

ALL-SOLID-STATE RADIOMETERS FOR ENVIRONMENTAL STUDIES TO 700 GHz

558-33
160572

P- 16

Ralph, Rüdiger and Peter Zimmermann

N 93-27784

RPG Radiometer-physics GmbH

5309 Meckenheim, Germany

ABSTRACT

We report results with an all-solid-state radiometer for measurements of the ClO molecule at 649 GHz. The project is part of a program to provide low-noise, low-weight, low-power radiometers for space operation, and special effort has been expended on the development of high-efficiency solid-state frequency multipliers and Schottky-barrier mixers with low local oscillator power requirements.

The best measured system noise temperature was 1750 K with the mixer and preamplifier cooled to 77 K. The mixer diode was easily pumped into saturation, indicating that the design has excellent prospects of operating at higher frequencies - our present design goal being 1 THz. We comment on the principal design features of such systems and will report on stratospheric measurements performed with this system.

INTRODUCTION

All solid-state radiometers in the frequency range 60-560 GHz have been reported [1], [2], [3], [4], and the measured parameters for the highest frequency receivers are tabulated in Figure 1. The ever-increasing

importance of atmospheric investigations in the higher sub-millimeter wavelength-range has led to a consolidated program to reach 1 THz with such instruments. To this end a radiometer (s. Fig.2) has been constructed for the detection of the ClO molecule at 649 GHz; this is the subject of this paper.

The three principal sections of the system are the optics, the all solid-state local oscillator and the low-noise mixer-preamplifier.

QUASI-OPTICS

At frequencies above 200 GHz the losses of waveguide components are too high for sensitive radiometers, and quasi-optical systems become increasingly compact. The prime component requirements for coupling the antenna and local oscillator into the mixer are high efficiency feed-horns, precisely machined offset-mirrors and low-loss wire grids for polarising couplers and filters. All mirrors are ellipsoids, whilst grids comprise 20 μm diameter tungsten wire with 50 μm spacings (between centres).

For IF bandwidths $\Delta f/f \leq 0.5$ the Martin-Puplett coupler is preferred.

Figure 2 shows the total front-end schematic, including a single-side-band filter and path-length modulator (from University of Bremen, to be reported at this conference). The quasi-optical beams, beam-waist locations and sizes are also shown. The feedhorns in this receiver are dual-mode horns as shown schematically in Figure 3 [5]. These horns have been measured at lower frequencies and have in all cases symmetrical near gaussian beam-patterns, to at least -15 dB. The losses of the optics plus feedhorns were measured by connecting the output of the frequency multiplier

directly to the mixer, and then feeding the l.o. to the mixer via the two horns and the quasi-optics: the loss was around 1 dB.

LOCAL OSCILLATOR

The local oscillator power requirement for a mixer depends strongly on the diode quality and on the mixer mount- and coupling-losses between source and mixer. Particularly in the submillimeter-range these parameters are not easy to determine. By extrapolating from lower submillimeter-wavelength, we estimate the l.o. power requirement to be in the range 100 μ W to 1 mW for a cooled mixer. The requirement was to build an all solid-state source for later space application.

In this paper the source comprises a Gunn oscillator, a waveguide cross-coupler plus harmonic mixer, a waveguide frequency doubler and tripler. All components are directly connected together, to reduce losses (Figure 4).

(a) Gunn-Oscillator

A Varian InP Gunn diode is mounted into a WR-8 waveguide (Figure 5). Bias is supplied to the diode via a coaxial low-pass filter held by teflon spacers.

The frequency is pretuned by a cap-resonator, fine adjustment over several GHz being provided by a dielectric tuning rod sliding under the cap. A waveguide back-short allows adjusting for maximum power. The power output is shown in Figure 6.

(b) Frequency Multiplier

There are several possibilities of attaining power at 650 GHz from a solid source followed by a multiplier. Gunn oscillators deliver output power up to 50 mW at frequencies up to 115 GHz. For this reason a sextupler seems a natural choice. Though we build one with ~ 100 μ W output power, it was very difficult to tune, as several idlers had to be optimised simultaneously. The better choice is a doubler-tripler or tripler-doubler combination, where each stage can be developed separately. Calculations using the program by Siegel et al. [6] showed that the doubler-tripler combination should result in higher efficiency; hence this combination was chosen.

To facilitate easy system construction and testing, especially for the case of cascaded multiplication stages, Radiometer-physics developed in 1987 "in-line" waveguide frequency multipliers (Figure 7). This means, that input- and output-waveguide are in-line, compared to the standard crossguide-type structure.

A schematic for both multipliers is shown in Figure 8. Input power is coupled from the input waveguide via a probe and coaxial filter to the diode which is part of the last section of this filter. The filter is of the low-pass Tchebycheff-type and has been modelled a lower frequencies. Probe and diode are located in the bend of input- and output-waveguides respectively.

The DOUBLER input waveguide dimensions are 2.0x1.0 mm, which are tapered to 2.0x0.5 mm at the probe. The dimensions of the output waveguide are 0.6x0.3 mm. Backshorts are provided for tuning. The diode is a 6P4 from University of Virginia, with the following DC-parameters $R_S = 12$ ohm , $C_j = 18$ fF, $V_{br} = 20$ V. It is contacted by a whisker of length 0.3 mm and diameter 25 μ m.

With 50 mW input signal an efficiency of 20% was achieved, compared with a theoretical efficiency of 37%. Power was measured with a Hughes Thermistor mount at the input. Output power was measured with an Anritsu power head 140-220 GHz with a tapered transition to match the input waveguide of the multiplier

The TRIPLER input and output waveguide dimensions are 0.6x0.3 mm and 0.4x0.2 mm respectively. It operates with a diode 2T2 again from University of Virginia. Its DC-characteristics are $C_j = 6.0$ fF, $R_s = 12$ ohm, $V_{br} = -11$ V. The whisker is 0.2 mm long, with 12 μ m diameter. An important feature of the tripler is the idler tuning circuit in form of a stub waveguide with a moving short. The output waveguide contains a short section of reduced-width waveguide to prevent idler propagation to the output. Low frequency modeling was important in attaining optimum waveguide dimensions. The output power achieved was 300 μ W, which means an efficiency of 3% compared to 17% theoretical.

The measurement of output power in the range 600-700 GHz is not trivial, and caution should be taken in specifying power at such high frequencies - in particular the power standards should be quoted. In our case relative measurements were performed using the same Anritsu thermistor power-head as for the doubler, with appropriate waveguide transitions. The absolute power output was then measured with the Queen Mary College acoustic calorimeter at 624 GHz, where an absolute calibration exists: this showed that the absolute power from the l.o. input is about three times greater than the Anritsu reading. Hence to a first approximation we can multiply all Anritsu readings by factor 3. Absolute measurements were also performed at 690 GHz with a similar frequency multiplier chain, whereby 30 μ W were measured with the Anritsu head and 90 μ W with the QMC instrument - once again a factor 3.

It is relevant to draw attention to the problems arising due to using different lower frequency thermistor heads, this is illustrated in Figure 10 for three measurements from a 345 GHz frequency multiplier. To show the possibilities of achieving l.o. power from solid-state sources in the submm-range we have included Figure 10.

MIXER

The mixer is shown schematically in Figure 11. The dual-mode horn is identical to that used for the l.o. output. The waveguide dimensions are 0.6x0.2 mm and the contacting back-short is gold-plated beryllium-copper. The diode chip (type 1T6 from the University of Virginia) is mounted on the coaxial choke structure, as shown in Figure 12. The chip is turned down to a cylindrical form and gold plated on the cylindrical surface, so that the chip is also the first choke-section. It is seen that the choke is supported by a Macor disc: the dimensions of this disc are important for obtaining a broad i.f. bandwidth. The calculated impedance of the choke is shown in Figure 14 from d.c. to 1100 GHz. Figure 15 shows the measured output impedance of the mixer across the i.f. band 9-11 GHz, without and with an i.f. matching transformer

The 1T6 diode has the following d.c.-characteristics: $R_S = 30 \text{ ohm}$
 $C_{j0} = 0.35 \text{ fF}$, $V_{br} = -6 \text{ V}$. The whisker is of gold-plated phosphorbronze, diameter 7 μm ; the total whisker length is 0.2 mm, and includes a loop to take up slight changes in waveguide and choke dimensions on cooling the mixer to 77 K. To test that there was adequate l.o. power the diode was biased at room-temperature to 0.86 V, whereby the diode drew a current of

10 μ A without l.o. and >600 μ A with l.o.: hence there was adequate l.o.-power for optimum mixer operation.

SYSTEM RESULTS

The system was tested using standard hot-cold foam absorbers from Emerson and Cuming at the input to the diplexer for DSB- and at the input to the SSB-filter for SSB-measurements. In the final configuration the cold image termination was replaced by an absorber for constructional reasons, without any appreciable sacrifice of performance.

The cryogenic i.f. preamplifier was developed at Chalmers Technical University and had a noise temperature of 35 K at 77 K ambient. All other i.f. components preceding the spectrometer were commercially available.

Double-sideband system tests with a 2 GHz i.f. bandwidth yield the following results:

| <u>T_{amb}</u> | <u>T_{sys}</u> | <u>T_m</u> | <u>L_o</u> |
|------------------------|------------------------|----------------------|----------------------|
| 300 K | 3800 K | 1900 K | 8.0 dB |
| 77 K | 1750 K | (1500 K) | (8.0 dB) |

T_{sys}-values are measured directly, whilst T_M and L_M are corrected for residual power mismatch of 0.15, and we assume the same conversion loss at 77 K ambient.

For single-sideband system tests the SSB-filter was adjusted by using a tunable Gunn-oscillator and multiplier chain, identical to the l.o. chain and a spectrum analyzer. The sideband rejection was at least 25 dB.

The result was:

$$T_{usb} = 3800 \text{ K at } 77 \text{ K}$$

More than adequate l.o. power was available to reach minimum T_{sys} . It was noted that the noise temperature was fairly insensitive to changes in diode current in the range 400-800 μA .

The system has been flown on an aircraft contracted by the University of Bremen. A first uncorrected result shows the ClO line in Fig. 15.

PROSPECTS

It appears reasonable to expect spaceborne all-solid-state radiometer system to be feasible at least to 1 THz, using only waveguide techniques. Calculations using the computer model of Siegel and Kerr yield l.o. output powers of 360 μW at 1 THz; taking into account losses this still implies that sufficient l.o. power will be available at 1 THz to pump a Schottky-barrier mixer diode; such a development program has commenced at Radiometer-physics. Since completing the 650 GHz system new Schottky-barrier mixer diodes have been reported [7], [8]. Hence, with improvements in multiplier- and mixer-technology it should be possible to operate such systems at even higher frequencies.

ACKNOWLEDGEMENT

The authors express their thanks to:

Dr. Nett from University of Bremen and Dr. Albinson from Chalmers Institute of Technology, Sweden for their helpful collaboration

Dr. Th. Crowe from University of Virginia for providing the excellent Schottky barrier diodes

Dr. E. Armandillo for support under ESA contract: "Limb Sounder critical Receiver Technologies for Remote Sensing of the Atmosphere".

Mr. F. Leipold of Radiometer-physics for his indefatigable support

REFERENCES

- 1 P. Hartogh, G.K. Hartmann, P. Zimmermann
"Simultaneous Water Vapour and Ozone Measurements with Millimeterwaves in the Stratosphere and Mesosphere". IGRASS 3.-6. Juni Helsinki, 1991
- 2 F. Lewen, University of Cologne, private Communication
- 3 J. Hernichel, R. Schieder, J. Stutzki, B. Vowinkel, G. Winnewisser, P. Zimmermann
"A 492 GHz Cooled Schottky Receiver for Radio-Astronomy"
Proceeding of Third Intern. Symposium on Space Terahertz Technology, March 24-26, 1992, Michigan
- 4 R. Zimmermann, Ra. Zimmermann, P. Zimmermann
"All Solid-State Radiometer at 557 GHz", 21st European Microwave Conference Stuttgart 1991
- 5 M.H. Picket, J.C. Hardy, J. Farhoomand
"Characterisation of a Dual Mode Horn for Submillimeter Wavelengths", IEEE, MTT-32, 1984 (936-937)
- 6 P.H. Siegel, A. R. Kerr, W. Hwang
"Topics in the optimisation of millimeter-wave mixers"
NASA Techn. Paper 2287, March 1984
- 7 N. Keen, A. Grüb, H. Hartnagel, J. Freyer, H. Grote, R. Zimmermann
"New Submillimeter-Wave Schottky-Barrier Mixer, Diodes: First Results"
Revised late Paper, Stuttgart
- 8 T.W. Crowe, W.C.B. Peatmann
"GaAs Schottky Diodes for Mixing Applications beyond 1 THz"
Proc. 2nd International Symposium on Space Terahertz Technology, Jet Propulsion Lab., Febr. 1991 (323-339)

| | 345 GHz [2] cooled 20 K | 490 GHz [3] cooled 20 K | 557 GHz [4] uncooled | 650 GHz cooled 77 K |
|---------------|----------------------------|----------------------------|-------------------------|------------------------|
| IF: | 1.5 ± 0.25 GHz | 1.5 ± 0.3 GHz | 1.4 ± 0.3 GHz | 10 ± 1 GHz |
| T_{IF} : | 10 - 20 K | 10 K | 60 K | 35 K |
| $T_{MIX,DSB}$ | n.m. - | n.m. - | 1200 K | 2000 K * |
| $L_{C,DSB}$ | n.m. - | n.m. - | 8 dB | 8.5 dB* |
| $T_{sys,DSB}$ | 350 K | 550 K | 1600 K | 1750 K (3800 K SSB) |

* only uncooled results; n.m. not measured

Fig. 1: RESULTS OF SYSTEMS WITH MIXERS AND MULTIPLIERS
FROM RADIOMETER-PHYSICS

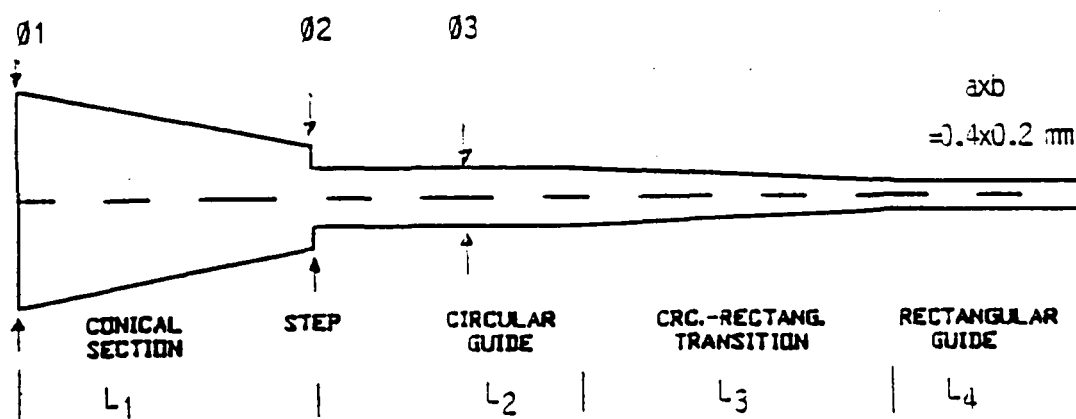

$$\varnothing_1 = 2.96 \text{ mm}$$

$$\varnothing_2 = 0.60 \text{ mm}$$

$$\varnothing_3 = 0.47 \text{ mm}$$

$$L_1 = 4.9 \text{ mm}$$

$$L_2 = 3.0 \text{ mm}$$

$$L_3 = 2.3 \text{ mm}$$

$$L_4 = 3.0 \text{ mm}$$

Fig. 3: DUAL - MODE HORN (SCHEMATIC)

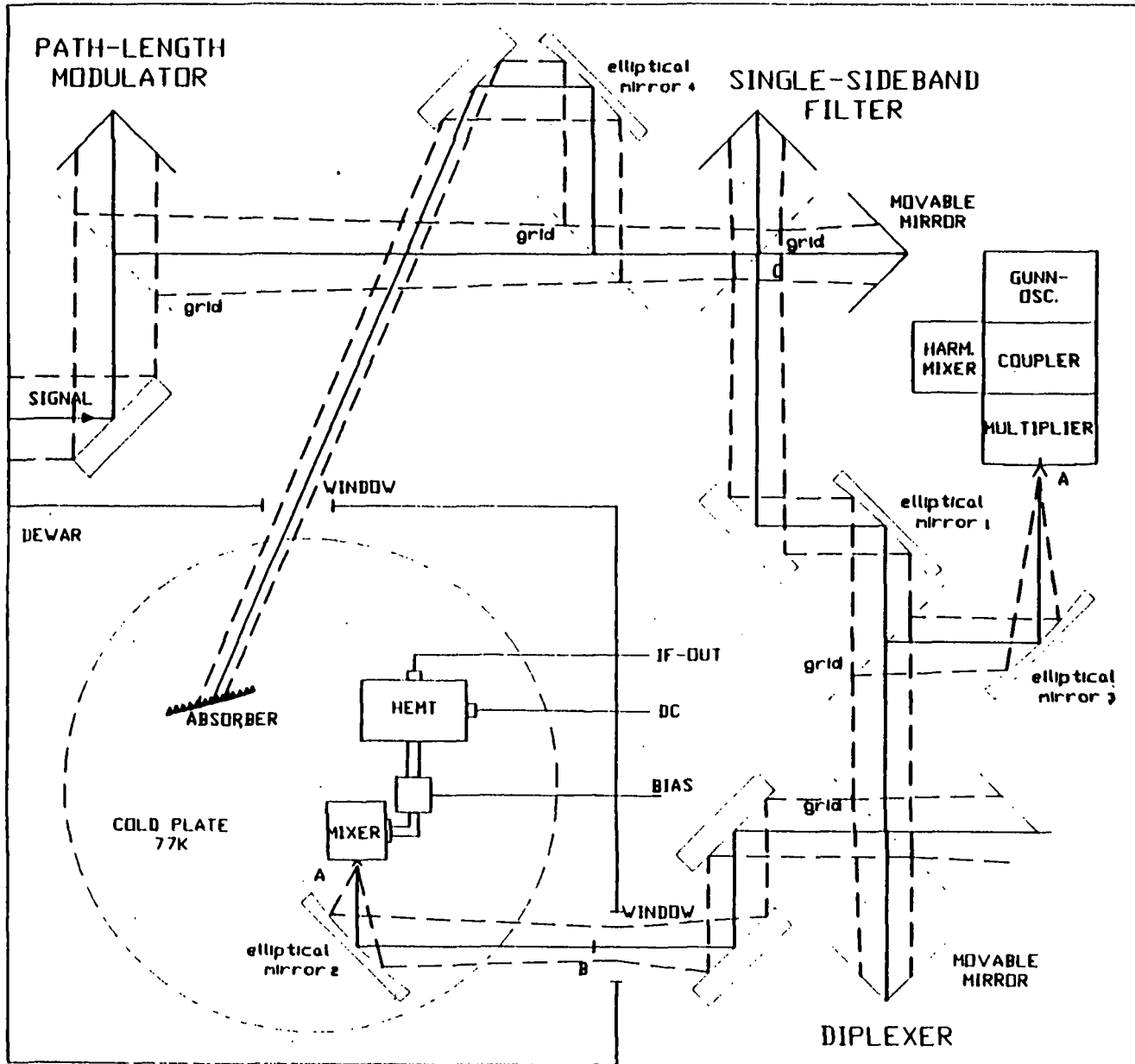

650 GHz COOLED SCHOTTKY RECEIVER BLOCK DIAGRAM

DIMENSIONS IN MM

BEAM WAISTS:

- A: 0.82 mm
- B: 6.0 mm
- C: 4.65 mm
- E: 4.0 mm

FIG. 2:
RECEIVER BLOCK
DIAGRAM

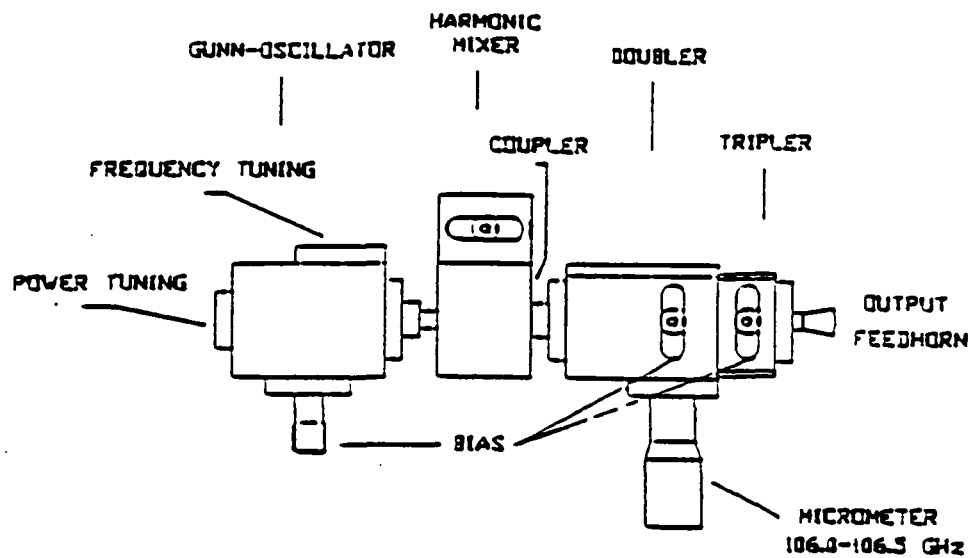

Fig. 4: LOCAL OSCILLATOR

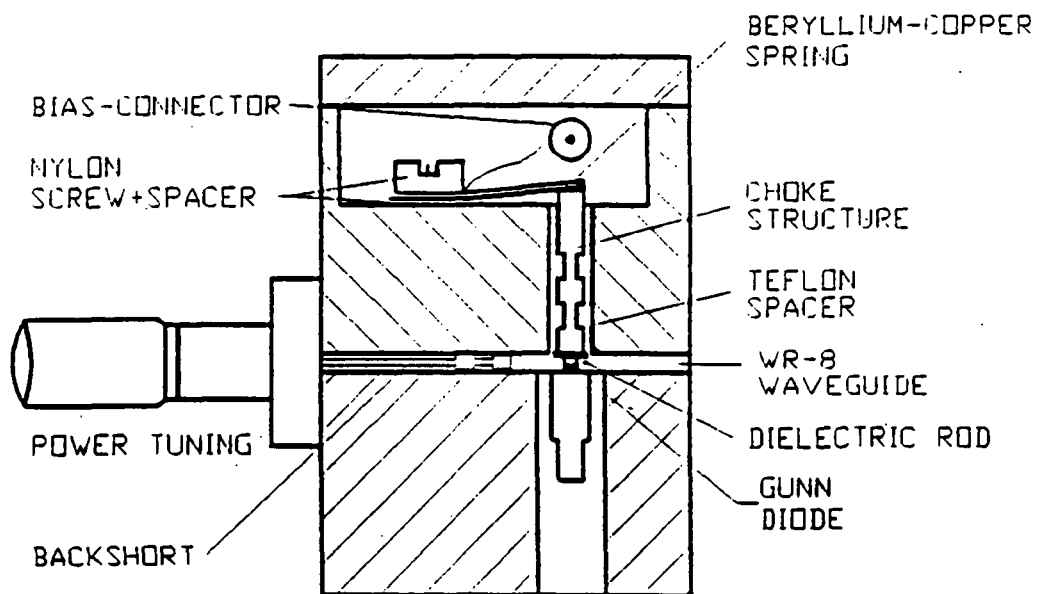

Fig. 5: GUNN-OSCILLATOR

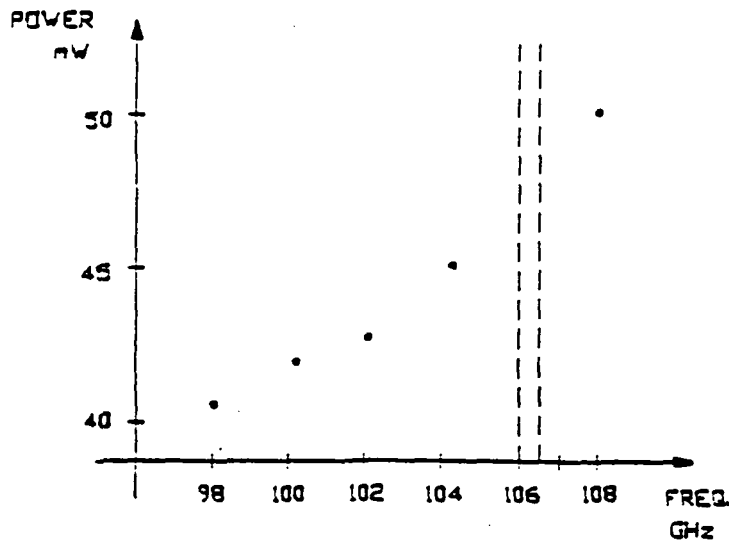

Fig. 6: GUNN OSCILLATOR OUTPUT POWER

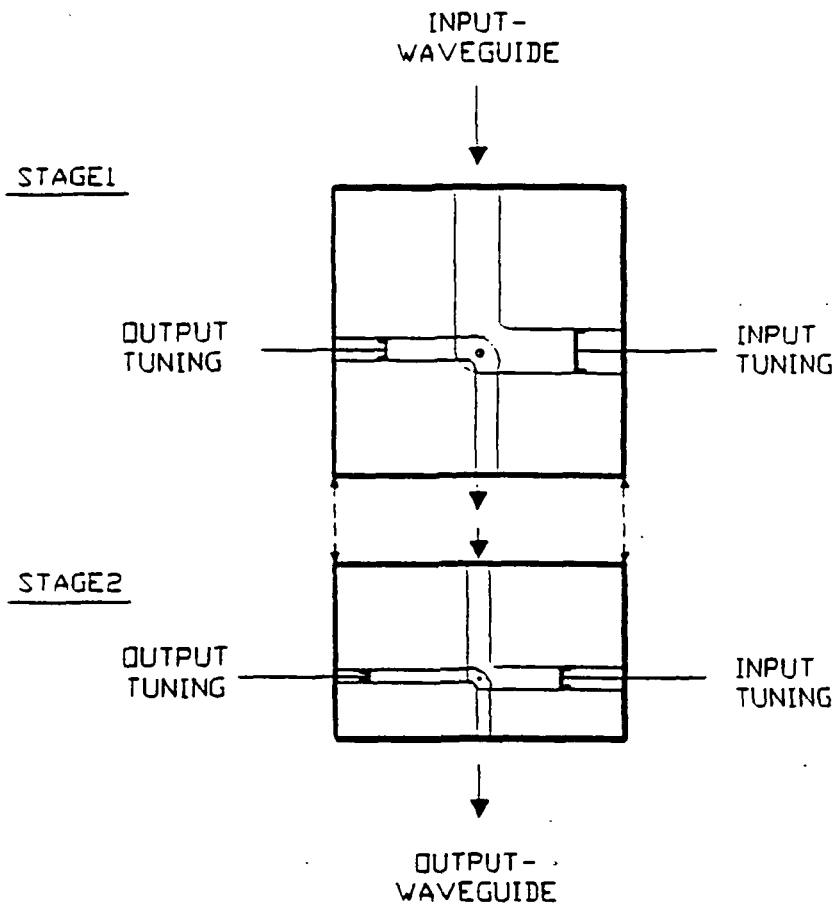

Fig. 7: ARRANGEMENT OF WAVEGUIDES FOR IN-LINE MULTIPLIERS

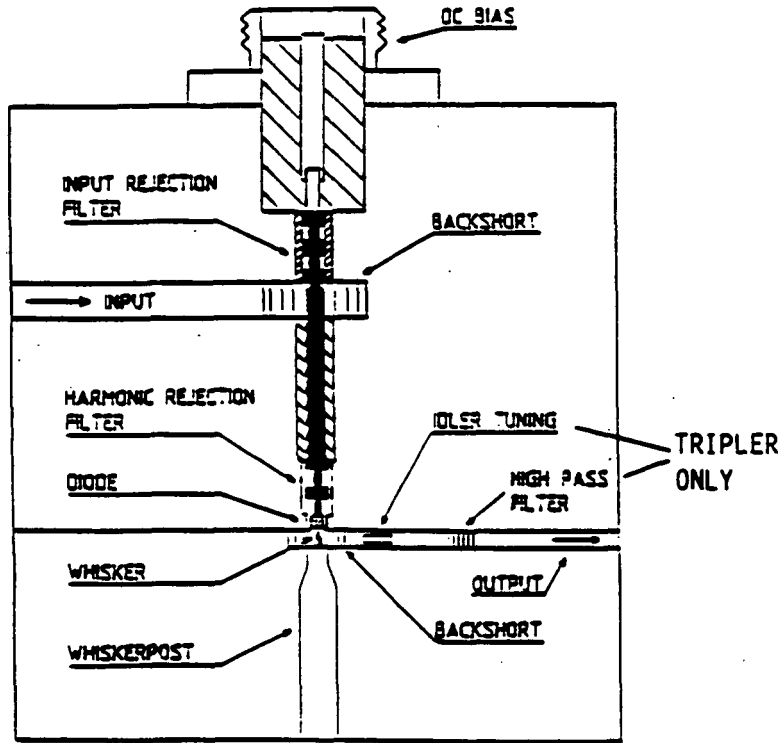

Fig. 8: MULTIPLIER (SCHEMATIC)

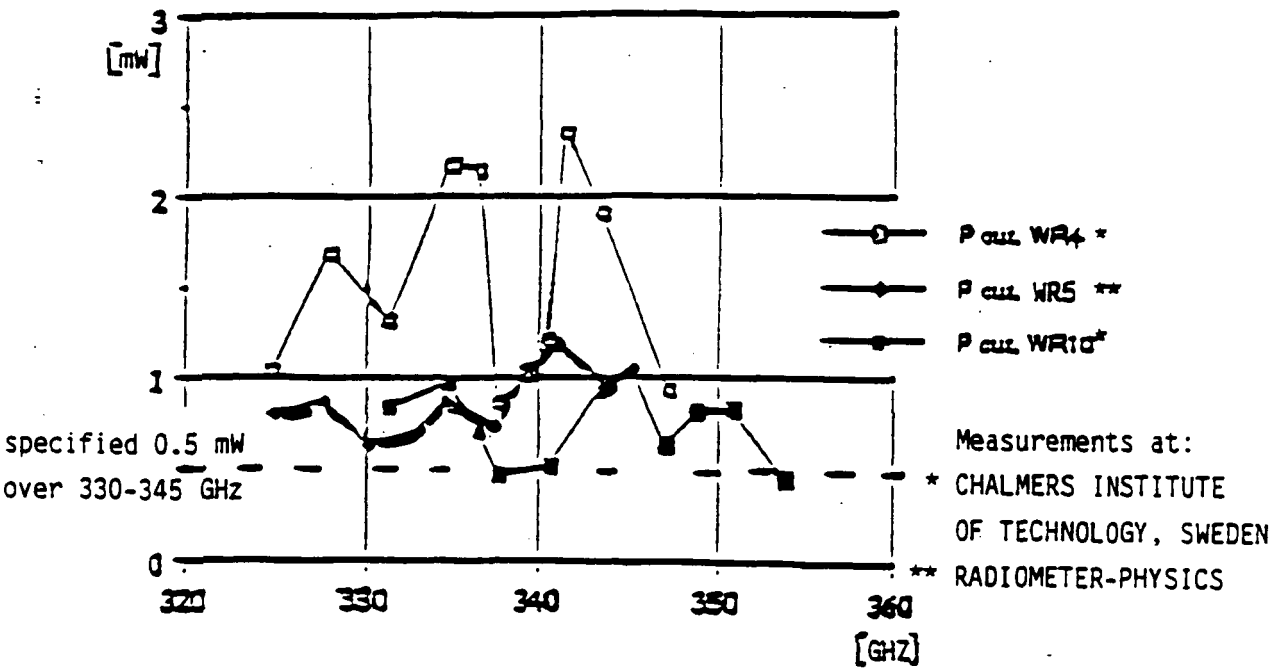

Fig. 9: MEASUREMENTS OF OUTPUT POWER WITH VARIOUS POWER METERS

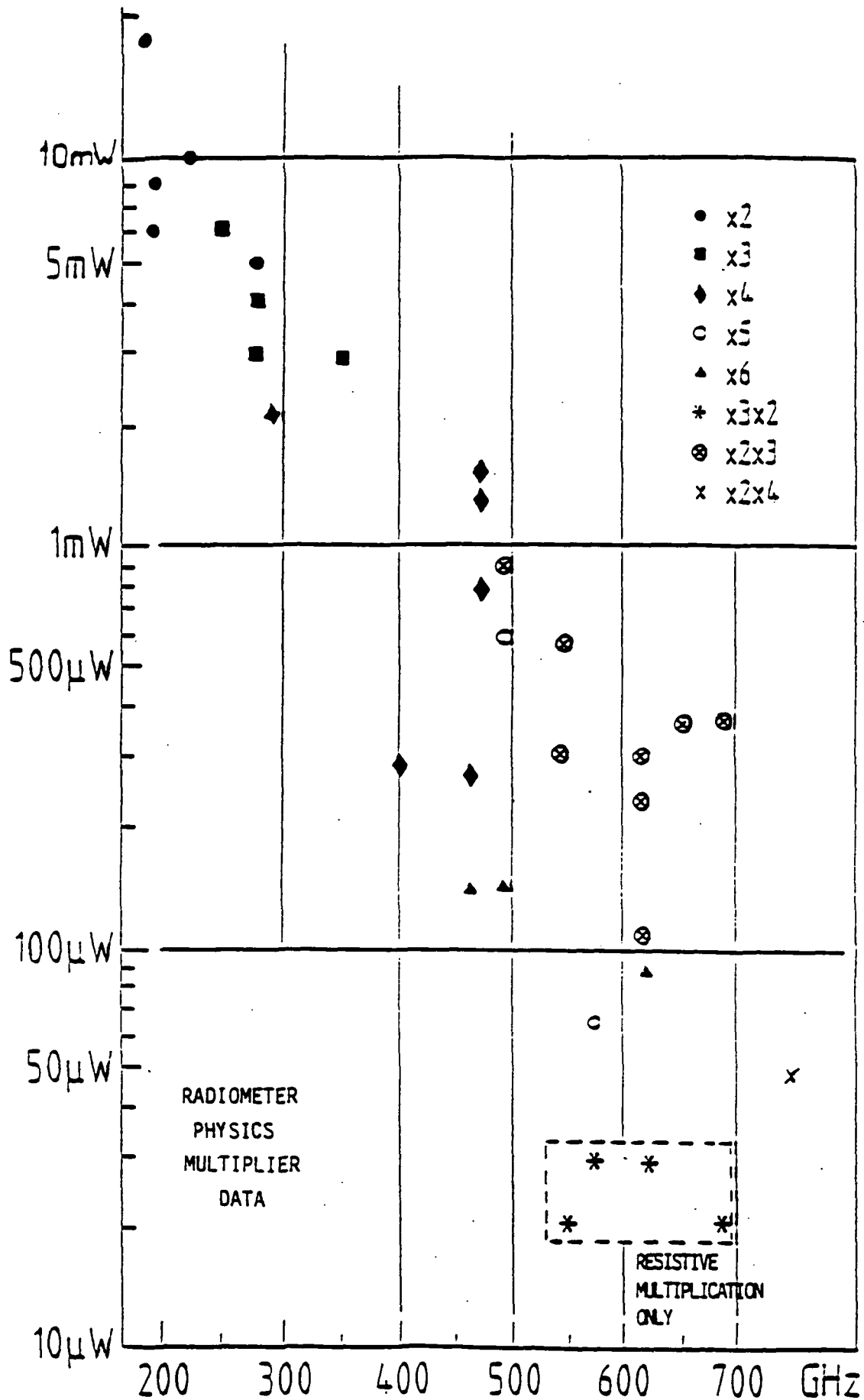

Fig. 10 POWER OUTPUTS FROM VARIOUS MULTIPLIERS

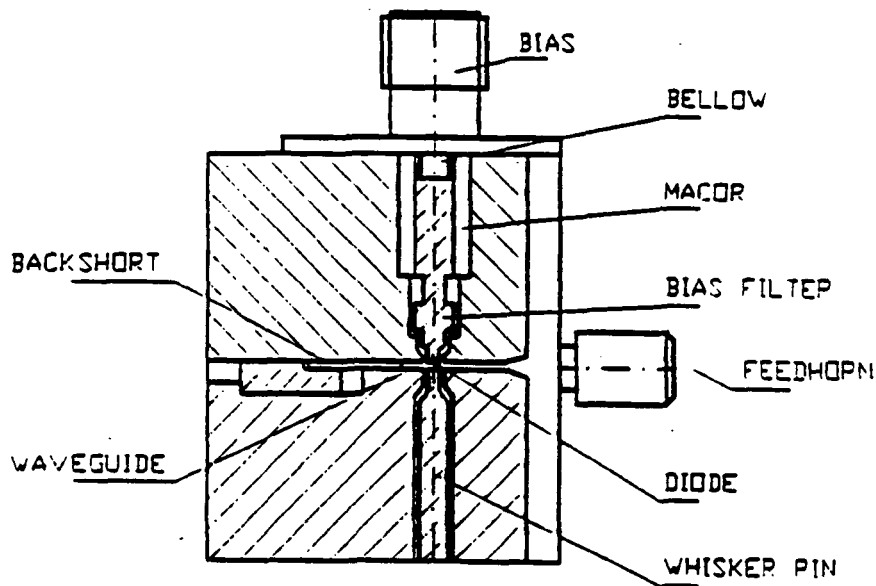

Fig. 11: MIXER (SCHEMATIC)

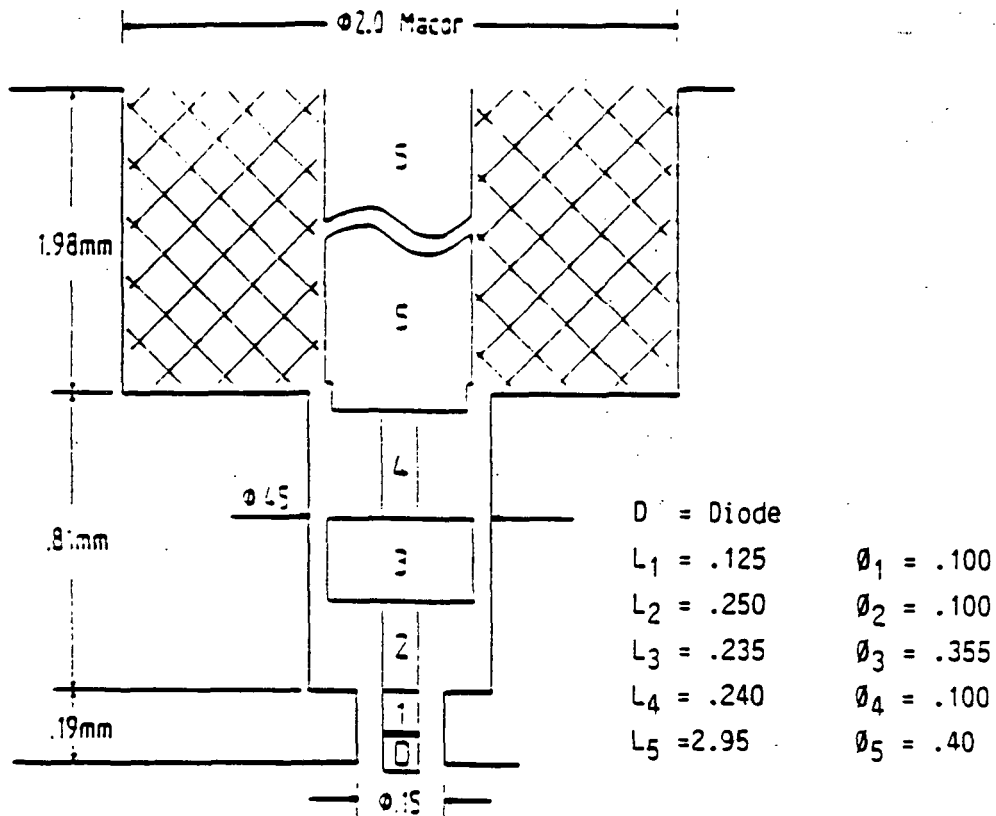

Fig. 12: MIXER CHOKE STRUCTURE

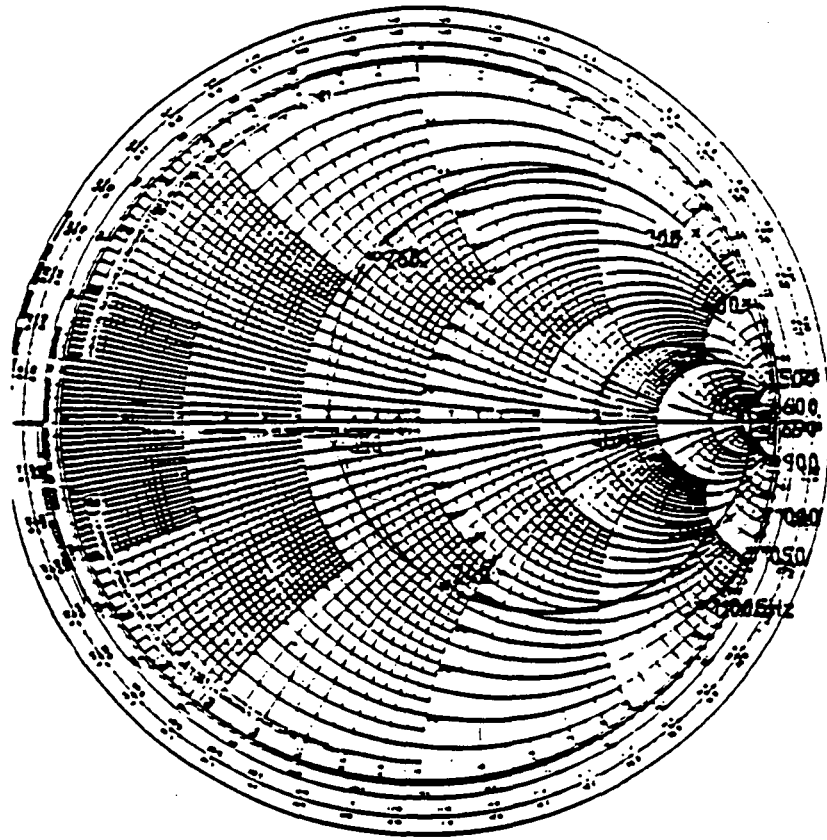

Fig. 13: MIXER CHOKE RF-IMPEDANCE

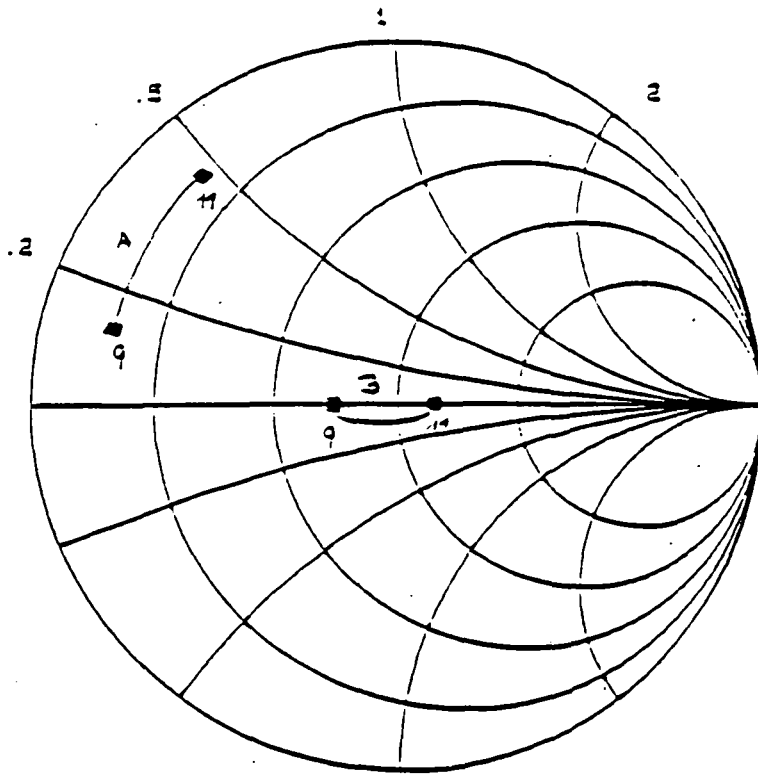

Fig. 14: MIXER IF-IMPEDANCE 9-11 GHZ
 A: before B: after matching

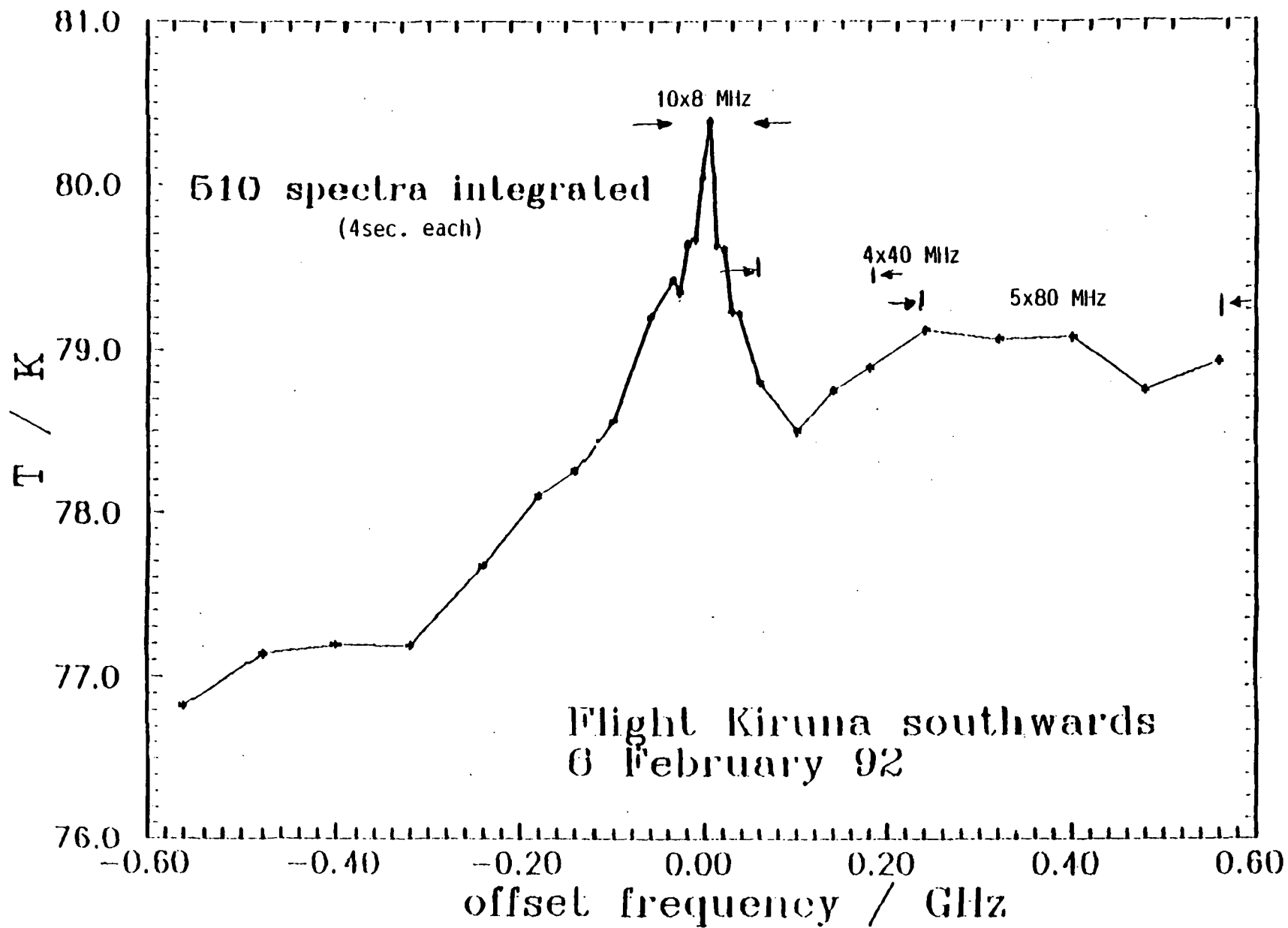

Fig. 15: C10-LINE SPECTRUM