

National Advisory Committee  
for Aeronautics  
MAILED  
JUN 29 1939  
to Library *L.M.A.H.*

TECHNICAL NOTES

NATIONAL ADVISORY COMMITTEE FOR AERONAUTICS

---

No. 715

---

WIND-TUNNEL INVESTIGATION OF AN N.A.C.A. 23012 AIRFOIL

WITH TWO ARRANGEMENTS OF A WIDE-CHORD SLOTTED FLAP

By Thomas A. Harris  
Langley Memorial Aeronautical Laboratory

**FILE COPY**

*To be returned to  
the files of the Langley  
Memorial Aeronautical  
Laboratory.*

Washington  
June 1939



## NATIONAL ADVISORY COMMITTEE FOR AERONAUTICS

## TECHNICAL NOTE NO. 715

WIND-TUNNEL INVESTIGATION OF AN N.A.C.A. 23012 AIRFOIL  
WITH TWO ARRANGEMENTS OF A WIDE-CHORD SLOTTED FLAP

By Thomas A. Harris

## SUMMARY

An investigation has been made in the N.A.C.A. 7-by 10-foot wind tunnel of a large-chord N.A.C.A. 23012 airfoil with several arrangements of a 40-percent-chord slotted flap to determine the section aerodynamic characteristics of the airfoil as affected by slot shape, flap location, and flap deflection. The flap positions for maximum lift, the polars for arrangements considered favorable for take-off and climb, and the complete section aerodynamic characteristics for selected optimum arrangements were determined. A discussion is given of the relative merits of the various arrangements. A comparison is made of slotted flaps of different chords on the N.A.C.A. 23012 airfoil.

The best 40-percent-chord slotted flap is only slightly superior to the 25-percent-chord slotted flap from considerations of maximum lift coefficient and low drag for take-off and initial climb.

## INTRODUCTION

The National Advisory Committee for Aeronautics has undertaken an extensive investigation of various wing-flap combinations to furnish information applicable to the aerodynamic and the structural design of high-lift devices for improving the safety and the performance of airplanes. A high-lift device capable of producing high lift with variable drag for landing and high lift with low drag for take-off and initial climb is believed to be desirable. Other desirable aerodynamic features are: no increase in drag with the flap neutral; small change in pitching moment with flap deflection; low forces required to operate the flap; and freedom from possible hazard due to icing.

It is planned in this investigation to test both simple and multiply slotted flaps of different chords on airfoils of different profile. Some promising arrangements of medium-chord slotted flaps have been developed for the N.A.C.A. 23012 and 23021 airfoils. The aerodynamic data for these arrangements are reported in references 1 and 2. Further improvement from considerations of high lift coefficients and low drag at high and intermediate lift coefficients was obtained with the combination of a medium-chord and a small-chord slotted flap (reference 3). Pressure-distribution data are also available for the medium-chord slotted flap on the N.A.C.A. 23012 airfoil. (See reference 4.)

In the present report, the section aerodynamic characteristics are given for the N.A.C.A. 23012 airfoil equipped with a 40-percent-chord slotted flap in combination with two slot shapes.

## MODELS

### Plain Airfoil

The basic wing, or the plain airfoil, used in these tests was built to the N.A.C.A. 23012 profile and has a chord of 3 feet and a span of 7 feet; the ordinates for the section are given in table I. The model was built of solid laminated pine and had been previously used in the investigation of the medium-chord slotted flap reported in reference 1. The trailing-edge section of this model is easily removable so that the model can be quickly altered for tests of different flap arrangements.

### Slotted-Flap Arrangements

The slotted flap and the slot shapes were built of solid laminated beech. The slot shapes were bolted to the main airfoil in place of the solid trailing edge. The flaps were mounted on special hinges that permitted considerable latitude in the location of the flaps with respect to the main airfoil.

Flaps.- Only one flap shape was tested; it is designated flap 1 (fig. 1 and table I). This flap has a small nose radius and was designed to give only a small

break in the lower surface of the airfoil when undeflected. It also lends itself to use with a door to seal the break in the lower surface of the airfoil with the flap undeflected.

Slot shapes.- The two slot shapes shown in figure 1 were used with the flap and are designated a and b. Slot shape a was designed to give a minimum break in the lower surface of the wing and, consequently, to have the smaller effect on the drag with the flap neutral. Slot shape b is similar to slot shape h of reference 1, which gave the lowest drag at intermediate and high lift coefficients for take-off.

The models were made to a tolerance of  $\pm 0.015$  inch.

#### TESTS

The models were so mounted in the closed test section of the N.A.C.A. 7- by 10-foot wind tunnel that they completely spanned the jet except for small clearances at each end. (See references 1 and 5.) The main airfoil was rigidly attached to the balance frame by torque tubes, which extended through the upper and the lower boundaries of the tunnel. The angle of attack of the model was set from outside the tunnel by rotating the torque tubes with a calibrated drive. Approximately two-dimensional flow is obtained with this type of installation and the section characteristics of the model under test can be determined.

A dynamic pressure of 16.37 pounds per square foot was maintained for all the tests, which corresponds to a velocity of 80 miles per hour under standard atmospheric conditions and to an average test Reynolds Number of about 2,190,000. Because of the turbulence in the wind tunnel, the effective Reynolds Number  $R_e$  (reference 6) was approximately 3,500,000. For all tests,  $R_e$  is based on the chord of the airfoil with the flap retracted and on a turbulence factor of 1.6 for the tunnel.

Plain airfoil.- Tests were first made of the plain airfoil over the complete angle-of-attack range from  $-6^\circ$  to the stall.

Slotted flaps.- With each slotted-flap arrangement, tests were made to determine the effect on minimum drag

of the breaks in the wing lower surface at the slot entrance with the flap retracted. Tests were also made to determine the effect of the flap hinges with the flaps in their retracted positions. The tests of slotted flaps 1-a and 1-b consisted in force measurements with various flap positions and deflections to determine the optimum path of the flap from considerations of low drag throughout the complete lift range and of the highest maximum lift for each flap deflection. Data were obtained for all tests throughout the angle-of-attack range from  $-6^\circ$  to the stall at  $10^\circ$  increments of flap deflection from  $0^\circ$  to  $50^\circ$ . No data were obtained above the stall because of the unsteady conditions of the model. Lift, drag, and pitching moments were measured for all positions of the flap over the complete angle-of-attack range tested.

## RESULTS AND DISCUSSION

### Coefficients

All test results are given in standard section non-dimensional coefficient form for the airfoil, corrected as explained in reference 1.

- $c_l$ , section lift coefficient ( $l/qc_w$ ).
- $c_{d_0}$ , section profile-drag coefficient ( $d_0/qc_w$ ).
- $c_{m(a.c.)_0}$ , section pitching-moment coefficient about aerodynamic center of plain wing ( $m(a.c.)_0/qc_w^2$ ).

where

- $l$  is section lift.
- $d_0$ , section profile drag.
- $m(a.c.)_0$ , section pitching moment.
- $q$ , dynamic pressure ( $1/2\rho V^2$ ).
- $c_w$ , chord of basic airfoil with flap fully retracted.

and

$\alpha_0$  is angle of attack for infinite aspect ratio.

$\delta_f$ , flap deflection.

#### Precision

The accuracy of the various measurements in the tests is believed to be within the following limits:

$\alpha_0$ - - - - -	$\pm 0.1^\circ$	$c_{d_0}(c_l = 1.0)$ - - - - -	$\pm 0.0006$
$c_{l_{max}}$ - - - - -	$\pm 0.03$	$c_{d_0}(c_l = 2.5)$ - - - - -	$\pm 0.002$
$c_{m(a.c.)_0}$ - - - - -	$\pm 0.003$	$\delta_f$ - - - - -	$\pm 0.2^\circ$
$c_{d_{0_{min}}}$ - - - - -	$\pm 0.0003$	Flap position - - - - -	$\pm 0.001c_w$

Corrections for flap-hinge fittings have been applied to the data for the flap-neutral conditions. No attempt was made to determine the effect of the hinges with the flaps deflected because their effect was believed small and because of the great number of tests required. The relative merits of the two flap arrangements are thought to be not appreciably affected because the same hinge fittings were used with the two airfoil-flap combinations.

#### Plain Airfoil

Aerodynamic characteristics.- The complete section aerodynamic characteristics of the plain N.A.C.A. 23012 airfoil are given in figure 2. These data have been discussed in reference 1 and therefore require no further discussion here.

Effect on profile drag of breaks in surface of airfoil at slot entrance.- The effects of the breaks in the lower surface of the airfoil with the flaps undeflected are shown in figure 3. The break in the wing upper surface only at the slot lip gave an approximately constant increment of section profile-drag coefficient of about 0.0001. The increments of section profile-drag coefficient due to the breaks in the upper and the lower sur-

faces of slotted flap 1-a vary from about 0.0006 at  $c_l = 0$  to about 0.0005 at  $c_l = 1.0$ . For slotted flap 1-b, the increment of section profile-drag coefficient due to the breaks in the upper and the lower surfaces varies from about 0.0013 at  $c_l = 0$  to about 0.0011 at  $c_l = 1.0$ . A door on the wing lower surface may be used to reduce greatly the increased profile-drag coefficient caused by the lower-surface break with either of the flaps.

### Slotted Flap Arrangements

Determination of optimum arrangements for maximum lift.- The data presented herein are the results of the maximum-lift investigation of the various flap-and-slot combinations in which the flap, at a given deflection, was located at points over a considerable area with respect to the main airfoil. The data are presented as contours of the position of the nose point of the flap relative to the slot lip for a given lift coefficient. The nose point of the flap is defined as the point of tangency of a line drawn perpendicular to the airfoil chord and tangent to the leading-edge arc of the flap when neutral, as shown in figure 1.

The complete maximum-lift data for slotted flaps 1-a and 1-b deflected  $10^\circ$ ,  $20^\circ$ ,  $30^\circ$ ,  $40^\circ$ , and  $50^\circ$  are given in figures 4 and 5. An inspection of these figures shows that the contours are not closed with all combinations for flap deflections less than  $20^\circ$ . Within this range, the position for maximum lift coefficient is not very critical and only a sufficient number of positions were taken to cover any practicable path along which the flap is likely to be operated. Furthermore, the optimum flap position for these deflections will probably be chosen from considerations of drag and ease of mechanical operation.

The position of the flaps for maximum lift coefficient becomes much more critical for the higher flap deflections and the contours are closed for flap deflections from  $30^\circ$  to  $50^\circ$ . Two values of the maximum lift coefficients were obtained with the  $30^\circ$  and the  $40^\circ$  flap deflections at certain positions and are shown by the broken and the solid lines on the contours. This result is probably due to critical air-flow conditions with gaps larger than the optimum. This unsteady condition has been encountered in the previous tests of the slotted flaps reported in

references 1, 2, and 3 and has been associated with large gaps between the slot lip and the flap. The unsteadiness is an undesirable condition and may be avoided if the gap for a given flap deflection is no larger than the optimum.

The maximum lift coefficients for slotted flaps 1-a and 1-b were obtained with the flap deflected  $50^\circ$  and with the flap nose point 1.5 percent below and 1.5 percent ahead of the slot lip. The maximum lift coefficient with slotted flap 1-a was 2.85 and with slotted flap 1-b was 2.90. With a  $40^\circ$  flap deflection, the maximum lift coefficient for both flaps was obtained with the flap nose point 1.5 percent below and 0.5 percent behind the slot lip.

From these contours, it should be possible for the designer to choose the best path for the flap to follow from considerations of maximum lift coefficient alone. If, from structural considerations, it is not possible to use the best aerodynamic path, the loss caused by using a compromise path can be immediately evaluated. Complete section aerodynamic characteristics of selected optimum arrangements for each flap deflection are given in a later section of this paper.

Determination of optimum arrangements for profile drag.— Optimum positions of the flap arrangements for the conditions of low drag for take-off and initial climb to clear an obstacle were determined. The sole criterion for a given lift coefficient was the drag coefficient. The most important single factor in unassisted take-off distance is the value of the lift coefficient for take-off because the higher the lift coefficient, the lower the take-off speed. It follows that, except for the detrimental effect of increased drag, the higher the lift coefficient, the shorter the distance required to clear a given obstacle. The limiting conditions are the power available to overcome the drag at the higher lift coefficients and the excess available lift required from considerations of safety. The data are given, therefore, as contours of the nose position of the flap for constant drag coefficients at certain selected lift coefficients,  $c_l = 1.5, 2.0,$  and  $2.5,$  and for flap deflections that cover the range for which the drag coefficient is decreased by deflecting the flap.

The complete drag data for slotted flaps 1-a and 1-b are given in figures 6 and 7. Where the minimum drag coef-



ficients were approximately the same for a given lift coefficient at low flap settings, both sets of data are given. From these data, optimum paths for the nose point of the flap may be chosen from consideration of drag coefficients at the various lift coefficients. If it is structurally impossible to follow the optimum path, the additional drag coefficient caused by the deviation will be available. Insufficient data were obtained to close all the contours, but most of the practicable arrangements are believed to be within the range covered.

Section aerodynamic characteristics of selected optimum arrangements.— The complete section aerodynamic characteristics of selected optimum arrangements of slotted flaps 1-a and 1-b are given in figures 8 and 9. The optimum arrangements were chosen from considerations of low drag coefficients at the specified lift coefficients, 1.5, 2.0, and 2.5, for flap deflections of 10° and 20° and from considerations of maximum lift coefficient alone for flap deflections from 30° to 50°. In addition to the optimum arrangements, data are also given for certain arrangements that appear structurally simpler. A table included in each figure shows the nose position of the flap for the various deflections; the points are plotted on the diagrams. The selected "optimum" path referred to herein after is shown by the broken line through the points and is a compromise between aerodynamic and structural considerations. The aerodynamic characteristics shown in these figures are typical; complete data for other positions of the flap at the several flap deflections are available upon request.

The erratic  $c_{d_0}$  for the 30° flap deflection of slotted flap 1-b is typical of the results for this flap deflection. The lower values of  $c_{d_0}$  over the lift range from  $c_l = 1.4$  ( $\alpha = -6^\circ$ ) to 1.9 ( $\alpha = -1^\circ$ ) have been disregarded in the selection of the optimum path because the arrangement would probably be impracticable. In addition, in a number of tests with larger gaps, two types of flow were encountered for this lift range; the other type gave a much higher  $c_{d_0}$ . The position for the flap at the 30° deflection was selected from consideration of maximum lift coefficient alone.

Comparison of selected optimum arrangements.— In order to compare the drags of the various flap arrangements, envelope polars are given in figure 10 for the

slotted-flap arrangements of figures 8 and 9. As previously mentioned, the low drag coefficients for the  $30^\circ$  flap deflections have been disregarded in drawing the envelope polars for slotted flap 1-b. Figure 10 shows slotted flap 1-b to be superior to slotted flap 1-a for take-off at any lift coefficient from 1.1 up to the maximum lift coefficient. For lift coefficients less than 1.1, the plain wing has lower drag coefficients than any of the arrangements with the flaps deflected. If a door were used to seal the break in the lower surface of the wing at the slot entrance, both of the slotted-flap arrangements would have approximately the same characteristics as the plain wing for lift coefficients less than 1.1.

A comparison of slotted flap 1-a and 1-b as lift-increasing devices is shown in figure 11, where the increments of maximum lift coefficient  $\Delta c_{l_{max}}$  are plotted against flap deflection when the flap is moved along the optimum path previously mentioned. Slotted flap 1-b is slightly superior to slotted flap 1-a for all flap deflections. It is particularly interesting to note that the increment of maximum lift coefficient increases very slightly for flap deflections greater than  $30^\circ$ .

The pitching-moment coefficients for slotted flaps 1-a and 1-b at comparable lift coefficients are about the same. (See figs. 8 and 9.)

Comparison of slotted flaps of different chord.— A comparison of slotted flap 1-b and slotted flap 2-h (25.66-percent-chord slotted flap) of reference 1 is shown by polars in figure 12. From a consideration of  $c_{d_0}$  for values of  $c_l$  less than 1.5, the two slotted flaps compared are about equal. For higher values of  $c_l$ , the 40-percent-chord slotted flap is slightly superior for take-off. In addition, the 40-percent-chord slotted flap for the extreme flap deflection gives higher values of  $c_{d_0}$ . It is probable, however, that the operating force would be so much higher for the 40-percent-chord slotted flap that it would be impracticable.

The effect of slotted-flap chord on  $\Delta c_{l_{max}}$  is shown in figure 13 where the data for the smaller-chord flaps were taken from references 1 and 3. It is of interest to note that the increase of  $c_{l_{max}}$  was only 0.1 for an in-

crease of flap chord from 25 to 40 percent whereas, with the increase of flap chord from 10 to 25 percent, the gain in  $c_{l_{max}}$  was 0.5.

A comparison of the pitching-moment coefficients for the 40-percent-chord slotted flap, the 25.66-percent-chord slotted flap of reference 1, and the 10-percent-chord slotted flap of reference 3 shows that, for equal lift coefficients, the pitching-moment coefficients are about the same.

#### CONCLUDING REMARKS

Slotted flap 1-b is superior to 1-a except for low drag with flap neutral. Slotted flap 1-b is also superior to slotted flap 2-h of reference 1 from considerations of maximum lift and of low drag for lift coefficients from 1.5 to 2.5. It should be noted that the gain in aerodynamic characteristics with the large-chord slotted flap as compared with the 25.66-percent-chord slotted flap is slight.

Langley Memorial Aeronautical Laboratory,  
National Advisory Committee for Aeronautics,  
Langley Field, Va., May 23, 1939.

## REFERENCES

1. Wenzinger, Carl J., and Harris, Thomas A.: Wind-Tunnel Investigation of an N.A.C.A. 23012 Airfoil with Various Arrangements of Slotted Flaps. T.R. No. 664, N.A.C.A., 1939.
2. Wenzinger, Carl J., and Harris, Thomas A.: Wind-Tunnel Investigation of an N.A.C.A. 23021 Airfoil with Various Arrangements of Slotted Flaps. T.R. No. 677, N.A.C.A., 1939.
3. Wenzinger, Carl J., and Gauvain, William E.: Wind-Tunnel Investigation of an N.A.C.A. 23012 Airfoil with a Slotted Flap and Three Types of Auxiliary Flap. T.R. No. 679, N.A.C.A., 1939.
4. Wenzinger, Carl J., and Delano, James B.: Pressure Distribution over an N.A.C.A. 23012 Airfoil with a Slotted and a Plain Flap. T.R. No. 633, N.A.C.A., 1938.
5. Harris, Thomas A.: The 7 by 10 Foot Wind Tunnel of the National Advisory Committee for Aeronautics. T.R. No. 412, N.A.C.A., 1931.
6. Jacobs, Eastman N., and Sherman, Albert: Airfoil Section Characteristics as Affected by Variations of the Reynolds Number. T.R. No. 586, N.A.C.A., 1937.

TABLE I

## ORDINATES FOR AIRFOIL AND FLAP SHAPES

(Stations and ordinates in percent of wing chord)

N.A.C.A. 23012 Airfoil		
Station	Upper surface	Lower surface
C	-	0
1.25	2.67	-1.23
2.5	3.61	-1.71
5	4.91	-2.26
7.5	5.80	-2.61
10	6.43	-2.92
15	7.19	-3.50
20	7.50	-3.97
25	7.60	-4.28
30	7.55	-4.46
40	7.14	-4.48
50	6.41	-4.17
60	5.47	-3.67
70	4.36	-3.00
80	3.08	-2.16
90	1.68	-1.23
95	.92	-.70
100	.13	-.13

L.E. radius: 1.58. Slope of radius through end of chord: 0.305.

Flap 1		
Station	Upper surface	Lower surface
0	-1.76	-1.76
.63	-.31	-
1.25	.37	-3.17
2.5	1.36	-3.40
5	2.69	-3.36
7.5	3.48	-3.19
10	3.97	-3.00
11	4.05	-
12	4.07	-
20	3.08	-2.16
30	1.68	-1.23
35	.92	-.70
40	.13	-.13

Center of L.E. arc

1.35	-1.76	
------	-------	--

L.E. radius: 1.35

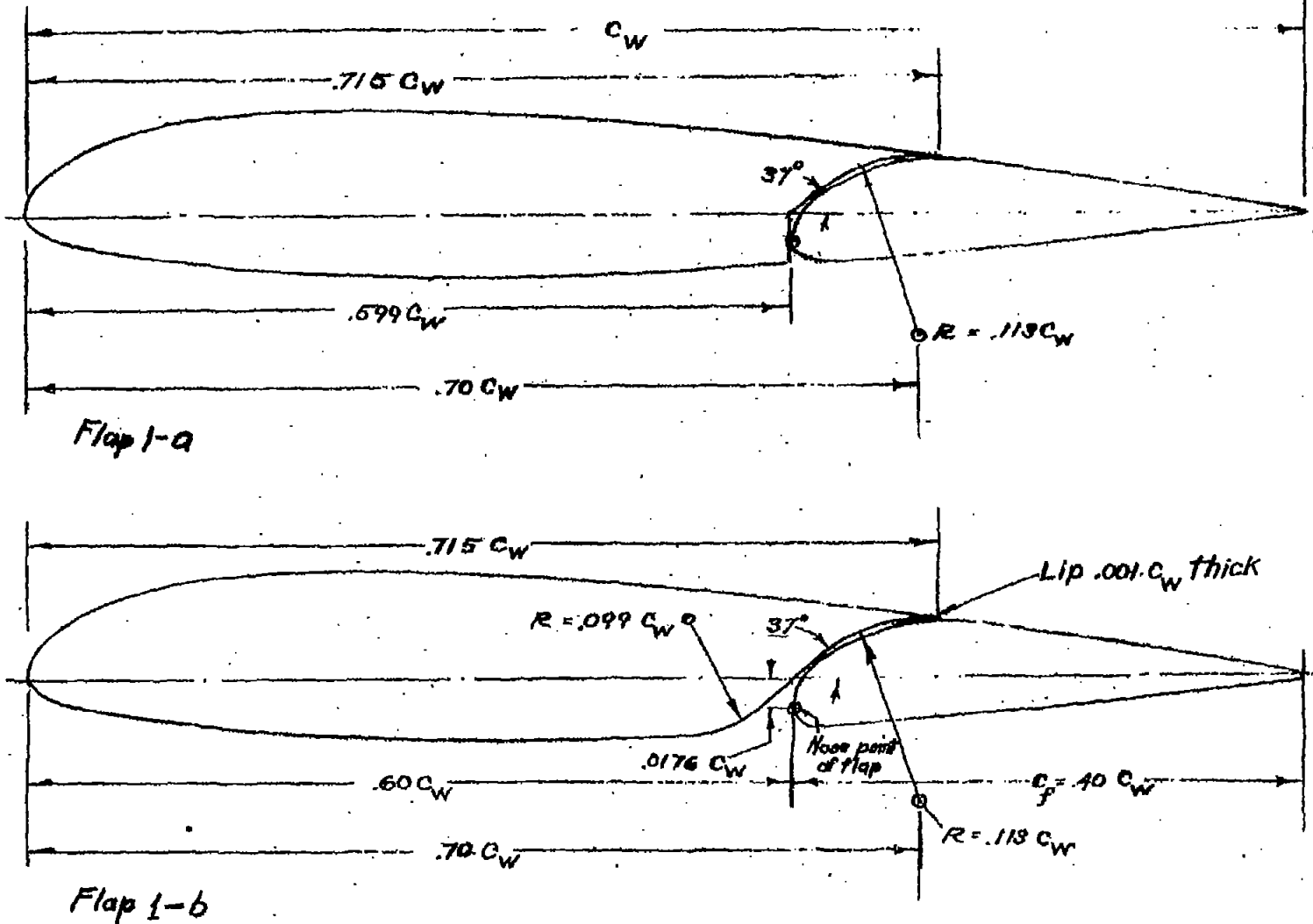

FIGURE 1.—Sections of N.A.C.A. 23012 airfoil with arrangements of 0.40 chord slotted flap.

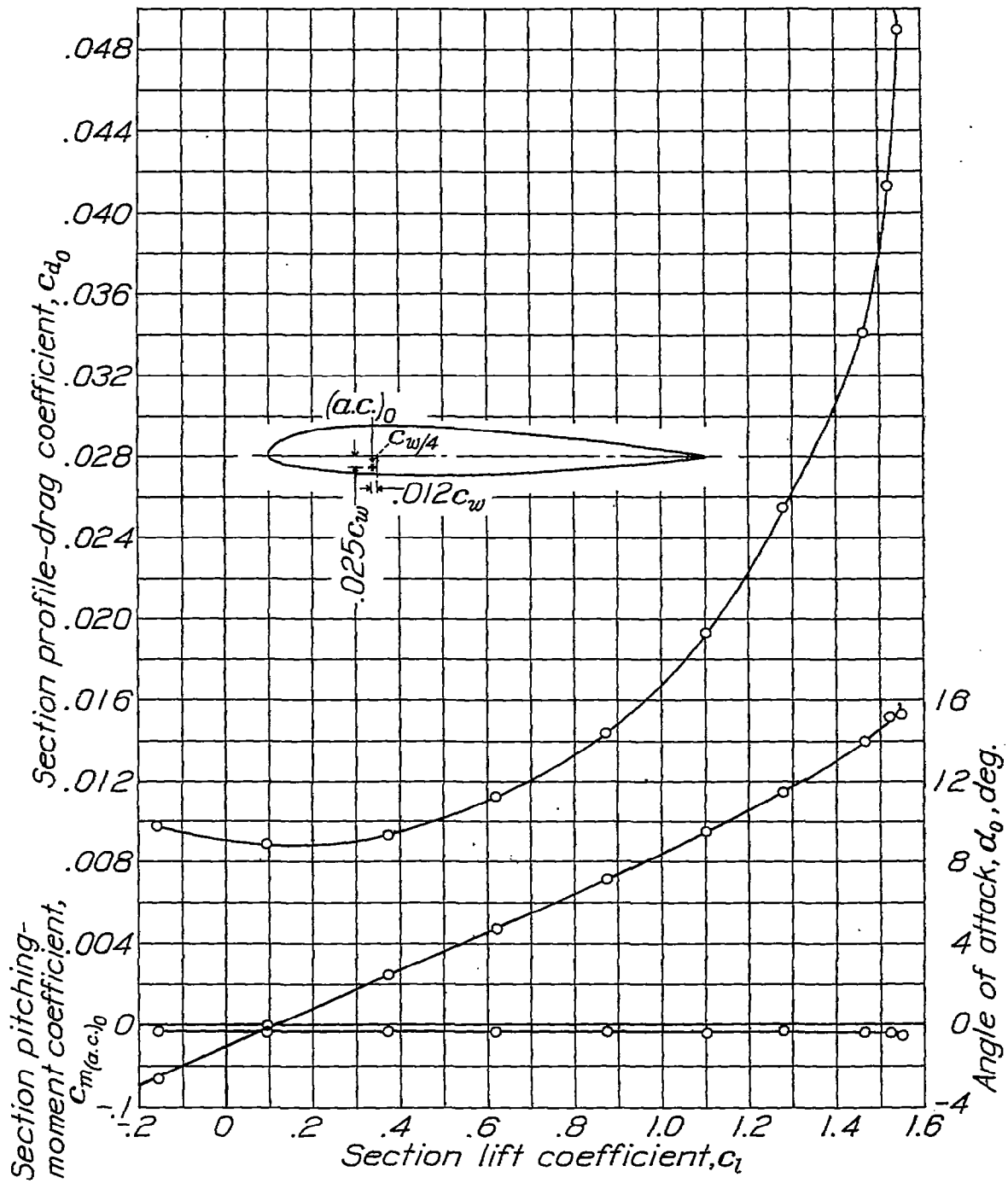

Figure 2.- Section aerodynamic characteristics of N.A.C.A. 23012 plain airfoil.

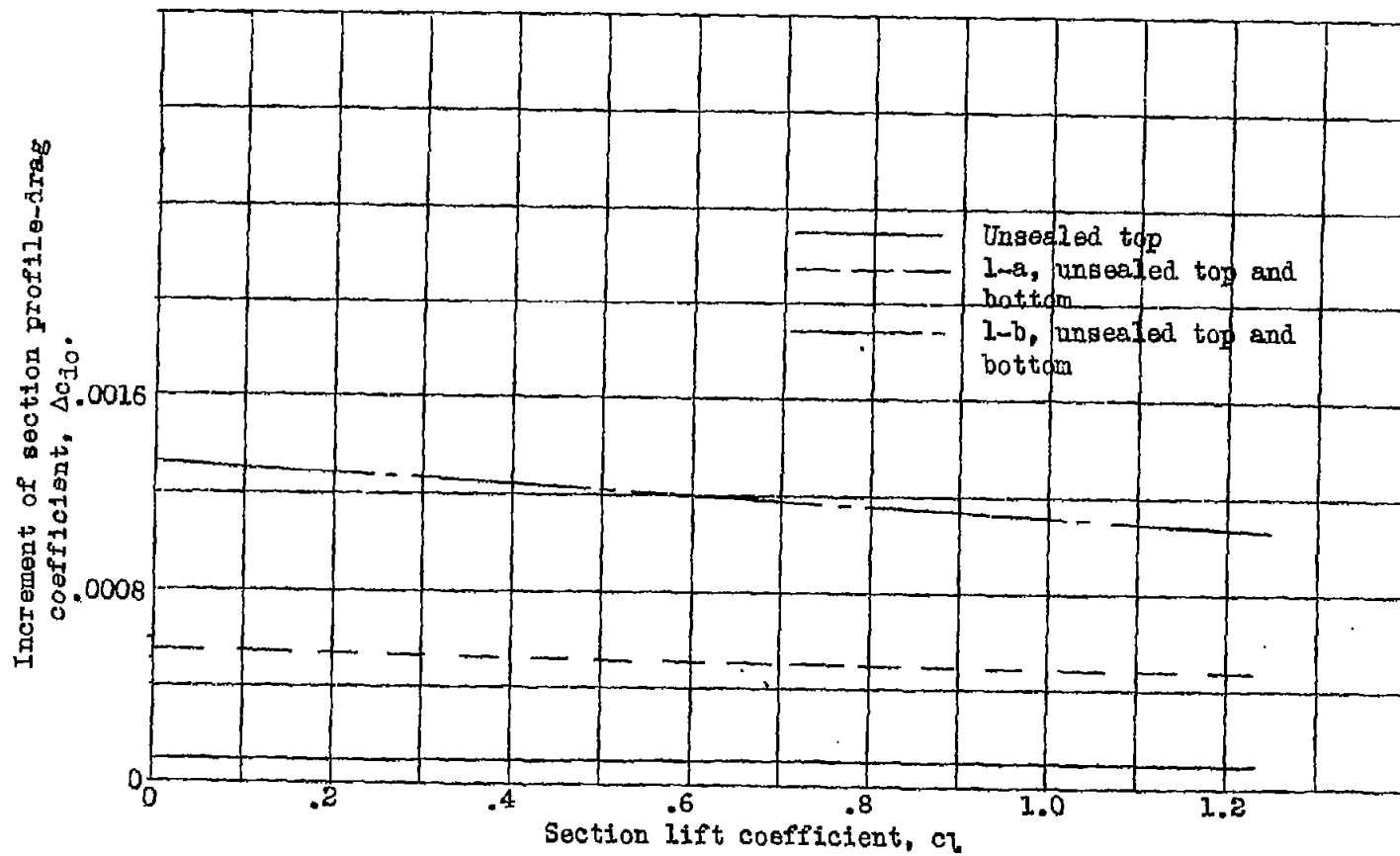
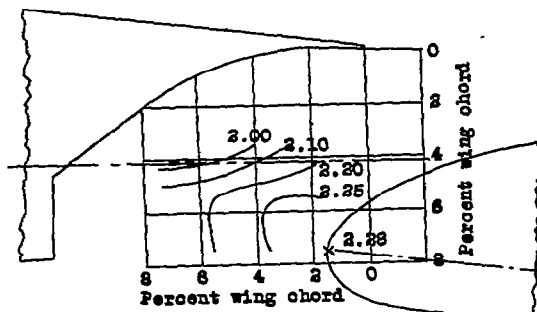
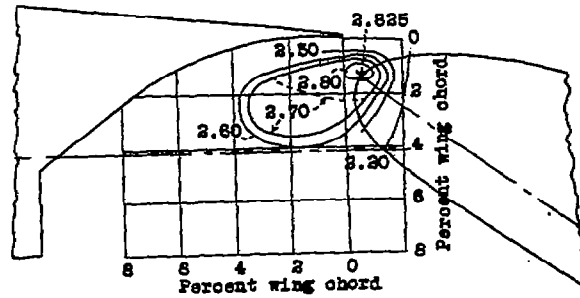

Figure 3.- Effect of slot openings in surfaces of airfoil on section profile-drag coefficient. The 0.40  $c_w$  slotted flap;  $\delta_f = 0^\circ$ .





(a)  $\delta_f = 10^\circ$



(d)  $\delta_f = 40^\circ$

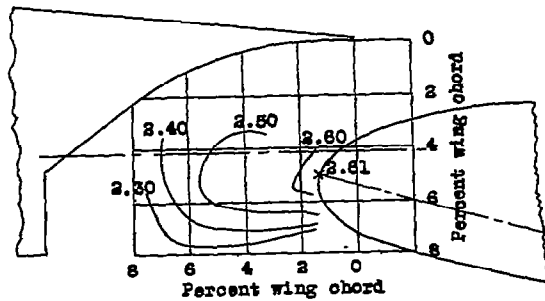

(b)  $\delta_f = 20^\circ$

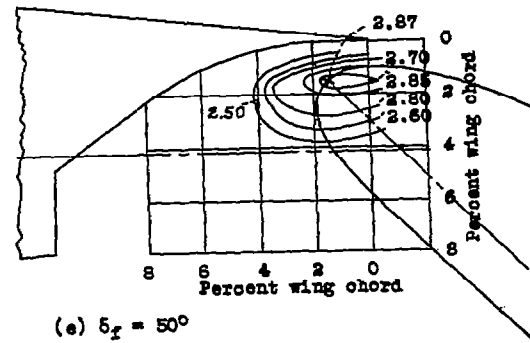

(e)  $\delta_f = 50^\circ$

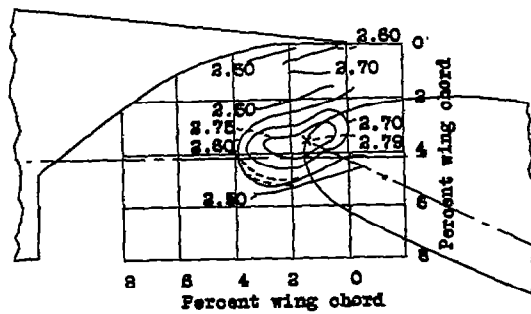

(c)  $\delta_f = 30^\circ$

Figure 4.- Contours of flap location for  $c_{l_{max}}$ . The 0.40  $c_w$  slotted flap l-a.

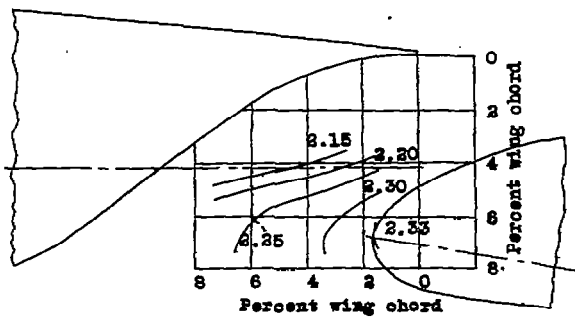

(a)  $\delta_f = 10^\circ$

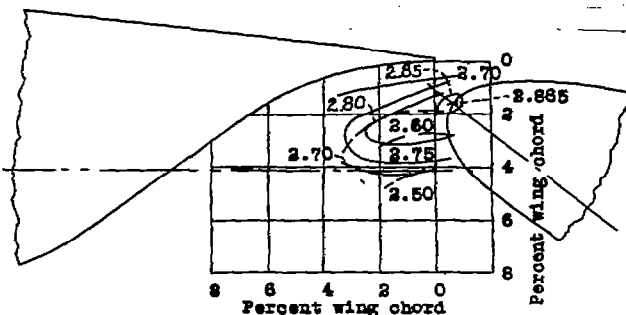

(d)  $\delta_f = 40^\circ$

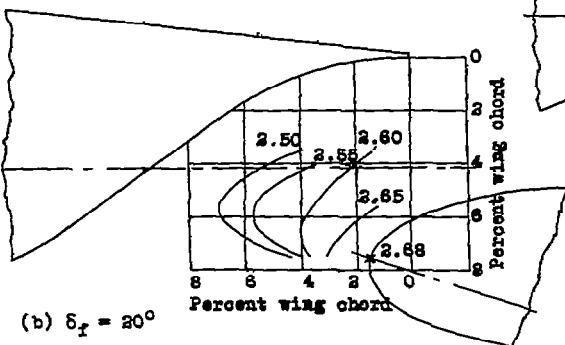

(b)  $\delta_f = 20^\circ$

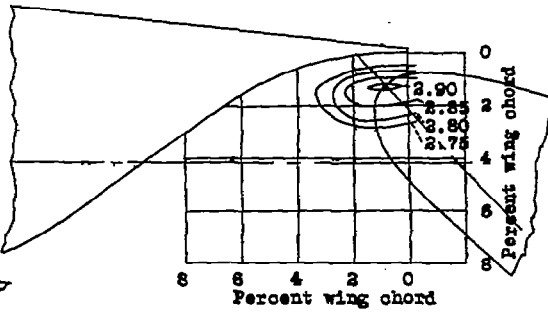

(e)  $\delta_f = 50^\circ$

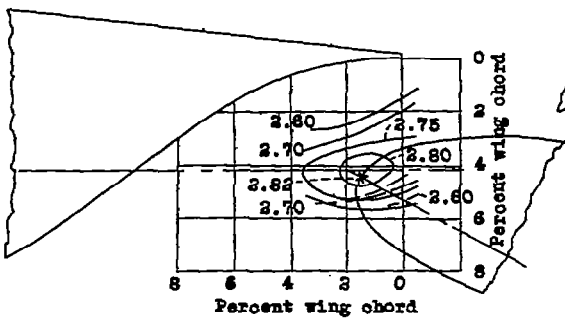

(c)  $\delta_f = 30^\circ$

Figure 5.- Contours of flap location for  $c_{L_{max}}$ . The 0.40  $c_w$  slotted flap 1-b.

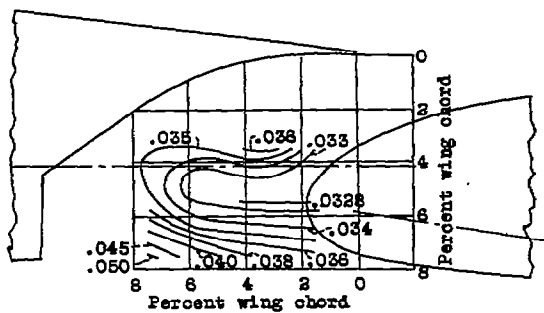

(a)  $c_l=1.5$ ;  $\delta_f=10^\circ$

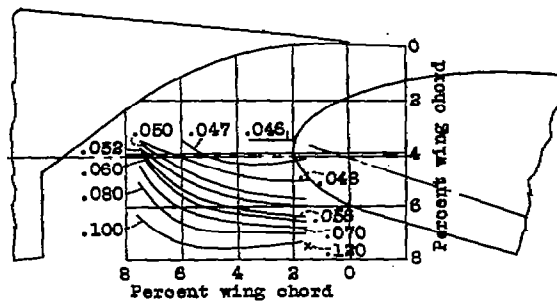

(c)  $c_l=2.0$ ;  $\delta_f=20^\circ$

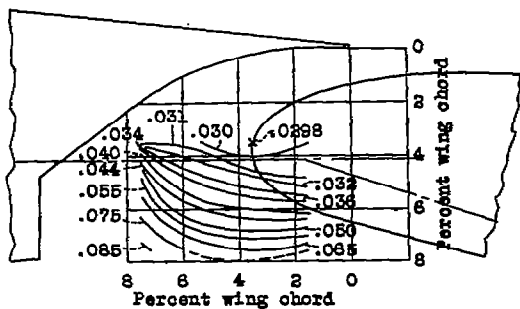

(b)  $c_l=1.5$ ;  $\delta_f=20^\circ$

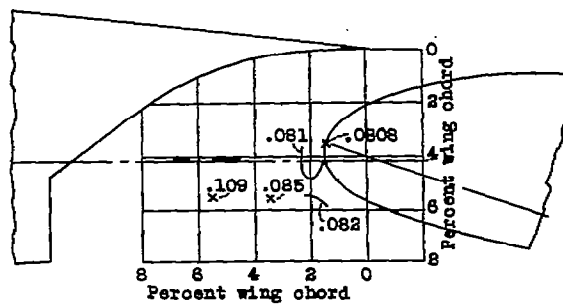

(d)  $c_l=2.5$ ;  $\delta_f=20^\circ$

Figure 6.- Contours of flap location for  $c_{d0}$ . The  $0.40c_w$  slotted flap 1-a.

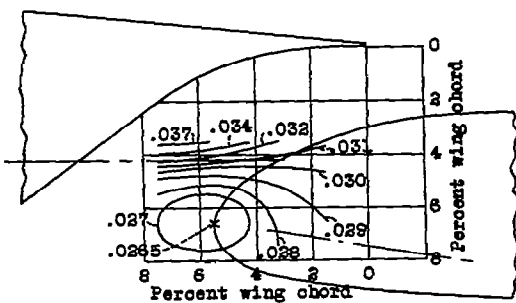

(a)  $c_l=1.5$ ;  $\delta_f=10^\circ$

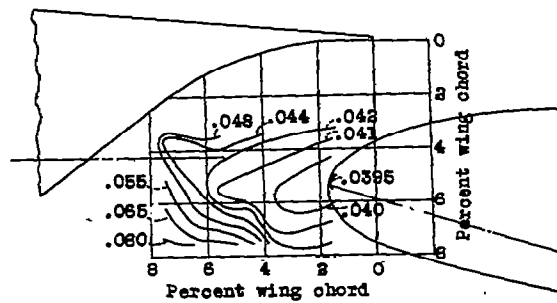

(c)  $c_l=2.0$ ;  $\delta_f=20^\circ$

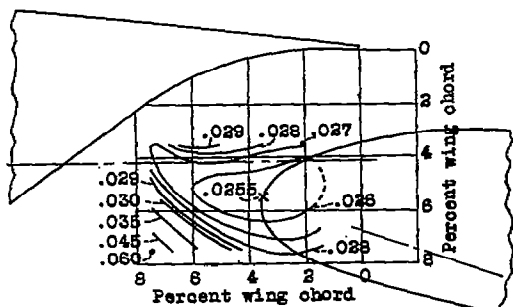

(b)  $c_l=1.5$ ;  $\delta_f=20^\circ$

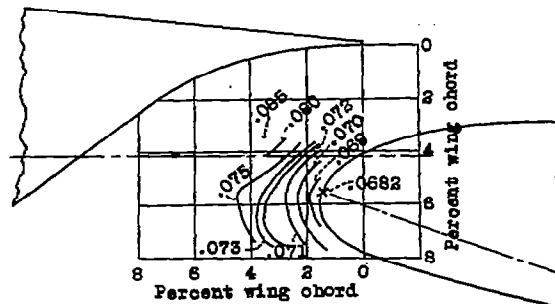

(d)  $c_l=2.5$ ;  $\delta_f=20^\circ$

Figure 7.- Contours of flap location for  $c_{d0}$ . The  $0.40c_w$  slotted flap 1-b.

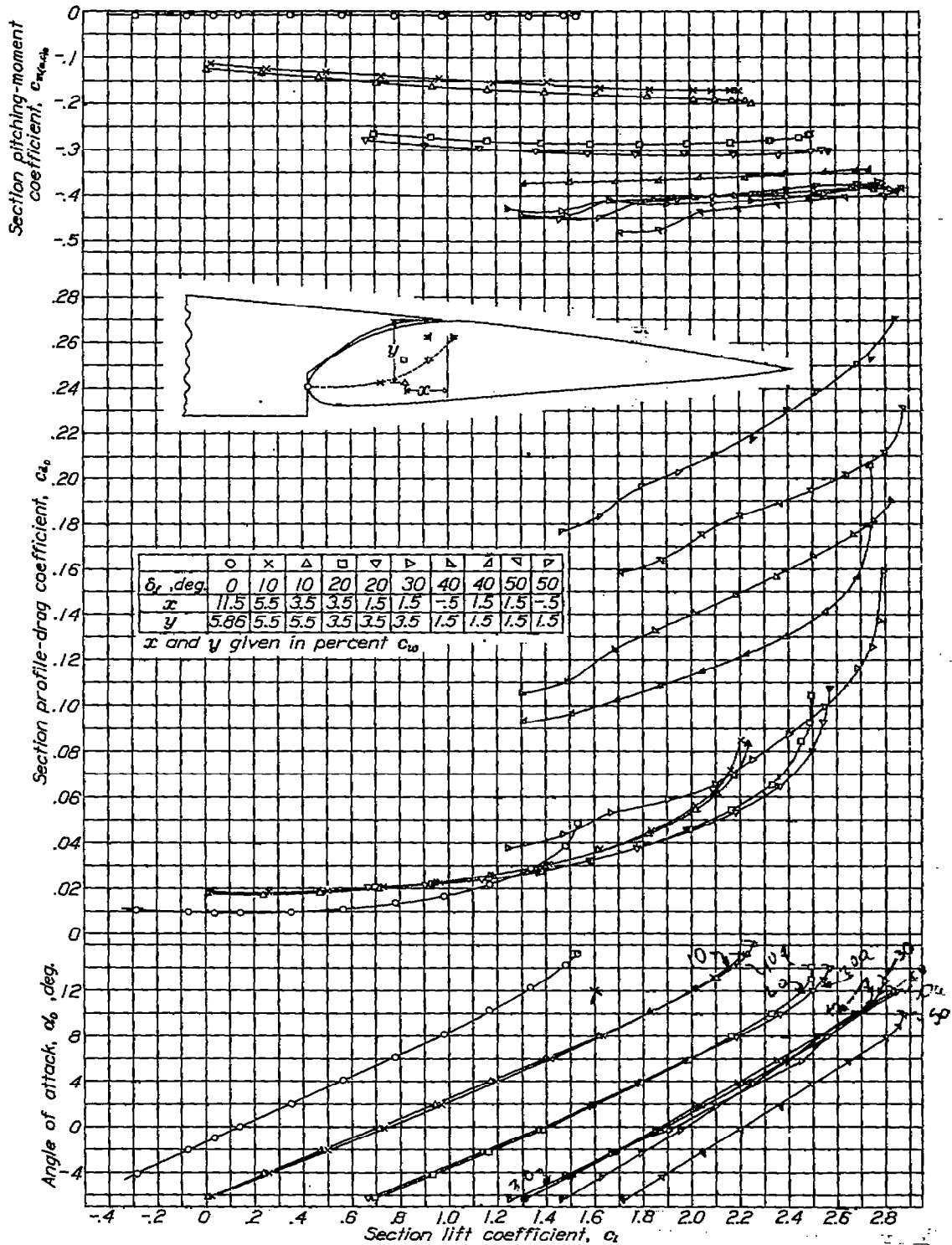

Figure 8.- Section aerodynamic characteristics of N.A.C.A. 23012 airfoil with  $0.40c_{l0}$  slotted flap 1-a.

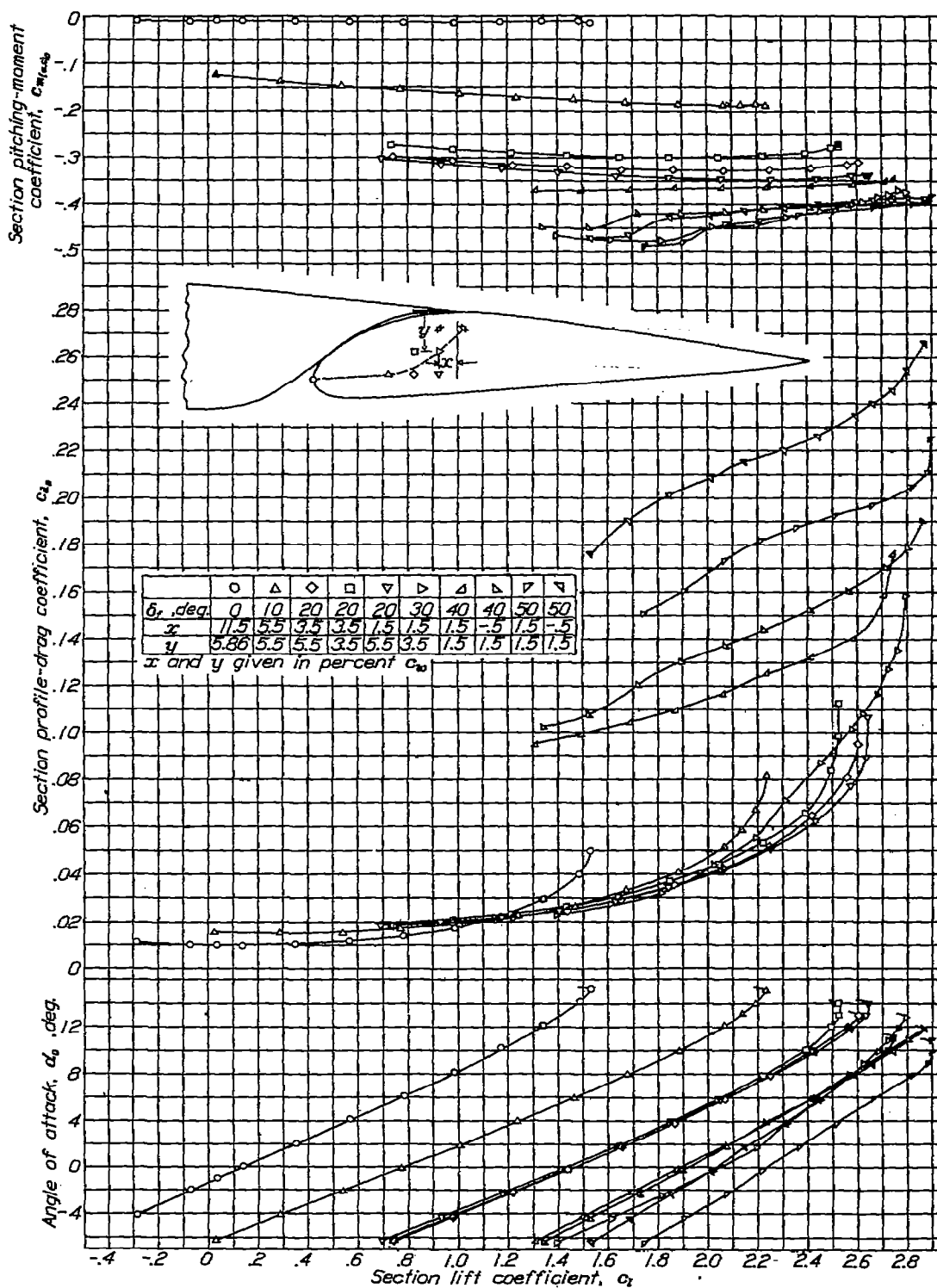
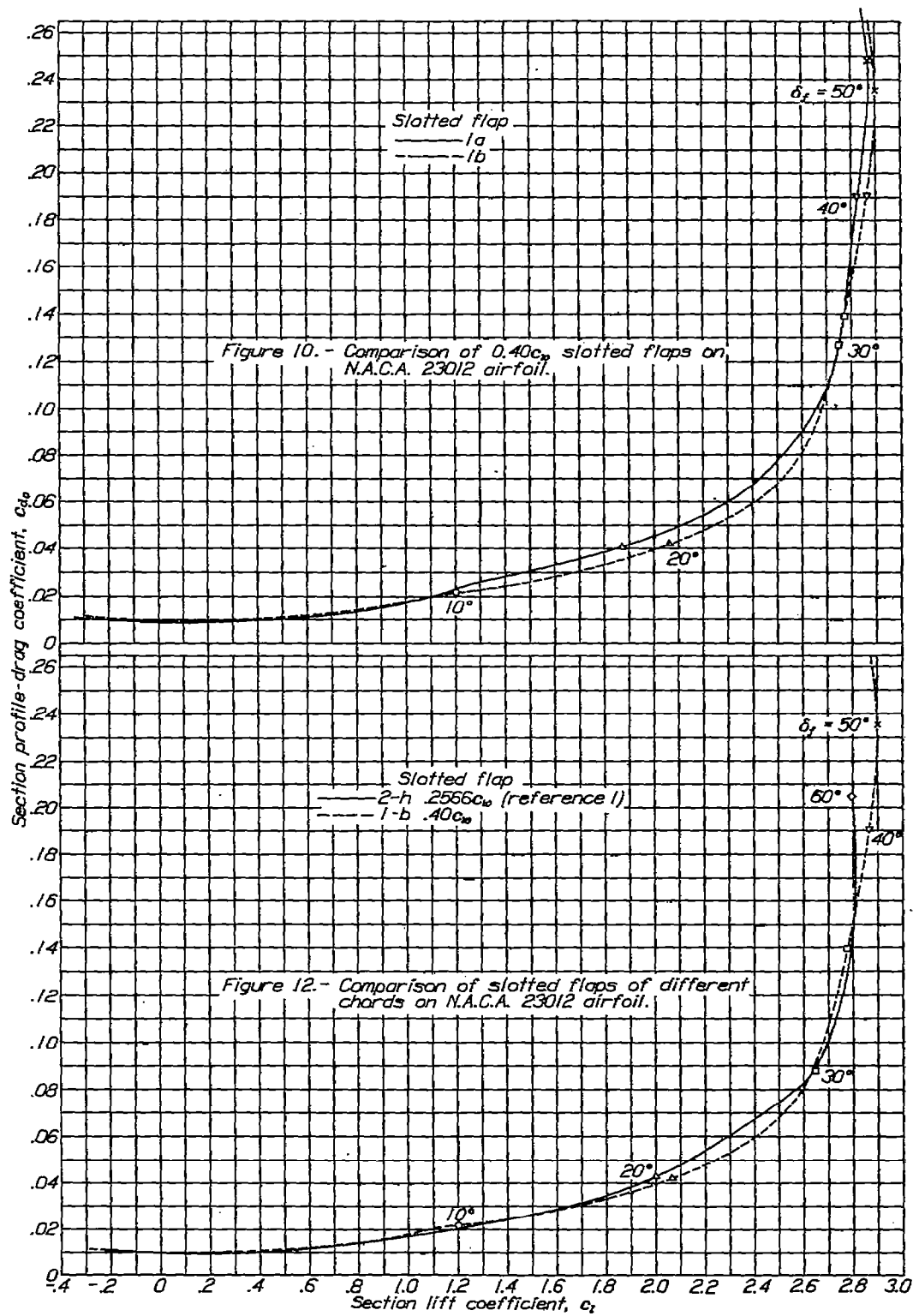

Figure 9.- Section aerodynamic characteristics of N.A.C.A. 23012 airfoil with  $0.40c_b$  slotted flap l-b.



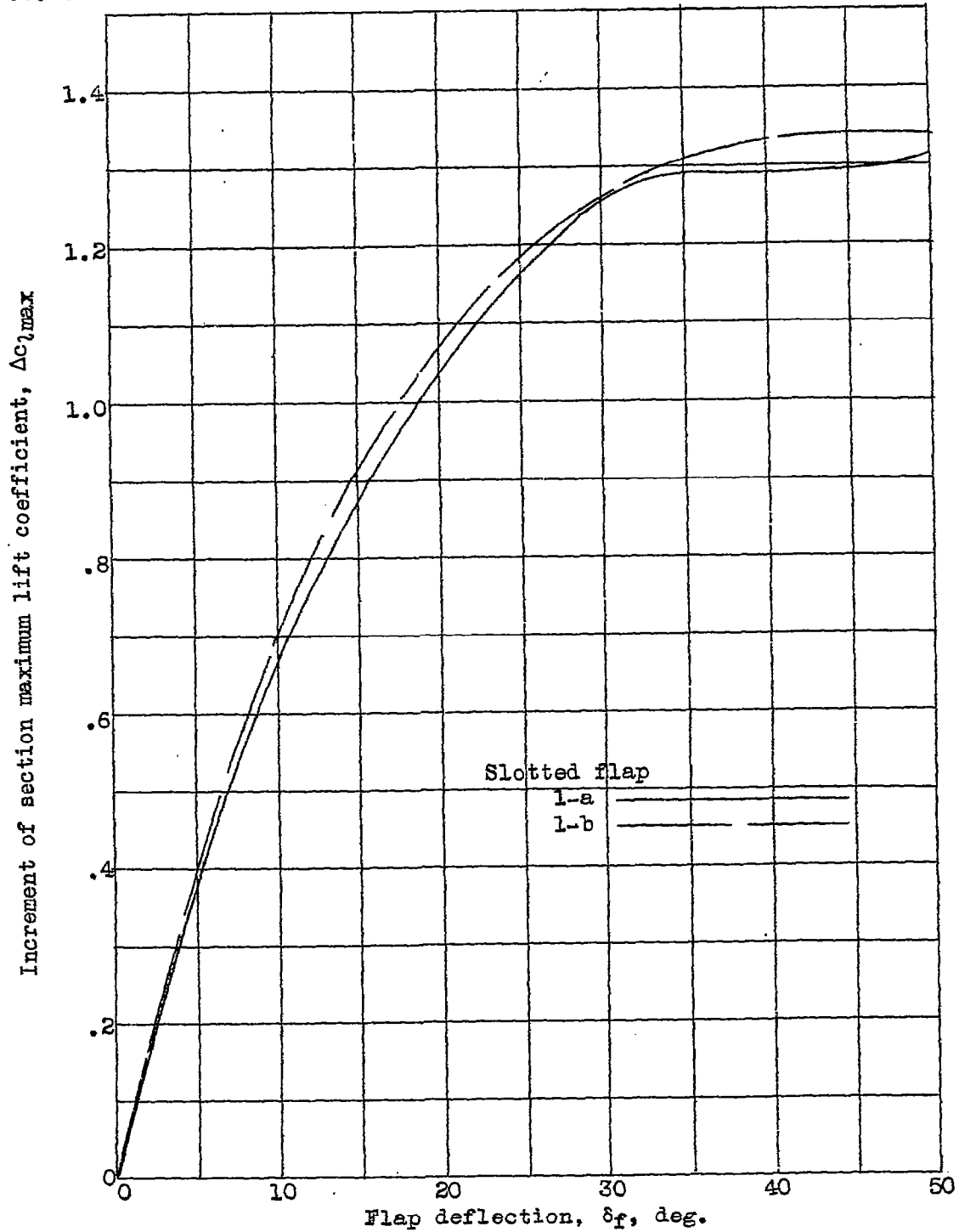

Figure 11.- Comparison of increments of section maximum lift coefficient for slotted flaps 1-a and 1-b when moved and deflected along the selected optimum paths.

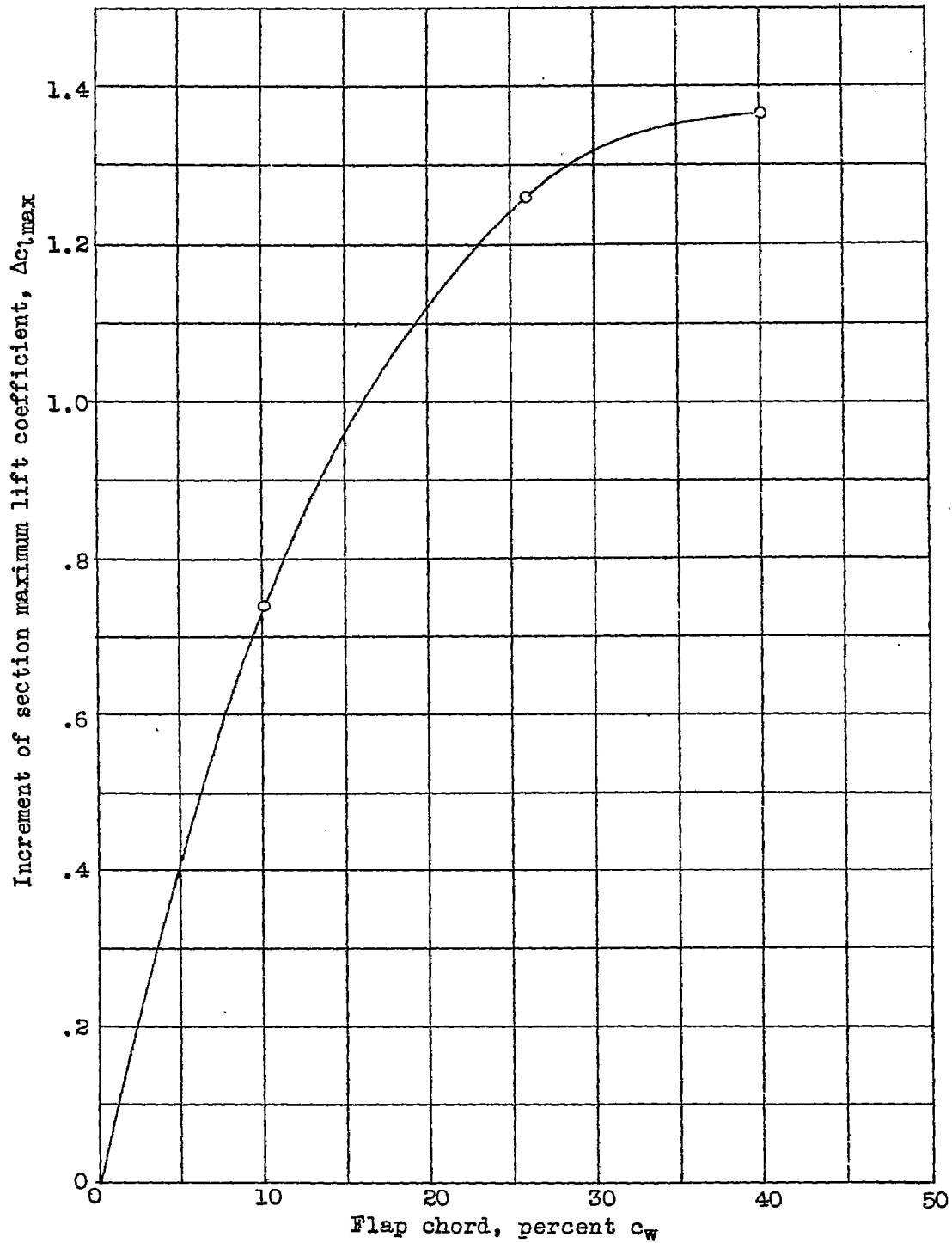

Figure 13.- Variation of increment of section maximum lift coefficient with flap chord. Slotted flaps on N.A.C.A. 23012 airfoil.