

TN 1209

# NATIONAL ADVISORY COMMITTEE FOR AERONAUTICS

TECHNICAL NOTE

No. 1209 1071



EXHAUST-VALVE TEMPERATURES IN A LIQUID-COOLED  
AIRCRAFT-ENGINE CYLINDER AS AFFECTED BY  
ENGINE OPERATING VARIABLES

By Alois T. Sutor, Lester C. Corrington  
and Carl Dudugjian

Aircraft Engine Research Laboratory  
Cleveland, Ohio



Washington  
February 1947

TECHNICAL LIBRARY  
AIRCRAFT MANUFACTURING CO.  
5851-5851 SEPULVEDA BLVD.  
INGLEWOOD,  
CALIFORNIA

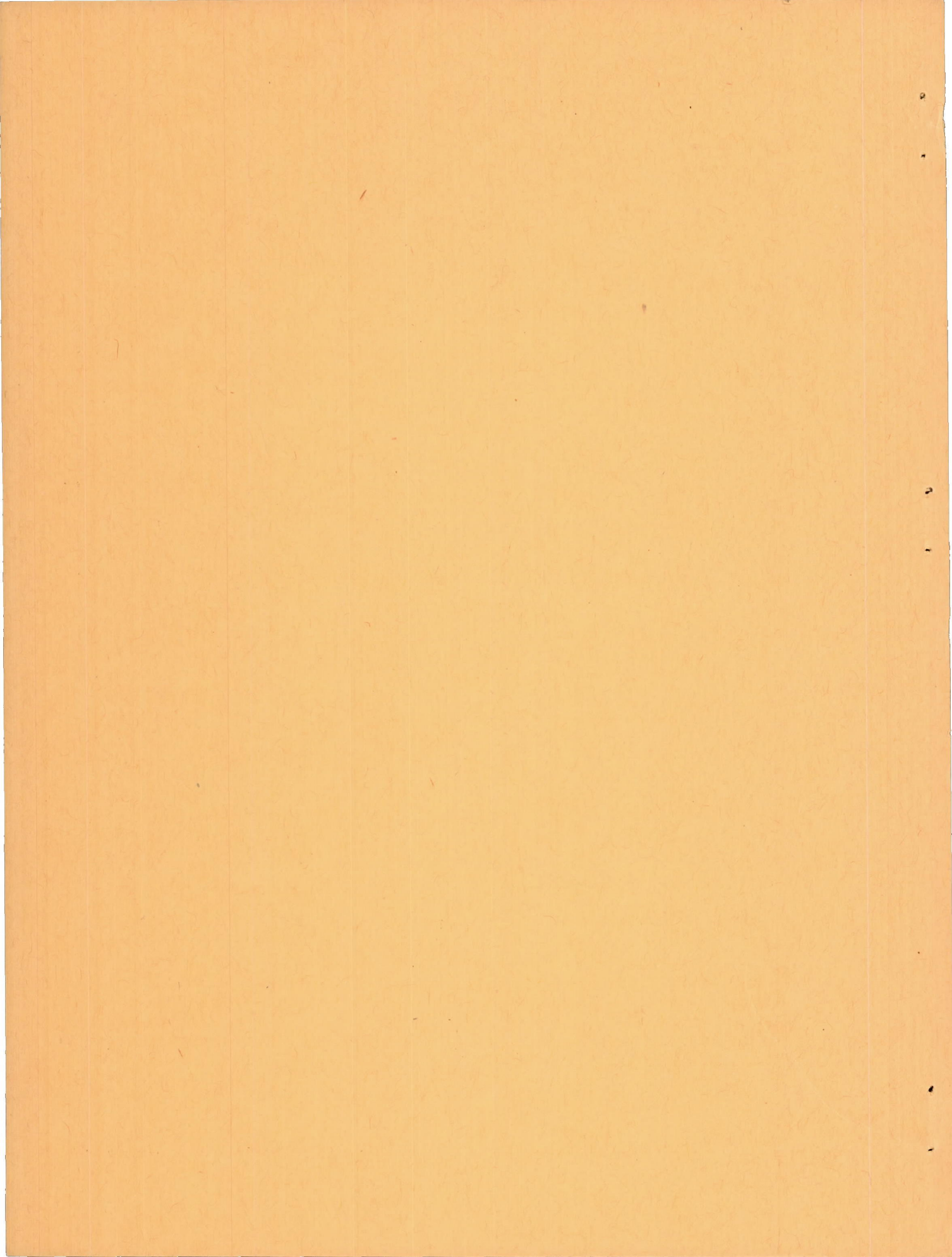

NATIONAL ADVISORY COMMITTEE FOR AERONAUTICS

TECHNICAL NOTE NO. 1209

EXHAUST-VALVE TEMPERATURES IN A LIQUID-COOLED  
AIRCRAFT-ENGINE CYLINDER AS AFFECTED BY  
ENGINE OPERATING VARIABLES

By Alois T. Sutor, Lester C. Corrington  
and Carl Dudugjian

SUMMARY

The operating temperatures of sodium-cooled exhaust valves in a liquid-cooled cylinder were investigated for a large variety of engine conditions by means of a thermocouple embedded in the valve head. Measurements were also made of the exhaust-gas and the cylinder-head temperatures. Only one of the six cylinders in a multicylinder block was fired for these tests.

The engine operating variables that affected the valve temperature most for a given percentage change in the operating variable were: (a) fuel-air ratio, (b) indicated mean effective pressure, (c) compression ratio, and (d) spark advance (for greatly advanced or retarded positions). Injection of internal coolants (water or a mixture of 50 percent water and 50 percent alcohol) at a constant indicated mean effective pressure decreased the valve temperature for a fuel-air ratio richer than stoichiometric although the use of an equal weight of additional fuel was more effective; for a fuel-air ratio leaner than stoichiometric the injection of water alone decreased the valve temperature but the injection of a mixture of water and alcohol increased the valve temperature at all except the highest ratios of internal coolant to fuel. An increase in external cooling was not an effective means of lowering valve temperature.

Valve-temperature measurements revealed that corrosion and deposits on the surface of the valve head affected its temperature at the engine conditions tested. Operation at a measured temperature above  $1500^{\circ}$  F was possible without preignition when a valve with a nonscaling (Nichrome-coated) head was used but preignition was encountered at a measured temperature of about  $1350^{\circ}$  F when a valve with scale on the head (uncoated head) was used. The temperature

distribution around the valve head as measured by the thermocouple was not uniform; the temperature was highest on the portion of the valve head nearest the exhaust spark plug.

## INTRODUCTION

An investigation has been conducted at the NACA Cleveland laboratory to determine the effect of engine operating variables on the exhaust-valve temperatures of a liquid-cooled aircraft-engine cylinder. This investigation was given impetus by the occurrence of preignition in cylinders of this design on several occasions at this laboratory. The preignition was thought to be caused by overheated exhaust valves. Previous investigations of exhaust-valve temperatures have had a somewhat limited scope in that only a few operating variables were examined; in this investigation a large number of operating variables were explored over wide ranges. Measurements of the operating temperatures of both Nichrome-coated and uncoated exhaust valves, and of the temperatures necessary to induce preignition were included. Exhaust-gas and cylinder-head temperatures were measured to show their relation to the exhaust-valve temperature.

The valve-temperature measurements were made with a thermocouple embedded in the valve head. This method had been previously used to measure the temperature at the center of the crown of a hollow-head sodium-cooled valve. (See reference 1.) The engine used for the present tests was equipped with tulip-type valves having sodium-filled stems. In a valve of this design the hottest part of the valve head is between the stem, which is cooled by the action of the sodium, and the outer edge, which is cooled by the contact with the seat. The thermocouple was installed in a position estimated to be the hottest part. Only one of the six cylinders in a multicylinder block was fired for these tests and only one of the two exhaust valves in the cylinder was provided with a thermocouple.

## APPARATUS

### Engine Setup

Engine. - The tests were conducted on a single-cylinder engine using a liquid-cooled multicylinder aircraft-engine block adapted to a CUE crankcase. (See reference 2.) The cylinder bore is 5.5 inches; the stroke 6.0 inches; the displacement is then 142.5 cubic inches.

The normal compression ratio of this engine is 6.65. An electric dynamometer absorbed the engine power and an NACA balanced-diaphragm dynamometer-torque indicator (reference 3) measured the torque. The test engine was lubricated with Navy 1120 oil and was cooled with a mixture of 30 percent AN-E-2 ethylene glycol and 70 percent water by volume.

Induction system. - Combustion air was supplied from the central laboratory system through a pressure-regulating valve, a thin-plate orifice, and an electric heater to the surge tank shown in figure 1. The fuel and internal coolants (when used) passed through calibrated rotameters and then were injected at the entrance to a vaporization tank through which the mixture passed before induction into the cylinder. (See fig. 1.) The vaporization tank was baffled to promote vaporization and thorough mixing of the fuel, the internal coolant (when used), and the air. Inlet-air temperature was measured at the exit of the surge tank and mixture temperature was measured near the exit of the vaporization tank. The inlet-air-pressure tap was located in the inlet elbow near the cylinder port.

Exhaust system. - The exhaust gases passed through a short water-jacketed pipe into a silencer and then through a 4-inch pipe to a 24-inch header. The pressure in the header was maintained at about 4 inches of water below atmospheric, which gave an average pressure at the entrance to the silencer of  $30 \pm 1$  inches of mercury absolute for all of the tests except that with variable exhaust pressure. During this test the 4-inch exhaust pipe was connected to the central laboratory altitude-exhaust system and the exhaust pressure was controlled by valves in this system. Exhaust-pressure measurements were made in the silencer near the entrance.

#### Thermocouple Installations

Exhaust-valve thermocouple. - The exhaust-valve-thermocouple installation used is shown in figure 2. Stock sodium-cooled valves with a stem diameter of  $5/8$  inch and a head diameter of  $1\frac{3}{4}$  inches were used for all tests. The thermocouple junction was formed in the valve head at a point  $9/16$  inch from the center by joining a constantan wire with the valve steel. The constantan wire and a stainless-steel stem were extended from the valve to a position outside the cylinder where the thermocouple circuit was completed. The thermoelectric potential in most tests was measured by a portable potentiometer with balance of the potentials indicated by a light-beam galvanometer. In some tests a self-balancing potentiometer was

used. The stainless steel used for the extended stem had a negligible thermoelectric potential when joined with the steel of the valve stem. Because of the design of the one-wire thermocouple, electrical circuits parallel to the valve-steel and constantan circuit occurred from the valve seat through the aluminum cylinder head and the bronze valve guide to the valve stem or to the valve-spring retainer and then to the valve stem. The error introduced by the possible circulating currents was investigated in bench tests for a one-wire thermocouple installed in a hollow-head sodium-cooled valve (having the same metal composition) of an air-cooled cylinder and was found to be negligible (reference 4). The error introduced in the present thermocouple measurements is also believed to be negligible.

A thermocouple was installed in each of four exhaust valves. Two of these valves (valves 1 and 2) had uncoated heads and the other two (valves 3 and 4) had Nichrome-coated heads. The valve material is a high chrome-nickel austenitic steel, AMS-5700, and the Nichrome coating is a nickel-chrome alloy, AMS-5682, which is used primarily as a corrosion-resistant coating. The thermocouple installation for valve 3 differed from that for the other three valves in that the extended stem was designed for intermittent rather than sliding contact with the external circuit. This valve was used to check the thermocouple readings of a valve with sliding contacts in order that the presence of stray electromotive forces due to the sliding contacts could be detected. No appreciable discrepancies were observed.

Calibration curves for the four valves are shown in figure 3. The points for valve 2 (uncoated) were obtained after more than 50 hours of operation in the engine, including a momentary temperature as high as 1870° F. These points coincide with the curve for valves 1 and 3, which were new at the time of calibration. The curve for valve 4 is slightly different; a variation in the thermoelectric properties of the steel valve stock may account for this deviation.

Exhaust-gas thermocouple. - Exhaust-gas temperatures were measured near the center of the exhaust-gas pipe with a quadruple-shielded chromel-alumel thermocouple (fig. 4).

Cylinder-head thermocouple. - Measurements of cylinder-head temperatures were made with an iron-constantan thermocouple installed in a hole drilled directly above the exhaust-spark-plug bushing to a point midway between the two exhaust-valve seats. (See fig. 5.) The results of previous tests indicate this point to be in the highest-temperature region of the cylinder head.

## TEST PROCEDURE

A basic set of engine operating conditions was chosen (approximately normal rated power conditions for the full-scale multicylinder engine); each operating variable was individually tested while the others were maintained constant at the basic value. The following table shows the basic values and the range through which each operating variable was tested:

Operating variable	Basic value	Range investigated
Fuel-air ratio	0.085	0.057-0.118
Indicated mean effective pressure, lb/sq in.	200	141-294
Engine speed, rpm	2600	1300-3000
Spark advance, deg B.T.C.		
Inlet	28	10-77
Exhaust	34	16-83
Mixture temperature, °F	200	87-274
Outlet coolant temperature, °F	250	122-269
Coolant-flow rate, gal/min	105	75-129
Exhaust pressure, in. Hg absolute	30	8-54
Compression ratio	6.65	5.00-9.75

Runs were also made with variable engine speed with the indicated mean effective pressure adjusted to maintain constant indicated horsepower.

In order to obtain information on exhaust-valve temperatures encountered during high-output operation, additional runs were made at an engine speed of 3000 rpm (which is take-off rated speed for the full-scale engine) with an indicated mean effective pressure of 300 pounds per square inch (which is approximately 25 percent higher than the rated take-off indicated mean effective pressure for the full-scale engine) and a mixture temperature of 130° F. Temperature measurements were made as the fuel-air ratio was varied from 0.06 to about 0.11. This power level was the highest attainable without knock in the fuel-air-ratio range investigated with the fuel used.

Tests with internal coolants were run at two fuel-air ratios, 0.085 and 0.06, with ratios of internal coolant to fuel from 0 to about 1.0. The inlet-air temperature was adjusted to give the basic mixture temperature (200° F) with no internal-coolant flow

and was held constant as the internal coolants were injected. The internal coolants used included water and a mixture of 50 percent water and 50 percent ethyl alcohol by volume (referred to herein as "water-alcohol mixture"). The ethyl alcohol was denatured with 5 percent methyl alcohol.

With the exception of the tests with variable compression ratio, 28-R fuel was used (minimum-quality specification AN-F-28), the compression ratio was 6.65, and the inlet-oil temperature was 135° F. Because 28-R fuel knocked at the highest compression ratios tested, a fuel blend of 90 percent triptane and 10 percent benzene with 3.6 milliliters TEL per gallon was used for the compression-ratio tests. The use of this fuel blend resulted in cylinder temperatures approximately equal to those obtained with 28-R fuel at basic conditions.

Friction runs (which were required to compute indicated mean effective pressure) were made by motoring the engine at test conditions with no fuel flow. Friction readings were taken as quickly as possible after a period of firing.

## RESULTS AND DISCUSSION

### Temperature Variations at Constant Engine Conditions

Temperature distribution around exhaust-valve head. - The sealing qualities of a valve and the stress distribution in the valve head depend in part on the temperature pattern around the valve head under operating conditions. Because the exhaust valve rotates in its guide during the tests, this temperature pattern around the circle described by the thermocouple junction could be determined. The rate of rotation was about  $1\frac{1}{2}$  rpm at the basic operating conditions; subsequent runs revealed that this speed is about normal for similar operating conditions without the thermocouple installation.

With all the engine conditions maintained at the basic values, temperature measurements were made every 45° as the valve rotated. A radial pattern of the results thus obtained is shown in figure 6. The maximum temperature difference is about 70° F, with the minimum temperature directly opposite the maximum. At engine speeds between 2100 and 3000 rpm, the difference between the maximum and minimum valve temperature changed as the engine speed was changed; an increase in engine speed resulted in a smaller temperature difference. Increasing the engine speed caused the rate of rotation of the valve to



increase and at the high rates of rotation the time was probably insufficient for the temperature at the thermocouple junction to follow the fluctuations measured at the lower rates of rotation. At an engine speed of 2100 rpm this temperature difference was about 100° F, whereas at 3000 rpm it was about 50° F. Between these two values the difference was approximately linear with engine speed.

The angular location of the maximum temperature with respect to the cylinder head is also shown in figure 6. Several factors may cause one side of the valve to have a higher temperature than the other side; possibly the origin of the combustion near this side of the valve is most important. Also of importance is the probability that more of the exhaust gases pass through the valve on the side nearer the cylinder wall because the path on this side is more direct. Temperature variations around the valve seat would also influence the temperature variations around the valve head; no attempt was made to measure the temperature distribution around the valve seat because of thermocouple-installation difficulties. Tests conducted on an air-cooled cylinder from a radial engine at the NACA Cleveland laboratory have shown that the temperature-distribution pattern around the valve seat is similar in shape to that for the valve shown in figure 6. The temperature pattern around the valve head and seat might have been different, however, had all six cylinders in the multicylinder block been fired.

Because the maximum temperature during rotation of the exhaust valve is of most importance with reference to preignition, valve corrosion, and valve strength, only maximum temperatures are presented, except where otherwise noted.

Effect of surface condition on exhaust-valve temperature. - Frequent determinations of the exhaust-valve temperature were made at the basic operating conditions. These measurements showed that the temperature varied as much as 50° F for the two valves with uncoated heads. When these valves were removed from the cylinder, scale and deposits were observed on the surface of the valve head. The surface condition of one of these valves (valve 2) after 36 hours of operation is shown in figure 7. When this valve was cleaned of all deposits and scale and the seating surfaces were reground, the temperature at the basic engine operating conditions was found to have increased about 50° F above the temperature measured just before the cleaning and reseating. Evidently, the scale and deposits acted as an insulating layer and when they were removed more heat was transferred from the hot cylinder gases to the valve. An investigation made at this laboratory on an air-cooled cylinder has shown that the amount of corrosion and deposits

on uncoated exhaust-valve heads varies with power output, which may account for much of the variation of valve temperatures at the basic operating conditions after periods of variable engine operation.

### Effect of Engine Operating Variables on

#### Exhaust-Valve Temperature

Fuel-air ratio. - The valve temperature reacts to changes in fuel-air ratio in the manner characteristic of most cylinder-head temperatures (fig. 8). For the test at an engine speed of 2600 rpm and an indicated mean effective pressure of 200 pounds per square inch (approximately normal rated power output), the maximum temperature of  $1254^{\circ}$  F occurred at a fuel-air ratio of about 0.068, with a rapid decrease in temperature as the mixture was leaned or enriched from this value.

Exhaust-gas and cylinder-head temperatures are also shown in figure 8 for comparison. Because the exhaust-gas thermocouple (fig. 4) had not been installed when the valve and cylinder-head temperatures were obtained, the exhaust-gas temperatures were obtained later; the data from this repeat test are shown as a dashed line in figure 8.

Tests made at high power output with the mixture temperature lowered to avoid knock are also presented in figure 8. The maximum valve temperature was  $1336^{\circ}$  F at the test conditions noted.

Indicated mean effective pressure. - The rate at which the exhaust-valve temperature increased with increasing indicated mean effective pressure is shown in figure 9. The relation is not quite linear: the higher the power level, the lower the rate of temperature increase. At the basic conditions (indicated mean effective pressure, 200 lb/sq in.), the valve temperature increased approximately  $1.2^{\circ}$  F for an increase in indicated mean effective pressure of 1 pound per square inch, which is equivalent to a valve-temperature increase of approximately  $2.6^{\circ}$  F per horsepower. The corresponding rates of increase for exhaust-gas and cylinder-head temperatures are about  $1.4^{\circ}$  and  $1.2^{\circ}$  F per horsepower, respectively. Exhaust-valve-temperature data for an air-cooled cylinder in references 4 (fig. 9) and 5 (fig. 12) show that the rate of temperature change with indicated mean effective pressure is about the same as the value given in this report, although the operating conditions were considerably different. The data for the air-cooled cylinder

also show that changes in valve and port design, which changed valve-temperature levels as much as 200° F, did not appreciably affect the rate of temperature change with indicated mean effective pressure.

Engine speed. - The variation of exhaust-valve temperature with engine speed when the indicated mean effective pressure is held constant is shown in figure 10. At the basic condition of 2600 rpm, the valve temperature changed approximately 4.5° F per 100-rpm change in engine speed or 1.3° F per horsepower. The exhaust-gas and the cylinder-head temperatures changed about 2.0° and 0.6° F per horsepower, respectively, at the same conditions. A comparison of these values with those obtained from figure 9 is shown in the following table:

Operating variable	Basic value of variable	Slope of curve at basic conditions (°F/hp)		
		Exhaust valve	Exhaust gas	Cylinder head
Indicated mean effective pressure	200 lb/sq in.	2.6	1.4	1.2
Engine speed	2600 rpm	1.3	2.0	.6

For a given change in power output, the valve and cylinder-head temperatures were affected less and the exhaust-gas temperature was affected more when the change in power output was caused by a change in engine speed than when caused by a change in indicated mean effective pressure.

When the engine speed was increased and the indicated horsepower maintained constant, the valve temperature decreased (fig. 11). The cylinder-head temperature also decreased but the exhaust-gas temperature increased. A brief analysis will show that these trends are in accordance with the indications of figures 9 and 10.

Although the valve temperature changed somewhat with engine speed at constant indicated horsepower, a correlation, which has a maximum variation with test data of ±30° F, has been derived that expresses the valve temperature as a function of indicated horsepower for various fuel-air ratios (fig. 12). For this correlation the average valve temperature was used and was assumed to be halfway between the maximum and minimum valve temperature for each data point. Because the rate of valve rotation varies during operation at different engine speeds, it may be expected to influence the

values of maximum and minimum valve temperature. In this correlation the average temperature was chosen to relate the variables tested rather than the maximum temperature because it more closely represents the over-all effect of heat addition to the valve head regardless of the rate of valve rotation. Data were taken from the runs of figures 8 to 11 and from two additional runs with variable fuel-air ratio. A three-dimensional plot (fig. 12) was made to represent the average valve-temperature data, using a linear scale for fuel-air ratio and logarithmic scales for valve temperature and indicated horsepower. These logarithmic scales permit the variation of valve temperature with indicated horsepower to be represented by straight lines. Within the engine-speed range of 2100 to 3000 rpm, this plot may be used to estimate the average valve temperature for various values of indicated horsepower and fuel-air ratio. The maximum valve temperature may be obtained by making an addition to the average temperature ranging linearly from 50° F at 2100 rpm to 25° F at 3000 rpm.

Spark advance. - The effect of spark advance on the exhaust-valve temperature at constant indicated power is presented in figure 13. These data show that the valve temperature is lowest at a spark advance of approximately 26° and 32° B.T.C. for the inlet and the exhaust, respectively. Advancing or retarding the spark from this point increased the valve temperature. This minimum point occurred at a spark advance near the peak-power value for these operating conditions. The value of peak-power spark advance was determined by noting the spark advance at which maximum power was obtained for a constant manifold pressure.

Data from two different valves were used to obtain the exhaust-valve-temperature curve of figure 13. At values of spark advance above 58° and 64° B.T.C. (inlet and exhaust, respectively), preignition occurred with the uncoated valve; this condition necessitated the use of a valve with a Nichrome-coated head (valve 3) to obtain data at higher values of spark advance. The data from these two valves showed sufficient agreement to be represented by a single curve. (See fig. 13.)

The variations of exhaust-gas and cylinder-head temperatures with spark advance are also shown in figure 13. The minimum point for the exhaust-gas-temperature curve occurs at a spark timing slightly advanced from the peak-power position; the minimum point for the cylinder-head-temperature curve is retarded from the peak-power position. The spark advance for minimum temperature of the exhaust valve was about midway between those for minimum temperatures of the exhaust gas and the cylinder head.

Mixture temperature. - The effect of mixture temperature on exhaust-valve temperature at constant indicated power is presented in figure 14. The relation is linear; the valve temperature changed about  $23^{\circ}$  F per  $100^{\circ}$  F change in mixture temperature.

The temperatures of the exhaust gas and cylinder head also varied linearly with mixture temperature. The exhaust-gas temperature varied about  $25^{\circ}$  F and the cylinder-head temperature about  $8^{\circ}$  F, respectively, per  $100^{\circ}$  F change in mixture temperature.

Outlet coolant temperature. - The tests at various outlet coolant temperatures revealed that an increase in external cooling had a relatively small effect on the exhaust-valve temperature. The valve temperature changed linearly with coolant temperature at a rate of about  $34^{\circ}$  F per  $100^{\circ}$  F change in coolant temperature. (See fig. 15.) The corresponding rates of change for exhaust-gas and cylinder-head temperature were about  $14^{\circ}$  and  $80^{\circ}$  F, respectively, per  $100^{\circ}$  F change in coolant temperature.

Coolant-flow rate. - The exhaust-valve temperature was unaffected by the flow rate of external coolant in the range tested. (See fig. 16.) The exhaust-gas temperature was also unaffected and the cylinder-head temperature, only very slightly affected. The normal coolant flow is so great that little additional cooling resulted from any reasonable increase.

Exhaust pressure. - As the exhaust pressure was increased, the exhaust-valve temperature also increased. (See fig. 17.) The temperature rise was about  $2.2^{\circ}$  F for a rise in exhaust pressure of 1 inch of mercury. The exhaust-gas and cylinder-head temperatures also increased with exhaust pressure; the rates of increase are  $2.1^{\circ}$  and  $0.4^{\circ}$  F per inch of mercury, respectively, at basic conditions. The temperature rise in each case may be attributed to the decreased expansion of the exhaust gases and the possibility that less fresh charge is blown through the cylinder during the valve-overlap period.

Compression ratio. - The exhaust-valve temperature decreased rapidly as the compression ratio increased from 5.00 to 8.00, but decreased more slowly with a further increase in compression ratio (fig. 18). As the compression ratio was increased from 5.00 to 9.75 the total drop in valve temperature was  $130^{\circ}$  F. For this same change in compression ratio the exhaust-gas temperature dropped about  $310^{\circ}$  F and the cylinder-head temperature decreased about  $30^{\circ}$  F.

This decrease in cylinder-head temperature with increasing compression ratio may be explained by the fact that the temperature at the cylinder-head-thermocouple location between the exhaust-valve seats (fig. 5) is influenced by the temperature of the exhaust gas.

Comparison of effects of engine operating variables. - In order to facilitate a comparison of the effects of operating variables on the exhaust-valve temperature, the curves showing these effects have been superimposed in figure 19. The individual curves have been vertically adjusted to pass through a common point. This point represents the approximate average of a large number of check determinations at the basic operating condition. Any variation in a temperature measurement at this basic condition was caused by scaling of the valve head, deposits on the valve head, distortion of the valve head, and experimental error. Very little adjustment in temperature ( $2^{\circ}$  to  $9^{\circ}$  F) was necessary to make most of the curves pass through this point but in one case (variable spark advance) an adjustment of  $23^{\circ}$  F was made. In two other cases (variable compression ratio and variable exhaust pressure) an adjustment of  $13^{\circ}$  F was necessary.

This composite plot shows the effect of any operating variable tested on exhaust-valve temperature in comparison with the effect of any other operating variable. The exhaust-valve temperature changed most rapidly for given percentage differences in fuel-air ratio, indicated mean effective pressure, compression ratio, and spark advance in the greatly advanced or retarded position; changed less rapidly for given percentage differences in exhaust pressure, mixture temperature, coolant temperature, spark advance in the normal range of settings, and engine speed (at constant indicated horsepower and at constant indicated mean effective pressure); and was unaffected by any change in coolant flow for the range tested.

Internal coolants. - The data for internal-coolant injection at fuel-air ratios of 0.085 and 0.06 are shown in figures 20(a) and 20(b), respectively. In figure 21(a) the effects of water injection, water-alcohol injection, and mixture enrichment with fuel on the temperature of the exhaust gas, the exhaust valve, and the cylinder head are compared for a fuel-air ratio richer than stoichiometric (0.085). The curves for fuel enrichment have been vertically adjusted from the fuel-air-ratio curves shown in figure 8, (engine speed, 2600 rpm; indicated mean effective pressure, 200 lb/sq in.) to pass through points representing the approximate average temperature of a large number of check determinations at the basic operating conditions. The curves for internal coolants have also been vertically adjusted a small amount to pass through the average temperature at the basic condition. From this basic condition, the

two coolants shown were injected at increasing rates up to coolant-fuel ratios of about 1.0. These curves show that mixture enrichment with fuel was considerably more effective as a coolant than the use of either water or the water-alcohol mixture. If water or a water-alcohol mixture is necessary for knock suppression, however, and if all other conditions are equal, less external cylinder cooling would be required with the use of the water-alcohol mixture than with the use of the water mixture. The greatest difference between these two coolants was in their effect on the exhaust-gas temperature. Water injection cooled the exhaust gas very little; whereas the water-alcohol mixture cooled it appreciably. Two causes are apparent for this effect: (1) The alcohol is a fuel and therefore effectively enriches the mixture; and (2) Unpublished tests on this engine have shown that water slows the burning more than a water-alcohol mixture, thereby increasing the exhaust-gas temperature by effectively retarding the ignition timing. (See fig. 13.)

The foregoing results on the relative effectiveness of water injection, water-alcohol injection, and mixture enrichment with additional fuel apply only if the fuel-air ratio is richer than the stoichiometric mixture. If the fuel-air ratio is leaner than stoichiometric the effect of internal-coolant injection becomes quite different, as shown in figure 21(b), when the internal coolants are injected at a basic fuel-air ratio of 0.06. The internal-coolant curves were again vertically adjusted a slight amount to meet at the basic condition. At this fuel-air ratio water was the best coolant in the lower flow region, whereas additional fuel was the best when large flow rates were required. When the water-alcohol mixture was used, the temperatures first rose and then declined gradually as more internal coolant was added. The effect of the water-alcohol mixture was to enrich the fuel-air mixture toward stoichiometric until a coolant-fuel ratio of about 0.47 (calculated stoichiometric mixture) was reached because alcohol is a fuel; a further increase in coolant-fuel ratio enriched the fuel-air mixture beyond stoichiometric and decreased the temperature. Up to a coolant-fuel ratio of 1.0, the cylinder temperatures associated with water-alcohol injection remained substantially higher than with water alone.

With water injection at high flow rates, the exhaust-gas temperature began to rise quite steeply as the rate of water injection was increased (fig. 21(b)). This rise was caused by the slower burning accompanying the water injection as proved by obtaining a curve with the spark advanced to the peak-power value for each point. When the engine was operated in this manner, the exhaust-gas temperature continued to decline as more water was injected at high flow rates.

### Exhaust-Valve Temperatures at Which Preignition Was Encountered

Preignition was encountered twice during the course of this investigation and was detected by an abnormal rise in cylinder temperature. The exhaust valves and spark plugs are the only probable sources of preignition in this engine; because cold-operating spark plugs were used, the preignition probably originated at the exhaust valves. Subsequent inspection revealed that the valve with the thermocouple was most likely the source in both cases because of much greater scaling of the head.

When the data for the spark-advance curves of figure 13 were obtained, the tests were started with an uncoated valve that had just been cleaned of all scale and deposits. With this clean valve no difficulty was encountered when the temperature reached  $1365^{\circ}$  F. After operation for about 6 hours at various conditions on another part of the test program, preignition was encountered at  $1345^{\circ}$  F. After this case of preignition the valve temperature for given operating conditions was found to be consistently higher than when the valve was first installed. Upon examination the valve was found to leak more than usual, probably because of permanent distortion of the valve head when subjected to the high temperatures associated with preignition. The consistently higher temperatures for the check points of figure 13 are attributed to this leakage.

A few hours later preignition was again encountered with this valve and this time it was allowed to continue for several minutes. At the start of preignition the valve temperature was  $1350^{\circ}$  F and it rose rapidly as preignition advanced. When the valve reached a temperature of about  $1870^{\circ}$  F (extrapolated on calibration curve, fig. 3) a large drop in engine power was noted. When the engine was disassembled, the valve was found to have a portion of the head melted away within about  $1/2$  inch of the thermocouple junction (fig. 22). The head of the valve with the thermocouple was badly scaled; whereas the head of the other exhaust valve was in good condition.

Temperatures slightly above  $1500^{\circ}$  F (extrapolated on calibration curve) were measured without preignition when a valve with a Nichrome-coated head was used. Reference 6 points out that an austenitic valve steel, similar to that used in the valves for this investigation, and stellite are probably prone to lead attack at temperatures above  $1380^{\circ}$  F, whereas a nickel-chrome alloy, similar to the Nichrome coating on the present valve heads, was found to resist rapid lead attack up to about  $1550^{\circ}$  F. A mixture of lead oxide and iron oxide was believed to form an insulating layer on the surface of uncoated valves that induced preignition. The foregoing results indicate that the scale and deposits, which formed on the head of



the uncoated valve, probably reached a temperature sufficiently high to cause preignition, whereas the temperature of the valve steel as measured by the thermocouple remained substantially below this temperature. Because the Nichrome-coated valve did not scale at the temperatures encountered in the test engine, the temperature of the surface exposed to the combustion chamber was probably not much greater than that measured by the thermocouple and preignition did not occur.

The destructive tendencies of preignition can be appreciated by noting the effect of abnormal spark advance on temperatures shown in figure 13. The high temperatures resulting from preignition well advanced from normal spark timing may cause valve distortion, scaling, and improper seating with consequent burning of the valve head.

#### ACCURACY AND PRECISION

Accurate measurements of the temperature of the exhaust-valve head during calibration were obtained by means of a standard thermocouple spot-welded to the valve head. The valve head was heated in an electric furnace but the stem projected through a hole in the furnace and was cooled by an air blast. The external thermocouple contacts used for calibration were those used for obtaining actual test data on the engine. The static calibration is believed to be accurate within  $5^{\circ}$  F. Errors caused by heat conduction along the thermocouple wire may be as high as  $25^{\circ}$  F. The error introduced by using the one-wire thermocouple because of circulating currents and the error due to stray electromotive forces at the sliding contacts are believed small enough that the measured temperatures are probably within  $40^{\circ}$  F of the true values. No account has been taken, however, of any changes in the heat-transfer characteristics of the valve that may have been caused by the thermocouple installation.

The exhaust-valve temperature as measured by the thermocouple during engine operation was affected by the surface condition of the valve head and by the conformity of the valve seat to the seat insert in the cylinder block to such an extent that the measured valve temperature varied as much as  $50^{\circ}$  F at the basic engine conditions. When preignition had been encountered, the valve temperature at the basic conditions was abnormally high. For these reasons the data cannot always be compared from one test to another. For each individual test, however, the running time averaged only about 1 hour and the reproducibility of data was found to be within  $15^{\circ}$  F.

The exhaust-gas thermocouple did not measure the true gas temperature but merely indicated the temperature that may be attained by an

engine part subjected to the flow of exhaust gases at the same position in the pipe and at the same cooling conditions. Most of the trends indicated by the exhaust-gas temperatures as measured, however, probably hold for both the total temperature and the static temperature.

#### SUMMARY OF RESULTS

Measurements of the temperatures of sodium-cooled exhaust valves in a liquid-cooled cylinder by means of a thermocouple embedded in the valve head indicated that:

1. For a given percentage change, the following engine operating variables affected the valve temperature most: (a) fuel-air ratio, (b) indicated mean effective pressure, (c) compression ratio, and (d) spark advance (for greatly advanced or retarded positions).

2. At fuel-air ratios richer than stoichiometric and at constant mean effective pressure, the addition of water or a mixture of 50 percent water and 50 percent alcohol decreased the valve temperature; however, the use of an equal weight of additional fuel was more effective.

3. At fuel-air ratios substantially leaner than stoichiometric and at constant mean effective pressure, the injection of a mixture of water and alcohol increased the valve temperature at all except the highest ratios of internal coolant to fuel tested. The injection of water alone, however, decreased the valve temperature.

4. External cooling was not an effective means of lowering the valve temperature.

5. The surface condition of the valve head affected the operating temperature. Surface scale and deposits formed an insulating layer that apparently reached temperatures substantially higher than the temperature of the valve head. Operation at a measured temperature above 1500° F was possible without preignition when a valve with a nonscaling (Nichrome-coated) head was used; preignition was encountered, however, at a measured temperature of about 1350° F with a valve having scale on the uncoated head.

6. The temperature distribution around the valve head when one cylinder out of six in the multicylinder block was fired was not uniform; the temperature was highest on the portion of the valve head nearest the exhaust spark plug. The effect of adjacent operating cylinders on the temperature distribution around the valve head was not determined.

Aircraft Engine Research Laboratory,  
National Advisory Committee for Aeronautics,  
Cleveland, Ohio, September 24, 1946.

#### REFERENCES

1. Sanders, J. C., Wilsted, H. D., and Mulcahy, B. A.: Operating Temperatures of a Sodium-Cooled Exhaust Valve as Measured by a Thermocouple. NACA ARR No. 3L06, 1943.
2. Waldron, C. D., and Biermann, A. E.: Method of Mounting Cylinder Blocks of In-Line Engines on CUE Crankcases. NACA RB No. E4G27, 1944.
3. Moore, Charles S., Biermann, Arnold E., and Voss, Fred: The NACA Balanced-Diaphragm Dynamometer-Torque Indicator. NACA RB No. 4C28, 1944.
4. Mulcahy, B. A., and Zipkin, M. A.: Tests of Improvements in Exhaust-Valve Performance Resulting from Changes in Exhaust-Valve and Port Design. NACA ARR No. E5G26, 1945.
5. Zipkin, M. A., and Sanders, J. C.: Correlation of Exhaust-Valve Temperatures with Engine Operating Conditions and Valve Design. NACA ARR No. E5I20, 1945.
6. Hives, E. W., and Smith, F. Ll.: High-Output Aircraft Engines. SAE Jour. (Trans.), vol. 46, no. 3, March 1940, pp. 106-117.

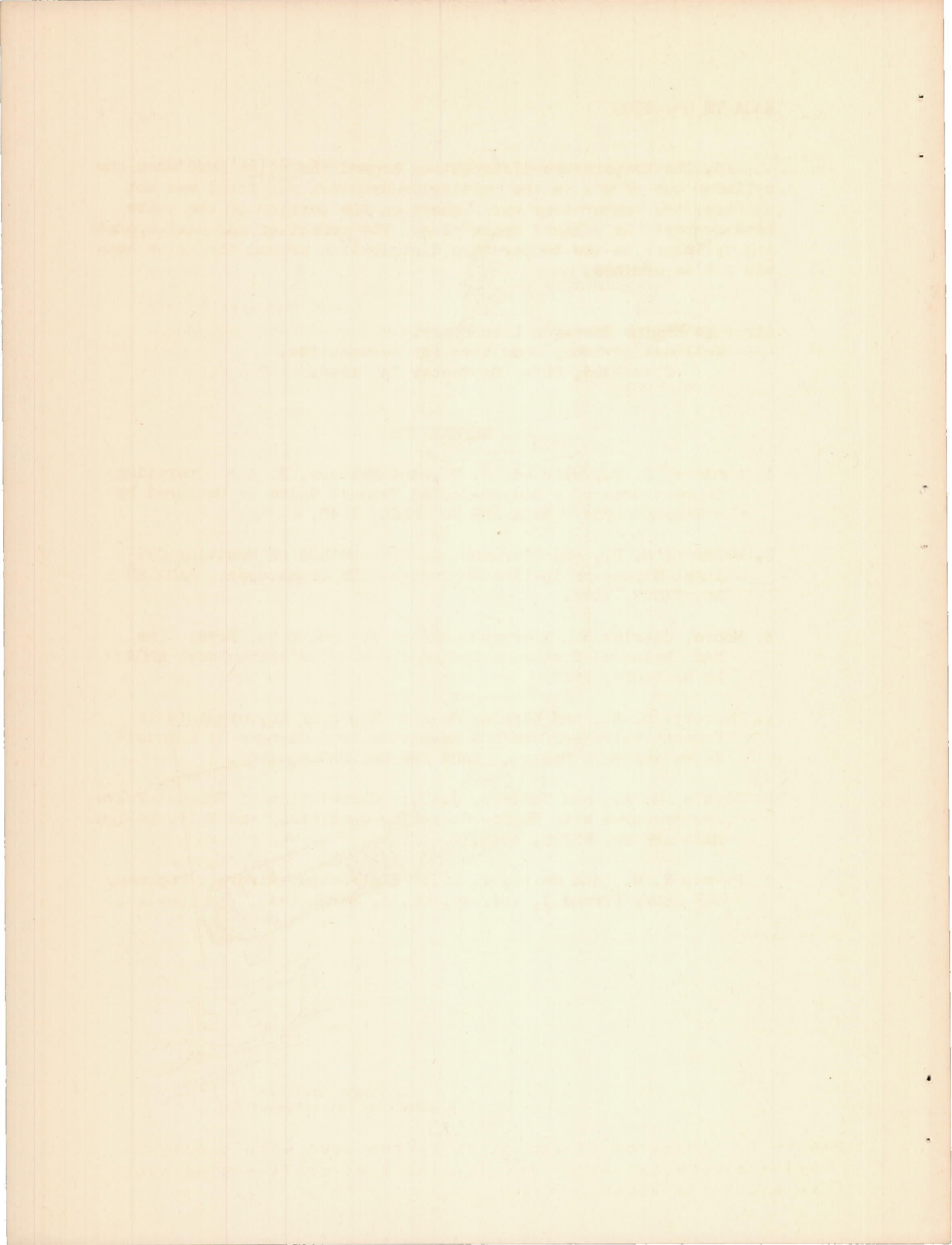

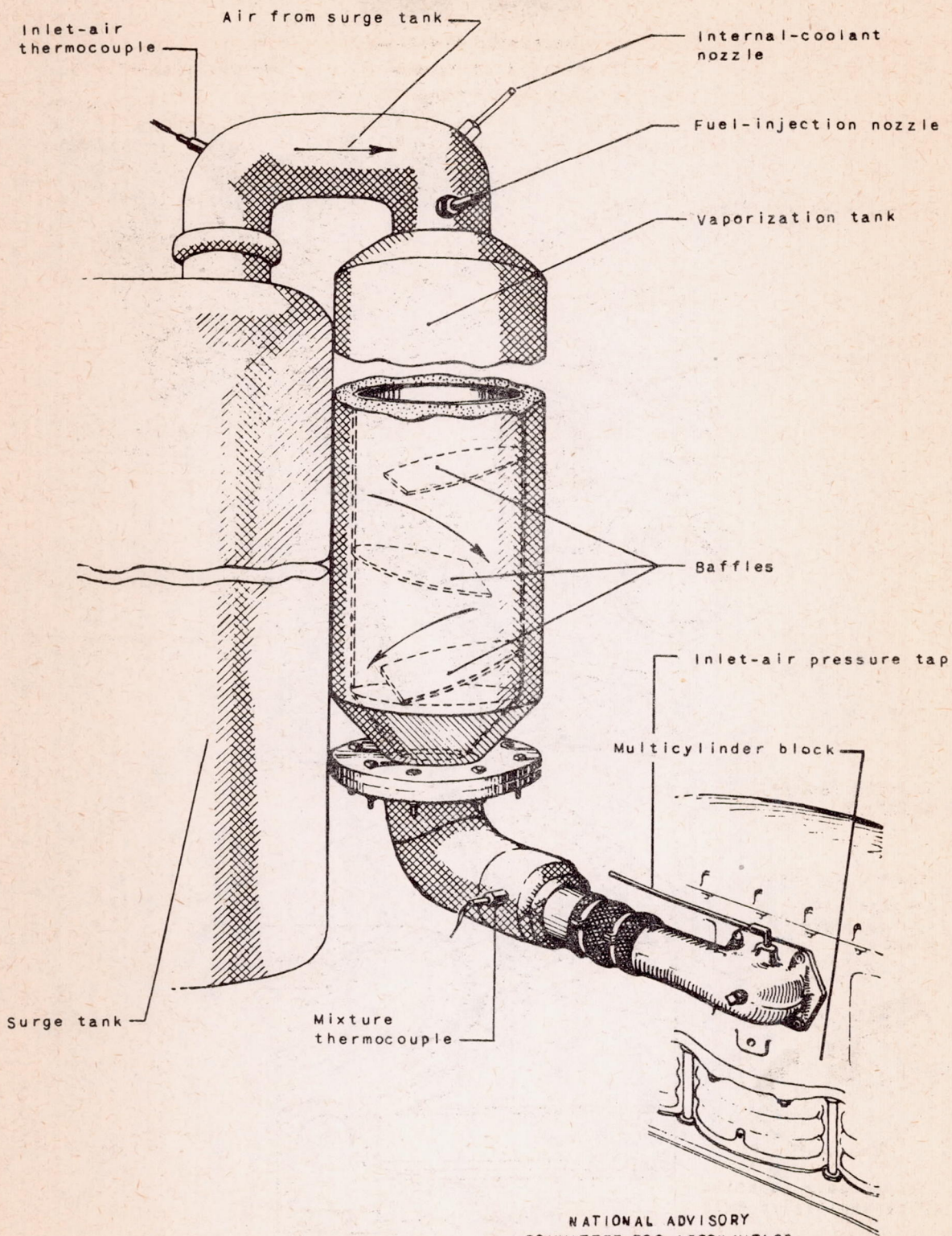

NATIONAL ADVISORY  
COMMITTEE FOR AERONAUTICS

Figure 1. - Diagram of induction system used with single-cylinder adaptation of multicylinder aircraft-engine block to a CUE crankcase.

639

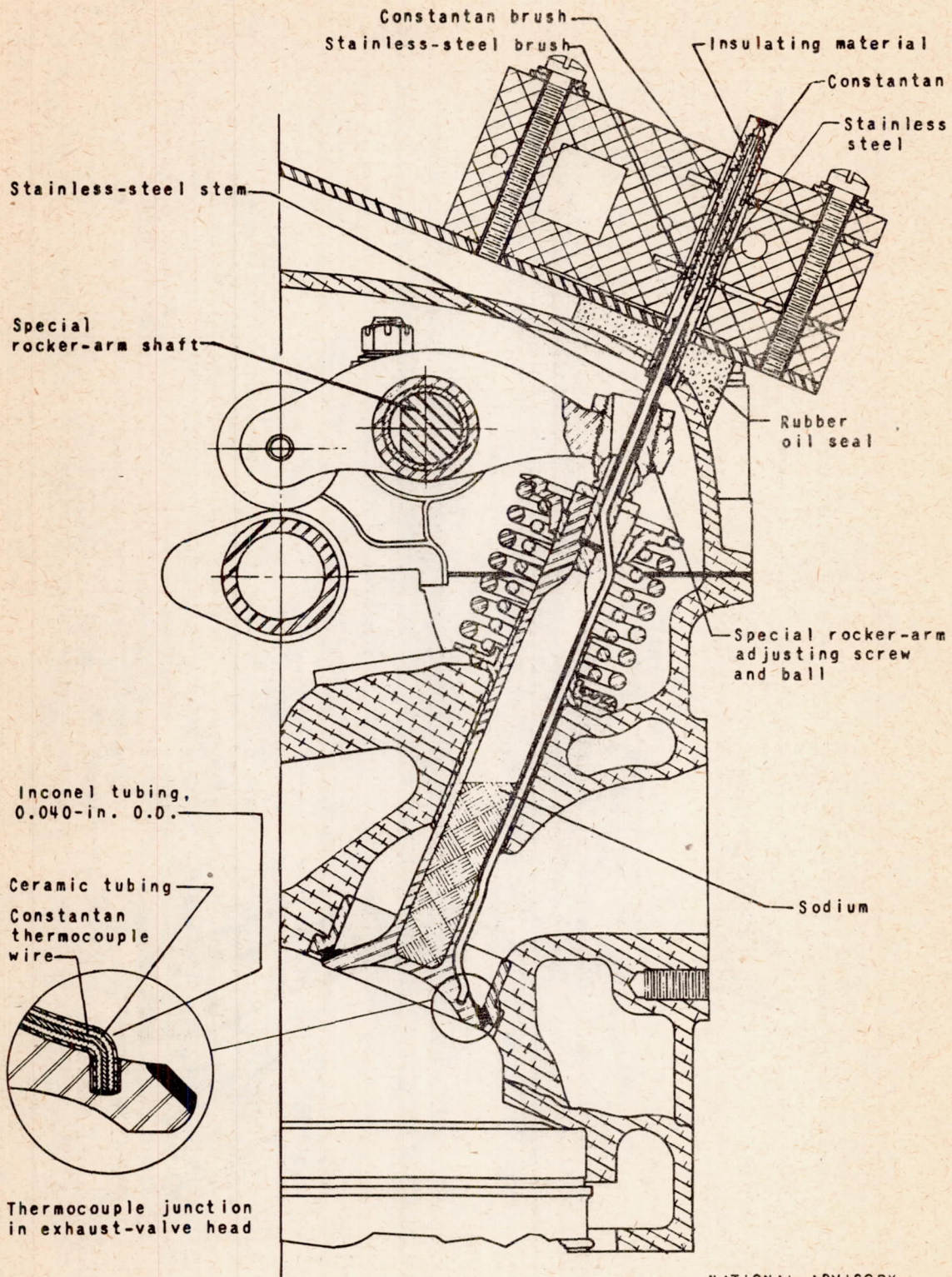

NATIONAL ADVISORY  
COMMITTEE FOR AERONAUTICS

Figure 2. - Exhaust-valve-thermocouple installation in the engine.

639

74+323

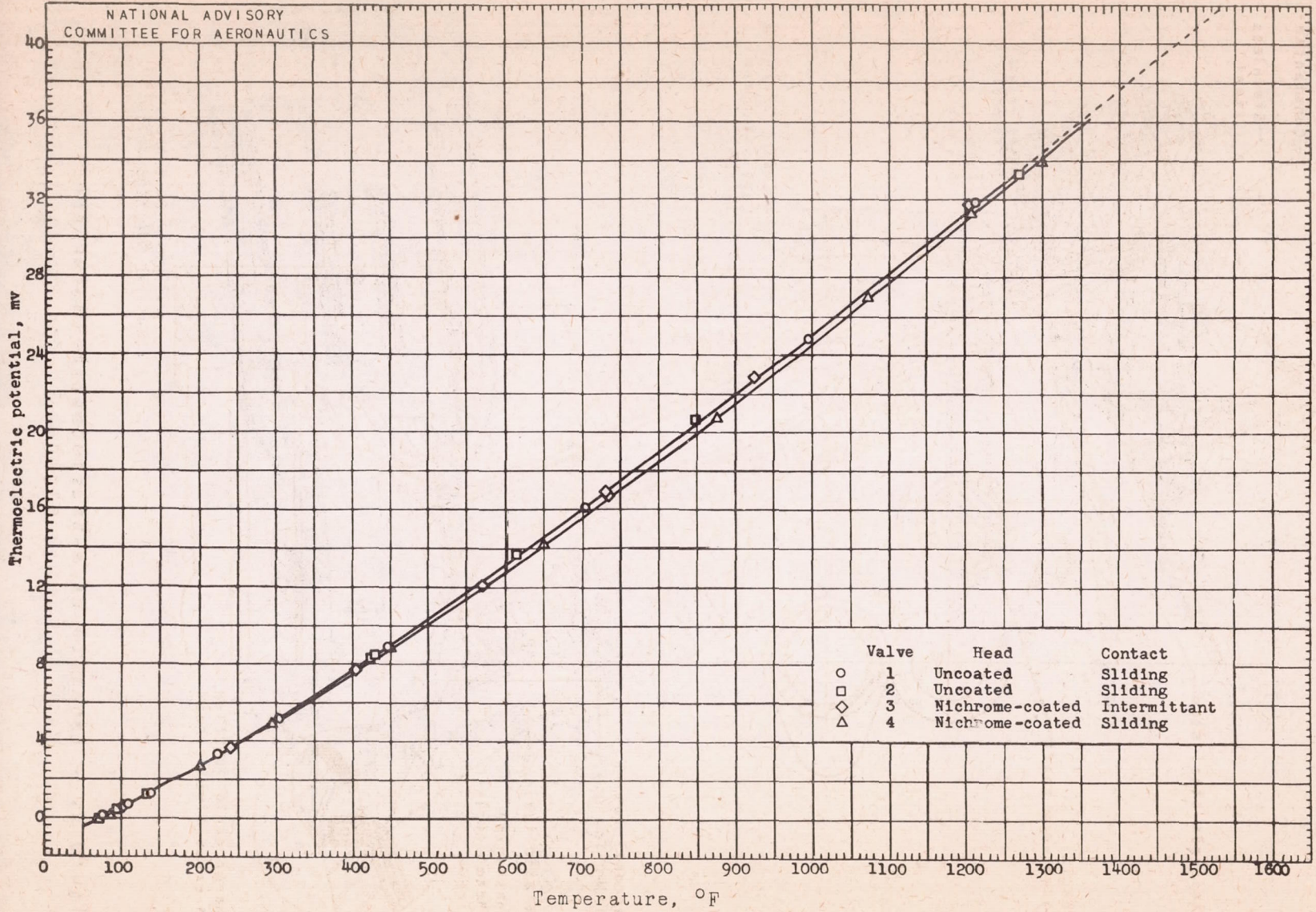
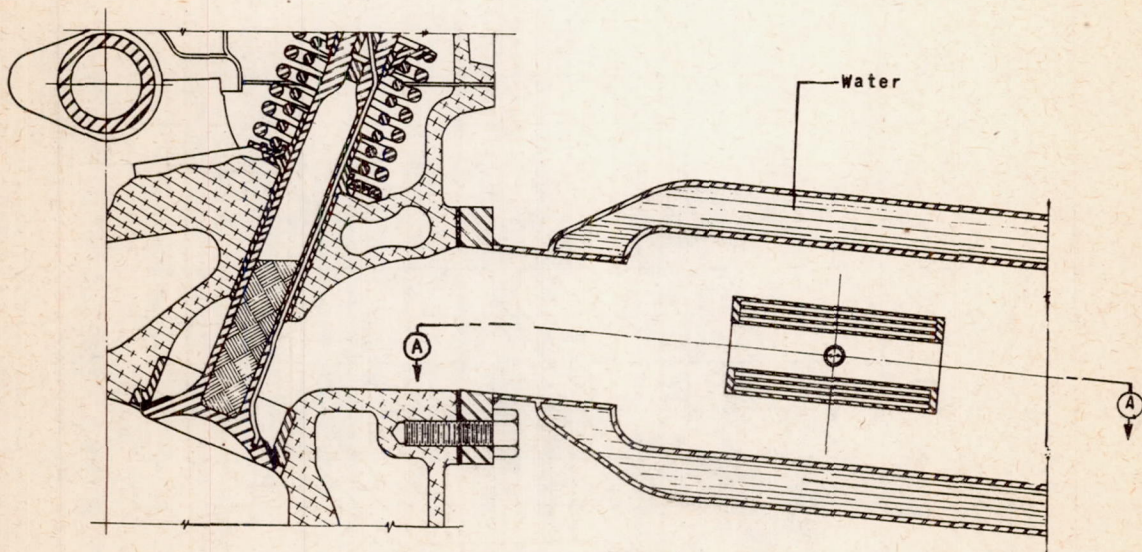
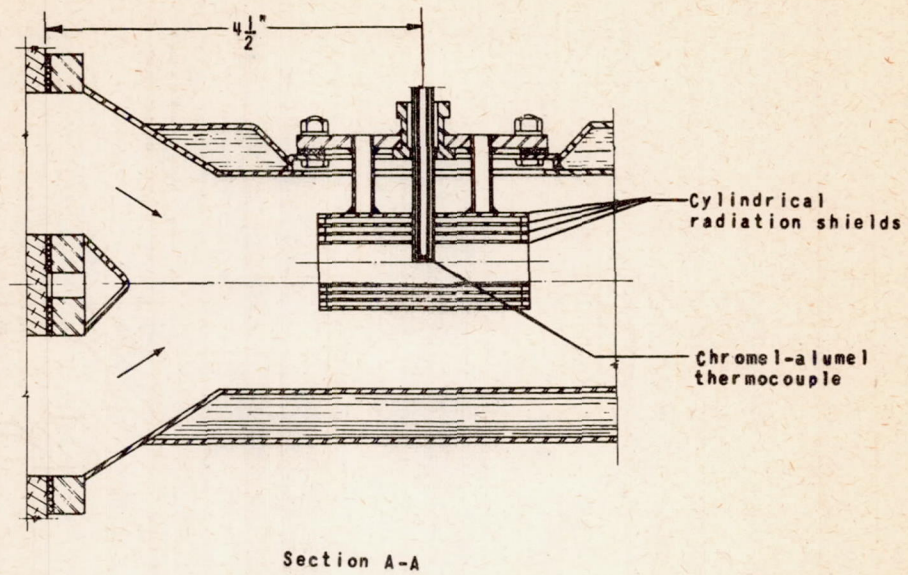

Figure 3. - Calibration curve for exhaust-valve thermocouples.



NATIONAL ADVISORY  
COMMITTEE FOR AERONAUTICS

Figure 4. - Location of exhaust-gas thermocouple.

639

27+389



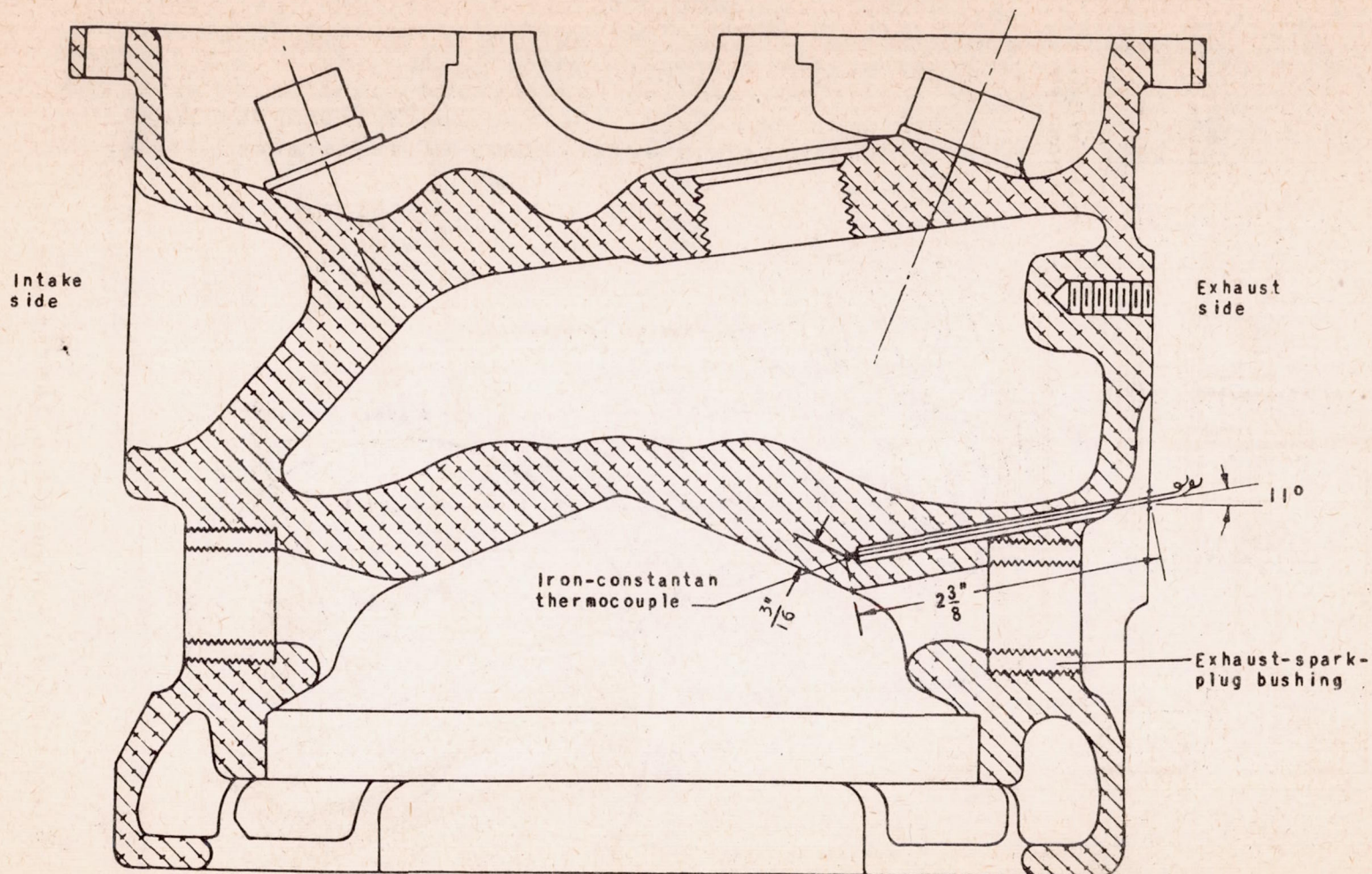

NATIONAL ADVISORY  
COMMITTEE FOR AERONAUTICS

Figure 5. - Location of thermocouple in cylinder head.

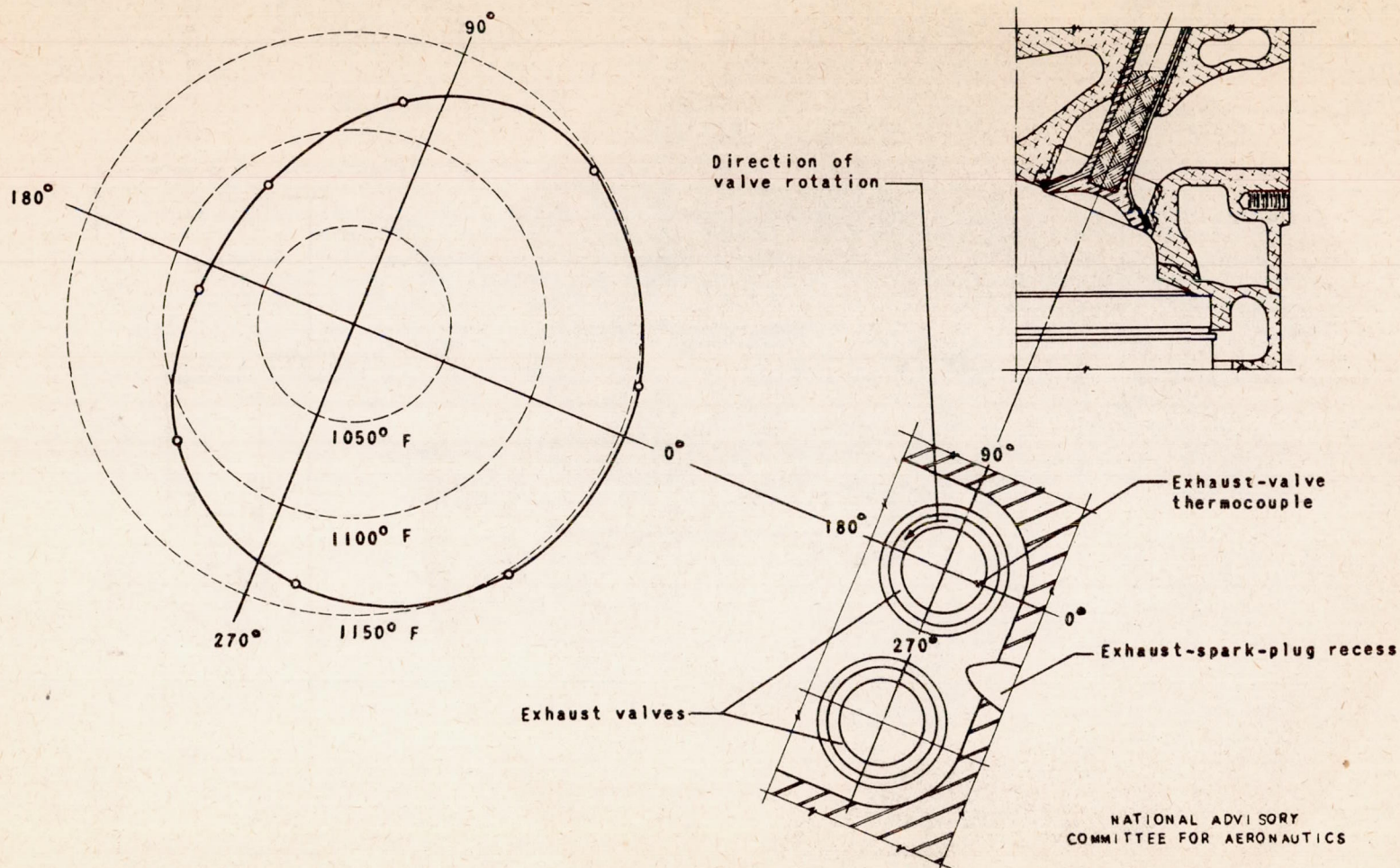
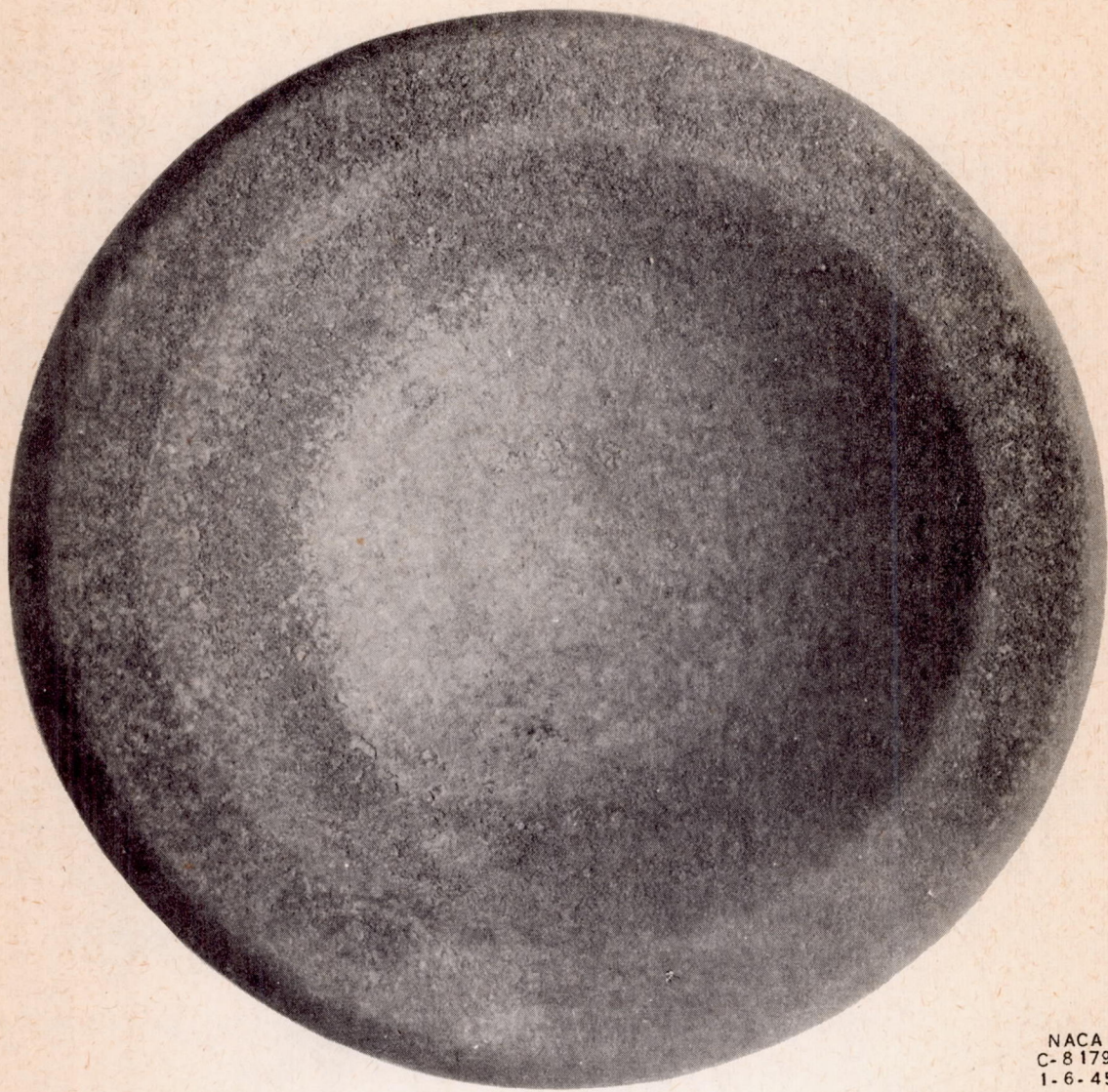

Figure 6. - Exhaust-valve-temperature distribution as measured with thermocouple at constant indicated power output. Fuel-air ratio, 0.085; indicated mean effective pressure, 200 pounds per square inch; engine speed, 2600 rpm; spark advance: inlet,  $28^{\circ}$  B.T.C.; exhaust  $34^{\circ}$  B.T.C.; mixture temperature,  $200^{\circ}$  F; outlet coolant temperature,  $250^{\circ}$  F; coolant flow, 105 gallons per minute; exhaust pressure, 30 inches mercury absolute; compression ratio, 6.65; fuel, 28-R.



NACA  
C-8179  
1-6-45

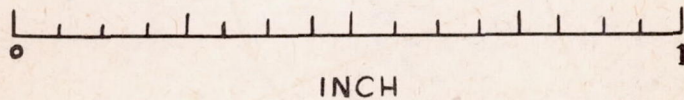

Figure 7. - Scale and deposits on head of valve 2 (uncoated) after 36 hours of operation.

639

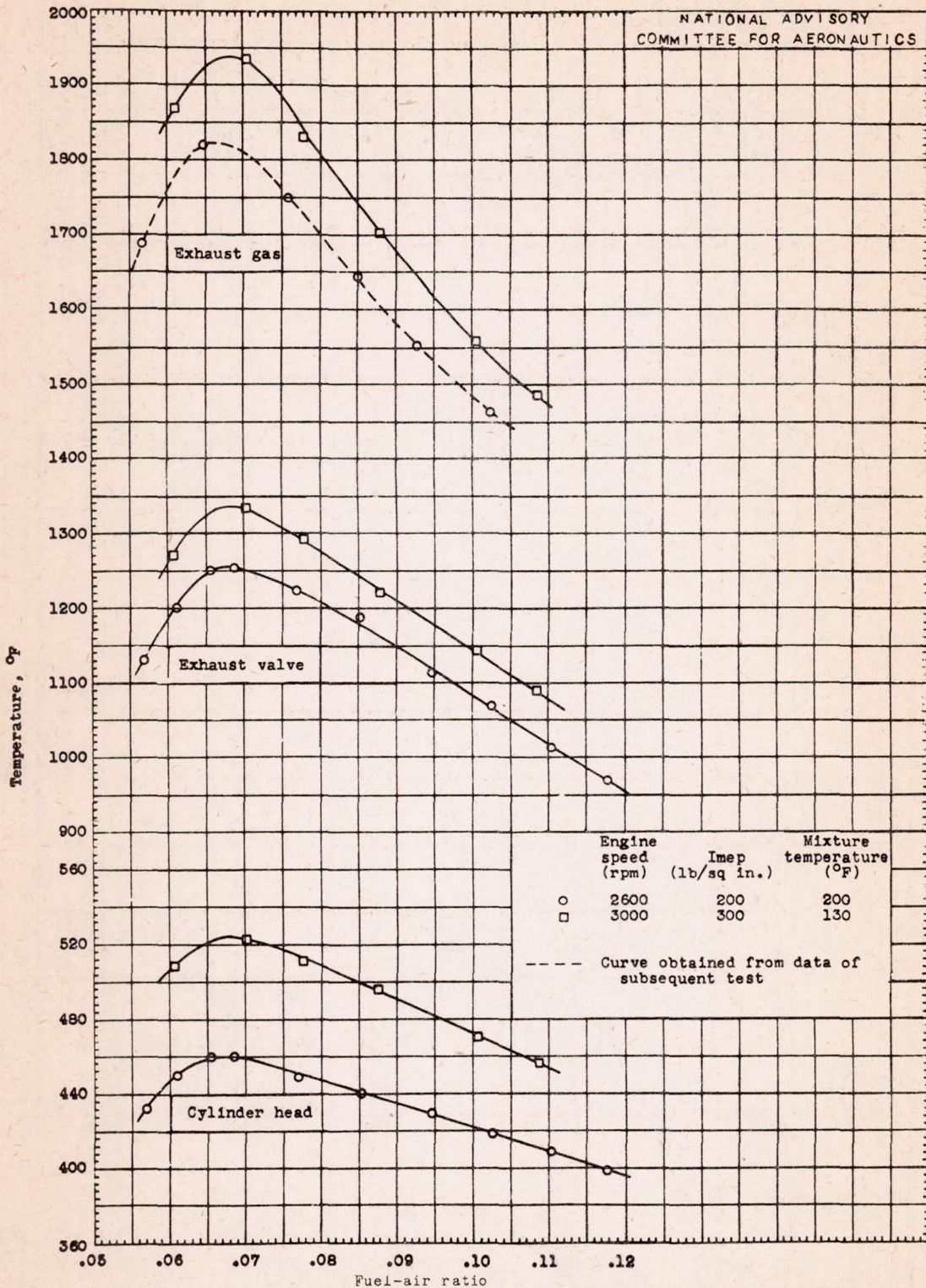

Figure 8. - Effect of fuel-air ratio on temperatures of exhaust valve, exhaust gas, and cylinder head at two different engine conditions. Spark advance: inlet, 23° B.T.C.; exhaust, 34° B.T.C.; outlet coolant temperature, 250° F; coolant flow, 105 gallons per minute; exhaust pressure, 30 inches mercury absolute; compression ratio, 8.65; fuel, 28-R.

639

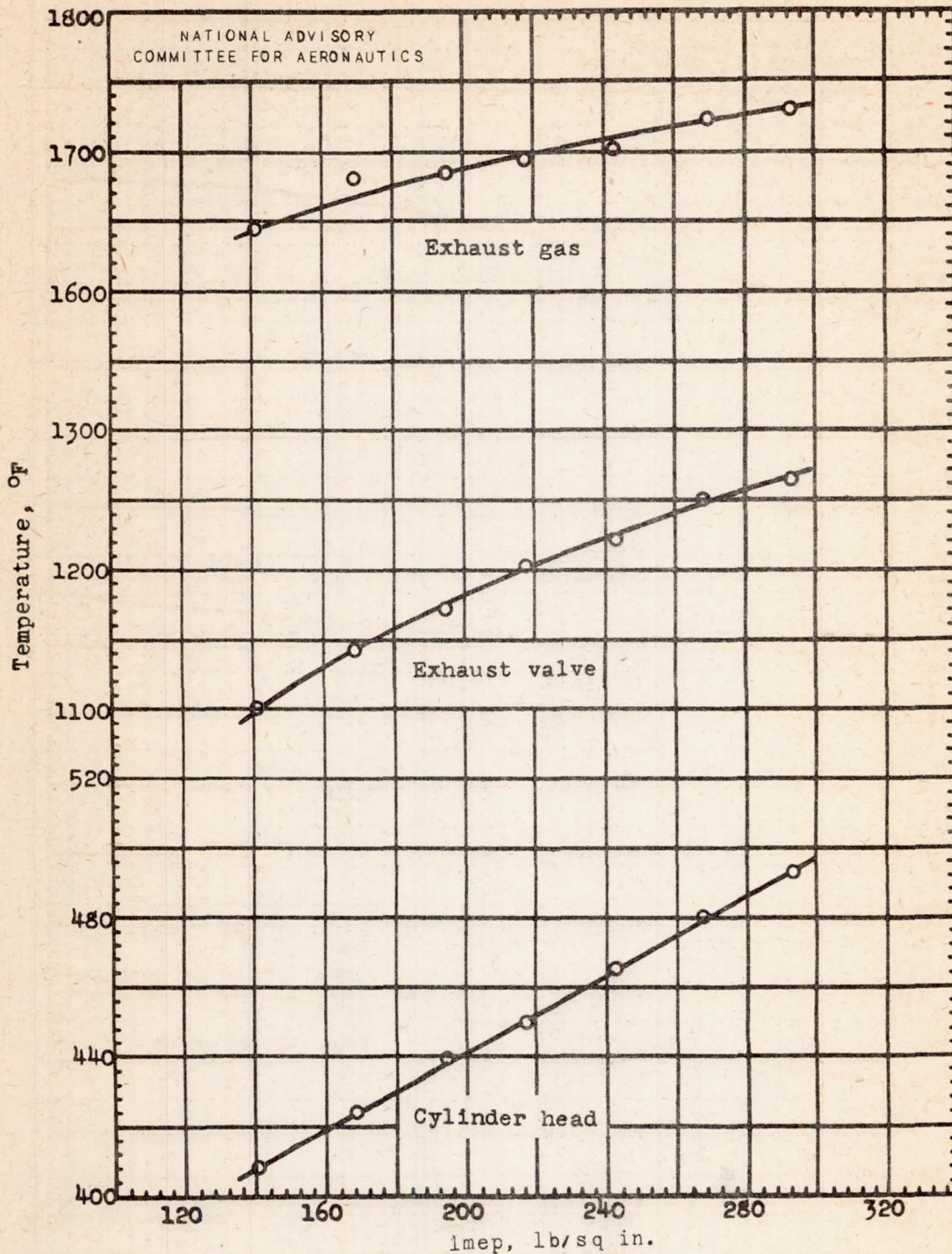

Figure 9. - Effect of indicated mean effective pressure on temperatures of exhaust valve, exhaust gas, and cylinder head at engine speed of 2600 rpm. Fuel-air ratio, 0.085; spark advance: inlet, 28° B.T.C.; exhaust, 34° B.T.C.; mixture temperature, 200° F; outlet coolant temperature, 250° F; coolant flow, 105 gallons per minute; exhaust pressure, 30 inches mercury absolute; compression ratio, 6.65, fuel, 28-R.

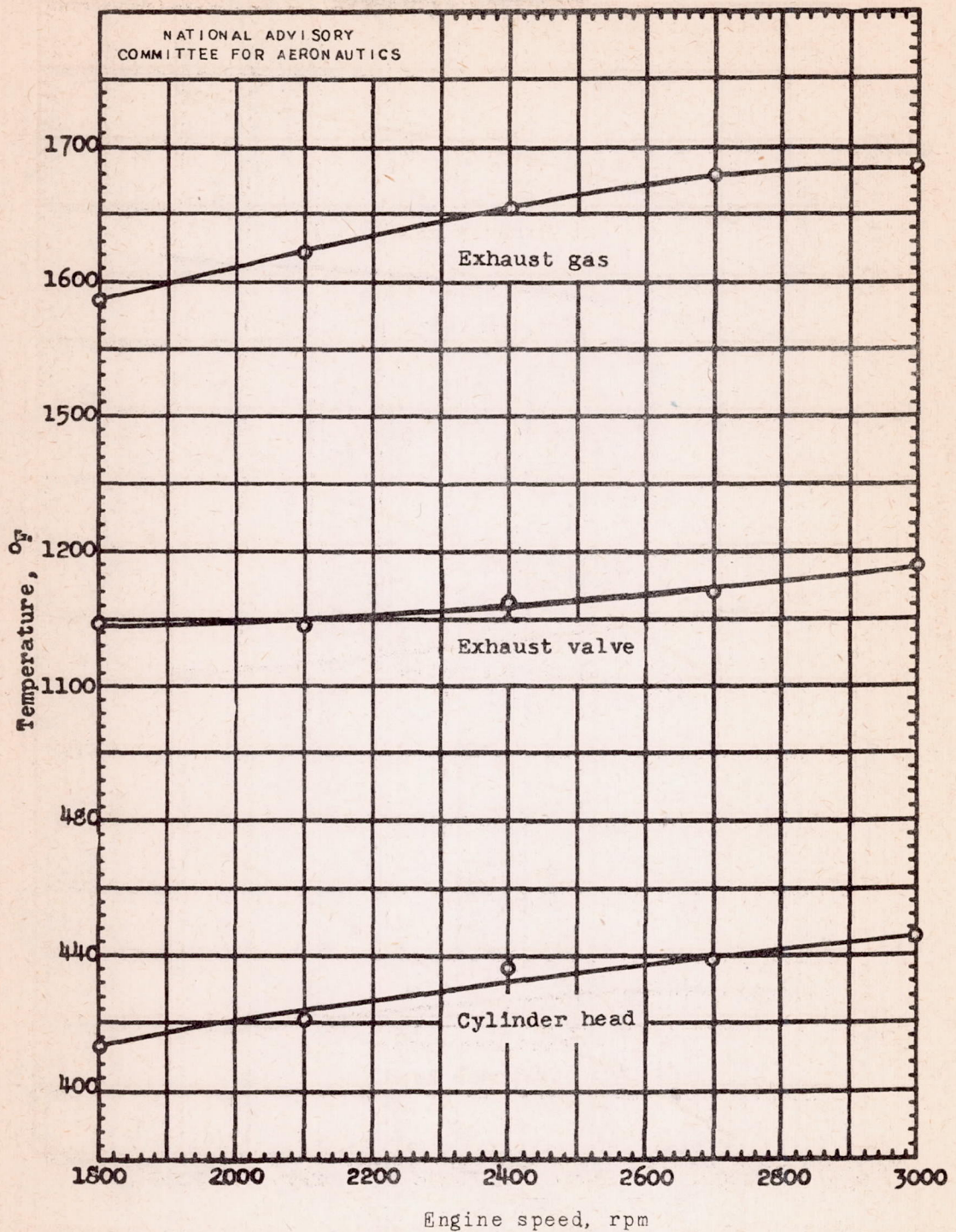

Figure 10. - Effect of engine speed on temperatures of exhaust valve, exhaust gas, and cylinder head at constant indicated mean effective pressure of 200 pounds per square inch. Fuel-air ratio, 0.085; spark advance: inlet, 28° B.T.C.; exhaust, 34° B.T.C.; mixture temperature, 200° F; outlet coolant temperature, 250° F; coolant flow, 105 gallons per minute; exhaust pressure, 30 inches mercury absolute; compression ratio, 6.65; fuel, 28-R.

639

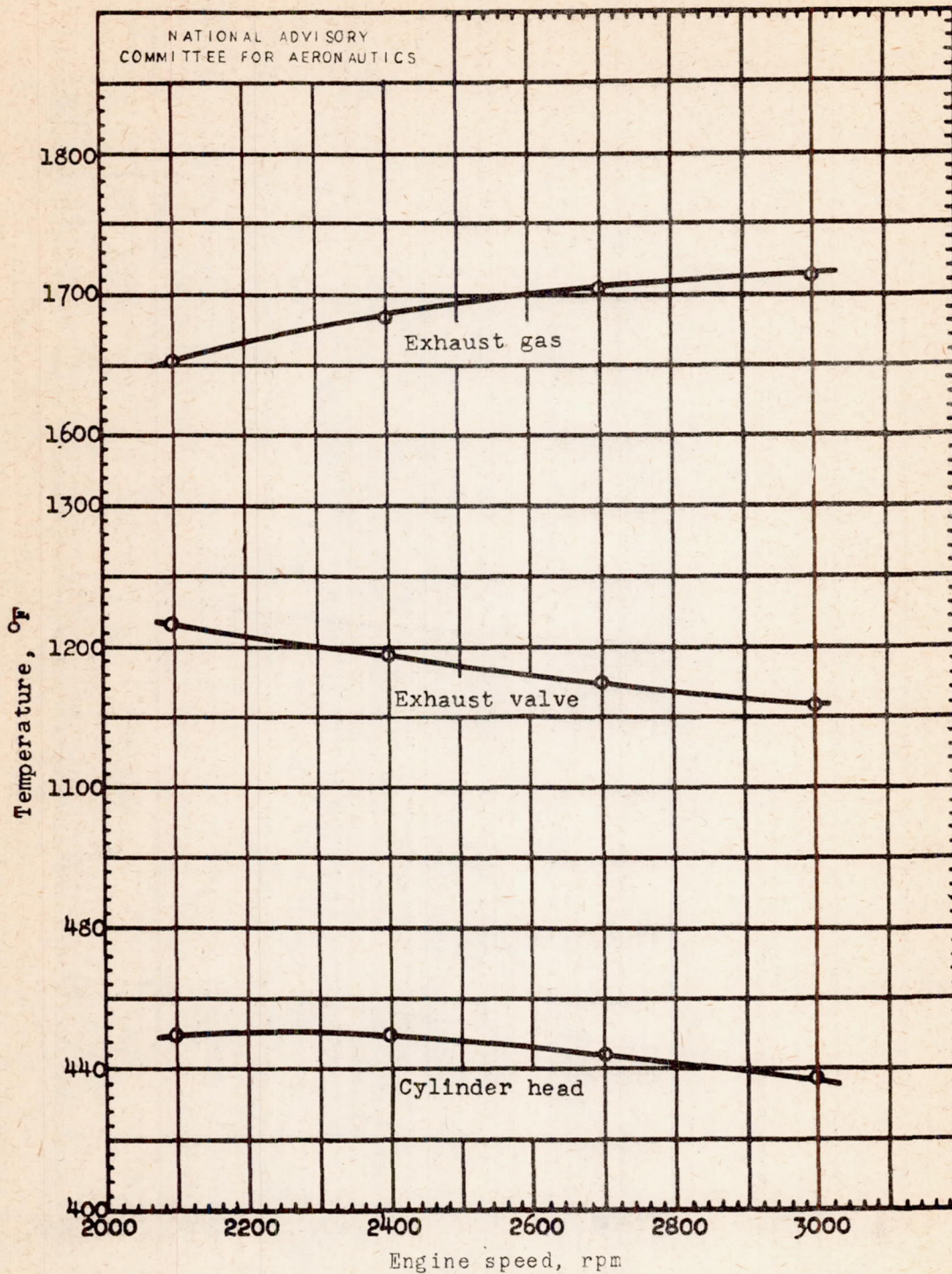

Figure 11. - Effect of engine speed on temperatures of exhaust valve, exhaust gas, and cylinder head at constant power output of 93.5 indicated horsepower. Fuel-air ratio, 0.085; spark advance: inlet,  $28^{\circ}$  B.T.C.; exhaust,  $34^{\circ}$  B.T.C.; mixture temperature,  $200^{\circ}$  F; outlet coolant temperature,  $250^{\circ}$  F; coolant flow, 105 gallons per minute; exhaust pressure, 30 inches mercury absolute; compression ratio, 6.65; fuel, 28-R.

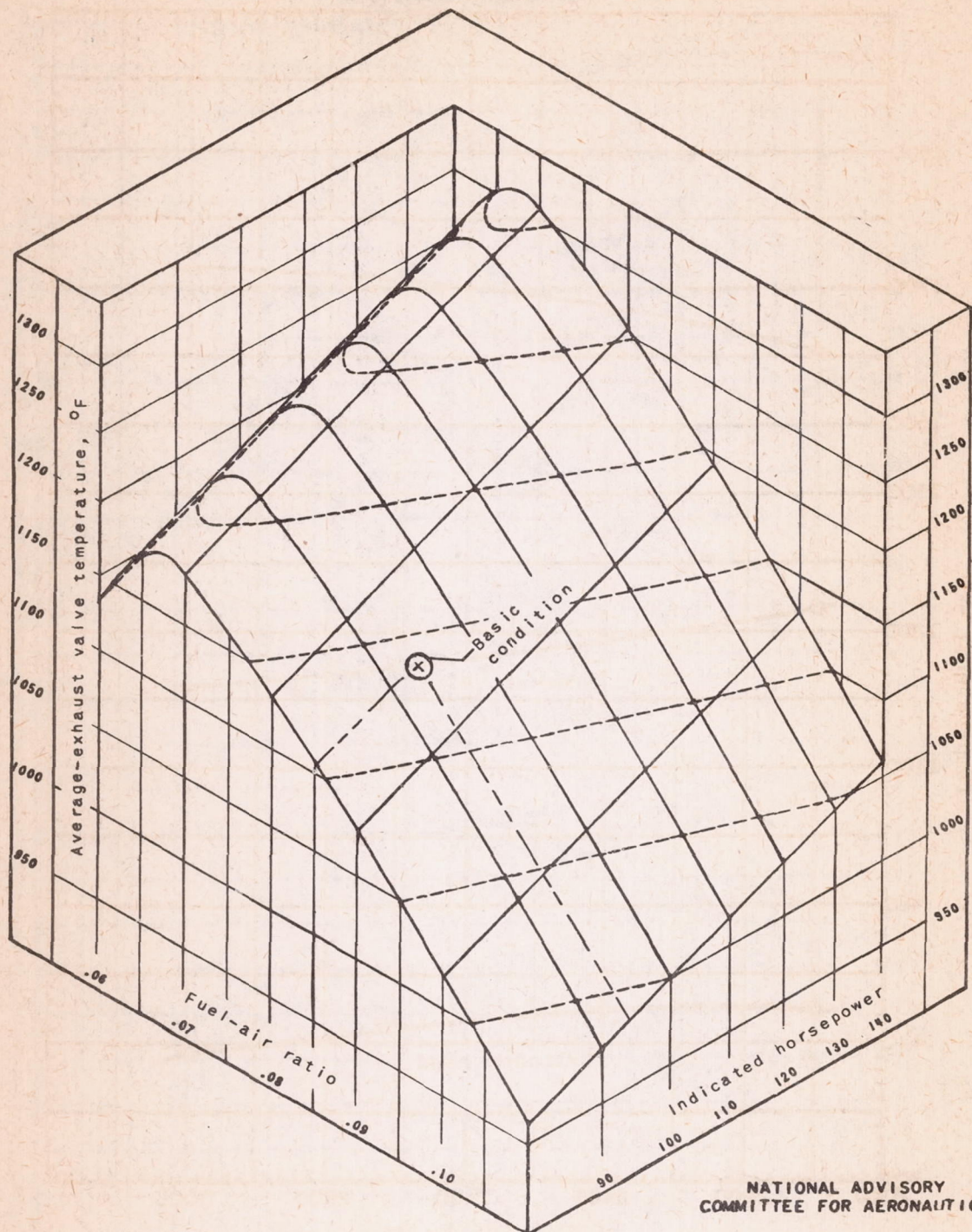

Figure 12. - Three-dimensional plot showing average valve temperature as function of indicated horsepower and fuel-air ratio. Spark advance; inlet,  $28^{\circ}$  B.T.C.; exhaust,  $34^{\circ}$  B.T.C.; mixture temperature,  $200^{\circ}$  F; outlet coolant temperature,  $250^{\circ}$  F; coolant flow, 105 gallons per minute; exhaust pressure, 30 inches mercury absolute; compression ratio, 6.65; fuel, 28-R.



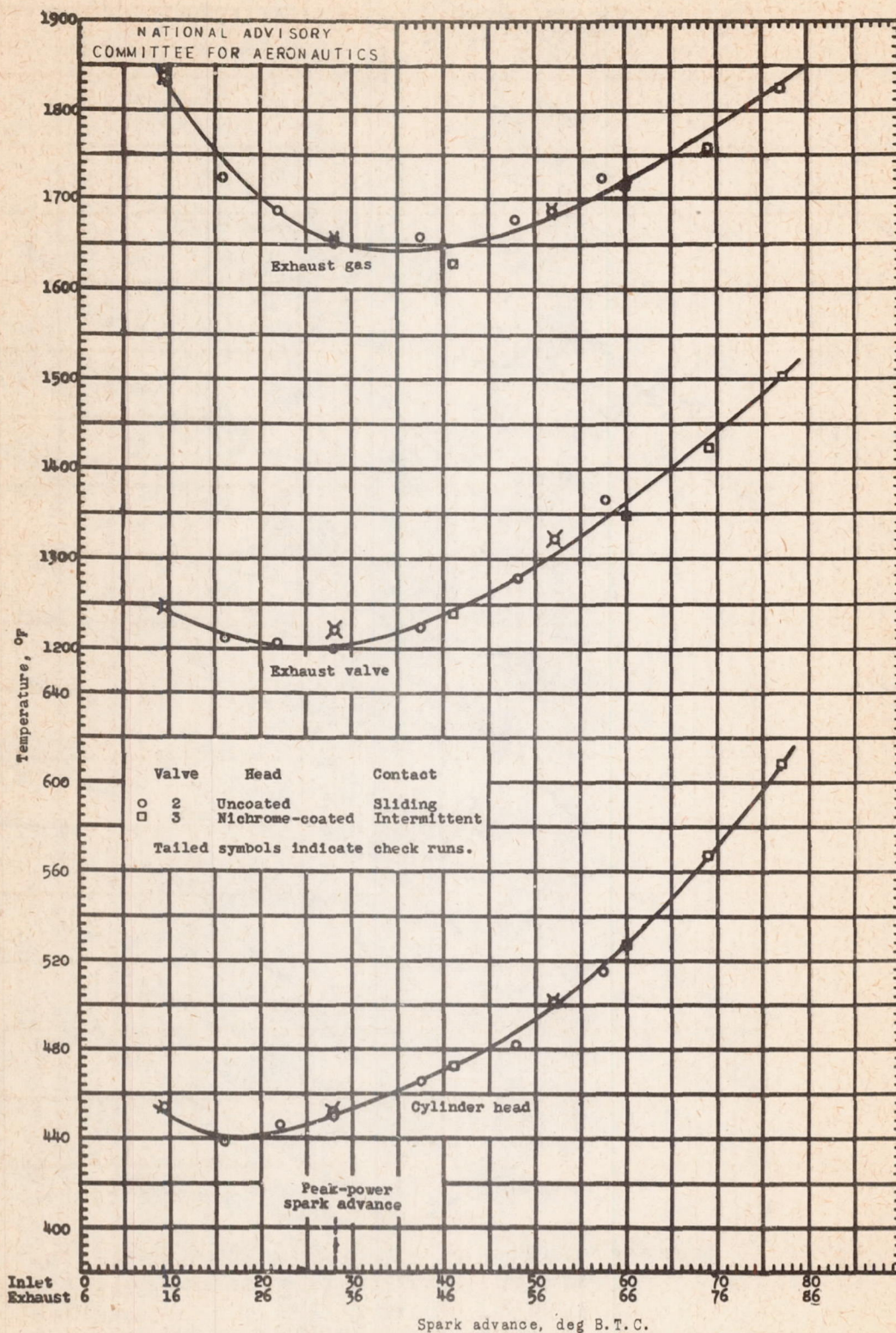

Figure 13. - Effect of spark advance on temperatures of exhaust valve, exhaust gas, and cylinder head at constant indicated power output. Fuel-air ratio, 0.085; indicated mean effective pressure, 200 pounds per square inch; engine speed, 2800 rpm; mixture temperature, 200° F; outlet coolant temperature, 250° F; coolant flow, 105 gallons per minute; exhaust pressure, 30 inches mercury absolute; compression ratio, 6.65; fuel, 28-R.

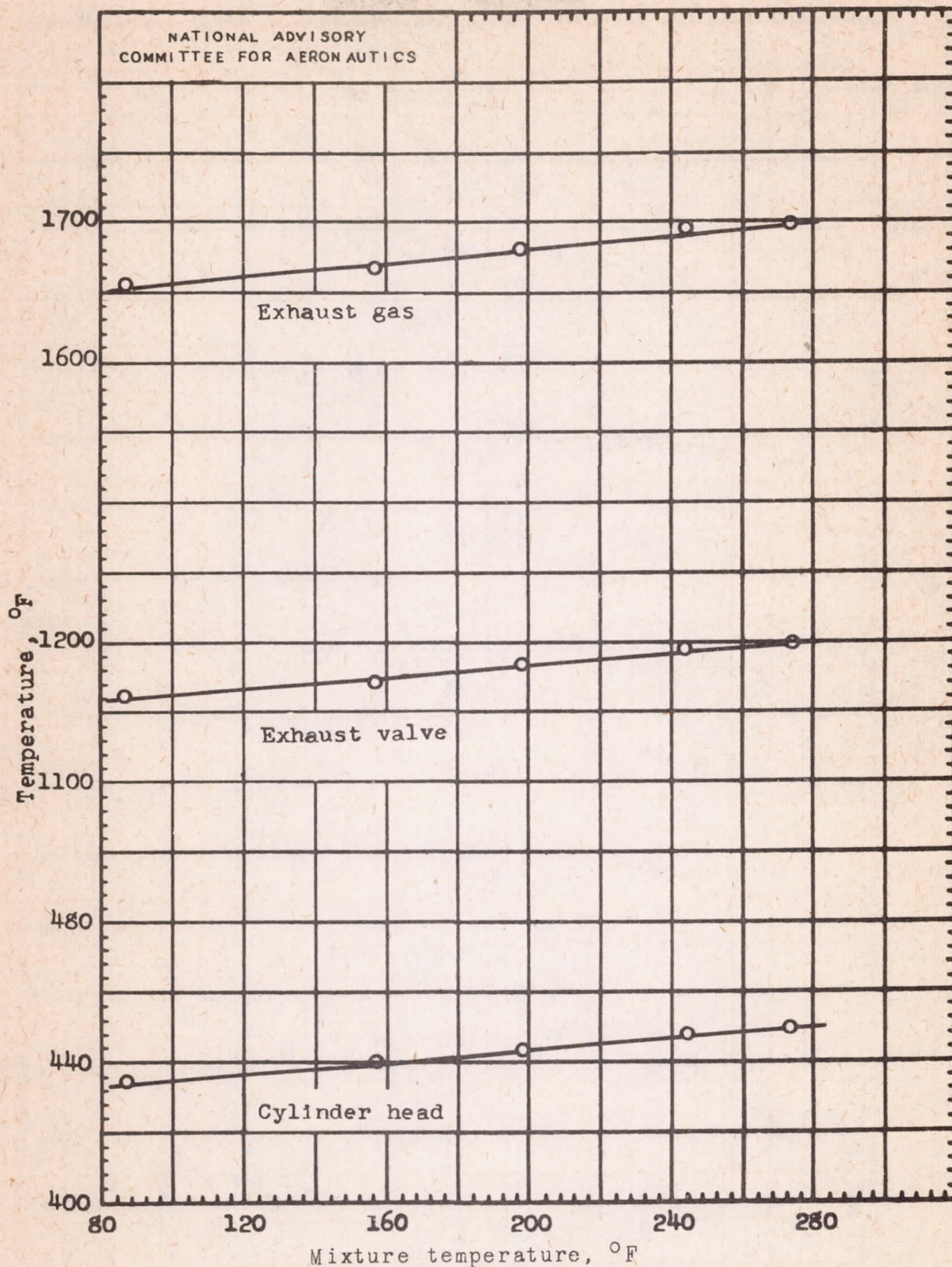

Figure 14. - Effect of mixture temperature on temperatures of exhaust valve, exhaust gas, and cylinder head at constant indicated power output. Fuel-air ratio, 0.085; indicated mean effective pressure, 200 pounds per square inch; engine speed, 2600 rpm; spark advance: inlet, 28° B.T.C.; exhaust, 34° B.T.C.; outlet coolant temperature, 250° F; coolant flow, 105 gallons per minute; exhaust pressure, 30 inches mercury absolute; compression ratio, 6.65; fuel, 28-R.

639

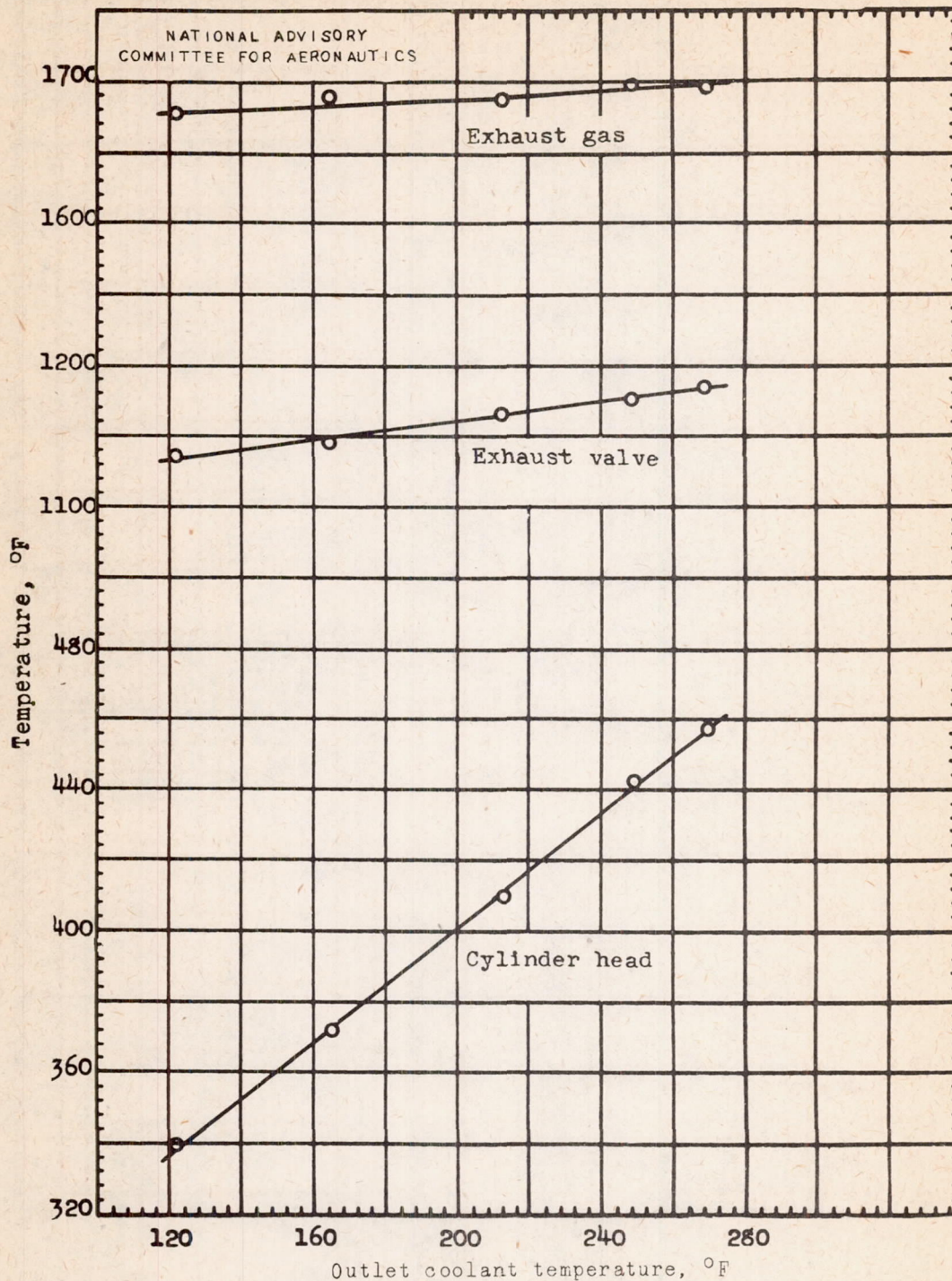

Figure 15. - Effect of outlet coolant temperature on temperatures of exhaust valve, exhaust gas, and cylinder head. Fuel-air ratio, 0.085; indicated mean effective pressure, 200 pounds per square inch; engine speed, 2600 rpm; spark advance: inlet, 28° B.T.C.; exhaust, 34° B.T.C.; mixture temperature, 200° F; coolant flow, 105 gallons per minute; exhaust pressure, 30 inches mercury absolute; compression ratio, 6.65; fuel, 28-R.

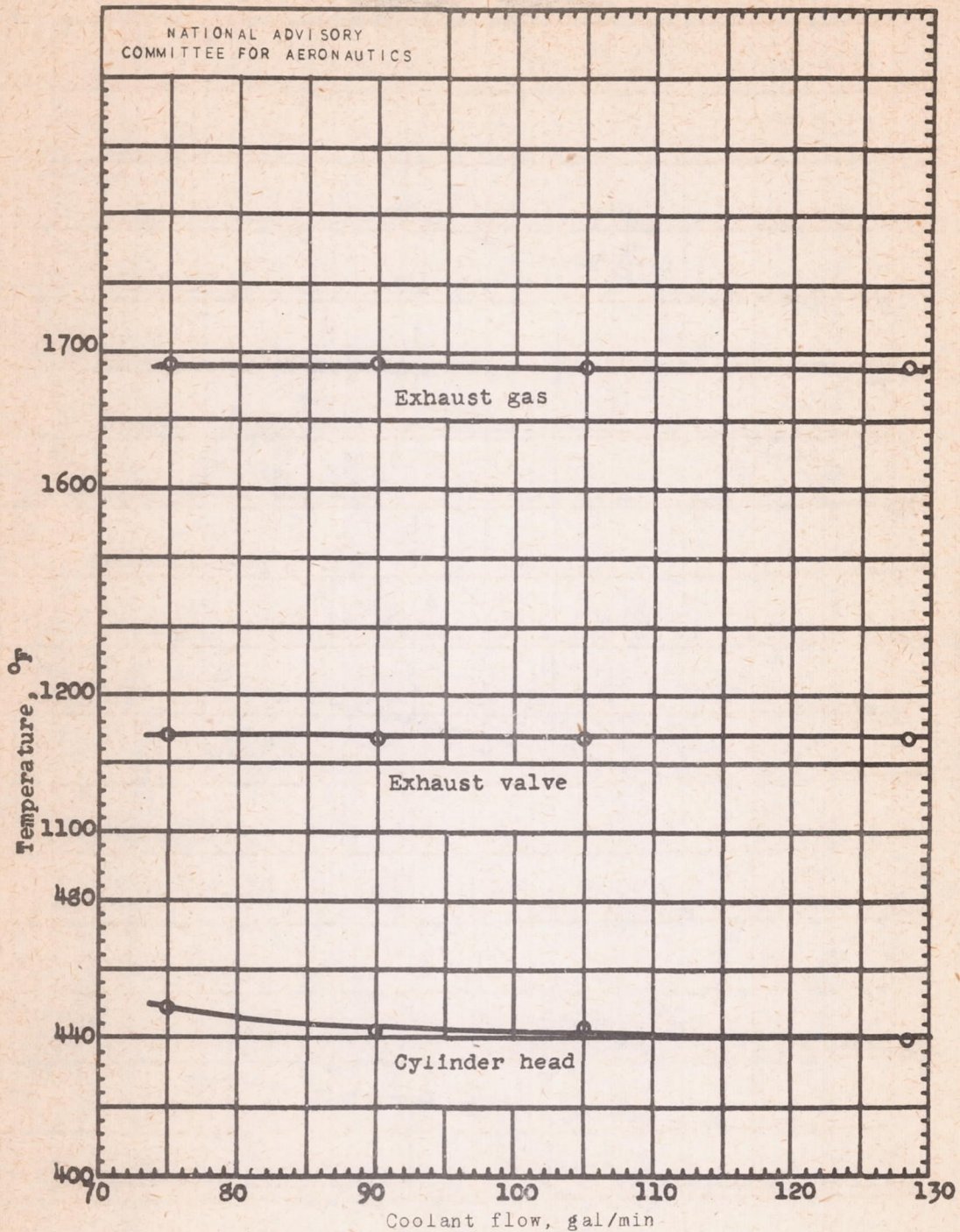

Figure 16. - Effect of coolant-flow rate on temperatures of exhaust valve, exhaust gas, and cylinder head. Fuel-air ratio, 0.085; indicated mean effective pressure, 200 pounds per square inch; engine speed, 2600 rpm; spark advance: inlet, 28° B.T.C.; exhaust, 34° B.T.C.; mixture temperature, 200° F; outlet coolant temperature, 250° F; exhaust pressure, 30 inches mercury absolute; compression ratio, 6.65; fuel, 28-R.

639

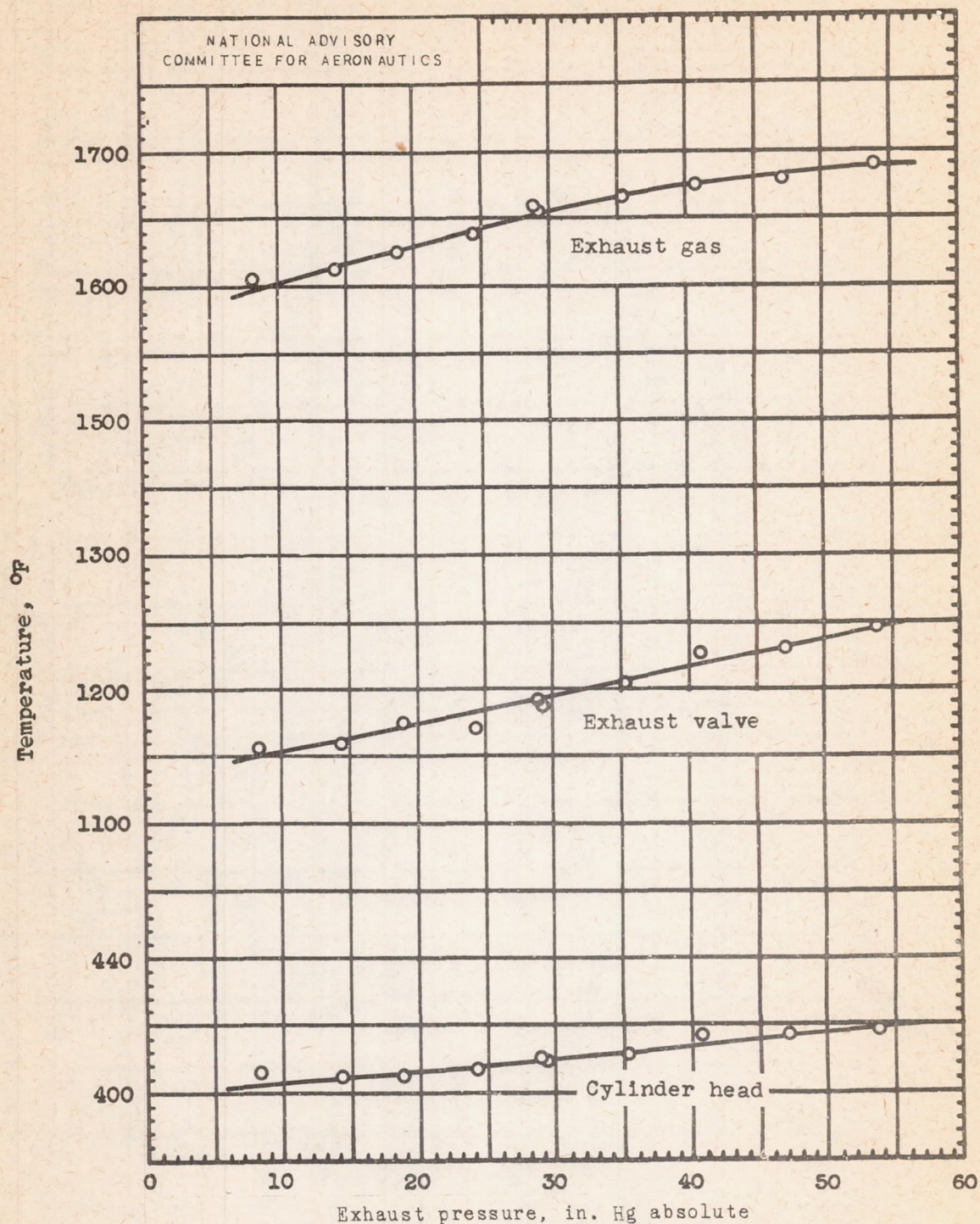

Figure 17. - Effect of exhaust pressure on temperatures of exhaust valve, exhaust gas, and cylinder head at constant indicated power output. Fuel-air ratio, 0.085; indicated mean effective pressure, 200 pounds per square inch; engine speed, 2600 rpm; spark advance: inlet, 23° B.T.C.; exhaust, 34° B.T.C.; mixture temperature, 200° F; outlet coolant temperature, 250° F; coolant flow, 105 gallons per minute; compression ratio, 6.65; fuel, 28-R.

639

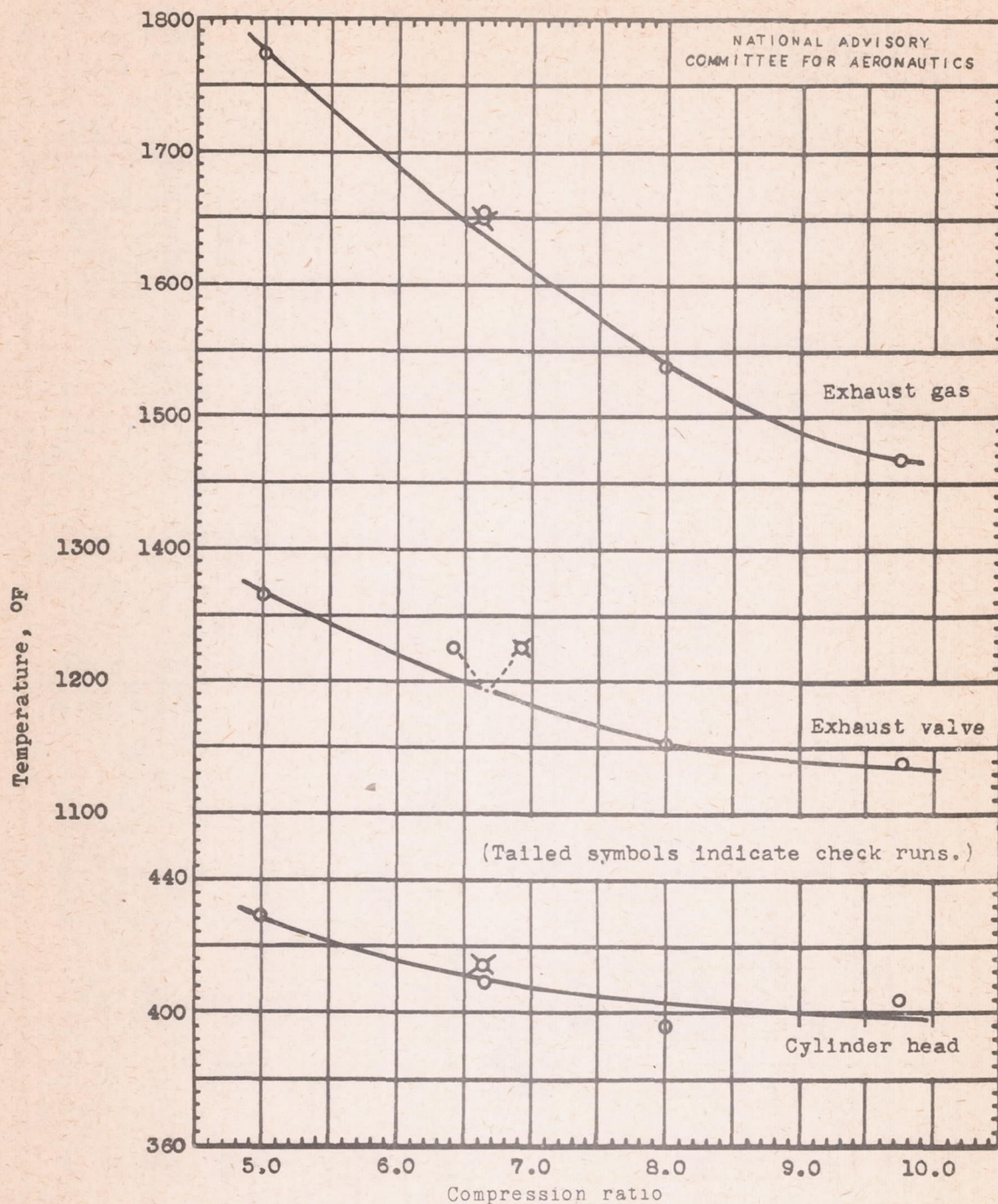

Figure 18. - Effect of compression ratio on temperatures of exhaust valve, exhaust gas, and cylinder head at constant indicated power output. Fuel-air ratio, 0.085; indicated mean effective pressure, 200 pounds per square inch; engine speed, 2600 rpm; spark advance: inlet, 28° B.T.C.; exhaust, 34° B.T.C.; mixture temperature, 200° F; outlet coolant temperature, 250° F; coolant flow, 105 gallons per minute; exhaust pressure, 30 inches mercury absolute; fuel, 90 percent triptane and 10 percent benzene, plus 3.6 ml TEL/gal.

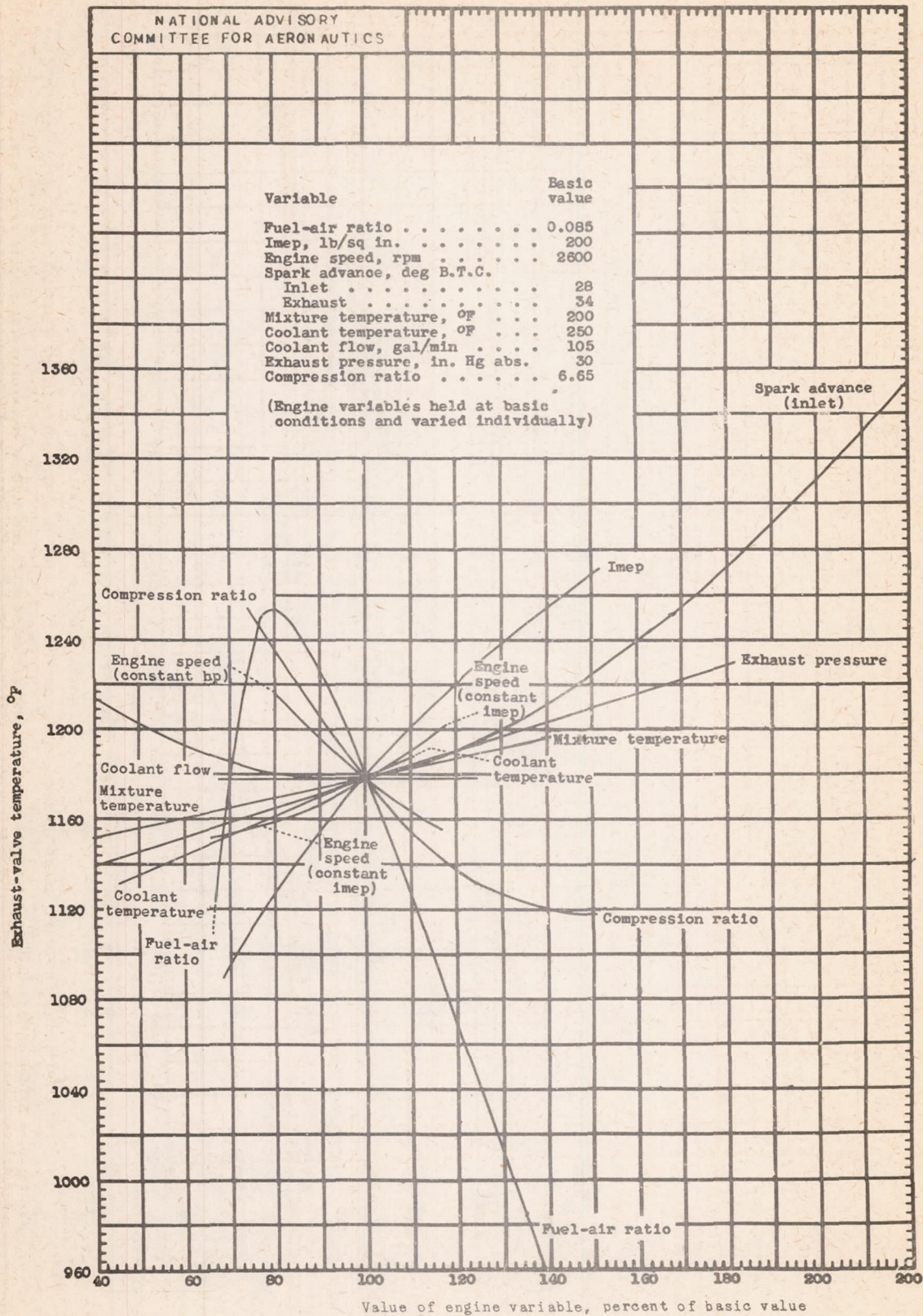

Figure 19. - Comparison of effects of engine variables on exhaust-valve temperature.

639

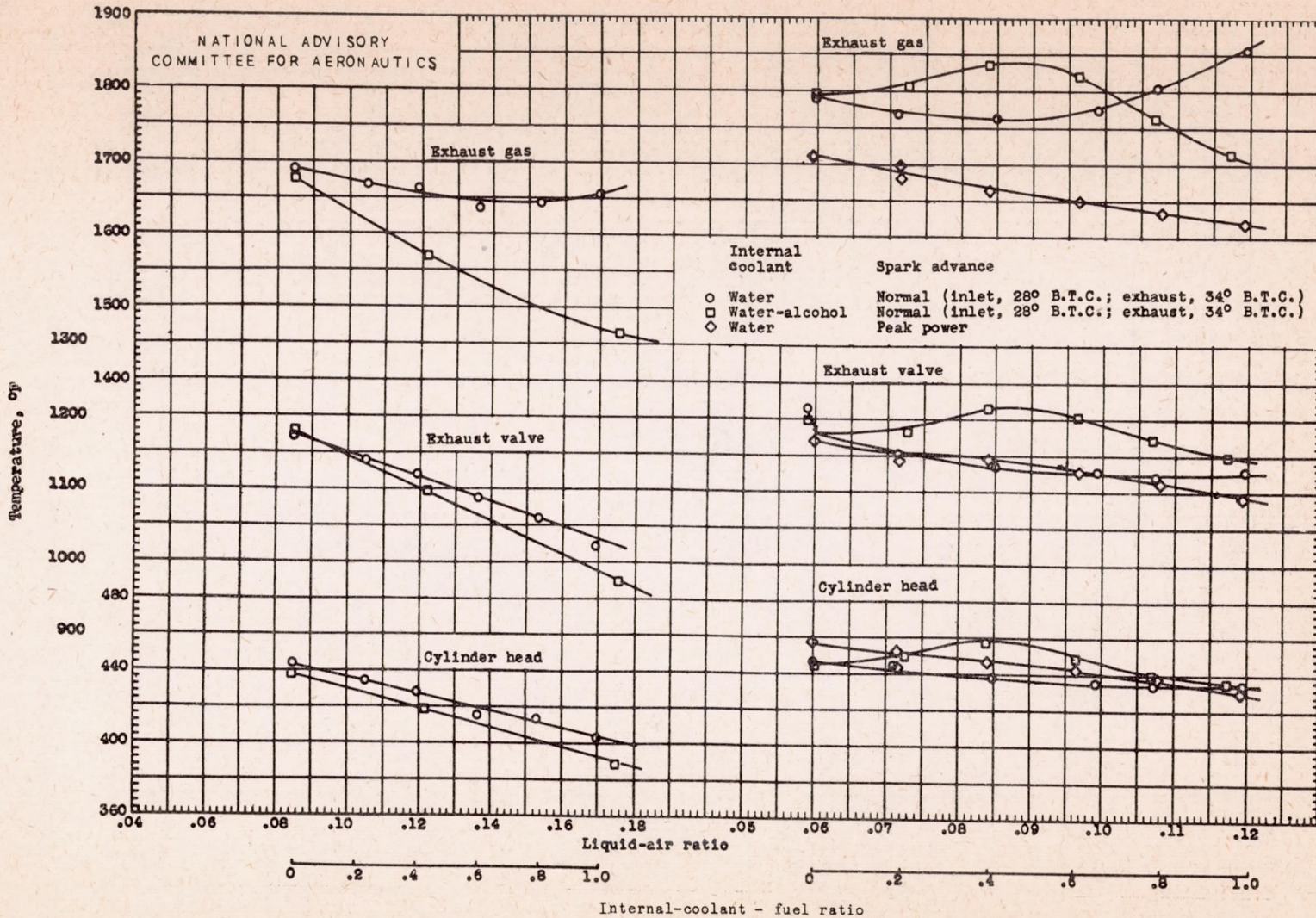
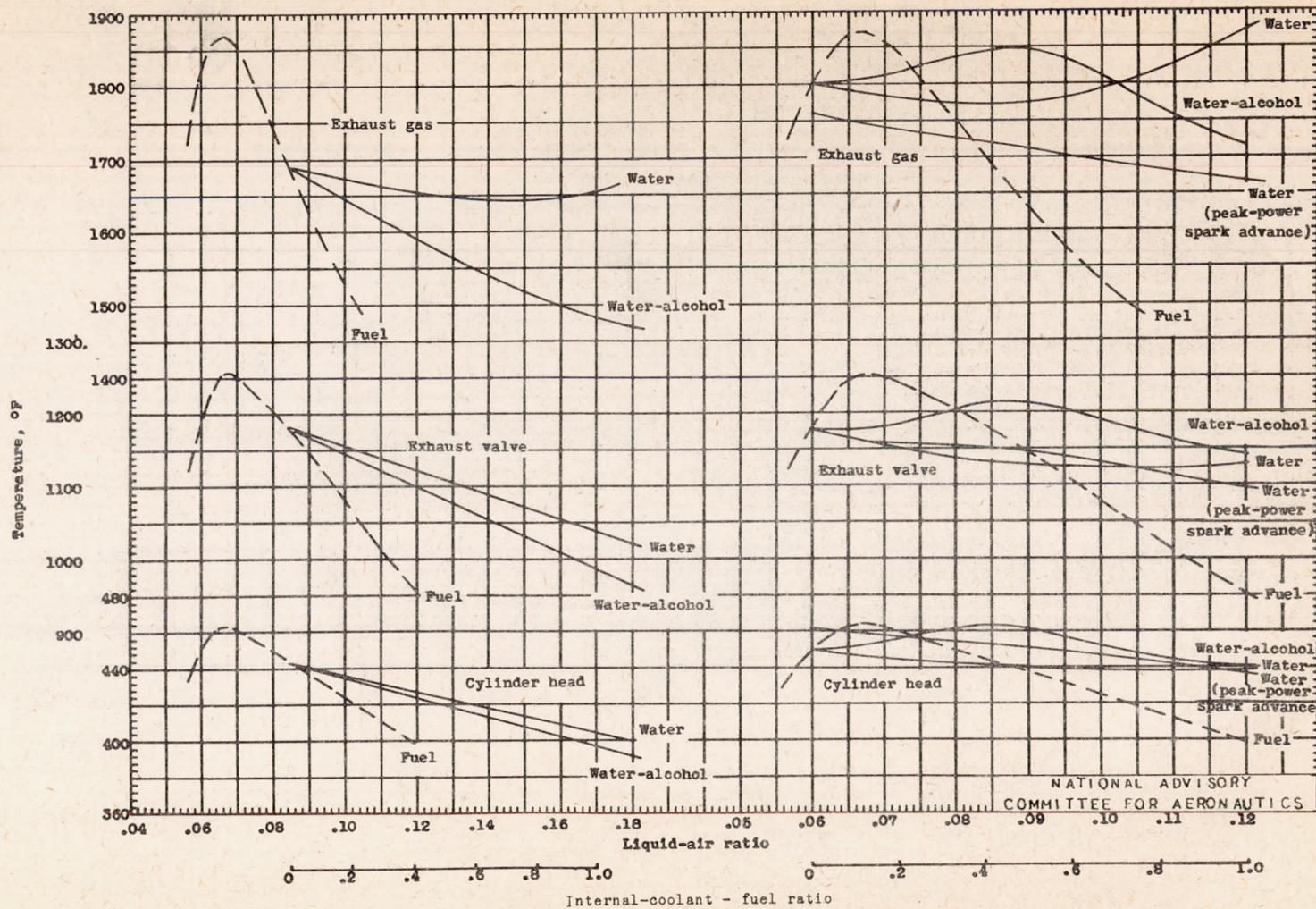

Figure 20. - Effect of internal-coolant injection at fuel-air ratios of 0.085 and 0.06 on temperatures of exhaust valve, exhaust gas, and cylinder head at constant indicated power output. Indicated mean effective pressure, 200 pounds per square inch; engine speed, 2800 rpm; outlet coolant temperature, 250° F; coolant flow, 105 gallons per minute; exhaust pressure, 30 inches mercury absolute; compression ratio, 8.65; fuel, 28-R.





(a) Fuel-air ratio, 0.085; inlet-air temperature, 260° F.

(b) Fuel-air ratio, 0.06; inlet-air temperature, 240° F.

Figure 21. - Comparison of effects of internal-coolant injection and fuel enrichment at basic fuel-air ratios of 0.085 and 0.06 on temperatures of exhaust valve, exhaust gas, and cylinder head at constant indicated power output. Indicated mean effective pressure, 200 pounds per square inch; engine speed, 2800 rpm; spark advance (for all tests except water injection at peak-power spark advance): inlet, 28° B.T.C.; exhaust, 34° B.T.C.; outlet coolant temperature, 250° F; coolant flow, 105 gallons per minute; exhaust pressure, 30 inches mercury absolute; compression ratio, 6.65; fuel, 28-R.

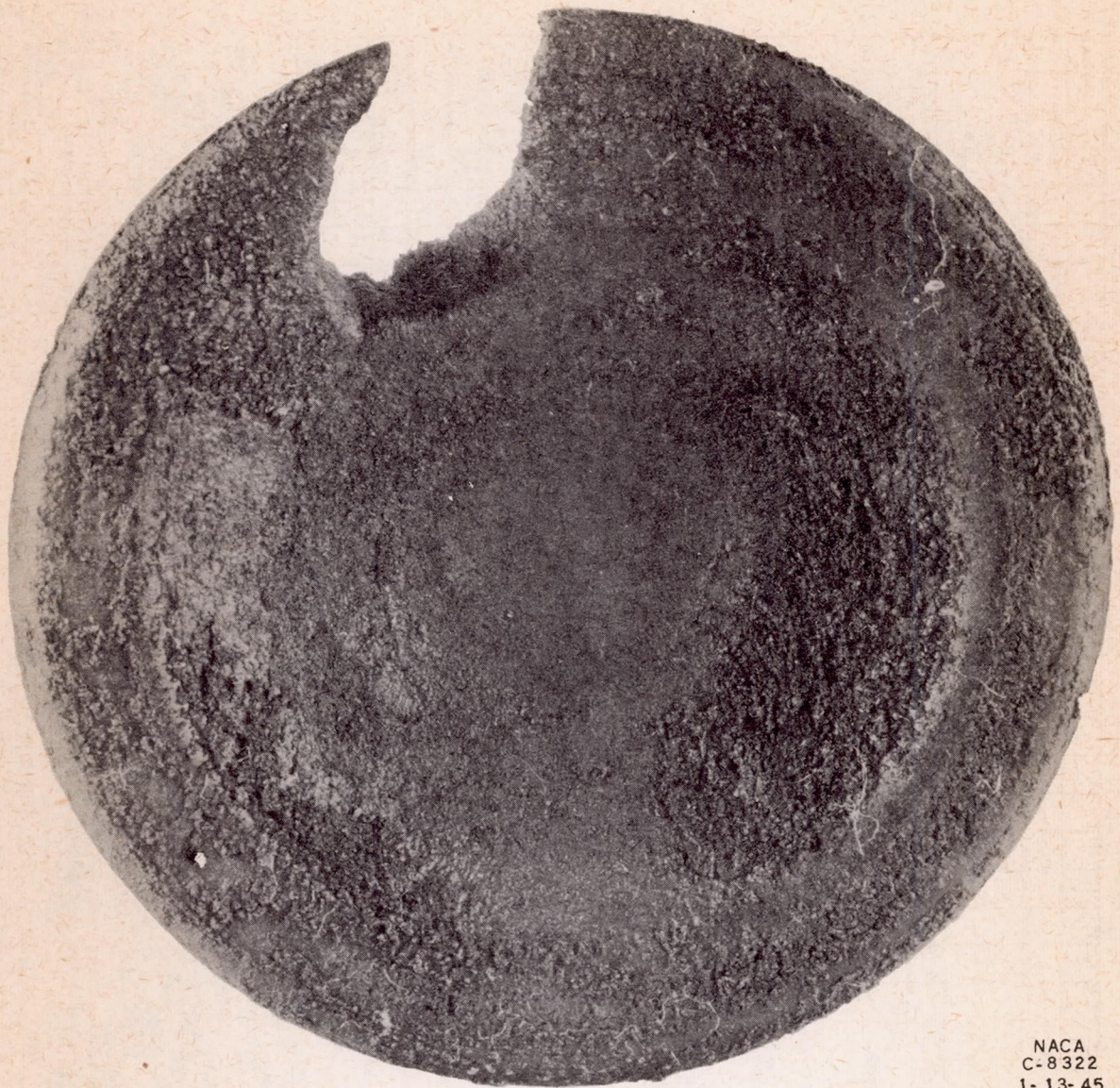

NACA  
C-8322  
1-13-45

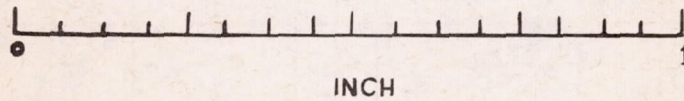

Figure 22. - Head of valve 2 (uncoated) after failure due to preignition.