

AERONAUTICS

FIRST ANNUAL REPORT
OF THE
NATIONAL ADVISORY COMMITTEE
FOR AERONAUTICS

1915



NACA LIBRARY
AMES AERONAUTICAL LABORATORY
Moffett Field, Calif.

WASHINGTON
GOVERNMENT PRINTING OFFICE

1916

SUBMITTED BY MR. LODGE.

IN THE SENATE OF THE UNITED STATES,
January 31, 1916.

Resolved, That the report of the National Advisory Committee for Aeronautics, transmitted with the President's message of December fifteenth, nineteen hundred and fifteen, be printed as a Senate document, together with the accompanying appendices and illustrations.

Attest:

JAMES M. BAKER,
Secretary.

CONTENTS.

	Page.
Letter of submittal	7
Report of committee	9
Appointment of committee	9
Rules and regulations	10
Organization of committee	11
Work of the committee	12
Problems	13
A. Stability as determined by mathematical investigation	13
B. Air speed meters	14
C. Wing sections	14
D. Motors	15
E. Propellers	15
F. Form of aeroplane	15
G. Radio telegraphy	15
Physical problems	16
A. Noncorrosive materials	16
B. Flat and cambered surfaces	16
C. Terminal connections	16
D. Characteristics of constructive materials	16
E. Generation of hydrogen	16
F. Standardization of nomenclature	16
G. Standardization of specifications	16
H. Bibliography of aviation	16
I. Collection and revision of reports	16
J. Limitation of size	17
K. Causes of accidents	17
Standards of work	17
Importance of work to Army and Navy	18
Quarters for committee	18
Existing facilities for aeronautic investigation in Government departments	18
A. Bureau of Standards	18
B. Navy Department	18
C. War Department	19
D. Weather Bureau	19
E. Smithsonian Institution	19
Itemized statement of expenditures	19
Summary of expenditures	20
Conclusions	20

REPORTS.

No. 1. Report on behavior of aeroplanes in gusts, by the Massachusetts Institute of Technology	23
No. 2. Report on investigation of Pitot tubes, by the United States Bureau of Standards	76
No. 3. Report on investigations of aviation wires and cables, their fastenings and connections, by John A. Roebling's Sons Co.	111
No. 4. Preliminary report on the problem of the atmosphere in relation to aeronautics, by Prof. Charles F. Marvin	127
No. 5. Report on relative worth of improvements on fabrics, by Goodyear Tire & Rubber Co.	131
No. 6. Report on investigation of balloon and aeroplane fabrics, by the United States Rubber Co.	137
No. 7. Report on thermodynamic efficiency of present types of internal-combustion engines for aircraft, by Columbia University	185

NATIONAL ADVISORY COMMITTEE FOR AERONAUTICS.

Brig. Gen. GEORGE P. SCRIVEN, United States Army, *Chairman.*
Naval Constructor H. C. RICHARDSON, United States Navy, *Secretary.*

Prof. JOSEPH S. AMES.	Hon. BYRON R. NEWTON.
Capt. M. L. BRISTOL, United States Navy.	Prof. MICHAEL I. PUPIN.
Prof. WILLIAM F. DURAND.	Lieut. Col. SAMUEL REBER, United States Army.
Prof. JOHN F. HAYFORD.	Dr. S. W. STRATTON.
Prof. CHARLES F. MARVIN.	Dr. CHARLES D. WALCOTT.

LETTER OF SUBMITTAL.

NATIONAL ADVISORY COMMITTEE FOR AERONAUTICS,
STATE, WAR, AND NAVY BUILDING,
Washington, D. C., December 9, 1915.

The PRESIDENT:

In compliance with the provisions of the act of Congress approved March 3, 1915 (naval appropriation act, Public, No. 273, 63d Cong.), the National Advisory Committee for Aeronautics has the honor to submit herewith its annual report for the period from March 3, 1915, to June 30, 1915, including certain recommendations for future work and a statement of expenditures to June 30, 1915.

The committee was appointed by the President on April 2, 1915, and held its first meeting for organization on April 23, 1915. On June 14 the President approved rules and regulations which had been formulated by the committee for the conduct of its operations.

By the act establishing the committee an appropriation of \$5,000 a year for five years was made immediately available. Of the appropriation for the first year, ending June 30, 1915, there was expended a total of \$3,938.94, as shown by the itemized statement in the accompanying report, and the unobligated balance of \$1,061.06 was covered into the Treasury as required by law.

In order to carry out its purposes and objects, as defined in the act of March 3, 1915, the committee submits herewith certain recommendations and an estimate of expenses for the fiscal year ending June 30, 1917. The estimates in detail were submitted through the Secretary of the Navy.

Attention is invited to the appendixes of the committee's report, and it is requested that they be published with the report of the committee as a public document.

It is apparent to the committee that there is a large amount of important work to be done to place aeronautics on a satisfactory foundation in this country. Competent engineers and limited facilities are already available and can be employed by the committee to advantage, provided sufficient funds be placed at its disposal, as estimated for the fiscal year 1917.

What has been already accomplished by the committee has shown that although its members have devoted as much personal attention as practicable to its operations, yet in order to do all that should be done technical assistance should be provided which can be continuously employed. There are many practical problems in aeronautics now in too indefinite a form to enable their solution to be undertaken. The committee is of the opinion that one of the first and most important steps to be taken in connection with the committee's work is the provision and equipment of a flying field together with aeroplanes and suitable testing gear for determining the forces acting on full-

sized machines in constrained and in free flight, and to this end the estimates submitted contemplate the development of such a technical and operating staff, with the proper equipment for the conduct of full-sized experiments.

It is evident that there will ultimately be required a well-equipped laboratory specially suited to the solving of those problems which are sure to develop, but since the equipment of such a laboratory as could be laid down at this time might well prove unsuited to the needs of the early future, it is believed that such provision should be the result of gradual development.

The investigations which the committee proposes in its program for the coming year can only be carried out to a satisfactory degree, with the limited facilities already existing, provided sufficient funds are made available. The estimates of the committee are based on such line of action, and on the assumption that a flying field can be placed at its disposal on Government land. If, however, such facilities be not practicable at this time, some progress may still be made by the utilization of the facilities of the Government aeronautic stations at Pensacola and San Diego.

The estimate of expenses for the fiscal year ending June 30, 1917, is as follows:

For carrying into effect the provisions of the act approved March third, nineteen hundred and fifteen, establishing a national advisory committee for aeronautics, there is hereby appropriated, out of any money in the Treasury not otherwise appropriated, for experimental work and investigations undertaken by the committee, including technical and clerical assistants and the necessary unskilled labor, equipment, supplies, office rent, and the necessary traveling expenses of the members and employees of the committee, personal services in the field, and in the District of Columbia: *Provided*, That an annual report to the Congress shall be submitted through the President, including an itemized statement of expenditures, \$85,000.

The committee, therefore, submits its report, recommendations, and estimates to your favorable consideration.

Very respectfully,

GEORGE P. SCRIVEN,
Brigadier General, Chief Signal Officer of the Army,
Chairman.

ANNUAL REPORT OF THE NATIONAL ADVISORY COMMITTEE FOR AERONAUTICS.

NATIONAL ADVISORY COMMITTEE FOR AERONAUTICS,
STATE, WAR, AND NAVY BUILDING,
Washington, D. C., December 9, 1915.

To the Congress:

The members of the National Advisory Committee for Aeronautics were appointed by the President on April 2, 1915, in pursuance of the following provision in the naval appropriation act (Public, No. 271, 63d Cong.), approved March 3, 1915:

An Advisory Committee for Aeronautics is hereby established, and the President is authorized to appoint not to exceed twelve members, to consist of two members from the War Department, from the office in charge of military aeronautics; two members from the Navy Department, from the office in charge of naval aeronautics; a representative each of the Smithsonian Institution, of the United States Weather Bureau, and of the United States Bureau of Standards; together with not more than five additional persons who shall be acquainted with the needs of aeronautical science, either civil or military, or skilled in aeronautical engineering or its allied sciences: *Provided*, That the members of the Advisory Committee for Aeronautics, as such, shall serve without compensation: *Provided further*, That it shall be the duty of the Advisory Committee for Aeronautics to supervise and direct the scientific study of the problems of flight, with a view to their practical solution, and to determine the problems which should be experimentally attacked, and to discuss their solution and their application to practical questions. In the event of a laboratory or laboratories, either in whole or in part, being placed under the direction of the committee, the committee may direct and conduct research and experiment in aeronautics in such laboratory or laboratories: *And provided further*, That rules and regulations for the conduct of the work of the committee shall be formulated by the committee and approved by the President.

That the sum of \$5,000 a year, or so much thereof as may be necessary, for five years is hereby appropriated, out of any money in the Treasury not otherwise appropriated, to be immediately available, for experimental work and investigations undertaken by the committee, clerical expenses and supplies, and necessary expenses of members of the committee in going to, returning from, and while attending meetings of the committee: *Provided*, That an annual report to the Congress shall be submitted through the President, including an itemized statement of expenditures.

APPOINTMENT OF COMMITTEE.

Under the authority of the statute the President appointed the following members of the committee:

Prof. Joseph S. Ames,
Johns Hopkins University, Baltimore, Md.
Capt. Mark L. Bristol, United States Navy,
Director of Naval Aeronautics, Navy Department.
Prof. William F. Durand,
Leland Stanford Junior University, Stanford University,
Cal.

Prof. John F. Hayford,
Northwestern University, Evanston, Ill.
Prof. Charles F. Marvin,
Chief, United States Weather Bureau.
Hon. Byron R. Newton,
Assistant Secretary of the Treasury, Treasury Department.
Prof. Michael I. Pupin,
Columbia University, New York, N. Y.
Lieut. Col. Samuel Reber, United States Army,
Officer in Charge Aviation Section, War Department.
Naval Constructor Holden C. Richardson, United States Navy,
Navy Department.
Brig. Gen. George P. Scriven, United States Army,
Chief Signal Officer, War Department.
Dr. S. W. Stratton,
Director, United States Bureau of Standards.
Dr. Charles D. Walcott,
Secretary, Smithsonian Institution.

RULES AND REGULATIONS.

The approved rules and regulations for the conduct of the work of the National Advisory Committee for Aeronautics, as approved by the President on June 14, 1915, are as follows:

RULES.

1. The committee may exercise all the functions authorized in the act establishing an advisory committee for aeronautics.
2. The committee, under regulations to be established and fees to be fixed, shall exercise its functions for the military and civil departments of the Government of the United States, and also for any individual, firm, association, or corporation within the United States: *Provided, however,* That such department, individual, firm, association, or corporation shall defray the actual cost involved.
3. No funds shall be expended for the development of inventions, or for experimenting with inventions for the benefit of individuals or corporations.

REGULATIONS FOR CONDUCT OF COMMITTEE.

ARTICLE I.

MEETINGS.

1. The annual meeting of the advisory committee shall be held in the city of Washington, in the District of Columbia, on the Thursday after the third Monday of October of each year. A semiannual meeting of the advisory committee shall be held on the Thursday after the third Monday in April of each year, at the same place.
2. Special meetings of the advisory committee may be called by the executive committee, by notice served personally upon or by mail or telegraph to the usual address of each member at least five days prior to the meeting.
3. Special meetings shall, moreover, be called in the same manner by the chairman, upon the written request of five members of the advisory committee.
4. If practicable, the object of a special meeting should be sent in writing to all members, and if possible a special meeting should be avoided by obtaining the views of members by mail or otherwise, both on the question requiring the meeting and on the question of calling a special meeting.
5. Immediately after each meeting of the advisory committee a draft of the minutes shall be sent to each member for approval.
6. There shall be monthly meetings of the executive committee.

ARTICLE II.

OFFICERS.

1. The officers of the advisory committee shall be a chairman and a secretary, who shall be elected by the committee by ballot, to serve for one year.
2. The chairman shall preside at all meetings of the committee and shall have the usual powers of a presiding officer.
3. The secretary shall issue notices of meetings of the committee, record its transactions, and conduct the correspondence relating to the committee and to the duties of his office.

ARTICLE III.

COMMITTEES.

1. There shall be an executive committee which shall consist of seven members, to be elected by the advisory committee by ballot from its membership, for one year. Any member elected to fill a vacancy shall serve for the remainder of his predecessor's term. The executive committee shall elect its chairman.
2. The executive committee in accordance with the general instructions of the advisory committee, shall control the administration of the affairs of the committee, and shall have general supervision of all arrangements for research, and other matters undertaken or promoted by the advisory committee; and shall keep a written record of all transactions and expenditures, and submit the same to the advisory committee at each stated meeting; and it shall also submit to the advisory committee, at the annual meeting, a report for transmission to the President.
3. The executive committee is authorized to collect aeronautical information, and such portion thereof as may be appropriate may be issued as bulletins or in other forms.
4. There may be subcommittees appointed by the executive committee, the chairmen of which shall be members of the advisory committee, and the other members of which may or may not be members of the advisory committee.
5. All officers and all members of committees hold office until their successors are elected or appointed.

ARTICLE IV.

FINANCES.

1. No expenditures shall be authorized or made except in pursuance of a previous appropriation by the advisory committee, or by authority granted by the advisory committee to the executive committee.
2. The fiscal year of the committee shall commence on the 1st day of July of each year.
3. The executive committee shall provide for an annual audit of the accounts of the advisory committee, and shall submit to the annual meeting of the advisory committee a full statement of the finances and work of the committee, and a detailed estimate of the proposed expenditures for the succeeding fiscal year.
4. The Paymaster General of the Navy shall be the disbursing officer for such funds as may be appropriated for the use of the advisory committee. The chairman of the advisory committee, or the chairman of the executive committee, if authorized by the advisory committee, shall approve all accounts for the disbursement of funds.
5. Contributions of funds or collections for any purpose for aeronautics may be made to the Smithsonian Institution, and disbursements therefrom shall be made by the said institution.

ARTICLE V.

AMENDMENTS.

1. Amendments to these rules and regulations may be made at any stated meeting by a two-thirds vote of the advisory committee, subject to approval by the President.

ORGANIZATION OF COMMITTEE.

Pursuant to a call of the Secretary of War, by direction of the President, the members of the Advisory Committee for Aeronautics met in the office of the Secretary of War on April 23, 1915. The first meeting was called to order by the Secretary of War, and a temporary

organization was effected. Brig. Gen. George P. Scriven, United States Army, was elected temporary chairman, and Naval Constructor Holden C. Richardson, United States Navy, temporary secretary.

In conformity with the designation in the call for the first meeting, issued by the Secretary of War, the word "National" was prefixed to the terms "Advisory Committee for Aeronautics."

Under the authority of the rules and regulations the organization was completed by the election of officers for one year as follows:

Brig. Gen. George P. Scriven, United States Army, chairman.
Naval Constructor Holden C. Richardson, United States Navy, secretary.

OFFICERS AND MEMBERS OF EXECUTIVE COMMITTEE.

OFFICERS.

Dr. Charles D. Walcott, chairman.
Naval Constructor H. C. Richardson, secretary.

MEMBERS.

Prof. Joseph S. Ames.	Prof. Michael I. Pupin.
Capt. Mark L. Bristol, United States Navy.	Lieut. Col. S. Reber, United States Army.
Prof. Charles F. Marvin.	Dr. S. W. Stratton.

WORK OF THE COMMITTEE.

The executive committee was directed to consider a program of investigation and procedure intended to carry into effect the purposes of the act creating the advisory committee, and to report the same with recommendations. The recommendations and the report of the executive committee were approved by the general committee at the annual meeting, and are incorporated in this report.

The authority of the advisory committee was given to the executive committee to institute special investigations that promised to be of service to aviation. The results are shown in the reports forwarded herewith as appendices. The limited time and the limited funds available both combined to prevent the accomplishment of additional work of importance, which might otherwise have been undertaken.

The executive committee instituted an investigation of facilities available in various colleges, technical and engineering institutions, and among manufacturers and various aeronautic societies, for the carrying on of aeronautic investigations. It was found that limited facilities were available for attacking various problems of aeronautic design, and that same could be made available to the committee, provided funds were available to carry out the necessary experiments, or to engage competent engineers on different phases of the work. A number of institutions have available mechanical laboratories and engineering courses capable of application to aeronautics, but only the Massachusetts Institute of Technology and the University of Michigan so far offer regular courses of instruction and experimentation. Worcester Polytechnic Institute has conducted experiments on full-sized propellers mounted on a whirling table turning on a pivot in the middle of a pond. The arms of the whirling table are provided at one end with a dynamometer for measuring the torque and thrust and revolutions of the propeller, and at the center a control stand for controlling the speed of the propeller. The speed

of the rotating arm is controlled by means of a drag in the water, attached to the opposite end of the rotating arm. While there are objections to this method of testing in a circular path in the open, the method is ingenious and the results obtained should be valuable, particularly for comparison. In general, however, it appears that the interest of colleges is more one of curiosity than that of considering the problem as a true engineering one, requiring development of engineering resources and, therefore, as not yet of sufficient importance to engage their serious attention. Manufacturers are principally interested in the development of types which will meet Government requirements or popular demand, but which will not involve too radical or sudden changes from their assumed standard types.

As a result of the investigations of the facilities available in this country, and of the problems requiring solution, it is found that many problems exist requiring careful and thorough investigation, which could be attacked with facilities which can be placed at the disposal of the committee, provided sufficient funds are made available. Considerable work has already been accomplished in aeronautics with which the general public is not acquainted. This covers lines of development and investigation which if published would save money and effort on the part of individual investigators and inventors who are now duplicating investigations already made by others. Some of these investigations have resulted in improvement; others have shown the futility of development on certain lines. Some of this information is already embodied in reports which are only accessible to a few interested parties who know of its existence. Much can be accomplished by making the results of such investigations accessible, either in a reference library or in the form of reports.

PROBLEMS.

Of the many problems now engaging general attention, the following are considered of immediate importance and will be considered by the committee as rapidly as funds can be secured for the purpose:

A. *Stability as determined by mathematical investigations.*—The reduction to practical form of the analytical methods of determining the stability of aeroplanes from design data, without necessarily requiring wind-tunnel tests or full-sized tests of same.

(a-1) This will require first a thorough investigation by competent mathematicians and physicists of the work so far accomplished by different authorities of prominence in this country and abroad. The publication of many valuable treatises which have already been prepared is not sufficient, as many of these treatises are presented in such highly technical manner that they are not in form to be comprehended by designers and manufacturers who are otherwise fitted for practical accomplishments in aeronautical work.

(a-2) Another phase of these investigations is the natural tendency on the part of designers and constructors to assume that mathematical theories are of use only to those who are mathematically inclined; and there is objection, frequently based on good ground, that in order to arrive at solutions of the complicated equations involved, mathematicians necessarily make certain assumptions which are not always based on actual conditions, and though the

conclusions drawn are logical, based on the assumptions made, there is reasonable doubt if the resulting conclusions apply to a complete machine. Until such distrust is overcome, true engineering progress in the design of air craft will be hampered and progress will depend, much as in the past, on "cut and try" methods. However, when the mathematician can explain by a correct application of mathematical analysis why certain things occur in practice, for which no satisfactory solution has been found, a start will be made toward the removal of the distrust of mathematical formulæ and real progress begin. As an instance of such application attention is invited to the report of Hunsaker and Wilson, of the Massachusetts Institute of Technology (Report No. 1), in which it is shown that although an aeroplane is designed so that statically it is stable to a satisfactory degree, it does not necessarily follow that the machine is dynamically stable; and in fact in the case investigated it was found that while within certain limits the machine was dynamically stable, the limits of dynamic stability were much smaller than supposed, and at low speeds dynamic instability existed to such a degree as to require correction in the design. Such instability has probably been the cause of a large number of accidents, and yet constructors and designers were at a loss to explain the cause until demonstrated by the test of a model of an actual machine in a wind tunnel.

B. *Air-speed meters*.—An important problem to aviation in general is the devising of accurate, reliable, and durable air-speed meters and other aeronautic instruments for the navigation and control of air craft.

(b-1) The most important of these problems is that of the prevention of "stalling" of aeroplanes. The committee considers "stalling" responsible for a very high percentage of aeroplane accidents. It is believed that at present the possibility of stalling exists in all machines, except a few which have been specially designed to have a high degree of inherent longitudinal stability; but it appears desirable and necessary to use machines of a normal type, because of certain considerations affecting the methods of using these machines in warfare and also because of certain restrictions involved in the performances of machines of the inherently stable type. The best means of preventing stalling is the development of a reliable air-speed meter, which by its indications will give warning of the approach to those conditions which produce stalling. A number of such meters already exist in different forms, but none so far developed or brought to the attention of the committee is considered to be satisfactory or reliable.

(b-2) The Bureau of Standards is now engaged in investigation of such meters, and attention is invited to the report of Prof. Herschel and Dr. Buckingham of the bureau on Pitot tubes. (Report No. 2.) In addition to the investigation by the Bureau of Standards referred to, a number of manufacturers and individuals are already engaged in the development of air-speed meters. The development of other forms of aeronautical instruments is in a more satisfactory condition and is progressing steadily.

C. *Wing sections*.—The evolution of more efficient wing sections of practical form, embodying suitable dimensions for an economical structure, with moderate travel of the center of pressure and still affording a large range of angle of attack combined with efficient action.

D. *Motors.*—The development of high powered aeronautic motors of the lightest possible construction consistent with reliable operation and the maximum economy of fuel and oil consumption.

(d-1) The committee is of the opinion that with proper encouragement, satisfactory types of aeroplane motors can be developed which will rival in efficiency and certainty of operation the automobile motors of to-day and the best aeronautic motors which have been developed abroad. This will require that manufacturers having capable organizations at their disposal shall become interested in aeronautic development and see a market for their products. In the meantime, both the War and Navy Departments are already engaged on this problem and may be expected to contribute valuable information in the near future. By employing some of the most competent engineers of this country on investigations of the many complicated details of design of gas engines, the committee should be able to make substantial progress on these lines.

(d-2) An efficient form of radiator is needed, which will provide satisfactory cooling for water cooled motors, without involving too much weight or resistance, and it is desirable that the principles of design should be carefully investigated with a view to the development of a type which will embody the different qualities required in such a manner as to have the least unfavorable effect on the aerodynamic efficiency of aircraft.

(d-3) An efficient form of muffler for internal combustion engines is necessary for military aircraft. An attempt by the committee to obtain a report on this subject has so far been unfruitful, though it is hoped that satisfactory progress can be made in the near future. The problem is not a simple one on account of the high power of the motors used.

E. *Propellers.*—The development of more efficient air propellers, which will hold their efficiency at high values over a large range of speed of advance. Also improvements in design of propellers relative to materials and details of construction, leading toward reduced weight and greater permanence of form, together with provision for ready repairs and moderate cost of construction.

(e-1) It is considered that this country has available a number of competent authorities on propellers for water craft, who are thoroughly equipped to place the design of aeronautic propellers on a satisfactory basis, and it is advisable that the committee should have at its disposal funds to engage such talent on the development of propeller design. A great deal of work has already been accomplished abroad and is available for use, and though high efficiency of design has been attained abroad, the progress on these lines in this country has been limited.

F. *Form of aeroplane.*—Improvements in the form of aeroplane leading toward natural inherent stability to such a degree as to relieve largely the attention of the pilot while still retaining sufficient flexibility and control to maintain any desired path, without seriously impairing the efficiency of the design.

G. *Radio-telegraphy.*—It is exceedingly desirable that the committee should investigate the question of apparatus to be used in sending messages from aeroplanes in order that there may be sure means of communication between the aeroplane and fixed base stations.

PHYSICAL PROBLEMS.

Beside the more general problems, the following problems of a physical rather than aeronautical nature are of particular interest:

A. *Noncorrosive materials*.—The availability of noncorrosive materials for construction details and fittings; such materials to have qualities comparable with those attainable in different grades of steel, both as to physical properties and as to reliability.

(a-1) Work on this line is already well in hand at the Bureau of Standards.

B. *Flat and cambered surfaces*.—A complete investigation of the effects of combinations of flat and cambered surfaces joined by hinges, as is usual in the construction of rudders.

(b-1) No extended work on these lines has yet been carried out, though facilities exist at the Washington Navy Yard and at the Massachusetts Institute of Technology.

C. *Terminal connections*.—The development of reliable terminal connections for truss wires, which will develop, if practicable, the full strength of the wire without involving too much bulk or weight, and without involving danger due to unusual care being required in attaching same; that is, the solution must be a practical and not a laboratory one.

(c-1) A valuable contribution to this question is submitted in the report volunteered by the John A. Roebling's Sons Co. (Report No. 3.)

D. *Characteristics of constructive materials*.—An accurate and authentic determination of the physical characteristics of all classes of woods, metals, and fabrics which enter into the present-day types of construction.

(d-1) Considerable information on these lines is undoubtedly available in the laboratory records of various technical institutions, but is not generally accessible. The Bureau of Standards is well equipped for this line of work.

E. *Generation of hydrogen*.—The generating of hydrogen economically at sea on a ship rolling in a seaway is a problem to be solved.

(e-1) There are many systems of generating hydrogen on land, but many of these would be defective if installed aboard ship. Any installation for this purpose aboard ship should combine capacity, compactness and economy, and certainty of operation to the highest degree.

F. *Standardization of nomenclature*.—The standardization of aeronautical nomenclature is most desirable for the whole country.

(f-1) This question has already been attacked by the Army and Navy, and the reports of these branches of the service should form a good basis for the work of the committee.

G. *Standardization of specifications*.—Standardization of specifications for aeroplane materials for use of the Government and people of this country.

(g-1) A proposition on these lines from a prominent manufacturer has already been received, and the committee has taken steps toward the development of such specifications.

H. *Bibliography of aviation*.—Revision and continuation of the bibliography of aviation.

I. *Collection, revision, and issuance of reports and bulletins* covering the state of the art of aeronautics, the primary purpose being to avoid

as far as possible unnecessary duplication of work which has already been well done.

J. Limitation of size.—Determination of the present upper limits with regard to size and carrying capacity, with special reference to the means by which those limits may be extended, it being very important to know approximately the present limitations in size and carrying capacity and to what elements these limitations apply, and why.

K. Causes of accidents.—Securing and carefully compiling of reports of causes of accidents in aeronautics.

(k-1) While conditions have changed decidedly from the early days of aeronautics in this country, there is still evidence of carelessness in the design and operation of aeroplanes. It would appear as coming within the province of this committee that legislation should be enacted toward obtaining control of this feature at an early date. However, any such legislation should be most carefully considered and the views of those interested should be obtained. This is particularly necessary, as already a number of attempts have been made toward legislation in different States, with the result that in one State, at least, experimental work is practically prohibited, not because inventors and constructors can not comply with the law, but because the operation of the law requires facilities which do not exist in the State in which the laws have been passed. With a view toward determining the requirements of such legislation, it is proposed that a beginning be made by requesting that all accidents be reported to the advisory committee on forms to be published by the committee, embodying a set of categorical questions, the answers to which may lead to a determination of the principal causes of accidents. In cases where such accidents result in the maiming or killing of spectators or flyers, such questions should be answered by the investigating authorities. The word "request" is used in view of the possible conflicts of State and Federal authority and jurisdiction; and whereas it is very probable that both State and Federal authorities would be willing and glad to cooperate in this work in response to a request, it is not clear that such cooperation would follow legislation, unless carefully worked out.

STANDARDS OF WORK.

While the functions of the committee are not considered directly to be concerned with the question of preparations for defense, in the opinion of the committee it is of greatest importance that the manufacturers of aircraft and the War and Navy Departments, at present the principal consumers, should come to a definite agreement as to the standards of work necessary to facilitate production and repairs. Of the most importance in this line is the preparation of standard specifications for materials and tests. In this manner the producers and consumers will have a clear understanding on which to base contracts, and under the stress of war conditions the multiplication of aircraft would be greatly facilitated.

IMPORTANCE OF WORK TO ARMY AND NAVY.

The importance of aircraft to the War and Navy Departments, in view of the utilization of such craft in the present war in Europe, is so evident that no further comment is offered. It is, however, strongly recommended that every consideration should be given toward the provision of adequate facilities for initiating and conducting the important experimental work necessary for the efficient development of both branches of the service on aeronautical lines.

QUARTERS FOR COMMITTEE.

By courtesy of the Secretary of War, the first meetings of the advisory committee and the executive committee were held in the reception room in the office of the Secretary of War, and the annual meeting was also held in that room. In accordance with the instructions of the advisory committee, the executive committee attempted to obtain quarters in the State, War, and Navy Department Building, but found that each of these departments was so crowded for space that none was available. However, through the courtesy of the Secretary of War, the meetings of the executive committee have been held in the private office of the officer in charge of the Aviation Section, War Department, and the office work of the committee has been temporarily conducted and the files have been kept in a portion of a room adjoining the same office. While such improvised quarters for the committee served their purpose, such temporary quarters are not satisfactory or suited to the needs of the committee. Suitable quarters can be obtained at moderate cost in one of the several office buildings centrally located in the city of Washington. It is for this reason the committee recommends that provision for suitable quarters be made in the next appropriation act.

EXISTING FACILITIES FOR AERONAUTIC INVESTIGATION IN GOVERNMENT DEPARTMENTS.

For the conduct of the work outlined, limited facilities already exist in different Government departments about as described in general terms in the following. These facilities can be augmented by the facilities described as existing in the different technical institutions, etc., previously referred to:

A. The Bureau of Standards is well equipped for carrying on all investigations involving the determination of the physical factors entering into aeronautic design, and is prepared to take up such matters as are of sufficient general interest to warrant same.

B. The Navy Department is equipped with a model basin and wind tunnel at the Washington Navy Yard, with adequate shop facilities for carrying on the work in a limited way, and is also constructing at the Washington Navy Yard a plant for the testing of aeronautic motors and devices involved in their operation, which will be in commission at an early date. Also, under the Navy Department steady progress is being made in attacking practical problems involved in the development of the Navy aeronautic service at its station at Pensacola, and theoretical and practical designs are in hand in the Bureaus of Construction and Repair and Steam Engineering.

C. The War Department has limited facilities at the flying school at San Diego, for investigations of interest to that branch of the service, and is able to carry out in a limited way experiments of interest to the service on full-sized machines, for which work it has the assistance of technical experts.

D. The Weather Bureau is well equipped for the determination of the problems of the atmosphere in relation to aeronautics, and Prof. Marvin, a member of the advisory committee, is the chairman of a subcommittee engaged on this problem. The work, however, will necessarily be limited until the necessary funds for more extensive work become available. There is already available in the records of the bureau much information of value which requires compilation in a form suited to aeronautic requirements, and this work is the subject of a preliminary report included in the annual report of the committee.

E. The Smithsonian Institution has been engaged for a number of years on the compilation of the bibliography of aeronautics, and is prepared to continue this work for at least two years more with the funds at its disposal. The institution has also contributed funds toward the development of the work of the subcommittee of the Weather Bureau in its investigation of the problem of the atmosphere in relation to aeronautics.

Itemized statement of expenditures under appropriation "Advisory Committee for Aeronautics, 1915."

No.	Payee.	Amount.
1150	J. F. Victory.....	\$26. 67
1155	Underwood Typewriter Co.....	67. 50
1156	Union Envelope Co.....	4. 23
1157	Andrews Paper Co.....	. 79
1158	Municipal Supply Co.....	7. 00
1159	Roberts Numbering Machine Co.....	2. 40
1160	Globe-Wernicke Co.....	1. 75
1161	E. J. Murphy Co.....	2. 05
1162	Shaw-Walker Co.....	10. 32
1163do.....	9. 16
1229	Transfer (supplies drawn from navy yard).....	51. 26
1420	A. B. Dick Co.....	75. 00
1435	Postal Telegraph Cable Co.....	3. 89
1436	Western Union Telegraph Co.....	20. 39
1550	Joseph N. Snellenburg.....	67. 00
1615	Prof. Michael I. Pupin.....	21. 80
1617do.....	21. 80
1640	Massachusetts Institute of Technology.....	800. 00
1641	Columbia University.....	1, 500. 00
7669	Prof. John F. Hayford.....	26. 25
7670	Prof. William F. Durand.....	213. 10
7775	Prof. Joseph S. Ames.....	3. 70
		2, 936. 06
	OBLIGATED.	
	Cornell University.....	\$1, 000. 00
	United States Rubber Co.....	1. 00
	Goodline Manufacturing Co.....	1. 88
		1, 002. 88
	Total expended and obligated.....	3, 938. 94

A statement showing the expenditures of the committee is submitted herewith.

Summary of expenditures under appropriation "Advisory Committee for Aeronautics, 1915."

Clerical services.....	\$26. 67
Office furniture.....	67. 00
Stationery and equipment.....	233. 34
Members' traveling expenses.....	286. 65
Telegrams.....	24. 28
Technical reports from Massachusetts Institute of Technology, United States Rubber Co., Columbia and Cornell Universities.....	3, 301. 00
Total expended and obligated.....	3, 938. 94
Unobligated balance turned into Treasury.....	1, 061. 06
Amount of appropriation.....	5, 000. 00

CONCLUSIONS.

From the above, it will be apparent that utilizing all facilities at present available, the progress that can be made will be fragmentary and at best lack that coordination which is necessary to accomplish in a direct, continuous, and efficient manner, and as rapidly as practicable, the important work now in sight. If the committee is to be prepared to keep pace with the increasing needs of the very rapid development already under way, stimulated by the unusual conditions existing in Europe, the facilities and technical assistance recommended are essential. While the needs at present are principally those which have an important bearing on military preparedness, the committee is of the opinion that aeronautics has made such rapid strides that when the war is over there will be found available classes of aircraft and a trained personnel for their operation, which will rapidly force aeronautics into commercial fields, involving developments of which to-day we barely dream.

Respectfully submitted.

GEORGE P. SCRIVEN,
Brigadier General, Chief Signal Officer of the Army,
Chairman.

REPORTS

SUBMITTED TO

**THE NATIONAL ADVISORY COMMITTEE
FOR AERONAUTICS.**

IN SEVEN PARTS.

REPORT No. 1.

IN TWO PARTS.

REPORT ON BEHAVIOR OF AEROPLANES IN GUSTS.

BY THE MASSACHUSETTS INSTITUTE OF TECHNOLOGY.

**Part I.—EXPERIMENTAL ANALYSIS OF INHERENT LONGITUDINAL
STABILITY FOR A TYPICAL BIPLANE.**

By J. C. HUNSAKER.

Part II.—THEORY OF AN AEROPLANE ENCOUNTERING GUSTS.

By E. B. WILSON.

LIST OF ILLUSTRATIONS.

Fig. 1 <i>a, b, c.</i>	Art. 1. Model plans.
Fig. 2.	Art. 4. Curves L, D, M.
Fig. 3.	Art. 5. Performance curves.
Fig. 4 5, 6, 7, 8, 9.	Art. 8. Curves of X, Z, M.
Fig. 10.	Art. 10. Photo of oscillator.
Fig. 11.	Art. 10. Curve of damping coefficient.
Fig. 12.	Art. 14. Curves of Routh's discriminant.

REPORT No. 1.

PART 1.

EXPERIMENTAL ANALYSIS OF INHERENT LONGITUDINAL STABILITY FOR A TYPICAL BIPLANE.

By JEROME C. HUNSAKER.

ARTICLE 1.

INTRODUCTION.

A model of span 18 inches, representing a typical military tractor biplane, was tested in the wind tunnel of the Massachusetts Institute of Technology. The lift, drift, and pitching moment were measured for a series of angles of incidence corresponding to the maximum possible changes of flight attitude. Only the discussion of symmetrical or longitudinal changes is given here. A report on the lateral stability of the same model is reserved for a later date. From the observed rate of variation of the forces and pitching moment, it was possible to calculate the "derivatives" needed in the complete theory of longitudinal stability in still air. The damping of the pitching oscillation was also determined experimentally.

The method followed is that of L. Bairstow in his extension of Bryan's theory. Notation also follows Bairstow. The value of Routh's discriminant, which Bryan has shown to be a measure of dynamical longitudinal stability, has been calculated for six speeds, ranging from the maximum to the minimum possible speeds for the aeroplane type selected. The principal point of interest brought out in this connection is that stability falls off rapidly as speed decreases or angle of attack increases, and that while this aeroplane appears to be very stable at high speeds, it is frankly unstable at speeds below 47 miles per hour.

This instability at low speeds takes the form of an oscillation in pitch combined with changing in forward speed and a rising and sinking of the whole aeroplane, which, therefore, follows an undulatory flight path. The period of the undulation is about 12 seconds, and the amplitude doubles itself in less than 20 seconds. Obviously, the pilot can not safely abandon his controls at slow speed.

The importance of this demonstrated instability at low speeds should be appreciated in view of recent accidents with military aeroplanes when operated at slow speeds.

The entire investigation of inherent longitudinal stability was preliminary to the discussion of the effect of wind gusts. Naturally, it was first necessary to find a stable aeroplane and to obtain some idea

of the "range" of stability. It now appears that a typical aeroplane is inherently stable in the sense defined at high speeds only. The effect of gusts on the uncontrolled aeroplane will, therefore, be investigated only for the high-speed condition. At low speeds the aeroplane can not be left to itself in still air. Consequently, a discussion of its certain destruction if abandoned in gusty air appears unprofitable.

ARTICLE 2.

MODEL AND PROTOTYPE.

The type of aeroplane selected is a high-speed military biplane tractor known as *Curtiss JN2*. Shop plans of this aeroplane were kindly furnished by the Curtiss Aeroplane Co., Buffalo, N. Y., to whom acknowledgment must be made for much valuable assistance, including the experimental determination of moments of inertia, etc., by Dr. A. F. Zahm of that company.

The principal dimensions of the aeroplane were assumed as follows:

Weight full load.....	pounds..	1,800
Brake horsepower.....	horsepower..	110
Maximum speed for calculations.....	miles per hour..	79
Minimum speed for calculations.....	do....	43.7
Total wing area (including ailerons).....	square feet..	384.0
Area fixed tail.....	do....	23.0
Area horizontal rudder.....	do....	19.0
Area vertical rudder.....	do....	7.8
Span of wings.....	feet..	36.0
Chord of wings.....	do....	5.3
Gap between wings.....	do....	5.3
Length of body.....	do....	26.0

The model was made geometrically similar to its prototype and one twenty-fourth scale. The general features are shown in the drawings of the model. (Figs. 1 *a*, *b*, *c*.) The model was an exact copy of the aeroplane except for the propeller and wing wiring, which features were omitted. Also wing struts were made round instead of "stream-line" in section. Since it is well known that the resistance of a series of similar aeroplanes varies somewhat less rapidly than the square of the speed and square of a linear dimension, due to skin friction, it is believed that the prediction of the resistance of the full size aeroplane from the observed model resistance will still be a fair estimate in spite of omissions on the model.

For simplicity, the model was made with the trailing ailerons or wing flaps integral with the wings. This somewhat increases the effective supporting area. Also the fixed tail and elevator were made in one, corresponding to the elevator held fast in its neutral position. These points are made clear on the drawings of the model.

ARTICLE 3.

GENERAL WIND TUNNEL PROCEDURE.

The model was tested in the 4-foot wind tunnel at a velocity of 30 miles per hour. The wind tunnel and aerodynamical balance are duplicates of the installation of the National Physical Laboratory, Teddington, England, and reference should be made to the Technical

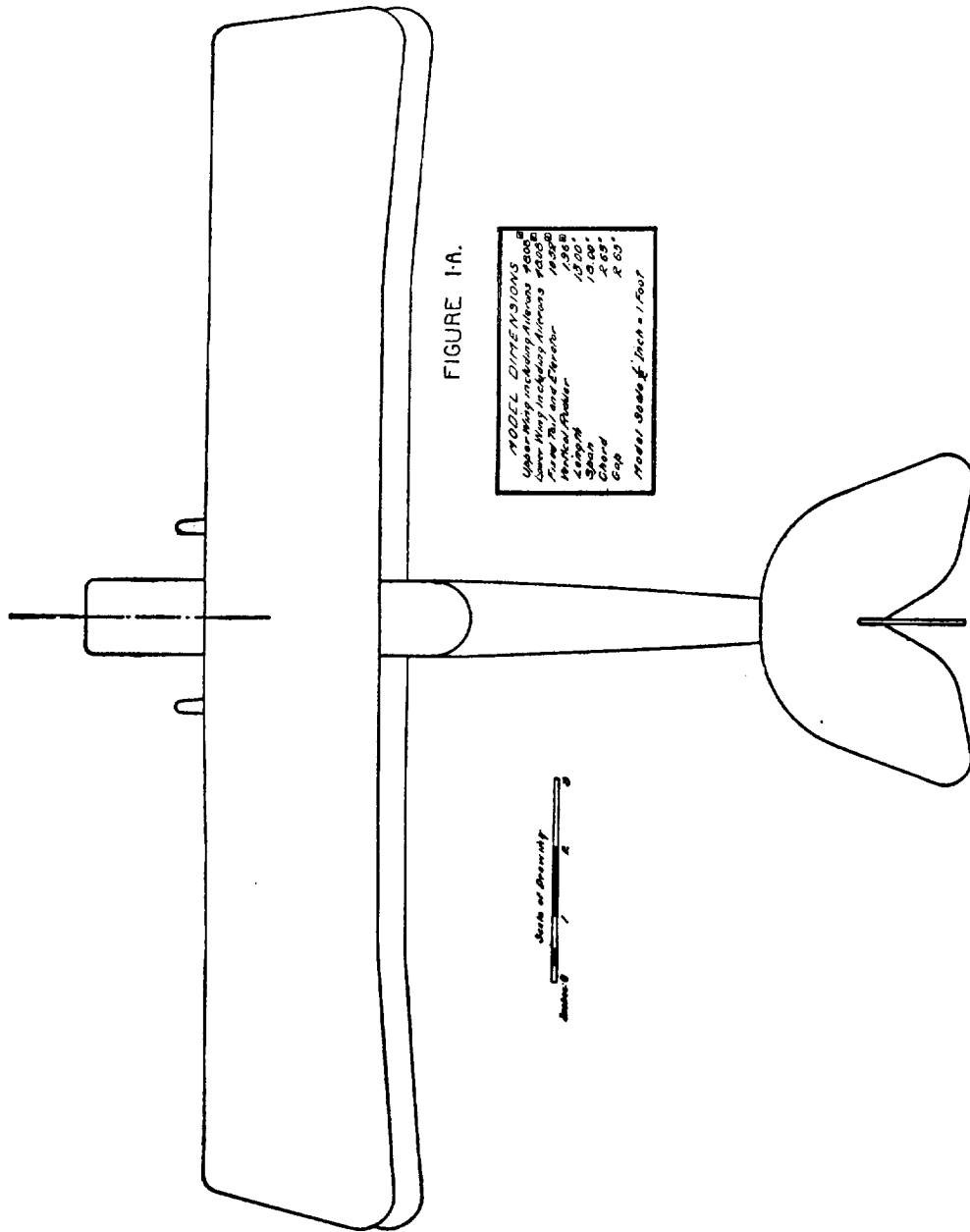
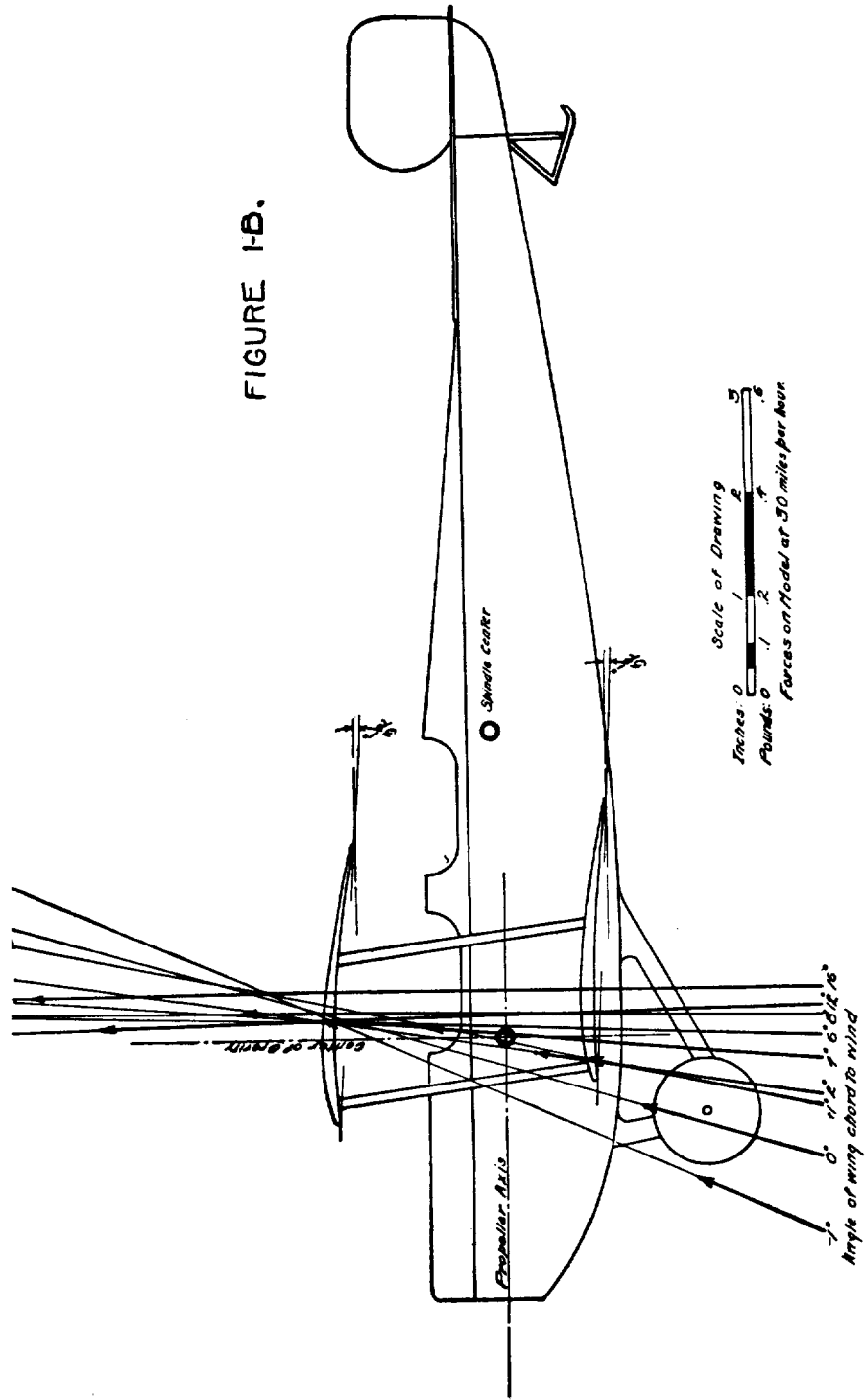

FIGURE 1-A.

MODEL DIMENSIONS	
Upper-Wing including Airfoam	9.000"
Lower-Wing including Airfoam	9.000"
Wing Span	17.000"
Wing Area	15.000"
Span	15.000"
Chord	2.000"
Tip	2.000"
Notes: Same as Inch = 1 Foot	

Scale of Drawing
 1
 2

FIGURE 1-B.



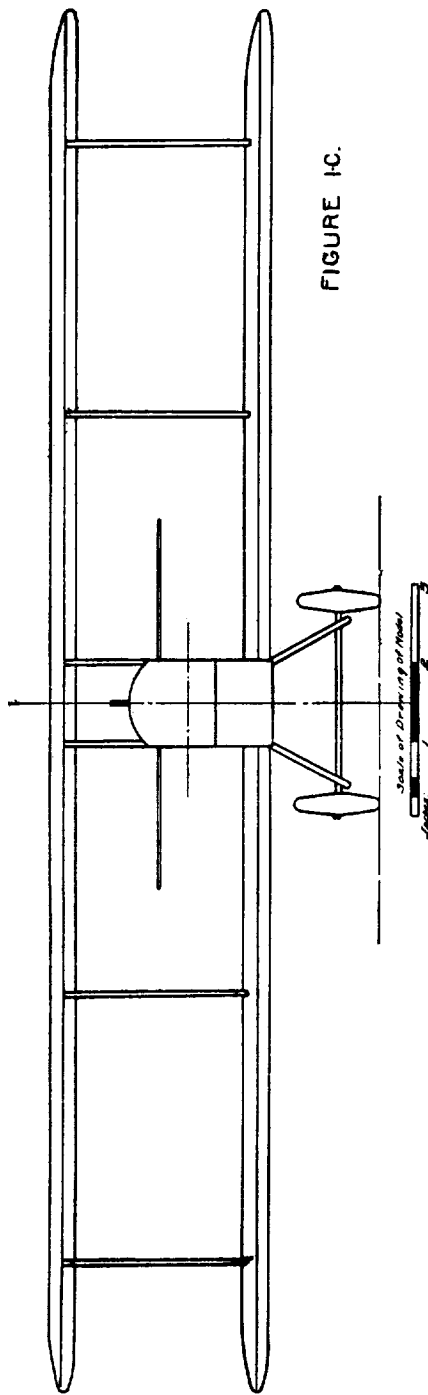

Report of the Advisory Committee for Aeronautics, London, 1912-13, for detail description and methods of operation.

In general, it may be stated that the wind tunnel provides a wind constant in velocity within 1 per cent, which velocity is further constant across the working cross section of the tunnel within $1\frac{1}{4}$ per cent. Velocity is measured by a suction plate calibrated against a standard Pitot tube with a precision of one-half per cent. The model is mounted on the balance in various attitudes of pitch or yaw, and in such positions are measured the three forces and three couples produced by the wind along and about three mutually perpendicular axes in space. From a knowledge of the variation of these forces and couples with change of attitude, the so-called "resistance derivatives" of Bryan's¹ theory of dynamical stability may be computed.

The theory of stability also requires the determination of the damping of oscillations about the center of gravity of the aeroplane. A special oscillating apparatus was built for these tests which will be described below. By oscillating the model in the wind and observing the decrement of amplitude with time, it was possible to estimate the "rotary derivatives."

ARTICLE 4.

LONGITUDINAL TESTS.

The model was mounted on the balance with its wings in a vertical plane by means of a vertical rod driven into the body at the point shown on figure 1*b*. By swinging the model about the vertical axis passing through the spindle, the angle of wind to the wing chord was varied from $+20^\circ$ to -8° . At each attitude the force across the wind or "Lift," force down wind or "Drift," and the pitching moment about the spindle were measured. The signs were taken so that an actual lift, actual head resistance, and a stalling moment are positive. The wind velocity was 30 miles per hour of standard dry air at 15° C. and 776 mm. Hg. The experimental points are shown on figure 2, where forces are in pounds and moments in inch-pounds. The precision of measurement is within 1 per cent.

For a given attitude, the resultant force on the model in pounds at 30 miles per hour is $R = \sqrt{L^2 + D^2}$. This resultant makes an angle with the wind direction given by $\alpha = \tan^{-1} \frac{L}{D}$. The force R is observed to have a pitching moment M about the spindle axis. It may then be assumed to be situated so that the perpendicular from this axis to R is given by $x = \frac{M}{R}$. The vector R is thus determined in magnitude, direction, and line of application. The resultant force vectors R are shown on figure 1*b* to a scale 1 inch equals 0.2 pound. The vector R is purely an algebraic substitution for the complicated system of forces and couples acting on the aeroplane. The vectors are drawn relative to the aeroplane.

The center of gravity was assumed to lie as shown near the intersection of the propeller axis with the resultant force vector for 4° . At this attitude, then, the pitching moment should be nearly zero.

¹ G. H. Bryan, Stability in Aviation.

The c. g. location determined for the actual aeroplane after extensive trial flights is almost identical.

It is seen that for angles smaller than 4° , R passes forward of the

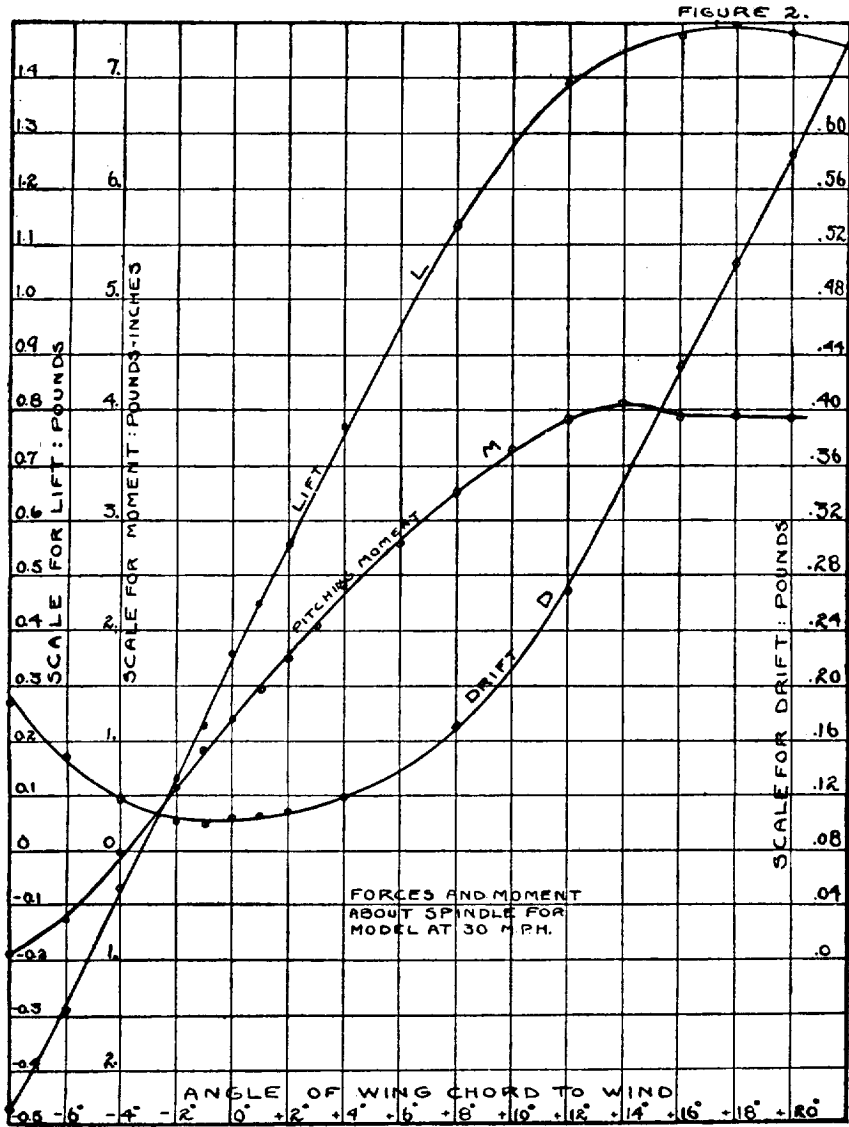

c. g. and for angles greater than 4° , it passes to the rear. The aeroplane is longitudinally stable in a static sense. It will be shown below that it is not always dynamically stable.

ARTICLE 5.

PERFORMANCE CURVES.

The lift and head resistance or "drift" of the full scale aeroplane were assumed to be approximately given by the relation:

$$\frac{\text{Force on model}}{\text{Force on aeroplane}} = \left(\frac{30}{24V}\right)^2$$

FIGURE 3.

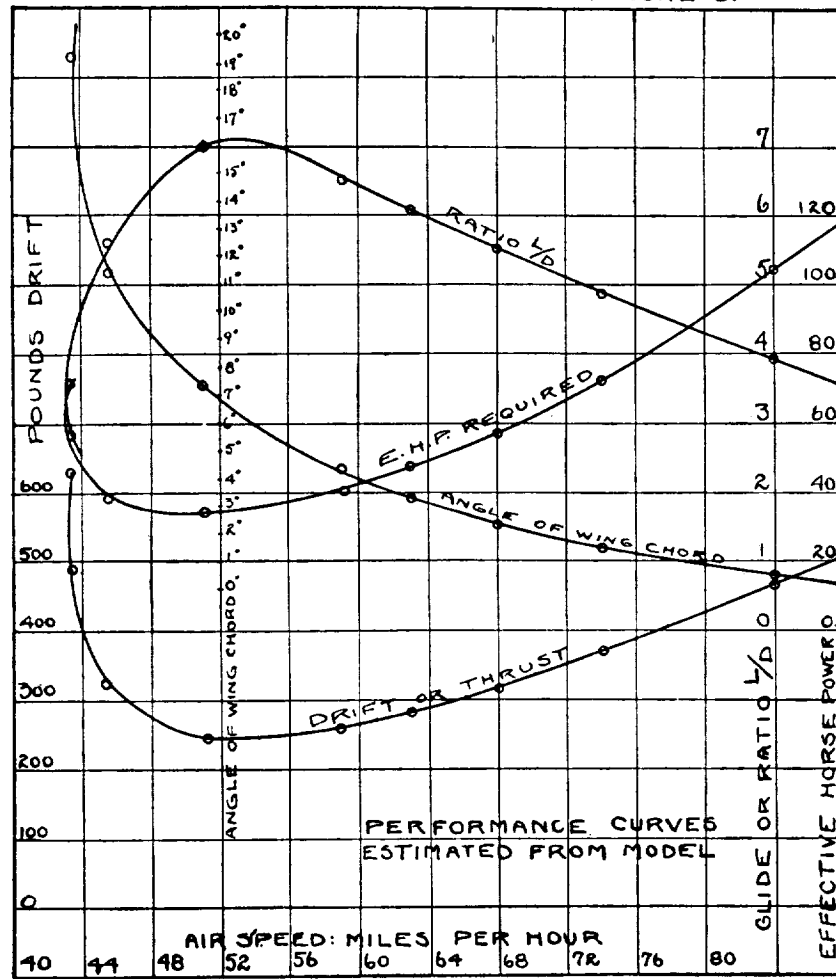

when V is the flying speed of the aeroplane in miles per hour. The above relation holds, of course, only for the same attitude of model and aeroplane. The weight of the aeroplane, 1,800 pounds, must equal the lift in flight. Hence:

$$V = \frac{30}{24} \sqrt{\frac{1800}{\text{Lift on model}}}$$

A series of speeds V was computed for a series of attitudes of the aeroplane, and the aeroplane drift at each attitude was then computed from:

$$D \text{ full size} = D \text{ model} \times 24^2 \times \left(\frac{V}{30}\right)^2$$

In figure 3 are given curves of drift, effective horsepower required, angle of wing chord to wind and ratio weight to drift plotted on V as abscissae. For our calculations a maximum speed of 79 miles and a minimum of 43.7 miles were selected corresponding to angles of wing chord to wind of 1° and 15.5° , respectively.

The curve of E.H.P. on figure 3, indicates that 87 propeller horsepower is necessary for a speed of 79 miles. If the propeller has an efficiency of 80 per cent, the motor must develop at least 110 brake horsepower. The original designs contemplated as maximum speed of about 80 miles per hour for a 120 brake horsepower motor, which appears very reasonable. As actually built this type was given a rated 90 horsepower motor. Assuming 70 E.H.P. delivered to the propeller a speed of 73 miles per hour is indicated by our curves. It is reported that the speed of this aeroplane was actually 73 miles per hour.

ARTICLE 6.

CHOICE OF AXES—NOTATION—UNITS.

Axes for reference are assumed fixed in the aeroplane and moving with it in space. The origin is at the center of gravity. For steady horizontal flight at a given attitude the axis of Z is vertical, the axis of X Horizontal and directed to the rear in the plane of symmetry, and the axis of Y is horizontal and directed toward the left-wing tip. Forces along these axes are denoted by X , Y , Z and are expressed in pounds per unit mass. Moments are L , M , N and are given in pounds-feet per unit mass.¹

Angles of roll, pitch and yaw from the normal flying attitude are denoted by φ , θ and ψ . Angular velocities of roll, pitch and yaw are p , q , r in radius per second. The signs of moments, angles and angular velocity are positive considered in the directions $X\dot{Y}$, YZ or $Z\dot{X}$.

Moments of inertia referred to axes X , Y , Z are denoted by mK_a^2 , mK_b^2 , mK_c^2 where m is the mass of the aeroplane and K_a , K_b , K_c corresponding radii of gyration.

ARTICLE 7.

EQUILIBRIUM CONDITIONS.

In normal horizontal flight in still air a state of equilibrium is assumed such that the power available maintains the aeroplane at such a speed that the weight is just sustained. Since the lift of an aeroplane wing is also a function of its attitude or angle of attack, it is further assumed that the attitude is proper for the speed. In

¹ Unit mass is the slug equal to 32.17 pounds weight.

normal horizontal flight the axis of X is parallel to the apparent wind direction and is hence horizontal. Let θ be the angle of pitch of the aeroplane away from its normal attitude. Then normally θ is zero. Likewise if the aeroplane is in equilibrium in its flight, the angular velocity of pitch is zero and also the pitching moment, M_0 .

At high speed, for example 79 miles, the axis of X is horizontal and makes an angle of 1° with the wing chord. At low speed, new axes are chosen such that the axis of X' is still horizontal but makes an angle of 15.5° with the wing chord. The axes are fixed by the equilibrium conditions for flight and differ for each normal flying attitude. Oscillations about the normal flight path when the motion is disturbed are referred to the above defined axes which are assumed fixed in the aeroplane and moving with it in space.

The pitching moment curve observed for the model shows zero moment for an angle of wing chord of 4.5° and a diving moment at larger angles. For slow flight, it is assumed that the pilot by proper setting of his horizontal rudder impresses an equal stalling moment on the machine so that the net pitching moment is zero. The effect is to move the pitching moment curve parallel to itself by the algebraic addition of a stalling moment so that its ordinate has zero value for the desired flight attitude.

ARTICLE 8.

TRANSFORMATION OF AXES.

It is convenient to measure in the wind tunnel the lift and drift about axes always vertical and horizontal in space. For the oscillations of the aeroplane it is convenient to consider the forces referred to axes fixed in the aeroplane as described above. The transformation is effected in the usual way by means of the formulæ:

$$\begin{aligned} m Z' &= L \cos \theta + D \sin \theta, \\ m X' &= D \cos \theta - L \sin \theta, \end{aligned}$$

where θ is the angle of pitch of the aeroplane away from its normal attitude, considered positive for stalling angles. Here L and D are lift and drift on the model in pounds, and $m X'$ and $m Z'$ corresponding forces in pounds along the axes X and Z . The model forces Z' , X' are converted to Z , X , full size, by multiplying by the square of the speed and linear dimension ratios. The following tables carry out the required transformation.

The pitching moment M is independent of the longitudinal shift of axes and varies only as the square of the speed. Curves of X , Z and M for the different flight attitudes are plotted on figures 4, 5, 6, 7, 8, and 9. The transformation of the moment about the spindle to the corresponding moment about the c. g. of the full-size aeroplane is given below.

$i=1^\circ$, $V=79$ miles, $m=55.9$ slugs.

i	θ	L	D	Z	X
- 4	- 5	-0.08	+0.115	- 6.4	+7.7
- 2	- 3	+ .14	.104	+ 10.8	7.8
0	- 1	.35	.102	24.9	7.76
+ 1	0	.45	.104	32.9	7.4
+ 2	+ 1	.56	.108	40.0	7.1
+ 4	+ 3	.765	.118	54.9	5.6
+ 8	+ 7	1.13	.165	81.0	1.9
+12	+11	1.39	.270	100.0	-.7
+16	+15	1.48	.428	109.0	-2.05
+20	+19	1.48	.581	112.5	-4.7

 $i=7^\circ$, $V=51.8$ miles.

0	- 7	+0.35	+0.102	+10.3	+4.42
1	- 6	.45	.104	13.4	4.64
2	- 5	.56	.108	16.9	4.79
4	- 3	.765	.118	23.3	4.85
7	0	1.05	.150	32.2	4.60
12	+ 5	1.39	.270	48.0	4.54
16	9	1.48	.428	47.0	5.90
20	13	1.48	.581	48.2	7.12

 $i=10^\circ$, $V=47$ miles.

6	- 4	+0.96	+0.136	+24.0	+5.14
8	- 2	1.13	.165	28.4	5.18
10	0	1.28	.21	32.4	5.21
12	+ 2	1.39	.27	35.4	5.56
14	+ 4	1.45	.348	37.2	6.24

 $i=12^\circ$, $V=45.2$ miles.

8	-4	1.13	0.165	26.1	5.68
10	-2	1.28	.21	29.6	5.83
12	0	1.39	.27	32.4	6.29
14	+2	1.45	.348	34.0	6.92
16	+4	1.48	.428	35.2	7.56

 $i=14^\circ$, $V=44.2$ miles.

10	-4	1.28	0.21	28.3	6.67
12	-2	1.39	.27	30.8	6.87
14	0	1.45	.348	32.4	7.22
16	+2	1.48	.428	33.3	7.43
18	+4	1.50	.508	34.2	7.62

$i=15.5^\circ$, $V=43.7$ miles.

i	θ	L	D	Z	X
9.5	-6	1.24	0.196	26.4	7.1
13.5	-2	1.40	.330	30.6	8.25
15.5	0	1.48	.408	32.2	8.9
17.5	+2	1.49	.482	33.0	9.4
19.5	+4	1.49	.561	33.4	10.0

CONVERSION OF PITCHING MOMENTS.

mM_s =moment about spindle in inch pounds on model.
 mM_{cg} =moment about c. g. in inch pounds on model.
 $b=3.04$ inches, c. g. forward of spindle.
 $a=0.10$ inches, c. g. above spindle.
 Axis of X 3.5° to wing chord.
 M =pitching moment about c. g. full size, full speed, in pounds feet per unit mass.
 $mM_{cg}=mM_s-mZ'b-mX'a$.
 i =angle of wing chord to wind, degrees.
 θ =angle of axis of X to wind, degrees.

i	θ	L	D	mZ'	mX'	mM_s	mM_{cg}	$1^\circ M$	$7^\circ M$	$11^\circ M$	$12^\circ M$	$14^\circ M$	$15^\circ.5 M$
-4½	-8	+0.130	+0.123	-0.146	+0.104	-0.022	+0.21	+29.9	+12.9	9.36	9.17
-2½	-6	+ .080	.105	+ .069	.112	+ .400	+ .18	+25.7	+11.0	8.0	7.85
-	-4	+ .300	.102	.293	.121	+1.05	+ .15	+21.4	+ 9.2	6.07	6.54
+1½	-2	.510	.105	.506	.123	1.65	+ .10	+14.3	+ 6.1	4.46	4.37
2½	-1	.615	.110	.613	.122	1.93	+ .08	+11.4	+ 4.9	3.56	3.49
3½	0	.715	.115	.715	.115	2.21	+ .03	+ 4.28	+ 1.8	+ 1.35	+ 1.32
4½	+1	.810	.122	.812	.107	2.48	00	0	0	0	0
5½	+2	.910	.130	.915	.098	2.71	-.98	-11.4	- 4.9	- 4.0	- 3.72	- 3.56	- 3.49
7½	+4	1.09	.157	1.10	.081	3.17	-.18	-25.7	-11.1	- 9.07	- 8.40	- 8.02	- 7.86
11½	+8	1.37	.252	1.40	.058	3.81	-.49	-57.0	-24.5	-29.2	-18.7	-17.9	-17.5
15½	+12	1.48	.408	1.51	.184	4.00	-.69	-85.5	-36.8	-30.3	-28.0	-26.8	-26.2
19½	+16	1.49	.561	1.54	.331	3.95	-.76	-108.0	-46.6	-33.9	-33.2

ARTICLE 9.

RESISTANCE DERIVATIVES, LONGITUDINAL.

Notation follows Bairstow,¹ to whose paper reference should be made for the detailed discussion of "derivatives." In the theory of small oscillations, the aerodynamic forces X_o , Z_o , and pitching moment, M_o , are eliminated by the conditions of equilibrium. In disturbed motion, disturbances in normal flying speed and attitude cause changes in the quantities, X , Z , and M .

Let U be the normal flying speed and u , w and q small changes in horizontal and vertical velocity components and angular velocity of pitch. If the disturbance be small, u , w and q are small with respect to U . For example, the function

$$X=f(U+u, w, q)$$

may be expanded into the approximate form

$$X=X_o+uX_u+wX_w+qW_q,$$

a linear function of the small quantities u , w , q . The coefficients X_u , X_w , X_q are the so-called resistance derivatives of the theory of

¹ Technical Report of the Advisory Committee for Aeronautics, London, 1912-13.

FIGURE 4.

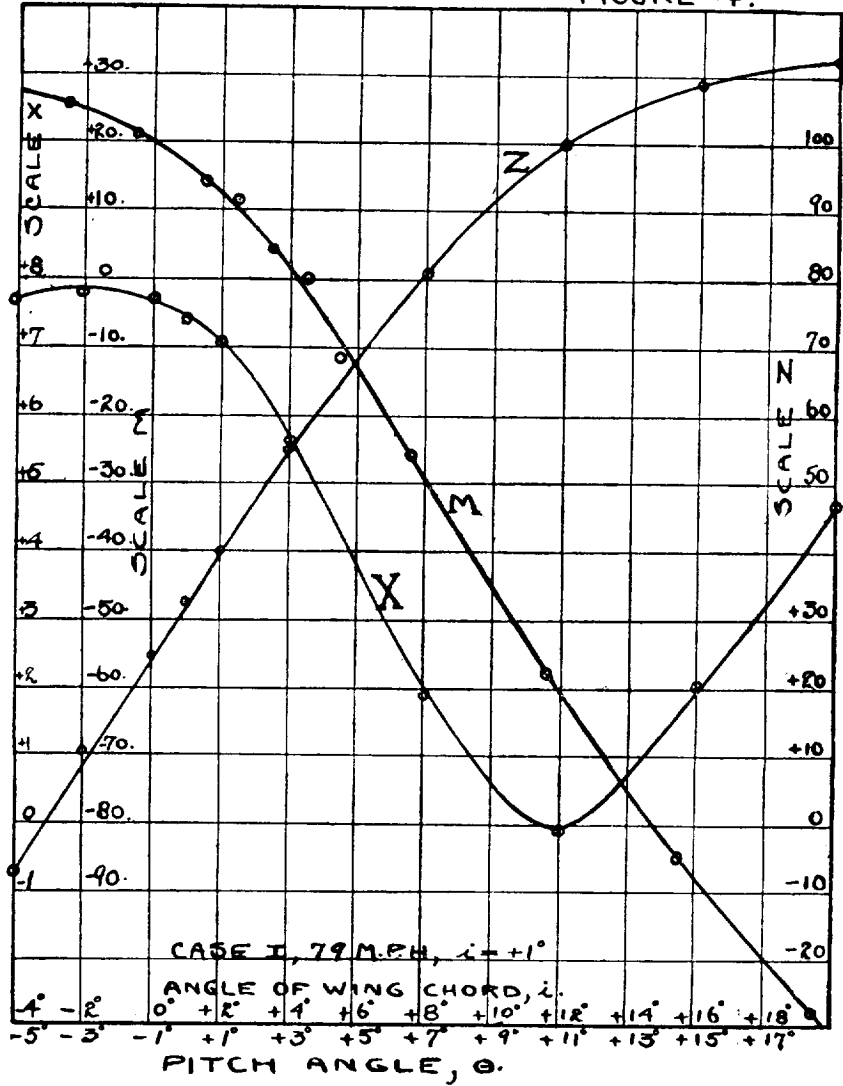
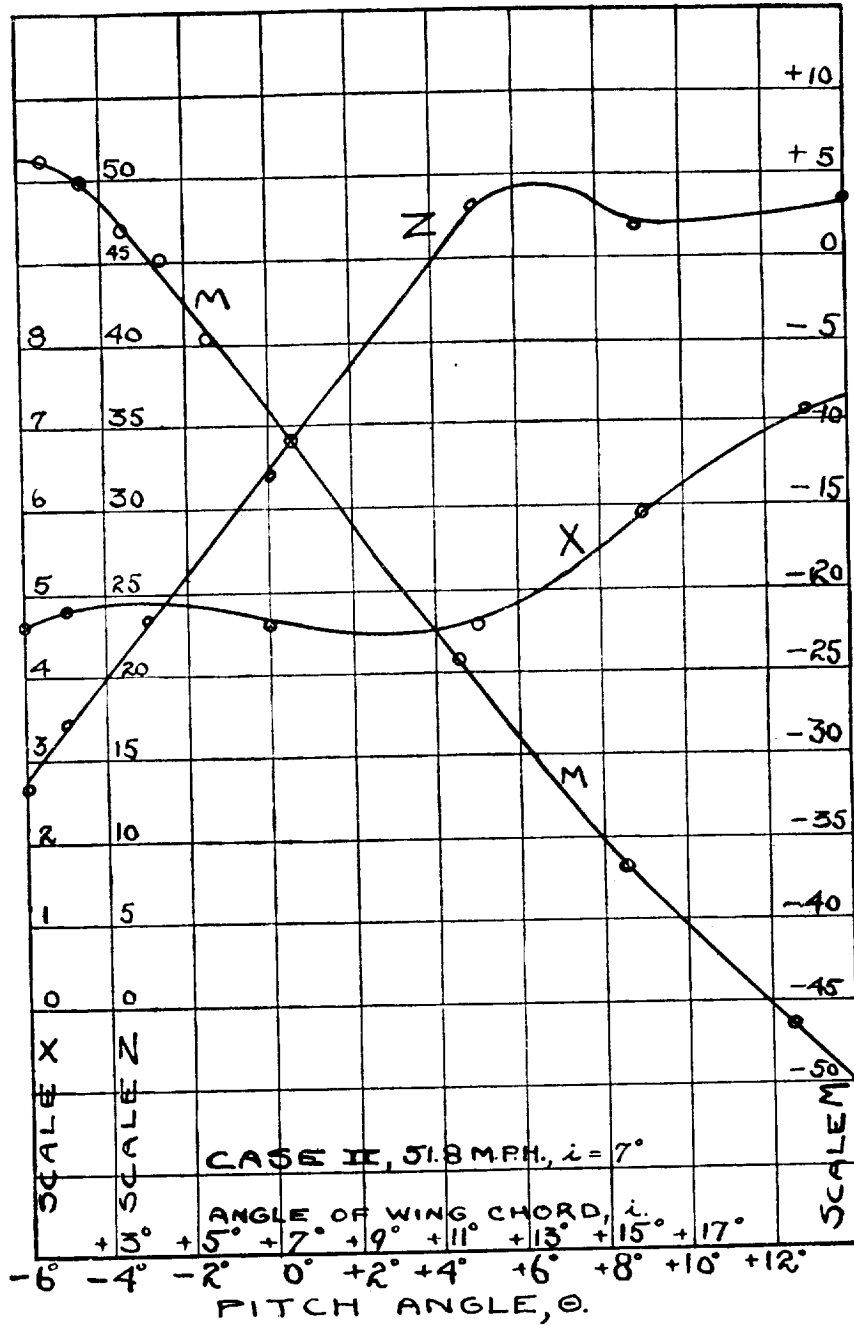
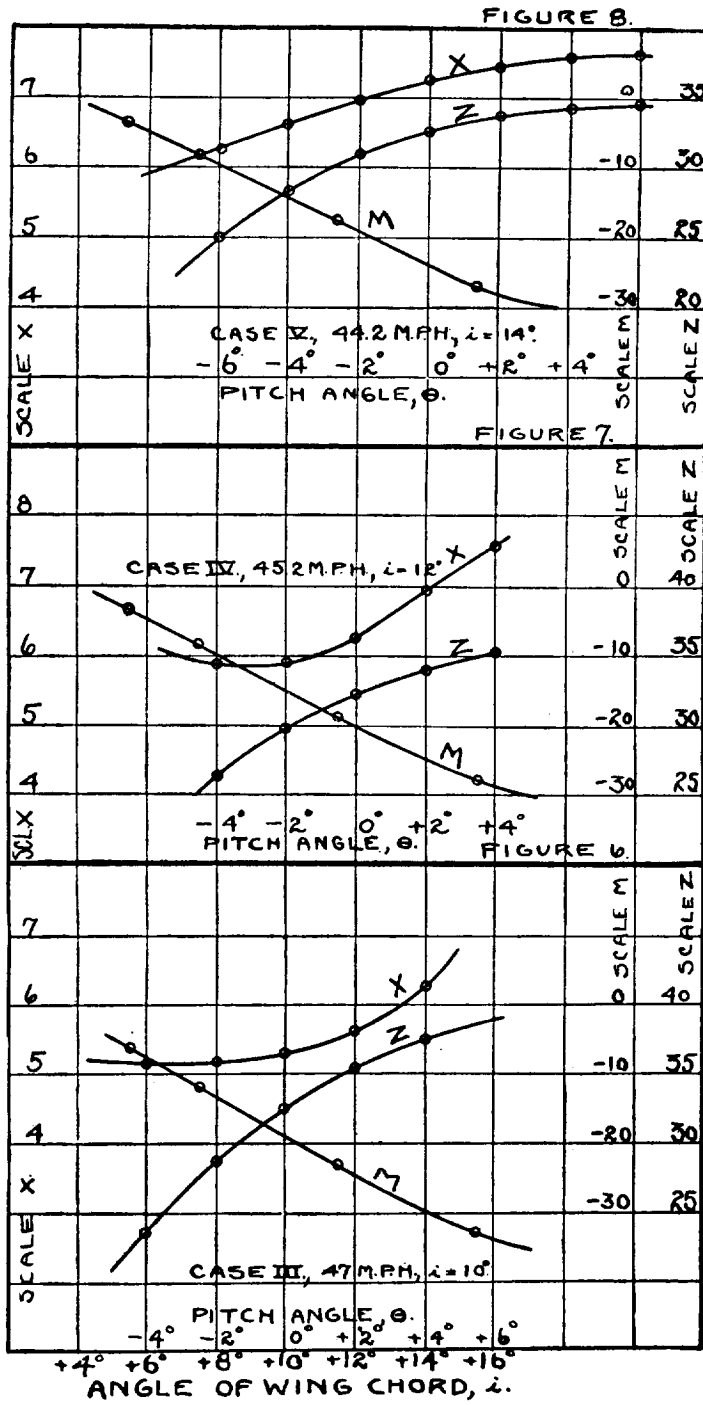
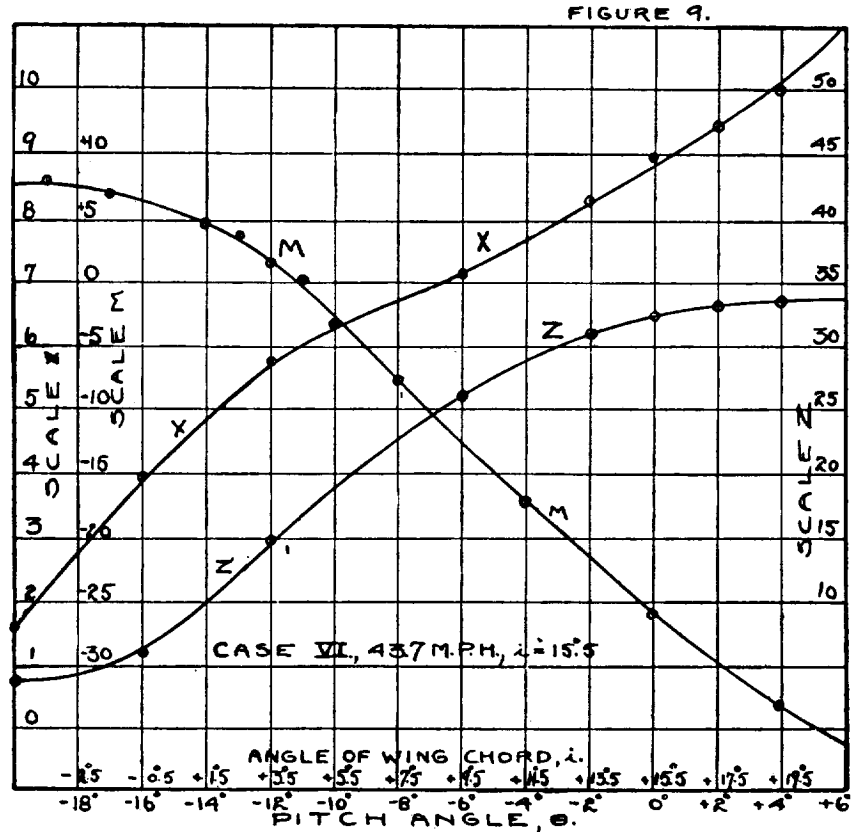

FIGURE 5.







small oscillations, and physically represent the slope of a curve of X on a base u, w , or q .

Similarly

$$Z = Z_0 + uZ_u + wZ_w + qZ_q$$

$$M = M_0 + uM_u + wM_w + qM_q$$

From the conditions of equilibrium, X_0 is balanced by the propeller thrust, Z_0 by the pull of gravity or $Z_0 = g$, and $M_0 = 0$. Also, Bairstow has shown that X_q and Z_q may be neglected.

X_u is the rate of change of X with change in forward speed. But since X is a function of forward speed squared we may write:

$$X_u = \frac{\Delta X_0}{\Delta U} = \frac{2X_0}{U}$$

and

$$Z_u = \frac{2Z_0}{U}$$

These coefficients may be obtained directly by calculation since $X_o = \frac{\text{Drift}}{m}$, and $Z_o = g$. For example, at 79 miles per hour, $U = -115.5$ feet per second and $Z_o = 32.2$. Then

$$Z_u = \frac{2 \times 32.2}{-115.5} = -.557$$

Also at $15^\circ 5$, $U = -63.8$ feet per second and

$$X_u = \frac{2 \times 10}{-63.8} = -.276$$

The derivatives X_w , Z_w , M_w represent the effect of a vertical component of velocity. From the well-known method of velocity composition, the vertical velocity w acts with the horizontal velocity U to cause the apparent wind to have an inclination to the horizontal of $\tan^{-1} \frac{w}{U}$. This inclination is given to the model in the wind tunnel, and X , Z , and M measured for various pitch angles.

But $\Delta\theta = \tan^{-1} \frac{w}{U} = 57.3 \frac{w}{U}$, when $\Delta\theta$ is a small angle in degrees.

$$\therefore X_w = \frac{\Delta X}{w} = \frac{57.3}{U} \frac{\Delta X}{\Delta\theta}$$

$\frac{\Delta X}{\Delta\theta}$ is the slope of a curve of X on pitch angle as base. For example,

from figure 4, $\frac{\Delta X}{\Delta\theta} = \frac{-.65}{2}$ and

$$X_w = \frac{57.3}{-115.5} \cdot \frac{-.65}{2} = +0.162$$

Similar formulas are used to compute Z_w and M_w . It may be noted that the method assumes that for small oscillations, hence small changes θ , the tangent may be substituted for the actual curve. The limit of validity is obviously the range of pitch angle over which the tangent to the curve is not greatly changed. This range is usually about 4 to 8 degrees.

The values of the resistance derivatives calculated in this manner will be found tabulated later.

ARTICLE 10.

DAMPING.

The damping of pitching about the c. g. is represented by the rotary derivative M_q . For an angular velocity $\frac{d\theta}{dt} = q$, a damping moment $q M_q$ is exerted on the aeroplane.

To measure this aerodynamic damping, the special oscillating apparatus was designed which is shown by the photograph of figure 10. The model is mounted on a massive bracket which pivots about the

two points shown. Fore-and-aft arms carry counterweights which are adjusted to give a reasonable natural period. The spiral springs bear in notches on the arms by means of knife-edged shackles. The springs insure that the motion shall be oscillatory. The assumed c. g. location of the aeroplane model is arranged to be on the axis of rotation. The actual center of gravity of the apparatus is not considered.

Friction is kept small by careful design of the steel pivots, which are hardened steel points bearing in tool steel cones. The spring knife edges are glass hard. It was found that a convenient period is about one-half second. In still air the apparatus will rock more than 300 times before the amplitude is diminished by friction to one-ninth of the initial displacement.

The moment of inertia of the entire oscillating mass was calculated and then checked by an independent experimental determination.

Let:

- I = moment of inertia of all oscillating parts in slug foot-units.
 m' = mass of all oscillating parts in slugs.
 M_o = moment of air forces on model at rest.
 M_s = moment of springs at rest.
 $K\theta$ = additional moment of springs when deflected.
 c = c. g. of entire apparatus above pivot, feet.
 θ = angle of pitch from normal attitude in radians.
 $\mu_o \frac{d\theta}{dt}$ = damping moment due to friction.
 $\mu_w \frac{d\theta}{dt}$ = damping moment due to wind on apparatus.
 $\mu_m \frac{d\theta}{dt}$ = damping moment due to wind on model.
 $cm'\theta$ = static moment due to gravity.

The equation of motion then is:

$$I \frac{d^2\theta}{dt^2} + (\mu_o + \mu_w + \mu_m) \frac{d\theta}{dt} + (K - cm')\theta + M_o - M_s = 0$$

But $M_o = M_s$, by the initial condition of equilibrium. Let

$$\mu = \mu_o + \mu_w + \mu_m; \text{ then } I \frac{d^2\theta}{dt^2} + \mu \frac{d\theta}{dt} + (K - cm')\theta = 0$$

The solution of this equation is well known to be:

$$\theta = C e^{-\frac{\mu t}{2I}} \cos \left\{ t \sqrt{(K - cm') \frac{1}{I} - \frac{\mu^2}{4I^2}} + \alpha \right\},$$

where C and α are arbitrary constants. If time be counted when the amplitude of swing is a maximum then $\cos\{-\} = 1$, and $\theta = \theta_o$, the initial displacement. Also if the number of beats be counted by

S. Doc. 268, 64-1.

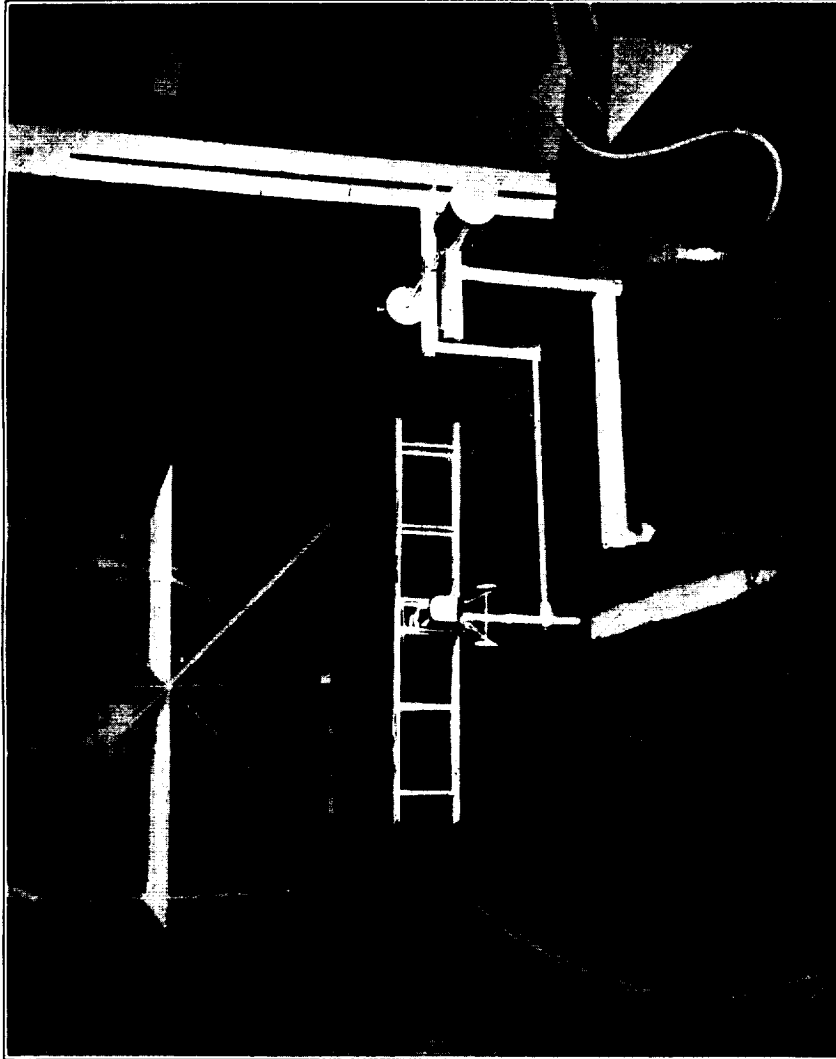

observing the times for succeeding maxima, a plot of amplitude on time will have for its equation the simple form:

$$\theta = \theta_0 e^{-\frac{\mu t}{2I}}$$

The coefficient μ is the logarithmic decrement of the oscillation and must be numerically positive to insure that the oscillation dies out with time.

The apparatus was fitted with a small reflecting prism by which a pencil of light was deflected toward a ground glass plate set in the roof of the tunnel. Nine lines spaced 0.2 inch were ruled on this plate. With the model at rest the beam of light was brought to a sharp focus on the line marked zero. By means of a trigger the observer started an oscillation of the model, and the spot of light was observed to oscillate across the scale. The time, t , was observed in which an oscillation was damped from an amplitude of 9 to an amplitude of 1, for example.

Then: $\log_e \frac{\theta_0}{\theta} = \frac{\mu t}{2I} = \log_e 9$, and knowing I and t , μ is calculated.

Preliminary tests showed that the same value of μ was obtained whether the timing stopped at $\theta = 5, 4, 3, 2$, or 1.

Oscillation tests were made at five wind velocities varying from 5 to 35 miles per hour. The coefficient μ appeared to vary approximately as the first power of the velocity.

Similar tests were made with the model for no wind to determine μ_0 , which may be said to be due almost wholly to friction and very slightly to the damping of apparatus and model moving through the air.

Likewise μ_w was obtained by oscillating the apparatus without model in winds from 5 to 35 miles per hour.

The coefficient μ_m has the dimensions $^1 \rho l^4 V$, where ρ is density of air, l a linear dimension, and V the velocity of the wind. To convert μ_m to M_q for the full-size machine at full speed, multiply by the fourth power of 24, the scale, and by the ratio of full speed to model speed.

The numerical results of tests of the pitching oscillation follow. Note that the damping of the pitching falls off for low speeds. This contributes to the difficulty of providing sufficient stability at low speeds.

In the tables following, the number of beats, n , is recorded as a general check and is not used. Recorded values of n and t are the means of three or five separate observations.

¹ Bairstow, loc. cit., p. 176.

FIGURE II.

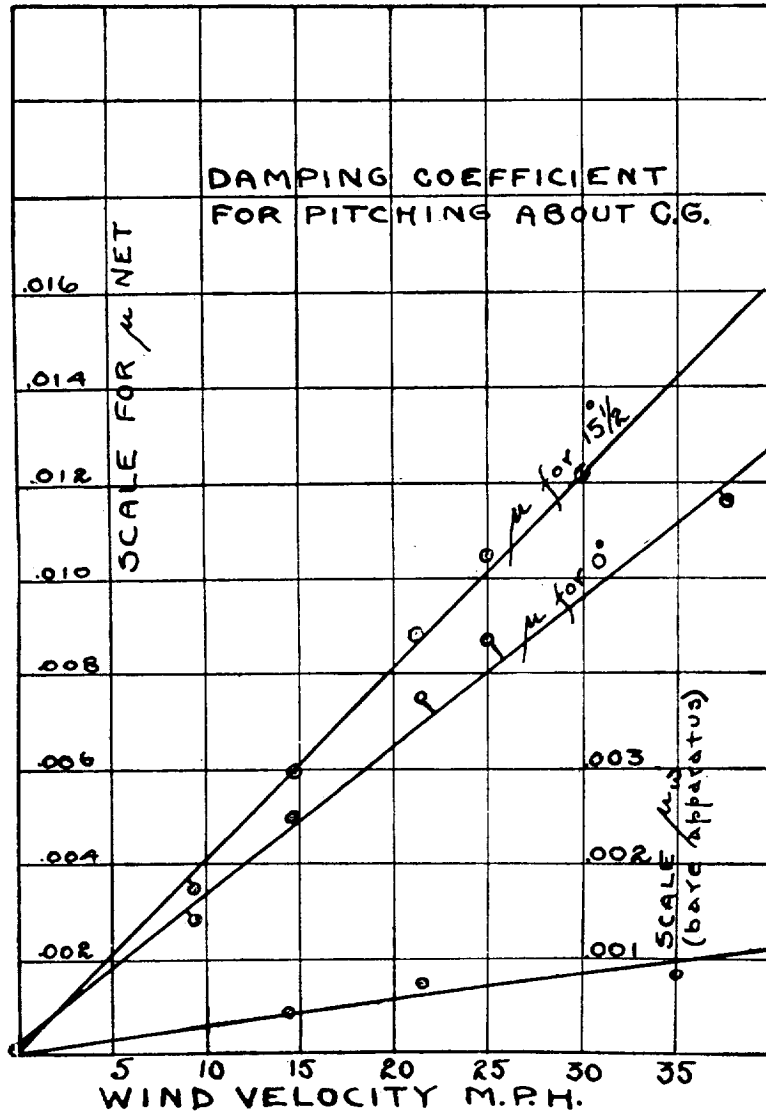

PITCHING OSCILLATION TESTS.

I model and apparatus=0.04195
 I apparatus = .0368

Apparatus.

Wind velocity, miles....	0	14.7	21.4	35
n beats counted.....	350	253	210	186
t seconds.....	168	120	100	90
μ.....	.00096	.00135	.00162	.00180
μ _w (less zero).....	0	.00039	.00066	.00084

} Use faired values below.

Apparatus and model with wing chord 1° to wind.

V miles.....	0	9.5	14.7	21.3	25	30	37.3
n beats.....	300	90	56	40	35	32	27
t seconds.....	160	45	28.5	20	17.5	16	13.5
μ gross.....	.00115	.00410	.00646	.0092	.0105	.0115	.0137
μ _o friction.....	.00096	.00096	.00096	.0010	.0010	.0010	.0010
μ _w apparatus.....	0	.00035	.00040	.0006	.0007	.0009	.0011
μ _m net.....	.00019	.00284	.0054	.0076	.0088	.0096	.0117

But μ_m = -m M_q when reduced to full size and 79 miles per hour and mass of 55.9 slugs.

$$\therefore M_q = -.0096 \times (24)^4 \times (79/30) \times 1/55.9 = -150.0$$

or for

$$U = -114 \text{ foot-seconds, } M_q = 1.32 U$$

Apparatus and model with wing chord 15.5° to wind.

V.....	9.1	14.7	21.4	25	30	37.5
n.....	75	50	35	30	25	19
t.....	38.5	25.0	17.5	15	13	9
μ gross.....	.0048	.0074	.0105	.0123	.0142	.0205
μ _m net.....	.0035	.0060	.0089	.0106	.0123	.0184

$$M_q = -.0123 \times (24)^4 \times (43.7/30) \times 1/55.9 = -106$$

or

$$M_q = 1.66 U \text{ where } U \text{ is } -64 \text{ foot-seconds, or } 43.7 \text{ miles.}$$

The computed values of μ_m, the model damping coefficient, are plotted on figure 11. It appears that μ_m is approximately a linear function of the velocity, as would be expected, and the conversion to full scale, full speed, is made as indicated above.

The damping coefficient is not greatly different for different attitudes, and the following values are obtained by interpolation:

Angle of wing chord to wind.	V.	U.	M _q .
+1°	79.0	-115.5	1.30 U = -150
7°	51.8	- 75.8	1.49 U = -113
10°	47.0	- 68.8	1.55 U = -108
12°	45.2	- 66.2	1.59 U = -106
14°	44.2	- 64.8	1.63 U = -106
15.5°	43.7	- 64.0	1.66 U = -106

ARTICLE 11.

RADIUS OF GYRATION.

For the radii of gyration of the fully loaded aeroplane we are indebted to Dr. A. F. Zahm. The actual aeroplane, complete with gasoline, water, pilot, passenger, and other weights in place, was suspended from a beam by a chain. The center of gravity was first located by an inclining method. The machine was then made to oscillate in pitch about the point of attachment of the upper end of the chain. Light guys were run to tail and wing tips to insure that the chain and aeroplane moved as a rigid body.

Let the distance from center of gravity to point of suspension be denoted by h , p the natural period of oscillation in seconds, K_B the radius of gyration in feet about the Y axis or axis of pitch, then

$$K_B^2 = \left(\frac{gh}{4\pi^2} \right) p^2 - h^2$$

By observation $h = 12.2$ feet, $p = 60/14$ seconds.

$$K_B^2 = 34, \quad K_B = 5.8 \text{ feet.}^1$$

ARTICLE 12.

ROUTH'S DISCRIMINANT.

Bryan² has shown that the character of the longitudinal motion of an aeroplane may be investigated with reference to the roots of a biquadratic equation of the form:

$$A\lambda^4 + B\lambda^3 + C\lambda^2 + D\lambda + E = 0$$

The equations of motion may be considered of the form $\Theta = Ke^{\lambda t}$ where K is some constant. For stability the quantity λ must be negative if real, or have its real part negative if complex, in order that the amplitude of the motion will diminish with time.

The condition that the real roots and real parts of imaginary roots of a biquadratic equation with constant coefficients shall be negative is that the coefficients A, B, C, D, E shall each be positive as well as the quantity $BCD - AD^2 - B^2E$. The latter is commonly known as Routh's³ discriminant.

The constant coefficients A, B, C, D, E , are functions of the constants of the aeroplane at the normal flying attitude, i. e., the following: $X_u, X_w, X_q, Z_u, Z_w, Z_q, M_u, M_w, M_q, U$, and K_B^2 . These are resistance and rotary derivatives, velocity, and radius of gyration. For a given attitude and for small oscillations about that attitude, it is here assumed that these quantities are constant. For simplicity it is here assumed that normal flight takes place in a horizontal plane and the inclination of the flight path and consequent components of gravity in the axes of X and Z are eliminated. Also X_q and Z_q are

¹ It is of interest to note that the radius of gyration for rolling was estimated to be 6.2 feet.

² Stability in Aviation.

³ Advanced Rigid Dynamics, E. J. Routh.

neglected as unimportant and M_u is zero by the conditions of equilibrium. For the computation of Routh's discriminant we require to know, then, only those quantities which have been so far determined, and which are assembled below for the different cases investigated.

Formulae for the coefficients A, B, C, D, E are given by Bairstow and are used here, but making $\Theta, X_q, Z_q,$ and M_u zero. They are copied in simplified form for reference.

$$A = K_B^2$$

$$B = -(M_q + X_u K_B^2 + Z_w K_B^2)$$

$$C = \begin{vmatrix} Z_w & U \\ M_w & M_q \end{vmatrix} + X_u M_q + K_B^2 \begin{vmatrix} X_u & X_w \\ Z_u & Z_w \end{vmatrix}$$

$$D = - \begin{vmatrix} X_u & X_w & 0 \\ Z_u & Z_w & U \\ M_u & M_w & M_q \end{vmatrix}$$

$$E = -g M_w Z_u$$

ARTICLE 13.

BAIRSTOW'S APPROXIMATE SOLUTION.

From consideration of the usual relative numerical values of the coefficients of the biquadratic, Bairstow has shown that the equation may be factored to a first approximation and put into the following form:

$$\left(\lambda^2 + B/A\lambda + C/A\right) \left(\lambda^2 + \left[D/C - \frac{BE}{C^2}\right]\lambda + \frac{E}{C}\right) = 0.$$

in which the first factor represents a very short oscillation, which in most aeroplanes rapidly dies out and is of no importance. The second factor represents a relatively long oscillation involving an undulatory flight path with changes in pitch, forward speed, and altitude. The long oscillations should diminish in amplitude with time, in which case the motion is stable and the aeroplane will return to its original normal flight attitude if temporarily deviated therefrom by accidental cause. The motion is unstable if the long oscillation increases in amplitude with time. It will be shown that the aeroplane under investigation is stable at high speeds and unstable at very low speeds. It is believed that this is true of all aeroplanes.

CASE I.

i =incidence, wing chord to wind $+1^\circ$.

Velocity $V=79$ miles. $U=-115.5$ foot-seconds.
 $m=55.9$ slugs, $K_B^2=34$.

$$\begin{array}{lll} X_u-.128 & X_w+.162 & M_w+1.74 \\ Z_u-.557 & Z_w-3.95 & M_q-150 \end{array}$$

$$\begin{array}{l} A=+34 \\ B=+289 \\ C=+834 \\ D=+115 \\ E=+31 \end{array} \quad BCD - AD^2 - B^2E = +18 \times 10^6 \text{ stable.}$$

$$\text{Short oscillation: } \lambda^2 + 8.5\lambda + 24.5 = 0$$

$$\lambda = -4.25 \pm 2.54i$$

$$p = \text{period} = \frac{2\pi}{2.54} = 2.5 \text{ seconds.}$$

$$t = \text{time to damp 50 per cent} = \frac{0.69}{4.25} = .16 \text{ second.}$$

$$\text{Long oscillation: } \lambda^2 + .125\lambda + .0374 = 0$$

$$\lambda = -.063 \pm .183i$$

$$p = 34.3 \text{ seconds, } t = 10.8 \text{ seconds.}$$

The short oscillations are unimportant. The long oscillations are easy and strongly damped. The aeroplane should be very steady at this speed.

CASE II.

$$i = 7^\circ, V = 51.8 \text{ miles, } U = -75.9 \text{ foot-seconds.}$$

$$\begin{array}{lll} X_u - .121 & X_w + .113 & M_w + 2.45 \\ Z_u - .849 & Z_w - 2.26 & M_q - 113 \end{array}$$

$$\left. \begin{array}{l} A = + 34.0 \\ B = + 194.0 \\ C = + 467.0 \\ D = + 64.3 \\ E = + 67.0 \end{array} \right\} BCD - AD^2 - B^2E = +32 \times 10^5 \text{ stable.}$$

$$\text{Short oscillation: } \lambda^2 + 5.7\lambda + 15.9 = 0$$

$$\lambda = -2.85 \pm 2.33i$$

$$p = 2.7 \text{ seconds}$$

$$t = .24 \text{ second to damp 50 per cent.}$$

$$\text{Long oscillation: } \lambda^2 + .078\lambda + .143 = 0$$

$$\lambda = -.039 \pm .377i$$

$$p = 16.7 \text{ seconds}$$

$$t = 17.7 \text{ seconds to damp 50 per cent.}$$

The period is shorter than at high speed and the damping less. The aeroplane should therefore be less comfortable.

CASE III.

$$i = 10^\circ, V = 47 \text{ miles, } U = -68.8 \text{ foot-seconds.}$$

$$\begin{array}{lll} X_u - .151 & Z_u - .936 & M_w + 2.50 \\ X_w - .075 & Z_w - 1.46 & M_q - 108 \end{array}$$

$$\left. \begin{array}{l} A = + 34 \\ B = + 165 \\ C = + 355 \\ D = + 42.5 \\ E = + 75.3 \end{array} \right\} BCD - (AD^2 + B^2E) = 3.8 \times 10^5 \text{ stable.}$$

$$\text{Short oscillation: } \lambda^2 + 4.85\lambda + 10.44 = 0$$

$$\lambda = -2.42 \pm 2.12i$$

$$p = 2.96 \text{ seconds.}$$

$$t = .28 \text{ second to damp 50 per cent.}$$

$$\text{Long oscillation: } \lambda^2 + .021\lambda + .212 = 0$$

$$\lambda = -.011 \pm .460i$$

$$p = 13.71 \text{ seconds.}$$

$$t = 62.7 \text{ seconds to damp 50 per cent.}$$

This oscillation is rapid and but slightly damped, and would probably be uncomfortable. The stability is slight and wind gusts or external disturbances, if recurrent, might cause trouble.

CASE IV.

$i=12^\circ$, $V=45.2$ miles $U=-66.2$ foot-seconds.

$$\begin{array}{lll} X_u-.189 & Z_u-.972 & M_w+2.15 \\ X_w-.236 & Z_w-.736 & M_q-106 \end{array}$$

$$\left. \begin{array}{l} A=+34 \\ B=+137.5 \\ C=+243 \\ D=+17.4 \\ E=+67.2 \end{array} \right\} BCD-AD^2-B^2E=-7 \times 10^5 \text{ UNSTABLE.}$$

Short oscillation: $\lambda^2 + 4.04\lambda + 7.14 = 0$
 $\lambda = -2.02 \pm 1.75i$

$p=3.59$ seconds.
 $t = .342$ second to damp 50 per cent.

Long oscillation: $\lambda^2 - .985\lambda - .276 = 0$
 $\lambda = +.043 \pm .524i$

$p=12.0$ seconds.
 $t = 16.0$ seconds to double amplitude.

The machine is frankly unstable and the pilot dare not release his elevator control.

CASE V.

$i=14^\circ$, $V=44.2$ miles, $U=-64.8$ foot-seconds.

$$\begin{array}{lll} X_u-.223 & Z_u-.993 & M_w+1.99 \\ X_w-.132 & Z_w-.553 & M_q-106 \end{array}$$

$$\left. \begin{array}{l} A=+34 \\ B=+134 \\ C=+213 \\ D=+28 \\ E=+63.6 \end{array} \right\} BCD-AD^2-B^2E=-3.7 \times 10^5 \text{ UNSTABLE.}$$

CASE VI.

$i=15.5^\circ$ $V=43.7$ miles, $U=-63.8$ foot-seconds.

$$\begin{array}{lll} X_u-.276 & Z_u-1.01 & M_w+2.02 \\ X_w-.292 & Z_w-.673 & M_q-106 \end{array}$$

$$\left. \begin{array}{l} A=+34 \\ B=+138 \\ C=+226 \\ D=+24.2 \\ E=+65.7 \end{array} \right\} BCD-AD^2-B^2E=-5 \times 10^5 \text{ UNSTABLE.}$$

Short oscillation: $\lambda^2 + 4.06\lambda + 6.65 = 0$
 $\lambda = -2.03 \pm 1.59i$

$p=3.95$ seconds, period.
 $t = .34$ seconds to damp 50 per cent.

Long oscillation: $\lambda^2 + .071\lambda + .291 = 0$
 $\lambda = +.0358 \pm .541i$

Real part of λ is here positive, indicating an oscillation increasing with time.

$$p = \frac{2\pi}{.541} = 11.6 \text{ seconds.}$$

$$t = \frac{.069}{.0358} = 19.3 \text{ seconds to double amplitude.}$$

The motion is both rapid in period and rapidly increasing in amplitude. Indeed the amplitude is doubled in two swings. This aeroplane, if left to itself, would be highly unstable.

ARTICLE 14.

VARIATION OF LONGITUDINAL STABILITY WITH SPEED.

Preliminary to consideration of the action of gusts on an inherently stable aeroplane, it was desired to analyze the motion in still air of a machine which could be called inherently stable longitudinally. It has been found above that a typical aeroplane becomes less stable at low speeds until real instability results. This result is somewhat unexpected in view of the curves of pitching moment M , which indicated static stability at all possible attitudes up to and including horizontal flight at $+15^\circ.5$. In other words, M_w is positive for all cases. The instability comes about on account of the rapid rate of increase of drift at large angles causing X_w to change sign, and on account of the less rapid rate of increase of lift, causing Z_w to become small at high angles of pitch. Furthermore, M_q diminishes at low speed.

From the speed power curves on figure 3, it appears that for angles greater than 10° , we are on the part of the power curve which requires more power to go slower, "region of reversed controls." This region is now found to be dynamically unstable so that controlled flight only is possible here. But with reversed controls this is doubly dangerous.

The frequency of accidents at low speeds, following the recent demand for a wide speed range, confirms this impression of the danger of low speeds when approaching a critical angle and speed. The critical angle for instability is clearly an angle less than the possible maximum for flight.

A fair measure of the relative stability at various speeds may be had by noting the following tabulation of the values of Routh's discriminant, denoted by R :

Velocity in miles.	Wind chord to wind.	R .
79.0	1°	$+180 \times 10^5$
51.8	7°	$+32 \times 10^5$
47.0	10°	$+3.8 \times 10^5$
45.2	12°	-7×10^5
44.2	14°	-3.7×10^5
43.7	15.5°	-5×10^5

The table is reproduced graphically on figure 12.

A similar investigation for lateral stability fails to show any marked change with speed, as would be expected since speed depends on pitch angle and the factors which make or unmake lateral stability are but slightly affected by angle of pitch.

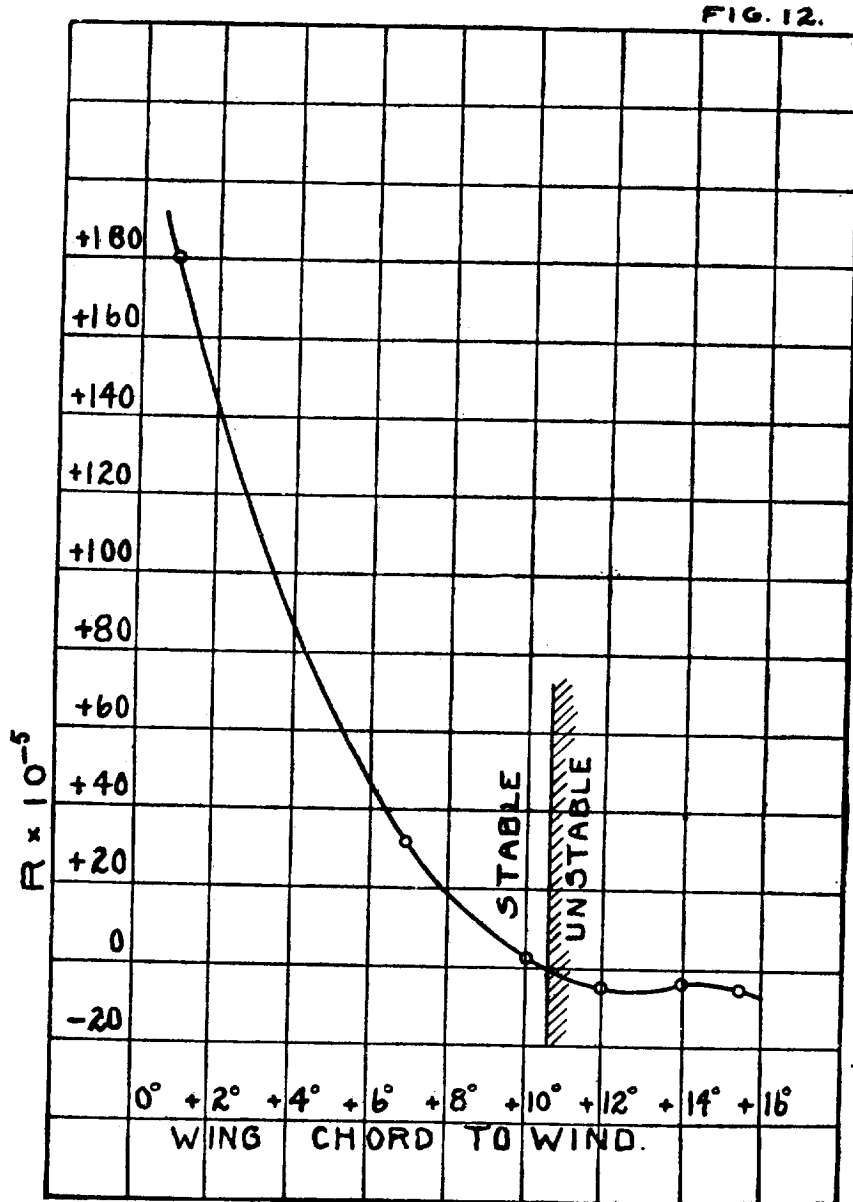

ROUTH'S DISCRIMINANT,
VARIATION WITH ATTITUDE.

REPORT No. 1.

PART 2.

THEORY OF AN AEROPLANE ENCOUNTERING GUSTS.

By EDWIN BIDWELL WILSON.

ARTICLE 1.

INTRODUCTION.

The notation here used will be in the main that of Bairstow. (Technical Report of the Committee for Aeronautics for the Year 1912-13, p. 143.) As, however, Bairstow changes his notation in the first few pages of his report, we shall begin at the start with some departures from him.

If x, y, z are moving axes directed, respectively, backward, to the left, and upward relative to the driver; if u', v', w' be linear velocities, and p', q', r' be angular velocities, resolved along these axes; and if X', Y', Z' be forces, and L', M', N' be moments of forces (measured per unit mass of the aeroplane); then the dynamical equations of motion are

$$du'/dt + w'q' - v'r' = X', \quad (1a)$$

$$dv'/dt + u'r' - w'p' = Y', \quad (1b)$$

$$dw'/dt + v'p' - u'q' = Z', \quad (1c)$$

$$dh_1/dt - r'h_2 + q'h_3 = mL', \quad (2a)$$

$$dh_2/dt - p'h_3 + r'h_1 = m M', \quad (2b)$$

$$dh_3/dt - q'h_1 + p'h_2 = m N', \quad (2c)$$

where m is the mass and

$$h_1 = p'A - q'F - r'E, \quad (3a)$$

$$h_2 = q'B - r'D - p'F, \quad (3b)$$

$$h_3 = r'C - p'E - q'D, \quad (3c)$$

are the components of angular momentum,—the quantities A, B, C being the moments and D, E, F the products of inertia relative to the moving axes fixed in the body.

The symmetric aeroplane will alone be considered here;

$$D = F = 0. \quad (4)$$

If the machine is in uniform horizontal flight, all the forces, moments, linear velocities and angular velocities except u' vanish, and $u' = U$, a negative quantity in magnitude equal to the uniform velocity. (The precise backward direction of the x -axis is that which is horizontal in uniform flight, and hence by this definition the direction of this axis, and of the z -axis, varies in the aeroplane with the speed.)

If the motion is slightly disturbed, the velocities take the values

$$u' = U + u, v' = v, w' = w, p' = p, q' = q, r' = r, \quad (5)$$

where u, v, w, p, q, r are small. The products of these small quantities are neglected, as in all discussions of small oscillations, and the equations take the form

$$du/dt = X', \quad dv/dt + Ur = Y', \quad dw/dt - Uq = Z', \quad (6)$$

$$Adp/dt - Edr/dt = mL', \quad Bdq/dt = mM', \quad Cdr/dt - Edp/dt = mN'. \quad (7)$$

In uniform motion the forces and moments all vanish. For the disturbed motion they are small and may be expressed linearly in terms of u, v, w, p, q, r . The forces are due to three sources: 1° the propeller thrust, 2° gravity, 3° the air. We shall assume that the propeller thrust (and moment, if any, arising from it) is constant; i. e., the motor is supposed to speed up or slow down under changed conditions so as to deliver a constant thrust. If θ and φ are the small pitch and roll, the components of gravity are $g\theta, -g\varphi, -g$ (see Bairstow, 144, $7u - w$), and its moments are zero because the C. G. is taken as origin. The air forces and moments may be written as X, Y, Z, L, M, N and developed as

$$X = X_0 + X_u u + X_v v + X_w w + X_p p + X_q q + X_r r, \quad (8)$$

where X_u, X_v, \dots are the "resistance derivatives" taken for the relative velocity of machine and wind. (X_0 and the propeller thrust cancel, so do Z_0 and g ; Y_0, L_0, M_0, N_0 vanish.)

In the symmetric aeroplane half the resistance derivatives vanish and the six equations of motion separate into two sets of three each, one set for the longitudinal, the other for the transverse motion. These equations are (Bairstow, 148, 13 and 14 with $\theta = 0$) for longitudinal motion,

$$du/dt = g\theta + X_u u + X_w w + X_q q, \quad (9a) \text{ see } (1a)$$

$$dw/dt = Uq + Z_u u + Z_w w + Z_q q, \quad (9b) \text{ see } (1c)$$

$$B/m \cdot dq/dt = M_u u + M_w w + M_q q, \quad (9c) \text{ see } (2b)$$

and, for transverse motion,

$$dv/dt = -g\varphi - Ur + Y_v v + Y_p p + Y_r r, \quad (10a) \text{ see } (1b)$$

$$A/m \cdot dp/dt - E/m \cdot dr/dt = L_v v + L_p p + L_r r, \quad (10b) \text{ see } (2a)$$

$$C/m \cdot dr/dt - E/m \cdot dp/dt = N_v v + N_p p + N_r r. \quad (10c) \text{ see } (2c)$$

The integration of these equations gives the free oscillations of the aeroplane.

ARTICLE 2.

LONGITUDINAL MOTION IN SMALL GUSTS.

A gust if not too severe may be treated by the method of forced oscillations. If the aeroplane is traveling on an irregular wind, we may regard the average wind velocity relative to the machine as that which should be used in the computation of the resistance derivatives, and we may regard the departures of the actual relative velocity from the mean as small quantities inducing additional forces into the equations of motion.

Suppose first a head-on gustiness. This would introduce an extra term of the form $X_u u$ into the first equation, $Z_u u$ in the second, and so on. If, as a result of the gust, the machine tilted appreciably, the originally head-on gust would no longer be head-on, but would have components u_1, w_1 and give rise to the term $X_u u_1 + X_w w_1$ in the first equation. It is clear, however, that under the hypothesis of small oscillations, w_1 would remain small of the second order relative to u_1 . The term $X_w w_1$ could then be neglected relative to $X_u u_1$, unless X_w much exceeded X_u .

We should in general allow a gust to have components $u_1, v_1, w_1, p_1, q_1, r_1$ relative to the axes. This would take into account any possible rotational motion in the gust. The rotational motion of a gust may be quite small. In the discussion by Glazebrook (Aeronautical Journal, July, 1914, pp. 272-301) nothing is accomplished relative to rotational gusts. Yet it may well be that the rotational element is of great importance. For the rotary derivatives, in the case of the machine whose derivatives are tabulated by Bairstow (loc. cit., 159), are large. Thus a term $M_q q_1 = -210q_1$ would be comparable with $X_u u_1 = -0.14u_1$ if q_1 were 1/700 of u_1 ; i. e., if the gust were a uniform whirl of radius 700 feet. In the same way L_p is large. In the machine that will be discussed in what follows M_q is also large, viz., -150.

The equations for the longitudinal motion in a general gust are (see 9a-c)

$$du/dt - g\theta - X_u u - X_w w - X_q q = X_u u_1 + X_w w_1 + X_q q_1. \quad (11a)$$

$$dv/dt - Uq - Z_u u - Z_w w - Z_q q = Z_u u_1 + Z_w w_1 + Z_q q_1. \quad (11b)$$

$$B/m \cdot dq/dt - M_u u - M_w w - M_q q = M_u u_1 + M_w w_1 + M_q q_1. \quad (11c)$$

The solution of these equations consists of two parts: 1° the so-called complementary function which gives the natural oscillations, 2° the particular integral which gives the forced oscillations due to the gust. To effect a solution for the particular integral, we must

make some assumption as to the value of the components u_1, w_1, q_1 of the gusts as functions of the time. Before making such an assumption for the particular integral, the solution by the "operational" method may be indicated. (See Wilson, Advanced Calculus, p. 223.)

Let D denote differentiation. The equations may be written

$$(D - X_u)u - X_w w - (X_q D + g)\theta = X_u u_1 + X_w w_1 + X_q q_1, \quad (12a)$$

$$-Z_u u + (D - Z_w)w - (Z_q + U)D\theta = Z_u u_1 + Z_w w_1 + Z_q q_1, \quad (12b)$$

$$-M_u u - M_w w + (k^2_B D^2 - M_q D)\theta = M_u u_1 + M_w w_1 + M_q q_1, \quad (12c)$$

where $k^2_B = B/m$. These equations are solved algebraically by multiplying by the proper cofactor determinants and adding. Then

$$\begin{aligned} D \begin{vmatrix} -X_u & -X_w & -(X_q D + g) \\ -Z_u & D - Z_w & -(Z_q + U)D \\ -M_u & -M_w & k^2_B D^2 - M_q D \end{vmatrix} u = & \begin{vmatrix} X_u & -X_w & -(X_q D + g) \\ Z_u D - Z_w & -(Z_q + U)D \\ M_u & -M_w & k^2_B D^2 - M_q D \end{vmatrix} u_1 \\ & + \begin{vmatrix} X_w & -X_w & -(X_q D + g) \\ Z_w D - Z_w & -(Z_q + U)D \\ M_w & -M_w & k^2_B D^2 - M_q D \end{vmatrix} w_1 \quad (13) \\ & + \begin{vmatrix} X_q & -X_w & -(X_q D + g) \\ Z_q D - Z_w & -(Z_q + U)D \\ M_q & -M_w & k^2_B D^2 - M_q D \end{vmatrix} q_1 \end{aligned}$$

or, if the determinant on the left be denoted by Δ ,

$$\begin{aligned} \Delta u = & \begin{vmatrix} X_u & -X_w & -(X_q D + g) \\ Z_u D - Z_w & -(Z_q + U)D \\ M_u & -M_w & k^2_B D^2 - M_q D \end{vmatrix} u_1 \quad (14a) \\ & + D \begin{vmatrix} X_w & -X_w & -(X_q D + g) \\ M_w & k^2_B D^2 - M_q D \end{vmatrix} w_1 + \begin{vmatrix} X_q & -X_w & -g \\ Z_q D - Z_w & -UD \\ M_q & -M_w & k^2_B D^2 \end{vmatrix} q_1. \end{aligned}$$

There are similar equations for w and θ , namely,

$$\Delta w = \begin{vmatrix} D - X_u & X_w & -(X_q D + g) \\ -Z_u & Z_w & -(Z_q + U)D \\ -M_u & M_w & k^2_B D^2 - M_q D \end{vmatrix} w_1 \quad (14b)$$

$$+ D \begin{vmatrix} Z_u & -(Z_q + U)D \\ M_u & k^2_B D^2 - M_q D \end{vmatrix} u_1 + \begin{vmatrix} D - X_u & X_q & -g \\ -Z_u & Z_q & -UD \\ -M_u & M_q & k^2_B D^2 \end{vmatrix} q_1,$$

$$\Delta \theta = \begin{vmatrix} D - X_u & -X_w & X_q \\ -Z_u & D - Z_w & Z_q \\ -M_u & -M_w & M_q \end{vmatrix} q_1 \quad (14c)$$

$$+ D \begin{vmatrix} D - Z_w & Z_u \\ -M_w & M_u \end{vmatrix} u_1 + D \begin{vmatrix} D - X_u & X_w \\ -M_u & M_w \end{vmatrix} w_1.$$

The general (literal) integration of these equations would be so complicated as to be useless. We shall make use of the formulas only after simplification by the insertion of numerical data.

Possible methods of treating gusts.—The only treatment of gusts which I have seen is that described somewhat popularly by Glazebrook (loc. cit.). He seems to state, as the main method of attack, that of small differences whereby it is assumed that the involved time over which the motion is to be studied is divided into small parts, and that the atmospheric conditions remain constant during each of these parts. By then regarding the differential equations of motion as equations in differences of the following form,

$$\Delta v' = (X' - w'q' + v'r')\Delta t, \text{ etc.},$$

$$\Delta h_1 = (mL' + r'h_2 - q'h_3)\Delta t, \text{ etc.},$$

it is possible to compute, through a series of intervals Δt , the approximate positions of the aeroplane. This method is, as Glazebrook states, exceedingly tedious, for Δt must be taken very small, indeed only a small part of a second in the case of a sharp gust, in order that the solution may be even approximately satisfactory for the differential equations. Moreover, the whole calculation apparently has to be done from the beginning for each new type of gust which one desires to study. The method, however, is applicable in all generality irrespective of the stability of the aeroplane.

The reason that I have chosen to operate on the basis of small oscillations is that after a certain amount of preliminary calculation has been accomplished my formulas will enable me to treat very rapidly a series of very different types of gusts. My method is not applicable, of course, to machines which are not stable, for the oscillations could not remain small with such machines, but it is probably doubtful whether the motion of the unstable aeroplane in a gusty wind is of very great importance, as the instability of the machine is not unlikely to cause indeterminately violent motions on relatively small gusts. I have tried to devise methods which would enable me to use graphical apparatus for obtaining the solutions here desired, but have been unable to throw the equations into a form which lends itself to such methods.

Moreover, the coefficients which enter into the equations and into the solutions at all stages of the work are of such varying magnitudes that it is difficult to obtain any reasonably accurate results. It seems impossible—I have not yet succeeded in avoiding the difficulty—to eliminate the occasional necessity of subtracting numbers which are nearly equal in magnitude; thus the accuracy of the figures is, after subtraction, seriously impaired. As I was aware that the data furnished me were probably not accurate to three figures, I first made the calculations with slide-rule accuracy, only to find that the final results became wholly illusory, owing to the difficulty just mentioned. I have therefore had to recompute everything with 4-place logarithm tables. Most of the figures which occur in the work are therefore 4-place numbers. Those which appear to have only three significant figures generally have the fourth figure zero when occurring in formulas containing 4-place numbers. In the calculations toward the end of the research the 4-figure accuracy has become reduced to three or two figure accuracy, but it did not seem best systematically to reduce the numbers by the omission of two figures, although this reduction has occasionally been made in final calculations.

ARTICLE 3.

NUMERICAL EQUATIONS FOR HIGH SPEED.

The data for high speed are (see Hunsaker, p. 47):

$$\begin{aligned} X_u &= -0.128, & X_w &= +0.162, & X_q &= 0 \\ Z_u &= -0.557, & Z_w &= -3.95, & Z_q &= 0 \\ M_u &= 0, & M_w &= +1.74, & M_q &= -150 \\ B/m = k^2_B &= 34, & U &= -115.5, & g &= 32.17 \end{aligned} \quad (15)$$

The cofactors δ in the determinant Δ are—

$$\begin{aligned} \begin{vmatrix} D - Z_w & -(Z_q + U)D \\ -M_w & k^2_B D^2 - M_q D \end{vmatrix} &= \begin{vmatrix} D + 3.95 & 115.5D \\ -1.74 & 34D^2 + 150D \end{vmatrix} \\ &= 34D^3 + 284.3D^2 + 793.5D = \delta_{11} \\ \begin{vmatrix} -M_w & k^2_B D^2 - M_q D \\ -X_w & -(X_q D + g) \end{vmatrix} &= \begin{vmatrix} -1.74 & 34D^2 + 150D \\ -0.162 & -32.17 \end{vmatrix} \\ &= 5.508D^2 + 24.30D + 55.98 = \delta_{21} \\ \begin{vmatrix} -X_w & -(X_q D + g) \\ D - Z_w & -(Z_q + U)D \end{vmatrix} &= \begin{vmatrix} -0.162 & -32.17 \\ D + 3.95 & 115.5D \end{vmatrix} \\ &= 13.46D + 127.1 = \delta_{31} \\ \begin{vmatrix} -(Z_q + U)D & -Z_u \\ k^2_B D^2 - M_q D & -M_u \end{vmatrix} &= \begin{vmatrix} 115.5D & 0.557 \\ 34D^2 + 150D & 0 \end{vmatrix} \\ &= -18.94D^2 - 83.56D = \delta_{12} \\ \begin{vmatrix} D - X_u & -(X_q D + g) \\ -M_u & k^2_B D^2 - M_q \end{vmatrix} &= \begin{vmatrix} D + 0.128 & -32.17 \\ 0 & 34D^2 + 150D \end{vmatrix} \\ &= 34D^3 + 154.3D^2 + 19.20D = \delta_{22} \\ \begin{vmatrix} -(X_q D + g) & D - X_u \\ -(Z_q + U)D & -Z_u \end{vmatrix} &= \begin{vmatrix} -32.17 & D + 0.128 \\ 115.5D & 0.557 \end{vmatrix} \\ &= -115.5D^2 - 14.78D - 17.92 = \delta_{32} \\ \begin{vmatrix} -Z_u & D - Z_w \\ -M_u & -M_w \end{vmatrix} &= \begin{vmatrix} -0.557 & D + 3.95 \\ 0 & -1.74 \end{vmatrix} \\ &= -0.9692 = \delta_{13} \\ \begin{vmatrix} -X_w & D - X_u \\ -M_w & -M_u \end{vmatrix} &= \begin{vmatrix} -0.162 & D + 0.128 \\ -1.74 & 0 \end{vmatrix} \\ &= 1.74D + .2227 = \delta_{23} \\ \begin{vmatrix} D - X_u & -X_w \\ -Z_u & D - Z_w \end{vmatrix} &= \begin{vmatrix} D + 0.128 & -0.162 \\ 0.557 & D + 3.95 \end{vmatrix} \\ &= D^2 + 4.078D + .5957 = \delta_{33} \end{aligned}$$

The value of the determinant Δ is

$$\begin{aligned} 34D + 288.7D^3 + 833.0D^2 + 115.1D + 31.18 = \\ 34(D^4 + 8.490D^3 + 24.50D^2 + 3.385D + 0.9170). \end{aligned}$$

(The value of the determinant checks by three calculations.)
The roots of the equation

$$f(D) = D^4 + 8.49D^3 + 24.5D^2 + 3.385D + 0.917 = 0 \quad (16)$$

determine the decrements and periods of the natural oscillations, and must be found. (Unfortunately these roots must be found with considerable accuracy, and the rough first approximations, such as are indicated by Bairstow, seem insufficient for our use.) Let it be assumed that one root is so large that it may be found approximately from

$$D^4 + 8.49D^3 + 24.5D^2 = D^2 + 8.49D + 24.5 = 0.$$

Then $D = -4.245 \pm 2.545i$.

If now r be an approximate solution of $f(D) = 0$, a new approximation may be had by assuming $r + x$, with x small, as a root.

Then

$$x = -\frac{f(r)}{f'(r)} = -\frac{r^4 + 8.49r^3 + 24.5r + 3.385r + 0.917}{4r^3 + 25.47r^2 + 49r + 3.385}$$

approximately. As $r^2 + 8.49r + 24.5 = 0$, the fraction simplifies to

$$x = -\frac{3.385r + 0.917}{23.08r + 211.4} = .063 + .107i,$$

if $r = -4.245 - 2.545i$. This root of $f(D) = 0$ is therefore

$$D = -4.182 \pm 2.438i.$$

The factor of $f(D)$ corresponding to this pair of roots is

$$D^2 + 8.364D + 23.43. \quad (17a)$$

Let the other factor be $D^2 + aD + b$. Then $23.43b = 0.917$ and $b = .03914$. Also, $8.364(.0391) + 23.43a = 3.385$ or $23.43a = 3.058$ and $a = .1305$. Hence the second factor is

$$D^2 + .1305D + .03914. \quad (17b)$$

As a check on the work we may multiply the two factors together; we find

$$(D^2 + 8.364D + 23.43)(D^2 + .1305D + .03914) = D^4 + 8.494D^3 + 24.56D^2 + 3.385D + .9170.$$

We can find, merely by careful trial, better factors as

$$(D^2 + 8.359D + 23.37)(D^2 + .1308D + .03924) = D^4 + 8.490D^3 + 24.50D^2 + 3.385D + .9170. \quad (18)$$

The definitive roots of $f(D) = \Delta = 0$ may therefore be taken as

$$\begin{aligned} a &= -4.180 - 2.430i, & b &= -4.180 + 2.430i \\ c &= -.0654 - .1870i, & d &= -.0654 + .1870i \end{aligned} \quad (19)$$

ARTICLE 4.

INTEGRATION FOR HIGH SPEED.

The numerical equation for u is (see 14a):

$$\begin{aligned} 34 (D^4 + 8.49 D^3 + 24.5 D^2 + 3.385 D + 0.917) u \\ = (X_u \delta_{11} + Z_u \delta_{21}) u_1 + D \delta_{22} w_1 + M_q \delta_{31} q_1 \\ = -34 (0.128 D^3 + 1.160 D^2 + 3.385 D + 0.917) u_1 \\ + 34 D (0.162 D^2 + 0.715 D + 1.647) w_1 \\ - 34 (59.37 D + 560.6) q_1. \end{aligned} \quad (20a)$$

The numerical equation for w is (see 14b):

$$\begin{aligned} 34 (D^4 + 8.49 D^3 + 24.5 D^2 + 3.385 D + 0.917) w \\ = (X_w \delta_{12} + Z_w \delta_{22} + M_w \delta_{32}) w_1 + D \delta_{12} u_1 + M_q \delta_{32} q_1 \\ = -34 (3.95 D^3 + 23.94 D^2 + 3.385 D + 0.917) w_1 \\ - 34 D^2 (0.557 D + 2.458) u_1 \\ + 34 (509.5 D^2 + 65.21 D + 79.05) q_1. \end{aligned} \quad (20b)$$

The numerical equation for θ is (see 14c):

$$\begin{aligned} 34 (D^4 + 8.49 D^3 + 24.5 D^2 + 3.385 D + 0.917) \theta \\ = M_q \delta_{33} q_1 + D \delta_{13} u_1 + D \delta_{23} w_1 \\ = 34 (4.412 D^2 + 17.99 D + 2.628) q_1 \\ - 34 (0.02851) D u_1 + 34 D (0.05117 D + .00655) w_1. \end{aligned} \quad (20c)$$

The solutions are of the type:

$$\begin{aligned} u &= C_{11} e^{at} + C_{12} e^{bt} + C_{13} e^{ct} + C_{14} e^{dt} + I_u, \\ w &= C_{21} e^{at} + C_{22} e^{bt} + C_{23} e^{ct} + C_{24} e^{dt} + I_w, \\ \theta &= C_{31} e^{at} + C_{32} e^{bt} + C_{33} e^{ct} + C_{34} e^{dt} + I_\theta, \end{aligned} \quad (21)$$

where a, b, c, d are the roots of the biquadratic (see 19), C_{ij} certain constants of integration, and I_u, I_w, I_θ a set of particular solutions of the equations. We shall determine I_u, I_w, I_θ in such a manner that they will not contain the functions e^{at} , etc.; we may therefore determine in advance the relations between the twelve C 's. (This will debar us from using as gusts u_1, w_1, q_1 , those which are of the form Ce^{at} , etc.; but this restriction is not important—such a damped gust tuned to the damping and period of the machine is highly improbable in nature.)

If we substitute u, w, θ in the equations (14), the particular solutions must cancel out among themselves (since they can not cancel terms of the form e^{at}) and leave

$$\begin{aligned} (a - X_u) C_{11} e^{at} - X_w C_{21} e^{at} - (X_q a + g) C_{31} e^{at} + \text{similar terms} = 0, \\ - Z_u C_{11} e^{at} + (a - Z_w) C_{21} e^{at} - (Z_q + U) a C_{31} e^{at} + \dots = 0, \\ - M_u C_{11} e^{at} - M_w C_{21} e^{at} + (k^2_b D^2 - M_q D) C_{31} e^{at} + \dots = 0. \end{aligned}$$

These equations hold identically in t , and the coefficient of e^{at} , etc., in each must vanish. The three homogeneous equations in the three unknowns C_{11} , C_{21} , C_{31} (or the similar equations in C_{12} , C_{22} , C_{32} ; C_{13} , C_{23} , C_{33} ; C_{14} , C_{24} , C_{34}) are consistent because a (or b , c , d) is a root of the determinant Δ , and the solutions are:

$$C_{11}: C_{21}: C_{31} = \begin{vmatrix} -X_w - g \\ a - Z_w - Ua \end{vmatrix} : \begin{vmatrix} -g & a - X_u \\ -Ua & -Z_u \end{vmatrix} : \begin{vmatrix} a - X_u & -X_w \\ -Z_u & a - Z_w \end{vmatrix},$$

with C_{12} : C_{22} : C_{32} determined by the same functions of b . In words: To obtain the ratios of the coefficients of e^{at} in u , v , w , substitute $D = a$ in the determinants δ_{31} , δ_{32} , δ_{33} . Or C_{12} : C_{21} : C_{31} as

$$13.46a + 127.1 : -115.5a^2 - 14.78a - 17.92 : a^2 + 4.078a + .5957$$

$$\text{or } C_{11}: C_{21}: C_{31} = 13.46a + 127.1 : 950.8a + 2560 : -4.281a - 22.81.$$

This gives C_{11} : C_{21} : C_{31} as

$$70.8 - 32.7i : -1414 - 2310i : -4.92 + 10.40i \text{ or as}$$

$$1 : -4.04 - 34.52i : -.1132 + .0946i.$$

The values of C_{12} : C_{22} : C_{32} are the conjugates

$$1 : -4.04 + 34.5i : -.1132 - .0946i.$$

To find C_{13} : C_{23} : C_{33} we must substitute $c = -.065 - .187i$ in the same determinants. Then

$$C_{13}: C_{23}: C_{33} = 13.46c + 127.1 : .33c - 13.39 : 3.947c + .5565. \text{ This gives}$$

C_{13} : C_{23} : C_{33} as

$$126.2 - 2.516i : -13.37 - .0623i : .2983 - .7380i$$

or

$$1 : -.1058 - .002587i : .002478 - .005799i.$$

The values of the conjugates are:

$$C_{14}: C_{24}: C_{34} = 1 : -.1058 + .002587i : .002478 + .005799i.$$

The general solutions of the equation of motion are:

$$u = C_{11}e^{at} + C_{12}e^{bt} + C_{13}e^{ct} + C_{14}e^{dt} + I_u, \quad (22a)$$

$$w = (-4.04 - 34.5i)C_{11}e^{at} + (-4.04 + 34.5i)C_{12}e^{bt} \\ + (-.1058 - .002587i)C_{13}e^{ct} + (-.1058 + .002587i)C_{14}e^{dt} + I_w, \quad (22b)$$

$$\theta = (-.1132 + .0946i)C_{11}e^{at} + (-.1132 - .0946i)C_{12}e^{bt} \\ + (.002478 - .005799i)C_{13}e^{ct} + (.002478 + .005799i)C_{14}e^{dt} + I_\theta. \quad (22c)$$

From these equations we see that the heavily damped short period oscillation (roots a , b) is about $34\frac{1}{2}$ times as strong in u as in w ; whereas the mildly damped long period oscillation (roots c , d) is about $9\frac{1}{2}$ times as effective in u as in w . Moreover, the short period motions in u and w are about quartered; but the long period motions are in opposite phase. The amplitude of the short period motion in θ is about $\frac{1}{2}\frac{1}{4}\sigma$ that of w ; hence for each foot-second of short oscillation in w there is about $\frac{1}{4}^\circ$ in θ . The amplitude of the long period motion in θ is about .006 of that in u ; hence for each foot-second of long oscillation in u there is about $\frac{1}{3}^\circ$ in θ . The damping of the short oscillation is so strong that the amplitude is reduced to about one-

ninetieth in one second where in the case of the long oscillation the reduction is only to about nine-tenths of its original value in one second; the relative amplitudes in the cases of u , w , θ are more important in the case of the long than in that of the short period oscillation because the latter is so quickly damped out that the swing may not get well started. However, the extreme magnitude of the short period oscillation in w as compared with u indicates the possibility of relatively violent accelerations in w ; indeed, it is the short period oscillation which may account for initial difficulties whereas the long period oscillation accounts for the progressive troubles, due to gusts.

There remain to be determined the values of the constants C of integration from the initial conditions of uniform flight, i. e., $u = w = \theta = q = 0$. Let the particular solutions have the initial values I_{u0} , I_{w0} , $I_{\theta0}$. Then

$$\begin{aligned} 0 &= C_{11} + C_{12} + C_{13} + C_{14} + I_{u0}, \\ 0 &= (-4.04 - 34.5i)C_{11} + (-4.04 + 34.5i)C_{12} \\ &\quad + (-.1058 - .002587i)C_{13} + (-.1058 + .002587i)C_{14} + I_{w0}, \\ 0 &= (-.1132 + .0946i)C_{11} + (-.1132 - .0946i)C_{12} \\ &\quad + (.002478 - .005799i)C_{13} + (.002478 + .005799i)C_{14} + I_{\theta0}, \\ 0 &= (-.1132 + .0946i)aC_{11} + (-.1132 - .0946i)bC_{12} \\ &\quad + (.002478 - .005799i)cC_{13} + (.002478 + .005799i)dC_{14} + I'_{\theta0}, \\ \text{or } 0 &= (.703 - .205i)C_{11} + (.703 + .205i)C_{12} + (-.001246 - .000084i)C_{13} \\ &\quad + (-.001246 + .000084i)C_{14} + I'_{\theta0}. \end{aligned}$$

The values of C_{11} , C_{12} and C_{13} , C_{14} are conjugate imaginaries; hence $C_{11} + C_{12} = A$, $C_{13} + C_{14} = B$, $i(C_{12} - C_{11}) = C$, $i(C_{14} - C_{13}) = D$ are real. The equations may therefore be written

$$\begin{aligned} 0 &= A + B + I_{u0} \\ 0 &= -4.04 A + 34.5 C - .1058 B + .002587 D + I_{w0} \\ 0 &= -.132 A - .0946 C + .002478 B + .005799 D + I_{\theta0} \\ 0 &= .703 A + .205 C - .001246 B + .000084 D + I'_{\theta0}. \end{aligned}$$

The values for A , B , C , D are (as found by determinants and checked by substitution):

$$\begin{aligned} A &= -.0008856 I_{u0} + .008198 I_{w0} + .01621 I_{\theta0} - 1.372 I'_{\theta0}, \\ C &= -.003196 I_{u0} - .02803 I_{w0} + .01476 I_{\theta0} - .1543 I'_{\theta0}, \\ B &= -(1 - .0008856)I_{u0} - .008198 I_{w0} - .01621 I_{\theta0} + 1.372 I'_{\theta0}, \\ D &= .3577 I_{u0} - .2940 I_{w0} - 172.0 I_{\theta0} - 29.89 I'_{\theta0}. \end{aligned} \quad (23)$$

The solutions (22) of the equations of motion of the aeroplane involve imaginary numbers from which they may be freed by using A , B , C , D in place of C_{11} , C_{12} , C_{13} , C_{14} . The equations then become

$$\begin{aligned} u &= e^{-4.18t} (A \cos 2.43t + C \sin 2.43t) \\ &\quad + e^{-.0654t} (B \cos .187t + D \sin .187t) + I_u, \\ w &= e^{-4.18t} [(34.5 C - 4.04 A) \cos 2.43t \\ &\quad - (34.5 A + 4.04 C) \sin 2.43t] \\ &\quad + e^{-.0654t} [(.002587 D - .1058 B) \cos .187t \\ &\quad - (.002587 B + .1058 D) \sin .187t] + I_w, \end{aligned}$$

$$\begin{aligned} \theta = e^{-4.18t} [&-.1132 A + .0946 C) \cos 2.43t \\ &+ (.0946 A - .1132 C) \sin 2.43t] \\ &+ e^{-.0654t} [(.00278 B + .005799 D) \cos .187t \\ &+ (.002478 D - .005799 B) \sin .187t] + I_{\theta}. \end{aligned}$$

These formulas enable us to study any particular gust we desire.

It is merely necessary to find the particular solutions, then the constants A, B, C, D . We shall reduce the coefficients in the parentheses. Then

$$u = e^{-4.18t} (A \cos 2.43t + C \sin 2.43t) + e^{-.0654t} (B \cos .187t + D \sin .187t) + I_u, \quad (24a)$$

$$w = e^{-4.18t} (A' \cos 2.43t + C' \sin 2.43t) + e^{-.0654t} (B' \cos .187t + D' \sin .187t) + I_w, \quad (24b)$$

$$\theta = e^{-4.18t} (A'' \cos 2.43t + C'' \sin 2.43t) + e^{-.0654t} (B'' \cos .187t + D'' \sin .187t) + I_{\theta}, \quad (24c)$$

where

$$\begin{aligned} A' &= -.1066 I_{u0} - 1.0001 I_{w0} + .4436 I_{\theta0} + .220 I'_{\theta0}, \\ C' &= .04346 I_{u0} - .1696 I_{w0} - .6190 I_{\theta0} + 47.93 I'_{\theta0}, \\ B' &= .1066 I_{u0} + .000107 I_{w0} - .4436 I_{\theta0} - .220 I'_{\theta0}, \\ D' &= -.03523 I_{u0} + .03112 I_{w0} + 18.20 I_{\theta0} + 3.158 I'_{\theta0}, \end{aligned} \quad (25)$$

$$\begin{aligned} A'' &= +.0004024 I_{u0} + .001724 I_{w0} - .003231 I_{\theta0} + .1698 I'_{\theta0}, \\ C'' &= +.0002778 I_{u0} - .003947 I_{w0} - .000136 I_{\theta0} - .1123 I'_{\theta0}, \\ B'' &= -.0004024 I_{u0} - .001724 I_{w0} - .99676 I_{\theta0} - .1698 I'_{\theta0}, \\ D'' &= .006683 I_{u0} - .000681 I_{w0} - .4261 I_{\theta0} - .08201 I'_{\theta0}. \end{aligned} \quad (26)$$

In any particular case the calculation of the coefficients in (24) from (23), (25), (26) is likely to be relatively simple because there are so many terms that for that case may be negligible.

ARTICLE 5.

SOME SPECIAL GUSTS.

If we wish to represent a gust which, starting from the condition of still air, increases to a certain intensity J we may use the function

$$J (1 - e^{-rt}). \quad (24)$$

The value of r determines the sharpness of the gust. If $r=1$, the gust has reached about two-thirds of its value in one second; if $r=5$, the gust has reached two-thirds of its value in one-fifth of a second; if $r=\frac{1}{5}$, the two-thirds intensity is reached in 5 seconds. We may perhaps regard $r=1$ as giving a moderately sharp gust, $r=5$ as giving a very sharp, and $r=\frac{1}{5}$ as giving a tolerably mild gust. The function (24) has the advantage of being in such form that the determination of the particular integrals is easy. (See Wilson's Advanced Calculus.)

CASE 1. *Head-on gust—mild.* $u_1 = J(1 - e^{-2t})$.

In equations (20) we let $u_1 = J(1 - e^{-2t})$, $w_1 = q_1 = 0$. Then

$$\begin{aligned} I_u &= -J(1 - .247 e^{-2t}), & I_{u_0} &= -.753J, \\ I_w &= .082J e^{-2t}, & I_{w_0} &= -.082J, \\ I_\theta &= -.00495J e^{-2t}, & I'_{\theta_0} &= -.0049J, \\ I'_\theta &= .00099J e^{-2t}, & I'_{\theta_0} &= .00099J. \end{aligned}$$

(N. B.—The total increase J of the wind occurs everywhere as a factor and may be omitted—the results then are for an increase of 1 foot-second.)

$$u = J e^{-.0654t} (.622 \cos .187t + .630 \sin .187t) - J(1 - .247 e^{-2t}),$$

$$w = J e^{-.418t} (-.004 \cos 2.43t + .003 \sin 2.43t) - J e^{-.0654t} (.078 \cos .187t + .059 \sin .187t) + .082J e^{-2t},$$

$$\theta = J e^{-.0654t} (.00495 \cos .187t - .0031 \sin .187t) - .00495J e^{-2t}.$$

It appears from these equations that the effect of a mild head-on gust of magnitude J is as follows: (1) The machine takes up an easy slowly damped oscillation in u of amplitude about 89 per cent of J ; after the oscillation dies out the machine is making a speed J less relative to the ground and hence the original speed relative to the wind. (2) There is a rapidly damped oscillation in w of rather small magnitude and a slowly damped one of about 10 per cent of J , the final condition being that of horizontal flight. (3) There is a slow oscillation in pitch of about .0058 J radians or about .32 J° . If the magnitude J is great, the pitching becomes so marked that the approximate method of solution can no longer be considered valid—a gust of 20 foot-seconds causing a pitch of some 6° . As the period is long (about one-half minute) the pilot should have ample time to correct the trouble before it produces serious consequences.

The result of a tail-on gust is the opposite of that of the head-on gust and therefore need not be treated separately. For the head-on gust J is negative; for a rear gust, positive.

To calculate the stresses on the machine or operator caused by the gust we have merely to find the accelerations du/dt and dw/dt of which the first is (approximately)—

$$du/dt = J e^{-.0654t} (.08 \cos .187t - .16 \sin .187t) - .05J e^{-2t}.$$

This acceleration reaches a maximum of something of the order of $J/10$; and if J should be 20 foot-seconds, the acceleration would be only about 2, or 6 per cent of g —not a large amount. The acceleration dw/dt is likewise small. (N. B.—The initial accelerations du/dt and dw/dt should vanish, because the gust starts from zero. That the initial values are not exactly zero in the above formulas is due to the roughness of the final calculations for u and w .)

The path of the machine varies from the horizontal by the amount

$$z = \int_0^t (w + 115.5\theta) dt$$

which accounts for the effect of the vertical velocity and of the climbing in the path. The result is (roughly)

$$z = J \int_0^t e^{-.0654t} (.5 \cos .187t - .4 \sin .187t) dt - .5e^{-.2t} dt,$$

$$z = J[e^{-.0654t}(\cos .187t + 3 \sin .187t) + 2.5e^{-.2t} - 3.5].$$

The motion is oscillatory approaching as a limit $z = -3.5 J$. The machine will rise 70 feet when the gust is 20 foot-seconds head-on.

CASE 2. *Up gust—mild.* $w_1 = J(1 - e^{-.2t})$.

$$\begin{aligned} I_u &= .305 J e^{-.2t}, & I_{u_0} &= .305 J, \\ I_w &= J(1 - 1.012e^{-.2t}), & I_{w_0} &= -.012 J, \\ I_\theta &= .000737 J e^{-.2t}, & I_{\theta_0} &= .000737 J, \\ I'_\theta &= -.000147 J e^{-.2t}, & I'_{\theta_0} &= -.000147 J. \end{aligned}$$

$$u = J e^{-.0654t} (-.305 \cos .187t - .0108 \sin .187t) + .305 J e^{-.2t},$$

$$w = J e^{-.18t} (-.02 \cos 2.43t + .026 \sin 2.43t) + J e^{-.0654t} (.032 \cos .187t + .002 \sin .187t) + J(1 - 1.012e^{-.2t}),$$

$$\theta = J e^{-.0654t} (.0008 \cos 187t + .0017 \sin .187t) + .00074e^{-.2t}.$$

The effect of the up gust is to set up a small long oscillation in u of magnitude about $0.3 J$, a very small oscillation in w , and a long oscillation of intensity $.0018 J$ radians or $.11 J^\circ$ in θ . The comparative effects on the velocity and angle in the case of head-on and up gusts show that the up gust is only about one-third as effective as the head-on gust. The accelerations in the case of the up gust are all small.

To find the displacement in a vertical direction we integrate as before.

$$z = \int_0^t (w + 115.5\theta) dt.$$

It is scarcely necessary to trouble with the trigonometric terms partly because the motion is less pronounced than in Case 1, partly because there is here the secular term Jt , which will carry the machine up with the gust and will be the chief effect after the lapse of a short time.

A down gust is in every way the opposite of an up gust and need not be separately treated.

CASE 3. *Rotary gust—mild.* $q_1 = J(1 - e^{-.2t})$.

$$\begin{aligned} I_u &= -J(610.6 - 475.5e^{-.2t}), & I_{u_0} &= -135.1 J, \\ I_w &= J(86.21 - 74.87e^{-.2t}), & I_{w_0} &= 11.34 J, \\ I_\theta &= J(2.865 + .691e^{-.2t}), & I_{\theta_0} &= 3.556 J. \end{aligned}$$

$$\begin{aligned}
I_{\dot{\theta}} &= -.138 J e^{-.2t}, & I_{\theta_0} &= -.138 J. \\
I_u &= J e^{-4.18t} (4.6 \cos 2.43t + .1875 \sin 2.43t) \\
&\quad + J e^{-.0654t} (134.7 \cos .187t - 659 \sin .187t) \\
&\quad - J (610.6 - 475.5 e^{-.2t}), \\
I_w &= J e^{-4.18t} (4.61 \cos 2.43t - 16.82 \sin 2.43t) \\
&\quad + J e^{-.0654t} (-15.95 \cos .187t + 70.08 \sin .187t) \\
&\quad + J (86.21 - 74.87 e^{-.2t}), \\
I_{\theta} &= J e^{-4.18t} (-.0698 \cos 2.43t + .0223 \sin 2.43t) \\
&\quad + J e^{-.0654t} (-3.487 \cos .187t - 2.414 \sin .187t) \\
&\quad + J (2.865 + .691 e^{-.2t}).
\end{aligned}$$

The effect of the rotary gust is a long oscillation in u (the short one is negligible) of magnitude about $670 J$, a short oscillation in w of about $17 J$ and a long one of about $71 J$, a long oscillation in θ of about $4.1 J$. The comparison with former cases may be made by supposing first that the oscillation in u may reach some 20 foot-seconds. Then $J = 1/33 = .03$. The amplitude of the oscillation in θ is then some 0.12 radians, which is an amount comparable with the 6° of Case 1. To get an idea of what $J = .03$ means, we may note that if a gust of 20 foot-seconds is due to a whirl of the air as a solid body with $q_1 = .03$, the radius of the whirl is 660 feet. We may therefore say that the effect of a whirl of radius 660 generating velocity of 20 foot-seconds is of itself about equal to that of a head-on velocity of that amount. If, however, a machine ran into such a whirl, it would experience both the effect of the whirl and of the linear velocity generated by it and would be disturbed considerably more than if it had encountered a pure head-on gust. We may therefore say that if the head-on gust arises from a whirl of materially less than 660-foot radius, the effect of the whirl is quite considerably larger than that due to a straight head-on gust of equal magnitude.

The conditions after enough time has elapsed to allow the exponential term to become small is

$$I_u = -610.6 J. \quad I_w = 86.2 J. \quad I_{\theta} = 2.865 J.$$

It is therefore seen that the machine takes up the head-on velocity, acquires a small upward velocity, and is inclined at an angle $2.865 J$ radians to the horizontal, these effects being due exclusively to the rotary motion of the air. The path in space could be obtained by integration, but (like the effects previously mentioned) would not be the true path if the rotary motion were accompanied by horizontal or vertical linear gusts. It seems therefore scarcely worth while to find the path.

The value that I attach to this theory of rotary gusts does not arise so much from the fact that such gusts seem nowhere to have been treated as from the revelation of the powerful effects of such gusts. When a machine is flying low it must expect to meet air which has been set in rotation by the friction of the wind against the ground, against buildings, or against trees. It seems certain that very material angular velocities might be set up and that these might (owing to their short radius) induce only moderate linear gusts. In such cases, if they can arise as assumed, the machine

might behave very much worse than could be foreseen when nothing is known of rotary gusts. It is not unlikely, however, that rotary gusts would be very irregular themselves and that, before the machine could feel the full effects of one, the gust might have disappeared. In the same way rotation could be generated at the interface between dark and light regions of air—indeed any sharp relative motion of the air is likely to contain rotation.

CASE 4. *Head-on gust—moderate.* $u_1 = J(1 - e^{-t})$.

$$I_u = -J(1 + .09876e^{-t}), \quad I_{u_0} = -1.09876 J,$$

$$I_w = .1307 J e^{-t}, \quad I_{w_0} = .1307 J,$$

$$I_\theta = -.00196 J e^{-t}, \quad I_{\theta_0} = -.00196 J,$$

$$I'_\theta = +.00196 J e^{-t}, \quad I'_{\theta_0} = +.00196 J.$$

$$u = J e^{-4.18t} (-.000676 \cos 2.43t - .000486 \sin 2.43t) \\ + J e^{-.0654t} (1.09944 \cos .187t - .1528 \sin .187t) \\ - J (1 + .09876e^{-t}),$$

$$w = J e^{-4.18t} (-.01405 \cos 2.43t + .02528 \sin 2.43t) \\ + J e^{-.0654t} (-.1159 \cos .187t + .01493 \sin .187t) \\ + .1307 J e^{-t},$$

$$\theta = J e^{-4.18t} (.0001207 \cos 2.43t - .00000895 \sin 2.43t) \\ + J e^{-.0654t} (.001838 \cos .187t - .006755 \sin .187t) \\ - .00196 J e^{-t}.$$

The short oscillation in u is negligible not only in regard to its magnitude but even as far as accelerations are concerned. Then

$$du/dt = J e^{-.0654t} (-.1 \cos .187t + .21 \sin .187t) + .1 J e^{-t}.$$

This is at most about $.25 J$, or 5 foot-seconds² if $J = 20$. The short oscillation in w is considerably smaller than the long, but when the coefficients -4.18 and 2.43 are brought in by differentiating to find dw/dt , whereas $-.0654$ and $.187$ are brought in by the long oscillation, it appears that the short oscillation is effective in determining the acceleration. Thus

$$dw/dt = J e^{-4.18t} (.12 \cos 2.43t - .07 \sin 2.43t) \\ + J e^{-.0654t} (.01 \cos .187t) - .13 J e^{-t}.$$

The amount of this acceleration is at most about $J/12$, one-third that in u ; the effect, however, is produced very quickly, in the first half second.

In integrating to find the path in a vertical plane we may neglect the short oscillation, because in this case we divide by -4.18 and 2.43 , whereas for the long oscillation we divide by $-.0654$ and $.187$. Then

$$z = \int_0^t (w + 115.5\theta) dt \\ = J \int_0^t [e^{-.0654t} (.106 \cos .187t - .765 \sin .187t) - .095e^{-t}] dt \\ = J e^{-.0654t} (2.3 \sin .187t + 3.5 \cos .187t) + .095 J e^{-t} - 3.6 J.$$

The final condition is a rise of $-3.6 J$, an amount which agrees with that in the case of the mild gust (Case 1) in as far as the rough calculation of that case permits us to judge.

CASE 5. *Up gust—moderate.* $w_1 = J(1 - e^{-t})$.

$$\begin{aligned} I_u &= .0773 J e^{-t}, & I_{u0} &= .0773 J, \\ I_w &= -J(1 - 1.205 e^{-t}), & I_{w0} &= .205 J, \\ I_\theta &= -.003069 J e^{-t}, & I_{\theta0} &= -.003069 J, \\ I'_\theta &= .003069 J e^{-t}, & I'_{\theta0} &= .003069 J. \end{aligned}$$

$$u = J e^{-4.18t} (-.002641 \cos 2.43t - .00651 \sin 2.43t) + J e^{-.0654t} (.07466 \cos .187t + .4034 \sin .187t) + .0773 J e^{-t},$$

$$w = J e^{-4.18t} (-.2139 \cos 2.43t + .1174 \sin 2.43t) + J e^{-.0654t} (.008943 \cos .187t - .02337 \sin .187t) - J(1 - 1.205 e^{-t}),$$

$$\theta = J e^{-4.18t} (.0009148 \cos 2.43t + .000487 \sin 2.43t) + J e^{-.0654t} (.002154 \cos .187t - .001432 \sin .187t) - .003069 J e^{-t}.$$

The short oscillation is negligible in u as far as concerns u itself. In calculating the acceleration du/dt the short oscillation is not negligible relative to the long; but the acceleration is small any way. The effect of an up gust J on u is about one-third the effect of an equal head-on gust (see Case 2).

The short oscillation is the main thing in w —its amplitude is about $J/4$, whereas the amplitude of the long oscillation is about $J/40$, or one-tenth as much. The acceleration dw/dt may therefore be calculated exclusively from the short oscillation; it is

$$dw/dt = J e^{-4.18t} (1.2 \cos 2.43t) - J(1 - e^{-t}).$$

This means values approximately as follows:

$$\begin{aligned} t &= 0, \quad \frac{1}{8}, \quad \frac{1}{4}, \quad \frac{1}{2}, \quad \frac{3}{4}, \\ \text{acc.} &= 0, \quad -.35 J, \quad -.6 J, \quad -.7 J, \quad -.6 J. \end{aligned}$$

If J should be 20 foot-seconds, the maximum acceleration would be about $g/2$, even a gust of 10 foot-seconds would produce an acceleration of $g/4$. Such accelerations coming upon the pilot in one-half a second might considerably surprise and disturb him. An addition of 25 to 50 per cent in the apparent weight of the machine could hardly strain it to an appreciable extent in view of the large factor of safety used in the design. (N. B.—For an up gust J is negative. For a down gust the operator would lose 25 to 50 per cent of his weight.)

The path of the machine in space is not of great importance in this case. The chief feature is the general drift of the machine with the current.

CASE 6. *Rotary gust—moderate.* $q_1 = J(1 - e^{-t})$.

As we know so little of the rotation in the atmosphere and as nothing particular of interest seems to be indicated for this case over and above what was found in Case 3, we shall not carry out the calculations.

CASE 7. *Head-on gust—sharp.* $u_1 = J(1 - e^{-5t})$.

$$\begin{aligned} I_u &= -J(1 + .01872 e^{-5t}), & I_{u_0} &= -1.01872 J, \\ I_w &= -.05102 J e^{-5t}, & I_{w_0} &= -.05102 J, \\ I_\theta &= -.0008896 J e^{-5t}, & I_{\theta_0} &= -.0008896 J, \\ I'_\theta &= .004448 J e^{-5t}, & I'_{\theta_0} &= .004448 J. \end{aligned}$$

$$\begin{aligned} u &= J e^{-4.18t} (-.005632 \cos 2.43t + .003986 \sin 2.43t) \\ &\quad + J e^{-.0654t} (1.02435 \cos .187t - .3294 \sin .187t) \\ &\quad - J(1 + .01872 e^{-5t}), \\ w &= J e^{-4.18t} (.1693 \cos 2.43t + .1782 \sin 2.43t) \\ &\quad + J e^{-.0654t} (-.1093 \cos .187t + .0322 \sin .187t) \\ &\quad - .05102 J e^{-5t}, \\ \theta &= J e^{-4.18t} (.00026 \cos 2.43t - .000984 \sin 2.43t) \\ &\quad + J e^{-.0654t} (.000628 \cos .187t - .006755 \sin .187t) \\ &\quad - .0008896 J e^{-5t}. \end{aligned}$$

Here again the short oscillation in u is insignificant. The long oscillation as in Case 4 has an amplitude a little in excess of J . The acceleration du/dt is small of the order $J/5$. The reason that a sharp head gust does not give a large value to du/dt is probably because the gust can blow through the machine; the acceleration is therefore not large except at the loops of the slow oscillation.

The short-period oscillation in w has now become stronger than the long oscillation and the acceleration dw/dt is mostly due to it and may be written

$$dw/dt = J e^{-4.18t} (-.25 \cos 2.43t - 1.13 \sin 2.43t) + .25 J e^{-5t}.$$

The value of the acceleration never gets large because it is damped out before the sine term gets effective—perhaps $-0.4 J$ would be about its maximum value. A sharp head-on gust is therefore about half as effective as a moderate up gust of the same intensity. Since up gusts are perhaps not likely to be as intense as head-on gusts, we might hazard a guess that sharp head-on gusts would inconvenience the pilot about as much as moderate up gusts.

The most important terms in the path in space are

$$z = J e^{-.0654t} (1.2 \sin .187t + 3.5 \cos .187t) - 3.5 J.$$

The total rise is again $-3.5 J$.

CASE 8. *Up gust—sharp.* $w_1 = J(1 - e^{-5t})$.

$$\begin{aligned} I_u &= .06621 J e^{-5t}, & I_{u_0} &= .06621 J, \\ I_w &= -J(1 - .5605 e^{-5t}), & I_{w_0} &= -.4395 J, \\ I_\theta &= -.00778 J e^{-5t}, & I_{\theta_0} &= -.00778 J, \\ I'_{\theta_0} &= .0389 J e^{-5t}, & I'_{\theta_0} &= .0389 J. \end{aligned}$$

$$\begin{aligned} u &= J e^{-4.18t} (-.05714 \cos 2.43t + .006 \sin 2.43t) \\ &\quad + J e^{-.0654t} (-.00907 \cos .187t + .3285 \sin .187t) \\ &\quad + .06621 J e^{-5t}, \\ w &= J e^{-4.18t} (.4378 \cos 2.43t + 1.947 \sin 2.43t) \\ &\quad + J e^{-.0654t} (.00181 \cos .187t - .03474 \sin .187t) \\ &\quad - J(1 - .5605 e^{-5t}), \end{aligned}$$

$$\begin{aligned}\theta = & J e^{-.418t} (.0059 \cos 2.43t - .0122 \sin 2.43t) \\ & + J e^{-.0654t} (.001883 \cos .187t + .0008667 \sin .187t) \\ & - .00778 J e^{-5t}.\end{aligned}$$

The oscillation in u is of long period, and the acceleration in u is small. The oscillation in w has a short-period term of great importance at the start, but except for this there is very little oscillation in w . The acceleration is

$$dw/dt = J e^{-.418t} (2.9 \cos 2.43t - 9.2 \sin 2.43t) - 2.8 J e^{-5t}.$$

(N. B.—The value of dw/dt when $t=0$ should be 0 instead of $J/10$. The failure to check seems due to multiplication of errors, which is unavoidable. The accuracy of the work in Case 8 and Case 5 appears reduced to two figures.) The acceleration is now very serious indeed; it is about $-9.2 J e^{-.418t} \sin 2.43t$, as the other two terms come near canceling. The maximum value occurs when $t=.217$, a little over one-fifth of a second, as is then about $-1.85 J$. If J should be as large as -18 foot-seconds, the acceleration would equal $g=32$. Clearly such a sharp gust if it existed would be very dangerous from the sudden forces it would bring into play. As the machine, however, would travel only about 24 feet during one-fifth second, it is reasonable to doubt whether in so short a distance so large a change in vertical air velocity could occur.

The path in space is found to be approximately

$$z = -1.2 J e^{-.418t} \cos 2.43t + 1.1 J e^{-.0654t} \cos .187t - .1 J e^{-5t} + .2 J - Jt.$$

The final effect is the general drift with the gust, less a lag of $J/5$.

ARTICLE 6.

THE CONSTRAINED AEROPLANE.

If an aeroplane is constrained to remain always horizontal by mechanism which does not otherwise alter the machine or its dynamical properties, the equations of motion in a gust may be found from our previous equations by setting $\theta = q = 0$. Then

$$\begin{aligned}(D - X_u) u - X_w w &= X_u u_1 + X_w w_1 + X_q q_1, \\ -Z_u u + (D - Z_w) w &= Z_u u_1 + Z_w w_1 + Z_q q_1, \\ -M_u u - M_w w &= M_u u_1 + M_w w_1 + M_q q_1 + F,\end{aligned}$$

where F is the effective force due to the constraint and is assumed to affect moments only, not components of horizontal or vertical force. The last equation merely determines F .

With the numerical data we find for high speed

$$\begin{aligned}(D + 128)u - .162w &= -.128u_1 + .162w_1, \\ .557u + (D + 3.95)w &= -.557u_1 - 3.95w_1, \\ F &= -.174(w + w_1) + 150q_1.\end{aligned}$$

The natural motion of the machine when slightly disturbed in steady air is found from

$$\Delta' = \begin{vmatrix} D + .128 & -.162 \\ .557 & D + 3.95 \end{vmatrix} = D^2 + 4.078D + .598 = 0.$$

The roots are

$$D = -2.039 \pm 1.887 = -3.926 \text{ or } -0.152.$$

We thus find the first result: The machine, when disturbed, does not execute a double damped oscillation, but has an aperiodic motion of the form

$$C_1 e^{-3.93t} + C_2 e^{-0.15t}.$$

The two damping factors -3.93 and -0.15 lie between the values -4.18 and $-.0654$ previously found.

The unconstrained machine was stable for the speeds 79, 51, and 47 mile-hours; unstable for 45.2 mile-hours and lower speeds. If we take the data for 47 mile-hours and use them for the constrained motion, we find

$$\Delta'' = \begin{vmatrix} D + .151 & .075 \\ .936 & D + 1.46 \end{vmatrix} = D^2 + 1.61 D + .150 = 0,$$

of which the roots are -1.51 and $+0.10$. The natural motion of the machine is therefore of the form

$$C_1 e^{-1.51t} + C_2 e^{.10t}.$$

The second factor indicates instability; the motion due to it increases instead of subsides and reaches 2.78 times its original value in 10 seconds. We thus find the second result: The machine, when constrained, becomes unstable at a higher speed than when free—it is to this extent a more dangerous machine.

We shall now return to the case of high speed and compute the effect of certain gusts on the constrained machine for comparison with the effect of the same gusts on the free machine. The general solutions are

$$\begin{aligned} u &= -.0426 C_1 e^{-3.93t} + C_2 e^{-.15t} + I_u, \\ w &= C_1 e^{-3.93t} - .147 C_2 e^{-.15t} + I_w, \\ C_1 &= -.148 I_{u0} - 1.006 I_{w0}, \\ C_2 &= -1.006 I_{u0} - .0429 I_{w0}, \\ \Delta' u &= -(1.28 D + .598) u_1 + .162 D w_1, \\ \Delta' w &= -(3.95 D + .598) w_1 - .557 D u_1. \end{aligned}$$

CASE 1. *Head-on gust—mild.* $u_1 = J (1 - e^{-.2t})$.

$$\begin{aligned} I_u &= -J (1 + 3.20 e^{-.2t}), & I_{u0} &= -4.20 J, \\ I_w &= .622 J e^{-.2t}, & I_{w0} &= .622 J, \\ u &= 4.19 J e^{-.15t} - J (1 + 3.19 e^{-.2t}), \\ w &= -.62 J e^{-.15t} + .62 J e^{-.2t}. \end{aligned}$$

The machine takes up the gust as before, of course. There is no oscillation. There is practically no acceleration in either u or w . The path in space is

$$z = J(4.1 e^{-.15t} - 3.1 e^{-.2t}) - J.$$

The total rise is only $-J$. In every way the motion in this case is easier in the constrained than in the free aeroplane.

CASE 2. *Up gust—mild.* $w_1 = J(1 - e^{-.2t})$.

$$\begin{aligned} I_u &= -.186 J e^{-.2t}, & I_{u0} &= -.186 J, \\ I_w &= -J(1 - 1.079 e^{-.2t}), & I_{w0} &= .079 J, \\ u &= .186 J e^{-.15t} - .186 J e^{-.2t}, \\ w &= -.052 J e^{-3.93t} - .027 J e^{-.15t} - J(1 - 1.079 e^{-.2t}). \end{aligned}$$

The motion is again exceedingly moderate in all respects.

CASE 3. *Rotary gusts.* These can have no effect except upon the constraining moment F .

CASE 4. *Head-on gust—moderate.* $u_1 = J(1 - e^{-t})$.

$$\begin{aligned} I_u &= -J(1 + .1895 e^{-t}), & I_{u0} &= -.1895 J, \\ I_w &= .2246 J e^{-t}, & I_{w0} &= .2246 J, \\ u &= .002 J e^{-3.93t} + 1.187 J e^{-.15t} - J(1 + .189 e^{-t}), \\ w &= -.05 J e^{-3.93t} - .174 J e^{-.15t} + .224 J e^{-t}, \\ du/dt &= -.008 J e^{-3.93t} - .180 J e^{-.15t} + 1.89 J e^{-t}, \\ dw/dt &= .197 J e^{-3.93t} + .027 J e^{-.15t} - .224 J e^{-t}, \\ z &= 1.16 J e^{-.15t} - .22 J e^{-t} - .94 J. \end{aligned}$$

The motion is again decidedly moderate.

CASE 5. *Up gust—moderate.* $w_1 = J(1 - e^{-t})$.

$$\begin{aligned} I_u &= -.0653 J e^{-t}, & I_{u0} &= -.0653 J, \\ I_w &= -J(1 - 1.350 e^{-t}), & I_{w0} &= .350 J, \\ u &= .0144 J e^{-3.93t} + .0507 J e^{-.15t} - .0653 J e^{-t}, \\ w &= -.343 J e^{-3.93t} - .007 J e^{-.15t} - J(1 - 1.350 e^{-t}), \\ dw/dt &= +1.35 J e^{-3.93t} - 1.35 J e^{-t}. \end{aligned}$$

The motion is easy except for the acceleration in w , which has a maximum when $t = .46$ and is then equal to about $-.62 J$. If the gust should have an intensity of 10 foot-seconds the maximum acceleration would be about $g/5$.

CASE 6. *Head-on gust—sharp.* $u_1 = J(1 - e^{-5t})$.

$$\begin{aligned} I_u &= -J(1 + .00795 e^{-5t}), & I_{u0} &= -1.008 J, \\ I_w &= -.5275 J e^{-5t}, & I_{w0} &= -.5275 J, \\ u &= -.029 J e^{-3.93t} + 1.037 J e^{-.15t} - J(1 + .008 e^{-5t}), \\ w &= .680 J e^{-3.93t} - .152 J e^{-.15t} - .528 J e^{-5t}, \\ dw/dt &= -2.67 J e^{-3.93t} + .02 J e^{-.15t} + 2.64 J e^{-5t}, \\ z &= -.173 J e^{-3.93t} + J e^{-.15t} + .103 J e^{-5t} - .93 J. \end{aligned}$$

The motion, including acceleration, is moderate.

CASE 7. *Up gust—sharp.* $w_1 = J(1 - e^{-5t})$.

$$I_u = .153 J e^{-5t}, \quad I_{u_0} = .153 J,$$

$$I_w = -J(1 + 3.628e^{-5t}), \quad I_{w_0} = -4.628 J,$$

$$u = -.197 J e^{-3.93t} + .044 J e^{-.15t} + .153 J e^{-5t},$$

$$w = 4.634 J e^{-3.93t} - .006 J e^{-.15t} - J(1 + 3.628 e^{-5t}).$$

$$dw/dt = -18.2 J e^{-3.9t} + 18.2 J e^{-5t},$$

$$z = -1.18 J e^{-3.93t} + .04 J e^{-.15t} + .73 J e^{-5t} + .41 J - Jt.$$

The acceleration dw/dt has a maximum when $t = 5/11$ when it is $1.44 J$. This is somewhat serious if J is 10 foot-seconds.

We may now calculate roughly the moment F necessary to produce the constraint.

$$F = -.174(w + w_1) + 150q_1.$$

The last term is effective only when the machine encounters rotating air and will be neglected here.

$$\text{CASE 1. } F = .11 J(e^{-.15t} - e^{-.2t}).$$

$$\text{CASE 2. } F = J(.009 e^{-3.93t} + .005 e^{-.15t} - .014 e^{-.2t}).$$

$$\text{CASE 4. } F = J(.009 e^{-3.93t} + .030 e^{-.15t} - .039 e^{-t}).$$

$$\text{CASE 5. } F = J(.06 e^{-3.93t} + .0012 e^{-.15t} - .0612 e^{-t}).$$

$$\text{CASE 6. } F = J(-.119 e^{-3.93t} + .0266 e^{-.15t} + .0924 e^{-5t}).$$

$$\text{CASE 7. } F = .811 J(-e^{-3.93t} + e^{-5t}).$$

SUMMARY.

I have indicated the general method, based on the theory of small oscillations, whereby the equations of motion of a stable aeroplane, whether free or constrained to fly without pitch, whether in steady or gusty air, may be completely integrated in such form that, after a certain amount of preliminary calculation, the effects upon the motion of a large number of different gusts may be determined with relative ease. So far as I am aware, no actual method of integration nor any quantitative results of such an integration has previously been published with the exception of the descriptive popular lecture of Glazebrook cited above. I have carried through the actual determination of the effects of gusts in the following cases:

Head-on gusts rising from 0 to J feet per second with various degrees of sharpness.

Up gust of the same type.

Rotary gusts of the same type.

Rear gusts and down gusts are included by merely changing the sign of J . For convenience, it has been assumed that the machine is in still air except for the gustiness; as a matter of fact gusts are usually superposed upon a general steady wind of other than zero

average velocity; but the conditions of flight in still air and in steady air are nearly identical, the only difference being that in the equations of motion the resistance derivatives are calculated from the relative wind, whereas U is the actual velocity over the ground.

It has been found that a stable machine, with controls untouched, running into a head gust of various sharpness and of total intensity J foot-second will swoop up, with some oscillation of no serious character, to a new level about $3.5 J$ feet higher than its previous level. The constrained machine will rise without oscillation to a new level only J feet, or a trifle less, higher than before. The path in a vertical plane is indicated in the diagrams drawn for me by Mr. T. H. Huff. The accelerations arising in the motion are not serious for either the machine or the pilot. It has been found further that a rotary gust may have considerable effect—though in the absence of data as to the intensity and regularity of rotation in the air no definite results can be formulated. Furthermore we find that up gusts operate chiefly in lifting the machine, whether free or constrained, with the gust. The path in space is given in the diagram. There is here in the case of sharp gusts a considerable momentary acceleration in the vertical which may reach a magnitude of about $1.5 J$ foot-seconds.² This would not seriously stress the machine, which is designed to stand accelerations of $6 g$ to $8 g$ in maneuvering, but owing to its sudden and unexpected appearance this acceleration might incommode the pilot—it is indeed the familiar phenomenon of a “bump.”

It follows, therefore, that the introduction of the constraint, whether by gyroscopic or other means, serves only to eliminate the natural oscillation in pitch and to diminish, in the case of the head or rear gusts only, the final change of level. As a rear gust of 20 foot-seconds is found to drop the uncontrolled machine by more than 80 feet in 15 seconds, flight at low altitudes is more dangerous in the unconstrained than in the constrained machine. However, the elapsed time is sufficiently great to enable the pilot to check the dip by a suitable movement of his elevator.

To offset any advantages derived from the constraint, we find that this particular machine, when constrained, becomes unstable at a speed between 47 and 51 mile-hours, whereas the free machine remains stable down to a speed between 45 and 47 mile-hours.

MASSACHUSETTS INSTITUTE OF TECHNOLOGY,
Boston, Mass., October 7, 1915.

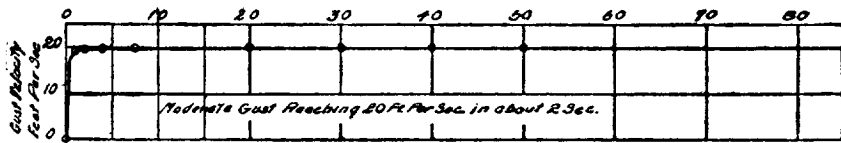
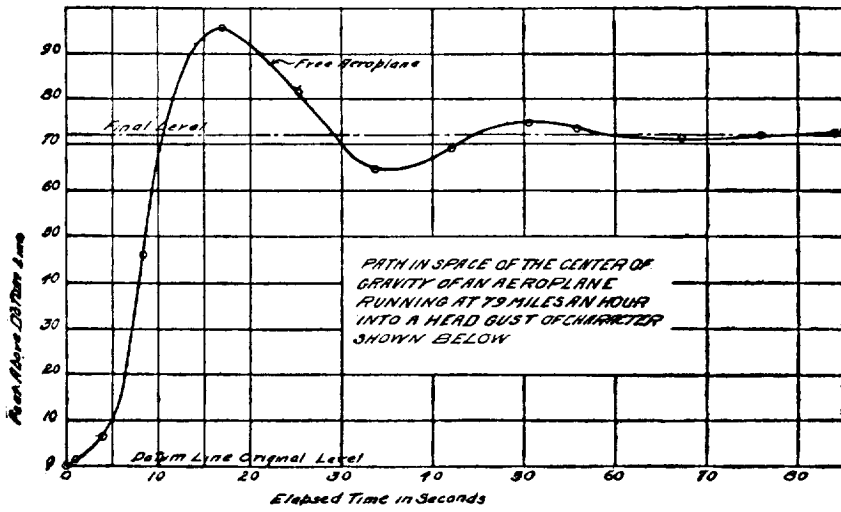
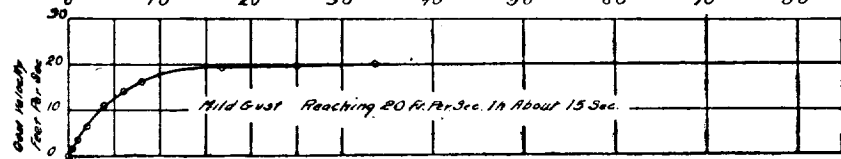
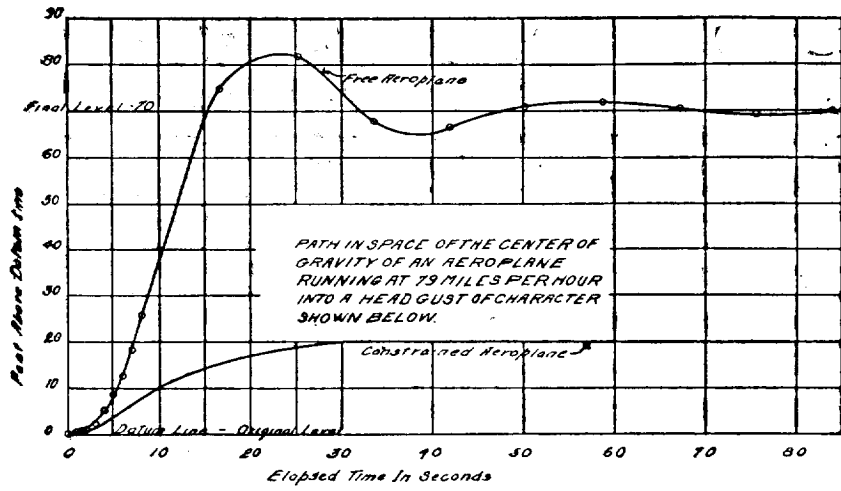

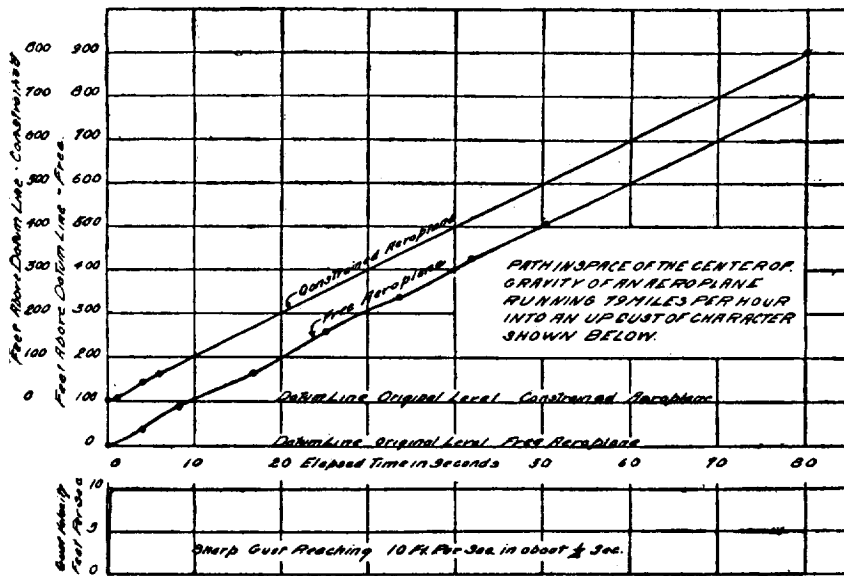
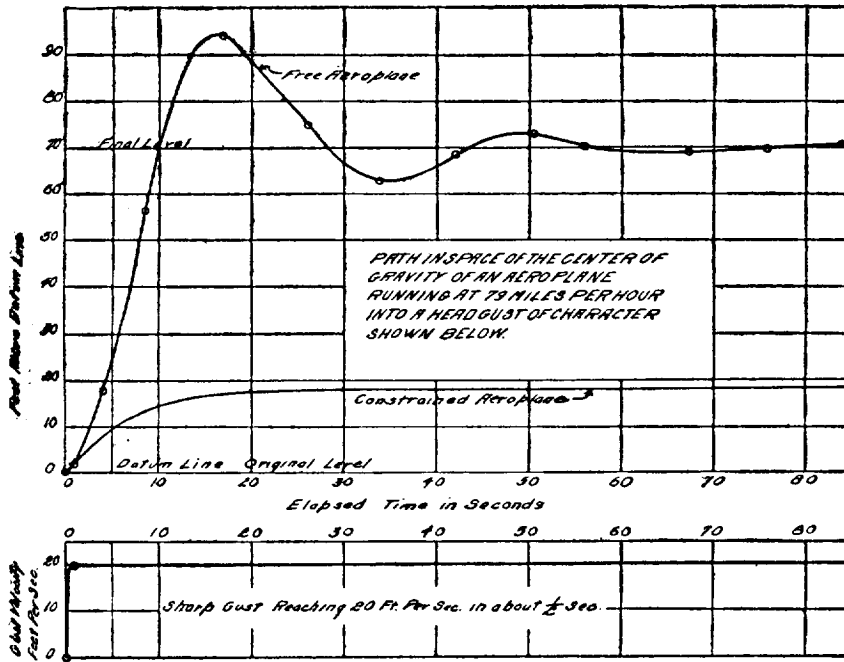

REPORT No. 2.

IN TWO PARTS.

INVESTIGATION OF PITOT TUBES.

BY THE UNITED STATES BUREAU OF STANDARDS.

**Part 1.—THE PITOT TUBE AND OTHER ANEMOMETERS FOR
AEROPLANES.**

By W. H. HERSCHEL,

Part 2.—THE THEORY OF THE PITOT AND VENTURI TUBES.

By E. BUCKINGHAM.

CONTENTS OF REPORT NO. 2.

	Page.
Section 1. Introduction.....	79
2. General remarks on the Pitot tube.....	79
3. Errors in the interpretation of Pitot tube readings.....	80
4. Working formulas for perfect Pitot tubes.....	82
5. Errors of the Pitot tube at very high speeds.....	84
6. General remarks on resistance anemometers.....	84
7. The wind resistance of flat plates.....	86
8. Resistance of spheres and hemispheres.....	88
9. Practical forms of resistance anemometers.....	89
10. The anemo-tachometer.....	90
11. The Bourdon-Venturi anemometer.....	91
12. Remarks on the special conditions to which aeroplane anemometers are subject.....	94
13. Density corrections.....	95
14. Comparison of types of anemometers.....	98

REPORT NO. 2.

PART 1.

THE PITOT TUBE AND OTHER ANEMOMETERS FOR AEROPLANES.

By W. H. HERSCHEL.

1. INTRODUCTION.

The air pressures on the wings of an aeroplane, and therefore the sustaining power of the wings and the stresses to which the whole structure is subject, depend on the speed of the machine relative to the air through which it is moving. The measurement of this speed—particularly near the lower limit where the sustaining power becomes deficient and there is danger of stalling, or at very high speeds where any movement of the controls may give rise to dangerously large stresses—is evidently a matter of importance, and the use of a reliable anemometer or speedometer is highly desirable. The aim of the following paper is to describe the principles of operation of some of the instruments which have been devised or used for this purpose and to discuss their characteristics, so far as it can be done from a general point of view or on the basis of available information, without undertaking new experimental investigations.

Since the Pitot tube is the instrument which has been most commonly used in the United States and Great Britain as a speedometer for aeroplanes, it will be treated first and somewhat more fully than the others.

2. GENERAL REMARKS ON THE PITOT TUBE.

The speed-measuring device known, after its inventor,¹ as the Pitot tube contains two essential elements. The first is the dynamic opening, or mouth of the impact tube, which points directly against the current of liquid or gas of which the speed is to be measured, and receives the impact of the current. The second is the static opening for obtaining the so-called static pressure of the moving fluid, i. e., the pressure which would be indicated by a pressure gauge moving with the current and not subject to impact. To avoid the influence of impact, the static opening points at right angles to the dynamic opening. If the two openings are connected to the two sides of a differential pressure gauge, the gauge shows a head which depends on

¹ Origin and Theory of the Pitot Tube, H. E. Guy Engineering News, June 5, 1913, p. 1172.

the speed and density of the current in which the tube is placed, and which may be used as a measure of the speed of the fluid past the Pitot tube.

If the fluid is a liquid and the two openings are connected to a U gauge containing the same liquid, the gauge shows a head h and the usual formula for computing the speed S is

$$S = C\sqrt{2gh} \quad (1)$$

in which g is the acceleration of gravity and C is the "coefficient" or "constant" of the given instrument. If the head h is read on a gauge containing a liquid of density d while the density of the fluid (either gas or liquid) in which the Pitot tube is immersed is ρ , equation (1) takes the modified form:

$$S = C\sqrt{2g\frac{d}{\rho}h} \quad (2)$$

According to the elementary theory as usually given, C should be exactly 1, and in practice it is in fact in the neighborhood of unity, when the instrument is properly designed and used with suitable precautions.

As regards design, it may be said that numerous recent investigations have shown that almost any sort of dynamic opening is satisfactory, but that the static opening must be designed with great care in order that the coefficient C may be set equal to unity without involving any sensible error in the result of using equation (2). Rowse,¹ for example, has made an extensive comparison of various forms of Pitot tube, which confirms previous results obtained by White,² Taylor,³ Treat,⁴ and others. With the most satisfactory tube tested, the experimental error in S was found to be not over 0.2 per cent, whether the static pressure was taken from a piezometer ring,⁵ or from the static opening of the tube as supplied by the maker. The standard of comparison was a Thomas electric meter, which was assumed to give correct readings.⁶

It may therefore be concluded that by proper construction the Pitot tube can be made to have a coefficient so near unity that for all ordinary purposes the equation

$$S = \sqrt{2g\frac{d}{\rho}h} \quad (3)$$

may be regarded as sensibly accurate.

3. ERRORS WHICH MAY OCCUR IN THE INTERPRETATION OF PITOT-TUBE READINGS.

The simple theory which leads to equation (3) assumes that the tube is always pointed exactly against the current and that the observed head, h , is due to the instantaneous value of the speed S .

¹ W. C. Rowse, *Trans. A. S. M. E.*, 1913, p. 633.

² W. M. White, *Journal Association of Engineering Societies*, August, 1901.

³ D. W. Taylor, *Society of Naval Architects and Marine Engineers*, November, 1905.

⁴ Chas. H. Treat, *Trans. A. S. M. E.*, 1912, p. 1019.

⁵ The piezometer was simply an air-tight annular space about the pipe, connected with the interior of the pipe by six small holes.

⁶ For accuracy of Thomas meter see C. C. Thomas, *Journal Franklin Institute*, vol. 172, p. 411, and *Proceedings Am. Gas Inst.*, vol. 7, 1912, p. 339. For more recent experimental verifications of equation (2) without use of the Thomas meter, see F. H. Bramwell, *Report of British Committee on Aeronautics*, 1912-1913, p. 35, and Wm. Cramp, *Manchester Memoirs*, vol. 58, part 2, sec. 7.

These assumptions are never exactly fulfilled in ordinary practice and accordingly exact results may not be obtained, even when no fault is to be found with the instrument itself.

In the first place, it is impossible to read the gauge instantaneously; furthermore, there is always a time lag between the openings and the gauge. Accordingly, even when the current does not change in direction, if its speed varies rapidly all that can be observed is the mean value of h over a certain time interval, and this value does not correspond to the arithmetical mean value of S over the same interval, even if the interval is long compared with the time lag, as has been shown experimentally by Rateau.¹

Disregarding the time lag, the value of S computed by equation (3) will be the root-mean-square speed, which is always larger than the arithmetical mean speed. Hence if, for example, the Pitot tube is being used to determine the discharge through a steam main feeding a reciprocating engine, the computed discharge will be greater than the true discharge. This error is not likely to be very large. If, for instance, the speed varies sinusoidally with time from 0.5 to 1.5 times its arithmetical mean value, the linear speed computed by equation (3) will be 1.0607 times the arithmetical mean speed which determines the total flow, or a trifle over 6 per cent. too large.

A second cause of error is rapid variability in direction of the current, which makes it impossible to keep the tube pointed correctly even when mounted on a vane. If, as is usually the case, it is desired to measure merely the component velocity in a fixed direction, the eddies which almost always exist may introduce a considerable error when this component velocity is computed by equation (3). If the variations of direction are small, the error is due almost entirely to the effect on the static opening and not to change of the direction of impact on the dynamic opening.²

This source of error is much reduced in the Dines tube, a form of Pitot tube in which the static opening consists of a number of round holes or longitudinal slits in a hollow cylinder placed with its axis perpendicular to the direction of the impact tube and to the plane in which the variations of direction are expected to occur. When this instrument is employed as an anemometer, its principal use, the cylinder is of course vertical.

The heads given by the Dines tube are sensibly independent of errors in direction up to about 20° on each side of the mean. To offset this advantage, the instrument is somewhat less sensitive than the ordinary Pitot tube, the coefficient C being greater than 1. Furthermore, each tube must be calibrated separately, and it is not even certain that the coefficient is strictly constant for each tube. Data by Dines³ show a constant coefficient $C=1.53$. Jones and Booth⁴ find values from 1.20 to 1.70 for different tubes. Zahn⁵ finds values from 1.42 to 1.50, depending on the speed.

It has sometimes been doubted whether the coefficient C of a given Pitot tube was dependent solely on the relative speed of the fluid and the tube, the suggestion being that a tube standardized by mov-

¹ *Annales des Mines*, 1898, p. 341.

² L. F. Moody, *Proceedings Engineers' Society of Western Pennsylvania*, May, 1914.

³ *Quarterly Journal, Royal Meteorological Society*, vol. 18, 1892.

⁴ *Aeronautical Journal*, July, 1913, p. 195.

⁵ *Physical Review*, 1903, p. 410.

ing through a quiescent medium, as with a whirling arm in air, may not give correct results when used to determine the velocity of a fluid past a fixed point. It is difficult to see how the Pitot tube can respond to anything but velocity relative to itself. At all events, experiments by Fry and Tyndall¹ have shown that while there was some apparent disagreement at speeds below 11 miles per hour (17.7 kilometers) where the experimental errors were large, for higher speeds, up to 36 miles per hour (58 kilometers) both methods of standardization gave the same result.

Which method of standardization should be adopted—motion of the tube or motion of the fluid—may, nevertheless, depend on the purpose for which the instrument is intended. It is impossible in practice to set up an artificial current of fluid which shall have a high speed and not be turbulent and full of eddies; and the only conditions to which equations (1) and (2) refer are, in strictness, those of steady stream-line flow or steady motion of the tube in a quiescent fluid. If

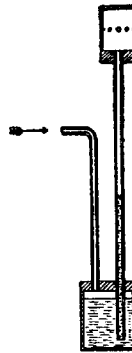

Dines anemometer.

the tube is to be used in a very turbulent medium, as, for example, in measuring the discharge from a fan, it should be standardized in a stream of fluid in which the turbulence is about the same as it will be under the working conditions. It might very well happen that a given tube when tested on the whirling arm or by moving through still water gave a coefficient $C=1$, while if the tube were tested in a turbulent current some other value of C was obtained. If the tube were to be used to measure the average speed of a similarly turbulent current, this second coefficient should be used and not the value $C=1$.

Apparent errors and inconsistencies in the results obtained by equations (1) and (2) have probably been due in part to disregarding the foregoing obvious considerations.

4. WORKING FORMULAS FOR PERFECT PITOT TUBES.

It will be convenient to collect here, for reference, certain practical working forms of equation (3) for the perfect or ideal Pitot tube, that is, for a tube having the coefficient C equal to unity. If the tube does not satisfy this condition, whether on account of its design or from

¹ J. D. Fry and A. M. Tyndall, *Philosophical Magazine* (6), vol. 21, p. 348 1911.

the necessary circumstances of practical use, the value of C must be determined by experiment, and the values of S given by the following equations are then to be multiplied by the observed values of C .

We start by inserting the value $g = 32.17 \text{ ft./sec.}^2$ or 9.81 m./sec.^2 in the general equation (3), viz:

$$S = \sqrt{2gh \frac{d}{\rho}} \tag{3}$$

in which S = the speed of the current,
 h = the head on the differential gauge,
 d = the density of the liquid in the gauge,
 ρ = the density of the current.

From this we obtain special equations for practical use.

(A) Any two fluids.— d and ρ may have any values but are to be measured in the same units. The value of S is given by the equation

$$S = X \sqrt{h \frac{d}{\rho}} \tag{4}$$

with the values of X shown in Table 1 for various methods of expressing S and h .

TABLE 1.—Values of X for equation (4).

h measured in—	S measured in—	X .
Inches of liquid of density d	{ Ft./sec.....	2.316
	{ Ft./min.....	138.9
	{ Mile/hour.....	1.579
Mm. of liquid of density d	{ M./sec.....	.1411
	{ M./min.....	8.404
	{ Km./hour.....	.5043

(B) Any moving fluid, gauge liquid water.—The value of S is given by the equation

$$S = Y \sqrt{\frac{h}{\rho}} \tag{5}$$

with the values of Y shown in Table 2.

TABLE 2.—Values of Y for equation (5).

h measured in—	ρ measured in—	S measured in—	Y .
Inches of water at 68° F. = 20° C	Lbs./ft. ³	{ Ft./sec.....	18.28
		{ Ft./min.....	1097
		{ Mile/hour.....	12.46
Mm. of water at 68° F. = 20° C.	Kgm./m. ³	{ M./sec.....	4.426
		{ M./min.....	265.5
		{ Km./hour.....	15.93

When the Pitot tube is to be used in air, the air density ρ for use in equations (4) and (5) may be found as follows:

Let B = the barometric pressure.

Let t = the temperature of the air.

Let P = the pressure of saturated steam at t° , from the steam tables.

Let H = the relative humidity.

Then in English units, if B and P are in inches of mercury and t in degrees F.,

$$\rho = 1.327 \frac{B - 0.376PH}{460 + t} \text{ lbs./ft.}^3 \quad (6)$$

or in metric units, if B and P are in millimeters of mercury and t in degrees C.,

$$\rho = 0.464 \frac{B - 0.376PH}{273 + t} \text{ kgm./m.}^3 \quad (6a)$$

All the numerical data given in this section are accurate enough to permit of computing the speed to within 0.1 per cent. Actual values computed from equation (5) may be found from Table 7, section 13. The calculations required by equation (6) may be avoided by the use of diagrams given by Rowse¹ and Taylor.² Hinz³ gives a diagram showing the gas constant of moist air, which may be used in place of equation (6a).

5. ERRORS OF THE PITOT TUBE AT VERY HIGH SPEEDS.

The theory of the action of the Pitot tube, as given in Part 2 of this paper, shows that the equations given in the preceding sections must be expected to require a correction if the observed pressure difference is enough to compress the fluid sensibly. This will never occur when liquids are in question, though when the instrument is used for measuring the speed of a gas the correction required to allow for compressibility might become sensible at high speeds. But for the highest speeds attained by aeroplanes, say 130 miles per hour, the correction computed from the theory is less than 0.5 per cent., an amount which is altogether negligible in comparison either with the errors of observation or with the uncertainties of the theory itself, which is far from convincingly rigorous.

6. GENERAL REMARKS ON RESISTANCE ANEMOMETERS.

When a fixed obstruction is placed in a current of fluid, it experiences a force in the direction of flow which depends upon and may be used as a measure of the speed of the current. The force depends on the relative motion and is the same, at the same relative speed, when the fluid is at rest and the body moves through it, the force then appearing as a resistance to the motion. It is the resultant of forces exerted on the elements of the surface of the body (*a*) normally by the pressure, which varies from point to point; and (*b*) tangentially

¹ Loc. cit., p. 690.

² Loc. cit., p. 33, and plates 33 and 34.

³ Adolf Hinz, *Thermodynamische Grundlagen der Kolben und Turbokompressoren*, p. 42.

by skin friction of the fluid moving along the surface. Since we are now interested only in devices which may be used as anemometers, we may as well, for the future, say "air" instead of fluid, and "wind" instead of current.

As regards the pressure, there is always, on the windward or upstream side, a region of increased pressure, i. e., of excess above the general static pressure of the air; while on the leeward or downstream side there is a deficiency. In the Pitot tube, the obstruction consists of the impact tube with its open mouth at the upstream end. This receives the excess pressure and transmits it to the gauge. The instrument deals solely with the excess pressure on the upstream side, of an obstruction of particularly simple form, the drag due to skin friction and the suction on the downstream side having no effect on the reading of what we have called a perfect Pitot tube.

The next simplest case is that of a thin flat plate of regular outline set normal to the wind. The skin friction forces balance one another and the whole normal force on the plate is the surface integral of the excess of pressure on the front, over that on the back. If the plate is mounted so that the force of the wind on it can be measured, it constitutes a "pressure-plate anemometer."

Various devices which are in practical use may be regarded as intermediate between the Pitot tube and the pressure plate anemometer. Among these are the Dines tube (see p. 82), the "Stauscheibe," and the Pneumometer. The Stauscheibe is a metal disk about 1 cm. in diameter with holes in the centers of its two faces from which the pressures are led to the two arms of the U gauge, through the disk and through the support by which the disk is held perpendicular to the current. The Pneumometer differs from the Stauscheibe only in details of construction. For both these instruments the coefficient of equation (1) has the value 0.854, the observed pressure difference being influenced by the suction at the downstream face as well as by the impact pressure on the upstream face.¹

In the case of pressure plate anemometers, it is usually the total force acting on the obstruction in the wind that is measured, rather than a manometric pressure, although Stanton² used a diaphragm and air pressure to transmit the force acting on a plate to a manometer 50 feet away.

If the solid obstruction is anything else than a thin flat plate normal to the wind, skin friction as well as pressure contributes to the resultant force; and if the body is not symmetrical about an axis parallel to the wind, the resultant force will not in general be parallel to the wind, but the body will receive a side thrust in addition to the resistance in the direction of the wind, as, for example, when the wing of an aeroplane has both lift and drift. Any body mounted so that the force on it can be measured, provides a means of measuring the speed of the wind and may be used as an anemometer; but if the body is to be held in a fixed orientation with respect to the wind, it is evidently simplest, mechanically, to avoid side thrust by making the body symmetrical about the wind direction, preferably a figure of revolution about that axis. The resistance offered to the wind by a symmetrical body of given maximum section normal to the wind

¹ Rowse, loc. cit., p. 677 and 684. A. Gramberg, Technische Messungen, third edition, 1914, p. 99. Cramp, loc. cit., p. 14.

² T. E. Stanton, Collected Researches, National Physical Laboratory, Vol. V, 1909, p. 169.

depends greatly on its shape, being less for a sphere than for a flat plate normal to the wind, and still less for a somewhat elongated spindle-shaped body.

Whatever the shape of the body may be, unless it is a sphere its resistance to a given wind depends on its presentation, and by a suitable choice of shape this variation of the force with the orientation may be made quite large. The operation of the Robinson, or cup anemometer, depends on the fact that the resistance of a hemispherical cup is greatest when the concave side is pointed to windward, so that a wind blowing in the plane of rotation of the cups always produces a torque. In the so-called "bridled" form of this anemometer, the torque is measured statically and the instrument is then merely a rather complicated form of pressure-plate anemometer. In the ordinary form of the instrument, in which the cups are allowed to revolve freely, the speed of the wind is measured indirectly by observing the speed of rotation, the action of the wind on the cups being then still more complicated.

From the fact that the pressure recorded by the Pitot tube is proportional to the square of the speed, it might be surmised that the total force observed with a pressure-plate or other static resistance anemometer would probably also be nearly proportional to the square of the speed; and this is confirmed by experiment. The analogy between these anemometers and the Pitot tube is a very close one, the Pitot tube being in principle only a particularly simple kind of resistance anemometer.

We have next to speak somewhat more in detail of some special types of resistance anemometer.

7. THE WIND RESISTANCE OF FLAT PLATES.

The resistance of a flat plate normal to a wind of velocity S is nearly proportional to S^2 and this relation is sometimes represented by writing

$$P = K S^2 \quad (7)$$

in which P is the force per unit area of the plate. The coefficient K is approximately proportional to the density of the air, but it varies with the size and shape of the plate. The independence of Pitot tube readings of the size and nature of the dynamic opening would lead us to expect that the pressure at the center of the front of the plate would be independent of the size and shape of the plate, and Stanton's¹ experiments confirm this expectation. But the suction on the back depends on size as well as speed, thus accounting for the variability of K and showing that P is only a fictitious pressure with no physical significance.

We shall confine our attention to square and round plates, for which the laws of the distribution of pressure are more simple than for very oblong rectangles.² When giving numerical values in "English units" pressure will be in pounds per square foot and speeds

¹ Loc. cit., p. 192.

² G. Finzi and N. Soldati, Engineering, Mar. 31, 1905, p. 397.

in miles per hour, while in "Metric units" pressure will be in kilograms per square meter and speeds in meters per second.

A. *Square plates*.—According to Eiffel¹ the value of the coefficient K of equation (7) in English units varies from 0.00266 for plates 4 inches square to $K=0.00326$ for plates 40 inches square or larger. The temperature and pressure of the air during the tests are not given. The corresponding metric values are 0.065 and 0.08. Bairstow and Booth² after analyzing the available data give the equation

$$F=0.00126 (S l)^2+0.0000007 (S l)^3$$

in which F is the total force in pounds, S is the speed in feet per second, and l is the length of side in feet. The equation refers to air at 760 mm. and 15° C. or 59° F. If S is measured in miles per hour the equation becomes

$$F=0.00271(Sl)^2+0.0000022 (Sl)^3$$

and if put into the form (7), for the sake of comparison with Eiffel's results, it may be written

$$P=0.00271(1+0.0008 Sl)S^2$$

the coefficient K depending on both S and l .

B. *Circular disks*.—For a circular disk 30 centimeters, or 11.8 inches, in diameter, Eiffel gives the value $K=0.00276$ English, or 0.0675 metric. Stanton³ found the values $K=0.0027$ English (0.066 metric) by using a 2-inch disk. On the whole, Eiffel's results seem preferable, because the size of disk used by him is more nearly the desirable size for an anemometer.

As regards the relative importance of the front and back of the plate, it may be noted that in a wind of 10 meters per second or 22.4 miles per hour, Eiffel found that the front of his 12-inch disk accounted for 72 per cent of the whole resistance. Zahm⁴ has pointed out that if a plate be surrounded by a sufficiently broad guard ring there will be no suction on the back, while the pressure on the front will be uniform and the same as indicated by a Pitot tube at the same speed.

Table 3 shows the force on a 12-inch disk for different wind velocities, the total resultant force being calculated from Eiffel's value of $K=0.00276$ English (0.0675 metric), and from Bairstow and Booth's formula for square plates, assuming, as some but not all experimenters have found, that the average pressure would be the same for a circular plate with a diameter equal to l , as for a square of side l .

¹ G. Eiffel, *The Resistance of the Air*, p. 35.

² Report, British Advisory Committee for Aeronautics, 1910-11, p. 21.

³ T. E. Stanton, *Proceedings Inst. C. E.*, Vol. CLVI, 1903-4, part 2, p. 78.

⁴ A. F. Zahm, *Journal Franklin Institute*, vol. 173, January-June, 1912, p. 256.

TABLE 3.—Wind forces in pounds on a 12-inch disk.

Wind speed S miles per hour.	Force in pounds according to Eiffel.	Force in pounds according to Bairdow and Booth.
30	1.94	1.97
40	3.47	3.50
50	5.40	5.53
60	7.80	8.00
70	10.60	11.01
80	13.88	14.48
90	17.55	18.48

TABLE 3A.—Wind forces in kilograms on a 30-centimeter disk.

Wind speed S kilometers per hour.	Force in kilo- grams according to Eiffel.	Force in kilo- grams according to Bairdow and Booth.
48.3	0.86	0.87
64.4	1.53	1.55
80.4	2.38	2.44
96.5	3.44	3.53
112.8	4.68	4.87
128.8	6.13	6.39
145.0	7.75	8.15

8. RESISTANCE OF SPHERES AND HEMISPHERES.

Next to thin plates and hemispherical cups the sphere has been most frequently employed in static resistance anemometers as the obstruction opposed to the wind. In addition to the fact that a sphere is symmetrical about all diameters, so that the indications of a sphere anemometer may be made independent of changes in wind direction, the sphere has the further advantage of simplicity of form so that it may readily be duplicated. A disadvantage of the sphere, as compared with thin plates, is the lower value of the coefficient K of equation (7).

According to W. H. Dines, as quoted by Lanchester,¹ K has a value of 0.00154 English for a sphere 6 inches in diameter, or 0.0378 metric for one 153 millimeters in diameter. Dines's tests were made with a velocity of 21 miles an hour (34 kilometers). Eiffel² gives K as 0.00045 (0.011 metric) and explains the difference between his value and that of 0.00112 (0.0275 metric) found at Göttingen, as follows: K decreases with an increase of velocity until a certain critical velocity is reached, after which K remains nearly constant at 0.00045 for the three spheres experimented upon. This critical velocity was found to be about 27 miles an hour for a 6-inch sphere, 16 miles for a 10-inch sphere, and 9 miles for a 13-inch sphere (12,

¹ F. W. Lanchester, *Aerodynamics*, p. 25.

² *La Technique Aeronautique*, 1913, p. 146.

7, and 4 meters per second, respectively, for the 16, 24, and 33 centimeter spheres). The high value of the Göttingen coefficient is, according to Eiffel, due to the fact that velocities of over 23 miles an hour (36 kilometers) can not be obtained at that laboratory. It will be noted that even for a 6-inch sphere the critical velocity is well below the lowest flying speeds used in practice.

Table 4 shows values of K for hemispherical cups, according to Dines.

TABLE 4.—Values of K in equation (7) for hemispherical cups.

	English.	Metric.	English.	Metric.	English.	Metric.
	Diameter of cup.					
	2½ in.	64mm.	5in.	127mm.	9in.	229mm.
Cup facing wind.....	0.00597	0.146	0.00386	0.095	0.00402	0.099
Cup with back to wind.....	.00239	.059	.00168	.041	.00138	.034

Since Dines used only the one speed of 21 miles an hour, there is a doubt whether his values would hold for higher speeds. It appears that with a cup there would be little if any reduction in diameter as compared with a plate giving an equal force, though the cup would have the advantage of greater strength for a given force and weight. The difference in the force acting on the cup in its two positions, which is the driving force of the Robinson anemometer, is clearly indicated by the table.

9. PRACTICAL FORMS OF RESISTANCE ANEMOMETER.

Maxim¹ used a pressure plate anemometer consisting of a disk with a spring resistance. His arrangement had the advantage of fairly uniform graduations of the scale, the spring acting indirectly, with variable leverage on the pressure plate.

In the pressure-plate anemometer of Dines² the variable resistance is furnished by a float partly immersed in water, the pressure on the plate being equal to the weight of a volume of water equal to that of the part of the float raised above the water level.

The 1914 catalogue of Aera, Paris, shows a pressure plate anemometer which is merely a speed indicator. It is supplied with three disks, so that it may be set for any speed between 50 and 75 miles an hour (80 and 120 kilometers). The pointer will then show whether the actual speed is above or below the normal. Aera also make an anemometer using a sphere, in the form of a pendulum. This instrument reads only to 45 miles an hour (72 kilometers) and has graduations coming closer together at higher speeds. It would be very inaccurate without some means for holding it vertical.

The Davis Lyall air speed indicator, made by John Davis & Son, of Derby, England, is a bridled anemometer of the screw type which should be held with its back to the wind, though the manufacturers

¹ H. Maxim, *Natural and Artificial Flight*, p. 70.

² *Quarterly Journal, Royal Meteorological Society*, vol. 18, 1892, p. 167.

do not provide it with an air vane to do this automatically. This defect is remedied in the Aera bridled anemometer. Concerning the Davis Lyall instrument, it is stated:

To avoid undue oscillation of the pointer a damper is provided—either magnetic or air. Such a damper is rendered necessary in measuring velocities in a natural wind which varies within wide limits.

When it is desired to investigate the gusty character of natural winds, the sensitiveness of a bridled anemometer becomes an advantage. Concerning a bridled anemometer consisting of five hemispherical cups attached to a vertical spindle by short arms, Stanton¹ says that this instrument is more sensitive to momentary gusts than any of the other recording instruments in common use.

10. THE ANEMO-TACHOMETER.

When anemometers of the screw type are used for high velocities, there is danger that the vanes will be deformed and the velocity indications become unreliable, and for this reason cup anemometers are more suitable for out-door work. Wilhelm Morell, of Leipzig, has placed on the market an anemo-tachometer illustrated in the *Deutsche Luftfahrer*.² This is a Robinson anemometer with tachometer attached for aeronautical purposes, the tachometer being an instrument, usually actuated by centrifugal force like a steam engine flyball governor, so that velocities may be read at a glance from the position of a pointer. It will be noted that with a tachometer, in contrast to a revolution counter, no measurement of a time interval is required. The anemo-tachometer also has the advantage of all Robinson anemometers that the wind vane may be dispensed with.

According to a communication from Morell, his anemometers are calibrated in a wind tunnel, built in accordance with designs of Prof. Prandtl of the University of Göttingen, in which air currents up to 78 miles per hour (125 kilometers), can be obtained. It is stated that some of these instruments have been in constant use for two years without needing recalibration.

The anemo-tachometer, as well as other anemometers, should be attached to the aeroplane in such a manner that its indications are not influenced by the irregular and indeterminate wash of the machine and propeller. It has been proposed to lengthen the distance between the cups and the casing, so as to bring the cups above the upper supporting plane, while keeping the dial on a level with the pilot's line of vision. The objection to this lengthening is that it might change the friction and hence the indications of the instrument, and necessitate a special calibration.

What appears at first sight to be a solution of the difficulty, would be to provide the anemometer axis with a small electric generator, and use the electric voltage, thus generated to indicate speed of rotation by means of a voltmeter. We should anticipate, however, that electric indicating instruments, as at present constructed, would not long retain their accuracy when exposed to the vibrations on an aeroplane.

¹ Collected Researches, National Physical Laboratory, Vol. V, p. 174.

² Apr. 2, 1913, p. 168.

11. THE BOURDON-VENTURI ANEMOMETER.

The Venturi tube consists of a short converging inlet followed by a long diverging cone, the entrance and exit diameters being usually equal so that the tube may be inserted as a section of a pipe line. There is generally a short cylindrical throat. The converging part has somewhat the shape of a vena contracta, but its exact form is of little importance. The exit cone has a total angle of about 5° , this being found to give the minimum frictional loss for a given increase of diameter.

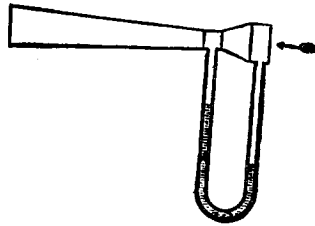

Venturi tube.

When a current of fluid passes through the tube, the pressure in the throat is less than at entrance to the converging inlet, by an amount which depends on the ratio of entrance to throat area, the density of the fluid, and the speed of flow. If the tube is provided with side holes and connections to a differential gauge by which this pressure difference may be observed, it constitutes a Venturi meter. The area ratio is a known constant for a given tube, so that when the density of the fluid is known the observed pressure difference may be used as a measure of the speed of flow. When the pressure difference is expressed as the height of a water column, it is known technically as the "head on Venturi."

Such an instrument may be used as an anemometer by pointing it so that the wind blows directly through it, and the observed head may then serve as a measure of the wind speed. Bourdon¹ employed the Venturi tube for this purpose in 1881, and it has been used recently as an aeroplane anemometer.

At a given speed, the observed head increases with the ratio α of entrance to throat area and the instrument may be made to give a much larger head than a Pitot tube. This is illustrated by the figures given in Table 5 for a tube in which $\alpha = 4$, the throat having half the diameter of the entrance. The data are for air at atmospheric pressure and 70° F. Column (2) gives the head which would be observed with a Pitot tube; column (3) that observed by Bourdon; and column (4) the ratio of (3) to (2).

¹ Annales des Mines, September and October, 1881; Comptes Rendus, 1882, p. 229.

TABLE 5.—Comparison of Pitot and Venturi heads for $\alpha=4$.

(1)		(2)		(3)		(4)	(5)	
Wind speed.		Pitot-tube head.		Head on Venturi according to Bourdon.		Col. 3. Col. 2.	Theoretical head on Venturi.	
<i>Miles hour.</i>	<i>Meters sec.</i>	<i>Ins.</i>	<i>Mm.</i>	<i>Ins.</i>	<i>Mm.</i>		<i>Ins.</i>	<i>Mm.</i>
10	4.47	0.05	1.3	0.17	4	3.4	0.7	18
20	8.94	.19	4.8	.80	20	4.2	2.9	74
30	13.41	.43	10.9	2.30	58	5.3	6.8	173
40	17.88	.77	19.6	4.0*	102*	5.2	12.3	312
50	22.35	1.20	30.5	6.6*	168*	5.5	20.0	508
60	26.82	1.73	43.9	10.0*	254*	5.8	30.0	762
70	31.29	2.35	59.7	15.0*	381*	6.4	45.0	1,143
80	35.76	3.07	78.0	20.0*	508*	6.5	63.0	1,600
90	40.23	3.89	98.8	25.0*	635*	6.4	90.0	2,286

In figure 1 the line HG represents Bourdon's observations and the starred values in column (3) of Table 5 were read from the dotted extension of this curve. While this extrapolation can make no claim to accuracy, it appears from column (4) of Table 5 that a Venturi tube with a 2 to 1 diameter ratio would probably give at least five times as much head as a Pitot tube at ordinary aeroplane speeds.

The curve FE of figure 1 and the numbers in column (5) of Table 5 were found from equation (27) of Part 2, which is known experimentally to agree closely with the facts when the Venturi meter is inserted in a pipe line instead of being used as an anemometer with both ends free. Upon introducing the known values of k and ρ for air at one atmosphere and 70° F., equation (27) reduces to

$$S = 1720 \sqrt{\frac{r^{\frac{10}{7}}(1-r^{\frac{2}{7}})}{\alpha^2 - r^{\frac{10}{7}}}} \text{ miles per hour.}$$

If the 1720 is replaced by 769, the result will be in meters per second.

What part of the great discrepancy between columns (3) and (5) of Table 5, or between EF and GH of figure 1, is to be ascribed to friction or other circumstances which make the Venturi tube act differently as an anemometer and as a flow meter, and what part to Bourdon's experimental arrangements and possible errors of observation, can not be decided without further investigation; but in any event, it is obvious that with the Venturi tube a much larger head is available than with a Pitot tube.

Since Bourdon wanted an anemometer for very low speeds, he increased the available head still farther by using two concentric tubes, the exit end of the inner one being at the throat of the outer, so that the suction there increased the speed through the inner tube and the fall of pressure at its throat. The proportions of the tubes which were adopted as giving the best results were as shown in Table 6.

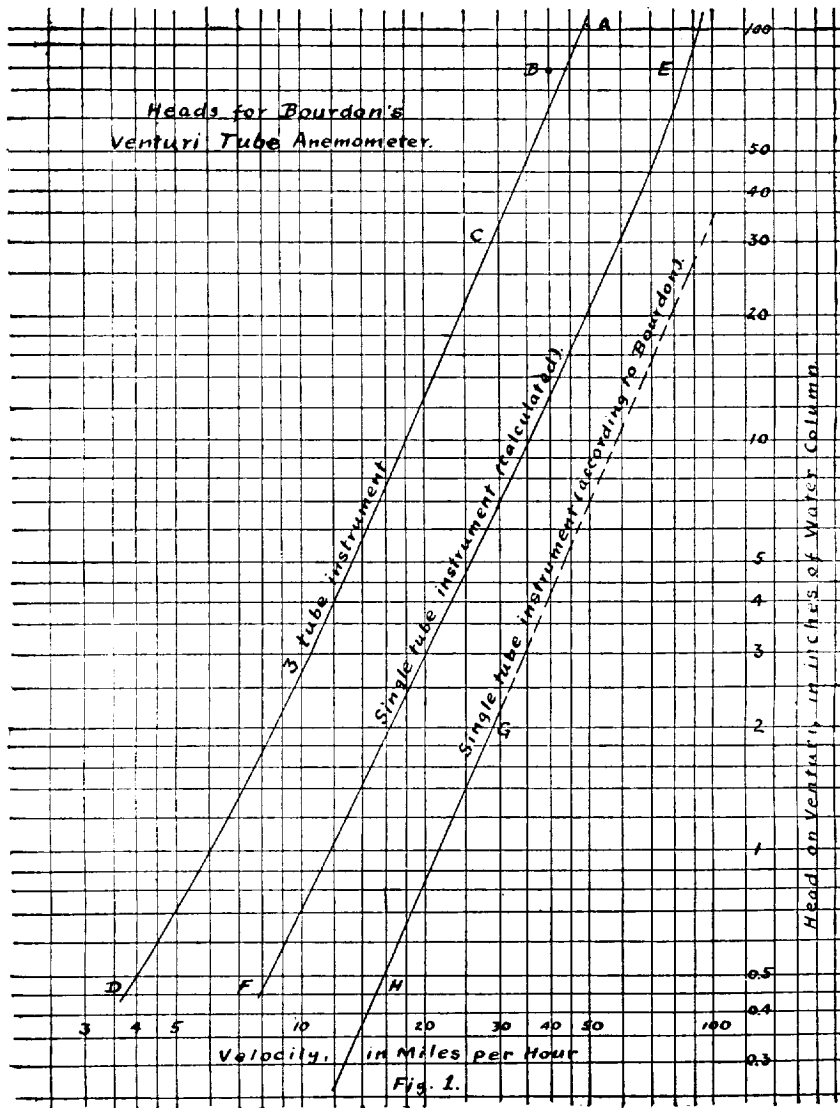

TABLE 6.—Proportions of Bourdon's double Venturi tube anemometer.

	Inner tube.	Outer tube.
Ratio of minimum to maximum diameter:		
(a) Of converging cone.....	0.31	0.56
(b) Of diverging cone.....	0.45	0.60
Double angle:		
(a) Of converging cone.....	34° 15	21° 38
(b) Of diverging cone.....	3° 45	4° 50
Relative throat diameters.....	1.0	6.2

No cylindrical throat piece was used with either tube, the converging and diverging cones being connected directly.

Bourdon also used a similar arrangement of three concentric tubes. The heads obtained with this, at various wind speeds, are shown on figure 1 by the curve *DC* and by the isolated point *A*. The point *B* is from tests of a 3-tube instrument by Brown Boveri & Co.¹

The proportions of single-tube anemometers as used in modern French practice seem to be somewhat like those of Bourdon's inner tube. (See Table 6.) The length of tube in the anemometer made by Aera, of Paris, is 6.3 inches (160 mm.) or nearly the same as the length of the diverging cone of Bourdon's inner tube. Dorand² gives, without dimensions, a section of a Venturi-tube anemometer which indicates a ratio of throat to entrance diameter of about 0.2. The proportions proposed by Toussaint and Lepère³ as a result of recent experiments are very similar to those of Bourdon's outer tube. (See Table 6.)

12. REMARKS ON THE SPECIAL CONDITIONS TO WHICH AEROPLANE ANEMOMETERS ARE SUBJECT.

A. Weight and head resistance.—These must both be small—the smaller the better. Accordingly we need not consider any essentially heavy instruments, such as those which require the use of electric batteries, nor instruments like large pressure plates which offer a head resistance of several pounds.

B. Robustness.—The very severe conditions of vibration preclude the possibility of using instruments which are not mechanically strong or which can not be made so without too great weight. Both the anemometer head proper, and the transmitting and indicating parts must be simple, light, strong, and free from the need of delicate adjustment or frequent testing.

C. Position.—The head must, so far as practicable, be out of reach of irregular currents and eddies and therefore at some distance from the indicator or dial in front of the pilot. The available positions are (*a*) in front of the center of the machine, (*b*) well above the upper planes over the pilot's head, (*c*) near one wing tip. Position (*a*) might be practicable and satisfactory in some cases but there is a possibility, unless the head were very far in front, that the readings might not be the same, at a given speed, during normal flight as when planing with the motor stopped. We have no information on this point. The influence of the body extends some distance ahead, a fact which should not be overlooked.⁴ Position (*b*) would often require the construction of a special support, increasing the weight and head resistance. Position (*c*) seems the natural one to adopt if a transmission of the requisite length can be made satisfactory; but here again it should be noted that the disturbance due to a strut or wing begins some distance ahead of the leading edge.⁵

D. Orientation.—While most anemometers have to be pointed directly into the wind if they are to indicate its resultant velocity,

¹ Zeitschr. d. Ver. Deutscher Ingenieure, 1907, p. 1848.

² E. Dorand, La Technique Aeronautique, Nov. 1, 1911, p. 252.

³ Rep. Brit. Adv. Com. for Aeronautics, 1912-13, p. 396.

⁴ See, for example, the results of experiments on the Marienfelde-Zossen high-speed electric railway, The Electrician, June 17, 1904.

⁵ See E. F. Relf, Rep. Brit. Adv. Com. for Aeronautics, 1912-13, p. 133.

what is needed in aviation is primarily the relative wind speed along a direction fixed with regard to the axis of the machine. The undesirable complication of mounting the anemometer head on a wind vane is therefore unnecessary and the head may be fixed. If information is required about motion perpendicular to this direction, it may be got from a wind vane.

E. Independence of gravity.—On account of the very considerable angles of heeling and pitching, it seems useless to consider any instrument which depends for its action on weights or liquid manometers. Any required forces must be applied by springs; or if pressures are to be registered, it must be by spring gauges. Furthermore, all parts of the instrument must be so balanced that the readings are not affected at all by gravity. This remark applies to the transmission and the indicator as well as to the head.

F. Vertical acceleration and centrifugal force.—Vertical acceleration acts merely as a change of the intensity of gravity. It will, therefore, have no effect on an instrument which is properly constructed in accordance with *E*, above.

Centrifugal force must be allowed for in a similar way by careful balancing of all movable parts so that the lateral acceleration of the whole machine during curved flight shall not influence the readings. This balancing in the transmission is equally necessary, whether forces are transmitted by rods or wires or pressures by fluids in tubes.¹

13. DENSITY CORRECTIONS.

Before considering the effects of changes of air density on the indications of particular types of anemometer it will be well to see how great these variations are likely to be under working conditions. For this purpose we consult equation (6) of section 4, viz,

$$\rho = 1.327 \frac{B - 0.376 PH}{460 + t} \quad (6)$$

in which

- ρ = the density of the air in pounds per cubic foot.
- B = the barometric pressure in inches of mercury.
- t = the temperature of the air in degrees Fahrenheit.
- P = the pressure of saturated steam at t° in inches of mercury.
- H = the relative humidity ($H = 1.0$ for saturated air).

The ranges we shall assume are: $B = 30$ to 20 inches, corresponding to a rise from sea level to about 10,000 feet altitude; $t = 0^\circ$ to 90° F.; $H = 0.0$ to 1.0, i. e., from complete dryness to saturation.

We may first consider the term $0.376 PH$. Taking P from the steam tables we have

at $t = 50^\circ$	70°	90°
$0.376 P = 0.136$	0.278	0.533
$0.376 P \times 0.5 = 0.068$	0.139	0.267

¹ For a discussion of the effect of vertical acceleration and centrifugal force on liquid manometers the reader may be referred to an article by H. Darwin, *Aeronautical Journal*, July, 1913, p. 170.

If we assume a constant relative humidity $H=0.5$, while in fact the humidity varies all the way from 0.0 to 1.0, the maximum error we can make in the value of $0.376 PH$ is $0.376 P \times 0.5$, of which the values at 50° , 70° , and 90° are shown above. To find the percentage error which this assumption can introduce into the computed value of ρ , we must compare these errors with the value of B . The following table shows the maximum per cent. errors in ρ at 50° , 70° , and 90° F. and at 20 and 30 inches pressure which can be caused by assuming $H=0.5$.

	$t=50^\circ$	$t=70^\circ$	$t=90^\circ$
$B=20$ inches	0.34%	0.70%	1.33%
$B=30$ inches	0.23%	0.46%	0.89%

Since a temperature of 90° F. will seldom or never prevail at an altitude where the pressure is as low as 20 inches, we may regard 1 per cent. as about the maximum possible error, and in the vast majority of cases the actual error will be less than 0.5 per cent. Now with the anemometers we need to consider, a given percentage error in the density causes only about half as much error in the speed S ; and furthermore, an accuracy of 1 per cent. in measuring the speed of an aeroplane may be regarded as satisfactory. Hence the assumption of a constant relative humidity of 50 per cent. ($H=0.5$) is quite approximate enough for our purpose, and we adopt this assumption and thereby simplify equation (6) to the form

$$\rho = 1.327 \frac{B - 0.19 P}{460 + t} \text{ pounds per cubic foot.} \quad (8)$$

From equation (8) we may now compute a table of approximate values of the air density at various values of the barometric pressure B and the temperature t . It will be convenient to have the values expressed, not in pounds per cubic foot, but in terms of a standard air density, and for this the value =0.07455 has been chosen. This is the density at $B=29.92$ inches, $t=70^\circ$ F., and $H=0.5$, conditions which are a fair average representation of those which are likely to prevail during anemometer tests. The values are shown in Table 7.

TABLE 7.—Relative density D of air at B inches pressure, t° F., and 50 per. cent relative humidity, referred to air at 29.92 inches pressure, 70° F., and 50 per. cent. relative humidity.

$B=$	20"	22"	24"	26"	28"	30"
$t=0^\circ$ F.	0.773	0.851	0.928	1.005	1.083	1.160
10°757	.833	.908	.984	1.060	1.135
20°741	.815	.889	.963	1.037	1.112
30°725	.798	.871	.943	1.016	1.088
40°710	.781	.853	.924	.995	1.066
50°696	.766	.835	.905	.975	1.045
60°681	.750	.818	.887	.955	1.023
70°667	.734	.801	.868	.935	1.003
80°653	.719	.785	.850	.916	.982
90°639	.703	.768	.833	.897	.962

We have next to consider how these variations of density may affect the readings of an anemometer which has been tested under standard conditions.

A. *The Pitot tube.*—The Pitot tube formula may be written

$$S = \text{const} \times \sqrt{\frac{p_1 - p_2}{\rho}}$$

or for a standard density ρ_0

$$S_0 = A_0 \sqrt{p_1 - p_2}$$

At any other density, $\rho = D\rho_0$, we have

$$S = \frac{A_0}{\sqrt{D}} \sqrt{p_1 - p_2} = \frac{S_0}{\sqrt{D}} \quad (9)$$

If the tube has been standardized at the density ρ_0 and the constant A_0 determined, or if the gage has been provided with a speed scale or a table for converting its readings at the standard density ρ_0 into speeds, the true speed at any other density ρ is found by multiplying the indicated speed by $\frac{1}{\sqrt{D}}$. Values of $\frac{1}{\sqrt{D}}$ computed from Table 7 are given in Table 8.

TABLE 8.—Values of $\frac{1}{\sqrt{D}}$ for use in equation (9).

t° F.	Barometric height <i>B</i> in inches of mercury.					
	20''	22''	24''	26''	28''	30''
0.....	1.137	1.084	1.038	0.979	0.961	0.928
10.....	1.149	1.096	1.049	1.008	.971	.938
20.....	1.162	1.108	1.061	1.019	.982	.948
30.....	1.174	1.119	1.072	1.030	.992	.958
40.....	1.187	1.131	1.083	1.040	1.003	.968
50.....	1.199	1.143	1.094	1.051	1.013	.978
60.....	1.212	1.155	1.106	1.062	1.023	.989
70.....	1.225	1.167	1.117	1.073	1.034	.999
80.....	1.238	1.180	1.129	1.084	1.045	1.009
90.....	1.251	1.193	1.141	1.096	1.056	1.020

If the purpose of reading the anemometer is not, primarily, to ascertain the speed, but to judge of the wind pressures on the machine which determine the lift and the stresses, then the density correction should *not* be applied. For at any given angle of attack, the wind forces are very nearly proportional to the Pitot pressure; when the gauge shows a given reading, the wind forces are always the same; and from the standpoint of sustaining power and strength it is immaterial how the forces arise. Hence from the point of view of the aviator who is concerned with the safety of his machine, the

speed readings of the Pitot-tube anemometer correct themselves automatically—if the machine flies safely at a given speed and in air of a given density, it will be equally safe in air of any other density, regardless of pressure, temperature, and humidity if the Pitot-tube gauge gives the same reading.

B. *Pressure-plate anemometers.*—It would naturally be supposed that the readings of pressure plate anemometers would be affected by variations of air density in the same way as those of Pitot tubes. The theory of the subject, however, is not entirely clear, and it is difficult to interpret some of the experimental results which have been obtained.¹ In the absence of further investigation it would seem safest to make the density correction, when necessary, exactly as is done for the Pitot tube. If the readings are taken only for the sake of estimating the wind forces on the machine, the density correction is to be omitted, just as with the Pitot tube.

C. *The Bourdon-Venturi anemometer.*—If the results of Bourdon's experiments agreed closely with computations from the theoretical equation of the Venturi meter, we should feel justified in using that equation to compute density corrections to be applied to the readings of an instrument which had been tested at a standard air density. But the discrepancies shown by curves GH and EF of figure 1 are so large that we can not trust the theoretical equation at all for a Venturi tube used as an anemometer. It appears that further experimental investigations of this instrument are needed.

D. *Rotary anemometers.*—Regarding rotary anemometers, Jones and Booth² say:

The principal advantage possessed by instruments of this type is that they read the actual travel through the air independently of variations in density.

It seems likely, however, that this independence is only approximate and not complete. The ratio of cup or vane speed to wind speed depends on the value of the least wind speed which will just keep the anemometer turning against friction. And since each vane or cup when moving very slowly acts as a pressure plate, it seems that the wind speed required in order to furnish the torque for very low speeds of rotation must depend on the air density. Hence it seems probable that at higher speeds the action of instruments of the Robinson or of the screw type is somewhat influenced by air density. Exact information on this is lacking.

14. COMPARISON OF TYPES OF ANEMOMETER.

Anemometers in general might be compared from various points of view; but since our purpose is strictly practical, we shall at once exclude from the discussion any instrument which can not be made satisfactory on the score of (a) robustness combined with lightness, (b) independence of gravity, and (c) flexibility of transmission, permitting the head to be placed at a distance from the indicator in front of the pilot's seat. There seem then to remain for discussion the Pitot tube, the pressure plate, the Venturi tube, and the Robinson anemometer.

A. *The Pitot tube.*—This has been the most studied, and we can speak of it with more certainty than of the others. The head is

¹ See Rayleigh, Rep. Brit. Adv. Com. for Aeronautics, 1910-11, p. 26.
² Aeronautical Journal, July, 1913, p. 192.

simple and may be placed in any position; and the transmission of the pressure through tubes presents no obvious difficulties. The prime defect of the instrument is the smallness of the pressure available for actuating the indicator. While sensitive liquid gauges may be used under some circumstances, anything but a spring gauge seems out of the question for all-round use. The problem with the Pitot tube is to make a satisfactory spring gauge which shall at the same time be sufficiently sensitive and so robust as to be reliable. The problem looks difficult, but may not be insoluble.

B. *The pressure plate.*—By an increase of size, the pressure plate may be made to give as large a force as is desired, the limit being set by the amount of head resistance which it is considered permissible to devote to an anemometer. Transmission by wires under tension might be practicable but would be liable to get out of order and to be seriously disturbed by vibration. Transmission by means of liquid pressure might be managed but would introduce complications, and the development of the instrument in this form would demand a great deal of experimentation. In spite of its attractiveness and apparent simplicity at first sight, the pressure plate does not, on the whole, seem very promising as a practical aeroplane instrument.

C. *The Bourdon-Venturi anemometer.*—The Venturi tube furnishes a pressure difference and the transmission problem is simple, as it is with the Pitot tube. But the pressure difference may be made so large that the problem of making a satisfactory spring gauge is vastly simpler than with the Pitot tube, and should not present any insuperable difficulties. A more important doubt arises in connection with the density correction. Since it is impracticable to test an anemometer at low-air densities by the ordinary methods, and since Bourdon's results differed greatly from what might have been expected on theoretical grounds, the instrument should be used with caution, if high altitude flights are in question, until we know more about its practical behavior. On the other hand, it appears to be satisfactory at ordinary air densities,¹ and it seems to be an instrument of great promise and one of which the practical development should be pushed along.

D. *The Robinson anemometer.*—The weak point of the Robinson anemometer is lack of flexibility in the transmission. In the form of Morell's anemo-tachometer it indicates speed through the air nearly independently of the air density. But since the main purpose of knowing this speed is for finding the total distance traveled, it would seem as if the ordinary method of registering the total number of turns would, in practice, be more useful than the attachment of a tachometer to give instantaneous speeds.

Having now discussed some of the mechanical characteristics of the four types of instrument we may take another standpoint and, assuming that a mechanically satisfactory instrument of each type can be constructed, ask whether one presents any advantages over another. The answer to this question depends on why we want to know the speed.

If what is wanted is to estimate the distance traveled through the air, some form of Robinson anemometer seems to be the thing to use, because it is independent of air density, to a first approximation, at

¹ See Eiffel, *The Resistance of the Air*, p. 234.

all events. The other three types of instrument will all require to have a density correction applied to their readings, if the air density is far different from that during standardization, and they are thus at a disadvantage.

But it appears that the speed through the air is, in general, not itself the important quantity sought; for at best it does not tell us the speed over the ground until it is compounded with the speed of the wind which may happen to be blowing. A more important use of the anemometer is not properly as a speedometer but as a dynamometer, i. e., as an instrument for indicating the air forces on the machine. For this purpose, any instrument such as the anemotachometer which gives the speed without reference to the density will require a density correction to its readings, whereas the Pitot tube gives just what is wanted, the allowance for density being already present in its uncorrected readings, so that equal readings mean equal pressures, whatever the density may be. The pressure plate falls in the same class as the Pitot tube. Of the Bourdon-Venturi anemometer we can say very little until the instrument has been further studied, but it seems likely that it also will act rather as a dynamometer than as a speedometer, if its readings are not corrected for variations of air density.

Still another question which may be asked is, What sort of mean speed does a given anemometer indicate when exposed to a gusty wind? In regard to this question, the four types under consideration fall into the same grouping as before. With the Pitot tube, the pressure plate, or the Venturi tube, the pressure difference or the force depends on the square of the wind speed, and the mean reading of any of these instruments in a wind of varying speed will therefore give not the arithmetical mean speed but the root-mean-square speed, which is what determines the mean wind forces on the aeroplane. The anemotachometer, on the other hand, will probably indicate something between the arithmetical mean and the root-mean-square speed. If it had no inertia it might be made to indicate the arithmetical mean, but the effects of inertia in causing lag or lead will probably make the mean reading of the instrument in a wind of variable strength somewhat higher than it would be in the absence of inertia. The fact that this might result in a slight overestimate of the total travel will hardly be of any moment, in view of the impossibility, for the aviator, of measuring and allowing for the true velocity of the wind with respect to the earth's surface.

REPORT No. 2.

PART 2.

THE THEORY OF THE PITOT AND VENTURI TUBES.

By E. BUCKINGHAM.

1. THE ENERGY EQUATION FOR STEADY ADIABATIC FLOW OF A FLUID.

Let a fluid be flowing steadily along a channel with impervious and nonconducting walls, from a section A to a section A_1 , the areas of the sections perpendicular to the direction of flow being also denoted by A and A_1 . By saying that the flow is "steady" we do not mean that it occurs in stream lines and without turbulence. We mean merely that it is "sensibly" steady; i. e., that such variations of speed, direction of motion, pressure, etc., as may occur at any point in the stream as a result of turbulence are so rapid that our measuring instruments do not respond to them, but indicate only time averages; and that these time averages are constant at any fixed point within the channel. Values of a property of the fluid, or of any other quantity such as speed, "at a point," are therefore to be understood as time averages over a time which is long compared with the speed of variation of the quantity to be measured, though it may appear short in the ordinary sense.

Let θ , p , v , ϵ , T , respectively, be the absolute temperature, static pressure, specific volume, internal energy per unit mass, and kinetic energy per unit mass, at the entrance section A . By the "static pressure" is meant the pressure which would be indicated by a gauge moving with the current. Let θ_1 , p_1 , v_1 , ϵ_1 , T_1 be the corresponding quantities at the exit section A_1 . Both sets of values are to be understood as averages over the whole section, as well as time averages in the sense explained above. The two sections shall be at the same level, so that the passage of fluid from A to A_1 does not involve any gravitational work.

As a unit mass of fluid crosses A , the work pv is done on it by the fluid following; and as it crosses A_1 it does the work p_1v_1 on the fluid ahead. Since the walls of the channel are nonconducting, no heat enters or leaves the fluid between A and A_1 ; hence the total energy, internal plus kinetic, increases (or decreases) by an amount equal to the work done on (or by) the fluid, and we have

$$\begin{aligned} pv - p_1v_1 &= (\epsilon_1 + T_1) - (\epsilon + T) \\ \text{or} \quad T - T_1 &= (\epsilon_1 + p_1v_1) - (\epsilon + pv) \end{aligned} \tag{1}$$

So far no assumptions have been made and equation (1) is rigorously correct for adiabatic flow between two sections at the same level. Internal heating by skin friction or the dissipation of eddies is merely a conversion of energy from one form into another and not an addition of energy; hence it does not affect the validity of equation (1) and need not appear in it.

2. INTRODUCTION OF THE MEAN SPEED INTO THE ENERGY EQUATION.

Let Q be the volume of fluid which crosses the section A per unit time, and let $S = Q \div A$; then S is the arithmetical mean, over the section, of the component velocity normal to A and along the channel. Let Q_1 and S_1 be the corresponding values at A_1 . Measuring kinetic energy, as well as work and internal energy, in normal mass-length-time units, we then set

$$T - T_1 = \frac{1}{2} (S^2 - S_1^2) \quad (2)$$

and proceed to substitute this expression for $(T - T_1)$ in equation (1).

This substitution is indispensable to further progress, but it involves an assumption which destroys the rigor of all further deductions. The deductions are, nevertheless, very approximately confirmed by experiment, and it is therefore worth while to examine the assumption.

If there were no turbulence and if the speed were uniform over each section, we should have the two separate equations

$$\begin{aligned} T &= \frac{1}{2} S^2 \\ T_1 &= \frac{1}{2} S_1^2 \end{aligned} \quad (3)$$

and equation (2) would be exact. If there is no turbulence but the speed of flow is nonuniform, approaching zero at the walls, as it must where the channel has material walls, equations (3) will not be satisfied, but we shall have $T > \frac{1}{2} S^2$ and $T_1 > \frac{1}{2} S_1^2$, because the mean square speed, which determines the kinetic energy, is always greater than the arithmetical mean speed S when the distribution over the section is not uniform. With a round pipe and nonturbulent flow $T = \frac{3}{8} S^2$ instead of $\frac{1}{2} S^2$.

In nearly all practical cases the flow of fluids is turbulent and the relation of the whole kinetic energy, including that of the turbulence, to the arithmetical mean normal component of the speed at the given section will depend on the amount of turbulence. It is impossible to say what the relation will be further than that the kinetic energy of eddies and cross currents tends to increase the error which would be involved in assuming equations (3), while, on the other hand, the fact that with increasing turbulence the speed becomes more nearly uniform over a cross section tends to decrease the difference between the mean square and the arithmetical mean of the component normal to any section.

The assumption involved in using equation (2) is not, however, so violent as that which would be involved in using equations (3) separately. For equations (3) are equivalent to

$$T - \frac{1}{2}S^2 = T_1 - \frac{1}{2}S_1^2 = 0$$

whereas equation (2) is satisfied if

$$T - \frac{1}{2}S^2 = T_1 - \frac{1}{2}S_1^2 \quad (4)$$

no matter what the value is. Equation (4) and its equivalent (2) are satisfied if the error in assuming equations (3) to hold is the *same* at both sections without vanishing or even being small. This will occur if the kinetic energy of turbulence is the same at both sections and if also the speed distributions over the two sections are such that the arithmetical mean normal speed is the same fraction of the mean-square normal speed at both. While therefore it is evident that the use of equations (3) separately might lead to conclusions at variance with facts, equation (2) may nevertheless be nearly fulfilled in practice. The agreement with observation of deductions from equations (2) and (1) shows that in many ordinary cases the error committed by treating equation (2) as exact is in reality quite insignificant.

For geometrically similar channels, the percentage error of equation (2) depends only on $\frac{DS}{\nu}$, in which ν is the kinematic viscosity of the fluid and D a linear dimension of the channel. With a given fluid in a given channel increasing S increases the turbulence, but it is not evident how this will affect the percentage error, $\frac{2T-S^2}{S^2}$, if at all. Hence, it seems possible that although turbulence increases with $\frac{DS}{\nu}$, the *percentage* error in assuming equation (2) may not increase but remain constant or even decrease. On the other hand, at a given speed S , if $\frac{DS}{\nu}$ is increased by increasing D or diminishing ν , the turbulence and the value of $\frac{2T-S^2}{S^2}$ will be increased

and there will be a greater chance that equation (2) may be sensibly in error. At a given mean axial speed S we must therefore be prepared to find greater discrepancies between experiment and results deduced from equation (2) for large channels and fluids of low kinematic viscosity than for the opposite conditions.

We shall now proceed as if equation (2) were rigorously exact, and by combining it with equation (1) we obtain

$$\frac{1}{2}(S^2 - S_1^2) = (\epsilon_1 + p_1 v_1) - (\epsilon + p v) \quad (5)$$

an equation which serves as the point of departure for the theory of the Pitot tube, the Venturi meter, the steam-turbine nozzle, and various other devices in which a stream of fluid is retarded or accelerated adiabatically.

3. ISENTROPIC FLOW OF AN IDEAL GAS.

If the physical properties of the fluid have been sufficiently investigated and if a sufficient number of quantities are measured at each of the two sections, the value of $(\epsilon + pv)$ may be computed for each section and the value of $(S^2 - S_1^2)$ found from equation (5), to the degree of approximation permitted by the assumptions which have been discussed above. A process somewhat of this nature is pursued in the design of steam-turbine nozzles, $(\epsilon + pv)$ being then the quantity known as the total heat of steam.

But when the fluid is a gas, it is usual to proceed with deductions from equation (5) by the aid of two further assumptions which enable us to compute variations of ϵ and v from observations of p alone. The first of these assumptions is that the fluid behaves sensibly as an ideal gas defined by the equations

$$pv = R\theta \quad (6)$$

$$\epsilon = \epsilon_0 + C_v (\theta - \theta_0) \quad (7)$$

in which C_v is the specific heat at constant volume, and ϵ_0 is the internal energy at the standard temperature θ_0 . The properties of ordinary gases, such as air, carbon dioxide, or coal gas, when far from condensation, are nearly in conformity with equations (6) and (7), and for such fluids no serious error is involved in making the assumption mentioned, unless very great variations of pressure and temperature are under consideration. Equations (6) and (7) imply also the relation

$$C_p = C_v + R \quad (8)$$

in which C_p is the specific heat at constant pressure.

The second assumption is that during the simultaneous changes of pressure and temperature in passing from A to A_1 the familiar isentropic relation for an ideal gas, viz,

$$\frac{\theta_1}{\theta} = \left(\frac{p_1}{p}\right)^{\frac{k-1}{k}} \quad (9)$$

remains satisfied, k representing C_p/C_v . This assumption is, of course, not exact, for while we have stipulated that the flow shall be adiabatic, the internal heating, due to viscosity causes an increase of entropy. The assumption amounts, therefore, to assuming that this irreversible internal heating is not enough to cause any sensible increase of the temperature at A_1 over what it would be if there were no internal heating at all.

The foregoing assumptions enable us to put equation (5) into a more available form. By substituting from (6) and (7) into (5), and using (8), we have

$$\frac{1}{2} (S^2 - S_1^2) = C_p (\theta_1 - \theta) \quad (10)$$

By means of (9) and (6), this may be written

$$\frac{1}{2} (S^2 - S_1^2) = \frac{C_p}{R} pv \left[\left(\frac{p_1}{p}\right)^{\frac{k-1}{k}} - 1 \right]$$

and by (8) we get $C_p/R = \frac{k}{k-1}$ so that we have

$$\frac{1}{2} (S^2 - S_1^2) = \frac{k}{k-1} pv \left[\left(\frac{p_1}{p} \right)^{\frac{k-1}{k}} - 1 \right] \quad (11)$$

which is the usual form of equation (5) for isentropic flow of an ideal gas. If the speed is known at either section, equation (10) enables us to find the speed at the other from a knowledge of C_p and an observation of the difference of temperature; while equation (11) gives us similar information in terms of the pressures at A and A_1 if the density and the ratio k are known. We shall apply this equation to both the Pitot tube and the Venturi meter.

4. THE THEORY OF THE PITOT TUBE.

To treat the Pitot tube, we consider the fluid which is approaching the dynamic opening. Starting at a point so far upstream that the presence of the Pitot tube produces no sensible disturbance there, a particle of fluid approaches the dynamic opening, slows down, and mixes with the permanent high-pressure cap of nearly stationary fluid, which covers the dynamic opening and communicates with the differential gauge through the impact tube. The same particle, or another indistinguishable from it, emerges from the cap and, being accelerated by the now positive pressure gradient, flows on along the impact tube, finally acquiring a sensibly constant speed when it has reached a region of sensibly constant pressure. We wish to apply equation (5) to this motion if we can find a plausible way of doing so.

Starting with the contour of a small plane area, in the undisturbed current and perpendicular to its general direction, we construct, in imagination, a tubular surface of which the sides are at every point parallel to the mean direction of motion of the fluid past that point, as found by averaging with regard to time. If the motion is not turbulent, this tube is a tube of flow and no fluid passes in or out through its sides. If the motion is turbulent, as it nearly always is in practice, the *same* fluid does not flow continuously along the tube as it would if the walls were impervious. On the contrary, particles of fluid are continually leaving the tube in consequence of the turbulent time-changes of the direction of motion at any fixed point; and these particles are continually replaced by others, of the same total mass, which enter from without the tube. But on the whole, the particles which enter have the same average component velocity along the tube as those which leave; for unless this were true we could, merely by *imagining* the tubular surface, generate within the fluid a particular filament which was moving, on the whole, faster or slower than the surrounding fluid. We conclude that the net effect of turbulence is the same as if the imaginary tube walls were made rigid and perfectly reflecting for mechanical impact without exerting any skin friction on the fluid flowing along them.

If the whole current of fluid is at a sensibly uniform temperature across its general direction, no heat passes in or out through the tubular surface, and equation (5) may be applied as though we had an impervious nonconducting channel to deal with. Furthermore, if the tube is of small section, the axial speed, averaged with regard

to time, will be the same at all points of any one cross section. Hence the application of equation (5), involving the assumption of equation (2) or (4), is better justified than for a material tube in which skin friction would cause the axial speed to be nonuniform over any section.

We now consider such an imaginary tube, starting in the undisturbed fluid some distance upstream from the dynamic opening of the Pitot tube, passing into the high-pressure cap over the opening and emerging again at the edge of the opening, to continue its course along the side of the impact tube. The portion of the imaginary tube which passes through the high-pressure cap may be regarded as an enlargement of cross section at which the mean axial speed is so reduced that its square is negligible in comparison with the square of the speed at distant points. If we let A be a section at some distance upstream and A_1 be the section of the tube where it passes through the high-pressure cap, S_1^2 is negligible in comparison with S^2 and equation (5) gives us

$$S = \sqrt{2[(\epsilon_1 + p_1 v_1) - (\epsilon + pv)]} \quad (12)$$

in which S is the speed of the undisturbed current; ϵ , p , and v refer to conditions in the undisturbed current; and ϵ_1 , p_1 , v_1 refer to conditions in the dynamic opening. The static pressure, which the static opening is designed to receive and transmit to the gauge, is p ; while the pressure received by the dynamic opening is that in the permanent high-pressure cap, or p_1 .

Equation (12) is the general form of the Pitot tube equation for any fluid, whether compressible or not. In the case of a liquid, the internal energy and specific volume are not appreciably affected by the very small pressure variations involved, so that we have $\epsilon_1 = \epsilon$ and $v_1 = v$ and equation (12) reduces to

$$S = \sqrt{2v(p_1 - p)} = \sqrt{2 \frac{p_1 - p}{\rho}} \quad (13)$$

ρ being the density of the liquid. If the pressure difference is expressed as a head h of liquid of density d , we have $p_1 - p = gh$ and equation (13) takes the form

$$S = \sqrt{2g \frac{d}{\rho} h} \quad (14)$$

the usual form of the Pitot tube equation for a perfect or ideal tube.

Even when the fluid is a gas, if S is small and $(p_1 - p)$ therefore also small, ϵ_1 and v_1 are nearly the same as ϵ and v so that equations (13) and (14) remain approximately correct—admitting all the assumptions made—though it is not evident how close the approximation will be. But if the speed and the pressure difference are great enough to cause sensible compression, we must return to equation (5) and introduce the conditions for adiabatic flow of a gas, as was done in section 3 in arriving at equation (11). The fact that equation (14) does agree well with observations on gas currents at moderate speeds, shows that no great error is involved in neglecting compressibility

and justifies us in going on to find a closer approximation by treating the gas as ideal and thereby using an approximation to the compressibility.

Assuming, then, that equation (11) is applicable to the imaginary current tube now under discussion, we have, by setting $S_1^2 = 0$, the equation

$$S = \sqrt{\frac{2k}{k-1} \frac{p}{\rho} \left[\left(\frac{p_1}{p} \right)^{\frac{k-1}{k}} - 1 \right]} \quad (15)$$

If we now set $\frac{p_1}{p} = 1 + \Delta$ and $\frac{k-1}{k} = n$ we have

$$\left(\frac{p_1}{p} \right)^{\frac{k-1}{k}} - 1 = n\Delta \left\{ 1 + \frac{n-1}{2} \Delta + \frac{(n-1)(n-2)}{1 \cdot 2 \cdot 3} \Delta^2 + \text{etc.} \right\}$$

Setting the $\{\dots\} = X^2$, substituting in equation (15), and noticing

that $n \Delta = \frac{k-1}{k} \frac{p_1 - p}{p}$ we have

$$S = X \sqrt{2 \frac{p_1 - p}{\rho}} \quad (16)$$

which differs from equation (13), obtained by disregarding compressibility, only in the correction factor

$$X = \left\{ 1 + \frac{n-1}{2} \Delta + \frac{(n-1)(n-2)}{1 \cdot 2 \cdot 3} \Delta^2 + \frac{(n-1)(n-2)(n-3)}{1 \cdot 2 \cdot 3 \cdot 4} \Delta^3 + \dots \right\}^{\frac{1}{2}} \quad (17)$$

The quantity $\Delta = \frac{p_1 - p}{p}$ is the fractional rise of pressure at the mouth of the impact tube: hence it is, in practice, always a small quantity. The value of k for gases is always between $\frac{5}{3}$ and 1, so that $n = \frac{k-1}{k}$ is always between $\frac{2}{3}$ and 0. Accordingly the terms of X containing Δ are alternately negative and positive and when Δ is small the series converges rapidly, the sum of all the terms in Δ being nearly equal to the first term alone, so that if the first is negligible the sum is negligible and X may be set equal to unity.

The ratio of the specific heats of air is 1.40. Hence $n = \frac{2}{7}$ and we have

$$X = \left\{ 1 - \frac{5}{14} \Delta + \frac{10}{49} \Delta^2 - \frac{95}{686} \Delta^3 + \text{etc.} \right\}^{\frac{1}{2}} \quad (18)$$

If an error of y per cent. in S is permissible, an error of y per cent. may also be allowed in the correction factor X and the value of Δ may be, at most, such as to make $\frac{5}{28} \Delta = \frac{y}{100}$ or $\Delta = 0.056y$. For any assigned values of the error y per cent. in the speed, the value of S can be found from equation (13).

Let us suppose, for example, that the Pitot tube is to be used for measuring the speed of an aeroplane and that an accuracy of 0.5 per cent. is sufficient. Then we have $\Delta = 0.028$ and $p_1 - p = 0.028 p$. To find what speed would give this head on the differential gauge, we set $p = 1$ atmosphere $= 1.013 \times 10^6$ dynes/cm.² and $\rho = 0.0013$ gram/cm.³ and substitute in (13), the result being $S = 66.1$ m./sec. $= 212$ ft./sec. $= 148$ miles/hour. Since an accuracy of better than 1.0 per cent. can hardly be demanded of an aeroplane speedometer, it is evident that for all ordinary speeds of flight, no correction for compressibility is needed and equations (13) and (14) may be used.

It is of course a simple matter to compute values of the correction factor X for various speeds; but in view of the uncertainties and assumptions involved in the theory, the results would have a misleading appearance of accuracy and would not in fact be worth the labor of computation. What has been shown is sufficient, namely, that if a Pitot tube does not measure the speed of an aeroplane correctly the error is not due to neglecting the compressibility of the air.

5. THE THEORY OF THE VENTURI METER.

The Venturi meter is a channel of varying cross section, and we may apply to it the general equations of flow which have already been developed. In doing so, we shall let A be the entrance section of the meter where p is measured, and A_1 be the throat section at which the diminished pressure p_1 is observed. We have to use equation (5).

If the meter is used for measuring the flow of a liquid of density ρ we may set $\epsilon_1 = \epsilon$ and $v_1 = v$ as we did in treating the Pitot tube, and equation (5) then gives us

$$S_1^2 - S^2 = 2 \frac{p - p_1}{\rho} \quad (19)$$

Neither S nor S_1 vanishes; but in addition to (19) we have the equation of continuity which for a fluid of constant density may be written

$$S_1 A_1 = S A \quad (20)$$

and (19) and (20) together enable us to find either S or S_1 . If we represent the area ratio by a single symbol

$$\frac{A}{A_1} = \alpha > 1 \quad (21)$$

we have

$$S = B \sqrt{2 \frac{p - p_1}{\rho}} \quad (22)$$

where

$$B = \sqrt{\frac{1}{\alpha^2 - 1}} \quad (23)$$

and B is a constant characteristic of the given meter.

Comparing (22) with (13), the equation for the Pitot tube in a liquid, we see that they differ only by the factor B which depends on

the area ratio α . If $\alpha = \sqrt{2}$, $B = 1$ and the observed Venturi pressure difference ($p - p_1$) will be the same as would be shown by a Pitot tube with its dynamic opening in the entrance of the meter. For various values of the ratio $\frac{D}{D_1}$ of entrance diameter to throat diameter we have the following values of B :

$\frac{D}{D_1} =$	1.5	2.0	2.5	3.0	4.0
$\alpha =$	2.25	4.00	6.25	9.00	16.00
$B =$	1.569	3.874	6.170	8.944	15.77

Evidently, the Venturi pressure difference may easily be made much larger than the Pitot pressure difference at the entrance speed and the gauge reading be made much more sensitive.

If the fluid is a gas instead of a liquid, compressibility will still be negligible at sufficiently low speeds, as for the Pitot tube, and equation (22) may be used; but in general the compressibility must be allowed for. To treat the flow of a gas, we have to make the same assumptions as in section 3, namely, that the gas is sensibly ideal and that the flow from the entrance section A to the throat A_1 is sensibly isentropic, the combined effect of heat conduction to or from the walls of the meter, and of internal heating in the gas itself, being insignificant. We then have to apply equation (11) to the case in hand, and if for simplicity we represent the pressure ratio by a single symbol and write

$$\frac{p_1}{p} = r < 1 \quad (24)$$

we have by equation (11)

$$S_1^2 - S^2 = \frac{2k}{k-1} \frac{p}{\rho} \left[1 - r^{\frac{k-1}{k}} \right] \quad (25)$$

ρ being the density of the gas at the pressure p as it crosses the entrance section.

To combine with (25) we have the equation of continuity

$$S_1 A_1 \rho_1 = S A \rho$$

and if we remember that during isentropic compression or expansion of an ideal gas pv^k remains constant, the equation of continuity may be written

$$S_1 = \frac{\alpha}{r^{1/k}} S \quad (26)$$

By using (26) to eliminate S_1 from (25) we now obtain the equation

$$S = \left\{ \frac{2k}{k-1} \frac{r^{2/k}}{\alpha^2 - r^{2/k}} \frac{p}{\rho} \left(1 - r^{\frac{k-1}{k}} \right) \right\}^{1/2} \quad (27)$$

by means of which the entrance speed S may be computed from the observed pressure ratio $r = p_1/p$ when the area ratio α and the properties of the gas are known. Since we are treating the gas as

ideal, p/ρ is, for any given gas, proportional to the absolute temperature θ at the entrance section, and we may write $\frac{p}{\rho} = \frac{p_o}{\rho_o} \frac{\theta}{\theta_o}$, ρ_o being the density of the gas at the standard pressure p_o and temperature θ_o .

For air, $\frac{C_p}{C_v} = k = 1.40$ and if we insert the known value of ρ_o at 1 atmosphere and 0° C. and set

$$S = Y \sqrt{\frac{\theta}{\theta_o}} \tag{28}$$

where

$$Y = \left\{ \frac{2k}{k-1} \cdot \frac{r^{2/k}}{\alpha^2 - r^{2/k}} \left(1 - r^{\frac{k-1}{k}} \right) \frac{p_o}{\rho_o} \right\}^{1/2}$$

we have the values of Y shown in the following table for various pressure ratios r and for meters in which the throat diameter is $\frac{1}{2}$, $\frac{1}{3}$, or $\frac{1}{4}$ of the entrance diameter, i. e., $\alpha = 4, 9, \text{ or } 16$. If t is the temperature at entrance, on the centigrade scale $\frac{\theta}{\theta_o} = \frac{273+t}{273}$ while if t is measured on the Fahrenheit scale,

$$\frac{\theta}{\theta_o} = \frac{460+t}{492}$$

THE VENTURI METER FOR AIR.

Values of Y in $S = Y \sqrt{\frac{\theta}{\theta_o}}$

S = Speed at entrance to meter $\alpha = \frac{A}{A_1} = \frac{\text{entrance area}}{\text{throat area}}$

r = throat pressure \div entrance pressure = p_1/p θ = absolute temperature of air at entrance.

θ_o = absolute temperature of ice point.

Values of Y .

r	$\alpha = 4$			$\alpha = 9$			$\alpha = 16$		
	M./sec.	Ft./sec.	Mile/hour.	M./sec.	Ft./sec.	Mile/hour.	M./sec.	Ft./sec.	Mile/hr.
0.9998	1.44	4.74	3.23	0.626	2.05	1.400	0.350	1.150	0.784
.999	3.23	10.60	7.23	1.40	4.59	3.13	0.784	2.57	1.753
.995	7.21	23.65	16.13	3.12	10.24	6.98	1.75	5.74	3.91
.99	10.16	33.34	22.7	4.40	14.11	9.85	2.47	8.09	5.52
.98	14.3	46.48	32.0	6.19	20.3	13.85	3.47	11.38	7.76
.95	22.2	72.8	49.6	9.62	31.6	21.5	5.39	17.7	12.06
.90	30.4	99.8	68.0	13.2	43.4	29.6	7.41	24.3	16.57
.80	40.2	131.7	89.8	17.5	57.5	39.2	9.82	32.2	22.0
.60	48.1	157.9	107.6	21.1	69.3	47.2	11.86	38.9	26.5

Computed on the assumptions $p v = R \theta$, $C_v = \text{constant}$, $\frac{C_p}{C_v} = 1.400$.

$p_o = 1.01323 \times 10^6$ dyne/cm².

$\rho_o = 0.0012928$ gm cm³ at 760 mm. and 0° C

REPORT No. 3.

**REPORT ON INVESTIGATIONS OF AVIATION WIRES
AND CABLES, THEIR FASTENINGS AND
TERMINAL CONNECTIONS.**

By JOHN A. ROEBLING'S SONS CO., TRENTON, N. J.

REPORT No. 3.

REPORT COVERING INVESTIGATIONS OF AVIATION WIRES AND CABLES, THEIR FASTENINGS AND TERMINAL CONNECTIONS.

By JOHN A. ROEBLING'S SONS CO.

In reference to our investigations of aviation wires and cables, their fastenings and terminal connections for stays, we have failed to find from past practice anything that would allow us to determine the best lines on which to proceed; therefore our study is not limited to any one stay design.

In making our investigation we have aimed to eliminate the use of acid and solder, imperfect bends, flattening of cable on bends, injury to wire, strand, and cord due to unskillful handling of material in the field; and based on our study of present methods of manufacture of aeroplanes we believe it is possible to manufacture the complete stay here at the factory, proof test same to 50 per cent of its ultimate strength, measure same under stress, and therefore eliminate any uncertainty as to strength of terminal connection, length of stay, and workmanship.

On this basis our research covered not only the terminal connection for shop attachment, but also a connection that would allow repairs to be made in the field without requiring the use of blow torch and solder, and from the following tests it will be readily seen that the development eliminates any doubt on this point.

We find present practice considers "the solid wire stay," consisting of one wire of suitable diameter and known to the trade as "aviation wire"; "the strand stay," consisting of either 7 or 19 wires stranded together and known to the trade as "aviator strand"; also "the cord or rope stay," consisting of 7 strands twisted together forming a rope, the strands being either 7 wires or 19 wires; and the rope known to the trade as "aviator cord."

THE SOLID WIRE STAY.

PLATE NO. 1.

Figure 1.

Figure 1 shows the type most generally in use. An eye or loop is formed in tinned aviator wire and a ferrule made by wrapping a thin flat strip around both wires. The free end of the wire is then bent back over the flat ferrule, holding it in place, and the whole terminal dipped in solder. This type of terminal is far from being satisfactory. Its mechanical strength is low and variable. The process of soldering involves the possibility of establishing a source of corrosion, as well as injuring the quality of the wire. The making of such a terminal is almost necessarily a factory proposition and provides no means for quick and efficient field replacements.

Figure 2.

The standard terminal in Europe is shown in figure 2. This consists of an oval spring wire ferrule applied in almost the same manner as the flat wire ferrule in figure 1. Particular emphasis is placed on the method of forming the eye in the stay before applying the ferrule. Radius of curve at "A" and "B," figure 2, must be exactly the same as radius at "C." This is called a perfect eye. No solder is used. The ferrule is made of wire of the same size as wire in stay and is "spring" quality. Nine convolutions constitute the standard length of ferrule. The hole in the ferrule is oval and a snug fit for the two wires forming the eye of stay. Both wire and ferrule are tin coated. The free end of the wire is bent back over the ferrule and is not fastened in any way. This holds the ferrule firmly against the shoulder at "A" and "B."

Tests made on stays having this type of terminal did not show very satisfactory results. Eighty per cent of the tests showed an efficiency of less than 65 per cent, the free end of the wire slipping through the ferrule at failure of the stay. In the remaining 20 per cent of the tests the wire broke at "A," the stays having an average efficiency of 68 per cent of the total strength of the wire.

Figure 3.

Figure 3 shows eye having radii "A" and "B" different from "C," which is not allowed in foreign specifications and practice. Tests made on terminals having an eye formed as in figure 3 always resulted in pulling through the free end of the wire at low efficiency.

Figure 4.

In order to determine whether the direction of pitch of the spiral spring ferrule had any influence in determining the efficiency of the stay, sample terminals having left-hand ferrules as in figure 2 and right-hand ferrules as in figure 4 were made with a perfect eye in both cases, tested, and compared. The left-hand ferrule clearly showed an efficiency of about 5 per cent more than the right-hand ferrule. In testing the latter the free end of the wire slipped in every case.

Figure 5.

In figure 5 an effort was made so secure the free end of the wire against slipping when strain was applied to the stay by wrapping this end around the main stay wire. Tests on this construction showed an average efficiency of 72 per cent, fracture taking place at "B."

Figure 6.

Another method of securing the loose end consisted of tying the end down on the ferrule with fine annealed wire as shown in figure 6. Tests made on this construction showed an average efficiency of 70 per cent, fracture taking place at "A."

CONCLUSIONS BASED ON ABOVE TESTS.

Observations made during tests of terminals 5 and 6 showed clearly that the weak points of this construction existed at "B" and "A," respectively, and that it was necessary to increase the friction between the walls of ferrule and the wire of the stay under strain to increase efficiency. Reliable information at hand showed that the same con-

clusions had been aimed at by foreign engineers stationed in America and that they had solved the problem by soldering the spring ferrule terminal in the same manner that Americans had adopted with the flat wire terminal.

HORN'S IMPROVED TERMINAL CONNECTION.

In an effort to avoid the use of solder with its many objectionable features types of construction as shown in figures 7 to 15, inclusive, were originated and tested. In every case the spring ferrule with left-hand pitch was adopted. The loose end of wire was secured with a tie or simple wire loop or clip as shown. Numerous tests made at intervals throughout the entire series of tests with wires having strengths of 1,600, 1,800, and 2,300 pounds showed conclusively that there is no difference in efficiency of stays using wire of any of the above strengths.

Figure 7.

Figure 7 shows a wedge between the ferrule and free end of wire so placed that as strain is applied to the stay and the bend in the free end of wire drawn toward the ferrule the wedge is forced in and thus increases the friction between the wall of the ferrule and the main stay wire. Average efficiency secured, 82 per cent; range of efficiency, 80 to 84 per cent. Fracture at "A" in ferrule.

Figure 8.

Figure 8 shows two wedges with a connecting yoke. The wedges enter on each side between the two wires and force them apart and against the wall of the ferrule as strain is applied. The wedges are forced in by pressure on the connecting yoke which passes under the bend of the free end of the wire as this free end is drawn into the ferrule under strain. Average efficiency of terminal in test equals 80 per cent. Range of efficiency in tests made, 79 to 83 per cent. Fracture at "A."

Figure 9.

In construction of figure 9 two wedges were used as in figure 8, but the yoke was replaced by a washer with two holes in it encircling both wires of the stay. Pressure on the wedges was supposed to be secured under strain by the drawing in of the loose end under strain. This result was not realized as the washer became locked on the main wire and broke the loose end at "D." Efficiency secured was only 70 per cent; range, 60 to 75 per cent.

Figure 10.

In figure 10 two wedges were used as in figure 8 and figure 9. The free end of the wire was wrapped around the main stay wire and pushed in the wedge as initial slippage occurred. Average efficiency, 84 per cent; range, 75 to 87 per cent. Fracture at "A" in ferrule.

Figure 11.

Figure 11 shows a double eye with no wedge. Standard straight ferrule with free end tied. This type of eye could only be used on stays when turnbuckles or hooks to be attached had open eye. Average efficiency in test, 80 per cent; range, 74 to 82 per cent. Fracture at "A."

Figure 12.

Figure 12 again shows a double eye in stay with a single wedge between wires on the eye end of the ferrule. As ferrule is drawn down against shoulders "A" and "B" the wedge is forced in. This increases friction of wires against ferrule at "A" and "B," but not at "D" and "E." Average efficiency, 85 per cent; range, 80 to 87 per cent. Fracture at "A."

Figure 13.

Figure 13 shows a construction consisting of a double eye in stay, a single wedge under the eye, and an oval spring wire ferrule tapered at the same angle as the wedge. In this case the pressure of the wedge forces both wires throughout the entire length of the ferrule against the walls of the ferrule and this increases friction on the ferrule uniformly as the strain increases on the stay and reduces the strain at the weak points "A" and "B" proportionately. Fracture always took place at "E." Average efficiency, 94 per cent; range, 92 to 95 per cent.

In figure 13 we have the most efficient terminal tested. It has none of the objections of a soldered terminal. It is simple, parts are inexpensive, strong, and few in number. It is an ideal terminal for emergency use in the field.

Figures 14 and 15.

Figures 14 and 15 show modifications of this type to overcome any objections which might be raised to the double eye. The wedge and a substantial thimble are combined in one piece. To secure more points of contact, and consequently greater friction, and also for greater flexibility, the taper ferrule is made of finer wires and with more convolutions. The wedge thimble may be open or closed, as desired. Fracture took place at "E." Average efficiency, 94 per cent; range, 92 to 96 per cent.

Summary of tests for efficiency.

Terminal.	Average efficiency.	Range of efficiency.	Points of fracture.	Remarks.
	<i>Per cent.</i>	<i>Per cent.</i>		
1.....	80	60-90	"A" or "B"	American, soldered.
2.....	65	60-75	"A" or slipped.	Foreign, proper eye.
3.....	62	60-65	Slipped....	Foreign, improper eye.
4.....	60	59-61	do.....	Right-hand ferrule.
5.....	72	65-75	"B".....	End wrapped around stay.
6.....	70	68-78	"A".....	End tied to ferrule.
7.....	82	80-84	"A".....	Wedge under hook.
8.....	80	79-83	"A".....	Two wedges with yoke.
9.....	70	60-75	"D".....	Two wedges with washer.
10.....	84	75-87	"A".....	Two wedges end wrapped.
11.....	80	74-82	"A".....	Double eye, no wedge.
12.....	85	80-87	"A".....	Double eye, 1 wedge.
13.....	94	92-95	"E".....	Tapered ferrule, double eye, wedge.
14-15.....	94	92-96	"E".....	Thimble wedge T. F. single eye.

NOTE.—These tests were made with wire having a diameter of 0.102 inch and a strength of 1,600, 1,800, and 2,300 pounds. No difference in efficiency of stay was found by using wire of any of these strengths.

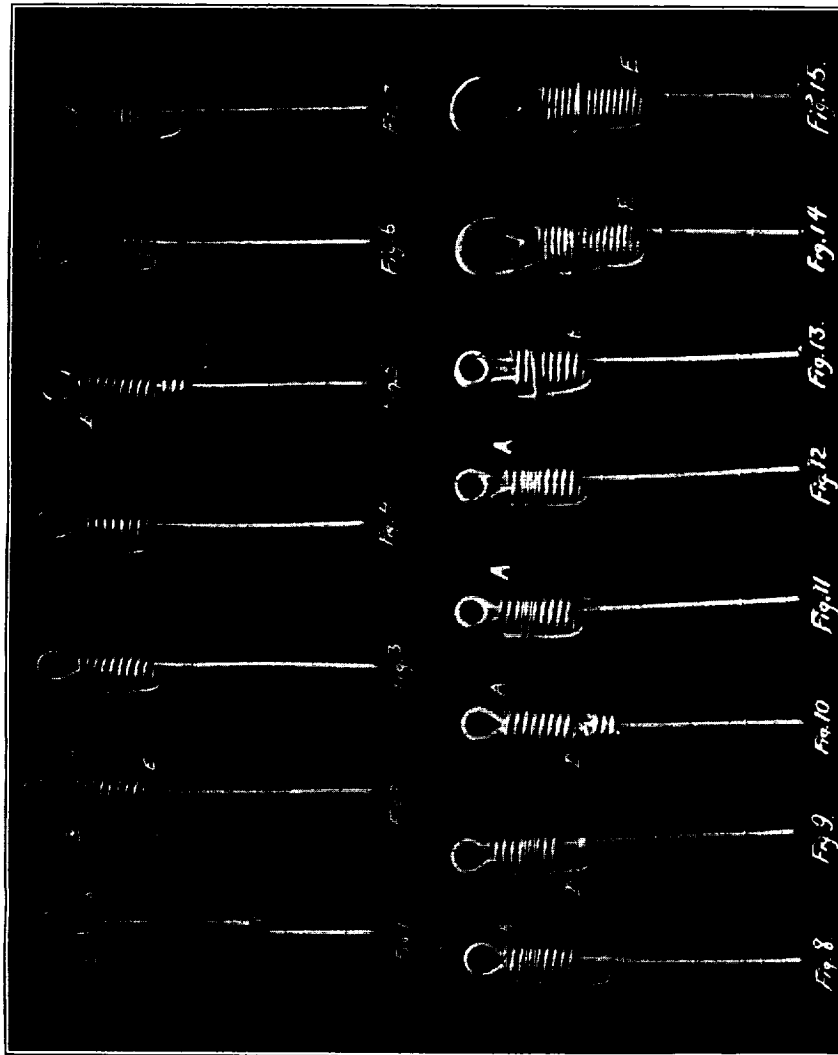

PLATE NO. 1.

S. Doc. 268, 64-1.

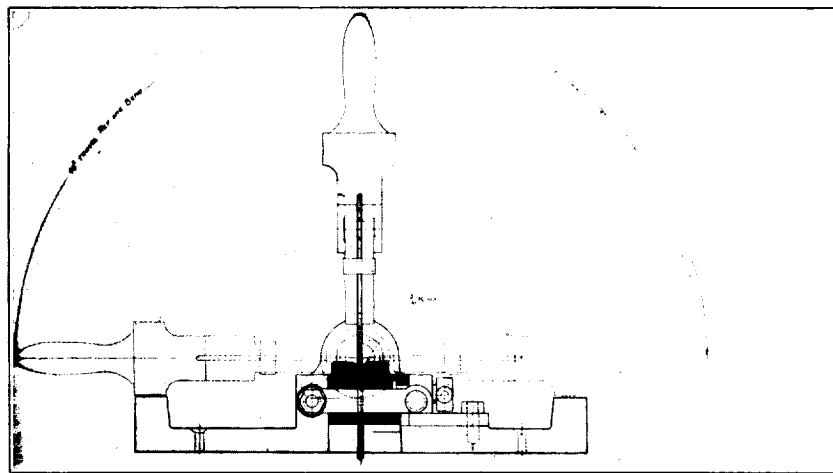

PLATE NO. 2.

S. Doc. 268, 64-1.

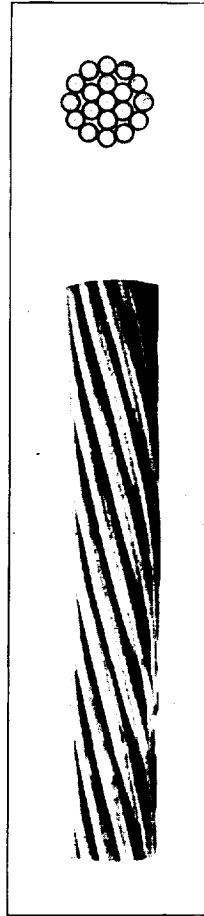

PLATE No. 3.

STANDARD WIRE FOR STAYS FOR AEROPLANES.

The original object in the manufacture of this material was the securing of the wire as strong as possible in order to reduce the weight as much as possible. This resulted eventually in the manufacture of a wire so hard and strong that difficulty was experienced in forming the eye and bend over the ferrule without breaking the wire. The result of this was a lack of confidence in high-strength wire, and in some cases the reaction extended to the use of a wire which could properly be classed as a soft wire. The process of soldering terminals on wire stays undoubtedly helped to a great extent in building up this prejudice. Nevertheless it is still true, as at first, that a strong wire which is serviceable permits the possibility of reducing weight and is therefore desirable. The great number of tests on wire and stays, which were necessary to determine the properties of different types of terminals as described above, afforded a very excellent opportunity to note conclusively the effect of using various grades and strengths of wire. We determined that it was all important that the wire should be tough and ductile as well as strong. All bends should be made without danger of fracture. In addition to requirement for tensile strength, we found it necessary to recommend requirements for torsion and bend. As the per cent efficiency of the stay due to loss of strength at terminal is as great with a strong wire as with a weaker wire, as was clearly demonstrated in our tests, it followed conclusively that as high a strength as can be secured commercially under the conditions of torsion and bend test required was desirable. The following specification is therefore recommended as representing suitable high-grade material for the purpose.

Standard aviator wire (tinned).

Diameter (inches).	American gauge (Brown & Sharpe).	Nearest fraction of inch.	Minimum breaking strain.	Minimum torsion in 6 inches.	Minimum number of bends through 90° over $\frac{1}{4}$ inch radius of jaws.	Weight in pounds per 100 feet.
0.204	4	$\frac{1}{8}$	6,700	9	4	11.15
.182	5	$\frac{3}{16}$	5,500	10	4	8.84
.162	6	$\frac{3}{8}$	4,500	11	5	7.01
.144	7	$\frac{7}{16}$	3,700	12	6	5.56
.128	8	$\frac{1}{2}$	3,000	14	8	4.40
.114	9	$\frac{5}{8}$	2,500	16	9	3.50
.102	10	2,000	18	11	2.77
.092	11	$\frac{3}{4}$	1,620	21	14	2.20
.081	12	$\frac{5}{8}$	1,300	24	17	1.744
.072	13	1,040	27	21	1.383
.064	14	$\frac{1}{2}$	830	31	25	1.097
.057	15	660	34	29	.870
.051	16	540	39	34	.690
.045	17	$\frac{3}{4}$	425	44	42	.547
.040	18	340	49	52	.434
.036	19	280	55	70	.344
.032	20	$\frac{3}{2}$	225	61	85	.273
.028	21	175	70	105	.216

PLATE NO. 2.

Breaking strain.—Test sample should be at least 15 inches long, free from nicks or bends. It should measure 10 inches in the clear between the jaws of a standard testing machine. Load should be applied uniformly at a speed not exceeding 1 inch per minute.

Torsion.—Test sample should be gripped by two vises 6 inches apart. One vise is turned uniformly at a speed not exceeding 60 revolutions per minute. On the large size of wire this speed should be reduced sufficiently to avoid undue heating of the wire. The vise which is not turned should have free lateral movement in either direction.

Bend test.—Wire for bending test should be a straight piece. One end is clamped between jaws having their upper edges rounded to 3/16-inch radius. The free end of the wire is held loosely between two guides and bent 90° over one jaw. This is counted one bend. On raising to vertical position the count is two bends. Wire is bent to the other side and so forth, alternating to fracture, each 90° bend counting one.

Diameter of strand.	Breaking strength of strand.	Approximate weight per 100 feet.
$\frac{5}{16}$	12,500	20.65
$\frac{1}{4}$	8,000	13.50
$\frac{3}{32}$	6,100	10.00
$\frac{7}{32}$	4,600	7.70
$\frac{5}{16}$	3,200	5.50
$\frac{3}{8}$	2,100	3.50
$\frac{1}{2}$	1,600	2.60
$\frac{3}{4}$	1,100	1.75
$\frac{5}{8}$	780	1.21
$\frac{3}{4}$	500	.78
$\frac{1}{2}$	185	.30
7 wire }		

PLATE NO. 3.

ROEBLING 19-WIRE GALVANIZED AVIATOR STRAND.

Roebling galvanized aviator strand consists of 19 fine wires of great strength stranded together. On account of its small size the $\frac{1}{8}$ -inch diameter strand is made of seven wires. This strand is not very flexible and is used for stays. This strand is approximately one and one-third times as elastic as a solid wire of the same material.

Thimble spliced in each end.

Diameter of strand.	Breaking strength of strand.	Breaking strength of stay.	Efficiency (per cent).	Approximate weight per 100 feet.
$\frac{1}{4}$	8,000	7,200	90.0	13.50
$\frac{3}{32}$	6,100	5,500	90.0	10.00
$\frac{5}{32}$	4,600	4,180	91.0	7.70
$\frac{3}{8}$	3,200	3,000	93.7	5.50
$\frac{1}{2}$	2,100	2,060	98.2	3.50
$\frac{3}{4}$	1,600	1,570	98.1	2.60
$\frac{5}{8}$	1,100	1,100	100	1.75
$\frac{3}{4}$	780	780	100	1.21
$\frac{1}{2}$	500	500	100	0.78

S. Doc. 268, 64-1.

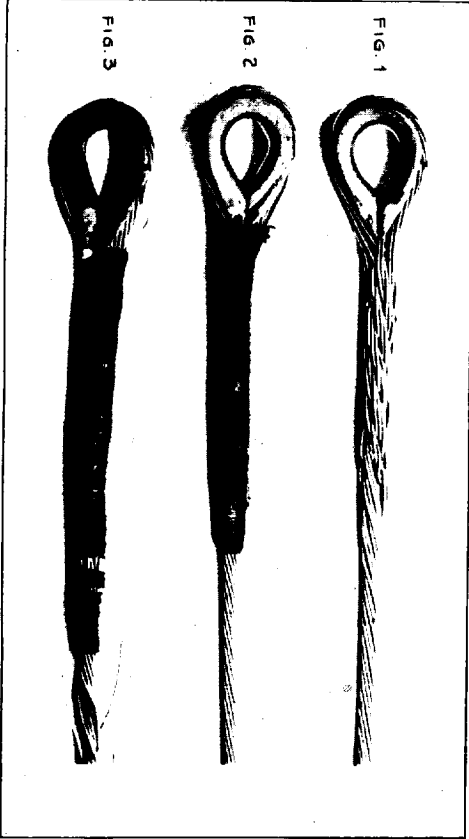

PLATE No. 4.

S. Doc. 268, 64-1.



PLATE No. 5.

S. Doc. 268, 64-1.

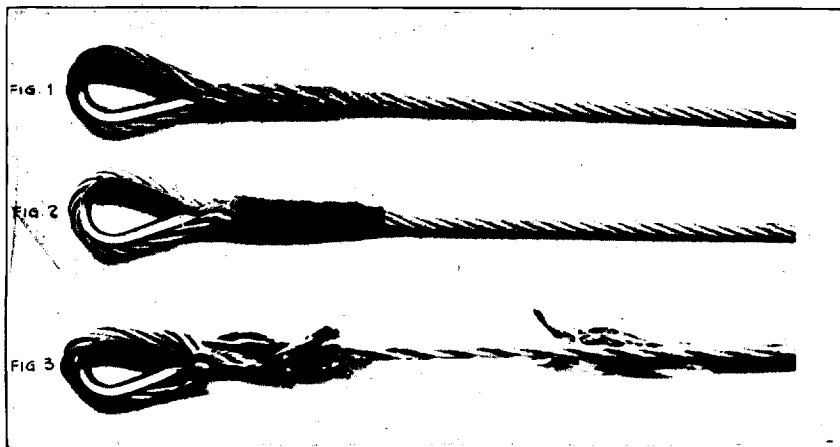

PLATE No. 6.

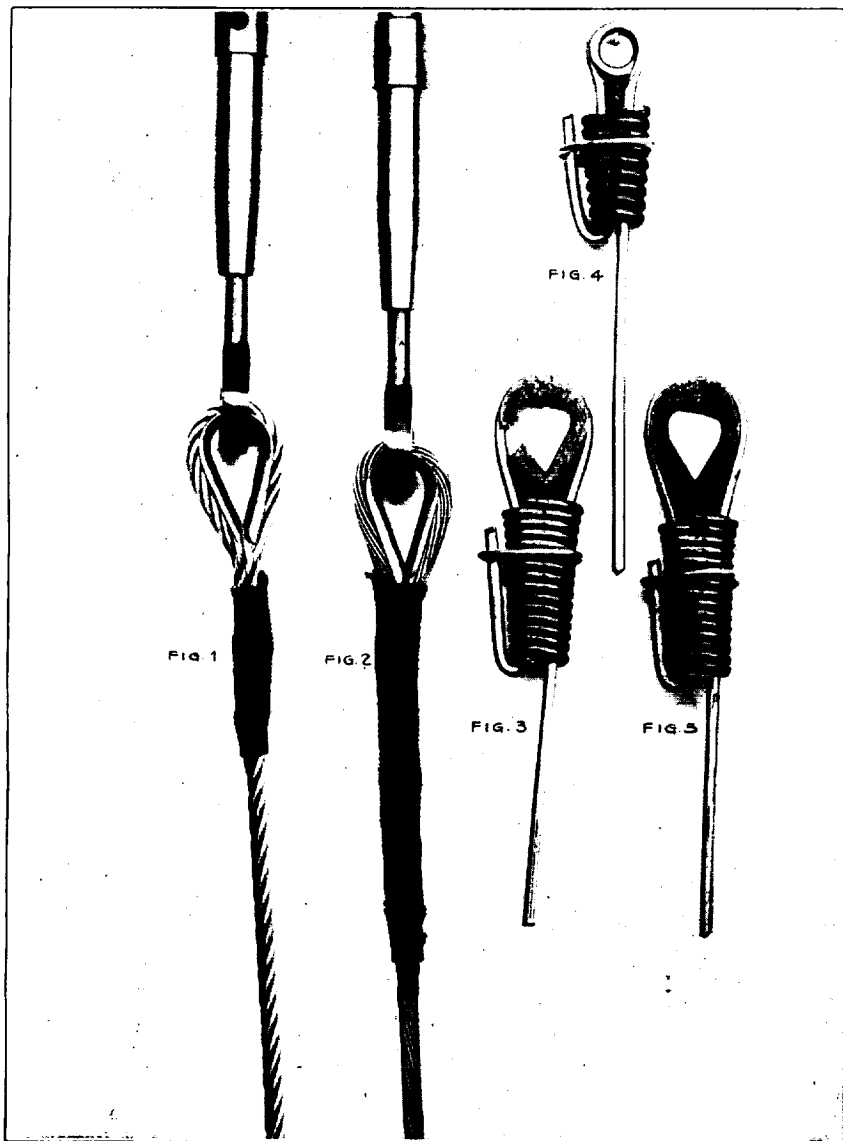

PLATE NO. 8.

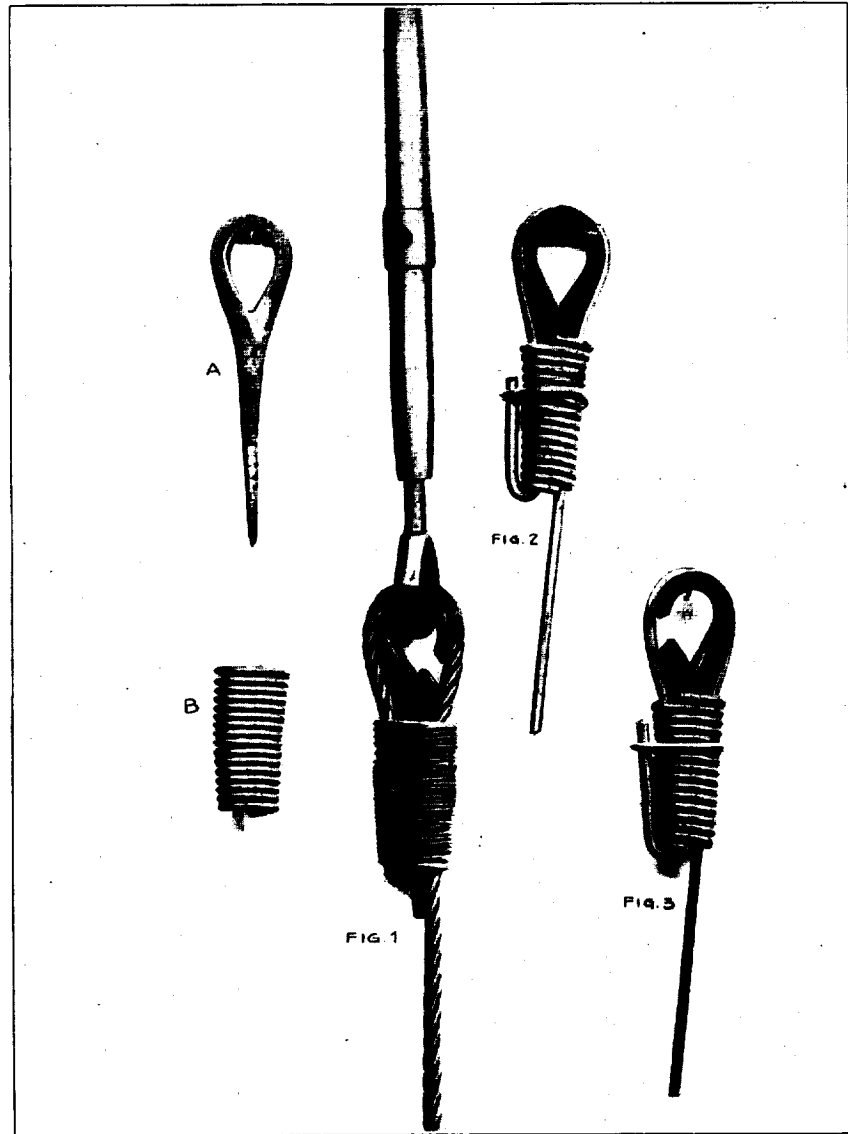

PLATE NO. 9.

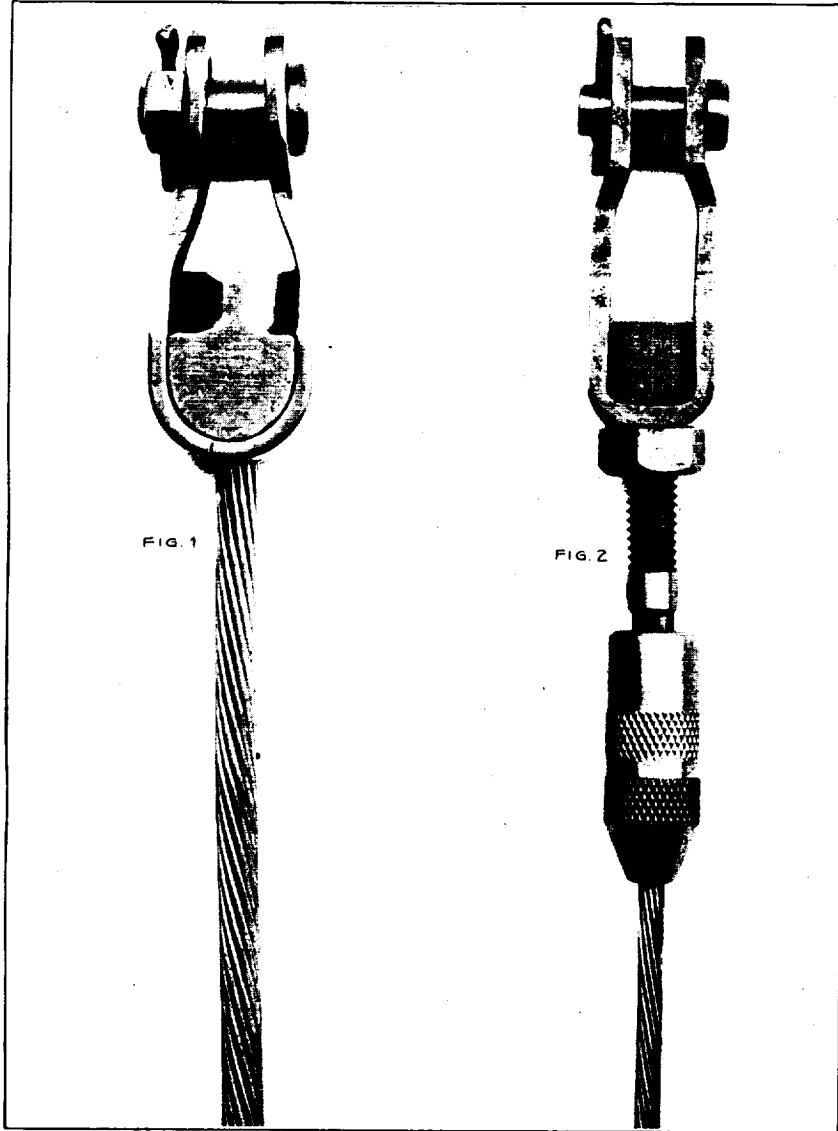

PLATE No. 10.

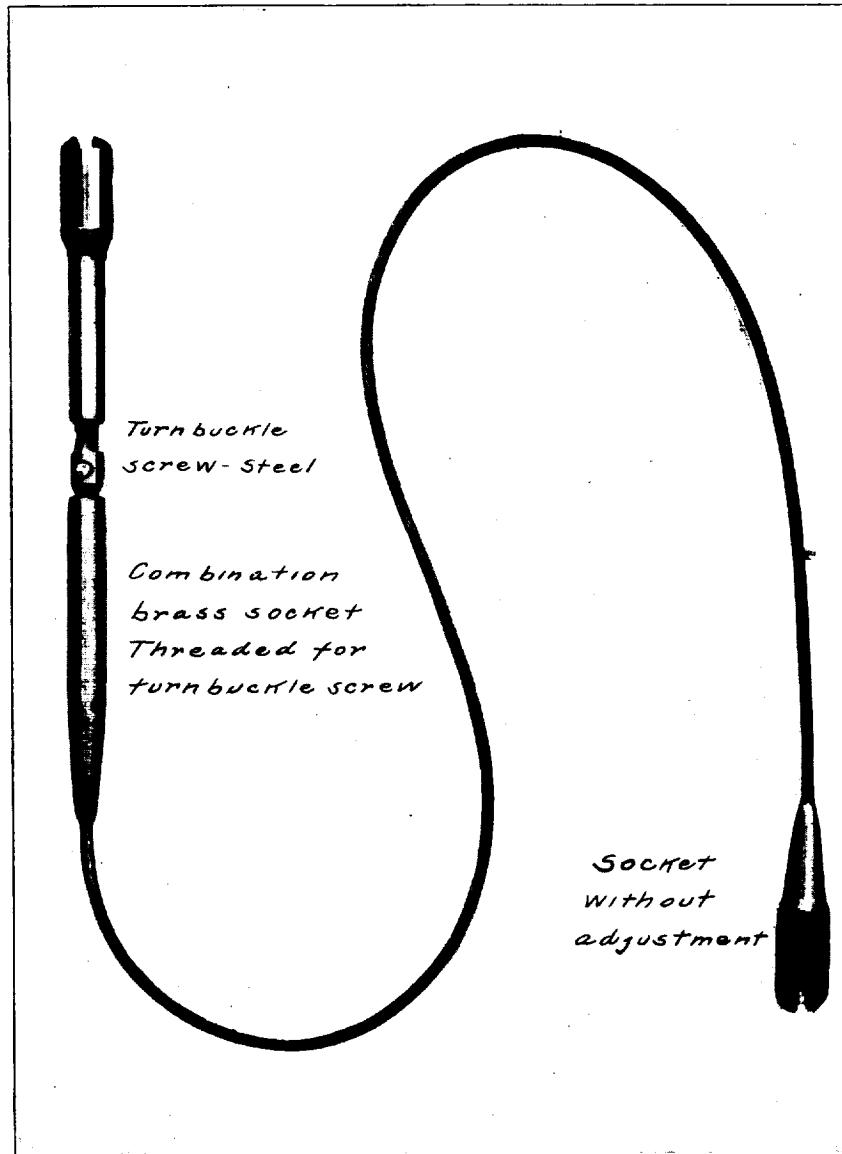

PLATE NO. 10 A.

PLATE NO. 4.

ROEBLING 19-WIRE GALVANIZED AVIATOR STRAND.

Figure No. 1 shows thimble spliced in 19-wire galvanized aviator strand.

Figure No. 2 shows the splice after the serving is applied.

Figure No. 3 shows the broken wires after the stay had been tested to destruction in the testing machine. It will be noted there are four broken wires. This break always occurs at the last tuck in the splice and never around the thimble.

Diameter of cord.	Breaking strength cord (pounds).	Approximate weight per 100 feet.
$\frac{1}{8}$	2,000	2.88
$\frac{3}{32}$	2,800	4.44
$\frac{1}{8}$	4,200	6.47
$\frac{7}{32}$	5,600	9.50
$\frac{1}{2}$	7,000	12.00
$\frac{9}{32}$	8,000	14.56
$\frac{5}{16}$	9,800	17.71
$\frac{3}{8}$	12,500	22.53
$\frac{7}{16}$	14,400	26.45

PLATE NO. 5.

ROEBLING 7 BY 19, TINNED AVIATOR CORD.

Roebling tinned aviator cord is composed of 7 strands of 19 wires each. This wire is made from the highest grade of steel and given a heavy plating of tin. It is used principally for stays on foreign machines. This cord is approximately one and three-quarter times as elastic as a solid wire of the same material.

Thimble spliced in each end.

Diameter of cord.	Breaking strength of cord.	Breaking strength of stay.	Efficiency.	Approximate weight per 100 feet.
$\frac{1}{8}$	2,000	1,600	Average of 54 tests 83.6 per cent.	2.88
$\frac{3}{32}$	2,800	2,300		4.44
$\frac{1}{8}$	4,200	3,500		6.47
$\frac{7}{32}$	5,600	4,700		9.50
$\frac{1}{2}$	7,000	6,000		12.00
$\frac{9}{32}$	8,000	6,800		14.56
$\frac{5}{16}$	9,800	8,200		17.71
$\frac{3}{8}$	12,500	10,400		22.53
$\frac{7}{16}$	14,400	12,000		26.45

PLATE NO. 6.

ROEBLING 7 BY 19, TINNED AVIATOR CORD.

Figure No. 1 shows thimble spliced in 7 by 19 tinned aviator cord.

Figure No. 2 shows the splice after the serving is applied.

Figure No. 3 shows the result of a test to destruction in the testing machine. Five strands have been broken at the last tuck in the splice. In all the 54 tests the stay failed at this point and never around the thimble.

PLATE NO. 7.**THIMBLES.**

The eye splice in strand and cord should be protected by means of either steel or brass thimble.

The brass thimble can be used for 19-wire strand for diameters of $\frac{1}{8}$ inch and smaller. For larger diameters use steel thimbles.

For the 7 by 19 cord use brass thimble for $\frac{3}{16}$ inch diameters and smaller, and steel thimbles for larger diameters.

PLATE NO. 8.**SHOP CONNECTIONS.**

Figure No. 1.—Based upon tests, believe the eye splice for the 7 by 19 cord is the most satisfactory for all sizes, including $\frac{1}{2}$ inch diameter, unless higher efficiency is required, in which case a socket attachment can be used for the larger diameters.

Figure No. 2.—The eye splice is very satisfactory for 19-wire strand for diameters not exceeding $\frac{5}{16}$ inch. For larger diameters a socket attachment is necessary to get high efficiency.

Figures Nos. 3, 4, and 5.—The tapered ferrule and wedge attachment gives maximum efficiency, and we believe can be used to great advantage for single-wire stays.

PLATE NO. 9.**FIELD CONNECTIONS.**

The repairing of stays in the field has been given careful consideration, and *Figure No. 1* on plate No. 9 shows a very simple and efficient device for attachment of either 19-wire strand or 7 by 19 cord. The efficiency is 90 per cent.

The wedge "A" and ferrule "B" are the two important members of the connections. After the strand or cord is placed on wedge and through ferrule, the end of same is bent backward on ferrule and then served with wire.

Figures Nos. 2 and 3 show the same type of connection for wire attachment. The efficiency is 94 per cent.

PLATE NO. 10 AND PLATE NO. 10A.**SOCKET ATTACHMENT.**

We believe the socket attachment can be used to advantage in connection with 19-wire strand, especially on the larger diameters.

The efficiency is nearly 100 per cent and the connection is positive and safe.

We find it necessary to use pure zinc for attachment of galvanized strand.

Plate No. 10 shows two types of sockets—

Figure No. 1 not furnished with adjustment and *Figure No. 2* having adjustment.

Plate No. 10A shows the sockets used by the Glenn L. Martin Co., and it is stated their efficiency is 100 per cent.

S. Doc. 268, 64-1.

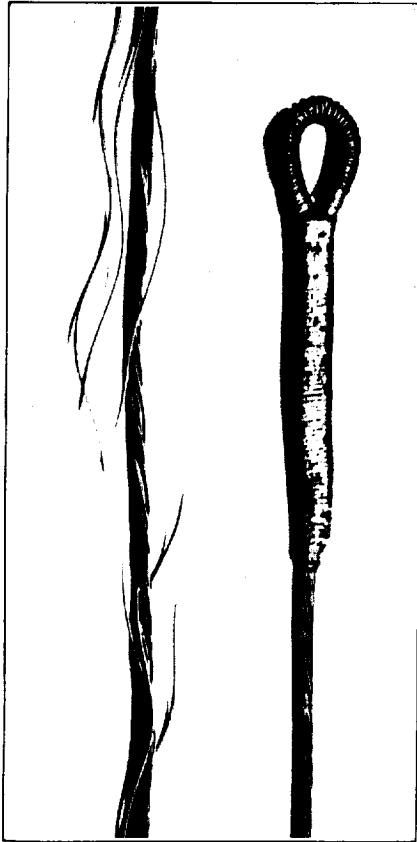

PLATE No. 11.

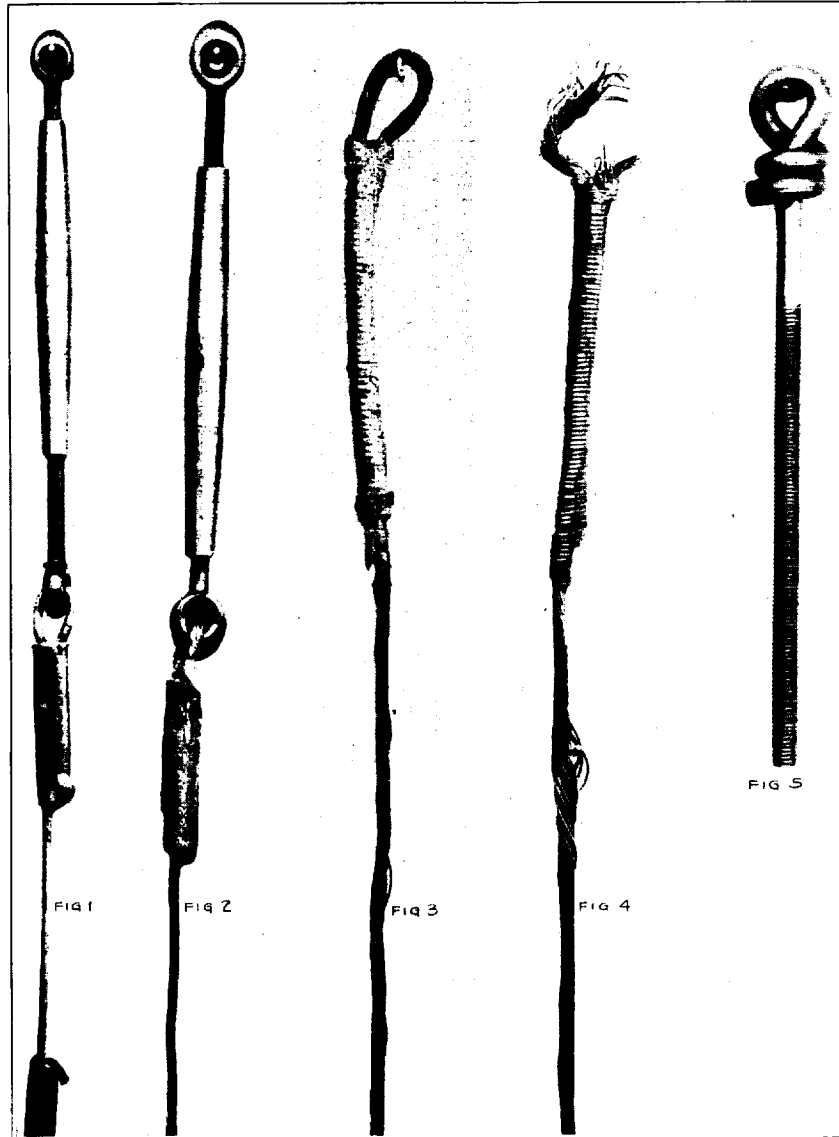

PLATE No. 12.

S. Doc. 268, 64-1.

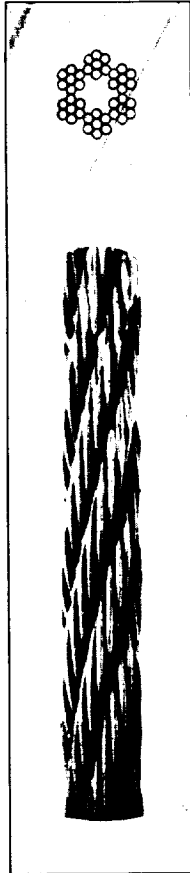

PLATE No. 13.

S. Doc. 268, 64-1.

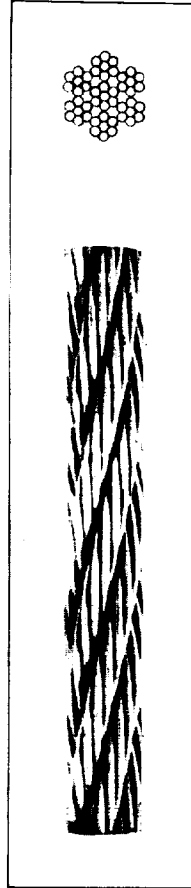

PLATE No. 14.

PLATE NO. 11.

ROEBLING 19-WIRE GALVANIZED AVIATOR STRAND.

Figure No. 1 shows a 19-wire galvanized aviator strand with end looped and soldered.

Figure No. 2 shows the result of test to destruction in the testing machine. It will be noted that the break of the seven wires occurs at the center of the stay and never at the ends. In the series of tests made this connection showed an efficiency of 100 per cent.

Special attention is called to the protective serving of the loop. In case this is not done a thimble must be used. The principal objections to this connection are the use of acid and solder.

Ends looped and soldered.

Diameter of strand.	Breaking strength of strand.	Breaking strength of stay.	Efficiency (per cent).	Length of lap.	Serving of lap.	Approximate weight per 100 feet.
$\frac{1}{4}$	8,000	8,000	100	20 times diameter of strand.	Diameter of serving wire = $\frac{1}{4}$ diameter of strand.	13.50
$\frac{3}{8}$	6,100	6,100	100			10.00
$\frac{1}{2}$	4,600	4,600	100			7.70
$\frac{5}{8}$	3,200	3,200	100			5.50
$\frac{3}{4}$	2,100	2,100	100			3.50
$\frac{7}{8}$	1,600	1,600	100			2.60
$\frac{1}{2}$	1,100	1,100	100			1.75
$\frac{3}{4}$	780	780	100			1.21
$\frac{5}{8}$	500	500	100			.78

PLATE NO. 12.

EXAMPLES OF PRESENT PRACTICE.

No. 1 shows the solid wire, using a copper tube as a ferrule, and if attached properly will give efficiency of 75 to 80 per cent.

No. 2 shows a 19-wire strand attachment, using a copper tube as a ferrule and bending the strand back and soldering both inside and outside of ferrule. Note that the strand is not protected where it bears on turnbuckle and the strand fails here. The efficiency is low.

No. 3 shows a 19-wire strand attachment where the strand is looped, served, and then soldered. Note the wire displacement in loop.

No. 4 was taken from a wrecked aeroplane and shows point of failure in loop, due to want of protection at this point.

No. 5 shows form of eye for solid wire, which makes it necessary to use medium steel to allow manipulation.

Diameter of cord.	Breaking strength of cord.	Approximate weight per 100 feet.
$\frac{1}{8}$	7,900	15.00
$\frac{1}{4}$	5,000	9.50
$\frac{3}{8}$	4,000	7.43
$\frac{1}{2}$	2,750	5.30
$\frac{5}{8}$	2,200	4.20
$\frac{3}{4}$	1,150	2.20
$\frac{7}{8}$	830	1.50
$\frac{1}{2}$	780	1.30
$\frac{3}{4}$	480	.83
$\frac{5}{8}$	400	.73

PLATE NO. 13.

ROEBLING EXTRA FLEXIBLE AVIATOR CORD 6 BY 7 COTTON CENTER.

Roebbling extra flexible aviator cord is composed of six strands of seven galvanized wires each and a cotton center. On account of its flexibility this cord is used for steering gear and controls. This cord is approximately two and one-quarter times as elastic as a solid wire.

Diameter of cord.	Breaking strength of cord.	Approximate weight per 100 feet.
$\frac{6}{16}$	9,200	16.70
$\frac{1}{2}$	5,800	10.50
$\frac{3}{8}$	4,600	8.30
$\frac{1}{5}$	3,200	5.80
$\frac{3}{16}$	2,600	4.67
$\frac{1}{4}$	1,350	2.45
$\frac{7}{16}$	970	1.75
$\frac{3}{8}$	920	1.45
$\frac{1}{2}$	550	.93
$\frac{3}{4}$	485	.81

PLATE NO. 14.

ROEBLING FLEXIBLE AVIATOR CORD 6 BY 7 WIRE CENTER.

Roebbling flexible aviator cord is made with seven strands of seven galvanized wire each. This cord is not as flexible as the cotton center cord and is approximately one and three-quarters times as elastic as a solid wire.

PROTECTIVE COATINGS ON STEEL WIRES.

NONFERROUS METALS—ALLOY STEELS.

We manufacture wire and cable in nonferrous metals such as monel metal, german silver, phosphor bronze, aluminum bronze, silicon bronze, brass, copper, etc., but we do not believe that any of these metals will ever prove commercially practicable for the purpose of aeroplane stays or cables. "Maximum strength with minimum weight" appears to be too all-important. In none of these can extreme reliability with high elasticity be so well secured as with steel when it is well protected from mechanical injury and corrosion. For exceptional purposes, the nonmagnetic properties of these metals may outweigh their lack of strength and durability in fatigue, making their use imperative, but in the final design the amount thus used will undoubtedly be the least possible amount permissible under the circumstances. For construction of this kind we would not recommend, without many qualifications, a natural alloy such as monel metal. This material appears to possess excellent noncorrosion properties when used in a relatively large mass, as in a propeller, but there appears to be considerable doubt as to its absolute reliability in uniformly resisting corrosion when rolled into very thin sheets or drawn into wire. To a lesser degree, a lack of confidence must exist in such manufactured alloys as brass, german silver, or bronzes containing relatively large proportions of two or more elementary metals. "Phosphor bronze," "silicon bronze," "aluminum bronze," or similar alloys containing a relatively high per cent of one element (copper)

only, are more "fool-proof" and consequently more reliable and desirable.

An attempt to give the elastic limit and tensile strength of each size of wire, strand, and cable used in aeroplane construction, if same were made of all the nonferrous metals mentioned above, would involve the publication of quite an extensive report. Confining ourselves to the most suitable of these metals or alloys, phosphor bronze, aluminum bronze, etc., it is a safe and reliable rule to assume that the ultimate strength of such wire or cable or stay will be 50 per cent of the ultimate strength of the extra high-strength steel listed by us for standard aeroplane use. The elastic limit for nonferrous metals could not safely be assumed at more than 50 per cent of the ultimate breaking strain.

The use of vanadium, titanium, and other special deoxidizers or cleansers in the manufacture of steel has undoubtedly resulted in very much improving homogeneity and density of structure in cast, forged, and other hot-worked masses of the metal especially in the harder alloyed varieties. It is not so certain, however, that the use of these metals has proven necessary or even desirable in making steels of the higher grade for wire manufacture where the enormous amount of cold working and exact heat treatment absolutely inherent to the process of wire manufacture produces eventually a structure finer and more homogeneous than has ever been possible by any other method. The increased resistance to corrosion which the special steels, referred to above, afford, because of their density and uniformity, is more than duplicated by any drawn high-grade wire of the ordinary carbon steels of sufficient degree of manufacture.

Vanadium steels and other steels of their kind have not as yet become established as desirable wire steels. Although strongly urged upon the industry and tried time and again, they have not demonstrated their superiority.

Carefully made high-grade carbon steel affords to-day the most reliable and flexible material for wire, cable, and stays, possessing the "greatest strength for the least weight" known in the wire industry. We know its advantages and we know its disadvantages. The fact that the mechanical properties of steel wire and cable are seriously affected by corrosion is so well known that it must be guarded against. As the damage done is a function of time as well as intensity of chemical or electro-chemical action on the unprotected steel, we have investigated the question of retarding corrosion in the steel itself to as great a degree as possible. We have found that pure iron retards corrosion to a greater degree than the more impure steel—but we have also found that in highly extenuated filaments of these two metals, as in wire, the difference in rate of corrosion is practically negligible, especially when the total life of the wire protected by an external coating such as galvanizing is taken into consideration. We have found the use of special deoxidizers and cleansers questionable and have not adopted them.

The use of protective coatings on steel wire or cable is a very broad subject. Hot galvanized unwiped wire is undoubtedly the best protected wire for the purpose. Very hard wires and very fine sizes of hard wire are likely to become brittle at the temperature of hot galvanizing, and the next best coating available is, therefore, a tin coating. Both of these metal coatings should be further protected

by frequent applications of paint. As a protection to the galvanizing, a coat of red-lead paint should be applied after the stay is assembled and the red lead protected by a coat of graphite paint.

The care with which inspections are made from time to time and the efficient maintenance of the paint on the wires really determines the life of the combination. This has been proven absolutely by the very extensive use and treatment of galvanized steel on board ship for many years.

Nickel plating is out of the question for wires to be bent or twisted into cable. Furthermore, nickel is absolutely injurious where the initial purely chemical action on the intact nickel surface ceases and electro-chemical action between steel and nickel begins at such spots when steel is exposed.

We believe, therefore, that tinning and galvanizing are to-day the most satisfactory coatings for steel wire that can be employed. They do not actually represent the final and efficient protection which is necessary in aeroplane construction, as this is secured by the repeated application of paint. These coatings are, however, an efficient guard against corrosion preliminary to service conditions in the plane and also serve to prevent corrosion and consequent damage to the steel cables and stays in service when the paint may have been accidentally rubbed off.

RECAPITULATION.

WIRE STAYS.

As shown by tests, the terminal fastening, figures 13 and 14, on plate No. 1, are efficient, simple, and readily attached, and we believe solve the question.

For shop attachment figure 13 or 14 would be used in connection with shackles and clevises, and for attaching to turnbuckle eye or other closed eyes use figure 15.

For field attachment use either figure 14 or 15.

Plates No. 8 and No. 9 also show these terminal connections.

WIRE SPECIFICATIONS FOR STAY WIRES.

Plate No. 2 and pages 10 and 11 of this report give specifications for wire having the highest possible strength, together with the necessary ductility for manipulation, and is the result of many years of experimenting in cooperation with engineers and manufacturers of aeroplanes.

19-wire strand stays.

Plates No. 3 and No. 4 give the strength of this strand, also the strength of same as stays using the thimble eye splice for terminal connection, and judging from tests as given, this connection is efficient, neat in appearance, and reliable.

Plate No. 11 gives table of stay strength when the ends of the strand are looped and soldered. The efficiency of this connection is a maximum, but the use of acid and solder are objectionable, and we believe the thimble eye splice with slightly lower efficiency is preferable.

We understand $\frac{1}{4}$ -inch diameter strand is the largest diameter used, but judging from present development larger diameter will be required and it will be found that the thimble eye splice, also the ends looped and soldered, will not give the same efficiency as the diameter increases and we believe the use of sockets for $\frac{3}{8}$ -inch diameter and larger may be desirable.

Plate No. 10 shows two types of sockets.

For making terminal connection of strand in the field, we believe the arrangement shown on plate No. 9 is best, as it gives 90 per cent efficiency and is readily attached by the average man and does not require the use of acid, solder, or blow torch.

7 by 19 cord stays.

Plates No. 5 and No. 6 show the 7 by 19 rope which is flexible, elastic, and lends itself readily to thimble splice, giving very uniform efficiency and has the advantage of higher efficiency for diameters between $\frac{3}{8}$ and $\frac{1}{2}$ inch.

We have determined by tests that the socket connection alone gives higher efficiency than the thimble eye splice on 7 by 19 cord, but as a general proposition believe the thimble eye splice is entirely suitable for stay construction.

For a field connection plate No. 9 shows the most suitable type.

CONCLUSIONS.

The tests as given show that it is possible to furnish efficient terminal connections for wire, strand, and 7 by 19 cord, and eliminate the use of acid, solder, and blow torch, and this report as a basis will allow a more thorough investigation on similar lines.

We are unable to determine from aeroplane manufacturers why it is necessary to use the solid wire, 19-wire strand, and the 7 by 19 cord for stays. It is self-evident that the wire stay is less elastic than the 19-wire strand, also that the strand is less elastic than the 7 by 19 cord, also the strength varies considerably, as can be determined by comparison of tables as given before, and to allow a quick comparison we give below:

Comparison of stay strength.

Material.	Diameter.	Strength of material.	Strength of stay.
	<i>Inch.</i>	<i>Pounds.</i>	<i>Pounds.</i>
Wire.....	$\frac{3}{16}$	5,500	5,100
Strand.....	$\frac{3}{16}$	4,600	4,100
7 by 19 cord.....	$\frac{3}{16}$	4,200	3,500

American practice covers both the wire and 19-wire strand stay and foreign practice requires the use of 7 by 19 cord for stay.

The table above shows how much more efficient the wire and strand stays are for the same diameter and therefore we are led to believe there are other considerations just as important as strength, such as the elastic stretch of stays, flexibility and fatigue values of material

which may be governed by the construction of stay, and we believe these points should be investigated under field conditions as well as laboratory tests.

We hoped to give this report stress-strain diagram for the solid wire, 19-wire strand, also 7 by 19 cord, so that the modulus of elasticity could be determined for any desired load and elastic stretch of stay calculated for comparison. We were unable to complete our tests in time, and therefore if you decide this is of value we will be pleased to submit these diagrams and any other data developed. If vibration of stays is a factor, the relative fatigue value of the three constructions would give interesting data.

Respectfully submitted.

JOHN A. ROEBLING'S SONS CO.,
By C. C. SUNDERLAND, *Engineer*.

(Investigations under direction of C. C. Sunderland, H. J. Horn,
and D. Green.)

REPORT No. 4.

**PRELIMINARY REPORT ON THE PROBLEM OF
THE ATMOSPHERE IN RELATION
TO AERONAUTICS.**

By PROF. CHARLES F. MARVIN.

REPORT No. 4.

PRELIMINARY REPORT ON THE PROBLEM OF THE ATMOSPHERE IN RELATION TO AERONAUTICS.

UNITED STATES WEATHER BUREAU,
Washington, D. C., November 9, 1915.

GENTLEMEN: The particular work comprising the subject of this report has been undertaken pursuant to an allotment by Dr. Charles D. Walcott, Secretary of the Smithsonian Institution, of \$2,500, made available through the Secretary of Agriculture to the Chief of the Weather Bureau. At the meeting of the executive committee held June 11, 1915, the chairman, Dr. Charles D. Walcott, was authorized to designate Charles F. Marvin, Chief of the Weather Bureau, as chairman of a subcommittee to investigate and report upon the problem of the atmosphere in relation to aeronautics. He was requested to select other members of the subcommittee, not to exceed four, and Profs. William J. Humphreys and William R. Blair, of the United States Weather Bureau, subsequently consented to act as members of the subcommittee.

At the meeting of the executive committee held August 5, 1915, a proposal of work to be undertaken was outlined by the chairman of the subcommittee on the atmosphere in relation to aeronautics, the substance of which is briefly quoted as follows:

The Weather Bureau is already in possession of an immense amount of data concerning atmospheric conditions, including wind movements at the earth's surface. This information is no doubt of distinct value to aeronautical operations, but it needs to be collated and put in form to meet the requirements of aviation. The bureau also has a considerable amount of determinations of atmospheric conditions in the free air. Most of these observations were made at Mount Weather, but others have been made at a few points in the West, such as Huron, S. Dak.; Fort Omaha, Nebr.; Avalon, Cal.; and a few aboard the Coast Guard cutter *Seneca*, during the past summer while this vessel was engaged on ice patrol off the Newfoundland coast. Portions of these data also are undoubtedly valuable to aviation, but it is quite apparent that but a small fraction of the material needed to meet the requirements of aeronautical work throughout the United States is available, and that therefore much additional observation work is necessary.

In considering the work that should be done along these lines, further cooperation is needed by the Weather Bureau with those actually engaged in aeronautical operations, and with this need in view Prof. Blair, a member of the subcommittee, has already been in conference with Mr. F. R. McCrary, acting director of naval aeronautics. It is proposed to utilize the fund made available by the Smithsonian Institution to undertake a careful compilation of the data already available in the Weather Bureau records, this compilation to be along lines that will make the data available to aviation; also that additional observations be undertaken to gain information concerning atmospheric conditions by means of pilot balloons, the position and motions of which are recorded by theodolites and such other apparatus as the work may require. It may be proper to state at this point that the Weather Bureau is already conducting aerial investigations of direct interest to meteorology, and that the new work herein proposed will be supplementary and in addition to the work the Weather Bureau is

already performing. Embarrassment has been experienced in the progress of this work since the European war on account of the inability to procure serviceable rubber balloons. A manufacturer in Ohio has undertaken to supply these, and has submitted a considerable number of samples and full-sized balloons. So far, however, the results have been almost a complete failure, on account of the seeming inability to secure the necessary strength and gas tightness at the seams. Work is still in progress, however, on the manufacture of the balloons, and we are hopeful of more favorable results in the future.

The following outline indicates approximately the subject matter of a meteorological character it is expected to include in the proposed publications:

ATMOSPHERIC CONDITIONS IN RELATION TO AERONAUTICS.

1. INTRODUCTION.—Brief presentation of a few fundamental principles and data relating to general atmospheric conditions and motions and forming a basis for the subsequent discussion of relations of temperature pressure and motions of the atmosphere.

CHAPTER I.—General meteorological and climatological data selected and classified with respect to its bearing on aeronautics. The data should show general surface conditions of weather, temperature, sunshine, rain, thunderstorms, humidity, and wind velocity and directions; also comprise as full information concerning average free-air conditions as the scanty data available permit.

CHAPTER II.—A discussion of particular and local atmospheric conditions as affecting aviation.

CHAPTER III.—General presentation of free-air conditions arranged with relation to surface conditions.

CHAPTER IV.—Instruments with special reference to aviation.

CHAPTER V.—Miscellaneous useful material not otherwise included.

APPENDIX.—Formulæ and practical tables.

The practical closing of European markets for certain instrumental supplies has prevented procuring recording theodolites of special construction needed in studying atmospheric motions by means of pilot and sounding balloons. A type of instrument of this kind has been designed and efforts are being made to secure the manufacture in the United States of a small supply for the Weather Bureau work.

Difficulties are still encountered in procuring in the United States a good quality of rubber balloons for atmospheric explorations.

Mention is made at this point of a special form of camera adapted to make a photograph on a single plate of the entire sky from horizon to zenith. This has been developed and tried out by Mr. Fred W. Mueller, with the advice and assistance of Dr. O. L. Fassig, both of Baltimore, Md. The instrument is fully described and illustrated in the *Monthly Weather Review*.

Since the publication of that paper I am informed by Dr. Fassig that Mr. Mueller has greatly improved the mechanical arrangements of the camera, so that the same results can be obtained in a simpler manner. It is believed the device may have some special use in aeronautics as well as meteorology.

C. F. MARVIN,
*Chairman, Subcommittee on the Atmosphere in
Relation to Aeronautics.*

NATIONAL ADVISORY COMMITTEE FOR AERONAUTICS,
Washington, D. C.

REPORT No. 5.

**RELATIVE WORTH OF IMPROVEMENTS
ON FABRICS.**

By THE GOODYEAR TIRE AND RUBBER COMPANY.

REPORT No. 5.

RELATIVE WORTH OF IMPROVEMENTS ON FABRICS.

By THE GOODYEAR TIRE AND RUBBER CO.

If one seeks to determine the qualities which offer the best chance for improvement, without knowing as yet the exact means for effecting such improvement, the procedure is as follows:

Assume that in a theoretically perfect fabric each of the following qualities would be reduced to zero:

Weight (per unit strength).

Diffusion.

Rate of depreciation (dollars per year).

Heating coefficient.

Interest and insurance.

Moisture absorption.

It may be admitted that, in practice, certain of the above qualities can not possibly be reduced below the well-recognized minimum of terrestrial materials, but this minimum is in every case so near zero, compared to the figures for ordinary balloon fabric, that the point is of no practical importance.

Applying the results to a dirigible and taking the items one at a time: If the weight of fabric is reduced to the assumed minimum it will save $\frac{W}{U}$ of the total running expense of the dirigible; where W is the total weight of fabric saved and U is the useful load carried.

If diffusion is entirely eliminated it will save the entire cost of gas (including labor and overhead) except that which escapes through the valves, the interest on the original inflation, and liability to accidental deflation.

If the fabric is made infinitely durable it will save all the depreciation of the gas bag except that due to accidental injury.

If the heating coefficient is reduced to zero it will save the running expense of that part of the control system which serves to correct the effects of heating, plus $\frac{w'}{u}$ of the total running expense of the dirigible; where w' is the weight of apparatus saved.

If cost is entirely eliminated it will save the interest and insurance on the fabric (exclusive of building up).

If the moisture absorption is reduced to zero, it will save the cost of apparatus to correct it, plus $\frac{w''}{u}$ of the total running expense of the dirigible, where w'' is the weight of apparatus saved.

Assume now a modern nonrigid dirigible of 500,000 cubic feet capacity and speed of 40 miles per hour. Other data could be reasonably expected as follows:

- W = weight of fabric = 5,000 pounds.
- U = average useful load = 6,000 pounds.
- 10,000 miles per year.
- Gross running expense, \$100,000 per year.
- Gas leakage, 0.5 per cent per day.
- Reinflation every three months.
- Gas and inflation cost at \$0.01 per cubic foot (plus allowance of \$10,000 for idle time), \$40,000 per year.
- Depreciation of gas bag (from weathering and ordinary wear), \$20,000 per year.
- w' = weight of heat-control apparatus (planes, fuel, and ballast), 1,200 pounds.
- Interest and insurance (military) on fabric, \$15,000 per year.
- w'' = weight of apparatus to counteract moisture absorption (planes and ballast), 500 pounds.

The above data works into the following figures which show the gross expense chargeable to each of the items named:

	Per year.
Weight.....	\$82,000
Diffusion.....	40,000
Depreciation.....	20,000
Heating.....	20,000
Interest and insurance.....	15,000
Moisture absorption.....	8,000

(These figures are of course largely overlapping and can not be summed up into a total.)

Expressed on a percentage basis for the various qualities sought for, we get roughly the following:

Quality:	Relative importance.
Lightness.....	44
Gas tightness.....	22
Durability (dollars per year).....	11
Low heating.....	11
Cheapness.....	8
Low moisture absorption.....	4
	100

For proportional improvement it will be seen that lightness is by far the most desirable quality, while mere cheapness of fabric is almost the last thing to be sought.

The table also furnishes means of determining whether a proposed change in the design of a fabric is worth while.

In effecting a certain improvement other qualities are generally affected at the same time, sometimes adversely. To determine the degree of net improvement multiply the per cent improvement in each quality by its quality gauge number, and add up the products. If the result is positive a net improvement has been effected proportional to the magnitude of the figure. For instance a 5 per cent saving in weight would be worth while even if accompanied by a 20 per cent increase in cost, other things remaining the same.

It should be carefully noted that this particular scale of improvements is strictly applicable only to a ship of approximately the characteristics above named, and to that only under certain fixed condi-

tions of operation. It is only taken as a rough guide to present day dirigibles in general. Whenever the fabric, the dirigible or its conditions of use are much changed, the fabric improvement scale must be changed accordingly.

It has been argued by some that the economic basis of design can not be applied at all to military work. With this I decidedly do not agree. It is true only to the extent that certain items of cost such as initial investment are often of small, sometimes negligible, importance compared with other items. But if the analysis is complete, it may be put squarely on an economic basis, it being only necessary to estimate the *true saving* for each of the possible improvements above named, *applied to the particular requirements and conditions governing the case in hand.*

It is evident from what has been said that for a dirigible of certain required specifications a definite equation exists connecting all the major qualities of the fabric, from which the fabric may be rigidly designed with respect to maximum ultimate economy.

The same principles apply to balloons and aeroplanes. For an 80,000 cubic foot spherical balloon (the *Goodyear*), the following order prevails if used for passenger flights (1 day trips).

Lightness.....	32
Durability.....	22
Low heating.....	20
Cheapness.....	16
Low moisture absorbtion.....	8
Gas tightness.....	2

For a 100 horsepower tractor biplane the same six qualities run approximately:

Lightness.....	60
Durability.....	20
Cheapness.....	15
Low moisture absorbtion.....	5
Air tightness.....	trifling.
Low heating.....	0

AUGUST 17, 1915.

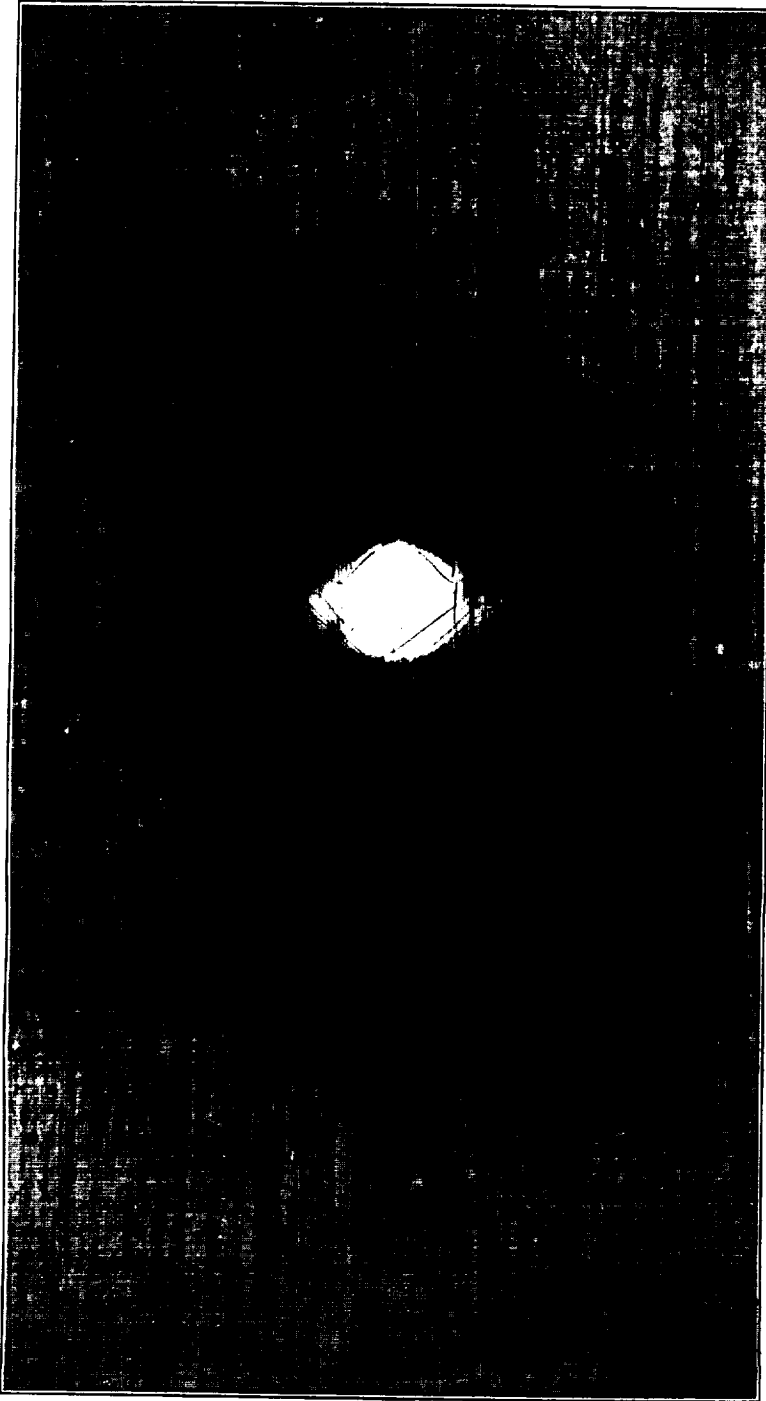

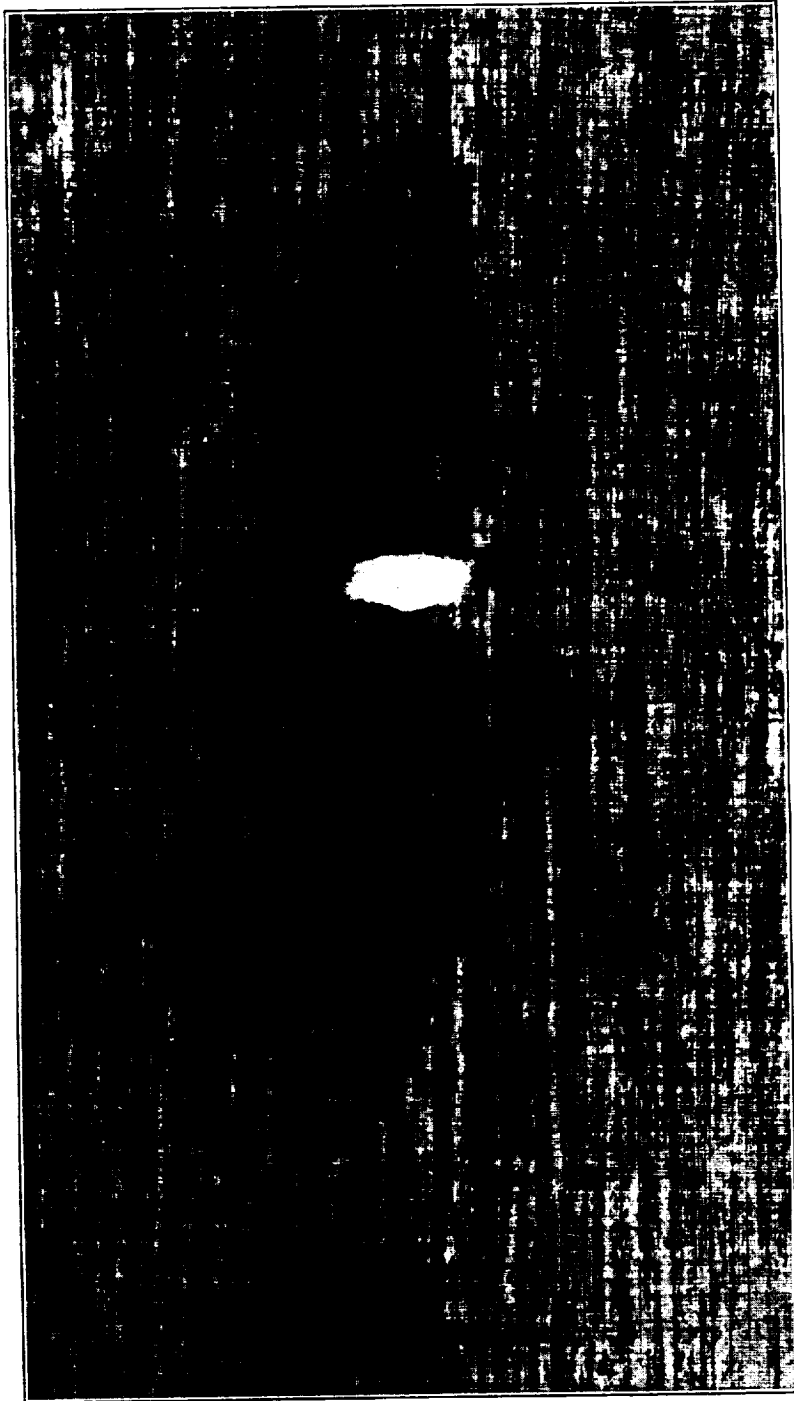

S. Doc. 268, 64-1.

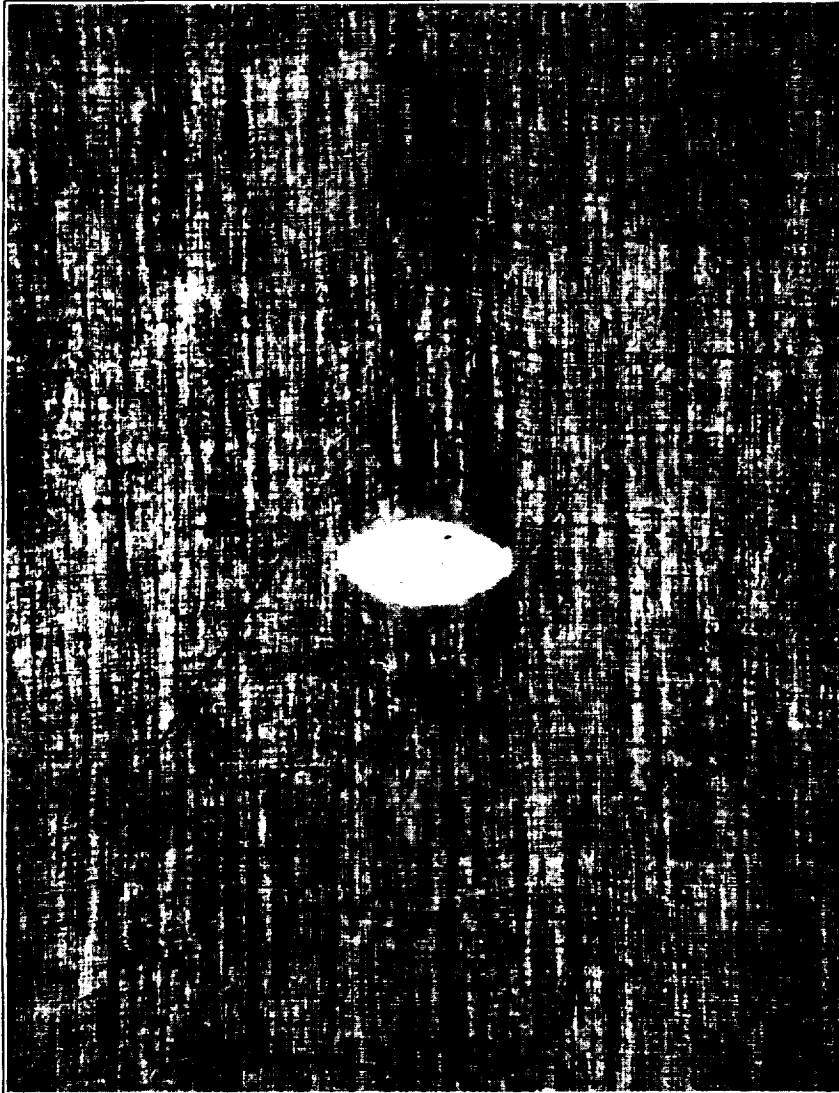

186-3

S. Doc. 268, 64-1.

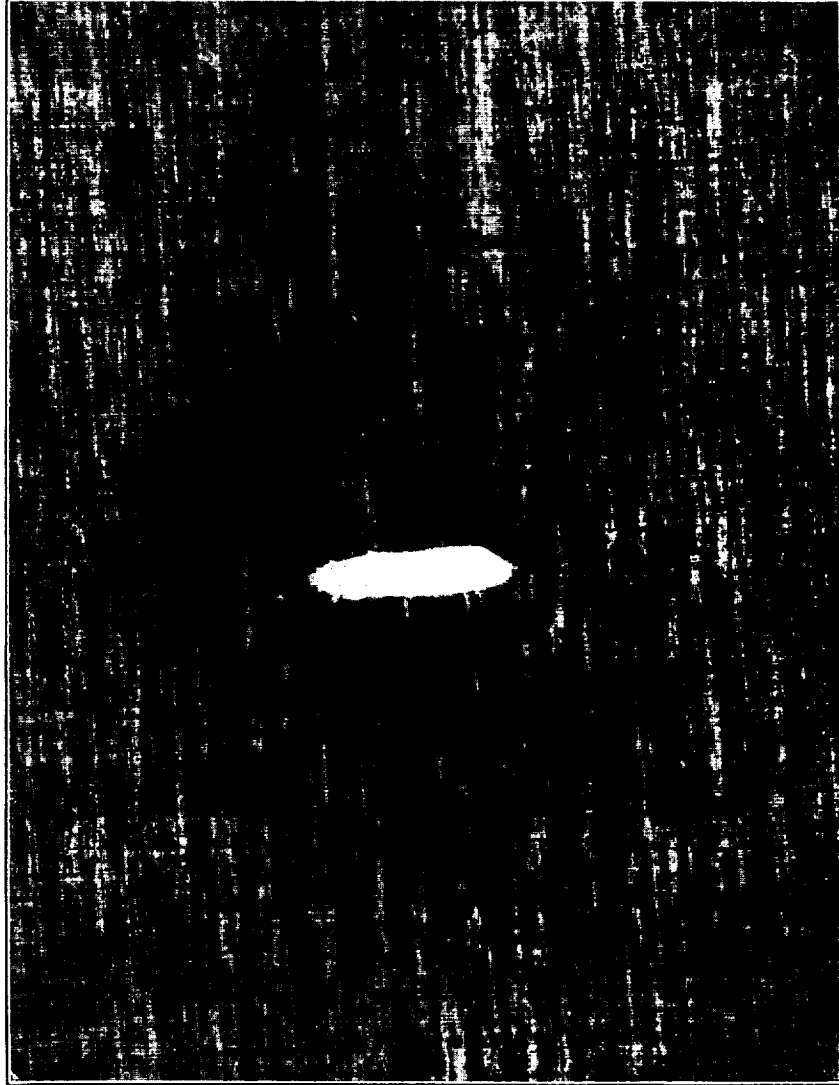

100-4

S. Doc. 268, 64-1.

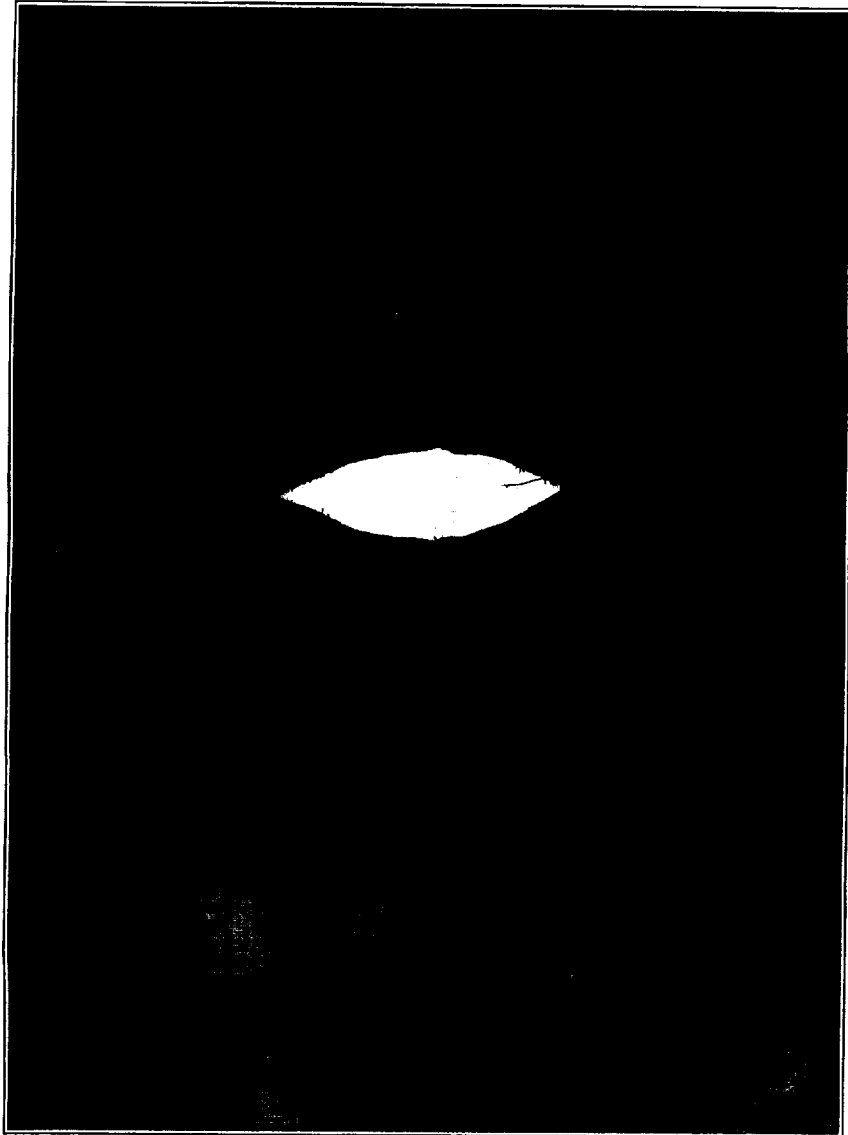

S. Doc. 268, 64-1.

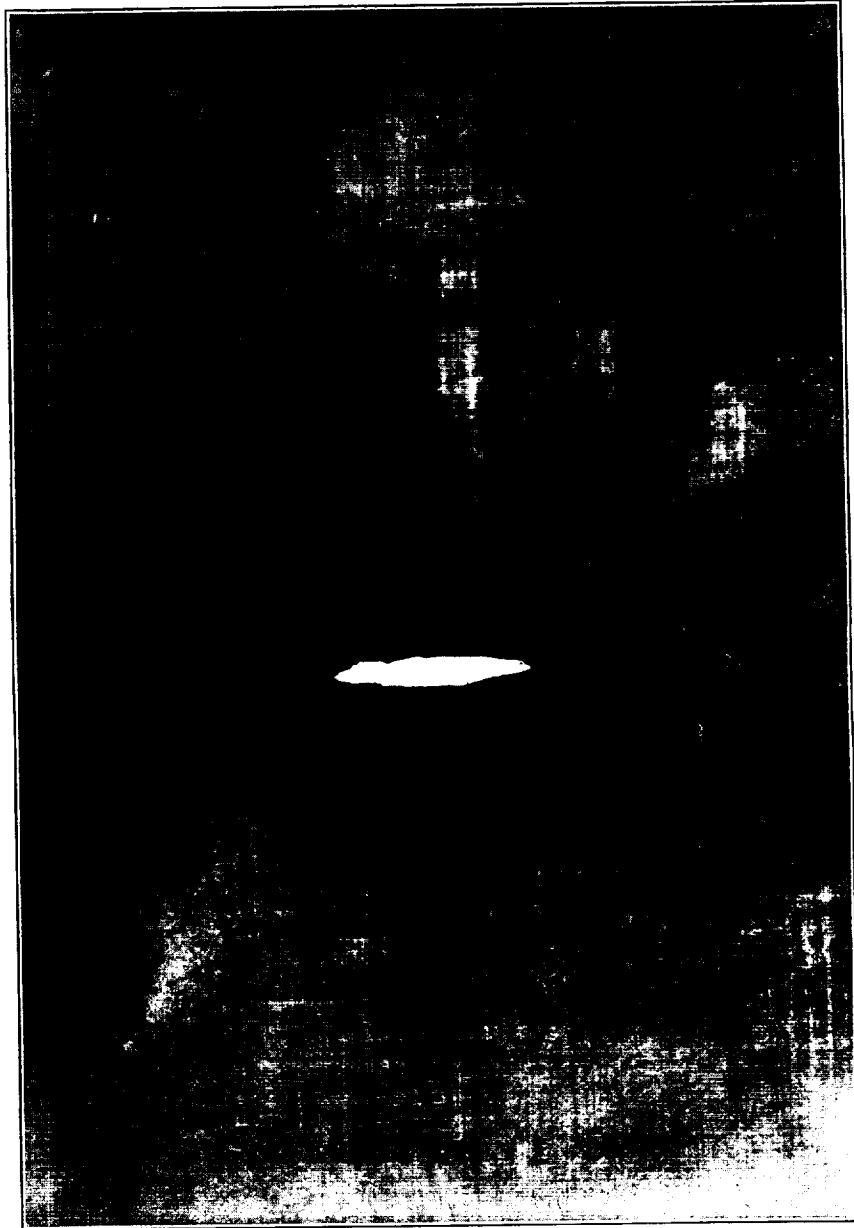

136-6

REPORT No. 6.

IN TWO PARTS.

**INVESTIGATIONS OF BALLOON AND
AEROPLANE FABRICS.**

By **THE UNITED STATES RUBBER COMPANY, GENERAL LABORATORIES.**

Part I.—BALLOON AND AEROPLANE FABRICS.

By **WILLIS A. GIBBONS and OMAR H. SMITH.**

Part II.—SKIN FRICTION OF VARIOUS SURFACES IN AIR.

By **WILLIS A. GIBBONS.**

137

**NACA LIBRARY
AMES AERONAUTICAL LABORATORY
Moffett Field, Calif.**

CONTENTS OF REPORT No. 6.

PART 1.

BALLOON AND AEROPLANE FABRICS.

	Page.
Aeroplane fabric.....	140
Materials used.....	140
Strength, stretching, and aging tests.....	142
Absorption of water.....	144
Fireproofing.....	145
Balloon fabric.....	145
Materials.....	145
Strength and aging tests.....	147
Permeability of balloon fabrics.....	147
Tests on balloon and aeroplane fabrics.....	150
Tearing tests.....	150
Surface friction tests.....	151

APPENDIX.

Linen fabrics.....	153
Stretching tests, description, data, and curves.....	154
Tearing tests, description, data, plates, and curves.....	160
Cotton fabrics, discussion, data, and curves.....	166
Permeability tests, description, data, and curves.....	168
Surface friction tests, data, and discussion.....	174

PART 2.

SKIN FRICTION OF VARIOUS SURFACES IN AIR.

Introduction.....	176
Experimental.....	178
Corrections.....	178
Surfaces.....	178
Results.....	180
Values of K and N.....	181

REPORT No. 6.

PART 1.

BALLOON AND AEROPLANE FABRICS.

By WILLIS A. GIBBONS and OMAR H. SMITH.

NOTE.—Although usually associated, for obvious reasons, balloon and aeroplane fabrics have actually become so dissimilar in many respects, such as materials of construction and requirements for satisfactory results, that for the most part the two will be discussed separately. The tearing and surface friction tests, being common to both, are exceptions to this rule. The plan followed as far as possible in this report has been to give first the results of the various parts of the investigation, with such descriptive matter, data, and plates as are necessary to make the results clear. The data and other details are given in the appendix. For convenience the data is grouped somewhat differently in the appendix, without, it is thought, causing any confusion.

SUMMARY.

The following conclusions are drawn from the results of our tests hereinafter described. It must, however, be remembered that they are based almost entirely on experiment, so care must be used in applying them extensively until they have been tried in actual practice.

COATING MATERIALS.

(1) By proper treatment fabrics can be made noninflammable even though coated with cellulose nitrate varnish followed by spar varnish.

(2) The ordinary cellulose acetate dopes do not make fabric fire-proof, although themselves noninflammable. This applies particularly in the case of fabrics doped, then coated with spar varnish.

(3) Fabrics coated on one side with rubber, with the other side doped, would probably give a satisfactory tightening effect and at the same time resist damp weather better.

(4) Maximum efficiency can apparently be best obtained by not stretching the cloth too tightly on the wings before coating.

(5) Stretching and tearing tests give valuable information regarding the suitability of fabrics and should be considered in addition to the tensile strength. The area inclosed by the stretch-load, curve, representing the work done to break the strip, gives an idea as to its resistance to shocks, etc.

BALLOON FABRICS.

(1) Permeability increases greatly with temperature—about 4 per cent per degree C. for samples tested.

(2) Tests made on fabrics with varying weights of rubber indicate that permeability is not directly proportional to the thickness of the layer.

(3) Tearing tests show a great superiority of bias over parallel doubled fabrics.

SURFACE FRICTION TESTS.

(1) For very smooth surfaces the surface friction varies with the 1.8-1.85 power of the velocity; the exponent increases with the roughness, approaching 2 for fabrics with nap on the surface.

(2) Varnished fabrics have nearly as low a resistance as plate glass. The resistance increases greatly as the surface becomes rougher from the presence of loose fibers.

Part I.—AEROPLANE FABRIC.**I. MATERIALS USED.**

By far the greater part of the aeroplanes in use to-day have wings made of a textile fabric, usually linen, coated with a more or less waterproof, practically nonelastic varnish. This is ordinarily some form of cellulose acetate, or less frequently cellulose nitrate, with more or less softening material added, and some suitable solvent.

It is ordinarily the practice to apply three or more coats of this varnish, rubbing down with sandpaper after the coating is dry, after which one or two coats of high-grade linseed oil varnish, preferably a spar varnish, are applied.

1. COATINGS.

The cellulose acetate or nitrate lacquer is chiefly useful because it acts as a sort of waterproof sizing, which shrinks the cloth more or less, and prevents it from changing in tension with the hygroscopic conditions of the atmosphere. The spar varnish protects this layer, which often shows a tendency to peel, and makes the wing more waterproof.

This form of treatment is convenient, and the materials fairly easy to obtain. On the other hand it could hardly be called permanent; the varnish or dope, as it is commonly called, must be applied to the wings of a machine every few weeks, if the machine sees much service.

Another defect noted probably more by the United States military branches than abroad, is that due to deterioration of the underside of the fabric from moisture and bacteria. The dopes owe their shrinking action to the fact that they are colloids, and as such, when applied to the cloth, do not penetrate but remain on one side. As the solvent evaporates, the gel decreases in volume. The most evident decrease is of course in the thickness of the layer, but there is naturally a tendency for the other two dimensions of the layer of drying varnish

to decrease, causing the well known shrinking effect. Other colloids produce the same effect; for example, glue. Another example is the common gummed label, which being unable to shrink, curls up. At Vera Cruz it was found that there was considerable tendency for the uncoated side of the wings to rot, owing to this lack of penetration. On the other hand, those varnishes which penetrate do not produce the shrinking effect.

2. FABRICS.

Of the fabrics linen is the most satisfactory. Ramie and cotton have been used to some extent, but the former is difficult to obtain and the latter does not take the varnish so well as the linen and tears much easier.

Practically all of the linen suited for this purpose comes from abroad, chiefly from Ireland. An investigation of the relative weights and strengths obtainable is, particularly at the present time, rather difficult to make complete. Added to this there is the difficulty of obtaining material of exactly the same grade from time to time. The fabrics in general use weigh $3\frac{1}{2}$ to $4\frac{1}{2}$ ounces per square yard, and have a tensile strength, tested at about 65 per cent humidity, of from 60 to 70 pounds per inch for the lighter weight to 100 pounds per inch for the heavier weight.

In the following experiments we have used two grades of linen, No. 1, called high grade, being about the best material immediately obtainable in sufficient quantities for our work, and No. 2, medium grade. The No. 1 weighs 4.6 ounces per square yard and has a tensile strength of about 90-95 pounds per inch warp and 60 pounds filling. The No. 2 medium grade weighs about 3.8 ounces per square yard and has a strength of about 65 pounds warp, 50 pounds filler.

DOPES.

The varnishes or dopes used were three representative products obtained in this country. The cellulose acetate varnishes are probably far from perfect, owing to the difficulty of obtaining a satisfactory product in this country. We understand that the latest European material of this sort is a vast improvement on anything heretofore produced.

The solvents for cellulose acetate commonly used are acetone or tetrachlorethane. The latter is said to be rather dangerous on account of its poisonous properties, and care should be used to allow the vapors, which are heavier than air, to pass through ventilating openings in the floor.

Mention must also be made of a material, the use of which in Europe has been mentioned in news reports. This is a transparent celluloid made of cellulose acetate compounded with a camphor substitute and used in the form of a thin, transparent, noninflammable sheet. These are used for wings instead of cloth, and are said to be very difficult to see at a height of a few thousand feet. Whether this is so or not there is of course this advantage, that the pilot can have a much wider field of view than with ordinary wings.

We were fortunate in obtaining sheets of this material. They are of practically the same strength in both directions.

Thickness.	Weight (ounces per square yard).	Tensile strength (pounds per inch), about--
10/1000	9.33	55
64/1000	59	325

Complete data are given elsewhere.

While the thickest sheets are of course too heavy for wings, they might be used for other purposes as, for example, flooring.

II. STRENGTH, STRETCHING, AND AGING TESTS.

1. STRENGTH.

The samples on which these tests are based were made in two ways: (1) The method used in most cases, except when otherwise specified: The linen was stretched moderately on a frame about 3 by 4 feet, and fastened by tacking. The dopes, etc., were applied to this. (2) The second way (used only in special cases): The linen was doped without first being stretched on a frame.

(1) In general there is a gain in tensile strength due to the dope. No added effect was observed from the varnish.

(2) With a high-grade linen No. 1, the increase in strength amounted to about 10 to 15 per cent. With a medium grade, the increase, particularly in the filler, was much higher, about 40 to 60 per cent.

(3) Tests made on high-grade linen No. 1, coated without being stretched on a frame, showed a much higher tensile increase—in the neighborhood of 40 per cent in some cases. In the first samples, stretched fairly tight before coating, there was evidently not much shrinkage, in the latter samples the cloth shrunk at will, in some cases 3 or 4 per cent. In specifying the increase in strength due to dopes, the method of coating is therefore of importance. The first tests probably approach more nearly the conditions of use on the aeroplane.

(4) Linen coated with rubber, with or without dopes, is stronger than uncoated linen.

(5) Medium-grade linen shows a greater increase in tensile than high-grade linen, in some cases about twice as great an increase being observed.

2. STRETCH.

The stretch at different loads was measured for several different samples and curves plotted. The following points were noted:

(1) The stretch is less up to a certain load with coated fabrics than with the same fabric uncoated.

(2) There is no decided difference between cellulose acetate and cellulose nitrate dopes. The latter is usually supposed to give less shrinking than the acetate. It is possible that this view arises to some extent at least from the fact that fabrics coated with the

nitrate varnish are often more flexible than the others, and therefore appear, on a frame, less taut.

(3) Spar varnish slightly decreases the stretch.

(4) Linen coated with rubber has a greater stretch than the linen without rubber, the latter being, for example, 13 per cent at 96 pounds break, the former 16½ per cent at 100 pounds.

(5) Medium-grade linen, while it acquires a relatively greater strength increase due to coating, has both coated and uncoated a lower ultimate stretch.

	Break.	Stretch.
	<i>Pounds.</i>	<i>Per cent.</i>
High-grade linen No. 1.....	90-95	13½
High-grade linen No. 1 coated with varnish 1877.....	100	14½
Medium-grade linen No. 2.....	65	11
Medium-grade linen No. 2 coated with varnish 1877.....	78	¹ 10.7

¹ By extrapolation.

3. EFFICIENCY.

While it is desirable to have a wing material which will not easily sag, at the same time it is also important to have a fabric yield rather than break under load. A material which has this ability will often by yielding reduce the stress, and so stand usage which would otherwise be disastrous.

A convenient index of this, which for want of a better term we call the efficiency of the fabric, is the work required to break a piece say 1 inch wide and 12 inches long. This is represented by the area included by the stress-stretch curve. We have calculated this value for the various materials examined. The details and data are given elsewhere, but the following points may be mentioned here, observations being based on breaking in the direction of the warp, since the fillers do not show such marked differences.

(1) When the linen is fastened to a frame under fairly strong tension, as would ordinarily be done in covering a wing surface, and then coated, the work required to break a piece of given dimensions is not sensibly greater than that to break the uncoated material, in spite of the fact that the actual tensile strength of the linen seems to be higher after coating. This holds for high and medium grade linens.

(2) Linen coated under no tension required about two and one-half times as much work to break as uncoated linen. The greater stretch and increased tensile strength are both responsible for this.

In view of this the suggestion is made that there is probably some advantage in not using any more tension than is necessary in fastening the fabric to the frames before coating. The dopes have considerable shrinking power, measured linearly, and by allowing the cloth to shrink a certain amount the slack will be taken up and at the same time a greater efficiency obtained. A stress from collision, etc., will then have a chance to exhaust itself without breaking the

cloth, since the cloth can "give" and thus adjust itself to decrease the amount of the stress.

We understand that one manufacturer of the varnish at least recommends this. We have also been told that in some cases, as when a wing collides with an obstruction in landing, a dent may be formed in the fabric without breaking, this dent later disappearing. Since the varnish coating is noncrystalline, and can really be considered in a sense a supercooled liquid, it seems quite likely that there may be some flowing action permitting a slow readjustment of this sort.

(3) The use of spar varnish seems to have no decided effect on the efficiency.

(4) Rubber on one side of the linen with various coatings showed an efficiency about 75 per cent higher than that of linen without rubber, coated on frames. This is of course partly due to the greater stretch of such a fabric, as already noted. It would be interesting to find by practical experiment whether a fabric with rubber on one side can be made to shrink sufficiently for use on a wing. From our small experiments it seems likely that it would be satisfactory. If so, it would have the advantage of being protected on the under side, a matter of consequence in certain localities, as already shown.

4. AGEING.

Samples subjected to continuous exposure for three weeks in a location such that the material felt the full effect of sun and weather throughout the day gave the following results on tests:

(1) The tensile strength was 66 to 75 per cent of the original.

(2) In all cases samples had been greatly affected by the weather, in appearance and feeling. Spar varnish coatings cracked and peeled; samples doped but not coated with spar were more or less scrubbed off by the weather and had evidently deteriorated.

(3) In several cases samples doped and varnished with spar varnish showed a smaller decrease in tensile than those unvarnished, but the effect was not so pronounced as would be expected.

(4) Cellulose acetate coatings seemed more affected by the ageing than cellulose nitrate. This is probably due to the hygroscopic character of the former material, and to the ease with which oils are blended with the latter, making it more waterproof.

III. ABSORPTION OF WATER.

Samples were first weighed, then dried at 95–100° C., and reweighed, after which they were tested. One piece of each was soaked in water at an average temperature of 25° C., another was hung in a saturated atmosphere at the same temperature—for two weeks in both cases. The samples were removed, surface water wiped off the ones that had soaked, after which they were weighed in a weighing bottle. They were then dried at 95–100° C., and reweighed. These data gave the amount of moisture normally present, the amount of water taken both by soaking, and by standing in moist air, and the amount of material washed out by soaking in water. The following results were obtained:

- (1) Loss from soaking amounts to 3 to 7½ ounces of the weight of the sample.
- (2) Compared with dried samples, fabrics exposed to saturated atmosphere showed 6 to 13 per cent moisture.
- (3) Soaking caused the samples to take up 30 to 60 per cent of water.
- (4) Cellulose acetate coatings suffer more from soaking than cellulose nitrate.
- (5) Fabrics coated with rubber on one side, and doped on the other side, show a smaller absorption of water on soaking, and a smaller increase in weight due to moisture taken up on standing in a saturated atmosphere than unrubberized fabrics. The effect of spar varnish, in preventing the absorption of water was here very apparent.

IV. FIREPROOFING.

Tests on fire resisting properties of various fabrics were made, to find the effect of the different coatings, and to investigate the possibility of impregnation of fabric with fireproofing materials.

Method of test.—A strip of the fabric $\frac{3}{4}$ inch wide, was held horizontally, coated side up, and the end touched to a Bunsen flame for a distance just sufficient to ignite. The time required to burn back for a distance of 3½ inches was observed; in cases where the flame was extinguished before this point was reached, the actual distance was noted. Care was taken to avoid drafts.

- (1) All coated fabrics not otherwise treated were inflammable; that is, the piece continued to burn after the source of heat was removed.
- (2) Spar varnish seemed to retard the burning of fabric coated with cellulose nitrate, and to accelerate it in the case of fabric coated with cellulose acetate.
- (4) Fabrics impregnated with ammonium chloride and ammonium phosphate were more fireproof than those impregnated with boric acid. In every case the first two prevented the flame from being self-propagating even when the fabric was doped with cellulose nitrate.
- (5) It is interesting to note (see appendix) that fabric impregnated with ammonium chloride has an increased initial tensile strength, but deteriorates more rapidly on exposure. This is probably on account of hydrolysis of the cellulose (fabric). These experiments lead one to believe that by further investigation a thoroughly satisfactory material may be found, which will make fabric fireproof and at the same time not injure it.

Part II.—BALLOON FABRIC.

I. MATERIALS.

Cotton is the most widely used fabric for balloons, in spite of the fact that it is one of the weakest textile fabrics. Silk, the strongest textile fabric, is used to some extent in France and Italy, when lightness is the most important feature. In Germany, it is usually considered dangerous, owing to its electrostatic properties. Its

high cost is another objection, when large amounts are needed, as in a Zeppelin type dirigible.

Ramie has been used, but is reported to be unsatisfactory, owing to the difficulty in rubberizing.

Linen has been used, with success, and on account of its greater strength possesses considerable advantage over cotton. The greater tearing resistance of this material as compared with cotton is particularly important. On the other hand, as already stated, it is more difficult to obtain, made according to specifications, than cotton.

In large balloons, rubber is used almost without exception. Other materials are less permeable to hydrogen, but none possess the same properties of adhesion, ease of working, and flexibility. Several layers of fabric can be used, thus increasing the strength and gas-tight properties of the material, whereas oiled fabrics are ordinarily used in a single layer, and to keep this tight a thin closely woven fabric must be used. Furthermore, oiled fabrics are subject to change from heat and cold and must be handled with care. They are, however, cheaper than rubberized fabrics.

We have obtained various cotton fabrics suitable for use in balloon cloth, and from the tests on these, and also from published data of tests made in Europe, have endeavored to establish some relation between the weight and maximum strength obtainable at that weight. Differences in testing conditions, such as humidity and method of testing, not usually specified, cause a certain variation, so the probable limits of strength of each weight are given.

Until recently it was very difficult to obtain a satisfactory fabric made in this country. Labor and other conditions in Europe have permitted a greater concentration upon the spinning and weaving of such fabrics. The results have been that until recently no cotton fabrics comparable to those made in Europe could be obtained.

Recently there have been produced in this country fabrics which from the standpoint of weight and strength are probably as good as those made in Europe. It is to be hoped that the same perfection in spinning and weaving may also be obtained.

In the former operation cotton manufacturers usually admit the superiority of European material, but probably in time this can be met. This point is important, in order to get a fabric as free from flaws as possible.

The mean results of our tests and those from abroad would indicate the following:

Weight of fabric.	Strength warp and filler.
<i>Ounces per square yard.</i>	<i>Pounds per inch.</i>
2	30
2½	42
3	53
3½	65
3¾	74

II. STRENGTH AND AGEING TESTS.

(1) *Effect of structure.*—Ordinarily balloon fabrics are made of two or more cloth layers, one of these usually on the bias. A layer of rubber is between each ply of fabric and a layer on the face of the fabric which comes in contact with the gas. The outside surface may or may not be coated with rubber and is sometimes treated after the balloon is made with cellulose acetate varnish. Parallel fabrics—that is, two or more layers of fabric with the warp threads all running in the same direction—have been used to some extent in France. They are supposed to be stronger, but tear more easily. Since cotton tears quite easily under ordinary conditions, it seems highly desirable to adopt some such method as biasing to prevent tearing. While the biased fabric does not show so high a tensile strength test, it must be remembered that the stresses on a dirigible balloon which cause trouble are not the simple ones due to internal pressure, weight of load, etc., but those localized in one area due to sudden pulls on ropes, etc. It is important to have a fabric that will not continue to tear after a tear is once started.

Tensile strength tests made on 1-inch strips showed that the strength of a 2-ply parallel fabric was not necessarily twice that of the single ply of uncoated fabric. On the other hand, double bias fabrics show a greater strength than that of the single ply of fabric when the stress is parallel, for example, to the warp of the unbiased piece.

	Balloon cloth made from—	
	Fabric No. 1.	Fabric No. 2.
Strength of fabric, uncoated warp.....	70	50
Strength of 2-ply parallel fabric warp.....	125.5	92.6
Strength of fabric 2-ply bias warp of unbiased ply.....	85	66
Tensile strength by bursting test, 2-ply bias.....	100	85

Ageing for 13 weeks, the samples being continuously exposed to the weather, caused a decrease in tensile strength of about 5 per cent. The samples were exposed during the winter months, from January 1 to about April 1.

Other samples exposed for one month, from August 20, to September 20, showed a decrease of about 8 to 10 per cent in tensile strength in the warp and from 0 to 6 per cent in the filling. The rubber was apparently unaffected.

III. PERMEABILITY OF BALLOON FABRICS.

The permeability was measured by the chemical method similar to that used at the National Physical Laboratory of Great Britain. In this method the fabric is held in a cell, which is divided by the fabric into two compartments. Dry purified hydrogen at a pressure of 70 millimeters of water is passed through one side, while air is drawn through the other, dried and passed through an electric furnace, which burns the hydrogen present in the air from diffusion to water,

which is absorbed and weighed. The cell is kept at constant temperature by immersion in a thermostatic bath. The permeability is expressed in liters of hydrogen, measured at 0° C., 760 millimeters per square meter of fabric per 24 hours.

In France the Renard-Sourcouf balance is ordinarily used. This measures the net volume of gas lost by diffusion through the fabric. It does not in reality measure the loss of hydrogen, since air passes in while hydrogen passes out. According to T. Graham,¹ the relative rates of diffusion of nitrogen, air, and hydrogen are as follows:

Diffusion through rubber.

Nitrogen.....	1
Air.....	1.149
Hydrogen.....	5.5

With the Renard balance, while 5.5 volumes of hydrogen pass out, according to the above figures, 1.149 volumes of air pass in, giving a net change of 4.351 volumes. In other words, for an apparent loss of 10 liters per 24 hours per square meter, we should have an actual loss of 12.6 liters, as measured by the chemical method. (We have not had an opportunity to test fabrics measured by the gas balance method.) The volume loss is of course important, and if on further investigation it is found that there is much variation in the ratios given by the Graham experiments for different kinds of rubber it would be well to make both tests standard. In fact, the introduction of auxiliary coatings of cellulose esters, etc., makes this of immediate interest.

(1) EFFECT OF VARYING AMOUNTS OF RUBBER.

The permeability decreases with increasing weight of rubber as a general rule, but does not seem to be proportional to it.

Weight of rubber between plies (ounces per square yard).	Permeability at 15° (by extrapolation).
1.65	50
3.11	9
5.11	9

This is in accord with the observation of Austerweil,² who found that the permeability of two rubber membranes, 918 and 1,675 grams per square meter respectively, was practically the same for the first 100 hours. The rates diverged up to 400 hours, after which they were again constant. This, according to Austerweil, marked the point when both membranes were saturated. Between 100 and 400 hours the thinner membrane became saturated more rapidly than the other, and so showed a greater rate of diffusion.

¹ Phil. Trans., 1866, p. 399.

² Die Angewandte Chemie in der Luftfahrt, p. 67.

(2) EFFECT OF TEMPERATURE.

Experiments conducted in England at the National Physical Laboratory¹ show that the permeability rises rapidly with the temperature. For two samples they found the following results:

Diagonally doubled, 3 layers rubber.....	{15.5° C.— 6.71 l
	{22.1° C.—10.84 l
Parallel doubled, 2 layers rubber.....	{15.5° C.—12.3 l
	{22.1° C.—21.5 l

These figures show more than 9 per cent increase in permeability per degree.

We have made tests at approximately 20, 30, and 40° C., and found in every case a marked temperature coefficient. If the values of permeability and temperature are plotted, it will be noted (fig. 9, appendix) that the curve rises more rapidly with increasing temperature. Our results show a temperature coefficient about one-half that given in the data just cited. It may be that the nature of the rubber compound has considerable bearing.

This high temperature coefficient is of peculiar importance in this country, where the aeronautic activities of both Army and Navy are centered in the South. It seems advisable that this be considered in specifying the minimum gas leakage allowable when contracting for dirigible balloons, and that some temperature be stated, since a balloon tested at Pensacola would, without extra precautions, show a higher loss than one in the vicinity of New York. A correction to a standard temperature could probably be made.

This also shows the advisability of providing adequate arrangements to prevent too high a temperature in hangars. I understand that in Europe double roofs, with fans and other suitable cooling devices are used.

(3) EFFECT OF COATING CLOTH WITH CELLULOSE ESTER LACQUERS.

It has been the practice in Europe for some time, apparently, to coat the outside of balloons with some sort of varnish. These are sold under various names, but in general are cellulose acetate lacquers. They are used to cut down wind resistance, to protect the fabric, and to render it gas tight in cases where the rubber has deteriorated.

Samples were given four coats of cellulose nitrate and cellulose acetate lacquers 1876 and 1877, respectively, the lacquer being applied to the cloth. In both cases the improvement in permeability was definite, though small, amounting to from 1 to 1½ liters per square meter per 24 hours.

(4) EFFECT OF COATING RUBBER WITH CELLULOSE ESTER LACQUERS.

It seemed likely that the small improvement noted above was due to the fact that cloth offers a poor surface for obtaining a tight coat, at least for a thin film. To verify this tests were made with the same

¹ Tech. Report Adv. Committee for Aeronautics, 1910-11, p. 60.

materials in the same amounts on the rubber side. The improvement was very marked here, amounting to 50 per cent or more of the value found for the same fabric uncoated. In one case there was a reduction from 11 liters at 20° C. to 4 liters at the same temperature. Unfortunately these lacquers are not suited for use on rubber surfaces since they peel off. It is to be hoped that a marked improvement may be made in them, since their use for this purpose seems very promising. The inflammability of cellulose nitrate is of course a drawback, but obviously a balloon filled with hydrogen must be carefully protected from fire, however noninflammable the material used in its construction. It is, moreover, a simple matter to obtain cellulose nitrate blended with oil to give a flexible coating.

(5) EFFECT OF COATING RUBBER WITH GELATIN COMPOUNDS.

A flexible gelatin compound on the rubber surface in about the same amounts as the coatings used in (4) and (5) was tested and found to give a very low permeability:

Original permeability at 20° C., 11 liters per square meter per 24 hours.
Permeability after coating with gelatin compound at 20° C., .8 liter approximately per square meter per 24 hours.

Part III.—TESTS ON BALLOON AND AEROPLANE FABRICS.
I. TEARING TESTS.

To obtain some knowledge of the behavior of aeronautic fabrics under stresses somewhat similar to those existing in aeroplanes and balloons, the test used by the National Physical Laboratory¹ was employed.

Method.—A piece of fabric is clamped in the jaws, and in the center of this a slit of definite length is cut perpendicular to the line of pull. When stress is applied, the cut opens, and if the load is increased the tear widens in a direction perpendicular to the stress and the sample finally breaks. The threads parallel to the line of stress bend inward on either side of the slit; those perpendicular to the strain bend away from the cut. The localization of strain on the thread at the ends of the slit is evidently caused by the pull being transmitted from the longitudinal threads to the transverse threads, due to the take-up in weaving. The general effect of stretching coated and uncoated fabrics is shown in the photographs taken of tests. (Appendix, Plates I-VI.) The wrinkling of the coated fabric around the cut, producing a poor impression, is particularly of interest, showing how the disturbance is more localized than in the case of uncoated fabric.

A fair index of the ability of fabrics to resist tearing may be obtained by plotting the results for the point at which the tear starts to widen and where rupture occurs against the size of cut. The factor found by dividing the breaking load by the width of slit gives a means of comparison which seems to have some value. (See appendix for data and curves.)

(1) The load to break falls off more rapidly with increasing size of slit in the case of a doped fabric than with an undoped fabric.

(2) Cotton is much inferior to linen.

¹ Tech. Report of Adv. Com. for Aeronautics, 1910-11, p. 72.

(3) Parallel double balloon fabric tears more easily than bias doubled fabric, particularly for small cuts. Furthermore, a parallel fabric tears evenly in a straight line, while in the case of the bias a general rending of one layer occurs, while the other is distorted rather than torn. It can be readily seen that the effect of tearing on the parallel fabric in a balloon would be much more disastrous.

II. SURFACE FRICTION TESTS.

Tests on the resistance of various fabrics were made in the wind tunnel at the Washington Navy Yard.

The method used was to suspend vertically a glass plate about 34 inches wide and 9 feet long so that its long edge is in the direction of the air flow. The following edge of the plate is connected with the balance, allowing the horizontal moment about one knife edge to be measured.

Corrections were found and used for the wires suspending the plate. The ends of the plate fitted into slots in struts of stream line form. The wind passing the slot into which the leading edge fitted caused a diminution in pressure, giving the effect of a thrust on the plate against the wind. The wind caused a compression in the slot in which the following edge fitted, likewise giving the effect of a thrust against the wind. The amount of pressure developed in each slot was observed with a hook gauge manometer, and from this and the area of the edges could be calculated the correction to be added for each speed.

The resistance of the plate glass was taken as standard and found at 30, 40, 50, 60, and 70 miles per hour. Various samples of fabric were then attached, covering both sides of the glass completely in each case, and the resistance measured at different speeds.

Complete data will be found elsewhere, but the following general points may be mentioned here. Taking, for example, the resistance of plate glass as 1, at 70 miles per hour, we have the following comparative resistances at this velocity:

Experi- ment No.	At 70 miles per hour.	
1	Plate glass.....	1. 000
5	Linen No. 1 (high grade).....	1. 362
2	Linen No. 1 (high grade), 1 coat varnish No. 1876.....	1. 162
3	Linen No. 1 (high grade), 3 coats varnish No. 1876.....	1. 108
4	Linen No. 1 (high grade), 3 coats varnish No. 1876, 1 coat spar varnish..	1. 061
6	Linen No. 1 (high grade), 3 coats varnish No. 1877.....	1. 085
7	Linen No. 1 (high grade), 3 coats varnish No. 1877, 1 coat spar varnish..	1. 081
8	Linen No. 1 (high grade), 3 coats varnish No. 1877, 2 coats spar varnish.	1. 078
9	Balloon fabric No. 3, cloth outside, double parallel.....	1. 965
10	Balloon fabric No. 3, cloth outside, double parallel, freshly singed.....	1. 654
11	Balloon fabric No. 3, cloth outside, double parallel, singed and coated once, No. 1876.....	1. 345
12	Balloon fabric No. 3, cloth outside, double parallel, singed and coated three times, No. 1876.....	1. 107
13	Balloon fabric No. 3, cloth outside, double bias.....	1. 902
14	Balloon fabric No. 3, cloth outside, double bias, freshly singed.....	1. 762
15	Balloon fabric No. 6, cloth outside (specially woven fabric), double bias.....	1. 528
16	Balloon fabric No. 6, cloth outside (specially woven fabric), double bias, freshly singed.....	1. 372
21	Aeroplane fabric, rubberized, No. 23.....	1. 079
22	Aeroplane fabric, aluminum coated, No. 24.....	1. 101

I. From these figures it will be seen that we may roughly divide surfaces into groups as to wind resistance.

(1) Those which are what might be called continuous; in this case the resistance probably increases simply as the surfaces deviate from a true plane due to lumps and other unevennesses. Plate glass, doped, varnished, and rubberized fabrics come in this class. The resistance does not exceed 1.20, glass being 1.

(2) Those which have a discontinuous surface, i. e., such as would be presented by a perfectly smooth woven material, as a wire gauze; linen and singed cotton approach this. Here the resistance is between 1.35 and 1.7.

(3) Those which have a discontinuous surface to which is added other roughnesses, such as arise from nap. Unsigned cotton is in this class, and the resistance is 1.5 or more.

II. It is interesting to note the great improvement produced on balloon fabric by the use of one or more coats of some sort of varnish.

III. The *difference* in resistance between an uncoated fabric of class (3) and plate glass is very appreciable at high speeds, being about 0.013 pound per square foot at 70 miles per hour. This would mean a total head resistance in a large machine of about 18 pounds, or a decrease in lifting power of 150-180 pounds. However, as can be seen from the list, it is fairly simple to cut down the resistance until it approximates that of glass.

APPENDIX

TO

REPORT No. 6, PART 1.

[Containing details, data, and plates.]

LINEN FABRICS.

Linen is the most widely used material for aeroplane wings, on account of its great strength and toughness. The grades now on the market have weights and strengths as shown:

	Weight (ounces per square yard).	Strength.	
		Warp.	Filler.
I	3.67	65.0	54.4
II	3.78	69.5	49.2
III	3.87	80.7	79.0
IV	4.04	86.9	74.0
V	4.09	90.2	82.7
VI	4.48	82.9	100.1
VII	4.60	95.0	60.0
VIII	4.86	90.4	102.5

In Great Britain there has recently been adopted the method of testing the sample wet, after soaking some time. This is to avoid error due to humidity changes. While this method may seem somewhat arbitrary, it is convenient and nearer the conditions of use than a test on absolutely dry material. They figure that this test corresponds to what could be expected at a theoretical humidity of 111 per cent.

Tests on transparent cellulose acetate sheets.

No.	(1) Thickness.	(2) Weight (ounces per square yard).	(3) Tensile strength (pounds per inch).		(4) Maximum difference in tests (in per cent of average value).	
1	10/1000	9.33	55.3	57	10.8	10.5
2	16/1000	15.49	106.3	85.8	14.1	8.1
3	24/1000	22.96	127.1	130	30.6	25.2
4	32/1000	30.35	178.6	187.7	21.2	2.6
5	64/1000	59.02	326	345.8	10.7	.8

Tests made on Riehle machine, 1-inch strips, 1-inch jaw, 3 inches between jaws; speed, 18 inches per minute.

The strength was measured both ways on each sheet, since it was thought that the material might show a grain, such as often occurs in materials in sheet form which have been made by a calendering process. Except in the case of No. 2, there is no perceptible difference in strength. The material runs fairly uniform in strength except for the one sheet No. 3. Column 4 shows the difference between the highest and lowest tests, compared to the average.

The material is quite flexible, in thin sheets, and can be bent double several times in one place without cracking. On the other hand, it tears very easily when once cut. It is nonflammable.

STRETCHING TESTS.

Figures 1-4 show the relation between load and per cent stretch. The numerical values for the tests are given on page 155 and need little comment.

The tests were made on a Riehle fabric-testing machine, and measurements were made on an initial distance of 20 inches, so the results are probably quite accurate. The jaws moved apart at a rate of 6 inches per minute.

It is interesting to note that the rate of stretch is usually low in doped fabrics up to 10 to 20 pounds load, after which it rises more rapidly. On the other hand, the uncoated fabrics tend to be just the opposite of this—that is, there is a considerable stretch at first under light load, up to say 20 pounds, then the “slack” having been removed from the fibers, the stretch is much slower. It will be noticed that this holds true even for samples when the total stretch of the coated fabric greatly exceeds that of the uncoated, as in figure 2, Curves VIII, IX, X, XI, when the fabric was not stretched on a frame without coating. The stretch of the coated fabric only becomes equal to that of the uncoated at loads of 12 to 20 pounds.

The application of this seems to lie in the fact that ordinarily even at high speeds the loading due to wind pressure is very light. According to Austerweil¹ even at highest speeds the load would not amount to more than 145.5 kilograms per meter, or about 8 pounds per inch. Ordinarily it would be much less. It would seem therefore that from the standpoint of keeping the fabric taut against stretching just as good results could be obtained by putting it on loosely enough to allow shrinkage, and get the benefit of increased tensile strength and efficiency shown by the fabrics in Curves VIII-X, inclusive.

¹ Die Angewandte Chemie in der Luftfahrt, 179.

Stretch of aeroplane fabric.

Fabric.	Curve.	Stretch under load of (pounds per inch)—										Efficiency— in (1-inch by 12-inch strip) foot- pounds.		
		10	20	30	40	50	60	70	80	90	100		110	
Linen No. 1:														
Untreated warp.....	I	3.65	7.10	8.30	9.35	10.10	10.65	11.15	11.55	12.05	(96) 12.35			8.67
Untreated Filler.....		1.62	2.37	2.90	3.37	3.75	4.16							
Varnish 1875—														
W.....	II	1.25	3.75	6.66	9.25	10.58	11.83	12.92	13.75	14.75				7.77
F.....		.80	1.68	1.86	2.12	2.66	3.19	3.73	4.36					
Varnish 1876—														
W.....	III	1.17	3.58	7.50	9.92	11.50	12.58	13.50	14.12	14.50	15.00			9.62
F.....		.75	1.58	2.58	3.42	4.11	4.42	5.25	5.62	6.00				
Varnish 1877—														
W.....	IV	1.75	4.7	7.42	9.35	11.25	12.00	12.83	13.33	14.12	14.50	14.75		10.93
F.....		.75	1.75	3.00	3.50	4.00	4.75	5.25	6.00	(86) 6.75				
Varnish 1875 and Spar—														
W.....	V	1.17	3.42	5.92	8.00	9.33	10.62	11.50	12.08	13.00	(95) 14.00			7.54
F.....		1.00	1.75	2.75	3.33	4.25	4.62	5.33	6.00	(86) 6.50				
Varnish 1876 and Spar—														
W.....	VI	1.10	3.5	6.42	8.80	10.30	11.25	12.16	13.00	13.53	14.00			8.75
F.....		.83	1.75	2.75	3.75	4.33	4.92	5.33	5.92	6.37	(96) 7.00			
Varnish 1877 and Spar—														
W.....	VII	1.75	4.00	6.50	8.75	10.50	11.75	12.12	12.50	13.00	(96) 14.2			7.32
F.....		1.04	1.99	2.85	3.55	3.81	4.08	4.60	4.86					
Linen No. 1, coated, without prestretching, coated with—														
Varnish 1875—														
W.....	VIII	5.00	6.89	11.44	15.33	17.55	18.89	20.00	21.17	21.75	22.67	120-23.67 23.33		19.41
F.....		2.20	3.33	4.33	5.07	5.76	6.33	7.00	7.37	(88) 8.13				
Varnish 1876—														
W.....	IX	3.16	7.83	12.00	15.08	17.08	18.08	19.66	20.42	21.17	22.00	120-23.83 22.50		19.11
F.....		2.00	3.80	4.77	5.25	6.00	6.37	6.50	7.00					
Varnish 1877—														
W.....		2.81	10.43	15.00	17.50	18.75	19.75	20.43	21.06	21.56	22.12	22.83		18.19
F.....		1.83	3.08	4.16	4.58	5.16	5.66	6.16	6.37					
Linen No. 1:														
Rubberized—														
W.....	IR	7.42	11.25	12.44	13.44	14.06	14.56	15.06	15.56	15.92	16.50			12.89
F.....		2.25	3.50	4.00	5.25	5.8	6.25							
Rubberized—														
Varnish 1875—														
W.....		1.92	5.58	8.58	10.92	11.66	13.08	13.92	14.42	14.92	15.33	16.25		11.77
F.....		1.92	2.81	4.00	5.12	5.62	6.37	6.50	7.00					
Varnish 1876—														
W.....		2.56	7.25	10.37	12.12	13.19	14.00	14.6	15.19	15.6	16.19	120-17.25 16.75		15.16
F.....		1.37	3.00	4.00	5.12	5.5	6.00	6.57	6.81					
Varnish 1877—														
W.....		2.75	7.08	10.5	12.25	13.33	14.17	14.92	15.5	15.92	16.37	16.70		13.46
F.....		1.62	3.19	4.19	5.08	5.66	6.17	6.50	6.92	7.25				
Varnish 1875—														
Spar—														
W.....		1.75	6.75	9.25	11.50	12.66	13.21	14.06	14.69	15.44	15.5			12.25
F.....		1.33	2.42	3.50	4.50	5.16	5.58	6.00	6.16					
Varnish 1876—														
Spar—														
W.....		2.50	7.94	11.06	12.81	13.77	14.69	15.37	16.00	16.37	16.62	17.00		13.64
F.....		1.37	3.06	4.44	4.62	5.19	5.56	6.19	6.31					
Varnish 1877—														
Spar—														
W.....		2.66	6.66	9.83	11.5	12.92	13.83	14.58	15.08	15.58	16.06	16.5		12.66
F.....		1.33	2.42	3.58	4.42	4.92	5.33	5.50	5.87					

Stretch of aeroplane fabric—Continued.

Fabric.	Curve.	Stretch under load (pounds per inch).										Efficiency in (piece 1 by 12 inches) foot- pounds.	
		10	20	30	40	50	60	70	80	90	100		
Medium-grade linen No. 2.													
W.....	IM	5.08	7.42	8.42	9.16	9.50	10.12						4.51
F.....		3.75	5.00	5.75	6.12								
Linen No. 2:													
Varnish 1875—													
W.....	IIM	1.58	4.16	6.42	8.67	9.92	10.62	11.50					4.77
F.....		1.67	1.42	2.33	3.16	3.83	4.42	5.00	5.12	5.50			
Varnish 1876—													
W.....	IIIM	1.33	3.08	5.08	6.58	7.50	8.33	8.75	9.50				4.56
F.....		1.17	2.50	3.83	4.92	5.83	6.50	7.12					
Varnish 1877—													
W.....	IVM	1.66	3.92	5.92	7.58	8.50	9.42	10.12					4.18
F.....		1.42	3.00	4.25	5.67	6.25	6.87	7.50					
Varnish 1875 and spar—													
W.....	VM	1.17	2.75	4.83	6.33	7.33	8.75	8.83	9.58	10.00			5.50
F.....		1.19	2.50	3.58	5.00	5.75	6.42	6.83	7.17	7.75			
Varnish 1876 and spar—													
W.....	VIM	1.50	3.50	5.50	6.92	7.75	8.58	9.25	10.00				4.82
F.....		1.00	2.16	3.17	4.08	4.75	5.25	5.83	(75) 6.00				
Varnish 1877 and spar—													
W.....	VIIM	1.33	3.33	5.00	6.58	7.75	8.50	9.16	9.75	10.25			5.68
F.....		1.58	2.66	3.50	4.83	5.42	6.08	6.58	(75) 6.75				

TEARING TESTS.

In these tests wooden jaws were used, fitted to a Riehle fabric testing machine. The jaws moved apart at a speed of approximately 6 inches per minute.

The Plates I-VI were made by setting up the machine in a dark room, putting the sample under tension, and holding a dry plate against the sample. An electric bulb on the other side of the sample furnishes light for the exposure. In the case of cotton fabrics the small size of the yarn and its transparency gave poor definition; this difficulty was removed by first coloring the sample with a yellow naphtha soluble dye. The photographs are therefore actual size, and show up the conditions of the threads quite clearly.

The factor obtained by dividing the breaking load for a 1-inch cut by that for the uncut fabric gives some idea as to the relative tearing resistance of various materials. This, with the actual tensile, should furnish a good basis for comparing fabrics as to suitability.

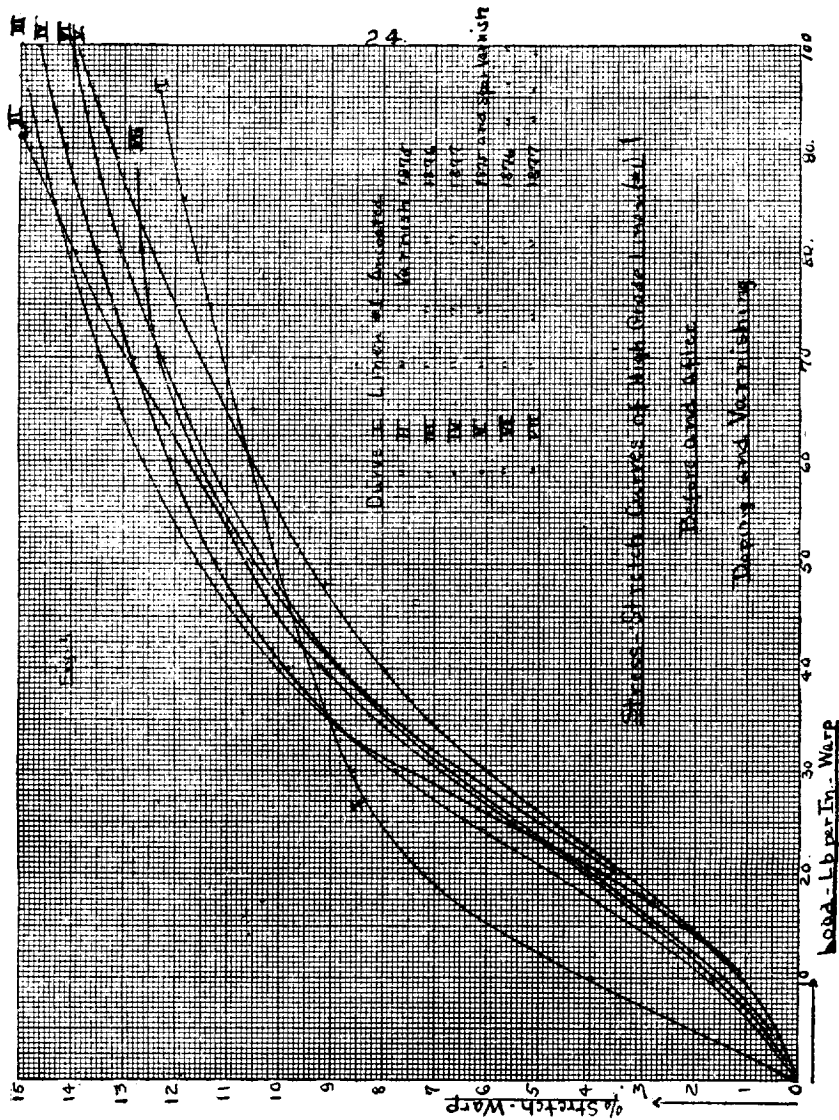

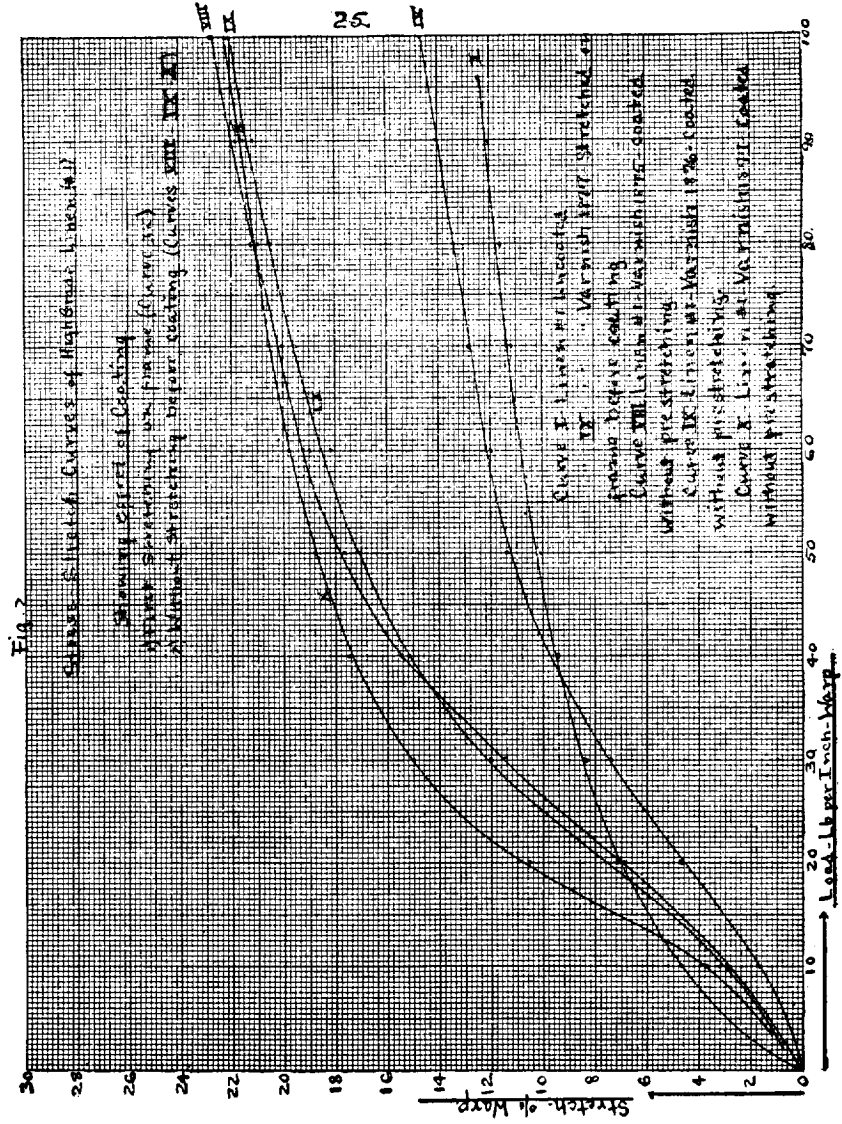
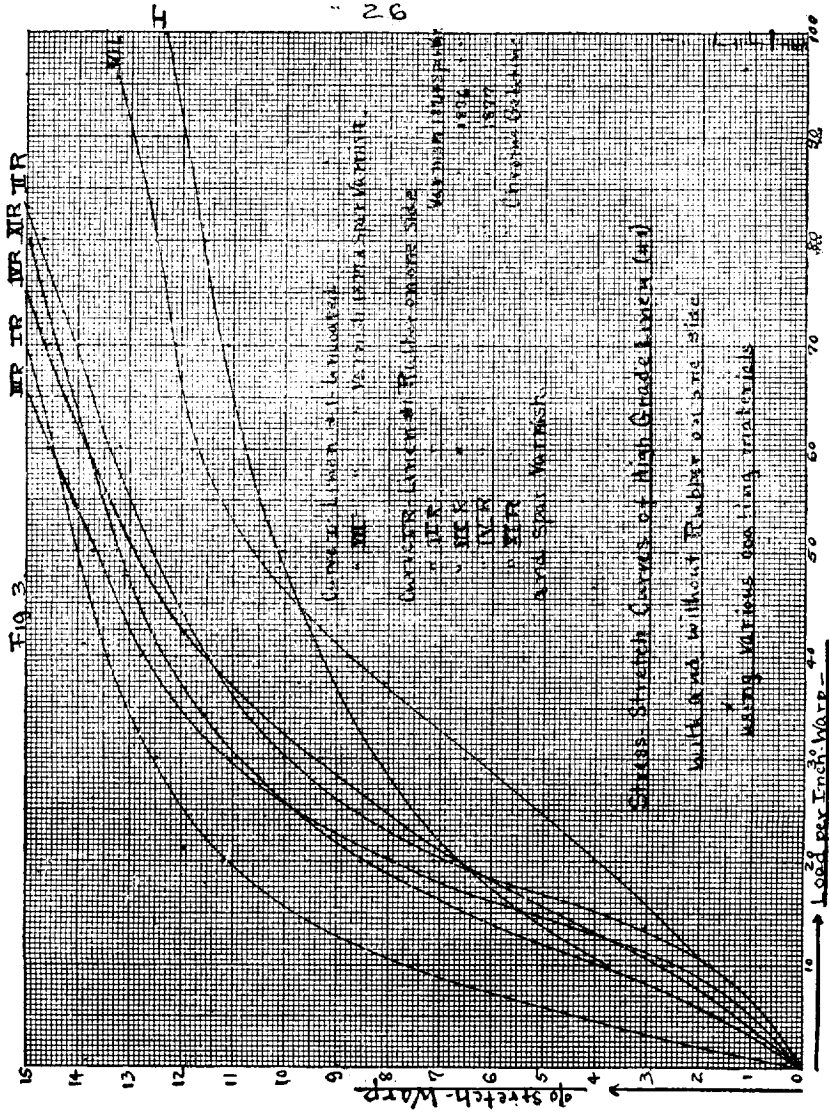
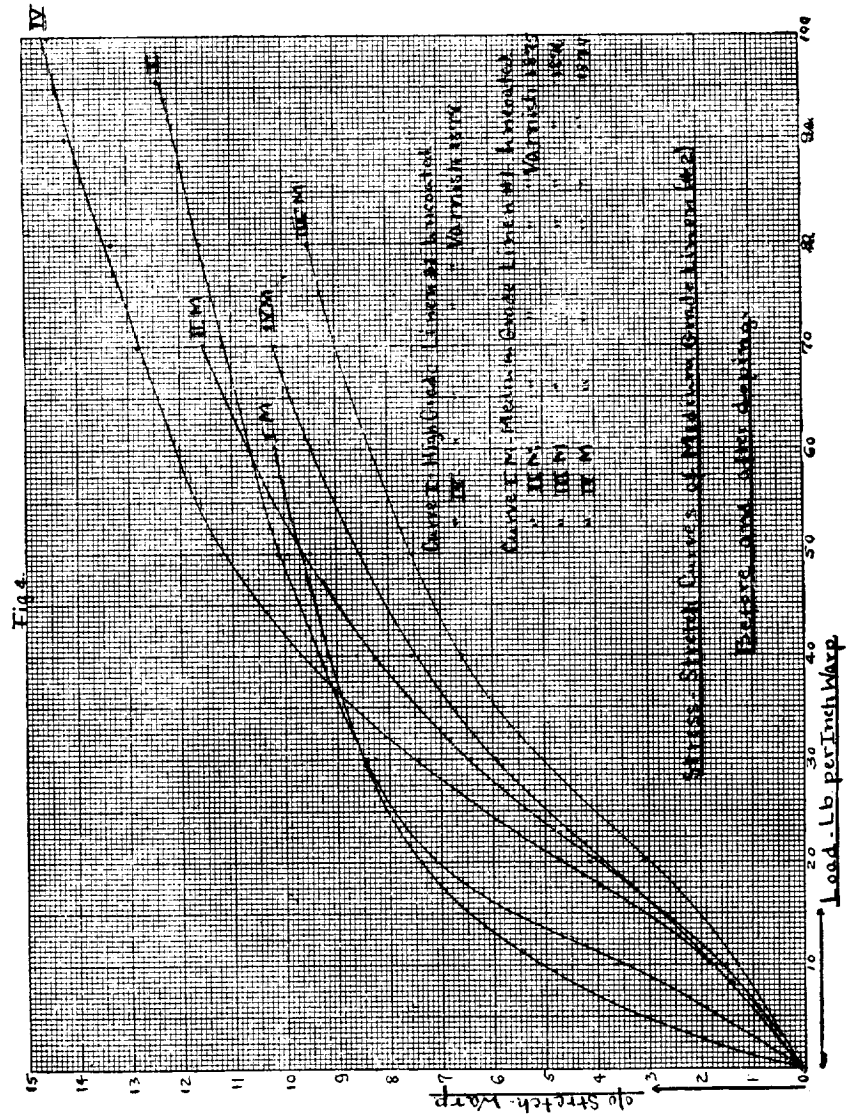

Fig. 2
 Curves of Stretch of Warps (Laminar Warps)
 showing effect of coating
 and stretching on warp (Curve I)
 without stretching before coating (Curve III, IV, V)





	Tensile strength (pounds per inch).		Tearing factor.	
	Warp.	Filler.	Warp.	Filler.
Linen No. 1, high grade:				
Uncoated.....	100	59	0.50	0.52
Doped.....	106	86	.29	.44
Linen No. 2, medium grade:				
Uncoated.....	65	45	.67	.57
Doped.....	85	75	.58	.58
Cotton, light weight:				
Uncoated.....	37	49½	.48	.36
Doped.....	45	45	.38	.37
Balloon fabric:				
Double parallel.....	85	70	.36	.33
Double bias.....	6566

From the above figures it will be seen that the lower grade of linen is relatively more difficult to tear than the high grade. This is probably because the higher grade fabrics, both linen and cotton, owe their greater strength for a given weight to the greater number of yarns per inch. These are of necessity smaller, and since tearing depends to a considerable extent on the strength of the individual threads, we find that strong, closely woven fabrics tear more easily in proportion than weaker ones. A good example of this is the filler of the cotton fabric, compared with filler of No. 2 linen. The actual tensile strength of the cotton is higher, but the effect of a cut much greater, giving the factors as shown: 0.36 for the cotton and 0.57 for the linen.

Tearing tests on aeroplane and balloon fabrics—Load required to start tear, and to break, for slits of various sizes.

Fabric.	Size slit.									
	0 inch.		¼-inch.		½-inch.		1-inch.		1½-inch.	
	Load per inch.									
	Tear.	Break.	Tear.	Break.	Tear.	Break.	Tear.	Break.	Tear.	Break.
Linen, No. 1, high grade, uncoated:										
Warp.....	100	100	66½	74	48½	66	36	50	27	49
Filler.....	59	59	40	44	34	42	23½	31	18	29
Linen, No. 1, high grade, coated, 1875 var.:										
Warp.....	106	106	74	90	49	70	31	45	26	43
Filler.....	86	86	51	68½	37½	45½	30	38	27	31
Linen, No. 2, medium grade, uncoated:										
Warp.....	65	65	49½	51	32	50	28	44	21	42
Filler.....	45	45	29½	35	26	30	20	26	17	25
Linen, No. 2, medium grade, coated, 1875 var.:										
Warp.....	85	85	57	74	41	64	23	50	21	49
Filler.....	75	75	55	62	38	46	29	43½	25	36
Cotton, light weight, uncoated:										
Warp.....	37	37	16	18	10½	18	10	18	9	18
Filler.....	49½	49½	18	20	14	18	10	18	(8)	(15)
Cotton, light weight, coated, 1875 var.:										
Warp.....	45	45	23	26	18½	22	15½	17½	14	18
Filler.....	45	45	20½	22	15	16½	11½	(17)	11	14½
Balloon fabric, double, parallel:										
Warp.....	85	85	41	46	30	37	23	31	20	25
Filler.....	70	70	34	36	23	29½	17½	23½	14	20
Balloon fabric, double bias.....	65	65	53	57	47	52	30	43	20	34

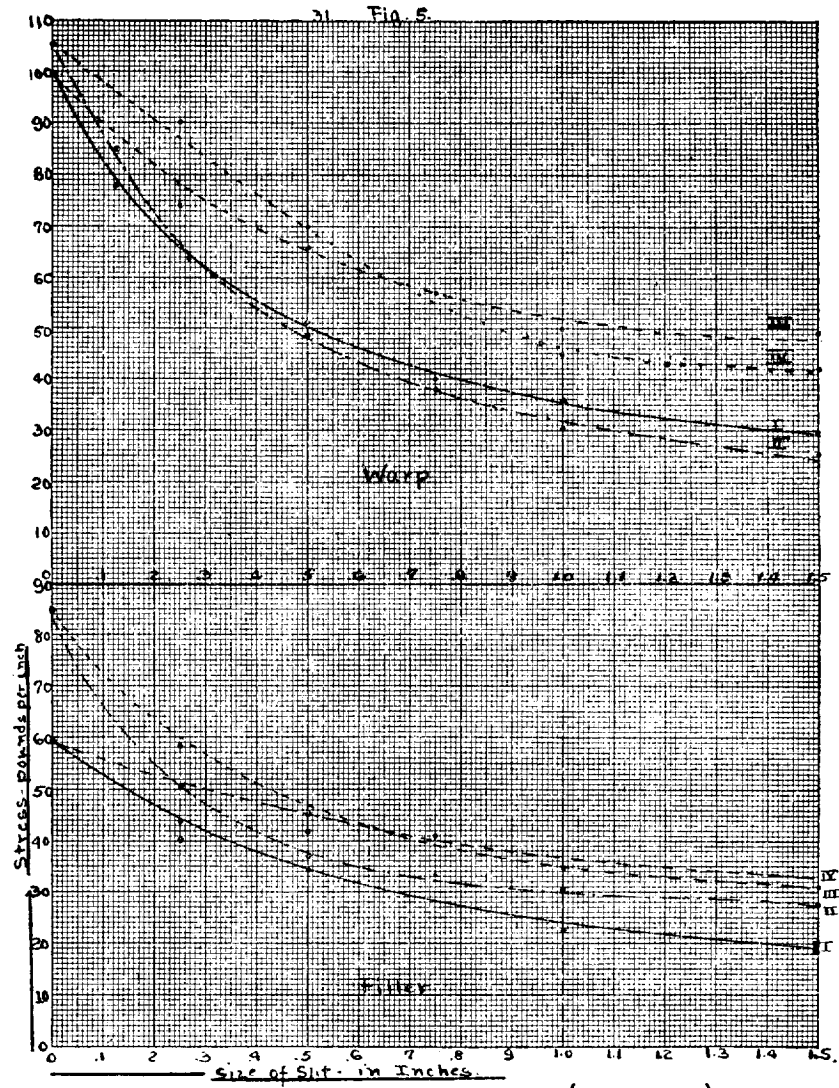

Tearing Tests on Linen - #1 (High Grade)

Curve I	Tearing Point	Undoped	————	Tearing Point; Undoped
" II	"	Doped	-----	" " Doped
" III	Breaking	Undoped	Breaking Point
" IV	"	Doped	Breaking Point

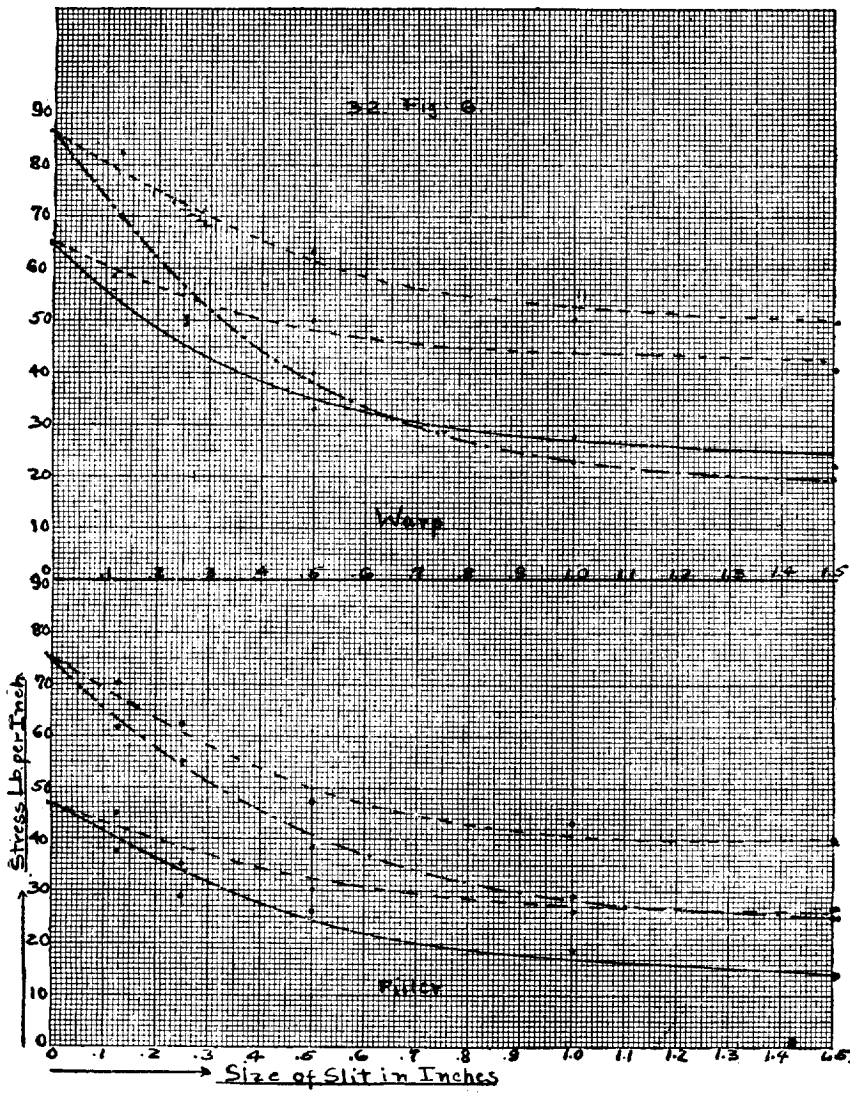

Tearing Tests on Linen #2 (Medium Grade)
 Curve I - Tearing Point - Undoped ——— Tearing Point - Undoped
 " II - " " Doped - - - - - " " Doped
 " III - Breaking Point - Undoped - - - - - Breaking Point
 " IV - " " Doped

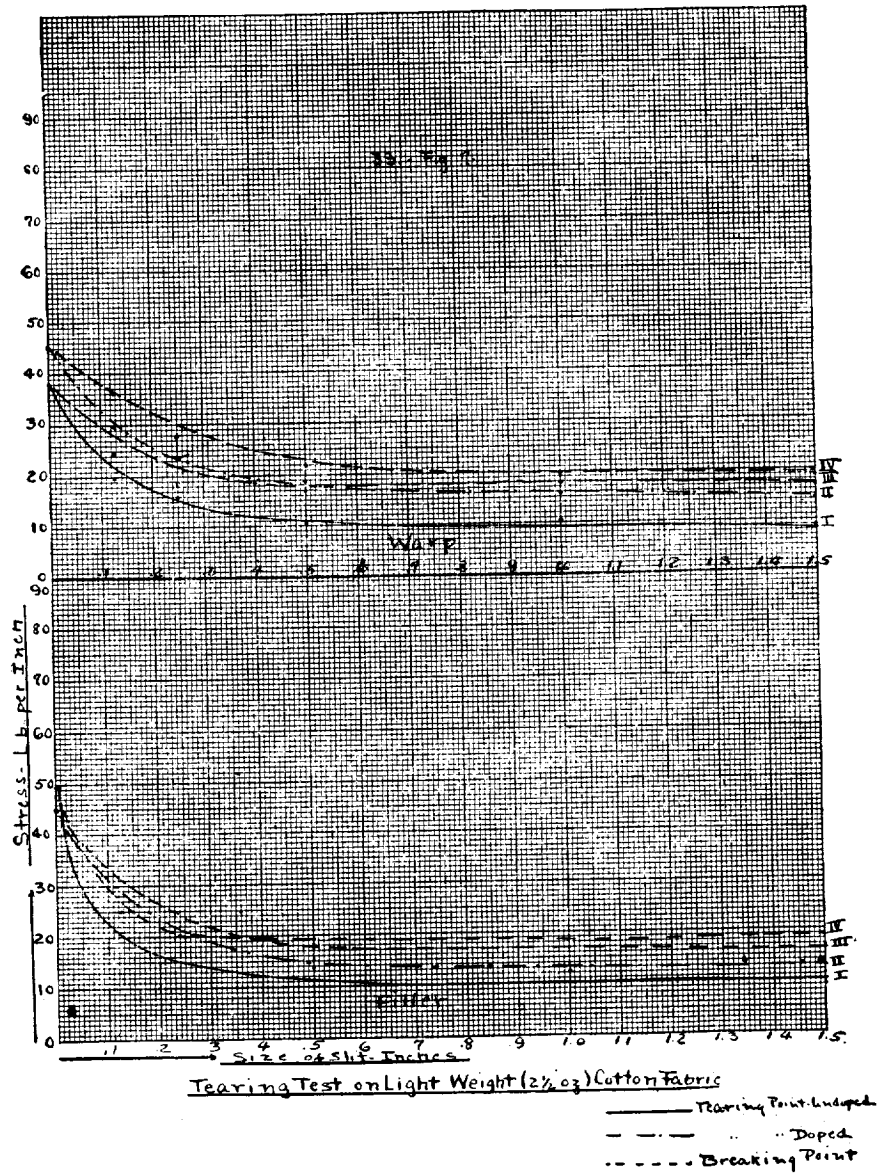

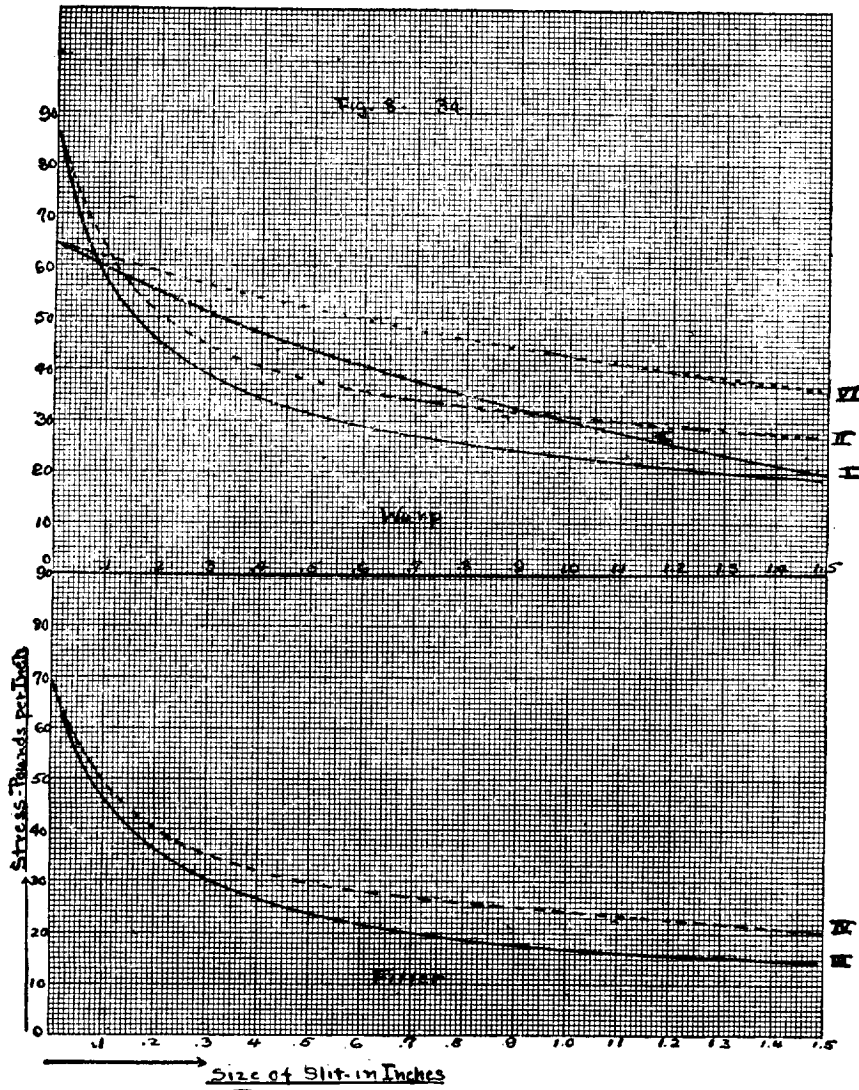

Tearing Tests on Balloon Fabric

- Curves I & III - Tearing points Double parallel balloon fabric. Warp & filler resp.
- " II & IV - Breaking .. " " " " "
- " V & VI - Tearing and Breaking Points. " " Double bias.

COTTON FABRICS.

Sea island or Egyptian cotton, preferably the former, should be used for fabrics intended for use in making balloon fabric. In general the fabrics should be as nearly as possible of the same strength in both directions. Ordinary fabrics intended for clothing are, of course, usually much stronger in the direction of the warp than in the direction of the filling, because the strain comes mostly on the warp, and such fabrics are softer. Another item is, of course, the expense, since the fillers represent a greater manufacturing outlay.

It is difficult to establish any very definite relation between weight and maximum strength attainable, since the methods of manufacture play a very important rôle. A heavy tightly woven fabric may actually test much lower than one apparently not so strong, probably on account of a shearing or grinding action.

The fabrics examined are in general of single-ply yarns, the number of threads varying between 120 and 144 per inch, depending on the weight and strength. The data given represent samples made and tested in this country, and also test published abroad.

	Weight (ounces per square yard).	Strength (pounds per inch).	
		Warp.	Filler.
I	1.60	27.0	26.0
II	1.85	24.3	24.5
III	1.98	31.0	31.0
IV	2.44	41.5	49.0
V	2.67	40.9	49.2
VI	3.51	70.0	67.0
VII	3.86	72.0	75.0
VIII	4.05	84.0	78.0

The curve shows that considerable variation is to be expected, probably to a large extent owing to the great variation in methods of testing. Accordingly, two curves are drawn as limits, with a mean or average value. Any fabric whose tests would place it within the area included by these curves would probably be about as good as could be expected in that grade. This does not mean, of course, that fabrics falling below this area would be unsatisfactory. It simply gives a rough idea of the possibilities under best conditions.

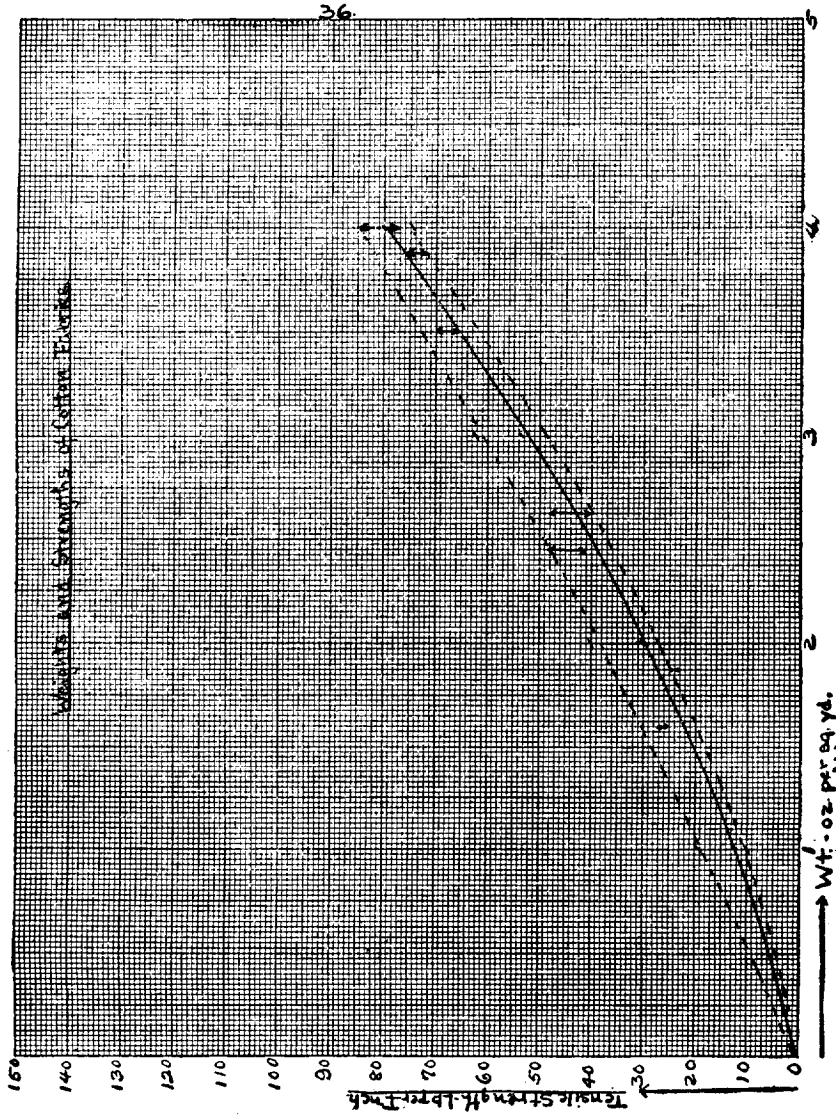

Summary of various tests on aeroplane fabrics.

Fabric.	Weight (ounces per square yard).	Tensile strength (pounds per inch).				Effect of exposure (per cent strength of original.)		Fire test.		Water absorption.		
		Original.		After 3 weeks' exposure.		Warp.	Filler.	Seconds to burn $\frac{1}{2}$ inch.	Distance burned.	In saturated atmosphere.		Loss in weight from soaking.
		Warp.	Filler.	Warp.	Filler.					Per cent.	Per cent.	
1. Linen No. 1 (high grade), varnish, 1875.....	5.18	95	92	62	66.7	65.0	72.5	35.0	Inch.	Per cent.	Per cent.	Per cent.
Linen No. 1 varnish:												
2. 1875, and spar varnish.....	5.88	101	90	75	72	74.2	80.0	33.6		12.99	43.6	3.33
3. 1876.....	5.40	100	88	68	57	68.0	65.0	23		10.01	43.6	5.47
4. 1876, and spar varnish.....	6.18	98	92	71	70	72.8	76.5	22.6		11.49	38.2	3.27
5. 1877.....	5.24	106	91	90	75	84.8	82.5	38.3		13.74	51.9	3.94
6. 1877 and spar varnish.....	6.42	113	83	81	59	71.7	71.2	39.6		12.14	61.9	4.03
7. Cotton (light weight) varnish, 1875.....	3.45	58	68	28	40	48.4	59.3	23.0		8.7	32.4	.84
Cotton varnish:												
8. 1875, and spar varnish.....	4.62	51	59	38	40	74.0	68.0	20.6		6.27	45.0	.75
9. 1876.....	3.43	50	62	21	23	48.5	36.6	9.6		6.42	37.9	.31
10. 1876, and spar varnish.....	4.07	55	63	29	40	49.8	63.2	10.0		5.66	34.5	.79
11. 1877.....	3.24	51	59	44	44	87.2	74.2	22.0		8.03	40.6	.96
12. 1877, and spar varnish.....	4.18	51	53	43	43	85.2	82.0	18.3		7.41	42.1	.71
Linen No. 1, Am. chloride varnish:												
13. 1875, and spar.....	7.16	97	95 $\frac{1}{2}$	52	58.4	53.5	61.0		1.6			
14. 1876, and spar.....	6.90	117	100	79	60.2	67.5	60.2		1.3			
15. 1877, and spar.....	7.57	107	96	58	54	54.2	56.3		1.4			
Linen No. 2 (medium grade) varnish:												
16. 1875.....	4.17	88.8	74.9									
17. 1876, and spar.....	5.50	100	86									
18. 1876.....	4.15	92	79									
19. 1876, and spar.....	5.50	91	77									
20. 1877.....	4.23	78	78									
21. 1877, and spar.....	5.39	91	82									
Linen No. 1 (rubberized) varnish:												
22. 1875.....	7.37	121	104			79.2	75.0			7.73	63.5	4.34
23. 1875, and spar.....	8.44	116	99			89.0	86.0			8.18	39.4	3.27
24. 1876.....	7.63	120	94	96	78	87.5	78.7			8.53	41.3	3.38
25. 1876, and spar.....	8.80	119	96	103	85	94.5	100.0			10.19	38.9	2.82
26. 1877.....	7.57	119	91	105	74	93.2	95.5			8.22	55.3	5.92
27. 1877, and spar.....	8.94	119	97	113	96	96.5	86.7			6.04	39.0	5.23
Linen No. 1 varnish:												
28. 1875.....	5.18	95	92	111	87	69.5	92.3					
29. 1875, and spar.....	5.88	101	90	115	84	90.0	91.0					

NOTE.—Samples Nos. 22 and 29 were exposed 2 weeks to weather; all others, 3 weeks. Varnish, 1876—cellulose nitrate; varnishes, 1875 and 1877—cellulose acetate.

PERMEABILITY TESTS.

As already stated in the main body of the report, the method used was similar to that of the National Physical Laboratory of Great Britain, in which the hydrogen diffusing through the fabric is burned to water and weighed.

Owing to the limited time at our disposal, the tests were each two hours in length. Several tests were made on each sample at each temperature, and ordinarily agreed within a few per cent, when the slight temperature differences were allowed for. (To save time the thermostat was not run always at the same temperature, but simply kept constant at one temperature for each run. As the room temperature varied greatly from day to day during the period in which the tests were made, this made the operation of the thermostat more simple, and in addition gave in many cases a further check on the temperature effect.)

The diameter of the cell was 220 millimeters.

The hydrogen was run through one side of the cell at a rapid rate for several hours at the start of an experiment, to insure the expulsion of air. The proper rate for the passage of the air was found by experiment; it was noted that above a certain point, even with increased absorption apparatus, the total weight of water absorbed did not increase, indicating that the hydrogen was swept out practically as soon as it entered the cell. In the interval between tests on the same fabric, the air side was continually swept out, to prevent the accumulation of hydrogen on the air side. For this purpose a three-way stop-cock was introduced, and connections with trap-bottles made so that the furnace and cell could be swept out separately with air. It was found that in some cases the furnace contained small amounts of moisture that had not been all removed during the experiment, so at the expiration of the time by turning the cock the cell was swept out in preparation for the next run, while dry air was drawn from without through the furnace and absorption tubes for 10 to 15 minutes.

Specimen tests are shown.

Permeability tests on various fabrics.

Fabric.	Temperature (° C.).	Permeability (liters per square meter per 24 hours, at 760/0°).
No. 1 balloon fabric, 2-ply parallel (9.25 ounces per square yard):		
1.65 ounces per square yard rubber between plies	21. 2	54. 99
1 ounce per square yard rubber on inside face	22. 07	56. 37
	29. 68	63. 4
	30. 01	65. 3
	40. 08	79. 1
	40. 09	79. 4
No. 2 balloon fabric, 2-ply parallel (10.81 ounces per square yard):		
3.11 ounces per square yard rubber between plies	20. 45	11. 64
1 ounce per square yard rubber on inside face	21. 65	11. 29
	29. 87	16. 8
	30. 71	17. 32
	32. 27	18. 79
	38. 58	24. 25
	39. 19	25. 34
No. 3 balloon fabric, 2-ply parallel (93.2 ounces per square yard):		
5.51 ounces per square yard rubber between plies	20. 04	11. 2
1 ounce per square yard rubber on inside face	20. 23	11. 7
	39. 48	25. 25
	39. 63	25. 55
	40. 14	26. 37
Balloon cloth No. 3, 4 coats varnish No. 1876 on cloth (about 2 ounces per square yard).....	21. 42	10. 86
	21. 91	11. 8
	22. 00	11. 34
	29. 99	15. 44
	31. 68	17. 11
	40. 51	24. 73
	40. 75	25. 25
Balloon cloth No. 3, 4 coats varnish No. 1877 on cloth (about 2 ounces per square yard).....	20. 81	11. 18
	20. 85	11. 34
	21. 28	11. 5
	30. 51	16. 90
	30. 57	17. 15
	39. 09	24. 13
	39. 74	24. 22
Balloon cloth No. 3, gelatin compound on rubber (2 ounces per square yard)....	20. 2	1. 4
	20. 01	. 8
	21. 29	1. 4
	38. 91	5. 6
	38. 95	6. 6
Balloon fabric No. 3, varnish No. 1876 (2 ounces per square yard), on rubber	20. 02	4. 5
	20. 22	5. 0
	20. 46	5. 6
	38. 96	10. 2
	39. 24	11. 2

Permeability tests on various fabrics—Continued.

Fabric.	Temperature (° C.).	Permeability (liters per square meter per 24 hours, at 760/0°).
Balloon cloth No. 3, varnish No. 1877 (2 ounces per square yard), on rubber	19.91	4.55
	20.25	4.15
	37.45	10.85
	38.90	11.35
Balloon cloth No. 19 (12 ounces per square yard)	38.96	12.7
	20.3	11.2
	21.1	11.37

(1) It will be noted that gelatin compound gives very low permeability. The use of gelatin on fabric for balloons was suggested by Julhe.¹ Austerweil tried this and found² that at first there was practically no loss in volume, even a slight gain due to gases dissolved in the water. After 35 hours the membrane was apparently saturated and lost gas at practically the same rate as the comparison rubber membrane. On the other hand, although each of our tests was only two hours long, the total time in which the cell was filled with hydrogen, and the gelatin-rubber fabric in place, was 48 hours, yet at the end of that time, when the tests were made at 40° C., the permeability was only one-fourth that of the rubberized fabric alone. It is possible that in contact with dry rubber and dry gases, as in our apparatus, the membrane might act differently.

(2) Another point of interest is the test on fabrics 2 and 3 compared with fabric 19. The first two were experimental samples, and for convenience made parallel. The fabric 19 was bias, yet showed practically no difference in permeability. There has been some indication in tests made at the National Physical Laboratory that parallel fabrics were much more permeable. They state that probably the method of manufacture has a considerable effect. This has not been noticed in our tests, and the reason for any such difference is not apparent.

(3) *Temperature coefficient.*—This varies with the temperature and degree of permeability of the material. From our experiments we found the following values:

	Rate of increase at—		
	10–20° C.	20–30° C.	30–40° C.
Rubber fabric, permeability at 15° C.	<i>Per cent.</i> 4.4	<i>Per cent.</i> 4.6	<i>Per cent.</i> 4
Rubber fabric coated with 2-ounce gelatin on rubber.....	<i>Per cent.</i> 1.3	<i>Per cent.</i> 1.3	<i>Per cent.</i> 3.4

(4) *Effect of Weathering.*—On account of the limited time at our disposal for making this investigation, long weathering tests on these samples were not made. Aging by continuous exposure for one month caused no increase in permeability; in fact, one of our samples seemed improved. The rubber layers were apparently unaffected, so this improvement was not due to resinification which has been noted in England, but was more likely due to a slight variation in samples.

¹ C. R. Acad. Sc., 1912, Feb. 12.² Die Angewandte Chemie in der Luftfahrt, p. 90.

Surface friction of aeronautic fabrics at different wind velocities.

Condition and area (square feet).		Experiment No. 1.					Experiment No. 2.				
		Plate glass.					Linen No. 1, 1 coat varnish, 1876 (area, 50.36).				
Miles per hour.	Net correction, pound.	Gross force, pounds.	Net force, pounds.	Net force, pound, square foot.	Net excess.	Resistance factor.	Gross force, pounds.	Net force, pounds.	Net force, pound, square foot.	Net excess.	Resistance factor.
30	0.020	0.384	0.464	0.0079	0	0	0.408	0.428	0.0085	0.0006	1.081
40	.031	.637	.668	.0131679	.710	.0141	.0010	1.080
50	.046	.969	1.015	.0199	1.046	1.092	.0218	.0019	1.098
60	.071	1.342	1.413	.0276	1.480	1.551	.0309	.0023	1.118
70	.094	1.768	1.862	.0364	2.040	2.134	.0424	.0050	1.162
Condition and area (square feet).		Experiment No. 3.					Experiment No. 4.				
		Linen No. 1, 3 coats varnish, 1876 (area, 50.35).					Linen No. 1, 3 coats varnish, 1876; 1 coat spar varnish (area, 50.35).				
Miles per hour.	Net correction, pound.	Gross force, pounds.	Net force, pounds.	Net force, pound, square foot.	Net excess.	Resistance factor.	Gross force, pounds.	Net force, pounds.	Net force, pound, square foot.	Net excess.	Resistance factor.
30	0.020	0.394	0.414	0.00822	0.0003	1.042	0.389	0.409	0.0081	0.0002	1.031
40	.031	.665	.696	.0138	.0007	1.060	.649	.680	.0135	.0004	1.034
50	.046	.938	1.044	.0208	.0009	1.048	.981	1.027	.0204	.0005	1.028
60	.071	1.410	1.481	.0295	.0019	1.067	1.376	1.447	.0287	.0011	1.038
70	.094	1.919	2.013	.0403	.0039	1.108	1.854	1.948	.0387	.0023	1.061
Condition and area (square feet).		Experiment No. 5.					Experiment No. 6.				
		Linen No. 1, uncoated (area, 50.18).					Linen No. 1, 3 coats varnish, 1877 (area, 50.18).				
Miles per hour.	Net correction, pound.	Gross force, pounds.	Net force, pounds.	Net force, pound, square foot.	Net excess.	Resistance factor.	Gross force, pounds.	Net force, pounds.	Net force, pound, square foot.	Net excess.	Resistance factor.
30	0.020	0.457	0.477	0.0095	0.0016	1.205	0.390	0.410	0.0082	0.0003	1.034
40	.031	.778	.810	.0161	.0030	1.234	.652	.683	.0136	.0005	1.040
50	.046	1.204	1.250	.0249	.0050	1.254	.988	1.034	.0206	.0007	1.039
60	.071	1.738	1.809	.0361	.0085	1.305	1.392	1.463	.0292	.0016	1.056
70	.094	2.395	2.489	.0496	.0132	1.362	1.880	1.984	.0395	.0031	1.085
Condition and area (square feet).		Experiment No. 7.					Experiment No. 8.				
		Linen No. 1, 3 coats varnish, 1877; 1 coat spar varnish (area, 50.18).					Linen No. 1, 3 coats varnish, 1877; 2 coats spar varnish (area, 50.18).				
Miles per hour.	Net correction, pound.	Gross force, pounds.	Net force, pounds.	Net force, pound, square foot.	Net excess.	Resistance factor.	Gross force, pounds.	Net force, pounds.	Net force, pound, square foot.	Net excess.	Resistance factor.
30	0.020	0.393	0.413	0.0082	0.0003	1.044	0.393	0.413	0.0082	0.0003	1.044
40	.031	.655	.686	.0137	.0006	1.049	.644	.675	.0134	.0003	1.026
50	.046	.977	1.023	.0204	.0005	1.028	.978	1.024	.0204	.0005	1.028
60	.071	1.384	1.455	.0288	.0012	1.041	1.367	1.438	.0286	.0010	1.033
70	.094	1.884	1.978	.0394	.0030	1.081	1.874	1.968	.0392	.0028	1.078

Surface friction of aeronautic fabrics at different wind velocities—Continued.

Condition and area (square feet).		Experiment No. 9.					Experiment No. 10.				
		Balloon fabric No. 3, double par. cloth outside (area, 49.6).					Balloon fabric No. 3 (same as 9), freshly singed (area, 49.6).				
Miles per hour.	Net correction, pound.	Gross force, pounds.	Net force, pounds.	Net force, pound, square foot.	Net excess.	Resistance factor.	Gross force, pounds.	Net force, pounds.	Net force, pound, square foot.	Net excess.	Resistance factor.
30	0.020	0.672	0.692	0.0139	0.0060	1.766	0.493	0.513	0.0103	0.0024	1.311
40	.031	1.149	1.190	.0238	.0107	1.822	.883	.914	.0184	.0053	1.408
50	.046	1.764	1.810	.0365	.0166	1.838	1.403	1.449	.0292	.0093	1.470
60	.071	2.501	2.573	.0513	.0242	1.873	2.041	2.112	.0426	.0150	1.539
70	.094	3.452	3.546	.0715	.0351	1.965	2.898	2.992	.0603	.0239	1.654
Condition and area (square feet).		Experiment No. 11.					Experiment No. 12.				
		Balloon fabric No. 3 (same as 10); 1 coat varnish, 1876 (area, 49.6).					Balloon fabric No. 3 (same as 10); 3 coats varnish, 1876 (area, 49.6).				
Miles per hour.	Net correction, pound.	Gross force, pounds.	Net force, pounds.	Net force, pound, square foot.	Net excess.	Resistance factor.	Gross force, pounds.	Net force, pounds.	Net force, pound, square foot.	Net excess.	Resistance factor.
30	0.020	0.446	0.466	0.0094	0.0015	1.190	0.394	0.414	0.0083	0.0004	1.036
40	.031	.783	.814	.0164	.0033	1.253	.661	.692	.0139	.0008	1.063
50	.046	1.199	1.245	.0251	.0052	1.264	1.009	1.055	.0213	.0014	1.072
60	.071	1.722	1.793	.0362	.0086	1.309	1.419	1.490	.0300	.0024	1.082
70	.094	2.332	2.426	.0490	.0129	1.345	1.904	1.998	.0403	.0039	1.107
Condition and area (square feet).		Experiment No. 13.					Experiment No. 14.				
		Balloon fabric No. 3, bias (area, 48.88).					Balloon fabric No. 3, bias, freshly singed (area, 48.88).				
Miles per hour.	Net correction, pound.	Gross force, pounds.	Net force, pounds.	Net force, pound, square foot.	Net excess.	Resistance factor.	Gross force, pounds.	Net force, pounds.	Net force, pound, square foot.	Net excess.	Resistance factor.
30	0.020	0.631	0.651	0.0133	0.0054	1.691	0.483	0.503	0.0103	0.0024	1.308
40	.031	1.078	1.109	.0227	.0096	1.739	.864	.895	.0183	.0052	1.402
50	.046	1.632	1.678	.0343	.0144	1.728	1.461	1.507	.0309	.0110	1.555
60	.071	2.343	2.414	.0494	.0218	1.782	2.157	2.228	.0457	.0181	1.651
70	.094	3.294	3.388	.0694	.0330	1.902	3.043	3.137	.0642	.0278	1.762
Condition and area (square feet).		Experiment No. 15.					Experiment No. 16.				
		Balloon fabric No. 6, double bias, special fabric (area, 49.34).					Balloon fabric No. 6, double bias, special fabric, freshly singed (area, 49.34).				
Miles per hour.	Net correction, pound.	Gross force, pounds.	Net force, pounds.	Net force, pound, square foot.	Net excess.	Resistance factor.	Gross force, pounds.	Net force, pounds.	Net force, pound, square foot.	Net excess.	Resistance factor.
30	0.020	0.468	0.488	0.0099	0.0020	1.252	0.423	0.443	0.0099	0.0020	1.139
40	.031	.858	.889	.0180	.0049	1.378	.744	.775	.0157	.0026	1.202
50	.046	1.343	1.389	.0281	.0082	1.414	1.170	1.216	.0247	.0048	1.243
60	.071	1.959	2.030	.0412	.0136	1.490	1.744	1.815	.0368	.0092	1.331
70	.094	2.648	2.742	.0556	.0202	1.528	2.378	2.472	.0500	.0136	1.372

Surface friction of aeronautic fabrics at different wind velocities--Continued.

Condition and area (square feet).		Experiment No. 21.					Experiment No. 22.				
		Aeroplane fabric, rubberized, No. 23 (area, 48.8).					Aeroplane fabric, aluminum coated, No. 24 (area, 48.6).				
Miles per hour.	Net correction, pound.	Gross force, pounds.	Net force, pounds.	Net force, pound/square foot.	Net excess.	Resistance factor.	Gross force, pounds.	Net force, pounds.	Net force, pound/square foot.	Net excess.	Resistance factor.
30	0.020	0.382	0.412	0.0084	0.0005	1.070	0.394	0.414	0.0085	0.0006	1.078
40	.031	.653	.690	.0142	.0011	1.082	.657	.688	.0142	.0011	1.083
50	.046	1.004	1.050	.0215	.0016	1.083	.988	1.034	.0213	.0014	1.073
60	.081	1.379	1.400	.0299	.0023	1.081	1.375	1.456	.0299	.0023	1.081
70	.094	1.824	1.918	.0393	.0029	1.079	1.856	1.950	.0401	.0037	1.101

SURFACE FRICTION TESTS.

In the next to the last column of each experiment, pages 43-4, are given under the heading "Net excess" the numerical difference between the resistance in pounds per square foot of the material, and the resistance of plate glass. In the last column are given factors obtained by dividing the resistance of the material by that of glass at the same velocity.

In general the resistance of an object to the wind increases with the square of the velocity. The general form is, for unit area:

$$P = K V^2.$$

When P = pressure.

V = velocity.

K = a constant.

It has been found by Froude and others that surface friction varies with about the 1.87 power of the velocity.

Plotting the logarithms of the velocity against the pressure, we obtained from our results, in practically all cases, a straight line. The values at 70 miles per hour were a little off in most cases, indicating the pressure of another factor, possibly due to temperature.

The logarithms were plotted and from the values of the faired curves, the approximate exponents and coefficients were obtained algebraically for some of the most interesting cases.

$$\text{General equation } P = K V^n.$$

When P = pressure in pounds per square foot.

V = velocity in miles per hour.

n and K = constants.

	K	N
Experiment 1. Plate glass	0.0000178	1.84
Experiment 2. Linen No. 1, varnish No. 18760000156	1.85
Experiment 5. Linen No. 1, uncoated0000137	1.92
Experiment 9. Balloon fabric No. 30000192	1.93

It will be noted that in general the rougher materials have higher exponents, approaching 2 in the case of balloon fabric.

Absorption tests, balloon and aeroplane fabrics.

Fabric.	Atmospheric weight.	Dry weight.	Moist weight.	Normal moisture.		Moisture after saturated atmosphere.		Atmospheric weight.	Dry weight.	Wet weight.	Dry weight after soaking.	Normal moisture.		Water held in fabric after soaking.		Weight of material removed by soaking.	
				Ounces.	Per cent.	Ounces.	Per cent.					Ounces.	Per cent.	Ounces.	Per cent.	Ounces.	Per cent.
High-grade linen No. 1, untreated, weight 4.6 ounces:																	
Varnish 1875 (cell. acetate).....	5.52	5.18	5.85	0.34	6.56	0.67	12.94	5.65	5.30	7.34	5.09	0.35	6.61	2.25	44.2	0.71	3.96
Varnish 1875 and spar varnish.....	6.26	5.88	6.57	.38	6.46	.69	12.90	6.09	3.71	7.93	5.52	.38	6.65	2.41	43.6	.19	3.33
Varnish 1876 (cell. nitrate).....	5.71	5.49	6.04	.22	4.02	.55	10.01	5.71	3.49	7.45	5.19	.22	4.02	2.26	38.6	.30	3.77
Varnish 1876 and spar varnish.....	6.34	6.18	6.80	.36	5.83	.71	11.49	6.46	6.11	8.17	5.91	.33	4.24	2.26	38.2	.20	3.94
Varnish 1877 (cell. acetate).....	5.61	5.24	5.96	.37	7.07	.72	13.74	5.72	3.34	7.79	5.13	.38	7.13	2.66	51.3	.21	3.77
Varnish 1877 and spar varnish.....	6.87	6.42	7.20	.45	7.01	.78	12.11	6.04	6.20	9.57	5.95	.44	3.43	3.72	60.9	.55	4.03
Rubberized (one side).....	6.49	6.27	7.08	.22	3.51	.59	9.41	6.63	6.41	9.88	6.16	.22	3.43	3.72	60.4	.55	3.50
Rubberized, varnish 1875.....	7.63	7.37	8.20	.26	3.53	.57	7.73	7.62	7.36	11.51	7.04	.26	3.53	4.47	63.5	.52	4.34
Rubberized, varnish 1875 and spar varnish.....	8.80	8.44	9.49	.36	4.27	.69	8.18	8.82	8.56	11.54	8.28	.26	3.03	3.26	39.4	.28	3.77
Rubberized, varnish 1876.....	7.85	7.63	8.50	.22	2.89	.65	8.53	7.80	7.69	10.72	7.43	.20	2.61	3.29	44.3	.26	3.58
Rubberized, varnish 1876 and spar varnish.....	9.13	8.89	10.08	.24	2.70	.95	10.69	8.82	8.51	11.49	8.97	.31	3.64	3.92	38.9	.24	2.82
Rubberized, varnish 1877.....	7.83	7.57	8.46	.26	3.43	.63	8.32	7.81	7.60	11.10	7.15	.21	2.76	3.95	55.3	.45	3.92
Rubberized, varnish 1877 and spar varnish.....	9.23	8.94	9.77	.29	3.25	.54	6.04	9.19	8.85	11.69	8.14	.34	3.84	3.28	39.0	.44	5.23
Cotton (light weight):																	
Varnish 1875.....	3.74	3.45	3.75	.29	8.40	.30	8.70	3.89	3.58	4.70	3.55	.31	8.67	1.15	32.4	.03	.84
Varnish 1875 and spar varnish.....	4.86	4.62	4.91	.24	5.19	.29	6.27	4.20	3.99	5.74	3.96	.21	5.97	1.78	45.0	.03	.75
Varnish 1876.....	3.60	3.43	3.65	.17	4.96	.22	6.42	3.68	3.20	4.40	3.19	.16	5.00	1.51	37.0	.01	.71
Varnish 1876 and spar varnish.....	4.23	4.07	4.30	.21	5.16	.22	6.68	3.98	3.79	5.95	3.76	.16	5.02	1.29	34.3	.03	.69
Varnish 1877.....	3.46	3.23	3.50	.22	6.80	.26	5.03	3.35	3.13	4.34	3.10	.22	7.03	1.24	49.0	.03	.66
Varnish 1877 and spar varnish.....	4.47	4.13	4.49	.29	6.94	.51	7.41	4.39	4.29	6.01	4.23	.30	7.00	1.78	42.1	.03	.71
Balloon fabric, cloth outside (1½ ounce double bias), No. 3.....	11.35	10.98	11.62	.37	3.37	.64	5.83	11.35	10.68	14.5237	3.37	3.54	32.3
Balloon fabric No. 3 and balloon fabric No. 3 spot proof.....	11.60	11.20	11.70	.30	2.68	.46	4.07	11.38	11.05	13.9233	3.00	2.87	24.8
Balloon fabric No. 3, proof No. 123.....	12.37	11.96	13.20	.42	3.52	1.23	10.50	12.28	11.89	13.2039	3.28	3.31	27.8

REPORT No. 6.

PART 2.

SKIN FRICTION OF VARIOUS SURFACES IN AIR.

By WILLIS A. GIBBONS.

INTRODUCTION.

The relation of skin friction or surface friction, to the relative velocity of a surface and the surrounding medium, and the variation of this relation with the nature of the surface is of growing importance to the science of aeronautics. Owing to the greater speeds now developed in air craft of all kinds, it was decided to investigate these relations with particular reference to the sort of surfaces which would be used in aeronautic work.

W. Froude¹ measured the resistance for various surfaces of various lengths in a water channel, and the results of his experiments lead to the following conclusions:

1. The force tangential to the plane due to skin friction, ordinarily varies according to the 1.85-2 power of the velocity for smooth surfaces. For rougher surfaces, it varies practically as the square of the velocity.

2. The length of the plane has a decided effect on the average resistance per unit area, the resistance decreasing as the length increases.

3. Smooth surfaces do not necessarily increase according to a lower power of the velocity than *rougher* surfaces, although the numerical value of the resistance per unit area is less.

4. The index decreases as the length increases for smooth surfaces.

Zahm² measured the resistance due to surface friction of planes in a current of air, and found that all smooth surfaces showed an increase in resistance according to the 1.85 power of the velocity. Buckram with 16 threads per inch gave a high resistance and an index of 2.05, practically 2.

He measured the resistance of planes of various lengths and obtained the following equation connecting the length of a plane with its velocity and surface friction:

$$P \propto L^{-.07} V^{1.35} \quad (1)$$

When V = Velocity in feet per second.

L = Length of planes.

p = Tangential force per square foot.

¹ British Assoc. Report, 1872, 118; 1874, 249.

² Phil. Mag., VIII, 58-66 (1904).

Lanchester¹ shows that to express the resistance of a plane bringing into account the linear size and kinematic viscosity, we have the relation—

$$R \propto v^q L^r V^r \quad (2)$$

When $q+r=2$
 v = Kinematic viscosity.
 L = Linear size.
 V = Velocity.

The kinematic viscosity² $v = \frac{\mu}{\rho}$

When μ = Coefficient of viscosity.
 ρ = Density.

The kinematic resistance, $R = \frac{F'}{\rho}$ i. e., it is the resistance per unit density.

Lanchester points out that in terms of R , Zahm's equation (1) becomes

$$R \propto L^{1.93} V^{1.85} \quad (3)$$

whereas according to (2) L and V should have the same index. He adopts the following for a smooth surface.

$$R \propto v^{-1} L^{1.9} V^{1.9} \quad (4)$$

Assuming, what we have found to be the case, that the exponent varies with the nature of the surface, we may put this in the form

$$R \propto v^{2-n} L^n V^n \quad (5)$$

whence

$$F' = \kappa \rho v^{2-n} L^n V^n \quad (6)$$

For any one surface it is convenient to neglect the length, and embody this and the ρ and v values in one constant, so we have.

$$F' = K V^n \quad (7)$$

The value of K depends of course on the units.—throughout this paper F' will be in lbs. per square feet, and V in miles per hour. The value of .1 for air is 1.3 times that for water, so this and the relative densities give a means of calculating from one medium to the other.

The values of n and K vary with the surface even for so-called smooth surfaces, and as will be shown, seem in such cases to bear a more or less definite relation to each other.

¹ Tech. Rept. Adv. Com. for Aeronautics, 1909-10, p. 34.

² Lanchester's Aerodynamics, p. 36.

EXPERIMENTAL.

Through the kindness of the Bureau of Construction and Repair of the Navy Department the excellent facilities afforded by the wind-tunnel of the Washington Navy Yard became available for experiments on the frictional resistance of various surfaces. These experiments were made for the purpose of looking into the matter of surface friction with particular reference to surfaces of the sort which would be of most interest from the standpoint of aeronautics.

A glass plate about 9½ feet long and 34 inches wide was suspended vertically, with its surface tangent to the direction of the wind, by two wires fastened to the upper edge of the plate. The ends of the plate were enclosed in slots in faired struts, which were fixed rigid to the floor and ceiling of the tunnel, and stayed to prevent vibration. Smooth steel rollers attached to each side of the slots, at the upper and lower ends, prevented side movement of the plate. They did not ordinarily touch the latter, being set to allow a clearance of 0.01 inch. Thus the plate was free to move within limits only in the line of the air current.

The trailing edge of the plate was connected by a steel rod to the balance, allowing the horizontal force to be measured.

CORRECTIONS.

It was found by experiment that the ends of the plate, although protected by the struts, were affected by the air current. Tubes were set in the slots and connected with a hook gauge manometer. From the pressure at each end, the force on the plate was measured for different velocities, and by a faired curve, a set of corrections at different velocities was obtained. Both of these corrections are to be added since the air rushing past the slot in which the leading edge fits causes a diminution in pressure, and in the other slot, an increased pressure. Both of these changes in pressure would give a thrust against the wind.

The correction for the wires was found by adding 4 more supporting wires, making 6 in all and measuring the force on the plate with these additional supports, then removing the original wires and measuring the resistance of the plate at different velocities with four wires. Subtraction gave the effect of the two wires, which were used as supports in all regular tests. This correction is of course to be deducted from the observed force. To avoid masking, small wedges were used to hold the added wires away from the glass, the added wire passing around under the lower edge of the plate in each case.

SURFACES.

Plate glass was used as a standard, or ideal surface, since it is probably as smooth as any surface, and can be easily duplicated. The various fabrics were attached to this by a nitrocellulose varnish, by which, with a little practice, we were able to obtain a surface practically smooth, so far as unevennesses from wrinkles, etc., were concerned. The amount of varnish needed was so small and its colloidal nature such that it was possible to attach an uncoated linen to the glass without affecting the outer surface of the fabric appreciably. The linen surface could then be tested, and treated further as desired.

When more than two coats of varnish were applied, the surface was sand-papered between each coat.

Where fabrics were singed between tests, the singeing was done with a blow-torch.

The surfaces tested may be grouped as follows:

1. Plate glass.
2. Fabric surfaces with nap.
3. Fabric surfaces without nap (linen and cotton).
4. Varnished fabrics (cotton and linen).
5. Rubber coated linen (plain and aluminum surface).

The experiments were made at velocities of 30, 40, 50, 60, and 70 miles per hour. Owing to the large size of the plate (area about 50 square feet) the forces were large enough to enable considerable accuracy to be obtained. For example in the case of plate glass, the gross uncorrected force is about 0.27 pound at 30 miles per hour. On this account and also on account of the greater range of velocities we were able to detect variations in apparently smooth surfaces which were not noticeable in earlier experiments at low velocities.

The values of F (pound per square feet) the relative value of F compared with that for glass called for want of a better term, the resistance factor ($R. F.$) and the values of n and K are given in Table I.

TABLE I.—Results of experiments on surface friction, in air, of various surfaces.

[Tests were made in wind-tunnel, Washington, D. C.]

NOTE.— n , k , and F are values in equation $F = KV^n$. $F = \text{lb./sq. ft.}$
 $V = \text{miles per hour.}$
 $R. F. = \text{Resistance factor} = F \text{ observed} / F \text{ glass.}$

No.	Nature of surface exposed.	n .	$K \times 10^7$.	30 miles/hr.		40 miles/hr.		50 miles/hr.		60 miles/hr.		70 miles/hr.	
				F .	$R. F.$	F .	$R. F.$	F .	$R. F.$	F .	$R. F.$	F .	$R. F.$
1	Plate glass.....	1.81	166	.0079	1.000	0.0133	1.000	0.0199	1.000	0.0276	1.000	0.0364	1.000
2	Fine linen:												
	1 coat aero varnish, 1876.....	1.84	163	.0085	1.081	.0141	1.080	.0218	1.098	.0309	1.118	.0424	1.162
3	3 coats aero varnish, 1876.....	1.89	129	.00822	1.042	.0138	1.060	.0208	1.048	.0295	1.067	.0403	1.108
4	3 coats aero varnish, 1876, 1 coat spar varnish.....	1.84	153	.0081	1.031	.0135	1.034	.0204	1.028	.0287	1.038	.0387	1.061
5	Uncoated.....	1.94	128	.0095	1.205	.0161	1.234	.0249	1.254	.0361	1.305	.0496	1.362
6	1 coat varnish, 1877.....	1.85	149	.0082	1.034	.0136	1.040	.0206	1.039	.0292	1.056	.0395	1.085
7	3 coats varnish, 1877.....	1.85	149	.0082	1.044	.0137	1.040	.0204	1.028	.0288	1.041	.0394	1.081
8	3 coats varnish, 1877, 2 coats spar varnish.....	1.84	157	.0082	1.044	.0134	1.026	.0204	1.028	.0286	1.033	.0392	1.078
9	Balloon fabric:												
	No. 3, double parallel, cotton surface.....	1.90	219	.0139	1.766	.0238	1.822	.0365	1.838	.0518	1.873	.0715	1.965
10	No. 3, double parallel, singed.....	2.05	96.5	.0103	1.311	.0184	1.408	.0292	1.470	.0426	1.539	.0603	1.654
11	No. 3, double parallel, 1 coat varnish, 1876.....	1.95	123	.0094	1.190	.0164	1.253	.0251	1.264	.0362	1.309	.0490	1.345
12	No. 3, double parallel, 3 coats varnish, 1876.....	1.85	153	.0083	1.056	.0139	1.063	.0213	1.072	.0300	1.082	.0403	1.107
13	No. 3, bias, cotton surface.....	1.95	207	.0133	1.691	.0227	1.739	.0343	1.728	.0494	1.782	.0694	1.902
15	No. 6, bias, special, cotton surface.....	2.03	99.7	.0099	1.252	.0180	1.378	.0281	1.414	.0412	1.490	.0556	1.528
16	No. 6 bias, special, cotton, singed.....	2.05	82.5	.0088	1.127	.0157	1.202	.0247	1.243	.0368	1.331	.0500	1.372
21	Aeroplane fabric:												
	Rubber surface.....	1.83	165	.0084	1.070	.0142	1.082	.0215	1.083	.0299	1.081	.0393	1.079
22	Rubber aluminum surface.....	1.83	166	.0085	1.078	.0142	1.083	.0213	1.073	.0299	1.081	.0401	1.101

RESULTS.

QUALITATIVE.

The great resistance offered by fabrics with nap on the surface will be noted. The effect of the weave is shown by comparison of experi-

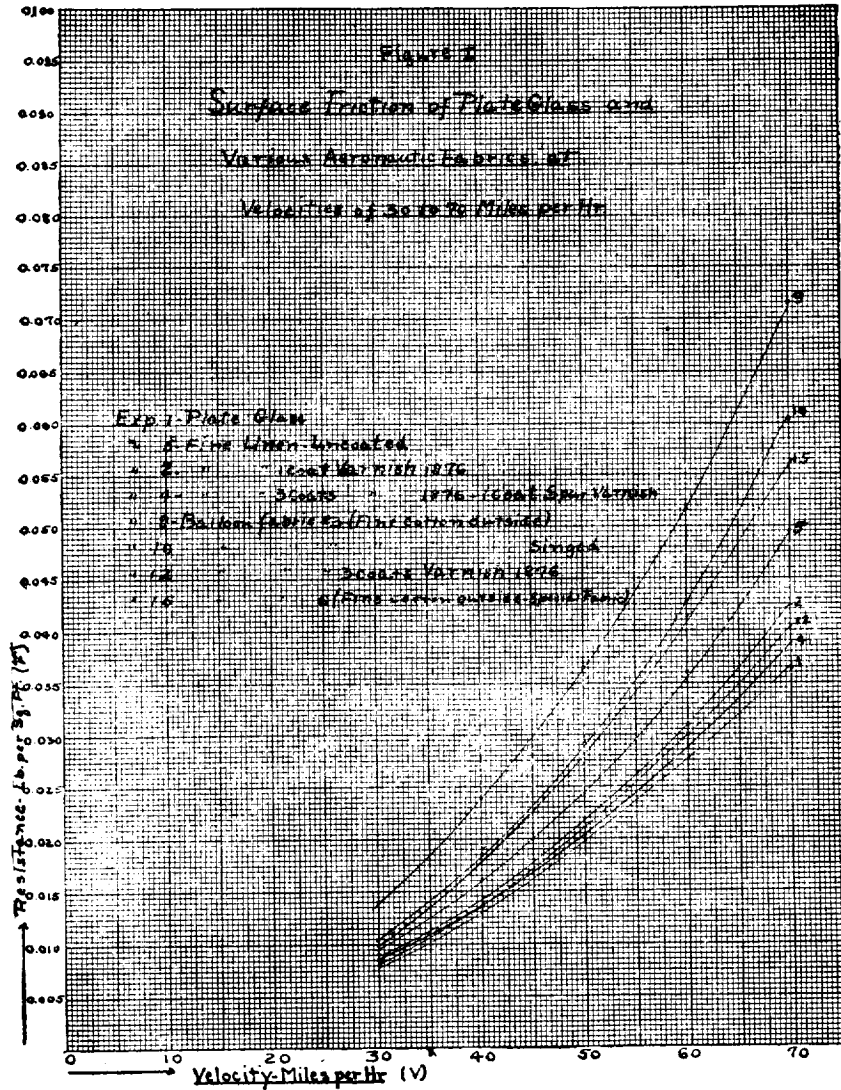

ments 9 and 15. Both fabrics are high-grade cotton, but probably that used in experiment 15 is closer woven and made of longer staple. Biasing seems to increase the index, but the effect would probably not be noted except at very high speeds.

Cotton shows a higher resistance than linen, although the cotton surfaces were finer weave than the linen. The linen yarn, while of more varying thickness, is smoother than cotton yarn, due to the nature of the ultimate fiber and its greater length. The linen yarn is more like a wire.

The effect of varnishing is very apparent, although no conclusion can be drawn as to the relative merits of various aeronautic varnishes. Probably it is more a matter of workmanship in applying and finishing the coat than any particular merit in the varnish itself. The use of a finishing coat of spar varnish gives some improvement.

The use of a varnish seems particularly advantageous in the case of cotton fabrics. This explains the good results obtained in Europe by varnishing the gas bags of dirigibles with cellulose acetate varnish, which both improves the gas-holding properties of the bag and decreases the frictional resistance. In a well-designed balloon most of the resistance offered by the air to the motion of the balloon is due to friction.

QUANTITATIVE.

If we plot the logarithms of the velocity (V) and frictional resistance in pounds per square foot (F') we obtain practically straight lines. From their slope we find the index n . Figure II shows the logarithmic plots for the most interesting cases. It will be noted that in many cases the value for 70 miles per hour seems to lie above the line, possibly indicating an increase in the index as velocity increases, due to greater turbulence. This has been predicted.

Using the slope obtained by logarithmic plots and F' = pounds per square foot, V = miles per hour, we may obtain the constant K , as given in Table I.

From these results it will be noted that the smooth surfaces do not necessarily have lower indices. When this was first noted it seemed so anomalous that it was thought at first that there might be some experimental error. However, we note that Froude found a similar result (Table III) in the case of tin foil, varnish, and paraffin.

The high resistance of fabrics having nap on the surface is noteworthy.

Froude's results obtained with an 8-foot plane in a water channel were reduced to the same units, and to air conditions. The values are given in Table II. Considering the differences in conditions the agreement for smooth surfaces is close. The resistance of calico was somewhat higher than the cloth resistance found in our tests. From the photograph accompanying Froude's paper¹ the fabric used by him probably had about 80 threads per inch. Those used by us had about 120 threads per inch, and on this account presumably a smoother surface.

VALUES OF K AND N .

As already noted, smooth surfaces may show a higher index than rougher ones, while the coefficients K vary in the opposite direction. To obtain an idea as to the relative values of these two quantities, we plotted the values of K and N as shown in Figure III. It will be

¹ Brit. Assoc. Report, 1874, p. 246.

noted that the results of our experiments seem to show two distinct types of surface:

1. Those having nap on the surface have high indices and high exponents. They act somewhat similarly to calico and sand-coated surfaces investigated by Froude, and may be classed as rough,

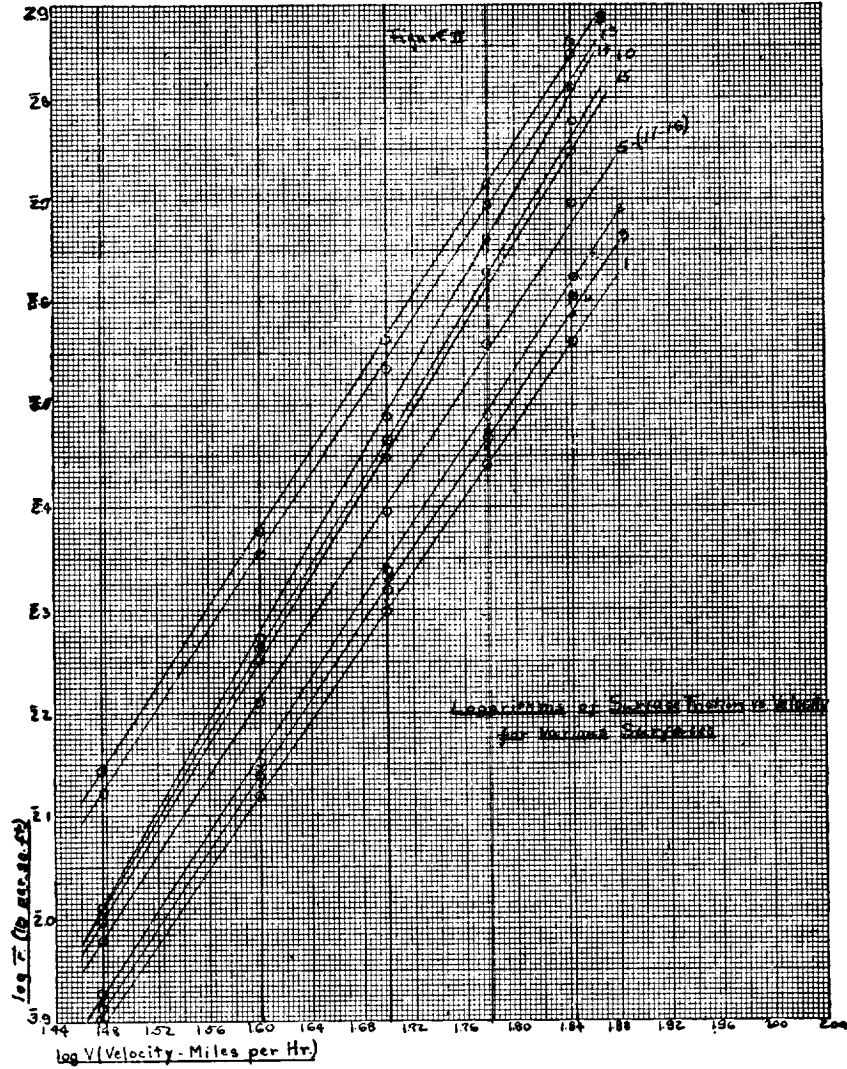

relatively. The index is 1.9 to 2, usually nearer 2, and the coefficient K , 0.00002 or more. (V in miles per hour.)

2. Surfaces which are free from nap, and more or less continuous and even. Fabric surfaces of fine threads closely woven and free from nap (due to singeing or natural great length of fiber, as linen)

are the roughest of this class. At the other extreme we have coated and varnished fabrics, which may approach glass in smoothness under good conditions.

Considering the nature of the quantities n and K , the points for smooth surfaces lie remarkably close to a straight line, the deviation

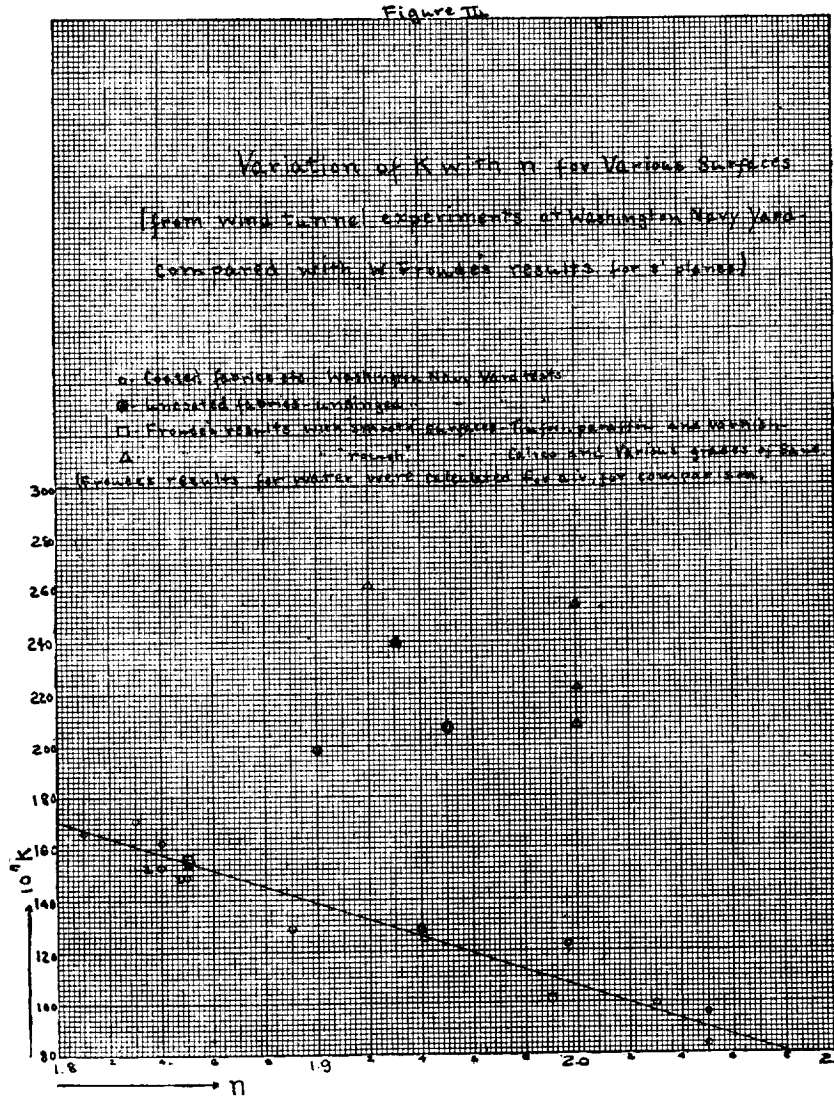

amounting to not more than 6 to 8 per cent, except in two cases, and these fall on opposite sides of the line (Fig. III).

The values found by Froude for varnishes, tin foil and paraffin for an 8-foot plane in water are also shown (Table II), and fall close to the line. On the other hand, "rough" surfaces, calico and roughened sand, do not come near the line.

TABLE II.—Results of Froude's experiments, calculated to air.

[8-foot plane (600 feet per minute) K in terms of miles per hour.

Surface.	n .	$K.10^2$.
Varnish.....	1.85	156
Paraffin.....	1.94	126
Tin foil.....	1.99	101
Calico.....	1.92	261
Fine sand.....	2.00	209
Medium sand.....	2.00	223
Coarse sand.....	2.00	255

From these figures we may express the relation of n and K for "smooth" surfaces by the empirical equation—

$$K = .0000746 - .000032n \quad (8)$$

whence

$$F = (.0000746 - .000032n) V^n \quad (9)$$

F being in pounds per square foot and V in miles per hour. While this expression is purely empirical, in view of our results it would seem as if it might be possible, within limits, to evaluate the complete equation for a smooth plane of fixed size, from the results of one experiment. To apply this rigidly would of course mean that the curves for smooth surfaces must not cross, i. e., that one given value of F and V applies to one curve only. While our results do not adhere strictly to this the deviations occur generally in the case of curves which are so close together as to almost overlap, and are probably due to experimental error. The value of K depends on L , but this can be figured as already shown.

On the other hand, Froude's results indicate that in the case of water, there is a fall in the index as the length of the plane increases. This change seems to be in the opposite sense to what would be expected. The equation

$$R \propto v^9 L^r V^r \quad (2)$$

shows that L and V vary according to the same power in every case. We should expect from this the same change in r , whether due to change in L or V . It is known, and our own experiments indicate that increase in V tends to increase r ; in other words, at high speeds, the resistance would vary according to a higher power of length and velocity. It seems logical to assume that this interchangeability of V and L would give a similar result as L increases, namely, that r would also increase, for both L and V . These changes in index would probably be so small for ordinary experimental differences as to be negligible.

REPORT No. 7.
IN TWO PARTS.

**THERMODYNAMIC EFFICIENCY OF PRESENT TYPES
OF INTERNAL COMBUSTION ENGINES
FOR AIRCRAFT.**

BY COLUMBIA UNIVERSITY.

**Part I.—REVIEW OF THE DEVELOPMENT OF ENGINES SUITABLE FOR
AERONAUTIC SERVICE.**

**Part II.—AERO ENGINES ANALYZED WITH REFERENCE TO ELEMENTS
OF PROCESS OR FUNCTION.**

By CHARLES E. LUCKE,
Professor of Mechanical Engineering, Columbia University.

CONTENTS OF REPORT No. 7.

	Page.
PART 1. —Review of the development of engines suitable for aeronautic service; origin, means used, and results.....	189
(a) Service requirements for aeronautic engines—power versus weight, reliability, and adaptability factors.....	189
(b) Means employed up to the present to promote aero-engine development, including possible means not employed (reference to Appendixes 1, 2, 3).....	196
(c) General characteristics of present aero engines: Power; speed; engine; radiator; water; gasoline and oil tank; weights; fuel and oil consumption; aggregate power plant weights with full tanks for given length of run; engine types (reference to Appendixes 1, 2, and 4)....	201
PART 2. —Aero engines analyzed with reference to the elements of function, form, proportion, and material, and their bearing on the power-weight ratio, reliability, and adaptability factors.....	219
(a) Aero engine processes and functions of parts versus power-weight ratio, reliability, and adaptability.....	263
(b) General arrangement, form, proportions, and materials of aero engine parts, versus power-weight ratio, reliability, and adaptability.....	301
(c) Conclusions and recommendations.....	301
PART 3. —Appendix. (Omitted. See note, page 187.)	
1. European aeronautic engine contests, conditions, entry test data and conclusions.	
(a) Governmental, German, French, British.	
(b) Private or institutional.	
2. European aeronautic engine laboratories—Other aeronautic laboratories.	
3. Bibliography of aeronautic engines with reproduction of a selected list of papers.	
4. Existing aeronautic engines by name, sizes, illustration, and general description.	

PREFACE.

In the preparation of this report, for which the time available was limited to a little less than three months, all the literature on aero engines that could be obtained in the libraries of New York City, or that could be secured by loan or purchase, has been consulted. Where valuable material was found in foreign languages, translations from the original have been made and in many cases whole papers or illustrations that seemed worthy of reproduction have been photographed for insertion. The report is divided into three parts, as indicated in the contents, and at the end of the second part the conclusions and recommendations will be found. The third part includes four appendixes consisting of reproductions of various valuable material referred to in the text, but separately presented so as not to break the continuity of thought and argument. In the very considerable labor involved in collection, translation, and digestion of the material, my colleague, Prof. F. O. Willhöft, has rendered most valuable service, which is gratefully acknowledged.

CHARLES E. LUCKE.

NOTE.—The third part referred to herein contains so much matter that has appeared in published form and so much is in such form as to practically prohibit satisfactory reproduction of essential illustrative matter that the committee has determined to present only parts one and two. Part three is in possession of the committee and may be inspected.

H. C. RICHARDSON, U. S. N., *Secretary.*

REPORT No. 7.

PART 1.

REVIEW OF THE DEVELOPMENT OF ENGINES SUITABLE FOR AERONAUTIC SERVICE—ORIGIN, MEANS USED, AND RESULTS.

By CHARLES E. LUCKE.

Part 1 (a).—SERVICE REQUIREMENTS FOR AERONAUTIC ENGINES—POWER VERSUS WEIGHT, RELIABILITY, AND ADAPTABILITY FACTORS.

Transportation over land and water has been revolutionized by the addition of engine motive power to vehicles and boats to a degree that requires no study to appreciate but the contribution of the portable power plant to aerial navigation is even greater. It is fundamentally creative, for without the aeronautic engine air flight would be quite impossible. Not only does an engine constitute the essential element of the air craft, but the engine must be suitable for the purpose; it must have certain characteristics never before required or produced by engine designers. Success in flight and improvements in flying machines rests absolutely upon the success with which the engine and its accessories that make up the portable power plant can be made to fulfill the new requirements peculiar to the flying machine. Before someone flew, no one could specify just what the aeronautic motor should be able to do, except that, of course, it should be as light as possible and not stop in the air. Nor was there any demand for such an engine that would serve as an inducement to engineers familiar with engine production to build one. In short, while those few experimenters who were engaged in trials of balloons and gliding planes felt they might be helped if they could secure a proper light motor, no one felt sure it would be of service if produced, and of course no one could say how light it should be, or what other characteristics should be incorporated, except that of reliable continuous running during a flight. Formulation of some of these specifications may be said to date from about the years 1901-2, when the Wrights, on the one hand, and Langley, on the other, found that existing engines developed for other classes of service were unsuitable, the nearest approach being the automobile engine, then pretty uncertain in operation and weighing about 15 pounds per horsepower in the lightest forms—a weight that would not serve even if the operator were willing to risk his life on the possibility of engine stoppage in flight. It was apparent at once that redesign for reduced weight per horsepower was necessary, and the Wrights proceeded to rebuild the automobile engine, while Manly boldly departed from any existing

practice and built his five fixed radial cylinder engine, both Manly and Wrights retaining the water cooling of the most successful automobile engines. Both succeeded in reducing weight enough to make flight possible, the Wright engine producing a horsepower with about 7 pounds and the Manly with about 2.4 pounds of engine weight, the former with a 12-horsepower, and the latter with a 50-horsepower engine.

Thus was flight initiated with engine redesign for weight reduction, and so has flight improved in range, speed, and safety, with further redesign of engine in the 13 or 14 years that have elapsed since that time, but the end is not yet in sight. The progress that has been made in engine construction, principally in Europe, is truly amazing, in view of the unique character of the problem and the short time that has elapsed; but all this has only served to increase the demand of the aeronautic engineer on the engine designer and manufacturer, so clearly and firmly is the principle established, that progress in flying rests fundamentally on engine improvement. These years of experience, however, have resulted in some data, derived largely from laboratory tests on the characteristics of the engines that are most successful in flight, and in some more or less accepted formulations of the sort of service required of aero engines and their essential parts in addition to weight, speeds, power, and general reliability, that might be classified as adaptability factors.

Any engine, for whatever service, must be suitable, and its design must be based as much on the specifications for suitability involving these adaptability factors, as on the fundamental principles of thermodynamics, stress resistance and the properties of the materials available, and these adaptability factors must be derived from the users or operators of the machines before the engine designer can interpret them, preparatory to the incorporation into the engine proper of those structural elements that will make it suitable. At the present time there are available some conclusions along this line of experience, a few of which will be quoted and summarized before undertaking to analyze the engine structure proper.

After nine years' use of engine-driven aeroplanes the engine structure was summed up in 1912 by Capt. H. B. Wild, Paris, as from his own experience as follows:

The comparatively crude and unreliable motor that we have at our disposal at the present time is no doubt the cause of many of the fatalities and accidents befalling the aeroplane. If one will look over the accessories attached to the aero engine of to-day, it will be noted that it is stripped clean of everything possible which would add head resistance or weight. The designer of the aero engine is too anxious to eliminate what he deems unnecessary parts in order to reduce the weight of the engine, and in doing so he often takes away the parts which help to strengthen the durability and reliability of the motor.

Few engine designers seem to appreciate the importance of eliminating the least tendency toward variation of angular velocity or in the torque, if the engine is required to drive a propeller. The effect of continually accelerating and retarding a propeller is most detrimental to its efficiency. * * * In front elevation an aero engine should be as compact as possible, so as to reduce head resistance.

Additional specific requirements named include—

(a) oil tank of six hours' capacity with reliable pump for forced feed lubrication, internal oil pipes, (b) standardized propeller hub and crank shaft end, (c) heater for carburetors and gravity feed of gasoline, (d) dual ignition and no loose wires, (e) exhaust silencer, (f) exhaust valve lifters for stopping and compression release for starting, (g) engine speed indicator, (h) cool valve seats. * * * Engine builders

generally would also do well to visit aviation grounds more frequently and to take more interest in the engines which have left their hands, * * * though in many cases the aviator does not leave the engine alone when it is working right, but tinkers with the different adjustments until they are all out of harmony with one another and places the blame where it does not belong. * * * The demand for a reliable motor is still prominent.

Writing in 1912, Awsbert Vorreiter, Berlin, gives the principal requirements which aviation engines have to meet, as—

First. Small weight referred to horsepower.

Second. Small consumption of fuel, water, and oil, so as to obtain the maximum possible radius of action with a given quantity.

Third. Absolute reliability since in the case of the dirigible engine hardly any—in the aeroplane engine absolutely no—repairs can be made during a flight.

In the demand for low weight per horsepower the requirement of the low fuel and oil consumption per horsepower-hour are included, since to-day it is no longer a question of getting a machine to fly for a short time only, but to construct flying machines for practical purposes, we have to figure on a running time of several hours. It may easily be shown by calculation that an engine very light compared with output, but requiring an excessive amount of fuel and oil, may weigh more per horsepower when the weight of fuel and oil are included than a heavy engine with low fuel and oil consumption. It is true that the oil consumption cuts less of a figure because the quantity of oil as compared with the fuel is small and in a good engine amounts to not more than one-tenth. As a most favorable value for fuel consumption of an aviation motor we may assume 0.536 pound per horsepower-hour, which value has been repeatedly reached in aeroplane engines. In dirigible engines figures as low as 0.514 pound have been obtained.

Hand in hand with the reliability goes the demand for durability and continuous maintenance of high capacity. It is here that older constructions of aviation engines sometimes fall down very badly. Only the continuous output which the engine is able to give is to be seriously considered in an aviation engine as distinct from the automobile engine. While the latter is only very seldom required to give its maximum output—and then only for a short time—the aviation engine almost always runs under full load.

Additional specific requirements mentioned include—

(a) carburetor action and engine performance must be independent of barometer, of temperature, of dust, and of tilting of engine, (b) uniform turning movement, (c) balance of engine parts, (d) high enough energy in rotating parts to produce fly-wheel effect to resist variable propeller resistances and maintain engine speed, (e) propellers give best efficiency at speeds lower than are feasible in engines—in some cases as low as half, (f) proper cooling of engine to insure lubrication, minimum distortion of metal parts, temporary or permanent, (g) locate exhaust discharge away from operator, (h) least weight of engine by designing for maximum feasible speed, maximum work per cubic foot of displacement, and least weight of metal of selected kind and cross section.

In a paper read before the institution of automobile engineers (London) in 1912, Mr. A. Graham Clark summarizes the qualities regarded as essential or desirable in an aeronautical engine, as follows:

(1) Reliability: Failure of the engine necessitates the immediate descent of the machine, if of the heavier-than-air type, which, should it occur at an inopportune moment, may be attended with disastrous consequences.

(2) High power weight ratio:

(3) Economy in fuel and oil:

Are desirable because of the increased radius of action.

(4) Low air resistance: The importance of air resistance becomes more marked with increase in the speed, as the power absorbed in this direction varies as the cube of the velocity. It may be remarked in this connection that the horsepower required to propel a flat plate 3 feet in diameter through the air is increased from about 6 to over 16 by increasing the relative velocity of the plate to the air from 50 to 70 miles per hour.

(5) Controllability or flexibility, although there is not the same need for it as with engines employed on automobiles, is none the less a desirable quality since at low

speeds of rotation the propulsive or tractive effort of the propeller is insufficient to move the machine along the ground, and hence the pilot will be able to start up without assistance should circumstances necessitate his so doing. Further, as the engine is not required to develop its full power in horizontal flight and when alighting, the ability to vary the speed during descent is certainly preferable to the crude method of switching the ignition off and on.

(6) Freedom from vibration: The necessity for elimination of vibration as far as possible will be obvious when the slender nature of the supports upon which the engine is carried is realized, especially as vibration of a dangerous character may be set up in the various parts of the machine.

(7) Accessibility: The question of convenience of access is frequently overlooked or, at any rate, disregarded on account of the care and attention which is now given to the class of engine before any extended flight is made. But it must be realized that from commercial considerations alone, apart from the addition to the time during which the machine can be used and which may, under some circumstances, be of value, it would be an advantage to be able to readily examine or dismantle any part, especially when the applications of the aeroplanes are more widely extended.

(8) Silence is desirable in any machine used for pleasure or sporting purposes, but when it is intended for employment on military reconnaissance duties it becomes of increasing importance to be able to maneuver without giving audible warning of approach, especially at night.

(9) Cleanliness is in the nature of a refinement, but it is none the less necessary since a dirty appearance is generally caused either by the oil splashed about during hand oiling or by the exhaust, both of which are objectionable—the former because the part requiring such attention is apt at times to run dry owing to the irregularity of the supply of lubricant, and the latter because it indicates an open exhaust.

Another contribution along similar lines worthy of reproduction is that of Granville E. Bradshaw before the Scottish Aeronautical Society (Glasgow), December, 1913:

There is probably no form of prime mover in existence that is more highly stressed or that has a more strenuous life than the aeroplane and there is undoubtedly no engine that has greater claims on reliability. The aeroplane, manufacturers' cry for the extremely light engine is probably greater to-day than it ever has been in the history of aviation. The demands of the authorities who purchase aeroplanes are such that probably as much as 90 per cent of the factors which determine the most successful machine are governed directly or indirectly by the weight efficiency and fuel efficiency of the engine. By the former is meant, of course, the number of pounds of weight for every horsepower developed. That the engine shall be extremely reliable is of course taken for granted.

Among the essential features of all successful aeroplanes are the following:

(1) It shall climb very quickly. This depends almost entirely on the weight efficiency of the engine. The rate of climb varies directly as the power developed and indirectly as the weight to be lifted. That the aeroplane shall be very efficient in this particular can easily be understood when one remembers that its capabilities of evading destruction from projectiles depend to a great extent on how quickly it can get out of range of such projectiles. It must also be efficient in climbing in order to successfully rise from a small field surrounded by tall trees which may be necessitated by a forced landing during a cross-country flight over a populous district.

(2) It shall have a good gliding angle; or, in other words, that from any given height it shall be able to glide for a great distance, is also governed indirectly by the weight of the machine, and consequently by the weight of the power plant, because a machine with a heavy power plant must be designed with a larger lifting surface and must be stronger in proportion. With the same lifting surface and head resistance the angle of descent of the heavy-engined machine will be steeper¹ than that of the light machine, as higher speed is necessary to support increased weight.

(3) It shall have a combination of fast and slow flying speeds. This is of paramount importance and one that aeroplane constructors are paying probably the greatest amount of attention to. The capabilities of a machine to fly slowly as well as fast depend almost entirely on the adoption of an extremely light and powerful engine. If the machine is designed for very high speed, a slow speed is only possible by the machine, and consequently the power plant, being very light. Note.—The wing characteristics of lift and drift are also very important.

(4) It shall be safe to handle in all winds both with and without the engine in operation. Aeroplanes have been built that will carry as much as 15 to 20 pounds

¹ The heavier machine glides faster, not steeper.

per square foot of supporting surface, but constructors nowadays agree that the lightly loaded machine is the safer to handle and the average loading on the planes is to-day generally in the neighborhood of 4 or 5 pounds per square foot. A heavily loaded machine depends to a great extent on high speed of flight in order to maintain it in the air. Should the speed fall, unconsciously to the pilot, through loss of engine power or from any other cause, the control becomes sluggish and will not answer quickly, the aeroplane, unless the nose is put down very quickly to increase the speed, flounders about like a log in the sea and generally ends in a side slip and one of these terrible nose dives that have deprived us of so many of our best pilots. The life of the pilot of the heavily-loaded machine is more dependent upon the good behavior of the engine than is the life of the pilot of the lightly-loaded machine, and the latter could probably go on flying in search of a good alighting ground with two or three cylinders not firing at all.

(5) It shall be able to remain in the air for long periods. This depends chiefly on the oil and gasoline consumption of the engine and without efficiency in this respect, the extremely light power plane is practically useless, as flights of only a few minutes duration are not likely to be of much use in serious warfare.

All the essentials just enumerated and particularly the last depend of course on the engine being absolutely free from any breakdown, which point has not been dealt with as it is not a debatable one. We are all without doubt of one mind on this matter.

Finally there are reproduced below some extracts from the Notice to Competitors issued by the British Government for 1914 competition for naval and military aeroplane engines, all bearing on the question engine-service requirements:

1. REQUIREMENTS TO BE FULFILLED.

(a) Horsepower, 90-200. (b) Number of cylinders to be more than 4. (c) Gross weight per horsepower, calculated for six hours' run not to exceed 11 pounds. The gross weight includes engine complete with carburetor devices connected up (exclusive of the gasoline tank and pipes), all ignition and oiling appliances, starting handle, all cooling appliances—e. g., fan guarding, air guides, and any water radiator and water connections and any oil left in the engine. It will also include all fuel and oil supplied for six hours' run and all oil containers and pipes therefrom.

The gross weight per horsepower is the total weight of the engine divided by the figure for horsepower, below which the output has not been allowed to fall throughout the six hours' run, with a tolerance of 3 per cent for small variations and inaccuracy of measurements.

(d) Shape of engine to be suitable for fitting in an aeroplane.

2. DESIRABLE ATTRIBUTES OF AN AEROPLANE ENGINE.

(a) Light total weight. (b) Economy of consumption. (c) Absence of vibration. (d) Smooth running whether in normal or inclined position and whether at full power or throttled down. (e) Slow running under light load. (f) Workmanship. (g) Silence. (h) Simplicity of construction. (i) Absence of deterioration after test. (j) Suitable shape to minimize head resistance. (k) Precautions against accidental stoppage—e. g., dual ignition. (l) Adaptable for starting otherwise than by propeller swinging. (m) Accessibility of parts. (n) Freedom from risk of fire. (o) Absence of smoke or ejections of oil or gasoline. (p) Convenience of fitting in aeroplane. (q) Relative invulnerability to small-arm projectiles. (r) Economy (in bulk, weight, and number) of minimum spare part equipment. (s) Excellence of material. (t) Reasonable price. (u) Satisfactory running under climate variations of temperature.

In the recently issued specifications issued by the United States Navy Department a number of items appear bearing on engine-service requirements which are abstracted and reproduced below for comparison.

"They shall be well balanced and produce no excessive vibration at any power. To be capable of being throttled down to 20 per cent of the revolutions per minute for full power. The weight of the engine complete, with ignition system, magnetos, carburetors, pumps, radiator, cooling water, and propeller not to exceed 5 pounds

per brake horsepower. Engine to be fitted with some type of compression release as a means of stopping it. To be fitted with a practical means of starting from pilot's seat when installed in an aeroplane. All moving parts not lubricated by a splash or forced lubrication system to be readily accessible for inspection, adjustment, and oiling. Ready means shall be provided for checking and making adjustment to the timing of the engine. To have an accurate and positive lubricating system which will insure a uniform consumption of lubricating oil proportional to the speed of the engine. All parts subject to corrosion to be protected from the effects of salt water. To be fitted with an approved attachment for obtaining the revolutions per minute. To be provided with means for preventing fire in case the engine is turned upside down. A hand-throttle lever and connections to carburetor to be provided that can be applied for convenient operation by the pilot. This lever to be designed with a positive means of retaining it at the throttle adjustment desired by the pilot. All bolts and screws without any exception to be provided with an approved positive means for preventing backing out due to vibration. No soft solder to be used in any part of the power plant."

Among the conditions for acceptance tests the following stipulation will be noted: "Motor to be run at full power for one-half hour under conditions approximating operations in the aeroplane in a heavy rainstorm."

At the present time many of the important conditions that an aeronautic engine must fulfill are pretty well settled, at least in kind, if not degree, but every day sees some new attribute announced as desirable, so that while it can hardly be said that aero service requirements for engines are now reducible to rigid specifications, they can be formulated with enough precision to enable an engine designer and manufacturer to undertake production with some prospects of success or acceptance. In so proceeding, however, no designer or manufacturer can afford to ignore past experience in engine construction nor, on the other hand, may old constructions be slavishly reproduced, for what was acceptable yesterday may not be to-day, and certainly will not be to-morrow.

All these service requirements can be classified under three headings for future more or less minute analysis.

POWER-WEIGHT RATIO, RELIABILITY, AND ADAPTABILITY.

If the engine complete with full tank is light enough it can be used—and is most useful when most light, and this weight involves many factors, each of which must be considered—some independent of others but many interrelated. The longer the contemplated flight, the more change there must be in the relation between specific fuel and oil consumption of the engine and the weight of the engine proper; so in any consideration of this item length of flight must be included. Not yet, however, has the engine or flight art reached the point where it is prepared to fix a minimum weight, though each year sees a definite maximum. In fact, one of the problems of the day for the aero engine designer is to discover means for lowering more and more both this maximum permissible weight that many can attain,

and the minimum possible attainable by only a few of the best—and with increasing flight lengths this is becoming more and more a matter of raising thermal efficiency, engine speed, and cylinder mean effective pressure, with corresponding reduction of lubricating oil. On the weight question, therefore, it is not the service conditions that specify what is wanted other than that it shall be as low as possible, but rather the engine designer is put on his mettle to say how far it is possible to go with due consideration to the other two elements—reliability and adaptability.

Reliability is demanded always, but how much? Some writers call for absolute reliability and others try to specify in numerical terms a value for one or another of its elements. For example, in the 1913 German tests, any engine that dropped to 85 per cent of its normal speed was rejected, and this stipulation was retained for the 1914 competition. Again, in the British conditions, the only power rating allowed was the least attained at any time in six hours. Now absolute reliability is impossible, for this would mean continuous, uninterrupted operation without variation in any respect, except at the operator's will. No such engine has ever been built nor will it ever be built. Obviously what is wanted is as great a reliability factor as the engine designer and builder can secure consistent with other factors, so here again, as with the unit weight factors, the problem is one for the producer to say how far the reliability can be assured, rather than for the user to specify and reject, especially on laboratory tests. However, rejection on such grounds is far more justifiable than acceptance, for the engine so accepted may fail on its first flight, due to some accident or to faulty operator's adjustment. What is needed here is, first, analysis of the reliability factor into its elements and by cooperation between engine designer and user, an agreement on reasonable values for each, so one will not promise, nor the other expect the impossible, but each understand clearly the limits—and more important, the reason for the limit—that means may be sought to eliminate the disturbing cause.

About the same situation is true with the third factor, adaptability, and its elements—such as shape, vibration, silence, accessibility, uniformity of torque. They may be specified to-day only in the qualitative or comparative way, though some of them are capable of formulation, quantitatively, such for example as torque variations. So far it has not seemed feasible to impose any such limits but to leave the field wide open to the designer with an expression of desire for as high a degree of success as is possible with each.

The reason for this state of affairs in the art is clearly due to its youth and the necessity at present, and for some time to come, for the maximum possible encouragement of invention, design, research, and manufacture, until it becomes clear to all just how far it is possible to go in any direction after engaging all available resources of talent, material, money, and plant. When, after such a period, one or more standard types of engine or engine parts—or even of air craft itself—have been established, then will it be feasible to specify more particularly and numerically all the elements of each of the factors of unit weight, reliability, and adaptability.

In the meantime, the problem is one of review of engines produced and an analysis of their construction and performance as a whole and with it a similar analysis of fundamental possibilities. This must

include a more or less standard examination of each of the essential parts of the engines and the relation of form and arrangement to the perfection or imperfection with which the part performs its partial duty or function. Even now, as Soreau, reporting the French tests, points out, the relative importance of low engine weight proper, reliability and life, and consumption of fuel and oil, originally considered in this order, has been reversed, experience indicating that the last is now first and the first last.

Part 1 (b).—MEANS EMPLOYED UP TO THE PRESENT TO PROMOTE AERO-ENGINE DEVELOPMENT, INCLUDING POSSIBLE MEANS NOT EMPLOYED.

Any new art develops as fast as encouragement is offered or as fast as the necessary means are made available and intelligently used, and, of course, inversely as the difficulties involved. It would be hard to find any class of machine among those developed in modern times that had to face the same inherent difficulties incident to the nature of the problem, or one that received, at least for the first few years, so little real encouragement and assistance as this one, the aero engine. The initial step is one of conception, which must be subsequently checked by construction and trial. This must be followed by commercial perfection, which requires endless research by test and computation—not only on the machines as a whole but to a larger degree on each element of the problem that analysis indicates to have separate entity, and on groups of elements that have coordinate functioning. Construction is here again necessary, not only of the complete machine, but also of variants on each part, and of instruments, appliances, models, and apparatus that do not themselves enter into the result but are essential to its attainment. Finally, with commercial perfection, further construction work is necessary to create the means of rapid large scale reproduction within the limits of dimensions needed for interchangeability of parts, i. e., establishment of the manufacturing plant. It must be understood, however, that these three steps that must be undertaken in this order on general principles may not be repeated many times over even when concerned with the same product, such as the aero engine, or that the earlier step ceases when the latter is inaugurated, for this is not true. These three stages or periods of development may, for the want of better terms, be designated as, first, the period of invention; second, the period of design; and, third, the period of manufacture. Design can not be undertaken before invention, whether that invention be of the patentable sort or not. Yet invention undoubtedly proceeds long after design has been firmly established and, of course, while manufacturing may not be undertaken until both invention and design have accomplished a reasonably commercial perfect product, it goes without saying that both invention and design will continue during the whole of the manufacturing period.

With the exception of invention, which needs little encouragement beyond a stimulation of the imagination, the primary factor in successful development is money, for, with sufficient funds, the necessary professional skill, labor, materials, and plant may be secured for carrying out the steps of design and manufacture. Of course, money may be, and usually is, misspent in these developments, especially when the control is in the hands of persons lacking engineering skill and

experience, so there should be added the requirement that organization be associated with money.

No better illustration of this situation can be given than that of the steam turbine, whose period of development practically coincides with that of the aero engine, but which has been brought to a state of commercial perfection that the aero engine has not even approached, partly by reason of the better understanding of the service requirements that are not yet fully formulated for the flying machine, but almost entirely because of the differences in the means employed for the development. The steam turbine had its invention stage, and while invention still proceeds it is largely superseded by rational design for manufacture, under skillful guidance, under proper organization, suitably financed and satisfying an ample, well-understood market demand. The aero engine is still largely undeveloped, invention is still more active than design, and the almost microscopic, painstaking research required to establish the data necessary for design is almost wholly lacking, so naturally manufacturing in the true sense of the term is correspondingly nonexistent, though a few individual models of engines are being reproduced in fair numbers.

The millions of dollars needed for rational perfection for manufacture become available to the suitable organization ordinarily only when a permanent market is clearly in sight and when the service requirements of the product are reasonably definite. In the case of the aero engine, this market has been absent or at least very uncertain and the service requirements very hazy—both so much so that under ordinary conditions the aero engine could not have reached even the degree of perfection so far attained, unsatisfactory as it may be, without other incentives or different sorts of encouragement than the ordinary article of commerce receives as, for example, again the steam turbine. This special element in perfecting the aero engine is that of governmental aid based on military necessity, a comparatively recent force in the situation but now a very strong one in Europe, but almost wholly lacking in America. The military establishment can purchase what it needs in the market only when there is a reasonably strong civilian demand for the same article, strong enough to warrant the financial investment necessary for its perfection—and such is the case with the automobile and traction engine. On the other hand, when there is no such demand, however active invention may be, rational design and manufacture will be absent and must be supplied by the Army and Navy through their own organization and plants, or, as an alternative, reasonably steady annual governmental appropriations for purchasing sufficient quantities by the military departments may be made the basis of support for civilian production. Such is the case, for example, with ordnance and to some extent with ships.

For several years after the demonstration that engine-driven air craft could make successful flights the only encouragement offered to development was that of adventurous sport. Men whose incomes were sufficient became purchasers of machines for their own amusement and others bought machines for making exhibition flights before paying audiences for the profit to be derived. Both sorts of operators took chances with the imperfections of the machine in a spirit of adventure or speculation, but practically all made short flights that made no such demand on the engines as is now standard. Men such as Eiffel, and Deutsch de la Meurthe, should be mentioned for their con-

tributions of large sums of money for scientific investigations, not of engines, however, and the national subscription funds of France and Germany, all of which assisted in development. In many cases, even with these short flights, the engine was taken apart, cleaned, repaired, and readjusted before each ascent. Even as late as September, 1912, Mr. Earle L. Ovington, writing in the *Scientific American* reports:

Usually every 15 hours of running, and at most every 20, my mechanics (skilled men) went through the interesting process of separating every single component part of my motor, one from the other. The valves were reground and retimed, because of valve-gear wear, new valve springs were inserted, the tappet rods were adjusted, and the whole motor was given a rigid inspection. The Gnome, in common with most rotary motors, uses castor oil as a lubricant, hence at each cleaning great quantities of carbon were removed. I claim that any engine requiring such attention may rightly be termed "delicate." How far would you get in an automobile if you had to take the entire engine to pieces and readjust practically every working part of the whole motor every 15 or 20 hours of service?

In an article in the *Auto Car* of March 28, 1914, we find the following statement:

The Gnome engine requires cleaning out after about 24 hours' continuous running if it is to be kept in tune. The French military regulations demand that the Renault be cleaned out after 200 hours' running. Users of other aeroplane engines have told the writer that cleaning carbon out is hardly ever necessary.

With such an uncertain and capricious market perfection of the aero engine could hardly be expected in a whole lifetime, especially as the amount of business in any one country would scarcely suffice to support one producing establishment, and that one unable to bear the expense of the high-salaried engineers competent to supervise the work and when, at the same time, the stimulus to the imagination created by the idea of the mechanical flight produced thousands of inventions and inventors, each seeking and many finding financial support, under the influence of the excitement of the time rather than from any sound business basis. Failures necessarily must be numerous under such conditions, and every failure, whether of mechanism or finances, set back the art and discouraged the rest.

During this period the military organizations of all the nations watched results and purchased a few machines for experimental purposes, out of which grew the conviction now so firmly established and so thoroughly demonstrated in the present European war that, however imperfect the aeroplane, it is a military necessity and must be perfected. Perfection being impossible or too slow without governmental aid, plans were formulated by the European nations, one after the other, and, in addition to creating a corps of flying men with suitable cooperation with the military establishment, competitive tests for aero engines were organized by Germany 1912-14; France 1909, 1911, and 1913 in cooperation with the *Ligue Nationale Aérienne* and the *Automobile Club de France*; Italy 1913; and England 1914, in which substantial money prizes were offered for successful machines and in some cases buying orders given to winners in the contest. It was the intention to make each of these contests an annual event so as to not only continue the development of engines under this incentive, but to show clearly the annual progress by comparison of the entries in successive years on the basis of their performance, in relation to their form, materials, and proportions. The contests so far held are summarized in Appendix 1, which also reproduces the conditions and such of best results with

some discussions and interpretations as are obtainable from published reports. Unfortunately the European war has interrupted reports of such tests as were completed in 1914 and prevented the carrying out of others, so that the latest information of this class is not now obtainable.

Besides these governmental contests with cash prizes and purchasing orders, which are undoubtedly the biggest single influence so far brought to bear on the rational development of the aero engine, there are some other coordinate factors to be noted, and these are civilian contests conducted by organizations interested professionally in promoting the art or by individuals, reports of which are also given in Appendix 1, with the Government contest reports. Among these private contests are to be noted in France Competition of La Ligue Nationale Aérienne, 1911; Automobile Club of France, 1913; England, Alexander contest, first for British-built engines, 1909, and second for any engine, 1912.

Finally, there must be noted among these influences for good in the rational development of the aero engine the establishment of laboratories for testing engines alone or flying-machine supporting and control elements alone, or both engine and air craft, and reference is made to the paper by Dr. A. F. Zahm, May, 1915, reproduced in Appendix 2, with other laboratory references in addition to those contained in the contest reports of Appendix 1. Some of the results obtained in these laboratories are not published and apparently but little work has been done on engines. It is assumed that most of the laboratory work on engines so far done is such as to be of value only to individuals seeking to perfect their own engine, or, believing it perfected, seeking an independent test report to enlist capital for manufacture or to serve as an advertising inducement to purchasers.

As a consequence, the conclusion must be that the largest single factor in the recent rapid development of the aero engine is governmental, involving the establishment of official organizations to study the problems, the operation of laboratories to determine by test the results attained by designers and producers, especially when large and regular purchasing orders are involved to support civilian development and manufacturing establishments, or in the absence of sufficient orders, and perhaps in addition to them, the distribution of sufficient cash prizes, whether originating in governmental appropriations or private and institutional donations.

Great as has been their influence for good in aero engine development, these contests have not yet been under way long enough to have accomplished more than a small fraction of what may be so attained, nor can this contest means be regarded as either sufficient or without faults. There is an inherent danger that the results of such tests be misinterpreted, and in fact there is even a bare possibility that they may exert a retarding influence on the art. Naturally competitors design engines and enter them to win a prize and the conditions of the contest become the controlling factor in the preparation of an engine for entry. If these conditions place undue weight on factors that are not of primary importance to the engine as it works in place in actual flight, it is easily possible that not only may the best engine from the actual service standpoint be rejected but, worse than that, the bulk of these workers who are engaged in development will be led away from lines that are truly legitimate in order that by following the lines prescribed by the rules

they may secure the necessary cash to continue. In view of this possibility too much care can not be exercised in the preparation and regular revision of these contest rules and conditions in order that the result may be what is wanted and what is needed by the whole art, instead of a perfect attainment of a merely hypothetical standard.

Attention is called to these rules in the appendix and especially to the alterations in later German rules as compared with the earlier, all directed toward greater latitude and greater reliance on the judgment of competent engineers and proportionately less on the numerical values of those quantities that are subject to measurement and which require experienced cultivated judgment to interpret into terms of engine goodness which often depends as much on intangible things such as workmanship, ruggedness, simplicity, and the other factors of general adaptability. In this connection there is a most significant, though guarded, statement at the end of the second report of the Deutsche Versuchsanstalt für Luftfahrt by Dr. F. Bendeman, January, 1913, the best document on the subject in existence herewith quoted:

The further development of the aeroplane and engine construction makes it seem desirable that in a future competition the engine be judged more in its relation to the *operating conditions* of the machine.

Even at best, better than yet arranged, the contest exerts but an indirect effect on engine development, it results in a public statement of a judgment of the machines relatively considered with reference to the rules and to each other. The winner is stated to be that engine that has best fulfilled the prescribed conditions; it is announced as better than others in this respect and that is all. Any test that measures only over-all results, whether of fuel and oil consumption, weight, horsepower, speed, unbalanced forces, torque variation, or similarly measurable quantities is faulty as a factor in direct development of engines to perfection. The only sort of direct contribution that can lead to true scientifically sound advance is that generally termed research which involves the patient analysis of not only over-all performance but more particularly of the performance of each part intended for the execution of every separate function, the accumulation and interpretation of data for the diagnosis not of the faults found but the determination of their causes and discovery of remedies, all of which are to be followed by the application of the promising prospective cures with test checks on their success. This sort of work requires the highest class of training and skill and is to be carried out as much in the computing and drafting room as in the laboratory, but to do most good to a young art struggling blindfolded to advance, every result must be not only convincingly and accurately arrived at but must be given wide publicity. This is the kind of development work that must be done and has not yet been attempted anywhere outside of a few establishments producing engines and in them is only carried on to a small degree because of the heavy expense, and naturally this same expense is sufficient reason for nonpublicity.

Research and publicity of the data of research are far more needed than public contests and their reports. While the latter are in a way an expression of the conclusions of the former, they give no clue to the means found necessary to bring them about no more than the sight of a man cured of an illness by a physician gives the observer any idea of the physician's diagnosis and methods of cure.

The advance of the profession or art is more important than an isolated case of perfection.

However sadly lacking are the data of research on aero engines, what literature there is descriptive of engines, of conditions of flight, of experiences, successes, and failures, of contests and over-all performances should be most thoroughly collected and recirculated in the form of collected papers.¹

Part 1 (c).—GENERAL CHARACTERISTICS OF PRESENT AERO ENGINES: POWER, SPEED—ENGINE, RADIATOR, WATER, GASOLINE AND OIL TANK, WEIGHTS—FUEL AND OIL CONSUMPTION, AGGREGATE POWER-PLANT WEIGHTS WITH FULL TANKS FOR GIVEN LENGTH OF RUN—ENGINE TYPES.

Since the period 1901-1903, with the two engines, Wright of 12 horsepower, a converted four-cylinder, vertical automobile engine weighing for engine alone about 7 pounds per horsepower and the then novel Manly design of radial star fixed cylinder engine of 50 horsepower, weighing for engine alone 2.4 pounds per horsepower, there has been produced in the interval more than a hundred different designs that have survived the stage of first trial. There are now on the market perhaps half this number of different engines being regularly reproduced, each to some extent and several quite extensively (for this art), and of several of these designs engines are available in more than one size.

While most of these engines have capacities of 50 horsepower, more or less, the number that reach or exceed 100 horsepower is steadily increasing, following the demand of the aeroplane and made possible by greater experience in construction of the smaller sizes. It is worthy of note that the 1913 winner of the Gordon-Bennet cup race carried 200 horsepower and the Russian Sikorsky used in his 17-passenger machine 400 horsepower in two engines. The latest Curtiss aeroplanes carry 320 horsepower in two engines, and the English Sunbeam catalogues a single engine of 225 horsepower. While some types of engine construction give trouble in large sizes, there is no reason to believe that the limit of engine capacity has been anywhere nearly reached, for even if a high limit of cylinder diameter be found, which is not the case yet, multiplicity of cylinders can carry up total capacity. Naturally there is no limit to the number of separate smaller capacity engines that may be placed in one air craft except that as the weight per total horsepower of two or more engines is always greater than of one engine of equal aggregate capacity. On the question of total power there is no high limit in sight, though the normal is somewhat about 100 horsepower. Germany in 1914 required for her latest army planes 80 to 120 horsepower and more for hydroaeroplanes, while the United States Navy specifications of 1915 call for 100 to 160 horsepower. It may easily happen that this trend toward larger engine capacities will result in the elimination of some styles of engines which only operate well in smaller units, or what is more likely as the number of different types of air craft increases in the limitation of engine type to flying machine type.

¹ A more or less complete bibliography of aero engines is offered in Appendix 3 as a nucleus, as full as the limited time available will permit, and to show the character of some of these papers, a selected few are reproduced. To complete this bibliography and republish these papers will be of very great service to the art, especially if there be added a corresponding collection of patents in all countries either in full or in abstract.

Speeds of engines are all in excess of 1,000 revolutions per minute, most engines operating normally between 1,200 and 1,500 revolutions per minute, with a few exceeding 2,000 revolutions per minute, the highest being the Sunbeam engine, rated at 2,500 revolutions per minute. These, of course, are the speeds when carrying normal full load and therefore a reduction of load, such as would follow a change of propeller to one of lesser torque or such as results from a gust of air in the direction of propeller air discharge, will accelerate the speed. This is because the full throttle, mean torque, of these engines is about constant up to speeds considerably in excess of their normal, probably approaching 2,000 revolutions per minute for most of them, though in all mean torque will decrease beyond some critical speed, due to valve and port resistance on the one hand and insufficient speed of combustion on the other. Below this critical speed, which is partly a matter of design of valves and ports, the horsepower is directly proportional to speed, and so speed increase is a natural means of reaching the light weight per horsepower of engine. It does not necessarily follow, however, that, because in a given engine the high speed does not reduce the mean driving torque, the engine will not suffer from the speed. In fact, it is just here that so many of the failures are found, the engines literally shaking themselves apart and pounding or grinding themselves to pieces. With due attention to the forces developed by high speed, and to bearing friction effects of rapid motion over loaded sliding surfaces, and to the suitable arrangement as well as proportions and materials for it, there is no reason why, from the engine operation standpoint, the present normal range of 1,200 to 1,500 revolutions per minute should not be exceeded if the service demands it, though the engine designer's problems are easier, the lower the speed. It must be noted that there seems to be no essential relation between propeller speed and engine speed if the operator has no objection to gearing, which in these days of automobile alloy steel gears can be made probably the most reliable element of the machine. Testing of engines at excess speeds to limits of unbalanced forces, bearing friction wear, and mean torque would seem to be a rational means of assuring that the operating speed itself will not cause trouble however much other causes might enter. Such a practice would be somewhat in accord with the hydrostatic test of 50 per cent excess of working pressure now standard with steam boilers and somewhat similar because each may in emergency reach that excess, in the one case of speed and in the other of pressure which may cause failure.

Engine weights now attained, per horsepower developed, exclusive of tanks, radiators, and supplies of gasoline, oil, or water, by the several classes or types of machines, at their own normal speeds, have not been materially lowered for some time, attention having been rather concentrated on the reliability and adaptability factors with existing weights, instead of on further weight reduction, though this will undoubtedly come in time. There is, however, a rather marked division of unit engine weights according to system of cooling of engine, whether by air or by water, involving besides water weight, that of radiator. For example, the most popular French rotating star cylinder air-cooled Gnome engine weighs just about 3 pounds per horsepower, ranging from $2\frac{1}{2}$ for 100 horsepower to $3\frac{1}{2}$ for 50 horsepower, while the vertical water-cooled automobile style and winner of the last German competition weighs 4.2 pounds per horse-

power. (A number of tables and some charts of engine weights are given in the papers in the appendix which are not repeated here, as it would serve no good purpose.) Attention is however called to the fact that the highest weight reported in the German competition (second) is about 6 pounds. This is about the present high limit, while 2.2, the value for the Gnome 100 horsepower, is the low limit, the water-cooled group occupying the upper portion of this range, the air-cooled, its lower portion. It is most interesting to note that the middle range in the neighborhood of 4 pounds is occupied by both types, providing that water-cooled engines can be built as light as some kinds of air-cooled engines, or that air cooling does not necessarily result in the lightest engine.

Whatever influence in this unit weight of engine alone the general arrangement may have is shown by a comparison of figures for some typical differences of arrangement or type. It ordinarily is of the order of a fraction of a pound and may be entirely offset by some other structural feature, not a factor in general arrangement, such as the use of a steel cylinder in one arrangement against a cast-iron cylinder in the other, or a high mean effective pressure in one against a low value in the other due to different weights of active mixture taken in per stroke. It would seem that cylinders set radially about a short single throw crank should yield an engine weight per horsepower less than the same number of cylinders set in line along a long multi crank shaft. Also that a V arrangement of two lines of cylinders should weigh less than a single line because of shaft and frame differences, but it is not clear whether a given output in four cylinders will yield a greater or less weight than in six or eight similarly arranged, nor is it clear just what difference in horsepower, if any, should be expected per unit of displacement per minute in water-cooled as compared with air-cooled cylinders. As pointed out, according to the general figures given, the aggregate of all such differences lie between the limiting weights of about $2\frac{1}{2}$ pounds and 6 pounds per horsepower and therefore cover a range of about $3\frac{1}{2}$ pounds per horsepower for such engines as are now in use and for which test data are available. Just how much of this difference is chargeable to one or another of the factors of arrangement, detail form, proportions, or material, it is not possible at the present time to accurately fix, but as a first attempt the following figures, Table I, are given as derived from available data:

TABLE I.—Weights of engines in pounds per horsepower versus type construction.

Cylinders and cooling.	Class construction.	Engine name.	Authority.	Weight.		
				Alone.	Plant.	
Water-cooled fixed cylinder	4 cylinders in line.	Benz.....	Bendemann.....	<i>Lbs.</i> 3.57	<i>Lbs.</i> 4.20	
	6 cylinders in line.	Daimler.....	do.....	3.75	4.36	
	8 cylinders in line.	Sturtevant.....	Maker.....	3.9	
	12 cylinders U.....	Sunbeam.....	do.....	4.0	
Air cooled:	Radial star.....	2-cycle laviator.....	"Flight".....	3.02	
	Fixed cylinder.....	8 cylinders U.....	De Dion Bouton.....	do.....	5.81	
		12 cylinders U.....	Renault.....	do.....	6.38	
	Radial star.....	British Anzani.....	Maker.....	4.0	
		3.4	
		4.1	
	Special.....	Ashmussen.....	do.....	3.3	
		1 radial star.....	B. M. and F. W.....	Bendemann.....	4.72	4.72
	Rotating cylinder.....	2 radial star.....	German Gnome.....	Maker.....	3.086
			2.480
.....	2.701	

TABLE I.—Weights of engines in pounds per horsepower versus type construction—Contd.

Cylinders and cooling.	Class construction.	Engine name.	Authority.	Weight.	
				Alone.	Plant.
Water-cooled fixed cylinder	4 cylinders in line.	Daimler.....	Bendemann.....	Lbs. 4.29	Lbs. 4.92
	6 cylinders in line.	do.....	do.....	4.60	5.23
	8 cylinders in line.	Curtiss.....	Maker.....	4.0
	Air cooled:	12 cylinders U.....	Rausenberger.....	do.....	3.9
Radial star.....		Salmson.....	Soreau.....	5.47
Fixed cylinder.....	8 cylinders U.....	Renault.....	"Flight".....	5.66
	Radial star.....	British Anzani.....	Maker.....	3.6
Rotating cylinder.....	1 radial star.....	Gyro.....	Bendemann.....	4.81	4.81
	2 radial star.....	Le Rhone.....	Maker.....	2.9
Water-cooled fixed cylinder	4 cylinders in line.	Daimler.....	Bendemann.....	4.74	5.37
	6 cylinders in line.	Argus.....	do.....	4.60	5.23
	8 cylinders in line.	Sunbeam.....	Maker.....	4.1
	Air cooled:	Radial star.....	Salmson.....	"Flight".....	3.42
.....		3.3
Fixed cylinder.....	8 cylinders U.....	Wolseley.....	"Eng'y".....	14.7
	Radial star.....	Edelweiss.....	"Flight".....	3.68
Rotating cylinder.....	1 radial star.....	Gnome.....	Bendemann Lumet.	3.26	3.26
Water-cooled fixed cylinder	4 cylinders in line.	Daimler.....	Bendemann.....	4.89	5.52
	6 cylinders in line.	Mulag.....	do.....	5.14	5.77
	8 cylinders in line.	Clerget.....	"Flight".....	3.2
Air cooled:	Fixed cylinder.....	Radial star.....	2-Cycle Laviator.....	do.....	3.05
	Rotating cylinder.....	1 radial star.....	Gnome.....	Bendemann Lumet.	2.93
Water-cooled fixed cylinder	4 cylinders in line.	Daimler.....	Bendemann.....	5.09	5.72
	6 cylinders in line.	Schröter.....	do.....	4.65	5.28
	8 cylinders in line.	Laviator.....	"Flight".....	3.43
3.48					
Rotating cylinder.....	1 radial star.....	German Gnome.....	Maker.....	3.439
.....	3.197
.....	2.590
Water-cooled fixed cylinder	4 cylinders in line.	N. A. G.....	Bendemann.....	4.33	4.96
	6 cylinders in line.	Hall Scott.....	Maker.....	4.32	5.15
	8 cylinders in line.	Panhard Levassor.....	"Flight".....	4.4
.....					
Air-cooled rotating cylinder.	1 radial star.....	German gnome.....	Maker.....	2.976
Water-cooled fixed cylinder	4 cylinders in line.	N. A. G.....	Bendemann.....	4.36	4.99
	6 cylinders in line.	Austro-Daimler.....	Maker.....	4.5
	8 cylinders in line.	Wolseley.....	"Eng'y".....	5.38
.....					
Air-cooled rotating cylinder.	1 radial star.....	Le Rhone.....	Maker.....	3.1
Water-cooled fixed cylinder	4 cylinders in line.	Argus.....	Bendemann.....	3.77	4.40
	6 cylinders in line.	Benz.....	Maker.....	4.1
	8 cylinders in line.	E. N. V.....	Alexander Prize Report.
.....					
Air-cooled rotating cylinder.	1 radial star.....	Gyro.....	Maker.....	3.25-2.88
Water-cooled fixed cylinder	4 cylinders in line.	Argus.....	Bendemann.....	4.28	5.01
Air-cooled rotating cylinder.	6 cylinders in line.	Wright.....	Maker.....	5.1
	1 radial star.....	Clerget.....	"Flight".....	3.3-2.7

1 Without flywheel.

TABLE I.—*Weight of engines in pounds per horsepower versus type construction—Contd.*

Cylinders and cooling.	Class construction.	Engine name.	Authority.	Weight.	
				Alone.	Plant.
Water-cooled fixed cylinder	4 cylinders in line. 6 cylinders in line.	Sturtevant.....	Maker.....	Lbs.	Lbs.
		Green.....	MacCault.....	4.0
				4.4
Water-cooled fixed cylinder	4 cylinders in line.	Cheno.....	"Flight".....	3.91
				2.87
				3.97
				2.8
Water-cooled fixed cylinder	4 cylinders in line.	Clerget.....	"Flight".....	4.28
				3.96
Water-cooled fixed cylinder	4 cylinders in line.	Green.....	Alexander Prize Report.	5.48	6.8

These figures show a consistent weight excess for cylinders in line over radial, but no conclusions can be drawn on the relations between water *vs.* air cooling for either fixed or rotating cylinders. More data and data in greater detail than are now available are necessary before such conclusions are possible. In later tables the figures are analyzed with reference to other units and some desirable conclusions are derived, but always there must be noted the data which one would expect at this date to be quite full and reliable are found to be both meager and uncertain.

To the weight of the engine proper with all the parts that are permanent features built on or into it, such as the magnetos, oil pumps, air fans, and water-circulating pumps, there must be added the weights of other parts to get the weight of the power plant with empty tanks. These additional parts may be called the engine accessories. All such supplies, as fuel, lubricating oil, and water needed for a given length of run, will add more weight, the amount of which depends partly on rate of consumption, partly on the general arrangement, but principally on the length of the run. The fuel weight to be carried per horsepower varies directly with the length of run and inversely as the thermal efficiency of the engine. The oil weight, while varying somewhat with the length of run, probably is not directly in proportion to it and certainly has nothing to do with the thermal efficiency of the engine, but rather depends on such factors as quality of the oil, mode of its application, style of engine, bearing temperature and surface pressure and speed. Water in any properly proportioned jacket and radiator system should not be lost, and its weight may therefore be regarded as a fixed quantity entirely independent of the length of run and additive as is a piece of accessory equipment such as the radiator itself, though its weight value is, of course, a function of the aggregate internal volume of jackets, piping, pump and radiator.

It needs only a superficial examination of these weights of accessories and supplies compared to engine weights to see that for short runs, engine and accessory weights are more important than supply weights, but that for long runs the supply weights, especially those of fuel and lubricating oil, will become the controlling factors in

plant weight, and the longer the run, the greater the difference, and the more dependent does plant weight become on thermal efficiency and on efficiency of lubrication. For example, the data of the second German competition showed that the winning 100-horsepower Benz water-cooled engine, weighing 4.2 pounds per horsepower, consumed 0.472 pounds gasoline (thermal efficiency, 29 per cent), and 0.042 pounds oil, or a total of 0.514 pounds of both per horsepower hour. The 70-horsepower Gnome air-cooled engine mentioned in Bendemann's report, and weighing 2.9 pounds per horsepower, consumed 0.805 pounds gasoline and 0.253 pounds oil, or a total of 1.058 pounds of both per horsepower-hour. This being the case, the aggregate weight of the engine and supplies for different lengths of run up to 20 hours compare as follows, neglecting variations in tank weights that should add a little more to the engine of high consumption than to the more economical one. The radiator weight of the Benz engine is included:

Weights of engine, gasoline, and oil.

	For—				
	0 hours.	5 hours.	10 hours.	15 hours.	20 hours.
Benz.....pounds...	4.2	6.77	9.34	11.91	14.48
Gnome.....do.....	2.9	8.19	13.48	18.77	24.06

Such relations as these—(Bendemann report shows the weights equalize in $1\frac{1}{2}$ hours' operation)—lead to that most important conclusion derivable from all the competition test data in existence, viz, engines intended for short runs must be themselves light and need not be especially economical if, by sacrificing economy lightness is promoted. Conversely, engines intended for long runs must be economical at all costs, almost regardless of weight. It may also be added and this seems most significant that reliability is of importance about in direct proportion to the length of run, assuming good condition to be assured before starting in each instance, so that, again on the grounds of reliability, short run engines must be light even if less reliable, measured by period of uninterrupted operation, while to long-run engines considerable weight may be added to gain reliability.

From the design standpoint, a broad principle of practice can be directly derived, to the effect that aeroplane engines being intended for more and more widely varying types of service as to frequency of flights, length of run, and load-carrying capacity, need not be of one design, style, or type, but that different ones are justified and good engineering procedure demands the development and perfection to equal degrees, of as many different types and characteristics as will best serve the varying requirements of flight. From among these, a selection may intelligently be made for general service of undefined nature but with full forehand knowledge of its capabilities and limitations. All this agrees with engineering practice in other fields for there are to-day not only more different steam engines than ever before, but in any one group, such as locomotives, there is greater variety than there ever was; why, therefore, should anyone expect to find a single aeroplane engine or plan the development of

one type to the exclusion of others? To do so, is to assume that all flights in all flying machines are the same as far as engines are concerned, which is just about as true as the assumption that a good pleasure motor-boat engine is the right thing for a trans-Atlantic ship, or that the best power plant for a tramp freighter will properly serve a battle cruiser. To be sure there are certain elements of service peculiar to flight, to which all aero engines must be adapted, but this can not be interpreted to mean that all aeroplane engines must conform to one another in arrangement, performance, or even in materials throughout.

Returning to the factors of plant weight, study of which leads to such important conclusions as the preceding, it is worth while to examine more closely the separate influences of the several component factors of accessory and supply weights.

Radiator weights must vary with the amount of sheet metal, cooling surface of given material in kind and thickness. The purpose of this surface is heat dissipation to the air, so the number of square feet and its weight will vary directly as the jacket heat loss of the engine, and directly as the mean temperature difference between water and air, but inversely as the coefficient of heat transmission. The most reliable data on this amount of heat to be dissipated, in fact, the only data are given by Bendemann, who finds that contrary to most internal-combustion engines, including the automobile class, which give up between 30 and 40 per cent of their fuel heat to jacket water, aero engines conform pretty closely to 15 per cent of the heat of combustion given to and carried by the water to the radiator. The difference, 15 to 25 per cent, is either not taken up by the water from the combustion chamber at all, passing out in exhaust gases instead, or, being taken in part by the water, is dissipated directly from jacket and water pipes to the air. In formulating the rules of the German competition, the radiator weights were assumed to conform to automobile practice and taken at 0.13 pound per 1,000 British thermal units per hour, but the experiments indicate that this should have been about 0.4 pound per 1,000 British thermal units per hour. Taking the calorific value of gasoline at the round number of 20,400 British thermal units per pound and the consumption of the more efficient water jacketed engines as one-half pound per hour per horsepower, the heat supplied per hour per horsepower is 10,200 British thermal units, of which 15 per cent, or 1,530 British thermal units per hour must be dissipated by the jackets. This quantity with the constant of 0.4 pound per 1,000 British thermal unit hours would make the radiator weight 0.61 pound, per horsepower of engine. Comparing this with the radiator weight of the 61.6 horsepower Green (British) engine, winner of the Alexander prize competition, which had a total weight of 46.9 pounds, the actual unit weight of radiator and connections becomes 0.76 pound per horsepower of engine, a fairly good check, considering the wide differences of design and circumstances. Winkler puts radiator weight between 0.40 and 0.55 pound per horsepower.

It is perfectly well known how fundamentally dependent on the flow conditions of the air, on the air side, and on the presence of air or steam bubbles, on the water side, is the coefficient of heat transmission for such apparatus as radiators, and yet this subject has scarcely

been touched as a research problem, especially when it is considered that the mean temperature difference, another prime variable, is itself subject to considerable control. This will account for such differences in radiator weights as exist and is responsible for the belief that very material reductions may be expected in radiator weights following proper research or arrangements for securing rates of heat transmission and on thin noncorrosive metal inclosures.

Water weights are, of course, directly under control of the designer within certain limits, as the jacket spaces may be long or short, wide or narrow, pipes short and small or long and wide, and the water space in the radiator itself, almost anything. In the same 61.6 horsepower Green engine, winner of the Alexander prize, the whole water weight was 34.1 pounds, or 0.56 pound per engine horsepower less than the radiator weights. Winkler places this between 0.2 and 0.3 pound per horsepower. Other values for different engines are given in Table II to show the order of the magnitude of this factor.

Tanks for gasoline and oil will weigh more for large than for small supplies, but not in proportion to their volumes, as shape, thickness, and kind of material will determine the square feet of metal and weight of the tank per cubic foot of capacity as much as the volume. Other things being equal, that shape of tank will weigh least that has least weight per cubic foot of volume, and cylindrical tanks are most economical of metal weight, needing no stays, so the ratio of length to diameter is an important factor, which, however, also affects wind resistance, but these variations are not of such an order of magnitude to warrant detailed study here. The above-noted Green engine, 61.6 horsepower, and a gasoline tank of 70 gallons weighing 39.7 pounds, and a lubricating-oil tank of 6 gallons weighing 9.2 pounds, so that the net weights are, gasoline tank 0.65 pound and oil tank 0.015 pound per engine horsepower, or 0.57 pound per gallon for 70 gallons and 1.54 pounds per gallon for 6 gallons. Bendemann gives the round number of 0.2 pound tank weight per pound of gasoline or oil, which does not check the above figures. Tanks used in tests, he writes, are frequently too light for actual service, which indicates a necessity for standardizing tank-metal thickness, shape, and to some extent size, as large capacity may be just as well carried in several small tanks as in one large one and with better weight distribution on the frame, as well as affording a measure of safety.

Gasoline consumption for the better water-jacketed engines averages very closely 0.5 pound per hour per brake horsepower (B. H. P.), and for the rotating-cylinder air-cooled engines about 0.8 pound for full load, though, as might be expected, there are quite wide variations with type of engine and its condition as to cleanliness, adjustment, load, and speed. There is practically no data available on the rise of consumption with poor adjustment of carburetor, ignition, leaky valves or pistons, gumming bearings, carbonized combustion chamber, or even at speeds other than normal, or throttle positions other than wide open. It is not possible from test data to even approximate the gasoline consumption of an aero engine in actual flight service, though, judging from data on other classes of gasoline engines, it may easily be double this best value obtained by perfectly tuned new engines in competitive tests. We have many figures on total consumption of gasoline and oil during competition flights, but horsepower of course was not determined, and such figures must be com-

pared with each other to give a true picture of range of possible variation. Even here, however, the operators are skilled and on their mettle, so they may be expected to better ordinary everyday flight consumption. These engine-test figures may be translated into thermal efficiency approximately by taking the average calorific value of American gasoline at 20,400 British thermal units per pound, making the engine heat consumption for the two typical classes 10,200 British thermal units and 16,320 British thermal units per hour per brake horsepower, equivalent to $\frac{2,545}{10,200} = 25$ per cent and $\frac{2,545}{16,320} = 15.6$ per cent thermal efficiency referred to brake horsepower. With the actual consumption of the Benz engine of 0.472 pound, Bendemann reports a thermal efficiency of 29 per cent, which requires that the gasoline used have a calorific value of 18,900 British thermal units per lb., which is the value used by Guldner for European gasolines. Other figures indicate about an equivalent difference between the American and European fuels which could be accounted for by the prevalence of paraffins and olefins, respectively, in each, even if of equal density.

Such a thermal efficiency as this high value is truly remarkable, and under the condition of operation and size of aero engines can hardly be bettered, judging from other experiences and from fundamental conditions to be examined later, but the low value is too low to be tolerated without adequate compensating advantages in engine weights for short flights and in the reliability and adaptability factors. Actual test values for specific engines and tests are reported in the appendix and need not be detailed here, but attention is again called to the practical importance of consumption data on other than these best conditions to show not only how high it may be in service, but also how sensitive it is to each individual adjustment and operating condition that may exert an influence.

Oil consumption is a thing that seems to follow no particular law, however much may be known about contributory circumstances, such as chemical character, viscosity, mode of application, surface speed, pressure and temperature, air evaporation, combustion chamber carbonization and cracking, and exhaust discharges. Beyond the more or less general adoption of castor oil to avoid gasoline absorption in the crank cases of rotating-cylinder aero engines, and the use of most widely different systems of feed and bearing conditions, this is a practically wide-open field of research. In all the competition tests the oil consumption has been made a subject of measurement, but no analysis of causes of consumption has been made, nor are there any data on the relative consumption of different oils or of different oiling systems for a given engine. The figures must be taken for no more than they really represent, viz, what was used, but it can be assumed that they are no guide whatever to the oil that will be consumed in actual service, except when consumption is fixed by a pump plunger displacement. Nor do these figures aid in fixing the least value attainable after proper thorough research on the lubrication of a given engine, which is rather more a matter of reliability and engine life than of oil weight to be carried. In the German tests values were found ranging from 0.009 pound to 0.089

pound per hour per brake horsepower for the water-cooled engines and from 0.145 to 0.253 pound per hour per brake horsepower for the rotating air-cooled cylinder engines. The only conclusions derivable from these figures are that there is a very wide variation—about 25 to 1—proving the need of study, and that on the whole the rotating air-cooled cylinders are much greater oil consumers than the fixed water cooled.

The aggregate weight of all the units of the power plant, engine, engine accessories, and supplies can be represented algebraically or graphically with every element involved in correct relative magnitude. All of these weights are constants for each engine, except the gasoline and oil weights, which are products of consumption per hour and the length of the run. Accordingly, the graphic representation will be a series of straight lines or of the aggregate, a single straight line. Algebraically the equation of that line will contain two constants, each of which is the sum of similar constants, one representing intercepts on the axis of zero time and the other slopes. In order to keep the various elements of the aggregate weight distinct and to bring out clearly the big factors of weight of engine proper and of gasoline weights, it is desirable that the excellent arrangement of a single line for each engine used by Bendemann in the second German report be supplemented by a general equation involving all the constants and a table of values for each as derived from the tests. Such an equation will have the following form:

$$\text{Weight of plant complete with tanks full for } H \text{ hours' run, pounds per horsepower.} \left. \vphantom{\text{Weight of plant complete with tanks full for } H \text{ hours' run, pounds per horsepower.}} \right\} = \left. \begin{array}{l} \text{Weight of engine alone per horsepower.} \\ + \text{Weight of gasoline tank per horsepower.} \\ + \text{Weight of oil tank per horsepower.} \\ + \text{Weight of radiator per horsepower.} \\ + \text{Weight of water per horsepower.} \\ + \text{Weight of muffler.} \\ + \left\{ \begin{array}{l} \text{Pounds gasoline per hour per horsepower} \\ \text{Pounds oil per hour per horsepower} \end{array} \right\} H. \end{array} \right\}$$

Symbolically this takes the following form with corresponding meanings from the former equation:

$$W = W_e + W_{ot} + W_{ot} + W_r + W_w + W_m + (G + O)H$$

In the following Table II are given some typical values for these seven constants, derived from the tests and for the total W for 0 and 10 hours. The gasoline and oil weights are added for 15 and 20 hours, but the plant weight can not be so given because of the uncertainty of the tank weights, which naturally are not directly proportional to content weights. It is interesting to note, however, that in 10 hours the plant weight is doubled—that is, the supplies for that time equal the weight of the plant empty for water cooled fixed cylinder engines. The air cooled rotating cylinder engines in the same time of 10 hours more than quadruples the weight.

TABLE II.—Weights of engine accessories and complete plant weights per horsepower versus type construction.

Name and authority.	Engine alone.	Gasoline tank.	Oil tank.	Radiator and connections.	Water.	Muffler.	Total engines and accessories.	Gasoline per hour.	Oil per hour.	Gas and oil for 5 hours.	Gas and oil for 10 hours.	Plant and supplies for 10 hours.
Average values, Bendemann.....		(¹)	(²)	0.63								
4-cylinder 100-horsepower Benz, Bendemann.....	3.57	0.944	0.084	.626			5.224	0.472	0.042	2.57	5.14	10.364
6-cylinder 90-horsepower Daimler, Bendemann.....	3.75	1.02	.076	.626			5.472	.510	.038	2.74	5.48	10.952
4-cylinder 70-horsepower Daimler, Bendemann.....	4.29	1.01	.094	.626			6.020	.505	.047	2.76	5.52	11.540
4-cylinder 100-horsepower Daimler, Bendemann.....	4.29	.988	.080	.626			5.984	.494	.040	2.67	5.34	11.324
4-cylinder 70-horsepower Daimler, Bendemann.....	4.74	1.006	.062	.626			6.434	.503	.031	2.67	5.34	11.744
6-cylinder 100-horsepower Daimler, Bendemann.....	4.60	1.056	.062	.626			6.344	.528	.031	2.99	5.99	12.33
4-cylinder 60-horsepower Daimler, Bendemann.....	4.89	1.002	.058	.626			6.576	.501	.029	2.65	5.30	11.876
4-cylinder 65 horsepower Daimler, Bendemann.....	5.09	.998	.120	.626			6.834	.499	.060	2.79	5.59	12.424
4-cylinder 95-horsepower N. A. G., Bendemann.....	4.33	.970	.076	.626			6.002	.485	.038	2.61	5.23	11.232
4-cylinder 55-horsepower N. A. G., Bendemann.....	4.36	1.038	.018	.626			6.042	.519	.009	2.64	5.28	11.322
4-cylinder 95-horsepower Argus, Bendemann.....	3.77	1.060	.178	.626			5.642	.534	.089	3.11	6.23	11.872
4-cylinder 70-horsepower Argus, Bendemann.....	4.38	1.176	.166	.626			6.34	.588	.083	3.35	6.71	13.058
6-cylinder 100-horsepower Argus, Bendemann.....	4.60	1.172	.134	.626			6.532	.586	.067	3.76	6.531	13.064
6-cylinder 100-horsepower Mulag, Bendemann.....	5.14	1.056	.042	.626			6.864	.528	.021	2.74	5.49	12.354
6-cylinder 90-horsepower Schröter, Bendemann.....	4.65	1.242	.094	.626			6.612	.621	.047	3.34	6.68	13.292
6-cylinder 125-horsepower (Hall-Scott makers).....	4.32			.51	.32			.60	.03			
Average of 6, British (Anzani, maker).....	3.7							.54	.164			
6-cylinder 87-horsepower (Benz, maker).....	4.0				.138	.101		.557	.022			
6-cylinder 60-horsepower (Wright, maker).....	5.1							.53				
Austro-Daimler "Flight".....				{.616 .589 .474}								
Green, Alexander test.....	5.48	.65	.15	.76	.56		7.60	.59	.175	7.65	15.25	
Gnome, 1913, Lumet.....							3.366	.849	.255	5.520	11.04	14.41
Gnome, 1911, Lumet.....							2.88	.805	.253	10.58	13.46	

¹ 20 per cent of fuel weight
² 20 per cent of oil weight.
³ In 65 horsepower.

⁴ In 90 horsepower.
⁵ In 130 horsepower.

NOTE.—Plant weights are given without muffler.

Typical arrangements of cylinders, pistons, jackets, frames, crank shafts, valves, valve gear, and typical structural forms of each, have been produced in great variety and in considerable numbers. Of these a fair number have received more or less development work, but the majority of them must be regarded as hardly more than interesting proposals, or experiments in need of development work to definitely reject or retain them for use. Features of detail will be treated later in the course of the analysis of the engine after a review of the types classified by general arrangement.

Most of the engines operate on the four-stroke cycle, though the two-cycle system is represented, both air and water cooling is used, and of the air-cooled class there are representatives of self-cooling by rotation of cylinders, by fan circulation and by propeller blast, or

free air currents over fixed cylinders. All engines are multicylinder, four or more, and generally more, and while nearly all use horizontal shafts with direct or spur-gear propeller drive, the vertical shaft with bevel-gear drive of propeller is represented.

These types, classified by cylinder and crank arrangement, are as follows:

1. Automobile type, four or more cylinders in line, each with its own crank, cylinder heads up. Air or water cooled.
2. V type, two rows of cylinders of four or more each, inclined to each other, one crank for each V pair of cylinders. Air or water cooled.
3. Radial star rotating cylinders, with crank shaft fixed, or rotating in the same or opposite direction. Air cooled only.
4. Special arrangement or combinations of the preceding.

Of these classes the first three are the most typical of the aero engine art in point of numbers of representatives, amount of development work done on them, and of standing in the engine-building industries of the firms represented, as will be seen from the following list of names of engines and makers, Table III, arranged under each class heading. This is not to be regarded, however, as a criticism of any of the other classes.

TABLE III.—Aero engines by classes.

		Class No.		I.		II.		III.		IV.									
		Cylinder crank arrangement.																	
Fixed in line.		Fixed V, 2 cylinders per crank.		Rotary.		Fixed star.		Miscellaneous.											
Cooling.																			
Water.		Air.		Water.		Air.		Water.		Air.									
Engine or maker.																			
Benz.		De Dion Bouton.		Curtiss.		B. M. & F. W.		Anzani.		Two-cycle aviator.									
Num-ber of cylin-ders.	Revo-lutions per min-ute.	Hor-se-power.	Num-ber of cylin-ders.	Revo-lutions per min-ute.	Hor-se-power.	Num-ber of cylin-ders.	Revo-lutions per min-ute.	Hor-se-power.	Num-ber of cylin-ders.	Revo-lutions per min-ute.	Hor-se-power.								
4	1,288	80	8	1,800	75 100 160	8 8 8	1,100 1,250 1,100	37.5	7	1,031	25 30 40	3 3 6	1,250	80	6	1,300	105	12	1,800
Daimler.		Renault.		Sturtevant.		Gyro.		Anzani.		Salmson.									
88.9	6	1,387	70	8	1,800	140	2,000	38.8	7	984	50 60 70	6 10 10	1,250	90 135 200	7 9 14	1,250

Daimler.		Clerget.		Gnome.		Edelweiss.	
103.1	6 1,315	200 8 1,300	{ 100 9 } 1,200 100 14 } 160 14 }	{ 75 6 } 1,350 125 10 } 1,350			
Daimler.		Laviator.		Gnome.			
60	4 1,396	{ 80 8 1,200 } 120 8 1,200 }	{ 200 18 } 1,200 80 7 } 100 9 }				
Daimler.		Panhard-Levassor.		D'Hénain.			
66.5	4 1,391	100 8 1,500	50 7				
N. A. G.		Wolsley.		Clerget.			
95.7	4 1,344	130 8 1,200	{ 50 7 } 1,180 80 7 } 1,180				
N. A. G.				Demont.			
55.8	4 1,408		300 6 2,000				
Argus.				E. J. C.			
96.7	4 1,368		60 6 2,000				
Argus.				Esselbé.			
71.0	4 1,342		65 7 1,250				

CLASS 1.—*Automobile class.*

Water cooled: American— Hall-Scott. Sturtevant. Wright. German and Austrian— Mercedes (Daimler). Austro Daimler. Benz. N. A. G. Argus. Mulag.	Water cooled—Continued. German and Austrian—Continued. Schroeter. Basse & Selve. Flugwerke Deutschland. French— Clerget. Chenu. British— Argyll. Green.
--	---

CLASS 2 V.

Water cooled: American— Curtiss. Sturtevant. Ransenberg. Maximotor. French— Panhard-Levassor. Clerget. Laviator.	Water cooled—Continued. British— Sunbeam-Coatalen. Wolseley. Air cooled: French— Renault. De Dion-Bouton. British—Wolseley.
---	---

CLASS 3.—*Radial start rotating air cooled.*

American: Frederickson. German: Kruk. Hirch. R. E. P. B. M. & F. W. French: Gnome. Clerget.	French—Continued. Canda. Burlat. Helium star. Demont. D'Henain. E. J. C. Esselle. S. H. K.
---	--

CLASS 4.—*Specials.*

Radial star-fixed cylinders: French— Salmson, water cooled. Laviator, two cycle. Opposed fixed cylinders: American—Ashmusen.	Squirrel-cage cylinders: French—Edelweiss. Radial fan: French—Anzani. Inverted automobile: German—Daimler.
---	---

Many engines appearing in older lists are omitted, because of the belief that they are now superseded or abandoned, and likewise, some new engines now in existence are not mentioned because of lack of general acceptance as commercial. It may be, and is quite likely, that errors have been committed in these insertions and omissions, but this is inevitable without personal visits to the engine shops, which, in the present instance, were quite impossible.

REPORT No. 7.

PART 2.

AERO ENGINES ANALYZED WITH REFERENCE TO ELEMENTS OF PROCESS OR FUNCTION, ARRANGEMENT, FORM, PROPORTION AND MATERIALS, AND THEIR BEARING ON THE POWER-WEIGHT RATIO, RELIABILITY AND ADAPTABILITY FACTORS.

By CHARLES E. LUCKE.

Part 2 (a).—AERO ENGINE PROCESSES AND FUNCTIONS OF PARTS VERSUS POWER-WEIGHT RATIO, RELIABILITY, AND ADAPTABILITY FACTORS.

In any machine the process is of superior importance to the mechanism as the latter is but one of many possible means for the execution of the former, and however necessary it may be to have the mechanism adapted in form, proportion, arrangement, and materials, to its objective process, success of the machine is fundamentally dependent on the process itself. Most machine processes are really combinations of a series of separate individual process steps working together, just as the mechanism parts themselves coact, and these processes are commonly said to be similar when they consist of the same partial steps executed in the same order as a series, and machines executing them are regarded as belonging to the same class, or as similar machines. There are, however, very great differences to be found in these similar machines which, therefore, may be vastly dissimilar from other standpoints. In the first place the process steps may differ widely in degree though being identical in kind, and this difference in degree may be in turn responsible for very considerable differences in mechanism. No better illustration is available than the common piston steam engine in which one basic step is expansion of steam after admission and before exhaust, yet experience has developed a whole succession of valves and valve gears, some adapted to moderate and others to high expansion ratios, while expansion to pressures below atmosphere immediately calls for the condenser with its elaborate series of auxiliary appliances and pumps. Differences in mechanism may be almost infinite even though the same process is executed, and to the same degree, and the steam engine will again serve as an illustration. Such differences may be significant or not. They must be regarded as significant when some good purpose is served whether the differences are those of detail parts form such as the shape of a piston; of arrangement of the same typical parts, such as the locomotive engine as compared with that of the steamship; of proportion of parts, as diameter of cylinder or thickness of wall; or of material. Such differences as are now accepted and well

understood in the steam-engine field can all be analyzed into significant or indifferent from the standpoint of service requirements. These service requirements require years of experience to be appreciated to a degree that permits of a reduction to standards of practice in arrangement, form, proportions, and materials of the mechanism and its parts. Even after the establishment of such experience standards of practice for machines performing a definite fixed service there will always remain very considerable differences of the indifferent or nonessential order.

Aero engines, while belonging to the now large and established class of internal-combustion engines, and to the smaller fairly well-developed subclass of the gasoline carburetor internal-combustion engine, in which the farm, automobile, and boat types are most fully developed, are themselves still struggling through the development stage, due to the youth of the special service to be performed, and in spite of all that might be borrowed from the older most similar arts. In fact there is some evidence that these older arts have exerted a distinct retarding influence even where assistance might be expected, because borrowing is the easiest mode of acquisition. It is not unnatural to find automobile practice being adopted for aero engines, when it is not yet clear that there is anything required of the aero engine sufficiently different from what the automobile or boat engine can supply, to make the latter unsuitable for the service of the former. At the same time there is equally strong evidence that in some respect the differences in service requirements have been exaggerated or misinterpreted with the result that totally different engines were produced unlike anything before built, and yet just as unsuitable as the borrowed auto or boat engine.

In proportion as service requirements on the one hand become better understood, and as engine capabilities or limitations, on the other hand, are recognized and utilized, so will the aero engine as a type come into full growth. Review of the engines so far proposed, built, and tried out, indicates a strong trend in some directions, but just as surely proves that in most essentials the period of blind grasping at every possibility whether rationally defensible or not, has not yet come to an end. The most hopeful sign of progress is the now general recognition that no older type of engine can be borrowed bodily for aero service, and following this, the large number of suggestions for modification that have been and are now being made, some rational, derived through reasoning from fact data, but often without any recommendation other than mere purposeless difference.

Most of the rational development so far accomplished has been devoted to forms of the type parts, to their grouping or general arrangement, and to special materials for their construction, rather than to the processes that are fundamental to the gasoline carburetor type of internal combustion engine. Aero-engine designers being so intensely absorbed in the problems of arrangement of parts, adaptation of form of parts, reduction of metal thickness and application of materials of high elastic limit or low specific gravity, have in some instances, though fortunately not all, been diverted from thought of the process steps to be executed, in kind and degree. This becomes clear by comparisons, first of aero engines with each other and second of any one engine with the absolute standards of thermodynamics.

It is clear that if at the same speed and using the same fuel one engine gives a materially higher mean effective pressure than another, or a lower specific fuel consumption, then some elements of the thermodynamic process have been violated by the mechanism of the inferior machine. It is also true that if the thermal efficiency obtained is a smaller fraction of the thermodynamic limit of possibility than in an auto engine, for example, then again something has been incorporated in the aero-engine structure inferior to its counterpart of the auto engine structure. To a lesser degree similarly, if aero-engine stoppages not due to seizure of bearings or breakage of parts are more frequent than in auto engines, or even if they stop at all under these conditions, then the process requirements are in some way being violated by unsuitable mechanism, for if they were not the engine would continue to run, and without change. As a matter of fact, the whole question of reliability is one of maintenance or continuity of the process in every stage, assuming, of course, an absence of the pure mechanism troubles of breakages or bearing failures. Likewise, some of the elements of the adaptability factor, as well as those of reliability or of high power and fuel efficiency, are concerned with the process, for, should excessive tilting of the engine interfere with the carburetor action and result in poor mixtures, or should passage through a cloud or fog obstruct the intake with frost or ice, or should flights at excessive altitudes change the mixture, then the engine becomes inoperative by reason of process interference due to lack of adaptability of the mechanism to the maintenance of the process when subjected to the ordinary interference of actual use peculiar to air flight.

Proper execution of the processes by mechanism that insures its continuity in kind, and the constancy of every step, in degree, regardless of any interfering conditions incident to normal or even extraordinary aerial use, is a necessary prerequisite to the high mean effective pressure and high thermal efficiency that together make for low power plant weight per horsepower for any length of flight. It is just as essential to the continuity of operation and output that constitutes reliability, entirely independent of whatever contribution may be obtained to the same end, from variation of general arrangement, and detail design of parts as to form or thickness or from the selection of special materials.

The processes are comparatively simple and easy to state, though a thorough analysis of the relative or absolute perfection of execution that various designers have accomplished through their mechanism would require far more space than is available here. Such an analysis must moreover be based on far more test data than have even been made available anywhere. Judging from the literature of the subject and from some familiarity with general practices not so recorded, it can be stated that practically no work has been done except by a few large engine building concerns who keep their results secret, and comparatively speaking, no data obtained bearing directly on the execution of the process steps, and the effect of design on process, for aero engines, though some interpretation can be based on the few overall results of engine tests. While the details of design versus process are beyond the scope of this report, it is possible even from a statement of the processes and their fulfillment conditions, to derive some general specifications for the parts of the apparatus that, taken

together, make up the power generating part of the engine, as distinguished from those parts that merely transmit or support.

As the working medium is primarily an explosive mixture of air and the vapor of gasoline, the first broad process step is mixture making, preparatory to introduction into the cylinder unless it be made directly therein. This must be followed by the second step of suitable treatment of the mixture in the cylinder, including expulsion of burnt products. Finally, as combustion develops heat in contact with metal walls, continuity of operation or the maintenance of a steady state in all respects requires heat abstraction and dissipation to a degree and at a rate equal to that of heat reception, so the third broad process step is cooling.

Each of these three broad divisions of the general power generating process, mixture-making, cylinder treatment of mixture, and combustion chamber cooling is itself a process, and is in turn subdivisible into more detailed or subprocesses, each definable to some extent as to degree or range that it is desirable to maintain.

The mixture-making process starts at the point of supply of gasoline and air and ends at the intake port of each cylinder. The one exception to this used in a few engines is the making of mixture directly in the cylinder by pump injection of gasoline, a method so wholly unsuited to the small cylinder high-speed engine, with such volatile fuel as gasoline, as to be rejected without further discussion not only on rational grounds but on actual comparative experience with the now standard system of mixture making. This standard practice that has taken many years to establish recognizes mixture-making as a distinct function to be carried out external to the cylinders, so as to permit of some control of this independent function without the interference that must result when it is combined with others in a single apparatus part.

Applying the common but more or less inaccurate name of carburetion, to this mixture-making function because the principal structural element of the process is the carburetor mechanism, the process divides itself into (a) fuel supply; (b) air supply; (c) carburetion proper, which includes proportioning, mixing, and vaporizing, and (d) mixture distribution to cylinders. Each of these steps must be carried out without variation in spite of anything that might happen beyond extraordinary accidents, and the apparatus, mechanism, or equipment must be so constructed as to insure the results desired. This is by no means easy, as will appear from even a superficial analysis of conditions and possibilities. Air must be taken from the atmosphere through which the machine is moving at a high, though not constant speed, a speed so high that the air pressure equivalent to the velocity, or velocity head of the air, is quite appreciable. With the air intake opening pointing in the direction of travel the velocity head is added to the static pressure of the air and air flow necessarily varies with flight speed, though it should not. This might be avoided by suitably shaped entrance orifice, the plane of which is in the direction of flight, but this is no safeguard when turning or in side gusts. The first requirement of air intake must, therefore, be independence of flow of air with reference to direction and speed of motion. Atmospheric air varies in absolute pressure with altitude and likewise varies in temperature, in water vaporized, and suspended water such as fog or rain. Each of these things exerts separately and together an

influence on carburetion. Temperature, pressure, and moisture affect air density and hence the flow through the air orifice under a given pressure drop. Temperature affects the vapor pressure of the gasoline. (Absolute pressure affects air flow itself independent of the density change.) Vaporized moisture affects the accumulation of water in the mixture passages due to reduction of temperature incident to gasoline vaporization, and both vaporized and suspended moisture affect the accumulation of ice in the mixture passages, unless heat be added in sufficient degree. These things need hardly be stated to be accepted as fundamentally important and as necessary elements for incorporation directly or indirectly into specifications for the air supply to the carburetor. The carburetor action should be made quite independent of these variables and it must be sufficiently independent to prevent changes of mixture quality beyond the allowable working range. Therefore, however great a variation may be encountered during actual flight, in direction and velocity of flight or wind, in barometric pressure, in atmospheric temperature, in atmospheric moisture vaporized or suspended as well, the mixture quality must be kept within the two limits to be determined as necessary to continued engine performance.

Gasoline must be carried in a closed tank and must be fed to the carburetor through a pipe, and the supply to the carburetor should be quite independent of the direction and angle of inclination of the whole structure. It positively must be unaffected by such changes of relative position of tank and carburetor, as may be due to not only ordinary but even extraordinary or emergency turning, gliding, climbing, or temporary falling movements of the whole machine. If the machine should completely fall and upset, the gasoline should be prevented from running out on the hot exhaust pipe as this is likely to cause a fire. Gravity feed from tank to carburetor is affected, as to head, by every variation in angle and direction of inclination of the frame. Gravity feed tanks must have an air vent and so if overturned the vent becomes a spill hole unless a special check feature be added. In stationary plants gravity feed from supply tanks is forbidden by the fire underwriters' regulations because of the possibility of drainage of the whole tank due to a leak in any part of the pipe system. Air or gas derivable from fire-charged bottles, from pumps, from combustion chamber relief valves, or from exhaust back pressure acting on the liquid surface in depressed gasoline tanks will feed the gasoline from any relative position of tank and carburetor. If reasonably high pressures are used in comparison with the normal static gasoline head, the delivery pressure will be substantially constant at all inclination angles and spilling will be confined to the small carburetor float chamber as the main tank is closed. This system is in quite general use in auto practice. Pump feed from a main depressed tank with air vent to a small auxiliary gravity tank with overflow return directly above the carburetor, is the standard stationary system. Recently automobile practice has adapted this to its service requirements, replacing the pump and overflow return by a vacuum lift system operated from the suction header beyond the throttle, but retaining the depressed main tank with air vent and the small auxiliary gravity tank without air vent, which being so close to the carburetor can supply it at all times at substantially constant head. These two systems of pump and suction header lift may be operated

with a closed main tank if slightly modified and in the event of a leaky pipe no loss or fire can occur because instead of gasoline escaping air flows in, doing no harm if the leak is small, but stopping the supply without loss if the leak is large.

The extraordinary changes of motion in direction and speed, both horizontally and vertically, peculiar to the aeroplane introduce liquid inertia and centrifugal pressures which may accelerate or retard gasoline flow by raising or lowering the pressure at the point of delivery to the carburetor. This is a peculiarity of the aero-engine service conditions which requires special attention. To cover all these influences an additional specification may be added for the carburation system; the fuel tank, piping, and supply system must deliver fuel to the carburetor at pressures that do not vary enough to cause the mixture quality to vary beyond the limits required for the proper steady operation of the engine regardless of angularity of the machine or of changes of its motion as to direction or velocity, and they must be such as to prevent fuel loss from small leaks and to minimize any spilling when overturned, preventing whatever spills touching hot parts or reaching electric sparks. References to the literature are made for actual tank arrangements which require no comment here except the approval of the practice of using more than one tank and especially of installing a small emergency reserve tank holding enough to insure a safe landing after main tanks are empty.

When supplied with atmospheric air and with fuel under pressure or static head, the carburetor mechanism is supposed to make a proper explosive mixture and through intake header and branches to deliver to each of the several inlet valves identical charges of that mixture equal in quality and quantity. This is supposed to happen regardless of the total quantity of mixture required by the engine load or speed and regardless of any variation in air temperature, pressure, moisture, direction, and velocity of flight or fuel delivery pressure. The possibilities of success in attaining this mixture-making ideal must, of course, depend on the definition of proper mixture, for in this is to be found the allowable range of variation from absolute constancy of quality.

Mixtures that enter the cylinder with too much gasoline for the air to support in combustion will not be explosive if the vaporized fuel excess is large enough and with such mixtures the engine is inoperative. Long before such a great fuel excess as this is reached the engine may be operative yet operate badly. It is clear that any excess vaporized gasoline in the mixture can not burn, so it will decompose or carbonize, depositing carbon all over the combustion chamber, including spark plugs and piston head, and show in exhaust as smoke. Such a mixture will be operative for a time, such time as it takes for the carbon to accumulate in layers thick enough to glow on hot spots, such as piston heads, causing back fires or preignition and possibly short circuits and miss fires from collections on spark plugs if they are so designed as not to be self-cleaning. Carbon deposits will also cause piston rings to stick and leak and impair lubrication when it collects on cylinder walls and between rings. To be sure, a certain amount of just such carbonization can be traced to lubricating oil that works past pistons, but this is an independent matter to be separately treated by oil selection and supply system. Excess fuel in the liquid state may be present when the vaporized

part and the air make a proper mixture, and such excess will partly decompose as above, but part will be dissolved by the lubricating oil and defeat lubrication besides being a dead loss.

Excess vaporized gasoline in the mixture should be prevented, first, to prevent carbonization, but also to avoid the slow combustion that results when the excess is too great. A small excess gives the highest rate of combustion and high rates of combustion are necessary in aero engines to permit of attaining the highest initial cylinder pressures with the very high mean piston speeds in use, none of which are below 1,000 and some in excess of 2,000 feet per minute. By use of properly high compression and more than a single point of ignition a sufficiently high rate of combustion appears to be obtainable without resorting to such overrich mixtures with their carbonizing evils and direct waste of fuel. It may therefore be set down as a requirement that mixtures preferably should not contain any excess fuel at any speed and load, and positively must not contain enough to cause carbon accumulation, measurable fuel waste, or interfere with lubrication.

It goes almost without saying that mixtures of air and fuel must be homogeneous and uniform throughout; that is, the constituents must really be mixed. On reaching the cylinder at least, no liquid should remain unvaporized, or, to use a short word, the mixture should be dry. A correct overall ratio of gasoline to air by weight as required for combustion reaction will not serve the purpose if the gasoline is in liquid form, or even if it is vaporized, but all concentrated in one corner of the combustion chamber with pure air in some other corner, such as is sure to happen with direct injection or with more unvaporized liquid admitted past the inlet valve than can be vaporized while entering. Such nonhomogeneous and wet mixtures will both carbonize and cut lubrication even if total weights are correctly related, so the second and third requirements of mixture must be homogeneity, and dryness at least after admission.

Other things being equal, a cool mixture carries more heat per cubic foot and hence more work capacity than a hot mixture of the same fuel and air. But with liquid fuel, mixtures that are too cold are no mixtures at all, any more than a brook running through the country can be said to be mixed with the atmosphere, though rain by a stretch of the imagination might be, and a fog really is, though not so intimate a mixture as vaporized moisture. Any gasoline-air, kerosene-air, benzol-air, or alcohol-air mixture, in combining proportions may be dried if the temperature be high enough and the temperature required will be least for the fuels of greatest vapor pressure of their heaviest constituent if they are solutions of heavy and light parts, as is the case with the petroleum distillates. For any one fuel the required drying temperature is least the more intimately the air and fuel are mingled or stirred, so that any fuel particle will be required to exert only the partial pressure of the vapor in the final mixture, instead of the full mixture pressure of one atmosphere that is necessary without true mixing. Mixtures should, therefore, be as cool as possible consistent with dryness and the maximum permissible moisture is that which will vaporize on entrance. The higher the mixture pressure the greater the work capacity of the charge, so that everything that contributes to such must be promoted as much as the preparation of cool and otherwise proper

mixtures. This means in effect that the pressure drop between the air and the cylinder must be a minimum, but this is entirely a question of proportions of passages.

Finally with reference to mixture quality there can not be much excess air, preferably none. Of course, excess air can not cause carbonization or lubrication trouble; in fact, it exerts a beneficial influence tending to burn accumulated hot carbon or lubricating oil vapor, and it permits of a somewhat higher compression which improves economy. But all the explosive mixtures of hydrocarbon vapors and air become nonexplosive in ratios very close to the combining proportions on the excess-air side, and with even a slight air excess the rate of combustion becomes prohibitively low. Summarizing mixture-quality requirements, a mixture is proper when it has the least and preferably no excess of either air or fuel, when it is homogeneous, when it is dry after entrance and as cool as possibly consistent with homogeneity and dryness, and when it is supplied at the maximum absolute pressure. To produce such mixtures is the function of the carburetor.

Carburetor mechanisms capable of making mixtures of such specified quality under the previously noted conditions of air and fuel supply are practically nonexistent at present, and improvement can hardly be expected so long as carburetor production remains a separate business, and purchasers buy on name instead of on performance, as is the practice, selling on name only, at present in the motor-car and motor-boat industries. Not until the aero-engine producer develops carburetor specifications in terms of mixtures produced and testing appliances to prove fulfillment and to locate causes of nonfulfillment of each separate requirement can the needed mixture-making carburetor be obtained. Under these conditions it matters very little whether the aero-engine builder makes his own, or buys on guaranty of performance, independent of engine operation.

Very great progress has been made in recent years in carburetor design for automobile and marine engines, but the end has not been reached, because all data point to a failure to maintain the quality of mixture in all the specified respects. In some respects the problem is less difficult with the aero engine than with the auto, as the former is not subjected to as wide a range of flow rates nor to such sudden and frequent changes in flow rates as are the latter, due to automobile driving in dense traffic or over country roads with constant changes of grade, curves, and rough spots requiring continuous opening and closing of the throttle. This fact is responsible for the general practice among aero engine builders of buying stock automobile carburetors on the theory that, the service being less severe, they should work better on aero service; yet such a conclusion is not warranted. While it is true that flow rate fluctuations will not be so great and so cause less variation in proportions, it is also true that the normal condition of flying with feed throttle wide open or nearly so produces a more intensive temperature drop, reducing vapor pressure and decreasing the degree of gasoline vaporization or increasing mixture wetness and condensing or freezing more water. It is also true that far stronger variations of fuel and air supply conditions must be encountered in air flight than in road driving. What is still more significant, however, is the fact that the aviator has no such opportunity to make hand adjustments as has the chauffeur, nor are the

consequences of auto-engine stoppage due to bad mixture hardly more than annoyance, while such a stoppage of an aero engine may mean a complete wreck. It can not be too strongly stated that acceptance for use of standard carburetors on their names, or even reputation, is not a satisfactory practice for aero engines. They should be designed or purchased to specifications of maintenance of mixture quality under all variations of working conditions within possible ranges to be met with in service.

There seems to be no doubt after the years of experience in carburetor construction for automobiles and boats that the gasoline float chamber apparatus, with simultaneous vacuum flow of gasoline and of atmospheric air, is permanently established and must be retained. Adhering to this principle of construction as the basis of proportioning and of the first step in mixing, does not prevent the addition of other elements to correct the faults inherent in the simple combination. Mixture proportioning correctors in the form of compensators to reduce the natural tendency for gasoline to flow in excess at high rates of vacuum when the ratio is correct for low, are now available in considerable variety and some are fairly good, though even in the best there is considerable room for improvement. These compensators constitute the principal differences between modern carburetors.

It is in control of mixture quality in other respects than proportioning that carburetors now available are lacking; for example, to render the mixture quality independent of atmospheric changes, fuel supply, pressure fluctuations, and above all independent of their own cooling action. This self-cooling is due to vaporization of gasoline, the latent heat for which lowers the temperature of the mixture below that of the entering air. Heat must be supplied if liquids are to be vaporized, and no amount of human ingenuity can overcome this law of physics. If the latent heat of vaporization be supplied from waste heat sources for so much of the gasoline as can vaporize in its air supplied at atmospheric temperature, then the resulting mixture will have the same temperature as the atmosphere and there will be neither vapor condensation nor water freezing on the intakes. Such mixtures especially when the air is cool are not sufficiently dry and certainly are variably dry, dryness varying with atmospheric temperature. To produce even this much effect requires a considerable amount of heat from either hot jacket water or exhaust gases. To get this amount of heat into the entering air or the mixture it is necessary to observe the laws of heat transmission and provide sufficient heating surface of suitable form. To simply surround the body of the carburetor with a water jacket or to take the air from a short exhaust-pipe jacket, which are the only means now in general use, is entirely inadequate, as can be proved by simply taking the mixture temperature by a thermometer in the intake pipe or by observing the flow through experimental glass headers and branches. Of course such wall heaters will prevent any adhering frost, but they can not prevent its formation as free snow to be drawn into the cylinders. This problem of mixture making by carburetors is one of the most important of all the elements of the aero engine structure and the carburetor proper its most important apparatus, on which much work has been done, but more remains, especially of the adaptation order.

(In this connection the paper by Dr. Karl Buchner on carburetion, which is one of the best, is reproduced in full in the appendix.)

Distribution of the mixture from the carburetor to the cylinder inlet valves without change of quality in transit, and in such a way as to insure a supply of mixture of equal quality to each cylinder, is a problem of equal importance to that of correct mixture making and is intimately associated with it. If the carburetor should yield correctly proportioned mixed and completely dry mixtures, this distribution header problem disappears, and any form of branch pipe will serve the purpose in place of the long elaborately curved headers now in use. Such mixtures are too warm to develop the maximum possible mean effective pressure. To get the greatest power output per cubic foot of piston displacement per minute requires a temperature lower than corresponds to complete dryness, probably corresponding to just such quantity of moisture as can be evaporated during entrance through the inlet valve and, therefore, the aero engine header may be expected to carry some moisture.

Such mixtures have a tendency to separate the liquid, which resists division equally among the branches, and where vertical flow must take place there is a tendency for the liquid, which always flows along the walls to drop back by gravity, to accumulate, and then suddenly carry over as a wave, causing a miss, especially at low-engine capacity. To prevent lagging of liquid, vertical pipes must be made so small as to produce skin friction forces superior to gravity at the lowest flow rates. If this is done then, at high flow rates, a considerable drop in pressure with consequent loss of power will result, unless, as is often the case, the carburetor is located at the highest point and the liquid allowed to drain downhill with the mixture current in large pipes. On reaching a bend the liquid flowing along the side walls always collects on the inside as the air stream impinges on the outside, while at a Y or branch the liquid may choose almost any path and is quite beyond control, for wherever the mixture velocity is locally least then the liquid concentrates and this point is constantly changing. The best that can be done is to use long-radius bends and flow paths to each cylinder of approximately equal length and curvature, but this gives no assurance of equal distribution of liquid. The frequent use of two carburetors on six cylinders in line and eight cylinders V engines is evidence of an effort to reduce this trouble.

The only absolutely reliable way to avoid these special headers and the irregular engine action that results in two cylinders never doing quite the same work or remaining equally clean, is to completely dry the mixture by raising its temperature, accepting the higher temperature and lowered mean effective pressure in the interests of cleanly, steady, operation, securing shorter simplified headers and possibly making up lost output by a small increase in cylinder diameter or by raising the mixture pressure by blowers. There really seems to be considerable reason for the use of blower-supplied air for carburetors other than to compensate for loss of density when mixtures are warmed to dryness, which heating incidentally renders the engine more independent of variations of fuel quality than it now is. By suitable regulators the air blast can be controlled so as to give always the same absolute pressure at the carburetor intake, regardless of barometer or flight speed and direction. With such an

auxiliary blower and pressure regulator, the friction effect of intake ports and small-diameter low-lift valves, while remaining a direct engine resistance, will have no effect whatever on the weight of charge per stroke and the mean effective pressures. Other things being equal, an initial pressure in the cylinder of 16, as compared with 14 pounds per square inch absolute, an increase of 2 pounds should increase the mean effective pressure and power one-seventh, over 14 per cent, while adding only 2 per cent additional load (if the mean effective pressure were 100 pounds), a net power gain of over 12 per cent if the blower be efficient. The use of such blowers is not unknown in two-cycle engines, though four-cycle engines have not employed them as yet, and the N. E. C. (New Engine Co.) two-cycle engine is so equipped, the blower in this case taking the place of a piston as a precompressor to prepare the charge for entrance into the motor cylinder when the port uncovers.

All two-cycle engines and all rotating cylinder four-cycle engines with inlet valves in pistons have mixture quality and supply conditions somewhat different from those of the four-cycle fixed-cylinder engines, and among the latter the air-cooled differs somewhat from the water-cooled group. The cylinder heads of four-cycle air-cooled engines are normally hotter than those that are water cooled, so that the mixture entering will receive more heat and may, therefore, be more wet as supplied, provided distribution from the carbureter is not a disturbing element, as, for example, if each cylinder had its own separate carbureter. If cylinders are not too large and the air cooling is vigorous it is possible to get the walls of the air-cooled cylinder quite as cool as the water-cooled one but only with excessive power consumption for air circulation, the Renault, for example, taking 8 per cent of its output for only such cooling as is normally provided. Most of the rotating-cylinder four-cycle engines with inlet valves in the pistons, including the Gnome, for example, take their mixtures into the crank case at the shaft center. In this crank-case chamber, which is rapidly whirling, with pistons churning up and down at the same time, a most vigorous stirring and heating action takes place. It would be hard to conceive of a better mixture conditioning apparatus than this Gnome crank case, provided there were some means of control of the temperature of the mixture, which in this case undoubtedly gets too warm, though dryness and homogeneity are practically perfect. Finally, two-cycle engines take the mixture from the carbureter into an auxiliary chamber for precompression, located in the crank case as the most favorable arrangement, or in a trunk enlargement of the main piston and cylinder preferably, as, for example, in the Laviator engine. While, of course, this precompression mixture has the evil effect of imposing negative work, equivalent to engine friction, it is highly beneficial as to mixture quality when the precompression chamber is so located, as is usually the case, as to get and stay warm, because in this case the chamber is at once a mixture stirrer and heating dryer, heating partly by wall contact and partly by compression.

Mixture treatment in the cylinder after it has been made and delivered to the intake port, begins with actual entrance and proceeds along different lines in the two and four cycle engine, in some respects. Nearly all aero engines are four-cycle engines, and these take the mixture in through a suction valve under the influence of

the lowered cylinder pressure maintained by the piston outstroke. This admission should be accomplished with the least possible loss of pressure and rise of temperature. Loss of pressure imposes direct negative fluid friction work, the extent of which is measured by the velocity of flow through the valve, and the shape of the opening, but even with small valves and badly shaped openings or ports, this loss may be, but not often is, very serious. Two pounds per square inch would be large and with mean pressures approaching 100 pounds it would be equivalent to a little over 2 per cent. However small it may be, it can be controlled by valve and port dimensions and these, because of the high speed of aero engines, must be given far more attention than in any other class. It is the terminal pressure at the end of the suction that is one of the determining factors in the weight of the charge, each pound per square inch accounting for about 7 per cent loss of power. Since inertia of the incoming stream tends to build up the terminal pressure over the mean suction pressure, if valve closure is delayed the right amount, the value is so great that care must be exercised to secure it, and Winkler recommends a closure 40° after dead center. This delayed inlet valve closure can be secured only by mechanical inlet valves which also give best control over the mean suction resistance, so that under no consideration should automatic inlet valves be employed, as they have been, to save valve gear weight, because more power is lost than would compensate for this weight. Charge density at the end of suction is just as much a matter of temperature as of pressure, a rise of about 500° F. on entrance accounting of itself for about a 50 per cent reduction of charge weight and hence of power output, or approximately 1 per cent for every 10° rise, with the probability that the rise averages in well-cooled engines somewhere about 200° , or 20 per cent, and in the less well-cooled ones over 300° , or 30 per cent, in general round numbers.

Reduction of suction heating is partly a question of arrangement and partly of wall cooling but to some extent depends on the temperature of the hot gases left in the clearance after the previous explosion. As to arrangement, head valves discharging mixture directly into the cylinder seem to be more rational than side-pocket valves, though no data are available to prove that the former results in less suction heating than the latter. It also seems likely that air-cooled heads and valve chambers unless vigorously air blasted and of small chamber should heat the mixture more than water-cooled ones, but no one has ever determined how small a diameter can be equally well cooled by air and water nor how much air is needed. Nor can it be said how much of the total suction heating is due to exhaust gas mixture in the clearance with the fresh incoming charge. It is interesting to note that the air-cooled radial fixed cylinder Anzani gave in the tests $99\frac{1}{2}$ pounds square inch effective pressure referred to brake horsepower, as much as most of the water-cooled engines.

Not only is it important that the charge in the cylinder be as cool as possible for the maximum charge density required for high mean pressures, consistent, of course, with complete vaporization, for which 120° F. is enough with gasoline if the mixture is well stirred, but it is perhaps even more important as the controlling factor in the permissible compression. This degree of compression of the charge before

ignition is the prime variable in fuel consumption per horsepower hour and thermal efficiency, as has been demonstrated conclusively both by thermodynamic analysis and experimental data on all classes of internal-combustion engines. The highest compression possible must be obtained at all costs, and since it is the ignition temperature of the mixture that imposes a limit the objective of the engine designer must be to so treat the mixture as to get the maximum compression volume ratio and final pressure before the mixture being compressed reaches the ignition temperature which is a physical constant of the mixture, never accurately determined but probably very close to 935° F. This compression for the best water-cooled engine has been found to be about 5 to 1 volumes and less for cylinder not so well cooled. Of course, self-ignition before compression is complete will occur if any metal part, such as the exhaust valve or piston head, or a carbon deposit, is overheated, because this will produce a local overheating of the charge in contact with the hot spot before the whole mass has reached the ignition temperature. Prevention of this is a matter of engine cooling and of the internal cleanliness that comes with proper lubrication and carburetion. Assuming such to be properly cared for, the compression permissible with gasoline mixtures is fixed by the initial temperature of the charge. The final temperature varies with the initial in a geometric ratio, as is indicated by the standard equation for adiabatic compression, so a few degrees rise initially results in several times as great a terminal rise.

Charge weight per cubic foot of suction must be a maximum, and so also must the compression, if the mean effective pressure and thermal efficiency are to have the highest possible value, as they should in aero engines. All efforts in this direction may be entirely defeated, however, if there is any material leakage of the charge during compression through valve seats or past the piston. It is of no value to secure maximum charge weights during suction if appreciable amounts are afterwards lost before the charge has a chance to do any work. Tightness of piston depends on the piston rings, on the oil film between piston and cylinder, and on the maintenance of shape of cylinder and piston, neither of which may warp in any direction. Valve leakage likewise is minimized by providing nonwarping valve disks and seats with strong spring loads to keep the valve tightly against its seat during the first period of compression; at other times the gas pressure itself will suffice. These are questions of form and materials and will be taken up later, but they are mentioned here because a failure means defeat of the results of an otherwise well-executed suction process.

Four-cycle engines, after the suction periods, have their charges directly in the cylinder ready for compression and subsequent ignition. Two-cycle engines must put the charge through the preliminary compression process in a precompression chamber where the mean pressure of precompression must be added to that of suction, the sum of the two subtracted from the mean effective pressure of the compression and expansion strokes to get the net available. Therefore, assuming equal performance of the compression and expansion strokes, the two-cycle engine is charged with more negative work than the four-cycle by the amount of the precompression stroke, assuming equal negative work of suction in each. Suction heating effects on the two-cycle are bound to be less than in the four, because the precompression cylinder is sure to be cooler than the working cylinder

into which the four-cycle charge enters directly, and so also is clearance gas with which the fresh charge mixes, as in the two-cycle case; this is reexpanded fresh charge remaining after discharge, while in the four-cycle it is hot burnt gases. All this two-cycle pump chamber charge will not enter the working cylinder nor remain there, for some will remain in the precompression chamber by reexpansion or failure of the pressure to drop during the open-port charging period to atmosphere. Some will escape through the exhaust port with the exhaust gases during the end of the transfer period when both transfer and exhaust are open, regardless of piston baffles of or special relative positions of inlet and exhaust ports designed for the purpose. During transfer the fresh charge bodily displaces the hot burnt gas that fills the motor cylinder and its clearance, and it is inconceivable that a considerable amount of mingling should not occur with corresponding heating and expansion effects. These mixture-heating effects are added to those of wall-contact heating, which walls in the two-cycle engines are always much hotter than in the four. The net effect is inevitably a discharge of some of the fresh charge with the burnt gases unless special arrangements are made to prevent this, and then each of these introduces its own evil.

Two methods of preventing this fresh charge heating on transfer in two-cycle engines and consequent loss of charge are in use, one is to intentionally reduce the charge transferred to so small a quantity as will not escape, and the other to expel burnt gases by a blast of fresh air, and then to expel this scavenging air which, of course, is cooler than the burnt gas, by the fresh charge. The former means intentionally reduced charge while the latter more than doubles the negative work of precompression which in effect is equivalent. Some part of the compression stroke in any two-cycle engine, so much as is required to cover the exhaust port, must result in further expulsion of charge. Naturally as in four-cycle engines, the charge weight can be built up in two-cycle engines to any value, by sufficient precompression, but to accomplish this the charge must continue to enter after the exhaust port is closed, which requires an admission or transfer valve mechanically operated and suitably timed, an extra complication. This is not common practice and no data are available on it, so for the present it must be regarded as merely an interesting possibility.

In the two cycle engines the net effect of all heat exchanges and pressure changes, incident to charging the main cylinder, is undoubtedly a lower mean effective pressure and thermal efficiency than in four-cycle engines, and for equally good design and construction in each class the two cycle is unable to carry compressions as high as the four, proving higher temperatures before compression. Any engine taking its charge into the crank case, as do most of the rotating cylinder four-cycle machines, or into a chamber connecting with the main piston, as the two-cycle Laviator, is subject to mixture quality impairment and equivalent charge loss, whenever the main piston leaks under its high explosion pressures, by the displacement of the fresh by the burnt gases.

While dealing with charge weights and volumetric efficiency of cylinders, the exhaust stroke of the four-cycle cylinder and the reexpansion stroke of the two-cycle precompression chamber must be considered as controlling by their terminal conditions of pressure

the point of the return or suction stroke at which charging will actually begin. No flow can be started from the intake header until the cylinder pressure is lower. At the end of the four-cycle exhaust stroke the cylinder pressure is higher than atmosphere, and still higher than the mixture-header pressure by the amount of the suction-header vacuum. Suction can not begin until the cylinder clearance volume of gases has expanded enough to lower the cylinder pressure (terminal exhaust valve) to below that of the mixture header. An appreciable part of the suction stroke is therefore useless for actual charging, the loss increasing with higher terminal exhaust pressures and lower suction-header pressures. A similar condition exists in the two-cycle precompression chamber; for there the pressure at the time the transfer to the working cylinder is complete must be something higher than atmosphere, and the higher the speed the more excess there must be, because of the limited time for pressure equalization. This mixture must expand not only to atmosphere, but as much below as the suction header or carbureter vacuum, even with a mechanically operated valve, and still more with the more common spring closed automatic check valve, by the amount of spring tension and valve inertia, before real suction can begin. The clearance in such precompression chambers is large, to limit the maximum precompression pressure to something less than 10 pounds per square inch, and, therefore, the reexpansion line will be very flat, cutting off a considerable part of the stroke as useless before the pressure has dropped sufficiently for suction to start. Many times the loss occurs here, as in four-cycle cylinders with their smaller clearances and steeper reexpansion lines, even with equal pressures at the start.

No separate data are obtainable for aero engines on any one of these quantities concerned with charge weight and the corresponding pressure and temperature changes, nor is there any indication that such information has even been sought. Even the over-all effects, as measured by volumetric efficiency, have apparently not been investigated, though all that is required is a measurement of air and gasoline or exhaust gas and a comparison with the piston displacement, the ratio of volumes constituting the true volumetric efficiency. Other things being equal, the horsepower per cubic foot of displacement per minute should be directly proportional to this volumetric efficiency, so it is a little surprising that the aero interests, which must have the most powerful engine per pound of metal, should have neglected to separately study each of the prime variables. As already noted, more designers seem to have been concerned with reduction of metal volume than with process perfection, though without proper execution of basic processes metal reduction may not only fail to give a light engine, but may even defeat the ultimate object by making the engine as structurally weak as it is weak in mean effective pressure or thermal efficiency. It must not be understood that no good performance results based on proper execution of the processes have been obtained; in fact, there are some most remarkable successes; but, on the other hand, these stand out so strongly as to prove that the procedure that has resulted so successfully is not the rule in the art, and may even in the case of the successful engine be as much a matter of good luck as patient, systematic investigation.

Assuming a good charge weight in the cylinder, or a high volumetric efficiency, the cylinder has at least the capacity for a high mean effective pressure and thermal efficiency, provided the subsequent treatment is proper. This treatment consists in compression with ignition before it is completed; combustion as rapid as possible consistent with absence of shocks; and expansion ending before the end of the stroke, by early opening of the four-cycle engine exhaust valve to drop the pressure to as near atmosphere as possible, at the end, and by uncovering the exhaust port of the two-cycle engine to get the same drop low enough before the end of stroke to allow the fresh charge to enter. It can be shown that both the mean effective pressure and the thermal efficiency will be highest for a given cylinder charge when the combustion starts as late as possible on the compression stroke and is completed as soon as possible on expansion stroke, or, referring to the shape of the indicator card, when the explosive combustion line is practically vertical, leaning, if at all, toward the expansion line than oppositely. Such a condition of affairs results in the Otto gas cycle, the efficiency of which is a function of compression only and the mean effective pressure of which is a function, partly of the compression, but also partly of the height of the vertical explosion line, which in turn depends on the weight of the charge or the volumetric efficiency. Should the combustion line be not of this shape, results are bound to be inferior, as can be demonstrated thermodynamically, and yet the maintenance of such explosion lines in service operation so fundamentally related to results, is now as much a matter of hand adjustment as of design. This is a strong reason for caution in applying special test results obtained by skilled enginemen, to conclusions of aero engine possibilities in actual service, where engine skill is likely to be less than in the shop or laboratory and where, even if it were not, the problems of flight control are so absorbing as to minimize the attention that can be given to engine adjustment. Recognition of this condition also suggests the great desirability of exerting sufficient effort in design, to reduce to a minimum or eliminate entirely the dependence of the operating result on such adjustments as affect the shape and position of the combustion line. Such explosion lines as are desired and needed for maximum power and thermal efficiency will result, if the combustion period is confined to within a sufficiently small crank angle at the inner dead center when the piston is substantially at rest, and it is common to take this angle as about 30° half before and after dead center. At a rotative speed of 1,200 revolutions per minute about the minimum for the good aero engines, or 20 revolutions per second, each revolution is completed in 0.05 second, and an angle of 30° being one-twelfth of a revolution combustion will be completed in about 0.004 second. The higher speed engines of 2,400 revolutions per minute must accomplish the result in half the time or 0.002 second. In this short time the mixture must be ignited, and the flame communicated from particle to particle, till all the mixture has been burned, even the part most distant from the ignitor. Assuming a uniform linear rate of flame propagation or flame speed and a 6-inch diameter cylinder about as large a one as any aero engine carries, the flame must travel half a foot in 0.004 to 0.002 second, which requires a linear velocity

of 500 to 1,000 feet per second, or 30,000 to 60,000 feet per minute if a single igniter is used on one side.

While no direct data on the possibility of attaining such rates by normal propagation are available it is likely that from interpretation of indirect data, they are probably not reached, so the rates are abnormal or maximum pressures not attained. At any rate conditions that could in any way improve this situation must be grasped and utilized. The first of these is concerned with mixture proportions which exert so strong an influence on the rate of propagation in explosive combustion. This is another argument for perfection of carburetion, and for the continuous maintenance of the exact proportions found best, because even a slight change of proportions, such as would never be noticed in an automobile, may exert a powerful influence under the steady high speeds of the aero engine. Next in order comes the flame path itself which if cut in half reduces the necessary combustion rate to half and this is partly a question of shape of combustion chamber and partly one of number and location of igniter plugs. It certainly should take less time to inflame the charge in an engine with valves in the head than in a tee-head form, for example, if each had one plug, so the former shape is preferable on this score. It would seem as if one plug located in the center of the head would ignite the whole charge in the time required for the flame to travel a distance equal to the radius and, therefore, that such a location would halve the time required by one plug located at the side, yet no such degree of difference has been established. Moreover, it would seem that two plugs simultaneously sparking, and located at opposite ends of one diameter would require more time to accomplish ignition than one in the center as each separate flame would have to travel more than a radius to burn all the mixture, and yet two such plugs seem to give a quicker combustion than the one in the center, instead of slower. This question of combustion rate versus spark plug location and number is still pretty well open, though clearly of considerable importance in securing proper combustion lines for most effective working. Reliability should also be served as there is a better chance of avoiding failure with two independent magnetos and two sets of spark plugs than one, and this much has been established as good practice, but accurate simultaneous sparking of both plugs is absolutely necessary.

There are two considerations that bear on the question, both of which require definite investigation. In the first place it is the volumetric rate of combustion that is of primary importance, not the linear rate. It is clear that a greater volume of mixture will be burnt with a fixed linear rate, if the ignition is at the center of a complete sphere of flame as the sphere has a greater volume for its radius than any other geometric body. This would seem to favor central ignition, but as the normal aero engine combustion chamber with head valves is a short cylinder in which the axis is short compared with the diameter, ignition at the center will burn in the first half of the total time a mixture volume proportional to the area of a circle of half the bore, while during the second half the circular ring between this circle and the cylinder wall will burn and this ring has three times the area and volume of the center cylinder. Therefore, with central ignition, the volumetric rate is low at first, and high

at the end, averaging three to one in the second as compared to the first half, and it is the second half that is most important because here expansion is beginning and tending to lower pressures which it is the function of combustion to raise. If the situation be reversed so that the higher rates occur in the early part of the period available, then there will be less to burn after expansion has started and this will be accomplished by two plugs. The second consideration is that of non-uniform rate of propagation or accelerated combustion, and recognizes that mixtures which are agitated, burn much faster than those that are quiet. The advancing combustion wave started at any ignition point agitates the mixture beyond, somewhat like a compression wave, and two ignitors may be expected to increase this agitation and so accelerate combustion, compared with single point.

Whatever the rate of combustion, it is necessary to start combustion before the end of compression, and the slower the combustion rate, or the higher the piston speed, the more advance must be allowed. This advance, needed to limit the combustion completion time must be as small as possible because pressure rise during compression is just as detrimental as excessive friction, and is accepted at all only as the lesser of two evils. It would seem as if, with sufficiently high volumetric rates of combustion, and a sufficiently large number of ignition points, spark advance would be minimized. Manual advance might even be eliminated entirely as an operator's adjustment, if the magnetos and distributors used had proper electrical characteristics with speed increases to give earlier sparks passage at higher speed. With widely varying throttle openings and engine speeds, such as are typical of auto engines, chances of success are more remote than with aero engines where speed and throttle positions are changed so seldom.

While it is possible to experimentally determine the degree to which each process step important to the power weight ratio has been executed in an aero engine, and to measure the precise amount of disturbing effect of each interfering influence to be encountered in practice and, therefore, experimentally study processes with reference to reliability and adaptability as well, no such work appears to have been undertaken or, if it has, the results have not been recorded. All that has been published with respect to the judging of process fulfillment has been concerned with a few simple over-all measurements of horsepower, speed, and fuel consumption from which some conclusions are derivable, but not of such significant value to designers and operators of engines as would be the case with true investigation work of the analytical character that accounts separately for each factor that enters into the result. As has already been pointed out, these results are subject to some interpretation by comparison, one with the other, and each with thermodynamic standards. All the facts necessary for the latter are not available, and must be assumed in part, so the conclusions will be correspondingly approximate and subject to caution in use.

From the measured brake horsepower and speed, the speed can be eliminated by division and a quantity obtained which measures the effectiveness with which those processes that are concerned with output have been executed, and this is the mean effective pressure referred to brake horsepower. This quantity, of course, includes all

negative work of gas friction through carburetor header ports, valves, and exhaust muffler, all mechanical friction, all fan, pump, and magneto work; all negative work of precompression in two-cycle engines and the windage of rotating cylinder engines. For the most satisfactory conclusions these included items of loss should be separately determined and certainly the motor cylinder work done behind its piston should be isolated from the rest, but up to the present the only separate factor thus embraced is the windage of the rotating cylinder engines in the German tests. Comparison of these over-all competition test results giving the mean effective pressure referred to brake horsepower with each other is possible from Table IV.

TABLE IV.—Mean effective pressures referred to brake horsepower versus engine classes.

		Class No.											
I.		II.			III.			IV.					
		Cylinder-crank arrangement.											
Fired in line.		Fixed V, 2 cylinders per crank.			Rotating.			Fixed star.		Miscellaneous.			
		Cooling.											
Water.		Air.		Water.		Air.		Air.		Water.		Air.	
		Engine or maker.											
Benz.		De Dion-Bouton.		Curtiss.		B. M. & F. W.		Anzani.		Laviator, 2 cycle.		Ashmussen.	
M.E.P.	Authority.	M.E.P.	Authority.	M.E.P.	Authority.	M.E.P.	Authority.	M.E.P.	Authority.	M.E.P.	Authority.	M.E.P.	Authority.
106.9	Bendman.....	67.3	"Flight".....	{ 107.7 111.7 104.7	Maker.....	66.6	B.....	{ 76.5 78.5 76.9	Maker.....	65	"Flight".....	77.5	Maker.
	Daimler.		Renault.		Sturtevant.		Gyro.		Anzani.		Salmson.		
114.4	B.....	{ 64.1 60.2	"Flight".....	100	Maker.....	76.9	B.....	{ 83.2 80.1 86.8	Maker.....	{ 83.5 92.8	"Flight".....		
	Daimler.	Wolsley water-cooled exhaust box.			Sunbeam.		Gnome.		Edelweiss.				
103.5	B.....	79	"Eng'g".....	127	Maker.....	75.0	B.....	97	"Flight".....				

Daimler.	Rausenberger.	Gnome.	Laviator, 2 cycle.
102.0 B.....	103 Marker.....	71.3 B.....	57.2 "Flight".....
Daimler.	Clerget.	German Gnome.	1911 Anzani.
107.1 B.....	101.5 "Flight".....	{ 57.9 } { 67.2 } Maker.....	90.56 Lumet.....
Daimler.	Laviator.	German Gnome.	1911 Neupport.
107.0 B.....	{ 106 } { 92.5 } "Flight".....	{ 78.7 } { 65.2 } Maker.....	86.76 Lumet.....
Daimler.	Panhard Levassor.	Le Rhone.	
104.8 B.....	82 "Flight".....	{ 85.6 } { 88.2 } Maker.....	
Daimler.	Wolseley.	Clerget.	
98.0 B.....	77 "Eng'g".....	{ 57.6 } { 72.8 } "Flight".....	
N. A. G.			
106.0 B.....			
N. A. G.			
94.9 B.....			

Values of mean effective pressure exceeding 114 pounds per square inch, referred to brake horsepower, reported for one engine, and in many instances in excess of 100 pounds per square inch for water-cooled fixed-cylinder engines, warrant the conclusion that little betterment is possible in view of the prevailing lower figures in engines of other classes. These attained values are truly remarkable and can hardly be exceeded unless the initial pressures are raised above atmosphere by blowers. That some engines do not attain these values is proof of their inferiority of design, but there is some question as to capacity for maintenance of the high value after long periods that can be settled only after very long trial runs. The contest figures are reliable and acceptable for the conditions imposed, and if such values can be maintained in flight, little more can be expected. Such a high value as 127 pounds reported by one maker can hardly be credited, nor can so low a value of 74 pounds be regarded as good enough to be acceptable. Air-cooled cylinder values are consistently lower even for fixed cylinders and much more so for rotating cylinders, which indicates a fundamental inferiority.

There is some question of the validity of a comparison of mean effective pressures for different engines at unequal speeds, especially as rotating cylinder engines are never run over 1,500 revolutions per minute while fixed cylinder engines are operated over 2,000 revolutions per minute. To eliminate such an objection and at the same time permit of a judgment of the best speed at which to run an engine of given design, the horsepower-speed curve should be determined, or its equivalent curve of mean torque speed, or of mean effective pressure referred to speed. It is evident that, if with an increase of speed the mean effective pressure remains constant, then the horsepower will be proportional to speed, and the best speed to use for aero engines will be the highest at which the inertia or centrifugal forces are not excessive, assuming proper bearing conditions to be provided. This best maximum speed for fixed cylinder engines is undoubtedly the speed at which the inertia force of the reciprocating parts at the beginning of the outstroke is equal to the normal maximum gas-pressure force acting on the piston. For these conditions the force transmitted to the crank pin at the moment of explosion will be zero, gradually rising through the stroke and will be maintained high until near the end of the outstroke during the last half of which the increasing inertia forces are additive to the lessening gas pressure forces. During the idle stroke of suction the inertia force acting alone imposes just the same crank-pin forces as would the explosion when starting. Any less inertia while reducing the transmitted crank-pin forces for idle strokes increases them at the beginning of the working stroke. As the normal or most used speed is less than the maximum and the maximum gas pressures likewise, this normal condition and not that of maximum should be made the basis of selection of operating speed for minimum weight of engine, coupled with general serviceability. The speed at which normal maximum gas pressures will be balanced against reciprocating inertia, which is a function of the square of the speed and of the weight of parts directly, will, of course, depend on these weights. Heavy reciprocating parts may be best operated at lower speed than light reciprocating parts which include piston, wrist pin, and part of the connecting rod.

For a water-cooled engine of the automobile type Winkler gives 350 pounds per square inch as the maximum explosion pressure. Accordingly from the equation, reciprocating inertia pounds per square inch of piston = $0.00034 \frac{W}{a} N^2 r$, and taking $\frac{W}{a} = 0.5$, calculated from the weight distribution figures given by Winkler, the speed at which this would become equal to 350 pounds per square inch is 2,640 revolutions per minute. (NOTE.— $\frac{W}{a}$ = pounds reciprocating weight per square inch piston, N = revolution per minute, r = radius of crank in feet.) The rotating cylinder engine introduces a different condition, for here the reciprocating parts always exert a centrifugal force varying from a maximum at out center to a minimum at inner center and such as will keep the connecting rods always in tension if speed and reciprocating weights are large enough to develop centrifugal forces higher than the gas pressure, the maximum for which is found at 250 pounds per square inch normal.

From this standpoint the operating speed or high limit is fixed by the weight of reciprocating parts, and the normal maximum gas pressures, and this is the controlling factor so long as mean effective pressures do not fall off materially with speed. Examination of any horsepower-speed curve will show it to have a straight line form up to some critical value which is easily determined by test, though no authentic curves are available for aero engines. Of course, this critical speed must be beyond the operating range and is a second high limit to be considered in conjunction with that imposed by inertia. The best procedure is undoubtedly the selection of such proportion of gas passages, carburetor, and ignition conditions on the one hand, and reciprocating parts weights on the other, as will bring the critical speed equal to the inertia speed limit. Curvature of the horsepower-speed curve is due partly to increased losses of charge at the higher speeds, and partly to insufficient rate of combustion. Which of these two is in any instance the controlling factor must be discovered before any plan of improvement can be undertaken and this is most directly done by plotting the volumetric efficiency-speed curve beside the horsepower-speed curve. If the latter departs from the straight line before the former, it is clearly not due to insufficient charge. In such a case enlargement of valves or ports, or reduction of carburetor vacuum will not improve matters at all, as it is a low rate of combustion that is responsible for the result, to cure which attention must be devoted to mixture quality and ignition.

Fuel consumption per horsepower hour, or the equivalent thermal efficiency, is also an indication of the overall effectiveness of the process execution, and comparison of engines on this basis can be made from the data of Table V, selected from the test reports. These would tell more if divisible into the factors as indicated in considering the mean effective pressure.

TABLE V.—Fuel consumption (pounds per brake horsepower-hour) and thermal efficiency versus engine classes.

Class No.									
I.		II.		III.		IV.			
Cylinder-crank arrangement.									
Fixed in line, 1 cylinder per crank.		Fixed V, 2 cylinder per crank.		Rotating.		Fixed star.			
Cooling.									
Water.		Water.		Air.		Air.		Water.	
Engine or maker.									
Benz.		Curtiss.		B. M. & F. W.		Anzani.		Solomon.	
Fuel.	Efficiency.	Fuel.	Efficiency.	Fuel.	Efficiency.	Fuel.	Efficiency.	Fuel.	Efficiency.
0.472	0.29	{ 0.560 .504 .525 }	{ 0.22 .25 .24 }	0.845	0.16	{ 0.58 .57 .57 }	{ 0.23 .24 .24 }	0.53	0.25
Authority.									
B.		Maker.		B.		Maker.		Lumet.	
Daimler.		Sturtevant.		Gyro.		Anzani.			
0.510	0.27	0.511	0.24	0.785	0.17	{ 0.49 .53 .51 }	{ 0.27 .25 .26 }
B.		Maker.		B.		Maker.			
Daimler.		Sunbeam.		1911 Gnome.		1911 Nieuport.			
0.505	0.27	0.5	0.25	0.787	0.17	0.805	0.17
B.		Maker.		Lumet.		Lumet.			
Daimler.				1911 Gnome.		1911 Anzani.			
0.494	0.28	0.805	0.17	0.668	0.20
B.				Lumet.		Lumet.			
Daimler.				German Gnome.		1913 Anzani.			
0.503	0.27	0.6614	0.20	0.711	0.19
B.				Maker.		Lumet.			

TABLE V.—Fuel consumption (pounds per brake horsepower-hour) and thermal efficiency versus engine classes—Continued.

Class No.									
I.		II.		III.		IV.			
Cylinder-crank arrangement.									
Fixed in line, 1 cylinder per crank.		Fixed V, 2 cylinder per crank.		Rotating.		Fixed star.			
Cooling.									
Water.		Water.		Air.		Air.		Water.	
Engine or maker.									
Daimler.				Gnome, average of six 45-horsepower engines.					
Fuel.	Efficiency.	Fuel.	Efficiency.	Fuel.	Efficiency.	Fuel.	Efficiency.	Fuel.	Efficiency.
0.528	0.26			0.7108	0.19				
.501	.27								
.499	.27								
B.				Lumet.					
Benz.				Gnome, average of twelve 63-horsepower engines.					
0.537	0.25			0.7354	0.18				
Maker.				Lumet.					
Wright.				1913 Gnome.					
0.53	0.23			0.849	0.16				
Maker.				Lumet.					
N. R. G.									
0.485	0.28								
B.									
N. R. G.									
0.519	0.26								
B.									

TABLE V.—Fuel consumption (pounds per brake horsepower-hour) and thermal efficiency versus engine classes—Continued.

Class No.									
I.		II.		III.		IV.			
Cylinder-crank arrangement.									
Fixed in line, 1 cylinder per crank.		Fixed V, 2 cylinder per crank.		Rotating.		Fixed star.			
Cooling.									
Water.		Water.		Air.		Air.		Water.	
Engine or maker.									
Argus.									
Fuel.	Efficiency.	Fuel.	Efficiency.	Fuel.	Efficiency.	Fuel.	Efficiency.	Fuel.	Efficiency.
0.534	0.26								
B.									
Argus.									
0.588	0.23								
B.									
Argus.									
0.586	0.23								
B.									
Mulg.									
0.528	0.26								
B.									
Schröter.									
0.621	0.22								
B.									

TABLE V.—*Fuel consumption (pounds per brake horsepower-hour) and thermal efficiency versus engine classes—Continued.*

Class No.									
I.		II.		III.		IV.			
Cylinder-crank arrangement.									
Fixed in line, 1 cylinder per crank.		Fixed V, 2 cylinder per crank.		Rotating.		Fixed star.			
Cooling.									
Water.		Water.		Air.		Air.		Water.	
Engine or maker.									
Hall-Scott.									
Fuel.	Efficiency.	Fuel.	Efficiency.	Fuel.	Efficiency.	Fuel.	Efficiency.	Fuel.	Efficiency.
0.6	0.21
Maker.									
Austro-Daimler.									
0.52	0.26
Government Acceptance Test.									
1911 Labor-Aviation.									
0.617	0.22
Lumet.									
1911 Aviatc.									
0.595	0.23
Lumet.									

NOTE.—For Continental engines a calorific value of 18,900 British thermal units per pound has been assumed, for American and British engines 20,400 British thermal units per pound.

Fuel consumption of less than half a pound per brake horsepower-hour, reported for fixed water-cooled cylinders on reliable authority, with corresponding thermal efficiencies approaching 30 per cent, are nothing short of wonderful for such high-speed engines, and judging

by the performance of other classes of engines and by the thermodynamics of limiting possibilities, little more can be expected. What must be sought for here is, therefore, not an improvement of the best, but a general raising of the poorer ones to level of the best, and the maintenance of the high test value in actual-service flight. In this prime factor, as in that of mean effective pressure, the fixed water-cooled cylinder has a demonstrated superiority, while the least favorable is the rotating air-cooled. The difference between the best and worst is very large indeed.

Comparison of engine results with each other, especially when it is not possible to divide overall results into contributing factors, can give no information as to how far it may be possible to further improve engines. It merely indicates which is the better, and may throw some light on type availability, as, for example, the fuel consumption of two-cycle engines must always be greater than four-cycle, if each is equally well designed; or again, air-cooled engines may or may not have as high a mean effective pressure as water-cooled.

Thermodynamic standards of comparison do indicate goodness more absolutely, and these are now in general use in engineering practice. Accounting for and eliminating operative conditions, such absolute standards illuminate the goodness of the machine with reference to the execution of its basic process. Such, for example, is the case with steam turbines, the performance of which is compared with that of the Rankine cycle as a standard, for equal initial and terminal conditions of pressure, temperature, and steam quality. It is also the case with internal-combustion engines of the classes that have really been subjected to any reasonable degree of investigation which are judged by the Otto and Diesel gas cycles. But the aero engine has not as yet been so studied. According to this method equations are derived from a study of the ideal Otto gas cycle for thermal efficiency and mean effective pressure. Thermal efficiency, for example, referred to indicated horsepower is found to be a function of the amount of compression only, and given by the following equation, in which the subscript (*b*) refers to the condition after, and (*a*) to that before, compression:

$$E = 1 - \left(\frac{V_b}{V_a}\right)^{\gamma-1} = 1 - \left(\frac{P_a}{P_b}\right)^{\frac{\gamma-1}{\gamma}} = 1 - \frac{T_a}{T_b}$$

Comparing this with the thermal efficiency of an engine of known compression results in an efficiency ratio, and in Table VI are given some values for aero engines, computed with what data are available and certain assumptions noted. As the fuel consumption per brake horsepower-hour is the only experimental quantity beside the compression, the factor includes all losses, both mechanical and thermal, which former should really be separated out.

Similarly, mean effective pressure can be shown thermodynamically to be not only a function of compression, as is efficiency, but also of the calorific value of the mixture, the negative work and suction heating or volumetric efficiency. As these effects are not separately known, and as all aero engines work on gasoline, although benzol is also used in Germany, and are capable of making and using the same calorific power mixtures measured at 32°, and one atmosphere, this factor

TABLE VI.—Diagram factors and efficiency ratios—Continued.

Class No.											
I.		II.		III.		IV.					
Cylinder crank arrangement.											
Fixed in line of 1 cylinder.		Fixed V?, 2-cylinder crank.		Rotating.		Fixed star.					
Cooling.											
Water.		Air.		Water.		Air.		Air.		Water.	
Engine or maker.											
N. A. G.											
P.	E.	P.	E.	P.	E.	P.	E.	P.	E.	P.	E.
Diag. fact.	Efficiency ratio.	Diag. fact.	Efficiency ratio.	Diag. fact.	Efficiency ratio.	Diag. fact.	Efficiency ratio.	Diag. fact.	Efficiency ratio.	Diag. fact.	Efficiency ratio.
101.0	0.28										
94.0	.26										
.337	.608										
.316	.565										
Angus.											
106.5	0.26										
107.0	.23										
.355	.563										
.337	.500										
Austro Daimler.											
94.0	0.26										
.31	.565										
Cheno.											
103.6	0.229										
106.5	.253										
Wright.											
80.2	0.182										
.267	.417										
Green.											
77.0	5.23										
.258	.504										

NOTE.—E is thermal efficiency referred to brake horsepower and P is mean effective pressure pounds per square inch referred to brake horsepower.
 On account of lack of sufficient data for individual engines, a compression ratio of 1:4.5 has been assumed for all engines, equivalent to an air card efficiency of 48.0 per cent and theoretical M. E. P. = 500.

These figures, which should throw so much light on performance, are, as a matter of fact, of but little value because of the absence of accurate data, especially on compression and engine friction, both mechanical and fluid. They are, however, given to illustrate the method of judging by thermodynamic standards rather than by simple comparison of engines one with the other, in the hope that in future tests such data will be obtained as to make possible the determination of both diagram factors and thermal efficiency ratios.

Continuity of the operation of mixture treatment in the cylinder is dependent on the maintenance of a steady state as to temperature of the metal parts, and this is possible only by a cooling system of considerable complexity from the thermal standpoint, however simple the apparatus may seem, superficially examined. Cooling for the maintenance of a steady state of temperature in the metal parts is not of itself sufficient, as the parts must be held to a low limit of temperature, which requires a definite heat conducting and dissipating capacity in proportion to the heat receiving capacity of the part. This limit of allowable temperature is imposed not only by the requirements of the charging and compression functions but is necessary for other reasons. If metal parts become too hot oxidation sets in, stiffness is reduced, and deformation, both the temporary sort resulting from expansion and the permanent sort due to molecular rearrangements, becomes troublesome. Cylinder lubrication is also dependent on the temperature of the metal surfaces, of piston barrel exterior and cylinder interior, which, if too high, prevents any oil remaining without destructive distillation or carbonization, or impairs its lubricating value by excessive reduction of viscosity.

Heat is received by all metal parts in contact with the hot gases and these parts include the cylinder head, inlet and exhaust valves, the walls of any valve pockets, the igniter plug, the piston head, and the whole interior of the cylinder wall exposed at the end of the outstroke. The heat received by the cylinder proper is greatest for the part exposed during the first part of expansion just following explosion, and extremely hot gases are in contact with the whole interior of the clearance space. In addition, heat is given up by burnt gases escaping through the exhaust valve and ports to the valve and its stem to the stem guides, port walls, and connecting parts of the cylinder head or the side pocket that carries the exhaust valve.

Heat received from hot gases must be conducted through the metal by more or less devious and rarely straight paths to the external surfaces of the metal walls from which heat may be abstracted. The first means of abstraction from the exterior faces of the walls is air in motion, induced or driven by a fan which may be separate, or the propeller itself. In some cases the free air moving past with the velocity of flight is relied upon, but the most unique arrangement is that of the rotating cylinder cooperating with the free air movement. The second means of abstraction is water or oil, or in general a liquid circulated by a pump, first over the heat receiving walls and then through the radiator where the free air again takes it up with or without the assistance of a fan. A third method, as yet used in very few aero engines, though frequently used elsewhere, is the boiling water jacket, noncirculating, with an air cooled steam condenser and condensate return. In any case the ultimate disposition of the heat is to the free air, and when liquids are interposed as carriers it is with

the idea that some good results will follow what appears to be at first an indirect method. The only sort of good result that would be worth while is a better abstraction from heated walls in steadiness and degree, and that such is the case is unquestionable, not only on rational grounds, but by experimental demonstrations.

Whenever heat is to pass between a fluid and a body of metal, it has been established that a layer of fluid adhering to the metal as a film acts on the heat flow as an insulating layer. The thickness of this dead fluid film, and therefore its thermal resistance, depends on the condition of fluid motion, or, as it has been termed, on the scrubbing action. High velocities always reduce the film thickness and the thermal resistance. The thermal resistance (reciprocal of the conductivity) of gases and, therefore, of gaseous films of given thickness, is of the order of magnitude of 1,000 times that of metals and 10 times that of liquids and the thermal resistance of liquids 100 times that of metals.

Heat flowing from hot cylinder gases to the air directly must, therefore, pass through a complex path of at least three parts, a dead gas film on the inside walls of the cylinder, the metal wall and a second dead gas film on the outside. When a circulating liquid is introduced the path is more complex, consisting of a dead gas film on inside cylinder walls, the metal walls, a liquid film outside the walls, a second liquid film on the inside of the radiator, jacket, or water pipe walls, and finally a second gas film on the outside of radiator jacket or pipe. Each of these elements of the heat path exerts a thermal resistance to heat flow, and the resistance of the whole path is the sum of the separate resistances.

Heat flows according to a law similar to Ohm's law for electricity, inasmuch as the flow varies directly with the difference of potential or temperature, and inversely as the resistance. Therefore, over any complex path, consisting of several parts each of different resistance series as the same quantity of heat is passing through all, the whole temperature drop is divisible into partial temperature drops in the proportion of the partial resistance to the whole resistance. The resistance of any one part of the path is inversely proportional to the conductivity of the substance, is directly proportional to the length of path in the direction of heat flow, and is inversely as the cross section of path at right angle to the heat flow. Accordingly the temperature drop through a gas film is almost a thousand times as great as through a metal wall of equal thickness, and the drop through a liquid film also of the same thickness would be about ten times that through the metal. Gas film thicknesses and thermal resistances on the interior of the combustion chamber, because of lack of circulation there, must be fairly thick and so highly resistant. These interior gas film resistances must be much greater than the air films on the exterior where air is blasted over surfaces and very much more in turn than the resistance of films of liquids circulating over those exterior surfaces. Of all the temperature drops, by all odds the least is that through the thin cylinder walls when the flow is direct.

The object of the design of the cooling system is to keep the interior metal walls as cool as possible, and these walls will be cool in proportion as the thermal resistance of the heat flow path is greatest on the side of heat reception and in proportion as the resistance on

the outside is small and the heat flow path through the metal short, or in the event of this being impossible then of equivalently larger cross section.

By reason of the fact that they normally work at or nearly at full power and at such high speeds, aero engines develop more heat per square inch of wall interior than any other class of internal-combustion engines of the same bore, and it is an open question whether cylinder bore has much, if anything, to do with this quantity. Cooling must, therefore, be more effectively provided than in any other similar engine, so that careful study of heat flow conditions should be well repaid in improved results, both as to maintenance of high power and reliability. While considerable advance has been made in this direction it is more concerned with general system than with details. The literature, for example, is full of controversial matter on air cooling versus water cooling, on the relative merits of air blasted fixed versus rotating cylinders, and such matters of general arrangement, but there is a general lack of attention to the rational thermal analysis or design of the heat flow path for control of its resistances and temperature gradients.

Cooling of cylinder-barrel walls is perfectly easy by either air or water, but to get air cooling as effective as water the air must circulate many times faster than the water, which is quite effective, whether it has any material velocity or not. Extension of exterior surface is, of course, a direct and rational means of reducing the necessary air velocity to secure a rate of heat abstraction that will keep the temperature of the metal walls much nearer to that of the circulating air than to the interior hot gases. Such ribbing is quite unnecessary with water or oil in jackets as the rate of abstraction by this medium of higher conductivity is so high that no more abstraction surface is required than that receiving heat to keep the metal at a temperature very close to that of the liquid.

Difficulties of cooling begin only on the irregular parts and increase with their irregularity or thermal isolation from heat dissipators. The first irregular element met is the cylinder head or side valve pocket. This receives heat over the whole interior, including the valve faces, and also from the walls of the exhaust port. It can not be of uniform metal thickness, and by reason of valve seats and ports the metal heat flow path can never be of uniform length, so it is to be expected that however uniform in temperature the interior of the smooth cylinder barrel may be no such condition can apply to heads or valve pockets. The intake port and valve, with its stem and stem bearing, are coolers and need no other cooling than is available from the incoming charge, especially when the mixture carries some liquid still to be vaporized. It is this inlet self-cooling that is responsible in part for lowered volumetric efficiencies, so the heat exchange here that helps in one direction is harmful in the other.

Exhaust ports, whether cast in or welded to sheet metal or screwed into machined seats, can not be too well cooled, because they start at the exhaust valve seat, at which point heat is received on both the port side and combustion chamber side. Exhaust ports also carry the stem bearing of the exhaust valve, which is the only means of disposing of the heat received by the valve itself on either side. For the amount of heat received and to be disposed of, with-

out undue localized rise of temperature at the exhaust valve seat, these exhaust ports of cylinder heads or valve pockets are normally not cooled sufficiently. Increased metal cross section and metal extensions to jacket or air blast spaces would naturally assist. Still worse in many engines is the condition of the exhaust valve receiving heat on both sides and with no source of dissipation except its stem and the stem bearing. These stems should have a large metal cross section, and the metal should be of as high conductivity as possible, while the joint from valve stem to disk should be of long curve and the disk of increasing thickness toward the center to further promote conducting capacity. The stem bearing can hardly be too big or long nor too well cooled by sufficient metal and heat dissipating surface, but heat transfer from the stem to the guide bearing can hardly be expected without an adequate oil film, because a dry stem means a gas film of so much greater thermal resistance than oil as to render useless the large metal cross section and surface. To hold oil in such a stem bearing without an elementary stuffing box is, of course, almost impossible, but though such a device is not used, it should be added to replace the present two diameter stems now in use for this purpose. It requires only a casual survey of the illustrations of aero engines to see how different is the means for head cooling and especially that of the exhaust valve, its seat, stem and port walls, and how easily, therefore, distortion of the metal parts may occur, due to unequal expansion, resulting possibly in breakages but certainly, when valves and seats are involved, in serious leaks which, once started, especially at exhaust valves, rapidly increase by the high erosion influences.

Probably the worst cooled part, aside from the exhaust valve, is the piston head, which receives heat over its whole top surface, equal to the area of the cylinder bore circle at least, and more if arched upward or dished down, as may properly be done, especially the former to give it some stiffness and elasticity in thermal expansion. This heat, while imparted in small part to the crank case air, must largely and almost wholly be disposed of to the cylinder walls by a radially outward conduction across the head, followed by conduct down the piston barrel, thence across an oil film to the cylinder walls. By increasing the metal thickness of the piston head regularly from the center outward in proportion to the square of the radius, its heat carrying capacity could be made proportional to the receiving surface above. Then by suitably thickening the upper barrel the axial heat carrying capacity can be made great enough to take what is delivered by the outer ring of the head and conduct it down for the oil film to be taken up and transferred to cylinder walls. This last transfer is most effective the longer the piston and the better the oil film, and as it is thus disposed of the thickness of barrel may be reduced. Such additional piston metal to secure an adequate heat carrying path will be least the greater its thermal conductivity, and there is no reason why suitable carrying capacities should not result without undue weight. Examination of the illustrations will indicate that apparently the idea of most of the designers has been to use as thin, and uniformly thin, metal as possible with no thought of heat conductivity whatever, though a few give evidence of some grasp of the problem. An exception to the overheated piston is found in the rotating cylinder engine that carries its inlet valve in

the piston, which in this case is adequately cooled, but at the expense of volumetric efficiency. There is no reason, should thick metal pistons prove objectionable, why air blasts should not be introduced directly under the pistons except the consequent evaporation of lubricating oil.

Piston heads that are very unequally heated or very highly heated are subject to a considerable expansion and to oxidation as well, besides being responsible for decreased volumetric efficiency and preignition or lowered compression. Excessive and variable expansion of the head besides resulting in permanent deformation or cracks will cause the piston to bind on the cylinder unless cut away or given extra cylinder clearance. If sufficiently cut away to give relief, leakage is promoted, which defeats lubrication, and the oil film, which is an essential part of the thermal path from piston to cylinder, is destroyed and overheating accelerated. Some little clearance, and more at the top than along the barrel, is necessary, but the less the better, and the better the cooling of the piston head whether by conduction across it and down the barrel or through separate conduction bars, directly from head center to barrel and to oil film, the less clearance will be necessary. A photograph is given in a German report of a piston that failed from overheating, and such failures seem to be frequent. There is also shown a burned spark plug, which should be cooled just as well as other parts to prevent excessive temperature rise, though its end must be warm to promote cleanliness, but not so warm as to make an incandescent spot, or to cause destruction.

Cracked cylinders are also more or less common from unequal cooling, and in both the German and the British Alexander tests such cases are reported. In the latter the fact that the cylinder ran 11 hours before failing proves the crack to be not due to any gas-pressure stress. This unequal cooling or heating may be due to uneven thicknesses of metal or to unequal heat abstraction, as would occur in water jackets with steam or air pockets, or to the impact of the air blast from the propeller on the front side of a forward cylinder. Rotating air-cooled cylinders and, in fact, even fixed air-blasted cylinders can not be equally cooled because it is quite impossible to force equally cool fresh air at equal velocity around the whole cylinder, no matter how many baffles or guides are used, and this inequality must promote distortion. One compensating element used, that of eccentric ribs giving more surface for heat abstraction on the side of least air activity, is ingenious, probably more so than effective. There seems to be no hope whatever of air cooling ever being made as uniform as with water, and therefore more distortion effects are certain in air-cooled engines even though, by the use of excessive quantities of air and fan or windage power, the walls could undoubtedly be kept as cool as with water, it could not be a uniform cooling, and hence not as desirable. In the German test report the windage of the Gnome rotating cylinder engine is given as 8 per cent of the output, which checks exactly the value given by Winkler for the Renault fixed-cylinder engine fan power.

Water gives control of temperature in degree as well as uniformity, for with sufficient radiator capacity the water temperature entering

jackets can be kept only a few degrees above that of the free air. By sufficient circulating-pump capacity the delivery temperature from the engine jackets can be kept as near the inlet temperature as may be desired. On the other hand, should the engine be found to work better with warmer water, or if radiator size is to be minimized, and the advantage be regarded as greater than a warmer engine, this can be accomplished by reducing radiator size with corresponding rise of temperature of water inlet to engine without in any way affecting the uniformity of heat abstraction from the engine metal. The limit of this occurs when the jacket water is allowed to boil, as in the Antoinette, in which case the radiator becomes an air condenser and very small because of high temperature difference between steam (212° F.) and the free air. Higher temperatures than this can be secured by the use of oil in jackets, as is done in some farm tractors to further reduce radiator size, and such oil has the advantage of not freezing.

Piston-cooling effectiveness is more or less measured by the limiting diameter that is operative, and the tendency to use multiple cylinders of small diameter, especially in the rotating air-cooled engine, which go as high as 20 cylinders per engine, and to keep their cylinder diameters less than 5 inches, can be traced directly to this. Even with water-cooled engines a limit is reached, dependent entirely on this piston-cooling factor, and larger cylinders than are now used require better cooling of the piston by the methods indicated.

Temperature expansion stresses added to those imposed by gas pressures and mass motion forces have never yet been successfully attacked by the stress analyst, but even if they could be treated mathematically it would help but little when the temperature in the various parts of the metal structure are unknown. No class of machine except the large internal-combustion engine suffers so severely from these temperature conditions as aero engines, and in none is the consequence of failure likely to be so serious. This new and difficult problem must be attacked patiently and systematically by experimental research if any but accidental or haphazard results are to be attained. Pending such needed fact data on temperatures and temperature gradients and on the effects of mean temperature or temperature differences on volumetric efficiency, on limiting compressions, on metal expansion, on permanent distortion, or on corrosion, the best that can be done is to use that method of attack that promises best results in uniformity of cooling and in low mean temperature. This undoubtedly involves the use of liquids as heat receivers from the metal walls, but just as surely demands proper arrangement of metal parts for promotion of heat transmission as uniformly as possible through the several parts.

Lubrication as a process is of considerably greater importance and significance in the aero engine than in any other, for while it has but little direct relation to the power weight ratio, it has an indirect one and, of course, bears directly on reliability, constituting probably the most important element of this factor. The indirect relation of lubrication to the power weight ratio results from the use of unusual metals at bearing surfaces, especially cylinder versus piston, adopted for reduction of metal volume, and bringing cast iron and bronze against steel, and even steel against steel. Lubrication is also as pointed out previously, a factor in cooling when the heat dissipation

path includes an oil film surface, maintenance of which reduces heat resistance to a proper value, but loss of which results in overheating of the parts that are thus thermally isolated. Not only is the lubrication of the aero engine peculiar in these two respects of unusually difficult metals to be lubricated, and heat conductivity function in addition to that of lubrication, but in other respects as well. Maximum compactness in the interests of low weight leads to the use of small bearings and as high bearing pressures as may be feasible for the very high speeds in use. In the case of rotating cylinder engines any change in angular velocity produces piston side thrust loads, not found in any other machine and these may be extremely high, so high as to even bend the cylinders as cantilever beams if the acceleration, positive or negative, is large. All aero engines have closed crank cases and these must necessarily get very warm, largely from heat received from the underside of pistons, but also from the whole side of the piston barrel and the exposed cylinder wall. The cylinder wall is hot by reason of the heat being conducted through, so that the viscosity of the oil on it is reduced just about to the limit. In the hottest region near piston heads, and even in some cases in other parts as well, the cylinder oil suffers decomposition changes, due to the heat, as is proved by the progressive loss of lubricating value of oil in circulating return systems. Not only is the oil subjected to variable and high temperatures, but it must be of such character as will not leave excessive carbon residues in the combustion chamber when it works past pistons, but must vaporize on the hot surface with least carbonization. Coupled with these high interior temperatures of the aero engine are possible excessively low temperatures of the surrounding air, freezing temperatures in high altitudes being rather the rule than the exception, and yet immediately before or after, the machine may be close to the earth where the temperature in summer may exceed 100 degrees.

It is clear that aero engine lubrication is not only more important as a process than in other classes of engine with reference to need and consequences, but is very much more difficult on account of the excessive heating, even when the engine is built of the standard materials of internal combustion engine practice, i. e., cast-iron piston on cast-iron cylinders, but is doubly difficult when steel is substituted to reduce metal volume, so it is natural to find new elements of practice introduced.

Crank shaft and crank pin bearings of aero engines offer no more difficulty on aero engines than on others, provided the bearing pressures imposed by the designer in an effort to cut down material are not excessive and provided the surrounding atmosphere is not hotter. The necessity for crank cases imposed by the presence of dust in the air at landing and starting points, does make the atmosphere surrounding these bearings abnormally hot, especially when the pistons are inadequately cooled as is more often the case than not. This hot atmosphere created by hot pistons and conserved by the closed crank case naturally raises main and crank pin bearing temperatures to some value higher than the crank case air, fixed by the heat generated in them by friction, and so reduces oil viscosity correspondingly. This would seem to be sufficient reason for using lower bearing pressures or larger surfaces than in auto engines, for example, and this conclusion is reinforced by the fact that the bearing surface speed is so

very high and continuously so. Instead of larger main and crank pin bearings, the aero engines so far developed usually have equal or smaller ones than automobile or boat engines. No matter how elaborate the oil-feeding system nor how carefully the grade of oil may be selected, this practice can not be accepted until it has been more fully demonstrated than has yet been done, that it is necessary.

Piston and wrist pin lubrication present still greater difficulties, and no new methods of lubrication are available beyond the supply of excessive quantities of oil to these surfaces. As already pointed out, aero-engine pistons are hotter than those of other engines because of the higher speed and consequent greater heat quantity per minute taken up by the pistons, and also because these are of thinner metal and so can not dispose of their heat so readily to the cylinder walls. This is further aggravated by the shortness of the pistons, which in some cases are hardly more than two-thirds of a diameter in length, though Winkler recommends 1.1 diameter, while stationary-engine pistons are regarded as requiring a length of two diameters. Such short pistons reduce the heat dissipating cylinder contact surface, but also increase the side-thrust pressures. They tend to cock side-wise, especially when made loose to relieve expansion, and so concentrate side thrust at the ends instead of distributing it over the already too small surface. In the rotating cylinder engines additional side thrust of almost any amount may result from variations of angular velocity if sudden. Under such high temperatures and high side pressures, perhaps badly distributed, the viscosity and lubricating value of most oils falls very low and the decomposition conditions are approached with production of light constituents that evaporate and of tar or carbon constituents that stick. Yet in spite of this the speed of the rubbing surfaces is so very high as to require lower surface pressures and temperatures rather than higher. Mean piston speeds are never under 1,000 feet per minute, a high limit for good stationary-engine practice, and even exceed 2,000 feet per minute.

To still further aggravate this piston-lubrication condition, steel pistons have been introduced against cast-iron cylinders, steel cylinders with cast-iron pistons, and steel pistons against steel cylinders, again in the interest of reduction of metal volume, though nowhere in engineering practice has there been any success in lubricating such surfaces, especially when very hot.

The fact remains, however, that these aero engines do run, but the absence of sufficient reliable data extending over years of experience, commensurate with that on which present standards of internal combustion engine practice rests, makes it a source of wonder whether the lubrication of aero engines at present is wrong and bad, or whether on the other hand they have taught old practice something new. About all that can be said at present, however, is that many aero-engine failures traced to lack of lubrication are recorded; that the oil consumption of these engines is very high, in some cases reaching half the weight of fuel; and finally that the greatest caution should be observed in following present methods. At the same time, the construction of engines to operate cooler at lower bearing surface pressures and with parts of successively different materials should be undertaken for test data. Each new combination should, be experimentally tested to destruction with decreasing quantities of

selected but different oils to definitely settle this question in the laboratory.

As to details of method of application of oil, there seems to have been developed some more or less general practices. All rotating cylinders are lubricated by crank-case sprays, which in the case of those taking the charge through the crank-case involves the carrying of appreciable quantities of oil into the combustion chamber where it burns, at least in part. This is practically equivalent to the splash system for fixed cylinders, which for auto engines has proved only moderately successful and for aero engines is quite unsuited. All fixed-cylinder engines use forced lubrication for main and crank-pin bearings, through hollow or drilled shafts and cranks, the pressure being developed by pumps, many of which have failed even during competition tests. Normally these fixed-cylinder engines have crank-case oil tanks at the lowest points, often, though not always, carrying here all the oil supply for a full length run of 10 hours or more, as a means of preventing solidification of oil under low-air temperatures, and with all or most of the distribution pipes inside the crank case for the same reason, sometimes substituting cored or drilled passages in the casting for pipes. These pump-forced feeds are so far all of the central system, one pressure supply, sometimes with a duplicate in reserve, being provided with multiple outlets, which has an element of danger, because tight bearings needing most oil receive least in proportion to the loose bearings which, offering less resistance to oil escape, tend to take it all. There are three typical pump systems: First, complete circulation of the whole supply to bearings with gravity return to sump and pump; second, direct feed of fresh oil from pump with no return; and third, combinations of this with two pumps, one for fresh and one for circulating oil, discharging into common bearing tubes or into separate ones. Any circulating oil system requires a cooler, and the exposed crank-case sump surface is sometimes relied on, sometimes supplemented by air-circulation tubes or by carrying the oil supply to exterior cooling surfaces, and as a rule this oil cooling is made complementary to carburetor mixture or air warming, by passing one in thermal contact with the other. As a rule cylinders and wrist pins are lubricated by the oil escaping from main and crank-pin bearings, but considerable modification of details is found, and reference is made to the papers and reports reproduced in the appendix. Among these that of Benderman, reporting on the second German competition, is so good that it is worth quoting.

Lubrication.—The amount of lubricating oil required is affected by the system of lubrication and the circulation of the lubricant. The lubricant of an aeroplane engine should not only reduce the friction between the parts which are in sliding contact, and not only remove the frictional heat, which is considerable, due to high bearing pressure, but in many cases it also has to cool the piston heads. The oil is largely lost without doing any work. It works past the piston into the combustion chamber and there fouls spark plugs and valves. This, of course, can not be avoided altogether, but it may be minimized by guards at the cylinder ends and by positively feeding the oil to the wrist pins. Much oil escapes in the form of vapor and fog through the ventilating funnels (breathers), which equalize pressure or vacuum in the crank case without allowing the oil to squirt out or dirt to

enter. If these breathers are made long and exposed to the air blast the oil vapor will condense in them and distant places, such as the cam shaft above the cylinders, may thereby be lubricated in place of the hand lubrication.

The loss of oil by leaks in the casing depends on the number and kind of the joints. Especially the guides of the valve tappet rods throw out a great deal of oil. It will, therefore, be well to keep their diameters at the place where they emerge, small. In one motor the tappets are nearly surrounded by the ventilating pipes (breathers), which direct the oil coming back to the crank case.

The lubricating qualities of the oil decrease with increasing temperature. Therefore rapid circulation of the oil in the bearings subjected to high pressures is required; also sufficient cooling in a spacious oil pan, preferably with cooling tubes. At high temperatures as tables 5 shows, castor oil is considerably more viscous and effective than good mineral oil. It, therefore, so far can not be done without in air-cooled engines. For water-cooled engines one of the two mineral oils mentioned was always satisfactory during the competition.

The most simple system of oil distribution is the so-called splash system (very imperfect). The fresh oil supplied from outside or the storage oil collecting in the crank case is whirled around by the rotating and reciprocating parts and is thus intended to get to the proper places. This means that considerable excess of oil is required; the losses are considerable. Engines lubricated in this way usually have a smoky exhaust.

More advantageously the oil is positively conducted by a distributing line to the fixed bearings, and from there as far as possible without loss conducted to the connecting rod ends and to the rubbing surface of the piston. This is best effected by full oil throw rings on the crank and a pipe connection between the ends of each connecting rod. In some cases the oil throw rings are only partially executed and are partially replaced by turned grooves in the side of the crank. These catch the oil, which, after leaving the bearings, runs along the side of the crank.

In other cases the oil conducted to the crank bearing is forced into the interior of the crank shaft and from there under the influence of centrifugal force runs to the connecting rod ends. On the way into the shaft it has to overcome centrifugal force. That requires very neat bearings and at times high oil pressures. Piston force pumps in this case are to be preferred to gear pumps. The positive supply to the wrist pins permits the most complete utilization of the oil. The lubricating oil consumption is reduced and a supply for several hours may be provided in the moderately enlarged crank case. If the crank case should be too small, a pump for fresh oil has to replenish the supply from without. The fresh-oil pump may either discharge into the circulation line or may feed a special distribution net, separated from the closed-circuit line. This, however, is hardly advantageous, since the required small make-up of fresh oil, should the closed circuit fail, does not suffice to keep the engine running for any length of time. Special attention must be given to the fact that the oil in cold weather becomes so thick in exposed pipes that a dangerous lack of oil will be the result and the bearings will melt.

The circulating oil becomes polluted by metal dust and deposits of combustion. Small particles, however, do not matter; larger

ones may be kept away from the pump by brass screens. In the engines tested these screens were not always well accessible. From the fine carbon particles which the circulating oil carries with it after a certain length of time, the bearing metal receives a grayish look, but its durability is thereby increased.

The oil pump is connected by a short suction line with a point of the case located so low that in all inclined positions of the engine it is covered by oil. The lubricating oil, which is very thick at low temperatures, renders the design of the oil pump very important. All automatically operated parts, such as valves with springs, and such, easily fail, and therefore are to be avoided.

Part 2 (b).—GENERAL ARRANGEMENT, FORM, PROPORTIONS, AND MATERIALS OF AERO PARTS—POWER-WEIGHT RATIO, RELIABILITY, AND ADAPTABILITY.

If in every cylinder the same mean effective pressure were obtained, and if all cylinders weighed the same number of pounds per cubic foot of displacement per stroke, including their attached valves, rods, pistons, wrist pins, and connecting rods, then the weight per horsepower of engine at the same engine speed would depend on the frame and shaft weights per cylinder which is a result of the general arrangement. If at the same time the thermal efficiency of all engines were the same, the added weight of fuel and tanks per horsepower would be the same for all. Differences in weight per horsepower of engine proper and of engine, oil, fuel, radiator, and tanks taken together are considerable, the heaviest being more than twice the weight of the lightest even for short runs, and the excess is more than this for the longer runs. The basic causes for such differences can be reached only by analysis along these lines, and such analysis will indicate that as many of the elements of actual difference are accidental or incidental as are essential or inherent in arrangement, form, proportions, or material.

The influence of arrangement to be first examined is in some cases quite clear and in others complex. Where, for example, arrangement of cylinders in number and position has no effect on the limiting speed, on the mean effective pressure, on thermal efficiency, or on the weight of cylinders complete per cubic foot of displacement per stroke, then the effects of arrangement are clear, qualitatively. The contrary is the case when a given arrangement that gives reduced frame and shaft weight per cylinder as compared with another also requires heavier cylinders, or is limited to a lower speed, or is incapable of any but a low mean effective pressure, for here the result depends on the degree to which one factor compensates another.

Differences in arrangement are more bold and numerous in aero engines than in any other class, and some of them are quite unique, yet with these truly remarkable differences that are quickly grasped by a reference to the illustrations in the appendix, the surprising thing is not that the weight per horsepower varies considerably with arrangement but that it does not vary even more. This is an indirect proof of the existence of these compensating factors, and shows that arrangement has not as great an effect on weight per horsepower as might at first be expected. Air cooling versus water cooling is a fair illustration of this, for elimination of jacket, radiator, and pipe metal and of water reduces weight, of course, but the result is usually a

lower mean effective pressure and thermal efficiency. Again, the rotating cylinder air cooled as compared with the fixed cylinder, while eliminating fans and rib casings, adds a windage power requirement, must have steel cylinders to avoid the uncertainty of casting soundness in resisting the great centrifugal forces, and so must use excessive quantities of oil, which has to be carried.

Ignoring for the present those compensating differences and concentrating attention on the effects of arrangement alone, it is clear that two similar cylinders set side by side, each developing the same power and of equal thermal efficiency, will not require shaft and frame weights twice as great as one. Adding a third is equivalent to placing between the frame and shaft ends an intermediate piece without ends, and hence of less weight, but each cylinder added, beginning with the fourth, adds exactly the same frame and shaft weight as the third, and therefore has very little influence on weight per horsepower, unless other modifications are introduced, such as casting two cylinders en bloc, removing main bearings between alternate cranks, and thickening of frame and crank shaft to meet the stresses introduced by increased lengths. Therefore multiplication of similar cylinders along one line reduces weight per horsepower fast at first, and beginning with four rapidly less, and beyond a certain number of cylinders the weight reduction is more or less equalized or overbalanced by the necessity for greater metal cross-sections per foot of length in shaft and frame. To illustrate the point, a given style of boat engine having the same cylinder on engines of one, two, three, four, and six cylinders in line is selected, as no other class of engine covers such a wide range of number of identical cylinders. For one size of cylinder the single-cylinder engine weighs 472 pounds, and the two-cylinder engine 626 pounds, the second cylinder having added 154 pounds, or 33 per cent. The third three-cylinder engine weighs 716 pounds, so that the third cylinder has added 90 pounds, and each additional cylinder also adds the same 90 pounds up to six, the weight of which is therefore that of the two-cylinder engine, 626 pounds, as these are retained for ends, together with the weight of four cylinders of 90 pounds each between, or $360 + 626 = 986$ pounds. The corresponding weights per horsepower have the following relation, taking that for one-cylinder engine as unity, the numbers representing 1, 2, 3, 4, and 6, respectively, are 1, 0.52, 0.40, 0.335, 0.274. The fact that each intermediate cylinder has added exactly the same weight in this engine indicates that shaft and frame weights per foot have also remained constant, but in some cases, and properly, these are made heavier in passing, for example, from four to six cylinders, so that the small reduction in weight per horsepower above 5 per cent of the weight of the single-cylinder engine is lost entirely, and the six-cylinder would be no lighter than the four per horsepower.

Further weight reduction by arrangement alone is available with multiplication of similar cylinders, not in line axially in a plane passing through and including the shaft, but radially about the shaft in a plane at right angles to it. Two cylinders with axes in line and with connecting rods working on one crank pin, constituting the two-cylinder opposed engine, or two cylinders with axes at right angles also working on one crank constituting the right-angled V engine, add no frame weight for the second cylinder over what the first requires. It really reduces it by the metal required to cover the bore

hole, except for some thickening at the joints. Nothing at all is added to the shaft weight except when the crank pin is made longer, as is rarely the case. This arrangement gives a greater gain in weight per horsepower than two cylinders in line, but when the second cylinder is added radially in another plane and has its own crank it should result in a weight exactly the same as for two in line, because the difference is merely one of rotating one cylinder with reference to the other, retaining the same metal throughout.

These are the two fundamental arrangements of multicylindering for the standard piston-connecting rod-crank engine, and so long as the cylinders remain fixed there is no reason why each cylinder in any combination should not weigh the same and give the same mean effective pressure or thermal efficiency as any other. In this case the weight per horsepower of engine and plant is less the more the cylinders are multiplied and the more the multiplication takes place radially around one crank rather than with separate cranks, up to the point where the shaft and frame thickening must be so great as to compensate for reductions, which begins to be appreciable at four cranks and is very marked at six, except as other details may modify the result.

Fixed-cylinder multiplication radially about one crank presents no objectionable features until the cylinders become inclined differently to the normal horizontal plane, when there enter lubrication difficulties on cylinder-piston surfaces, especially when cylinder heads are lower than the crank shaft. The tendency for oil to work past the piston into the combustion chamber, fouling spark plugs or carbonizing the interior and requiring more oil to keep the surface properly wetted, is strong enough when the head is directly above the shaft, but is stronger when it is lower, and doubly so when the head is directly below. This has prevented the general adoption of any radial arrangement about one crank beyond the horizontal opposed and the 90° to 45° V, set with equal angles to the horizontal. Any more than two radial cylinders compose unequal angles and involve different tendencies to oil flow toward heads in each, so while multiplication in this direction promises greater weight reduction than in line with a crank to each cylinder, the latter has been carried farther in point of general adoption.

The four and six cylinders, each with its own crank, are standard, and doubling the rows of cylinder axes in line without changing the cranks gives the 8 and 12 cylinder opposed, the former used a little, the latter not at all. It also gives, when axes are inclined, the 8-cylinder V, a much used standard, and the 12-cylinder V, but little used so far, but possessing advantages that are promising.

Radial disposition of fixed cylinders which should give the greatest possible weight reduction in frame and shaft has a few representations, notably the air-cooled Anzani, which uses three or five cylinders in one plane on one crank and then duplicates on successive cranks until the 200-horsepower engine is reached, which has 20 cylinders in four planes of five stars each, and five cranks. It is the operation of this and similar engines and of the bold departure of the German Daimler inverted cylinders (Bendeman report), with heads directly under cranks, which makes it doubtful that the old conclusion that such arrangements must lead to fouling is really valid. This latter engine did not foul in the competition, and it will be worth watching in service to see if it continues to keep as clean as do cylinders with

heads above cranks, and not to require excessive amounts of oil to make up for gravitational cylinder wall drainage. If this should work at all right, this arrangement offers further opportunities for weight reduction over the now standard multicrank form.

Even here, however, there is a limit to the number of cylinders that can be radially placed about one crank, a limit imposed by their intersections, and while the rotating Gnome uses a maximum of nine and a minimum of five, the fixed Anzani uses three or five. The Anzani figures for two sets of three are 50 horsepower and 200 pounds, or 4 pounds per horsepower, and for two sets of five 100 horsepower and 330 pounds, or 3.3 pounds per horsepower, the reduction of 0.7 pounds per horsepower, or $17\frac{1}{2}$ per cent, being the effect of using five instead of three per star, all cylinders being of same size. Similarly the effect of doubling the number of rows is shown by comparing the 10-cylinder 100-horsepower with the 20-cylinder 200-horsepower, both having sets of five, the former two sets and the latter four sets. The former weighs 363 pounds, and the latter 682 pounds, the difference of 319 pounds being the weight added to the first 10 cylinders, which themselves weigh 363 pounds, and showing nearly proportionate addition of weight per crank added, the actual addition being 88 per cent. The gain is of course greater in passing from a one crank star to a two than from two to four cranks, as might be expected from the study of cylinders in line. This is shown by the figures for the 3-cylinder, 30-horsepower, 121 pounds, compared to 6 cylinders (two sets of 3 50-55 horsepower, 200 pounds), the second row adding 79 pounds to the first 121 pounds, which is only 65 per cent, as compared with 88 per cent when two rows are added to two to make four.

Increase of cylinders radially about a crank always reduces weight, but the weight reduction is most when the frame and shaft weight is large in proportion to cylinder weight, and least otherwise. Ideally the weight reduction by multiplication of cylinders would be zero if the shaft and frame weighed nothing. This is clearly shown by the figures given by Winkler in Table VII for the proportionate weight of the various parts of fixed auto type and rotating radial cylinder engines. To these figures are added some pound values for the parts computed from Winkler's fractional weights and assumed typical total weights.

TABLE VII.

[NOTE.—The table is based on Winkler's figures for weight distribution in different types of engines. The first three engines are of the fixed cylinder in line type; the last is an ordinary Gnome engine. The total weights have been assumed.]

	100 horsepower 4-cylinder engine.		55-60 horsepower 4-cylinder engine.		150 horsepower 6-cylinder engine.	
	<i>Per cent.</i>	<i>Pounds.</i>	<i>Per cent.</i>	<i>Pounds.</i>	<i>Per cent.</i>	<i>Pounds.</i>
Crank case, complete.....	23.75	95.00	19.00	49.40	23.00	126.50
Cylinders.....	26.00	104.00	30.00	78.00	28.50	156.80
Pistons.....	5.75	23.00	8.50	22.10	7.00	38.50
Connecting rods.....	6.50	26.00	5.00	13.00	9.00	49.50
Crank shaft.....	15.00	60.00	14.50	37.70	13.00	71.50
Cam shaft.....	3.25	13.00	2.00	5.20	2.00	11.00
Valve rods, etc.....	5.50	22.00	4.50	11.70	4.50	24.75
Valves, springs, etc.....	3.25	13.00	2.00	5.20	3.50	19.25
Pump, including connections.....	1.50	6.00	2.75	7.15	1.50	8.25
Carbureter, throttle, etc.....	.50	2.00	1.50	3.90	.50	2.75
Magneto, etc.....	7.50	30.00	7.00	18.20	6.50	35.75
Oiling system.....	.50	2.00	1.25	3.25
Rest.....	1.00	4.00	2.00	5.20	1.00	5.50
Total.....	100.00	400.00	100.00	260.00	100.00	550.00

TABLE VII—Continued.

	Rotating-cylinder engine.			Rotating-cylinder engine.	
	7 cylinders.	50 horse-power.		7 cylinders.	50 horse-power.
	<i>Per cent.</i>	<i>Pounds.</i>		<i>Per cent.</i>	<i>Pounds.</i>
Crank case.....	20.00	30.00	Magneto.....	7.50	11.25
Cylinders.....	27.50	41.25	Oiling mechanism.....	2.50	3.75
Pistons.....	7.00	10.50	Carburetor, including throttle.	1.25	1.875
Connecting rods.....	6.00	9.00	Frame.....	9.50	14.25
Crank shaft.....	8.00	12.00	Rest.....	1.00	1.50
Cam shaft and drive.....	2.00	3.00			
Cam-shaft casings.....	3.75	5.625	Total.....	100.00	150.00
Tappets and rods.....	4.00	6.00			

These figures are most interesting, but must be used with considerable caution, as the Winkler fractions are general averages and when applied to a given engine may give pound values that are somewhat in error. One instance of this appears in the value obtained for the magneto in pounds by applying the general average fraction to a given overall engine weight and which works out in the table as 35 pounds for one and 18 for another. While of course there really may be this difference, it is not fundamental nor is there any acceptance of its accuracy. The really valuable parts of the table are those items for the principal parts, such as cylinders, crank case, pistons, and shafts.

Radial disposition of cylinders does not suffer from inequality of oil flow to combustion chambers only when cylinders and frames are rotated about the crank shaft, but here the tendency toward head-flow is increased by the centrifugal force on the oil, which is far greater than pure gravitation and which apparently is at least a contributing factor to very high oil consumption of these engines and their quick carbonization. It may be that this is more an effect of the use of steel and of high wall temperatures than of centrifugal flow, as such engines are always air cooled by reason of the difficulty of making moving water joints and of controlling water flow with the centrifugal forces acting in jackets and pipes, but everything points the other way. Inverted cylinders having head flow tendencies between these rotating cylinder engines and the normal vertical must be accepted with great caution at present, though there is at present no data that warrant a conclusion. Complete radial star disposition of rotating cylinders gives the smallest possible frame and crank weight per cylinder, but it is not possible to use some of the cylinder constructions and materials that are perfectly feasible in fixed cylinders. Centrifugal forces put cylinders and connecting rods under a tension stress that is pretty large at the high speeds used, and angular velocity changes impose cylinder-bending stresses, due not only to their own overhang but also to the pistons, and these stresses are additional to those imposed by explosion pressures. To reduce these special centrifugal stresses to a minimum, the weights of the parts must be the very least possible, and this is to be accomplished by the use of an assuredly sound and high-tension metal, such as one of the steels. These engines, then, have adopted steel as a cylinder material not so much from choice as of necessity,

and the fact that the surfaces could be lubricated at all has acted as an incentive to its substitution for the old standard cylinder material, cast iron, in the fixed cylinder engines, with corresponding weight reduction per cylinder in that class. The effect of this weight reduction must not be exaggerated. Steel pistons, for instance, are only 12 to 15 per cent lighter than cast-iron ones, since bottom must not be too thin on account of the danger of burning through. Furthermore, pistons weigh only about 7 per cent of the total engine weight. Greater effects are possible when steel cylinders and sheet jackets are substituted for cast iron, yet even here the gain is rather less than might be expected, because of the heads, and the substitution is warranted more on grounds of assumed soundness of forged rolled or drawn steel compared with cast-iron, which may have hidden defects such as blow holes, cold shorts, or bad shrinkage stresses.

In this brief review of the effects of general arrangement of cylinders and cranks on the weight per horsepower, it was assumed that other factors remained fixed, such, for example, as the weight of cylinders per cubic foot of displacement per stroke. Variations in details of construction of the cylinder complete with valves and valve drives, pistons, and connecting rods, such as might affect this unit weight, are not only pretty numerous and cover a considerable range, but taken in conjunction with the corresponding variations of material, the resulting unit weights of the complete cylinders follow no simple law. A type construction of few parts that would tend to lightness may employ a heavier material that equalizes the weight. A somewhat more complicated or essentially heavier construction will often be found associated with a lighter material, producing the same result and unit weight. The combination of lighter construction and material together, cooperating to produce low unit weight, is also found, but unfortunately this is usually offset by lower mean effective pressure and efficiency or by a less favorable general arrangement.

The object sought is the lightest combination of form and material for cylinders, pistons, and their accessories consistent with proper values of the other factors that contribute in the same direction to a higher horsepower per pound of total weight.

It seems pretty clear that designers and inventors of aero engines have started with some favorite general arrangements of cylinders, cranks, and frames and then have selected detail part forms and such material for cylinders and pistons as was either essential, as in the rotating cylinder engines, or as would bring the net result into successful competition with previous engines. To put it otherwise, there is no combination of the various factors that contribute to a low weight per horsepower ratio involving the most favorable value of each factor. This would require the largest number of cylinders that could be disposed radially about one crank, followed by further extension in line on other cranks, as to general cylinders-frame-crank arrangement. It would also require the use of the simplest piston, cylinder, valve, and connecting rod construction, all of steel, operating at the highest speed, and processes, and producing the highest mean effective pressure and the lowest fuel and lubricating oil consumption. Such a combination has so far been impossible and is mentioned here to accentuate the position of the factor at present

under consideration, that of weight per cubic foot of displacement per stroke of cylinders, including all attached parts.

Lightness of metal parts may be secured by the use of large volume of low density material of low stress resistance such as aluminum or by a small volume of metal having high stress resistance but of greater density, such as steel, or some compromise, such as cast iron. If the material were required to perform the stress resistance function alone, the modern steels which can be counted on for upward of 175,000 pounds per square inch elastic limit and some 15 per cent elongation with an ultimate tensile strength approaching 200,000 pounds per square inch, are so superior that nothing else could be considered. That other materials are used at all is due to the fact that the material of some parts must have other properties, each contributing to a different function than that of stress resistance. Piston and cylinder material must have good conductivity, especially the former. Pistons and exhaust valves especially, but to some extent the whole combustion chamber, must resist oxidation under high temperatures and water jackets must resist hot water corrosion. All heated parts should have the lowest possible coefficient of expansion to minimize the thermal stresses of unequal heating, and the expansion characteristics of cylinder material with reference to that of the piston should be such as to oppose seizing on heating. The piston must heat more than the cylinder, so cylinder material should have a higher thermal coefficient of expansion than piston material, though in small cylinders with proper clearance the same material will serve but never should piston metal have a higher coefficient than cylinder metal. Permanent distortion of metals under the heating conditions of operation is not permissible in cylinders, heads, valve seats, valves, and pistons, so some commercial alloys, including some steels, are barred on this account. Finally the metal of these two parts, cylinder and piston, should have such a molecular structure as will lubricate well, cast iron on cast iron is the best, cast iron on steel next best, and steel on steel the worst combination, neglecting the nonferrous alloys which may be serviceable though they are as yet unknown quantities. This is not an absolute necessity except where excessive oil consumption is more important than metal weights. Engines intended for short flights, an hour or so, might very properly have piston-cylinder materials that ignore this, compensation being secured by large oil consumption which adds little weight. But long flights will add enough oil weight to more than offset the weight reduction obtained by making both parts of steel, as compared with both cast iron, or one of each.

About every combination of standard ferrous materials forged, cast, drawn, and rolled for the heated parts that could be produced has been tried, and is even now in use, so it can be definitely stated that practice in ferrous materials is not yet established, which means that there are insufficient data at hand on the differences in their behavior and practically none on the nonferrous. Here is a field for investigation that is of most fundamental importance practically untouched metallurgically, and solution of which requires scientific research under the combined efforts of enginemen familiar with the requirements, of metallurgists familiar with alloy production and properties, and of shopmen familiar with the processes of forming and fitting.

No metal equal to cast iron on cast iron has ever been found for the pistons and cylinders of internal-combustion engines in all the desired properties except one, that of metal weights for a given size. Casting, as a process however, is most uncertain; the known defectives amount to almost 50 per cent while the unknown possibilities and hidden defects are responsible for large factors of safety and the use of excess metal. This excess is quite prohibitive and fruitless in rotating cylinders with the enormous centrifugal stresses that come from speeds exceeding 1,200 revolutions per minute, because each pound excess metal adds its own equivalent centrifugal stress and so fails to add to the certainty of safety as in fixed cylinders. Excess thickness adds to the resistance to heat escape through cylinder walls. It was in these rotating cylinders that the first departure from the older internal-combustion engine practice took place, from sheer stress resistance requirements regardless of other properties. The steel cylinder machined from a forged-steel billet was developed by the French rotating cylinder engine builders, and with cast-iron pistons it operates successfully.

Some builders of fixed cylinder engines encouraged by this demonstration adopted steel for cylinders with cast-iron pistons. Even steel pistons, were tried and in some cases adopted for use in both steel and cast-iron cylinders, apparently without gain, in the former case because of increased lubrication requirements and in the latter from reversed expansion coefficients or permanent distortion. Some of these steel fixed cylinders are cast with heads in one piece and machined all over to disclose defects, but in other cases rolled or forged steel cylinders are combined with cast-iron heads in which ports are most readily formed. The most radical of all these steps is undoubtedly that undertaken by the German Daimler Co. in constructing cylinders, heads, ports, valve seats, and jackets, all of sheet steel welded together by the modern oxygen flame method. Only experience can tell how successful this may prove in practice, though in the competition tests the engine gave a most remarkable performance.

At the present time the only data bearing on the question are those of oil consumption, Table VIII, with respect to materials. This is not a basic figure anyway, and is complicated by variations in oil and in oil application methods, so it is inconclusive though interesting.

TABLE VIII.—Oil consumption versus engine type and cylinder piston materials.

Cylinders and cooling.	Class construction.	Materials.		Engine name.	Authority.	Oil per H.P.-H.	
		Cylinder.	Piston.				
Water-cooled fixed cylinder.	4 cylinders in line..	Cast iron..	Cast iron..	100-horsepower Benz.	Bendemann...	0.042	
	6 cylinders in line..	..do.....	..do.....	100-horsepower Daimler.031	
	8-cylinder V.....	Steel.....	..do.....	..do.....	90-horsepower Daimler.	Bendemann...	.038
				Steel.....	Austro-Daimler..	Maker.....	.027
		Cast iron..	..do.....	Cast iron..	140-horsepower Sturtevant.	..do.....	.045
				Steel.....	150-horsepower Sunbeam.	..do.....
12-cylinder V.....	..do.....	..do.....	225-horsepower Sunbeam.	..do.....	.03		
Air-cooled fixed cylinder.	Radial Star.....	..do.....	..do.....	Salmson.....	Walker, 1912..	.054	
	8-cylinder V.....	..do.....	Cast iron..	Renault.....	..do.....	.045	
	Radial Star.....	..do.....	..do.....	British Anzani..	Maker, Av. of 6.	.164	
Air-cooled rotating cylinder.	1 Radial Star.....	Steel.....	Steel.....	8-horsepower German Gnome.	Maker.....	.167	
	2 Radial Star.....	..do.....	..do.....	160-horsepower German Gnome.	..do.....	.167	
Water-cooled fixed cylinder.	4 cylinders in line..	Cast iron..	Cast iron..	71-horsepower Daimler.	B.....	.047	
	6 cylinders in line..	..do.....	..do.....	100-horsepower Argus.067	
	8-cylinder V.....	..do.....	..do.....	Curtiss.....	Maker.....	.045	
Air-cooled fixed cylinder.	Radial star.....	..do.....	Cast iron..	Wolseley.....	Walker, 1912..	.041	
Air-cooled rotating cylinder.	1 Radial Star.....	Steel.....	..do.....	Anzani.....	Lumet.....	.255	
	2 Radial Star.....	..do.....	..do.....	100-horsepower German Gnome.	Maker.....	.171	
Air-cooled rotating cylinder.	1 Radial Star.....	Steel.....	..do.....	200-horsepower German Gnome.	..do.....	.171	
	2 Radial Star.....	..do.....	..do.....	100-horsepower Daimler.	B.....	.040	
Water-cooled fixed cylinder.	4 cylinders in line..	Cast iron..	Cast iron..	100-horsepower Daimler.021	
	6 cylinders in line..	..do.....	..do.....	100-horsepower Muelag.106	
	8 cylinder V.....	..do.....	..do.....	Hall-Scott.....	Clark, 1912....	.106	
Air-cooled rotating cylinder.	1 Radial Star.....	Steel.....	Steel.....	1911-Gnome.....	Lumet.....	.212	
Water-cooled fixed cylinder.	4 cylinders in line..	Cast iron..	Cast iron..	70-horsepower Daimler.	B.....	.031	
	6 cylinders in line..	..do.....	..do.....	90-horsepower Schroeder.047	
Air-cooled rotating cylinder.	1 Radial Star.....	Steel.....	Steel.....	1911 Gnome.....	Lumet.....	.253	
Water-cooled fixed cylinder.	4 cylinders in line..	Cast iron..	Cast iron..	60-horsepower Daimler.	B.....	.029	
	6 cylinders in line..	..do.....	..do.....	125-horsepower Hall-Scott.	Maker.....	.030	
Air-cooled rotating cylinder.	1 Radial Star.....	Steel.....	Steel.....	1913 Gnome.....	Lumet.....	.255	
Water-cooled fixed cylinder.	4 cylinders in line..	Cast iron..	Cast iron..	{66-horsepower}	B.....	.060	
	6 cylinders in line..	..do.....	..do.....	{87-horsepower Benz.	Maker.....	.022	
Air-cooled rotating cylinder.	1 Radial Star.....	Steel.....	Steel.....	Gyro, 1911.....	Clark.....	.017	

TABLE VIII.—*Oil consumption versus engine type and cylinder piston materials—*
Continued.

Cylinders and cooling.	Class construction.	Materials.		Engine name.	Authority.	Oil per H.P.-H.
		Cylinder.	Piston.			
Water-cooled fixed cylinder.	4 cylinders in line.	Cast-iron..	Cast iron..	100-horsepower N. A. G.	B.....	0.038
	6 cylinders in line.	...do.....	...do.....	100-horsepower (Cheno).	Clark.....	.005
Water-cooled fixed cylinder.	4 cylinders in line.	...do.....	...do.....	95-horsepower N. A. G.	B.....	.009
Water-cooled fixed cylinder.	4 cylinders in line.	...do.....	...do.....	96-horsepower Argus.	B.....	.089
Water-cooled fixed cylinder.	8-cylinder V.....	Cast iron..	Steel.....	1911 Labor-Aviation.	Lumet.....	.073
	12-cylinder V.....	...do.....	...do.....	1911 Aviatric.....	...do.....	.054
	Radial Star.....	...do.....	...do.....	Green.....	Clark.....	.11

There appears to be some relation between oil consumption and cylinder arrangement, but not so with reference to piston versus cylinder materials. For example, radial cylinders seem to require much more oil than vertical cylinders, but there is no conclusive evidence that air-cooled cylinders require more than those that are water cooled. Again, comparing the three Daimler engines as to oil versus materials, it appears that there is no appreciable difference between cast iron and steel cylinders, cast iron and steel pistons, though such a serious conclusion should not finally rest upon a single instance like this.

An effort to retain the low metal weight characteristics of steel and to meet lubrication requirements, that is worthy of note, involves the use of liners for cylinders and of sleeves, or even a separate barrel for pistons, made of a material such as cast iron or bronze having a good lubricating surface. This is not only objectionable as complicating the thermal and total stresses, increasing thermal resistance of cylinders, and adding something to weight removed but it now seems to be unnecessary.

At present the standard material for fixed cylinders is unquestionably cast iron with heads in one piece, and with cast-iron pistons. There is, however, a growing tendency to use tube steel for cylinders. This steel cylinder involves a head complication in shop practice, solution of which is now in course of development. Heads must have irregular forms due to ports and valve stem guides, which are most easily and satisfactorily cast. Such a cast head requires a joint to connect it to a drawn-steel cylinder. As alternatives the following are used, cast-steel cylinders with heads in one piece and cylinder and head machined from a forged billet or finally the complete sheet metal welded Daimler construction.

Steel is the adopted standard material for connecting rods and crank shafts and always is a very high tension alloy such as nickel or chrome nickel, which permits these parts to be very small and

light while amply strong and stiff. Crank case or frame material is still unsettled, ranging from the forged steel cage of the rotating cylinder engine through cast steel, cast iron, and aluminum, with the last prevailing in fixed cylinder engines. No successful attempt is yet on record, to use welded or riveted sheets and standard structural steel shapes in the long frames and crank cases of fixed cylinder multicrank engines, where frame weight per cylinder is a matter of considerable importance. It would seem as if stiffness or its equivalent uniformity of distortion can better be served with less weight by such structural steel construction than by the soft aluminum casting. To give a general survey of the practice in materials, Table IX is added.

TABLE IX.—Materials

Engine or makers' name.	Cylinder and crank arrangement rotating part.	Cooling medium and system.	Horse-power.	Number of cylinders.	R. p. m.
Benz.....	Vertical fixed separate.....	Water, C. P.....	{ 88 108 150	{ 6	{ 1,250 1,250 1,250
Hall-Scott.....	do.....	do.....	125	6	1,300
Frederickson, 2-cycle	Cylinders, rotating shaft, stationary.	Air.....		{ 5 10	
Sturtevant.....	V-type, L head, cast in pairs.....	Water, C. P.....	140	8	2,000
Sunbeam.....	V-type, L head, en bloc.....	do.....	{ 150 225	{ 8 12	{ 2,000
Austro-Daimler.....	Vertical fixed separate.....	do.....	{ 90 120	{ 6 6	{ 1,300 1,200
Le Rhone.....	Rotating cylinders, shaft stationary.	Air.....	{ 80 160	{ 9 18	{ 1,200 1,150
British Anzani.....	Fixed star.....	do.....	25-200	3-20	1,250
Rausenzerger.....	V-type, separate cylinders, valves in head.	Water.....	150	12	1,200
Argyll.....	Vertical fixed, sleeve valves, separate cylinders.	do.....	120	6	
Wright.....	Vertical fixed, separate cylinders, heads screwed in.	Water, C. P.....	60	6	1,400
Sturtevant.....	Vertical fixed cylinders en bloc, T head, 4 valves per cylinder.	Water.....	100	4	2,000
Curtiss.....	V-type, separate cylinders, L head, 4 valves per cylinder.	do.....	200	8	1,500
Chenu.....	{ Vertical fixed cylinders in pairs, T head.	{ do.....	{ 65 90 100 850	{ 4 4 6 6	{ 1,800 2,300 1,600 1,500
Clerget.....	{ V or vertical fixed separate cylinders, valves in head.	{ do.....	{ 50 100 200	{ 4 4 8	{ 1,450 1,300 1,300
Do.....	{ Rotary cylinders, valves in head, mechanically operated.	{ Air.....	{ 50 80	{ 7 7	{ 1,180 1,180
De Dion Bouton.....	V-type, separate cylinders, L head.	do.....	80	8	1,800
Edelweiss.....	{ Radial star, fixed pistons, reciprocating cylinders.	{ do.....	{ 75 125	{ 6 10	{ 1,350 1,350
Laviator.....	{ V-type, separate cylinders, valves in head.	{ Water.....	{ 80 120	{ 8 8	{ 1,200 1,700
Panhard-Levassor...	V-type, cylinders en bloc, L head.	do.....	100	8	1,500
Salmson.....	Fixed star, valves in head.....	do.....	{ 90 135 200 300	{ 7 9 14 9	{ 1,250 1,250 1,250 1,200
Wolsley.....	{ V-type separate cylinders, valves in head.	{ Combination wa- ter.	{ 82 130	{ 8 8	{ 1,650 1,200
Green.....	Vertical fixed, separate cylinders, valves in head.	Water.....	100	6	

NOTE.—I= integral head; C. P.=centrifugal pump.

for engine parts.

Materials for—									
Cylinder.	Cylinder heads.	Cylinder jackets.	Head jackets.	Pistons.	Valves.	Connect- ing rods.	Crank shafts.	Frames or crank case.	
								Upper.	Lower.
Cast iron.	I.	Sheet steel, welded.	Sheet steel, welded.						
do.	I.	I.	I.	Cast iron.	Tung- stensteel.	I-section chrome nickel steel.	Chrome vana- dium steel.	Alum- inum alloy	Alum- inum alloy.
do.	I.			do.	Cast iron, rotary rocking.	Nickel steel.	Nickel steel.	Cast iron with nickel-steel rings shrunk over.	
do.	Cast iron.	I.		Semisteel.	Tung- sten	H-section chrome nickel steel.	Chrome nickel steel.	Aluminum alloy.	
do.	I.	I.	I.	Steel.		H-section high tensile steel.	High tensile steel.	Do.	
do.	I.	Copper electrol dep.	Copper electrol dep.	Pressed steel.					
Steel with cast-iron liner.	I.			Steel.					
Cast iron.	I.			Cast iron.	Nickel steel.	I-section nickel steel.	Nickel chrome steel.	Do.	
do.	I.	Spun copper pressed on and locked by steel rings.		do.		H-section nickel steel.	Chrome vana- dium steel.	Do.	
Forged steel.		Sheet steel, welded.							
Cast iron.	Cast iron.	I.	I.	Cast iron.	Valve heads, cast iron.	H-section chrome nickel steel.	Chrome nickel steel.	Do.	
do.	I.	I.	I.	Semisteel.					
do.	I.	Monel metal, welded.	Monel metal, welded.		Tung- sten steel.	I-section.	Krupp steel.	Do.	
do.	I.	I.	I.					Do.	
Steel.	I.	Copper electrol deposited.							
Forged steel.								Steel.	
Steel.				Steel.				Aluminum alloy.	
High tensile steel.				Cast iron.				Special alumi- num frame.	
Steel.	Air cooled.				Concen- tric valves, nickel steel.				
Cast iron.	I.	I.	I.						
Forged steel.	I.	Spun copper, cor- rugated, brazed.		Cast iron.		H-section.		Aluminum alloy.	
do.	I.	Copper.	Steel exhaust valve boxes.	Forged steel and phosphor- bronze bearing rings.		Tubular		Do.	
Cast steel.		Spun copper.	I.	Cast iron.	Nickel chrome steel.	Nickel chrome steel.	Chrome vana- dium steel.	Do.	

Form of cylinder proper including head is a direct contributing factor in the cylinder weight per horsepower, as is also to some extent the proportions. For a given bore and stroke, and made of the same material, all cylinders would weigh the same if they were similar in form, and as they are not similar the differences in form must account in some measure for total weight differences. That form that gives the least metal volumes evidently should be lightest. On this basis air-cooled cylinders with their radiating heat dissipating ribs, casings and baffles are heavier than water-cooled cylinders of the same bore, stroke, material, and similar valves. This excess weight of the air over the water-cooled cylinder added to its fan weight, when subtracted from the weight of radiator, pipes, pumps, and water, measures the excess weight of the water-cooled cylinder with its accessories. With radiators especially designed for lightness and for a minimum supply of water rapidly circulating, there is no essential reason why the air-cooled cylinder engine complete should weigh materially less than the water cooled. As a matter of fact, the actual difference itself is small, even when all contributing factors in each case are not equally well selected, as appears from the comparison of the weights of some well-known eight-cylinder V engines given in Table X.

TABLE X.—Comparative weights per cubic foot displacement of air and water cooled 8-cylinder V engines.

Engine or makers' name.	H. P.	R. P. M.	Bore (inches).	Stroke (inches).	Displacement (cubic foot per stroke).	Total weight, engine complete.	Engine weight per cubic foot per stroke.	Remarks.
Curtiss.....	75	1,100	4.00	5.00	0.2912	300	1,030	Water cooled. Water-cooled engines give weights without radiator water.
	100	1,250	4.25	5.00	.3260	340	1,034	
	160	1,100	5.00	7.00	.6370	700	1,100	
Sturtevant.....	140	2,000	4.00	5.5	.321	550	1,715	
	150	2,000	3.54	5.91	.271	610	2,245	
225	.407				905	2,245		
Sunbeam.....	150	1,200	4.125	6.0	.557	590	1,060	
Rausenberger.....	200	1,200	5.512	6.290	.665	640	921	
Clerget.....	80	1,200	3.937	5.118	.289	275	952	
Laviator.....	120	1,200	4.488	6.290	.465	418	900	
Panhard-Levassor..	100	1,500	4.331	5.512	.372	440	1,183	
Wolseley.....	130	1,200	5.0	7.0	.637	700	1,100	
De Dion-Bouton...	80	1,800	4.173	4.724	.303	465	1,535	Air cooled. Weight given includes 2 exhaust connectors; also fan.
Renault.....	70	1,800	3.780	4.724	.233	396	1,700	Do.
Wolseley.....	82	1,650	3.750	5.500	.281	438.5	1,370	Cylinder barrels. Air cooled. Exhaust valves. Water cooled.

¹ Without flywheel.

NOTE.—Engine weights taken from Table I, where sources of information are given.

There is a somewhat surprising range of weights here and one that bears close study as directly related to design, form, and material quite independent of speeds and mean effective pressures. The lowest value is 900 and the highest 2,245 pounds per cubic foot of suction stroke. There seems to be no doubt of the superiority of head-valve construction over side-pocket valves in weight reduction, and there is no marked difference between an air and a water cooled

construction. This last conclusion is most important in view of the consistent inferiority of air cooling with reference to mean effective pressure and fuel consumption. Next to general arrangement, weights per cubic-foot displacement are fundamentally related to materials and wall thickness.

Cylinder metal volumes are least in any cylinder, other things being equal, when the valves are placed in the head instead of in side pockets, so in the interest of cylinder lightness this arrangement must be adopted unless it appears that the compensating factors, which will be referred to later, overbalance the extra pocket metal, but this is not the case. There are, however, several successful aero engines that follow the standard automobile practice of locating valves in side pockets mostly of the L-head form. One arrangement has the valves side by side, both stems pointing toward the crank case, both seating down in a wide pocket. The other locates the two valves axially in line, one stem pointing up, while the other points down, and seating on opposite sides of a narrow pocket.

The compensating weight elements referred to in connection with the head valve as compared with the side-pocket valve arrangement are those of valve gear. Two side by side valves in one wide pocket are ordinarily driven by a pair of push rods. Placing one valve above the other in a narrow pocket reduces the width and hence the metal of the pocket, but adds a rocker arm with bracket and pin and some additional rod length. Placing both valves in the head removes the pocket metal entirely, but adds a second rocker and push-rod extension ordinarily. It is the weight of these two rockers and push-rods extension that is to be balanced against the metal of the pocket. Such side pockets with ports, being irregular in shape and necessarily jacketed, can be formed, as in the case with cylinder heads that carry valves, only by casting (except when welded of sheet metal as in the Daimler experiment). The added cast iron due to pockets in combustion chamber and jacket wall will weigh more than the steel rocker arm and the push-rod extension. The weight difference in favor of the head-valve arrangement is greater still when a single rod alternately works in tension and compression on one rocker actuating both valves, as in the Austro Daimler, but in this case two different cams should be used, one to lift and the other to depress. Further reduction is possible in standard four and six cylinder engines by placing the cam shaft directly on the heads as in the German Daimler, for here the combined weight of all push rods is removed and the weight of a pair of gears and a vertical shaft introduced instead. This is no advantage, however, in V engines, because with the push-rod drive one cam shaft can serve both rods, and this is one of the advantages of V arrangement. Removal of one push rod and cam entirely becomes possible when the inlet valve is made automatic as it is in several engines, but the loss of volumetric efficiency resulting cuts more from the power than removal of push rod even with rocker does from the weight. For this reason automatic valves are not to be recommended, though there is another reason also strong enough alone, that of unrestrained seat impact.

Water-jacket metal in all cast cylinders will normally weigh more than the metal of the cylinder proper inclosed by it, in spite of the fact that it might be made thinner, due to lack of pressure loading in

one case and in the very high internal pressures in the other. The area of the jacket metal is considerably greater than that of the cylinder, especially when the water space is large, and the foundry can not make a sound jacket casting as thin as lack of stress would warrant. Accordingly, while the cast jacket is retained in many aero engines in accordance with automobile practice, this can hardly be accepted as the best aero engine practice, which seeks weight reduction by legitimate removal. Sheet metal of copper, brass, aluminum, or steel in sheets, in drawn tubes, spun and die pressed shapes is so peculiarly adapted to the purpose that its lack of immediate general adoption requires explanation. This is to be found first in the joint difficulty originally encountered in automobile practice, where such a mechanical discouragement was sufficient to cause rejection in view of the slight importance of the weight relation to automobiles, especially as the cast jacket is cheaper. With aero engines the case is different because the need of saving every ounce is vastly greater, and the cast jacket is a larger fraction of the total weight when all the other economics have been practiced, so the per cent gain by sheet metal substitution is great enough to warrant efforts to find suitable joints. This has been accomplished in a variety of ways, one of them being especially noteworthy, viz, electrolytic deposition of the whole jacket metal or electrolytic deposition of the joint. Added to this is the now generally available method of the oxygen flame weld, beside the usual screw-cover and press-fit joint which has always been available. Experience with these sheet-metal jackets has indicated the necessity for expansion provisions to avoid overstressing of the joint when the cylinder expands, exactly as in big gas engines. This conclusion is itself a measure of the distortional stresses set up in one-piece castings and an additional reason for their abandonment. To these advantages of weight reduction and relief of cylinder metal from jacket stress, the sheet metal jacket gives additional assurance of safety when jacket water freezes, and especially with cast heads or cylinders permits complete assurance of the external soundness of the cast metal that is to resist explosion pressures and of the reality of water spaces, which when cored may be filled with metal in corners where the designer intended water to be, so adding to expansion stresses and preignition tendencies that result from the consequential overheating.

At least three openings to the combustion chamber through the jacket space are necessary for insertion of inlet valves, exhaust valve, and igniter. The outer ends of these passages must be joined at the jacket wall by the jacket itself and the use of sheet-metal jackets calls for joints at these points. These offer no difficulty if welded autogenously or accomplished by electrolytic deposition, though considerable pressure joints are apt to be troublesome. Expansion is provided in three separate ways, (a) the slip joint, packed by a rubber ring as in Green (British), (b) corrugated bellows, (c) the elongation of a thin jacket of suitable metal provided the joint is welded as in the Benz (German) which seems quite satisfactory.

Jacket water spaces are usually made narrower on aero engines than others but the width may properly be even further reduced to hardly more than a water film as the corresponding high water velocity is beneficial to heat abstraction around the barrel. On the

heads greater width is usually necessary to avoid the formation of pockets where air or steam may collect next to the irregular port walls, and the outlet for water must be at the highest point to promote expulsion of any bubbles. Jacket lengths on the cylinder barrel are usually short, normally extending little if any below the lowest position of the piston head. This is not as satisfactory as a longer jacket even if the space be narrow, especially as the cylinder walls are so thin as to have a minimum of heat-conducting capacity longitudinally. The piston barrel will give heat to every part of the cylinder wall with which it comes in contact and if at some low part there is no water, then the heat must be dissipated to the air directly or conducted up to where the jacket starts.

Provisions for valve insertion and removal, to facilitate inspection and regrinding, are used in the very best large internal-combustion engine practice but would add weight to the aero engine if adopted. Inlet valves are carried in cages, which, with their fastening and the necessary additional guide walls, add several times the weight of the valve. Through the opening of the removed inlet cage the exhaust valve, which must seat on water-cooled metal, becomes accessible. This accessibility of valves is the primary recommendation for the side pocket, which permits of the use of the above construction when both stems are opposed in line as in the Mulag. In the parallel construction it is accomplished by two covers, one over each valve, as in Sturtevant. It is also attained in the head valve arrangement without cages by the separate or removable head which in aero engines is objectionable for many reasons. This problem has been boldly met by the designers of many of the best aero engines by simply providing a joint between cylinder and frame that is easy to loosen and by using valve gear and pipe connections that are quickly detachable, so the entire cylinder, which even in the largest sizes is not heavy, can be bodily removed by hand with ease and the valves reached through the bore. In this way the number of parts is kept to a minimum and a material contribution to low cylinder weight is secured.

Low valve weight would demand the thinnest disk and stem and the shortest possible stem, but process considerations are in opposition to this conclusion, especially in exhaust valves where heat dissipation is opposed thereby. Practice oscillates between these two extremes, but the heavy construction of exhaust valves must be favored while the light is permissible on self-cooling inlets, unless it be regarded, as in marine and automobile practice, unwise to use two different valves in the interest of reduction of spares. It is otherwise perfectly feasible to make inlet valve disks thin with short stems of small diameter, and exhaust valves thick with large diameter stems, perhaps taper bored from the end toward the disk, and long enough in the guides to dispose of the heat. If a metal of high conductivity could be found otherwise suitable, then exhaust-valve thickness might be reduced. Keeping the weights now used for both valves, the excess desired in exhaust valves can be secured by reducing the inlets, though many good engines are amply well cared for in this respect. Valve material is invariably steel, forged to meet the requirements of inertia and impact shock at high speeds and of corrosion, especially in exhaust valves, and alloy steels seem better adapted than carbon steels for this purpose. Shock troubles of

broken stems, battered push rods, and worn seats would all disappear if some form of good rotary valve could be evolved, and this is a most attractive possibility with as yet no realization in sight, though the case is by no means hopeless.

A general comparison of water cooled cylinder weights with various constructions of jackets, valve location, and drives, per cubic foot of displacement per stroke, is given in Table 11 to show limiting effects of various structural details, but unfortunately in an inconclusive way for cylinders alone, as shafts and frames are included.

TABLE XI.—Weights of engines per cubic foot displacement (per stroke) versus type construction of parts.

Cylinders and cooling.	Class construction.	Cylinder material.	Valve location.	Suction valve, A. or M.	Name.	Bore.	Stroke.	Revolutions per minute.	Weight per cubic foot.
Water-cooled fixed cylinders.	4 cylinders in line.	Cast iron.	Head.	M.	Bena.....	5.180	7.087	1,288	1,075
					Sturtevant.....	4.5	6.0	2,000	778
					Daimler.....	4.724	5.312	1,315	1,418
	6 cylinders in line.	Steel.	Head.	M.	Mulg.....	4.331	6.693	1,346	1,536
					Daimler.....	4.134	5.512	1,387	1,301
					Curtiss.....	4.00	5.0	1,100	1,030
	8 cylinders, V.	Steel.	Pocket.	M.	Sturtevant.....	4.00	5.50	2,000	1,718
					Laviator.....	3.937	5.118	1,200	952
					Sunbeam.....	3.54	5.91	2,000	2,225
	12 cylinders, V.	Steel.	Head.	A.	Laviator.....	3.937	5.118	1,300	1,115
					Salmson.....	4.724	5.512	1,250	947
					Wolsley.....	3.750	5.900	1,650	1,370
Fixed cylinders.	Radial star.	Cast iron.	Head.	M.	De Dien Bouton.....	3.780	4.724	1,830	1,535
					Renault.....	3.51	4.72	1,800	1,511
					Anzain.....	3.54	5.12	1,250	837
Rotating cylinders.	Horizontal opposed cylinder	Steel.	Pocket.	M.	Ashmussen.....	4.13	4.92	1,800	865
					B. M. & F. W.....	3.75	4.5	1,051	1,000
					German Gnome.....	4.331	4.724	1,200	625
Water-cooled fixed cylinders.	4 cylinders in line.	Cast iron.	Head.	M.	Daimler.....	4.724	5.512	1,412	1,375
					Chem.....	4.331	5.118	1,800	1,468
	6 cylinders in line.	Steel.	Head.	M.	Argus.....	4.921	5.118	1,370	1,391
					Green.....	5.512	5.981	1,600	1,527
	8 cylinders, V.	Cast iron.	Pocket.	M.	Curtiss.....	4.25	5.00	1,250	1,084
					Sunbeam.....	3.54	5.91	2,000	2,245
12 cylinders, V.	Cast iron.	Head.	M.	Laviator.....	4.888	6.269	1,200	2,000	
	Cast iron.	Pocket.	M.	Rausenberger.....	4.125	6.00	1,200	1,060	

1 With flywheel removed.

NOTE.—Engine weights taken from Table I where source of information is given.

TABLE XI.—Weights of engines per cubic foot displacement (per stroke) versus type construction of parts—Continued.

Cylinders and cooling.	Class construction.	Cylinder material.	Valve location.	Suction valve, A. or M.	Name.	Bore.	Stroke.	Revolutions per minute.	Weight per cubic foot.
Air cooled:									
Fixed cylinders.....	{ 8 cylinders, V Radial star.....	Steel..... Cast iron.....	Pocket..... Head.....	M..... A.....	Renault..... Anzani.....	3.780 4.13 4.53 4.13	4.724 5.71 6.10 5.52	1,800 1,250	1,700 825 811 801
Rotating cylinders.....	{ 1 radial star 2 radial star.....	Steel..... do.....	do..... do.....	A..... A.....	Gyro..... German Gnome.....	4.269 4.88 4.88	4.748 5.51 5.91	1,200	511 461
Water-cooled fixed cylinders.....	{ 4 cylinders in line 6 cylinders in line.....	Cast iron..... do.....	Head..... Pocket..... Head..... Pocket.....	M..... M..... M..... M.....	Daimler..... Chenu..... Scherer..... Chenu..... Curtiss.....	5.512 4.331 4.882 5.906 5.00	5.906 5.118 6.299 7.874 7.00	1,373 2,300 1,252 1,500 1,100	1,310 1,491 1,010 1,270 1,100 1,183 1,100
Air cooled:									
Fixed cylinders.....	{ 8 cylinders, V Radial star.....	Steel..... Cast iron.....	Head..... do.....	M..... M.....	Panhard Levasson..... Wolsley..... Edelweiss.....	4.331 5.0 4.528	5.512 7.0 4.724	1,500 1,200	1,052 893 569 646
Rotating cylinders.....	{ 1 radial star 2 radial star.....	Steel..... do.....	do..... do.....	A..... M.....	Gnome..... Le Rhone.....	4.522 4.724 4.13	4.724 4.724 5.51	1,350 1,194 1,150	
Water-cooled fixed cylinders.....	{ 4 cylinders in line 6 cylinders in line.....	Cast iron..... do.....	Head..... do.....	M..... M.....	Daimler..... Hall-Scott.....	4.724 5.	5.512 7.	1,343 1,300	1,500 1,132
Air cooled:									
Fixed cylinders.....	{ Radial star.....	do.....	do.....	2-cycle A.....	Laviator.....	3.937	5.118	1,200	912
Rotating cylinders.....	{ 1 radial star.....	Steel.....	do.....	A.....	Gnome.....	5.118	4.724	1,156	467
Water-cooled fixed cylinders.....	{ 4 cylinders in line 6 cylinders in line.....	Cast iron..... do.....	Head..... do.....	M..... M.....	Daimler..... Austro Daimler.....	4.331 4.72 4.33	5.512 5.51 4.72	1,336 1,300 613	1,564 1,090 613
Air-cooled rotating cylinders.....	{ 1 radial star.....	Steel.....	do.....	A.....	German Gnome.....	4.80	4.72 5.51	1,200	563 534

Water-cooled fixed cylinders.....	{ 4 cylinders in line.....	Cast iron.....	Head.....	M.....	Daimler.....	4.724	5.512	1.391	1,518
Air-cooled rotating cylinders.....	{ 6 cylinders in line.....	do.....	do.....	M.....	Austro Daimler.....	5.12	6.89	1,290	975
	1 radial star.....	Steel.....	do.....	A.....	German Gnome.....	4.88	5.91	1,200	507
Water-cooled fixed cylinders.....	{ 4 cylinders in line.....	Cast iron.....	Head.....	M.....	N. A. G.....	5.315	6.224	1,314	1,265
Air-cooled rotating cylinders.....	{ 6 cylinders in line.....	do.....	do.....	M.....	Benz.....	4.17	5.91	1,230	1,351
	1 radial star.....	Steel.....	do.....	A.....	Frederickson.....	4.50	4.75		680
Water-cooled fixed cylinders.....	{ 4 cylinders in line.....	Cast iron.....	Head.....	M.....	N. A. G.....	4.724	4.724	1,408	1,272
Air-cooled rotating cylinders.....	{ 6 cylinders in line.....	do.....	do.....	M.....	Wright.....	4.375	4.5	1,400	1,300
	1 radial star.....	Steel.....	do.....	M.....	Le Rhone.....	4.13	5.51	1,200	691
Water-cooled fixed cylinders.....	4 cylinders in line.....	Cast iron.....	Head.....	M.....	Argus.....	5.512	5.512	1,368	1,205
Air-cooled rotating cylinders.....	1 radial star.....	Steel.....	do.....	M.....	Clerget.....	4.724	4.724	1,180	888
						4.724	5.900	1,180	513
Water-cooled fixed cylinders.....	4 cylinders in line.....	Cast iron.....	Head.....	M.....	Argus.....	4.921	5.118	1,312	1,385

Here, again, the superiority of the head over the pocket valve arrangement, and the indifference of air versus water cooling, are demonstrated, but in addition the steel cylinder is shown to be superior to the cast iron. As to arrangement of cylinders with reference to crank shaft, comparing the four and six in line, the 8 and 12 cylinder V, there is nothing conclusive demonstrated, though for the latter there are insufficient figures available. Radial star arrangements are consistently lighter than the above, not as much as might be expected for fixed cylinders, but quite markedly so for the rotating, which in round numbers weigh only half as much as the line arrangements. It is the consistent use of steel for cylinders in the rotating against the cast iron in the fixed star arrangements that is responsible for the weight differences reported rather than rotation versus fixity.

Cylinder weight must have some relation to the ratio of bore to stroke for equal displacements, and the variation of stroke per unit of displacement must affect as well the shaft and frame weights. The thickness of the cylinder walls should vary directly with the diameter for explosion pressure stress resistance, while displacement varies directly as the square of the diameter, and directly as stroke. The actual ratios of stroke to bore will be between one and two, the former giving a very short and the latter a very long stroke engine according to practice. The short-stroke cylinder will require a thicker wall than the long for stress resistance, but the difference is so small in view of shop limits and the small diameters that it can be neglected. Even allowing extra thickness, the short-stroke engine will be lighter than the long as to cylinder weight and doubly so when the increased thickness of crank and larger crank case necessary are included. More effect on weight reduction is possible by offsetting cylinders than by working to extremes of stroke bore ratio, as this reduces the height of engine, especially when the connecting rod is shortened as it may be at the same time to equalize the side thrust friction on the two sides of the cylinder wall. This offsetting is quite generally practiced, though it is by no means universal, and weight reduction possible by this means is small.

Cylinders when cast are cast sometimes singly, sometimes two, three, or even four together, to make up multicylinder engines, and this is a factor in weight reduction. Casting a single cylinder complete with head and cast jacket is the old standard practice for small stationary engines, and the method first adopted for auto engines. Such cylinders simplify and cheapen the construction of multicylinder engines of different numbers of cylinders to give different horsepower units, as the only change required to get a new capacity engine is in frame, cam shaft, and crank shaft. When automobile engines became standardized to the four cylinders in line, four crank form, it became evident that weight would be saved and compactness promoted by casting two cylinders in one piece, the jacket consisting of two semicylindrical and two tangent flat plate elements for the barrel, and two semicircular and one flat plate nearly square, connecting member for the top instead of two circles. This produced a stiff structure which permitted a reduction of frame or crank case stiffness, and it shortened the frame and shaft, but required the elimination of one main bearing between the cylinders, for which with this arrangement there is not sufficient room. As a partial offset there is required a somewhat thicker crank and shaft to com-

pensate for the increased bending moment that follows the spreading of main bearings as supports. This practice of casting two cylinders enbloc for four-cylinder engines is equally adapted for six, and is quite commonly adopted, though not universally. Aero-engine practice followed in part this auto and marine practice for cast cylinders of making two enbloc, so that the four-crank engine has three and the six-crank engine four main bearings.

Cylinder removal is facilitated by separate cylinder castings, because there are less parts to be detached, and the weight to be lifted is the least. Separately cast cylinders are better adapted to sheet-metal jackets, so aero engines departed from automobile two enbloc practice in casting such cylinders separately and leaving a bearing between each crank. The four crank engine then has five, the six crank, seven bearings, and the whole engine is symmetrical. This is perfectly sound and good practice, for there are no more important members than the crank shaft and the frame. By this construction the maximum stiffness and best distribution of main-bearing surface is secured, with least deflection at crank pins, and the extra shaft and frame length is worth the small cost in weight, for the weight increase is very small. Steel cylinders are always separate and can be substituted for the cast cylinders with sheet-metal jackets on this type of frame and shaft without any alteration whatever, as may also air-cooled cylinders, which by the very nature of the problem of air cooling can not be cast in pairs at all.

Frame form, for connecting cylinders and main bearings, has a very large influence on the weight per cylinder in multicylinder multicrank engines, because the more direct the stress resistance, the less the metal required. As evolved from old stationary and marine steam engine practice, the main bearings support the shaft from below, the caps being removable upward, which requires a two-part frame. The lower frame member consists of a cross web to carry each main bearing, and these are tied together by a longitudinal web just out of reach of the crank throw, so for a multicrank engine this lower frame member becomes essentially a semicylindrical box with a semicircular cross partition for each main bearing. The upper frame member ties the cylinders to this box by another box, or by the A form of double column. The latter receives a cylinder at its upper ring end, and its legs seat on the lower frame in the plane of the crank path. Thus the stress which is alternately tension and compression in standard steam engines, is communicated from cylinders to main bearings in a decidedly roundabout way. The same is true of the second or box form of upper frame member as to indirectness of stress transmission, for here the upward cylinder thrust is received by a flat plate with holes in it, one for each cylinder, and this horizontal flat plate transmits it down two inclined semi-vertical plates to the edges of the cylindrical box of the lower frame member, which carries the vertical main-bearing cross webs.

Single-acting internal-combustion engines are subjected to a frame stress from explosion-gas pressures; that is, a pure tension between cylinders and main bearings, although inertia of reciprocating parts at high speeds on idle strokes may introduce a compression equivalent to the double-acting steam engine. Aero engines are necessarily light and their parts also, so that there is no real necessity for bottom gravitational support of the crank shaft, nor for keeping the old

scheme of removal through end holes in box frames or sidewise through removable columns. Aero-engine crank shafts can perfectly well be supported below by bearing caps, removal of which permits the shaft to drop free. This greatly simplifies the frame which need not be more than a short cross web hanging between cylinders under a horizontal flat plate with holes for each cylinder. This cross web, if cast of aluminum, can be formed for compression resistance as a column, and steel tension rods inserted to relieve it entirely for the tension stress it can not resist. The substitution of steel shapes welded or riveted for the aluminum casting is perfectly feasible in such form as to equally well serve as struts and ties. Resistance of longitudinal bending of crank shaft due to the relative forces at two different cylinders or cranks, is easily resisted by side plates in the cast form, or by diagonal latticed braces in the structural form. This means the elimination of the old lower frame member entirely and the substitution for purposes of inclosure of a mere shell subjected to no stress whatever, but formed solely in the interest of an unstressed oil-tight inclosure.

Aero-engine frames have not all developed along these lines, practically all being of cast aluminum and only a few introducing the steel tension rod, Green for example, while a great many retain the bottom web, leaving a hole where the more serviceable upper direct web should be. There are no structural-steel frames. Reference is made to the illustration in the appendix to frame constructions which should be judged in this light. Modifications of frames along these lines will materially improve the stiffness and life of main bearings, which should reduce lubrication difficulties as well, for the same frame and shaft weights now used, or result in an equivalent weight reduction.

Main bearings are almost universally of the plain type lined with so-called antifricition or white metal, though in a few cases ball bearings, which seem ill adapted, have been employed. The thrust bearing, which is peculiar to aero as compared to auto engines, because the useful effect of all power developed lies in propeller thrust against the frame, must be suitably supported by the frame. As the loads are not severe, and the thrust not irregular as in main bearings, but reasonably steady and always in one direction, this offers no difficulty. The longitudinal side plates connecting the main bearing webs, to make the frame stiff as a beam, are equally serviceable in making it serve as a column loaded by propeller thrust, if the end plate be suitably stiffened. This end-plate stiffening is all the frame modification required to receive the thrust bearing.

Aero-engine pistons follow almost universally the practice in auto engines as to use of cast iron as a material, but vary in practically every other respect. They are invariably shorter and thinner, being machined all over as nearly as pin bosses permit, in an effort to reduce weight, which in many cases has been carried entirely too far. Unless normal speeds are made higher than at present, say 1,500 revolutions per minute, the piston weight can be considerably greater without developing inertia forces equal to explosion pressures. With present piston weights this equality between explosion pressure and inertia forces is reached about 2,500 revolutions per minute. In any case metal sufficient for heat conduction must be available, and

reduction on this basis becomes legitimate only when better thermal conductors than cast iron, such as aluminum, copper, or the bronzes, are substituted for it. Complete substitution is difficult, in view of their expansion coefficients and low stress resistances, but these materials can be used as supplementary conductors to stiff cast-iron piston frames. As piston-weights of any one design increase per square inch of piston, the use of a large number of small pistons results in legitimate piston weight reduction over a smaller number of larger ones of equal area. With the exception of the brass L section single top ring of the Gnome engine, aero-engine piston rings differ not at all from the cast-iron ring of auto engines. Usually the thin lower end of aero-engine pistons is stiffened by an internally projecting web, which is an excellent feature and should be retained, however heads and upper barrel are increased. Flat heads, being structurally weak and inflexible, should be definitely abandoned, as is also the case with any cast ribs on the under side of the head, especially as these are useless in tension and involve shrinkage stresses in the making. Downward curving or concave heads being in tension, must likewise yield to the convex upward or domed pistons such as the Daimler, which, without ribs, is the best possible form, but these would be much improved by thickening at the edges. Wrist-pin bosses, while in a few cases separately attached, are normally cast integral, a practice that leads to least metal for strength, though the deformation tendency on expansion is unfavorable.

As a partial compensation for the increased unit side thrust due to shortening of pistons and use of short connecting rods, there is a marked tendency to offset the cylinders an amount recommended by Vorreiter as one-eighth the stroke. This is of no assistance whatever when inertia forces are as high as they should be, as on the suction stroke a side thrust equal to that developed by gas pressure alone is imposed on the other side, so that the symmetrical cylinder setting in line with crank shaft should not be abandoned for this reason. The principal value of offsetting is reduction of engine height.

Wrist pins are properly made hollow in some cases to reduce weight, while leaving enough metal to resist undue stressing and securing the maximum bearing area for the rod end. They should always be hollow. The old bad practice of tapering pin ends is often retained, though in view of its natural tendency to work the pin toward the big end, to loosen and to score the cylinder, which tendency is only opposed by excessive locking requirements, should have been long ago abandoned. Plain cylindrical-ended pins, of two diameters but slightly different, is the best practice, and the next best is a straight pin or tube locked in the bosses. Bearings in the bosses with pins fixed in rod ends have never proved satisfactory in other engines, and there is no difference in aero engines that warrants a different conclusion.

Connecting rods follow the usual auto practice in having the wrist-pin end solid forged, bored, and bushed, with the old split-marine form of crank-pin end, lined with soft metal, and forged of steel. They are, however, universally of high tension alloy steel of sometimes tubular, but almost universally, I section. The special rod forms are confined to the rotating cylinder engines with many rods per crank, where each engine is characterized by some arrangement peculiar to itself, all involving, however, a single bearing embracing

the crank pin, to which the other rods are movably attached to allow the small relative oscillation of each with reference to this bearing. This system, which for the want of a better name, may be called the master-and-shoe rod-end construction, even though the name applies to only one form, is adapted to the double rod per crank construction of the V engine as a substitute for the separate embracement of the crank pin by each rod, either of similar rod ends side by side or one straight and the other forked, as the master and shoe results in lower mean pressures and less friction than the double direct.

Weight of engine proper per horsepower is, as pointed out, not to be secured by reducing engine metal alone or by raising speed alone, but may follow a raising of mean effective pressures without any change in metal or speed. It may also be secured with the same metal by maintaining mean effective pressures with increasing speed, or even by lessening mean effective pressures at increasing speeds, provided the latter increases faster than the former decreases. It is therefore important to return to the question of mean effective pressure and examine it in the light of such arrangements of engine as may affect the weight of cylinder complete per cubic foot of displacement and the weight of shaft and frame per cylinder. Mean effective pressure indicated is entirely a question of port and valve size and of port, valve, and combustion chamber temperatures. The former affects the weight of charge by pressure drop and the latter by suction-temperature rise, but the latter also limits the compression, which is the other factor in mean effective pressure. Mean effective pressures referred to brake horsepower are the same, except for mechanical friction and in the case of two-cycle engines for pump work. Any alternative arrangements or detail form that do not inherently increase the suction-pressure drop or the suction-temperature rise or do not produce hotter internal combustion-chamber walls may be made to yield equally high mean effective pressures by the use of suitable proportions and dimensions of passages and chambers. Forms or arrangements of this sort that reduce engine weight per cubic foot also directly contribute to the desired result of reduction of weight per horsepower.

According to this, a given number of fixed water-cooled cylinders of the same size should yield the same indicated mean effective pressures, no matter how they are arranged, whether, for example, four are radial or in line, six in the radial groups of three each or all in line, eight in line or in two fours V connected. Any differences actually found must be charged to proportions, to carburation, or to ignition, and can not be regarded as inherently characteristic of the grouping, though, of course, mean effective pressures referred to brake horsepower will differ by the difference in mechanical friction, which is least for the least product of bearing surface and mean bearing pressure. The same is not true for fixed air-cooled cylinders because their form and arrangement does, to an appreciable extent, affect their temperatures, though the suction-pressure-drop effects can be made the same for all. Therefore, more differences may be justifiably expected among fixed air-cooled than among fixed water-cooled cylinders.

The fixed air-cooled cylinders are likely to run hotter than the water-cooled cylinders so their mean pressures would be lower, as much so as the cooling is ineffective.

Rotating air-cooled cylinders taking their charge through the pistons, probably suffer the greatest of all suction heating effects and must be expected to have the lowest mean effective pressures, indicated and brake, more so because the windage is added to mechanical friction.

Automatic suction valves whether used in fixed cylinders or in the pistons of rotating cylinders, must always oppose suction by greater pressure drops than mechanical valves, each suitably designed, so such engines should have lower mean effective pressures.

Thick-walled cylinders and thin-walled pistons should run hotter than thin cylinders and thick pistons, so differences in mean effective pressure may be expected in these directions, always subject to proper selection of proportions in other directions.

Speed limits should inherently be the same for all fixed cylinder engines, no matter how disposed, so that with proper proportions there is no reason why any arrangement should suffer a greater falling off in mean effective pressure with speed increase than any other, however much the constant high value for one may differ from that of another. Rotating cylinder engines are, however, subject to lower speed limits than are fixed cylinder machines, on account of centrifugal forces, though there is no reason why one kind of rotating cylinder engine should not run as fast as another, nor why all should not suffer the same rate of decrease in mean effective pressures with speed increase, as do fixed cylinder engines except as windage may cause greater losses, referred to brake horsepower.

Any one type of cylinder and piston will run hotter the larger its diameter, so a given piston area in a large number of cylinders should result in higher mean effective pressures from the reduction of suction heating and the increased compression made possible by the cooler interiors. Therefore an eight-cylinder V should be better than four or six cylinders in line of equal displacement, and the rotating cylinder engine of several rows and cranks should be better than equal displacement in one row and one crank.

Similarly a large stroke bore ratio, favoring smaller piston diameters for equal displacements, should yield higher mean effective pressures than a small ratio but this difference is necessarily small, as reduction of cylinder diameter from 6 to $5\frac{1}{2}$ inches, for example, can not greatly affect interior temperatures.

These principles should all be checked by experimental data and can be so checked, but such data have never yet been obtained, largely, because such tests as have been made were directed toward a comparative judging of engines in competition, and were not conducted for discovery of principles of construction. Such results as are available are compared in Table 12 with reference to the variables discussed. In the same table are incorporated the figures for thermal efficiency which controls the weight of fuel to be carried. This, while slightly affected by valve resistances as is mean effective pressure, is dependent primarily on compression for indicated efficiency, and on engine friction and negative work for brake efficiency. It therefore is most affected by temperatures of the charge before compression starts and by interior temperatures, as these affect the maximum compression. As might be expected therefore the differences between the thermal efficiencies are less than those between mean effective pressures.

TABLE XII.—Mean effective pressure and thermal efficiencies versus type construction of parts.

Cylinders and cooling.	Class construction.	Cylinder material.	Valve location.	Suction valve A. M.	Name.	Bore.	Stroke.	Revolutions per minute.	Mean effective pressure.	Efficiency.	
Water-cooled fixed cylinders.	4 cylinders in line.	Cast iron.	Head.	M.	Benz.	5.180	7.087	1,288	106.9	0.29	
				M.	Daimler.	4.724	5.512	1,315	107	0.26	
				M.	Motag.	4.331	6.693	1,346	101.3	0.26	
	6 cylinders in line.	Steel.	Head.	M.	Daimler.	4.134	5.512	1,387	114.4	0.27	
				M.	Curtiss.	4	5	1,100	107.7	0.22	
				M.	Surtevant.	4	5.5	2,000	100.3	0.24	
	8 cylinders, V.	Cast iron.	Pocket.	M.	Sunbeam.	3.54	5.91	2,000	126.8	0.25	
				M.							
				M.							
	Air cooled:	12 cylinders, V.	do.	do.	M.						
					M.						
					M.						
Radial star.		do.	Head.	A.	Anzani.	3.54	4.72	1,250	76.2	0.23	
				A.		4.13	5.12	1,250	78.5	0.24	
				A.		4.331	4.92	1,031	76.9	0.24	
Rotating cylinders.	1 radial star.	Steel.	do.	A.	B. M. & F. W.	4.331	4.724	1,031	66.6	0.16	
				A.		4.33	4.72	1,200	67.9	0.21	
				A.		4.72	4.72	1,200	67.2	0.21	
Water-cooled fixed cylinders.	4 cylinders in line.	Cast iron.	Head.	M.	Daimler.	4.724	5.512	1,412	103.5	0.27	
				M.	Argus.	4.921	5.118	1,370	101.1	0.23	
				M.	Curtiss.	4.25	5	1,250	111.7	0.25	
	6 cylinders in line.	do.	do.	M.	Sunbeam.	3.54	5.91	2,000	126.5	0.25	
				M.							
				M.							
	8 cylinders, V.	do.	do.	Pocket.	M.						
					M.						
					M.						
	Air cooled:	Radial star.	do.	Head.	A.	Anzani.	4.13	5.71	1,250	83.2	0.27
					A.		4.53	6.10	80.1	80.1	0.25
					A.		4.13	5.52	954	86.2	0.26
1 radial star.		Steel.	do.	M.			4.718	76.9	76.9	0.17	
				M.			5.51	78.7	78.7	0.17	
				M.			5.91	65.2	65.2	0.21	
Rotating cylinders.	2 radial star.	do.	do.	M.							
				M.							
				M.							
Water-cooled fixed cylinders.	4 cylinders in line.	Cast iron.	Head.	M.	Daimler.	5.512	5.906	1,373	102	0.28	
				M.	Schröber.	4.882	6.289	1,252	78.2	0.22	
				M.	Curtiss.	5	7	1,100	104.7	0.24	
	8 cylinders, V.	do.	do.	do.	M.						
					M.						
					M.						
Air cooled rotating cylinders.	1 radial star.	Steel.	do.	A.	Gnome.	4.331	4.724	1,194	75	0.17	
				A.							
				A.							

Water-cooled fixed cylinders..	4 cylinders in line..	Cast iron..	Head..	M.....	Daimler.....	4.724	5.512	1,343	107.1	0.27
Air-cooled rotating cylinders..	6 cylinders in line..	do.	do.	M.....	Hall Scott.....	5	7	1,300	92.75	.21
	1 radial star..	Steel.....	do.	A.....	Gnome.....	5.118	4.724	1,156	71.3	.17
Water-cooled fixed cylinders..	4 cylinders in line..	Cast iron..	Head..	M.....	Daimler.....	4.331	5.512	1,386	102.8	0.27
Air-cooled rotating cylinders..	6 cylinders in line..	do.	do.	M.....	Austro-Daimler..	4.72	5.51	1,300	94	.26
	1 radial star..	Steel.....	do.	A.....	German Gnome... }	4.33	4.72	1,200	67.9	
						4.72	4.72	1,200	67.2	.21
						4.88	5.51	1,200	78.7	
Water-cooled fixed cylinders..	4 cylinders in line..	Cast iron..	Head..	M.....	Daimler.....	4.724	5.512	1,384	93	0.27
Air-cooled rotating cylinders..	6 cylinders in line..	do.	do.	M.....	Austro-Daimler..	5.12	6.89	1,200	93	.26
	1 radial star..	Steel.....	do.	A.....	German Gnome... }	4.88	5.91	1,200	65.2	.21
Water-cooled fixed cylinders..	4 cylinders in line..	Cast iron..	Head..	M.....	N. A. G.....	5.315	6.299	1,344	101	0.28
Air-cooled rotating cylinders..	6 cylinders in line..	do.	do.	M.....	Benz.....	4.17	5.91	1,250	113.5	
	1 radial star..	Steel.....	do.	M.....	L. C. Rhone.....	4.13	5.51	1,200	85.6	
Water-cooled fixed cylinders..	4 cylinders in line..	Cast iron..	Head..	M.....	N. A. G.....	4.724	4.724	1,408	94.9	0.26
		do.	do.	M.....	Wright.....	4.375	4.5	1,400	83.7	.23
Water-cooled fixed cylinders..	4 cylinders in line..	Cast iron..	Head..	M.....	Argus.....	5.512	5.512	1,368	106.5	0.26
Water-cooled fixed cylinders..	4 cylinders in line..	Cast iron..	Head..	M.....	Argus.....	4.921	5.118	1,342	107	0.23

NOTE.—Values for mean effective pressure taken from Table IV, where source of information is given. Efficiencies calculated from fuel consumption values in Table V, where authorities will be found.

There appears to be no consistent difference between the performance characteristics of steel compared with cast iron, as combustion chamber materials, when measured in terms of mean effective pressures or thermal efficiencies. The same is true, as might be expected, for fixed cylinder-crank shaft arrangements of four or six in line compared with 8 or 12 cylinder V, or star, though the figures for the latter do fall off a little. As indicated before, the fundamental difference is in air versus water cooling, and fixed versus rotating, or crank case versus direct admission of charge. Fixed cylinders are always superior to rotating, other things being equal, direct charge admission to crank case admission, and water cooling to air cooling.

Reliability of the engine as affected by arrangement, form, proportions, and materials is partly a process question and partly one of endurance of structure. So long as the mixture is made regularly and properly received into the cylinders, and then treated always the same, which includes ignition and cooling, then the mean effective pressure and thermal efficiency should remain the same, and the engine continue to run indefinitely. This is the process part of reliability. It is equally necessary, however, that no part shall break or fastenings loosen, and that bearings shall neither seize nor wear too fast or unevenly. Breakage means immediate involuntary stoppage, and loosening or bearing trouble a more or less fast approach to a stoppage, which, if anticipated, may be voluntary, or if not, a stoppage essentially the same in immediate effects as a breakage.

There is no excuse to-day for any greater number of breakages of aero engine parts than of similar parts of other engines, provided the same amount of skill and foresight in design and construction are exercised. The fact that the consequences of breakage are so much more serious in the case of the aero engine than in any other is sufficient reason why the breakages should be even less than on any other, and should not exceed those that could be called pure accidents beyond the utmost skill and care. It is, however, undoubtedly a fact that stress analysis, skill, and material data, for operating conditions, are far less generally applied to aero engine design than to other important classes of machinery. This is partly because the youth of the art has kept the inventor in the foreground and the computer behind, but largely through lack of rigidity of requirements by purchasers and lack of financial support of the business. If the business of aero engine production were large and regular, or Government supported, it could not only afford to pay experienced stress analysts, metallurgists, and material investigators, but would be forced to do so.

Breakage prevention is therefore almost entirely a question of money, and of realization that design is not purely invention. It is, however, somewhat a question of arrangement and form, for, as has been mentioned, from time to time some arrangements or forms lend themselves better to design for assurance against breakage than do others, or some promote a reduction of seriousness of the consequences of breakage, if it does occur, through pure accident. An illustration of this latter point is the case of the rotating cylinder arrangement versus the fixed. Breakage of a cylinder fastening means a throwing off of the mass under the influence, not merely of the gas pressure but of centrifugal force as well, and with a good possibility of much more serious consequences for the former. Even the breakage of one of the radial valve tappet rods will cause a loose end to fly out and whip

through the supporting structure. Such is believed to have been the cause of wrecking a British machine in flight and causing the death of the two passengers. Partial ruptures such as cracks in piston and cylinder are preventable by proper cooling, but the substitution of steel for cylinders directly contributes to this result, as does arching of pistons, the former a contribution of materials and the latter one of form to structural permanence. Complete ruptures are probably more common in valve stems and other small parts than in the main elements of frame, shaft, cylinder, piston, and rods, indicating lack of care or insufficient experience.

All such things are to be eliminated by organization, supplemented by time and by long periods of operation of experimental engines, run under specified unfavorable conditions to complete destruction of any one part under investigation, such as a valve and stem, or of the whole structure. Testing to destruction is the very best way to accelerate experience without danger to anyone. As in the case of the other illustration cited, however, form can contribute something to the reduction of consequences of breakage, and in the case of the stem of the head valve, this has been attempted by placing the edge of the valve seat slightly over one side of the cylinder bore in an offset, or complete enlargement of diameter at the clearance and with the valve circle tangent to the bore. Should a stem break, the valve will drop to the cylinder shoulder instead of on top of the piston, which smashes it or itself, provided the break is high enough upon the stem so the stem does not emerge from the guide. Otherwise the result is quite the same as if the shoulder were not present, except that a larger diameter of valve is possible than without such extension of the bore. This valve trouble is supposed to be quite prevented by side-pocket location of valves, but is not, because should the valve drop into the pocket there is every chance of it sliding over on the piston under the influence of a suction stroke, especially if the flat bridge inclines downhill, as it usually does in single cam shaft V engines, for example, though placing the valve on the opposite or downhill side would prevent it, but would require two cam shafts.

Prevention of undue wear on shaft and pin bearing surfaces is entirely a question of bearing pressures and lubrication. These bearing pressures are all subject to pretty accurate determination by computation, so the design of an engine with excessively high bearing pressures, judged by general machinery bearing experience, is a pure technical mistake, not to be excused by the addition of elaborate forced systems of pump oil supply. Bearings should be large enough to not need elaborate special oils or oil-application systems, but these should be added to make assurance doubly sure, in short; as safety attachments, not as essential elements. Weight reduction secured by cutting down main and pin bearings is too dearly bought to be worth the price. Cylinder and piston bearing wear, while involving the same elements as main bearings, have to endure the additional difficulty of high temperature, but this is not serious if due attention is paid to the principles of heat abstraction. Violation of these principles, coupled with a rise of side thrusts, aggravated by side cocking that follows undue shortening of pistons, is another case of pure neglect. Pistons should be as long and as thick at the top as is consistent with weight-speed limits, and where observance of these limits fails to reduce the pressures and temperatures to values known

to run properly in other engines, then definite special remedies can be suggested, only one of which is excessive use of lubricating oil and the last to be adopted instead of the first.

Seizing of running parts at bearing surfaces is entirely a question of relative size or of clearances, and its prevention a question of maintenance of the cold clearances after the parts become heated, which, of course, is least necessary, the better the provision for abstracting and dissipating the heat derived from combustion or developed by friction. Next to cooling, which in main and crank pin bearings is not attempted, though it might well be, and which in cylinders and pistons is their big problem, material selection is most important. Some materials have low relative frictional coefficients for their lubricated surface and are properly related as to thermal expansion. Nothing better than the soft-metal lined or bronze can be found for steel shafts and pins, especially as these expand more per degree rise than the steel, so heating tends to loosen and oppose seizing by assisting lubrication, which by lowered oil viscosity tends to become less effective. The boxes must, however, be stiff enough to really distribute stress. Piston and cylinder bearing surfaces are somewhat more difficult, as the outer part, the cylinder, is normally much cooler than the inner part, the piston. The temperature difference is greater the thinner the pistons, and the difference is much greater than in the case of the standard box on the pin or shaft. It is, therefore, more necessary to care for these clearances. This is done when the materials are the same, cast iron on cast iron, by making the initial clearance high, far higher than would be feasible on shafts. This tends to promote side knocks and leaks at part load. For equally good cooling the steel cylinder with cast-iron piston gives about the same expansion relations as do the bronze box and steel shaft, but not such good antifriction qualities. Steel selection and heat treatment will undoubtedly lead to improved antifrictional results, perhaps even equal or superior to cast iron, after proper research. This seems to be a rational and promising line of development, especially if the cylinders are kept symmetrical, as they can be with head valves.

Reliability so far as carburization, ignition, mixture distribution, and cylinder treatment processes are concerned, has already been discussed. Any derangement whatever here leads to impaired power output or increased and perhaps very much increased fuel consumption. Serious derangement of these processes means stoppage even though the whole engine structure be perfect. Most operating troubles are directly traceable to these process derangements, which if sufficient in degree, mean stoppage, and even if slight, constant tinkering and anxiety.

Adaptability of an internal-combustion engine to aeronautic service is promoted by certain features of the engine that play no part in metal reduction, in mean effective pressure and efficiency increases or in its reliability, though of course low weight of engine and of fuel per horsepower are themselves adaptability factors, as is also any element of reliability.

General external shape and position of points of attachment are subject to a far wider range in aero than in auto engines. In one respect aero adaptability imposes a direct requirement, that of end shape for least head resistance. Engines directly exposed to the air or their casings when covered have a relative movement always

approaching, and sometimes exceeding, 100 miles per hour. This must always impose a resistance which is larger, the larger the end area facing the direction of flight and the less smooth the exposed surfaces are. In this respect the rotating-cylinder engines are by far the worst and the single line of cylinders of the auto type of multi-crank engine is best, nearly twice as good as the V engine for example. Air-cooled engines if similarly arranged to water cooled offer more head resistance except for the radiator of the latter which may be very highly resistant but is not necessarily so. But apparently the requirements of low head resistance is losing in importance, at least for war machines, since in these the fuselage is roomy enough generally to accommodate any type of engine.

Ease of starting and a control of speed are also required of aero as of automobile and boat engines, but with some elements of difference. Electric self-starters with generator-motor and storage batteries are prohibited by weight limits, for even if the craft could carry them their weight would be much better disposed in the engine by adding either more horsepower of the same unit weight, more fuel for the same engine to make longer flights, or for equal flights and engine power by using a heavier built and therefore less sensitive engine of longer life. When starting from the ground a starting crank on the shaft end often would be inaccessible and even if it were within reach, engines of large power could not be hand rotated against their normal compression. It has been a general practice to start these engines by hand turning of the propeller blades, a practice that is most dangerous, does the blades no good and certainly requires an extra man because at the moment of starting the operator must be in his seat. All hand-starting difficulties are removed if the compression is relieved and the accessibility of a starting crank can be met with equal ease by a chain and sprocket having a self-releasing ratchet and hand crank on a short auxiliary shaft, near the operator's seat. It may therefore be regarded as necessary that aero engines, certainly the larger ones, and this means most of all if not all of those to be built in the near future, be provided with compression-release cams, equivalent to those so long used on hand-started stationary engines and lever operated from the seat. This same compression release gear will serve as a speed control, should speed variation be necessary, by permitting escape of part of the charge though, of course, with waste of gasoline. It serves as a supplement to the throttle valve of the carbureta, and which is not so wasteful of fuel. Speed reduction by spark retardation should not be practiced on aero engines, though a starting retard is necessary, automatic or manual, because of the serious overheating effects that follow, and aero engines at best are hard enough to keep cool at their high speeds.

Muffling may be regarded as a necessity, however much free exhausts have been used in the past, and whatever unfavorable weight and power effects are imposed must be regarded as warranted. Noise from the exhausts of so many cylinders operating at high speeds becomes a loud roar. There are at 1,200 revolutions per minute from the 20 cylinders of the Le Rhone engine, for example, $600 \times 20 = 12,000$ air impacts per minute, and at 2,400 revolutions per minute the eight cylinders of the Sunbeam engine give $1,200 \times 8 = 9,600$ impacts. With such a disturbance close to him no operator can be expected to keep his head as clear for the serious business of

flying as if the noise were absent. To detect engine defects by the noise changes in the machine before they become serious is absolutely impossible, though this is the main reliance in operating any other kind of machine. Free exhausts must be classed, therefore, not as annoyances but as preventers of engine-trouble detection, no matter what the type of machine, and for military machines they are the finest kind of approach signal to the enemy, being audible long before the machine is visible.

Mufflers can be made, due to automobile development, that are quite effective with no more than 2 pounds per square inch back pressure, and possibly less. This will reduce engine output 2 per cent if the mean effective pressure is 100 pounds per square inch, as it is in aero engines, less than 2 per cent for higher, and more for lower mean pressures. The weight increase is almost negligible, being between one-tenth and two-tenths of a pound per horsepower.

Just as soon, however, as mufflers are demanded as a necessity the rotating cylinder engine must be changed or abandoned, as normally the exhaust valve is placed in the center of the head, usually held in place by an open cage screwed to the cylinder, discharging directly into the air. To attach a muffler will require a change of the cage to a closed form with pipe attachment and additional cooling to keep the now inclosed valve as cool as the open one. The muffler would have to be disposed symmetrically about the shaft and inwardly radial pipes held against centrifugal force at the muffler, fitted to the exhaust cage by slip joints. These pipes must, moreover, be circumferentially supported to prevent distortion by variable angular velocities, and they will impose additional windage resistance. The net effect will be a greater reduction of power and a greater increase in weight than muffler attachment imposes on fixed cylinder engines.

It goes without saying that no aero engine with tanks and connections complete is adapted to its purpose if tilting even to very considerable degrees interferes with its operation, and if it stops on tilting to any angle that is remotely possible in real flying it certainly must be rejected as failing in adaptability. There is considerable uncertainty as to the angle and direction of tilt that aero-engine adaptability requires, but the 15° required in the German and British contests seems to be a very modest requirement. No one will deny that the greater the angle of tilt and the more independent of direction, the better the adaptability factor. The conditions when tilting in flight may be quite different from those existing in a tilted engine at rest, especially when the motion is in curves developing centrifugal forces in all masses as well as in the lubricating oil and fuel feed system. Therefore, in considering engine independence of tilting, rapid change of motion as to speed and direction, but especially direction, must be included.

Any changes of direction of motion that the planes could withstand can have no appreciable effect on the motion or friction of the moving masses, but the effects on lubricating oil in the crank case or separate tank or pipes and on the gasoline in the carburetor float chamber, tank, and pipes may easily be as great as in extreme tilting. It is quite possible to imagine a resistance to flow, for example, purely gravitational or purely centrifugal, or both, great enough to cause engine trouble, in the one case from failure of the carburetor and in the other from overheating of bearings robbed of oil, or from flooding

of combustion chambers whose pistons get an excess. It is likewise possible that the water-circulation system be similarly deranged by opposition to circulation, causing steam to generate in a jacket, expelling all water, and causing an overheating, with a possibility of a crack, or by a drainage of water from the radiator vent. If an engine could so be designed that it could work on end, lying on its side, or even upside down for a short time, but preferably indefinitely, this would be the ideal. No such possibility is in sight, though engines are now operating in machines moving in curves and circles in horizontal planes, turning the engine on its side, but centrifugal force replaces gravity and no flows are disturbed. Similarly, looping or circle flying in a vertical plane turns the engine so that it operates first on end and then upside down, but, as before, the centrifugal force replaces gravity. Such is not the case, however, in a steep climb or descent nor in the uptilting of one end of the plane due to wind gusts. Here gravity flows are disturbed by the amount of side and end angle. Crank shafts and pin bearings must receive new and end thrusts which are not difficult to handle if they all are properly journaled.

Crank-shaft torque that is most uniform is best adapted to propeller drives, as these propellers being made of wood for lightness may be broken by sudden torque changes. Such changes also reduce the average propeller efficiency and produce reverse rocking forces in the machine frame. Any engine with insufficiently steady torque for propeller safety and for maintenance of high average efficiency may be adapted by addition of sufficient fly-wheel effect between engine and propeller. The same fly-wheel effect increases the crank-shaft torsional distortion and crank deflection and adds to engine weight. Engines that can give sufficiently uniform torque for the purpose without fly-wheels must displace others, and while the four cylinders in line engine seems to serve, it is true that the effort falls to zero on dead center. Anything less than four cylinders is out of the question, because the gas-pressure effort is entirely absent for a part or a whole stroke or more. Increase of number of cylinders over four makes the actual effort or resultant tangential force due to combined gas pressure and reciprocating inertia forces depart less and less from the constant mean effort and minimizes the angular velocity variations of the propeller without any other fly wheel than itself. From this standpoint the more cylinders the better, though from others discussed this is not the case.

Arrangement of a given number of cylinders radially about one crank produces the same torque curve as the same cylinders in line, provided their cranks in the latter case are separated by the same angles as their cylinder axes in the former. When, however, these cylinders in line have cranks parallel in pairs, as in the four and six crank arrangements, the torque will not be as uniform as when these are radially disposed about one crank. It appears, however, that the 6 cylinder in line, 6-crank arrangement, in which the torque never drops to zero, is quite uniform enough for practical work, and the 8 and 12 cylinder V arrangements are progressively better. There is no reason for adopting the radial arrangement if, as is the case, other objectionable elements are introduced, because the above is good enough and anything better not worth another disadvantage. Comparison of turning efforts for any arrangement of cylinders and

cranks is easy if they be plotted to a crank angle or crank path base by the usual standard methods. Many of these curves have already been worked out and may be found in the literature, including the inertia as well as gas-pressure force effects, and for such reference is made to the bibliography in the appendix. In no case may a fly wheel be introduced in aero engines to dampen torque variations because of weight limitations.

Balance of reciprocating parts in view of the light and flexible character of the engine supports which are part of the flying-machine structure, is probably the most important of the adaptability factors, because lack of balance means free shaking forces or moments on the whole system, and these being regular and periodic may periodically synchronize with the natural periods of wires, struts, and beams, and so cause displacements of such increasing amplitude as may be responsible for rupture. In no other engine, including the automobile, motor boat, and even the light shell of the racing boat, which comes nearest, is the support so frail and of such small mass capacity for absorbing vibration forces. Therefore, all unbalanced forces or couples and the full displacements or vibration of the engine as a unit are communicated directly to the flying-machine structure practically without any modification. Moreover, aero engine weight being so small in comparison with other engines, its own mass resists displacement by its free unbalanced forces and couples less than any other. For these reasons good balance is essential to aero engines, but absolutely perfect balance is not.

Shaking forces and moments in engines are due to both reciprocating and rotating masses, and vibration or rocking is the result of a failure to balance these forces and moments. Shaking forces due to rotating masses can be balanced perfectly by other rotating masses disposed on opposite sides of the shaft center with proper numerical relation between centers of gravity, radii, and weights. If the plane of rotation of the original rotating mass is not the same as that of its balance weight or weights, then there will be an unbalanced couple even if the centrifugal forces are in balance, unless balancing masses be disposed properly in separate planes, themselves properly related. Due observation of these simple and well-known relations make it a perfectly easy and simple matter to balance rotating parts of an engine by adding suitably disposed extra rotating balance masses. Such dead balance weights are, however, prohibited by the service requirements of least weight per horsepower, so the actual rotating working parts must themselves be so disposed as to balance each other. These parts include the cranks, crank pins, and rod ends principally, but also such small parts as the cams. If cranks, pins, and rod ends are balanced, other minor rotating parts may be neglected, though they set up inevitably some small shaking forces, especially as the speeds are so high, and these forces vary with the square of the speed.

Accordingly, to balance centrifugal forces and couples, due to cranks and their attached rotating masses, of fixed cylinder engines similar cranks must be suitably disposed with reference to the first. To avoid unbalanced couples with balanced forces more than two such cranks are necessary and in different planes. Two similar cranks at 180° , three at 120° , or any number equally spaced will result in force balance, because each introduces an equal force vector,

and, the sum of the vector angles being 360° , these vectors will form a closed equilateral force polygon, which means, of course, a zero resultant. Each set of such equally spaced cranks is characterized by a free couple, to balance which a similar and opposite couple must be introduced by adding a similar set of cranks with equal but reversed angular spacing.

Applying this reasoning to fixed cylinder engines, it appears that the least number of cranks that can give couple and force balance is four, set at 0° , 180° , 180° , and 0° , and the next smallest number, six, set at 0° , 120° , 240° , 240° , 120° , and 0° . Of course any multiples of these four and six crank arrangements will also yield such balance. This indicates a condition of inferiority of the fixed cylinders star engine with many cylinders circumferentially disposed about each crank, compared to the single-row and double-row V engines of equal number of cylinders. These star arrangements must have as many multicylinder stars, each working on its own crank, as the single and double rows of parallel arrangement has cylinders, in order to secure equally good rotating mass balance. This would impose on such fixed star cylinder engines an excessive number of cylinders, unless crank counterbalance weights were introduced, with consequent loss of the weight advantage otherwise due to the star arrangement.

Rotating cylinder star engines are peculiar, because with fixed cranks all parts of the engine are rotating—cylinders and frames in purely circular paths, pistons and wrist-pin ends of rods in a sort of oval path, while crank-pin ends of rods are fixed. According to this the cylinder and frame are in force balance when axis angles are equal, and all being in one plane there is no unbalanced moment. The centrifugal force due to the rotation of the piston is a maximum and radially outward when the piston is at outcenter, and a minimum at the incenter position with regular symmetrical gradations between. The net effect is a resultant force constant in amount and direction acting radially outward along the crank and exerting a lifting action if the crank points up, but not producing any vibration so long as the speed is constant. From the balance standpoint, therefore, the rotating star is superior to the fixed star arrangements, but is no better than the four and six cranks and their multiples with parallel rows of cylinders.

Reciprocating masses of fixed cylinder engines, such as pistons, wrist pins, and an appropriate part of the connecting rod, develop inertia forces for uniform rotary motion of the crank that can be expressed by an equation of the form of Fourier's infinite series, each successive term being proportional to a trigonometric function of a multiple of the angle of rotation from inner dead center and to increasing powers of the ratio of crank to connecting rod length. The reciprocating inertia force of one set of reciprocating parts is therefore the sum of an infinite number of forces of different periods or frequency, the first being largest and its period that of an engine speed, each successive one being smaller and of longer period. These reciprocating forces and the couples due to them must be balanced perfectly if possible; and if not, as well as possible. The forces due to valve and valve-gear reciprocation with accelerations determined by cam form may be neglected, though of course if these could be balanced in a simple way it would be desirable.

Balance of main reciprocating forces is possible only by opposing equal and opposite masses of equal simultaneous acceleration, or by arranging reciprocating masses in groups, so that the vector sums of their inertia forces become zero. There is, however, a partial balance possible by the use of crank counterweights or otherwise disposed rotating masses frequently used on stationary and locomotive engines, but normally prohibited on aero engines, on the principle of exclusion of all dead weights, even for balance purposes. A rotating crank counterweight exerts a radial centrifugal force which may be resolved into an axial and a right-angle component. This axial component may be made equal to the first-period inertia force, and, being, of course, opposite, it serves to balance this force. The right-angle component is, however, left and of equal intensity, and so, of course, are all higher period inertia forces. Such counterweights are therefore quite useless alone for flexibly supported engines, though when used with one particular combination of pistons and cylinders they become serviceable without very great weight increases. This special case is that of two cylinders set V at 90° , for here there are two first-period inertia forces at right angles, which are in balance with one counterweight, of mass equivalent to one of them for first-period forces, though higher period forces are still free.

As first-period inertia forces are similar to the axial components of rotating centrifugal forces, a similar grouping of multiples serves to produce balance effects. Such, for example, is the case with the four parallel cylinder four-crank arrangements in which, without balance masses, the first-period inertia forces are balanced, and, of course, also in the 8-cylinder V , which is a duplication of similar parts.

All combinations of arrangements of reciprocating parts for parallel, fixed star, and rotating star cylinders can be examined mathematically or graphically, and most of the proposed arrangements have been so studied and are reported in papers and books noted in the bibliography of the appendix. Of these perhaps the most elaborate is that of Kolsch in his book published in 1911, where conclusions are reproduced on mass balance of both rotating and reciprocating parts. Engines that are in complete mass balance without introduction of balance weights include the fixed cylinders 6, 8, 12, and 16 in a row each with its own crank, the 12 and 16 in two rows V with two cylinders per crank, the two cylinders opposed axes in line with two cranks and its multiple, and all rotating star cylinder arrangements having four or more cylinders per star. Those that are balanced for rotating masses and for the first period reciprocating mass forces but not higher ones, without balance weights, include the fixed cylinder engines of the four parallel cylinder four-crank arrangement and its twin or 8-cylinder V .

Introduction of balance masses gives complete balance to fixed cylinder star engines of four or more cylinders and a balance of first-period reciprocating inertia forces but not of higher ones to the 2 and 4 cylinder V and the 3-cylinder fixed star radial. This fundamental need of balance weights for fixed radial cylinders is also mathematically demonstrated by Milner, who says: "The engine will be completely balanced for primary and secondary forces by a mass $\frac{n}{2}$ times that one of the pistons (n = number of cylinders") and diametrically opposite and same radius as the crank.

Of course this is in addition to the mass required to balance the rotating parts of the engine. The rotating cylinder engine ordinarily has one connecting rod heavier than the others which itself makes perfect balance impossible.

More cylinders and cranks than are necessary to give the required torque constancy, or the required balance, or the total power within the cylinder diameter limit can not be accepted. Each additional individual cylinder carries with it sources of additional trouble and increases the chances of unreliability, however much the consequences of failure may be reduced. The least allowable number on this basis appears to be 4 fixed cylinders in line or radial fixed or rotating. The maximum should be 6-cylinder 6-crank in line for balance or 8-cylinder V for torque, both advantages being equal in the 12-cylinder V, or twin 6. Of course the rotating cylinder engine of equal number of cylinders and symmetrical parts is just as good in torque and balance, and even a lesser number down to four equal in balance, though deficient in torque, but these rotating cylinders are in no way superior to the above arrangement. Stars fixed cylinders of equal number are equal in torque to the same number rotating if similarly disposed, but inferior in balance unless rotating counterweights are introduced, in which case equality results.

CONCLUSIONS AND RECOMMENDATIONS.

In the following brief statement of recommendations and conclusions, which are presented in the form of a list, no effort is made to develop arguments in support of each because it is believed that the text and appendices of the report themselves serve as sufficient support. No specific type of engine, form of part, material, or design constant is recommended, because it is believed that attention at this time must be directed mainly to methods of procedure that will lead to improvement. Naturally specific recommendations on design could be made, and these will be available at such time in the future as they may be desired.

1. The art has developed several typical arrangements of engine and several different designs of each type that may be regarded as of proven acceptability as to weight per horsepower of engine and thermal efficiency, but which require considerable work to perfect and standardize in detail and material without any further inventive work than properly constitutes part of the normal routine of research and designing engineers. These types are the 4 and 6 cylinders in line, each with its own crank, the 8 and 12 cylinder V with two cylinders per crank, all fixed cylinders and operating with both air and water cooling, preferably the latter, for long flights, and finally the radial star rotating air-cooled cylinder form for short flights.

2. There have also been developed a very large number of special designs of engine, which in some instances have been built and used but in others remain mere suggestions. Each one of these is practically an invention in itself, the precise practical value of which remains more or less in doubt. To properly develop the good points of these and other inventions to come, and to reject or eliminate unfavorable elements that are always present in new machines that have not yet stood the test of time, much work must still be done, quite independent of the research work so necessary for final perfec-

tion and standardization of the now acceptable and more or less largely used types noted above.

3. Direct governmental aid is an absolute necessity to the art, both for the perfection and standardization of accepted types and for encouragement of further invention. Private contributions should also be encouraged, whether for use in connection with the governmental establishment or independently.

4. There should be a regular buying program providing for the purchase of a fixed minimum number of aero engines yearly, to encourage existing engine builders to spend the money necessary to produce what is wanted to meet aviation specifications, because the best shops will not enter the field without some definite assurance of a fixed amount of business, for which they are, however, quite willing to compete.

5. The aviation engineers should standardize service specifications for engines, limiting the specifications strictly to those items that bear directly on service, so designers and builders may know definitely what conditions must be fulfilled without being hampered with purposeless limitations as to the means to be used by them.

6. The Government should conduct regular annual test competitions of engines on rules to be prepared and widely published at least 10 months in advance, and revised yearly immediately following the closing of the previous contest. For those engines that make the best records, substantial rewards must be provided in the form of cash prizes, or buying orders, or both. These cash prizes may be provided by Government appropriation, by private contribution, or both together.

7. There should be established a standardization research laboratory with a permanent staff of engineers selected for efficiency. This staff should conduct the competition tests, over not more than two months of the year, including the reports, and during the rest of the time should carry on tests for design and performance data of every engine of the accepted class noted in No. 1, but of no others. Other engines are to be admitted only on the recommendation of a second laboratory staff devoted to development of invention noted in No. 8.

8. There should be established a laboratory for development of inventions submitted by anyone, when those inventions seem promising. This staff must be quite independent of that of the standardization research laboratory noted in No. 7, and should preferably be located in quite a different place. Its engineers should be, in ability and temperament, quite different as well. When in this laboratory an engine, engine part, or accessory not in the accepted class, has been brought to a condition where its performance is equal or superior to what is in the accepted class, then it may be recommended to the standardization research laboratory for further study and perfection.

9. In at least one of the Government shops, possibly located in one of the navy yards, actual construction of engines of the accepted classes should be undertaken on about the same basis as is now followed for ships, the military shop competing with civilian shop in price and performance. Safeguards must be introduced to prevent any discouragement of private enterprises or charges of unfairness in this competition.

10. Officers and enlisted men who may be charged with the care of aero engines in service should be assigned to duty, first, in the Government aero engine shops, then in both the standardization

research and the invention development laboratories, and finally in the engineering office noted in No. 11, for instruction.

11. There should be established a staff of supervising and designing engineers for internal combustion engines. This staff should prepare all purchasing specifications, prepare engine test competition rules, receive and use all standardization data from the laboratory, exercise general direction over both the laboratories, and prepare detailed drawings for the shops.

12. There should be established the closest possible relation between aero-engine development and that for other classes of internal combustion engines in which the military now has or may in the future have an interest. Among these are included submarine engines, ship and launch engines, automobiles and auto trucks, gun and transport traction engines, and stationary electric generation sets for wireless, mine firing, searchlights or general service. The same designing staff, laboratories, and shops that should be established for aero engines can also advantageously undertake similar work for these other internal combustion engines, as most of the fundamental training, knowledge, data, methods, and skill required for the one is also of equal service to the others. Similarly, officers and enlisted men of those other branches of the service can be given adequate instruction by temporary assignments to the shop, laboratories, and engineering office.

13. Publicity of data should be promoted by governmental publication of reports to keep alive the general interest in the needs of the Military Establishment in the internal combustion engine field, because the greater the interest the greater the contributions of the profession. This publication may also take the form of papers prepared by engineers of any of the various staffs and presented to the national engineering societies. Not only should domestic results be thus given publicity, but all foreign papers and official reports of value should be translated and republished. Whenever data is regarded as being strictly military in value and where publication is therefore deemed inadvisable, such material can, of course, be withheld, but it is believed that in general both Army and Navy have more to gain than to lose by publicity of engineering data on engines.

14. It is regarded as of the utmost importance that advantage be taken by the Government of the service of such civilian engineers as have given special attention to the study, commercial development, and use of internal combustion engines of all classes, and more particularly those not engaged in manufacturing, though not excluding those of high professional standing that may be so engaged. The special knowledge, skill, and experience that these men can bring immediately to the service of the Military Establishment should prove as invaluable here as it has abroad, in Germany, for example, first in organizing the various working staffs recommended above, and later in working with them. Advantages may also be taken of the laboratories of such of the engineering schools as have specialists of the above type on their faculties, or as may be located in large centers where such men not associated with engineering schools may have their regular offices.

15. No recommendation is made on the details of the organization of these various staffs and their coordination with the existing Army and Navy Departments and bureaus except as to necessity.

NOTE.—Part 3 omitted. See note on Preface, page 187.



