

NATIONAL ADVISORY COMMITTEE FOR AERONAUTICS

L-547

WARTIME REPORT

ORIGINALLY ISSUED

October 1942 as
Memorandum Report

FLIGHT MEASUREMENTS OF THE RUDDER CONTROL AND SIDESLIP

CHARACTERISTICS OF FOUR VERTICAL TAIL ARRANGEMENTS

ON THE P-40 SERIES AIRPLANES -

By Harold I. Johnson and Joseph R. Vensel

Langley Memorial Aeronautical Laboratory
Langley Field, Va.

JPL LIBRARY
CALIFORNIA INSTITUTE OF TECHNOLOGY



WASHINGTON

NACA WARTIME REPORTS are reprints of papers originally issued to provide rapid distribution of advance research results to an authorized group requiring them for the war effort. They were previously held under a security status but are now unclassified. Some of these reports were not technically edited. All have been reproduced without change in order to expedite general distribution.

MEMORANDUM REPORT

for

Army Air Forces, Materiel Command

FLIGHT MEASUREMENTS OF THE RUDDER CONTROL AND SIDESLIP
CHARACTERISTICS OF FOUR VERTICAL TAIL ARRANGEMENTS
ON THE P-40 SERIES AIRPLANES

By Harold I. Johnson and Joseph R. Vensel

INTRODUCTION

Directional control difficulties had been experienced in P-40 series airplanes in dive demonstrations and inadvertent entry into spins in service operations. At the request of the Army Air Forces, Materiel Command, quantitative measurements of rudder trim force change with speed and power, rudder force reversals in sideslips, and rudder positions in sideslips and straight flight of a P-40E airplane were made. Quantitative measurements of these items were also made on three other vertical tail arrangements supplied by the Curtiss-Wright Corporation. The results of these measurements are presented in this report.

DESCRIPTION OF VERTICAL TAILS TESTED

Photographs of the four tail arrangements tested are shown in figures 1 through 6. Tests of the original vertical tail, Curtiss fin extension no. 1, and Curtiss fin extension no. 6 on a tall fin (Curtiss dwg. SK-5524) and rudder (Curtiss dwg. SK-5676) were made on a P-40E airplane. Flight measurements with the original vertical tail moved aft 20 inches were conducted on a modified P-40F airplane.

Line drawings of the vertical tail surfaces, that is, the original vertical tail, Curtiss fin extension no. 1, and Curtiss fin extension no. 6, along with their respective areas, are shown on figure 7. The rudder of the original vertical tail surfaces and of that used with fin extension no. 1 were equipped with balancing trim tabs, while the rudders used with Curtiss fin extension no. 6 and the 20-inch fuselage extension on the P-40F airplane were equipped with trim tabs only. The relations between rudder trim tab position, rudder position, and cockpit tab setting are shown on figures 8 through 11. The fin offset on the original vertical tail and on the tail with fin extension no. 1 was $1-1/2^{\circ}$, while the fin offset for fin extension no. 6 and the 20-inch fuselage extension was 0° .

The center of gravity at take-off was maintained at approximately 27 percent of the mean aerodynamic chord on both the P-40E and the P-40F airplanes.

INSTRUMENTATION AND METHOD OF TESTS

Flight test data were taken with standard NACA recording instruments. The yaw-angle recorder was mounted a chord length ahead of the right wing tip. A calibration of the yaw-angle recorder was made by mounting a similar recorder on the left wing and recording both values simultaneously as the airplane was flown through the speed range. One-half the difference of the two recorded yaw angles was taken to

represent the correction necessary to obtain true airplane yaw angle when only one recorder was used, as in the tests. The magnitude of this correction was quite small, being about 0° at minimum speed and 2° to 3° in the high-speed range.

The airspeed total head and the free-swiveling static head were mounted a chord length ahead of the left wing tip. A pilot's airspeed meter and an NACA airspeed recorder were connected to these total and static heads. The use of a pilot's airspeed indicator connected in this way greatly facilitated holding the airspeed approximately constant in sideslips since the NACA free-swiveling static and total head tubes are not affected as much by yaw as the standard service installation.

The directional trim characteristics of the four vertical tail configurations were determined by flying the airplane in straight laterally level flight from minimum speed to an indicated speed of about 350 miles per hour with power off and with rated power on in the clean condition, that is, wheels up, flaps up, and cockpit hood closed.

At least two rudder trim tab settings were used for each power-off and power-on speed range coverage, and in cases where rudder forces became excessive the speed was not increased beyond the point where it was extremely difficult to hold the airplane in straight laterally level flight. Similar runs were also made in the landing condition both with power off and with rated power.

No special indicating instruments for straight laterally level flight were installed for the pilot as it was considered desirable to determine what angle of bank and yaw angle could be expected in these airplanes when a pilot attempted to hold straight laterally level flight, particularly in a dive.

The sideslip or directional stability characteristics of the four vertical tail arrangements were measured by permitting no relative motion of the nose of the airplane with respect to a distant point on the horizon and very slowly increasing the bank with the aileron until either the limit of rudder travel was reached or the rudder force became too high. While this maneuver was being made, the pilot attempted to hold the selected indicated airspeed constant by reference to the test airspeed indicator as noted above. The sideslips were made in the clean condition both with power off and with rated power on.

RESULTS AND DISCUSSION

The rudder-control characteristics in straight flight are presented for the four vertical tail arrangements tested in figures 12 through 23. The effectiveness of the rudder trim tabs as a function of indicated airspeed is shown on figure 24.

The sideslip characteristics of the tail arrangements tested are shown in figures 25 and 26. Attention is

I-547

called to the rudder force reversals encountered in the lower speed range with rated power on with the original P-40E airplane. Sideslip characteristics for small angles of yaw are shown for all the tail configurations in figures 27 and 28.

A summary of the measured characteristics for the four tail arrangements tested is given in table I. On the basis of this comparison it is apparent that fin extension no. 6 on the tall fin (Curtiss dwg. SK-5524) and rudder (Curtiss dwg. SK-5676) is superior to all the other arrangements tested. This vertical tail provided the minimum rudder force change with speed, and the magnitude of the rudder force change for straight laterally level flight from power on to power off at the same speed was only about 40 pounds in the high-speed range. No rudder force reversals in sideslips were encountered and the directional stability as measured by the slope of rudder angle versus sideslip angle was greater than for any of the other vertical tails.

The test results further indicate that the 20-inch fuselage extension in itself, as tested on the P-40F airplane, did not contribute as much to directional stability as measured by $\frac{d\delta_R}{d\psi}$ as did the slight addition of area accomplished by adding fin extension no. 1 to the original P-40E fuselage vertical tail combination. This can be readily seen from table I by comparing test no. 1 with

no. 2 and no. 4. The incorporation of the 20-inch fuselage extension did not, therefore, in itself materially improve any of the directional characteristics investigated, although spinning has not been considered.

It appears from an analysis of the data of all the vertical tails tested that a vertical tail combination (although the particular combination was not tested) consisting of fin extension no. 1, fin offset 0° , with the original rudder and a rudder tab for trimming only, would eliminate the major faults in the directional characteristics of the present P-40 airplanes. The incorporation of this vertical tail combination would mean that the rudder force change with speed and power in the high-speed range would be acceptable and no rudder force reversals in sideslips would be expected. The force changes experienced in the low-speed power-on regime of flight would be fairly large but not excessive. It is believed that this change could be easily incorporated in the airplanes already in service.

The reason for the selection of a rudder tab for trimming only in the suggested service change is based on a study of the original vertical tail that indicated that the balancing action of the tab materially contributed to the rudder force reversals in sideslips.

CONCLUSIONS

Fin extension no. 6 on the tall fin (Curtiss dwg. SK-5524) and rudder (Curtiss dwg. SK-5676) are recommended as the most satisfactory of the four vertical tail arrangements tested insofar as rudder force change with speed or power, rudder force reversals in sideslips, and directional stability are concerned.

An arrangement consisting of fin extension no. 1 on the original fin with the offset 0° and the original rudder with the tab rigged for trimming only is suggested by an analysis of the test results as an alternate modification that could be more easily incorporated than the above arrangement. This latter arrangement would exhibit rather large but still controllable forces in the lower end of the speed range with power on, but would avoid some of the structural difficulties involved in the installation of the much larger fin and probably would be more acceptable as a service change.

Langley Memorial Aeronautical Laboratory,
National Advisory Committee for Aeronautics,
Langley Field, Va., October 9, 1942.

L-547

TABLE I

L-547

COMPARATIVE DIRECTIONAL CHARACTERISTICS OF FOUR VERTICAL
TAIL ARRANGEMENTS ON P-40 AIRPLANES

Order of tests	Airplane	Rated power	Vertical tail arrangement	Distance c.g. to rudder hinge line, in.	Fin offset, deg	Order of merit for minimum change in rudder force with speed in straight flight				Order of merit for minimum change in rudder force from rated power to power off		Rudder force reversals in sideslips	Magnitude and order of merit of directional stability as measured by $\frac{d\psi}{dt}$ for $\psi = 25^\circ$			
						Clean condition		Landing condition		Clean condition	Landing condition		Rated power between $V_1 = 115$ and $V_1 = 160$	Merit	Power off between $V_1 = 110$ and $V_1 = 120$	Merit
						Rated power	Power off	Rated power	Power off							
1	P-40E	1,000 hp at 13,000 feet	Original, trim and balance tab	217	$1\frac{1}{2}$	4	4	2	3	4	4	Yes	-0.47	4	-0.49	4
2	P-40E	1,000 hp at 13,000 feet	Fin extension no. 1 on original, trim and balance tab	217	$1\frac{1}{2}$	3	3	3	2	2	3	^a No	-.60	2	-.60	2
3	P-40E	1,000 hp at 13,000 feet	Fin extension no. 6 on tail fin and rudder, trim tab only	225	0	1	1	1	1	1	1	No	-.83	1	-.99	1
4	P-40F	1,080 hp at 21,000	Original, 20-in. fuselage extension, trim tab only	237	0	2	2	4	4	3	2	No	-.54	3	-.51	3

^aRudder force reduced to zero but no reversals were encountered.

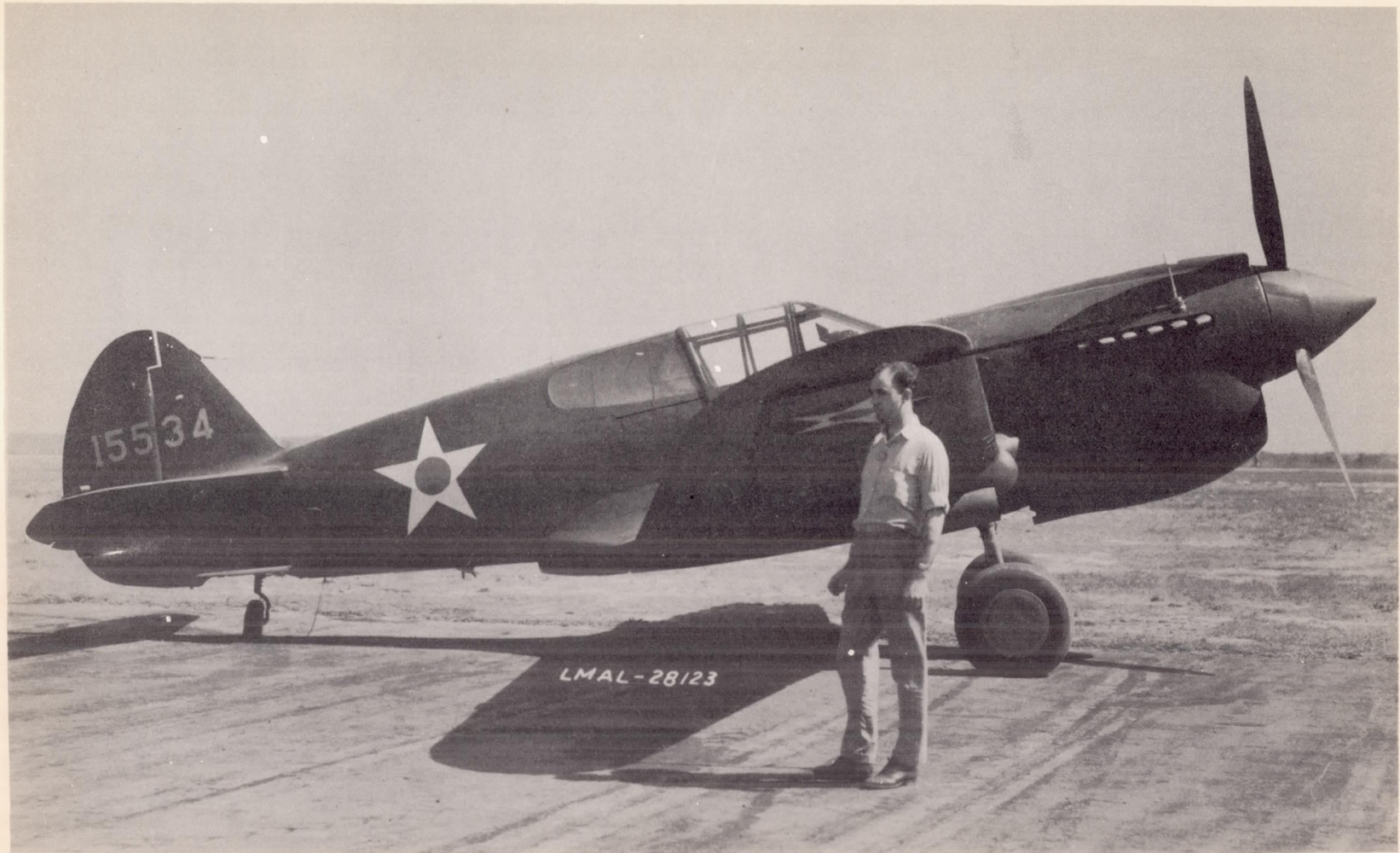

Figure 1.- Side view of Curtiss P-40E airplane with original vertical tail surfaces.

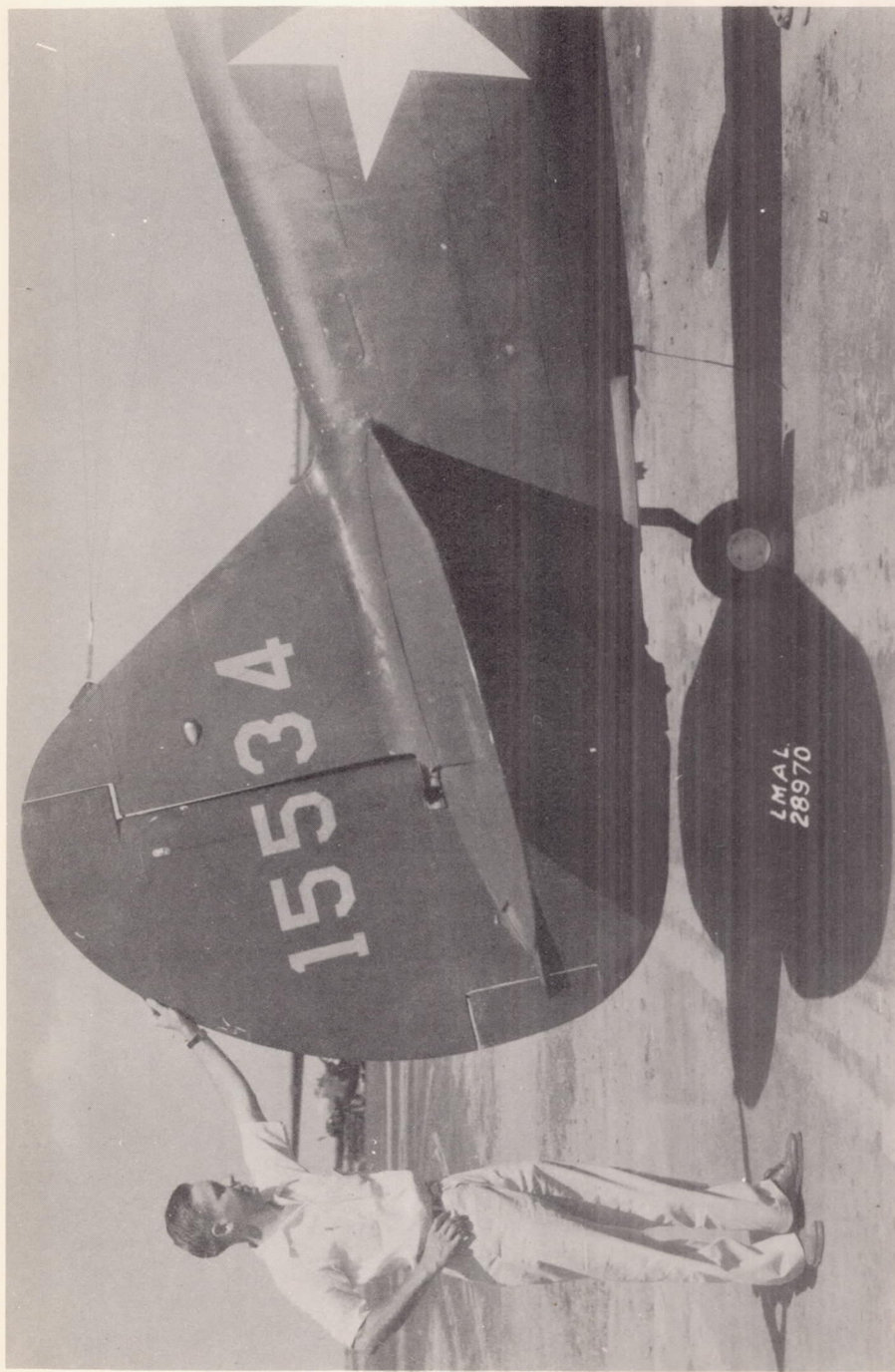

Figure 2.- Side view of original P-40E vertical tail.

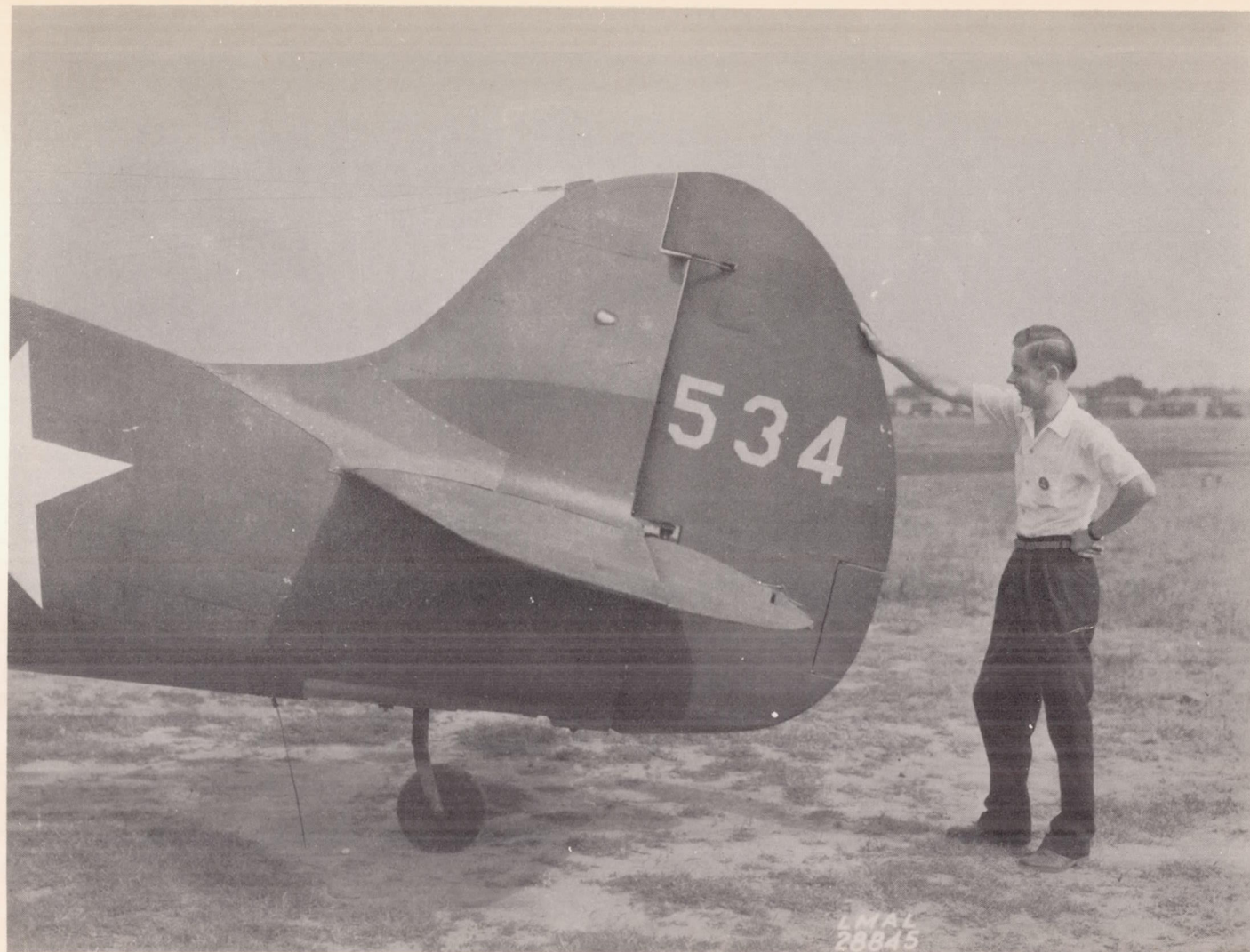

Figure 3.- Side view of Curtiss fin extension No. 1 on original P-40 vertical tail.

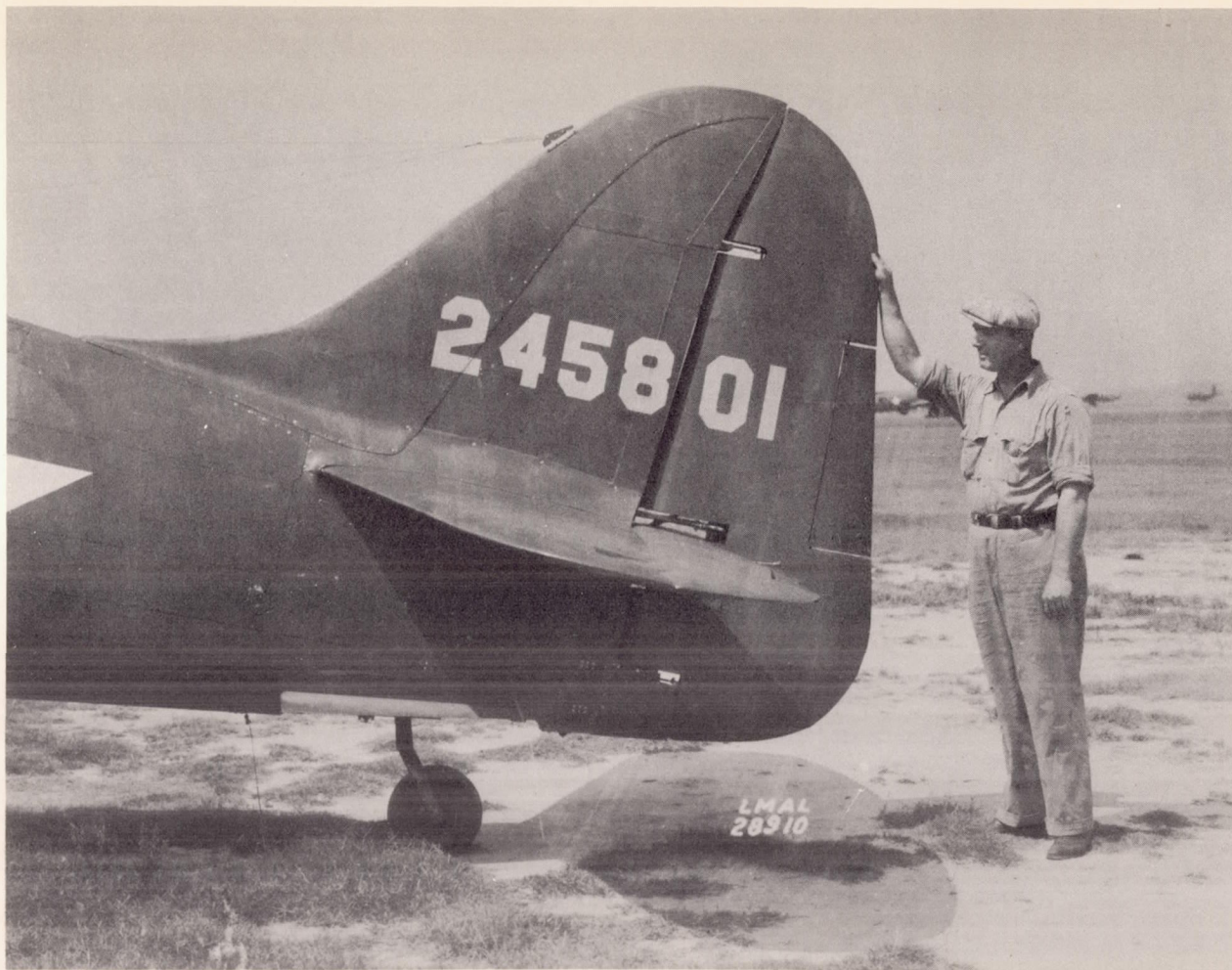

Figure 4.- Side view of Curtiss fin extension No. 6 on a tall fin
(Curtiss DWG. Sk-5524) and rudder (Curtiss DWG. Sk-5676).

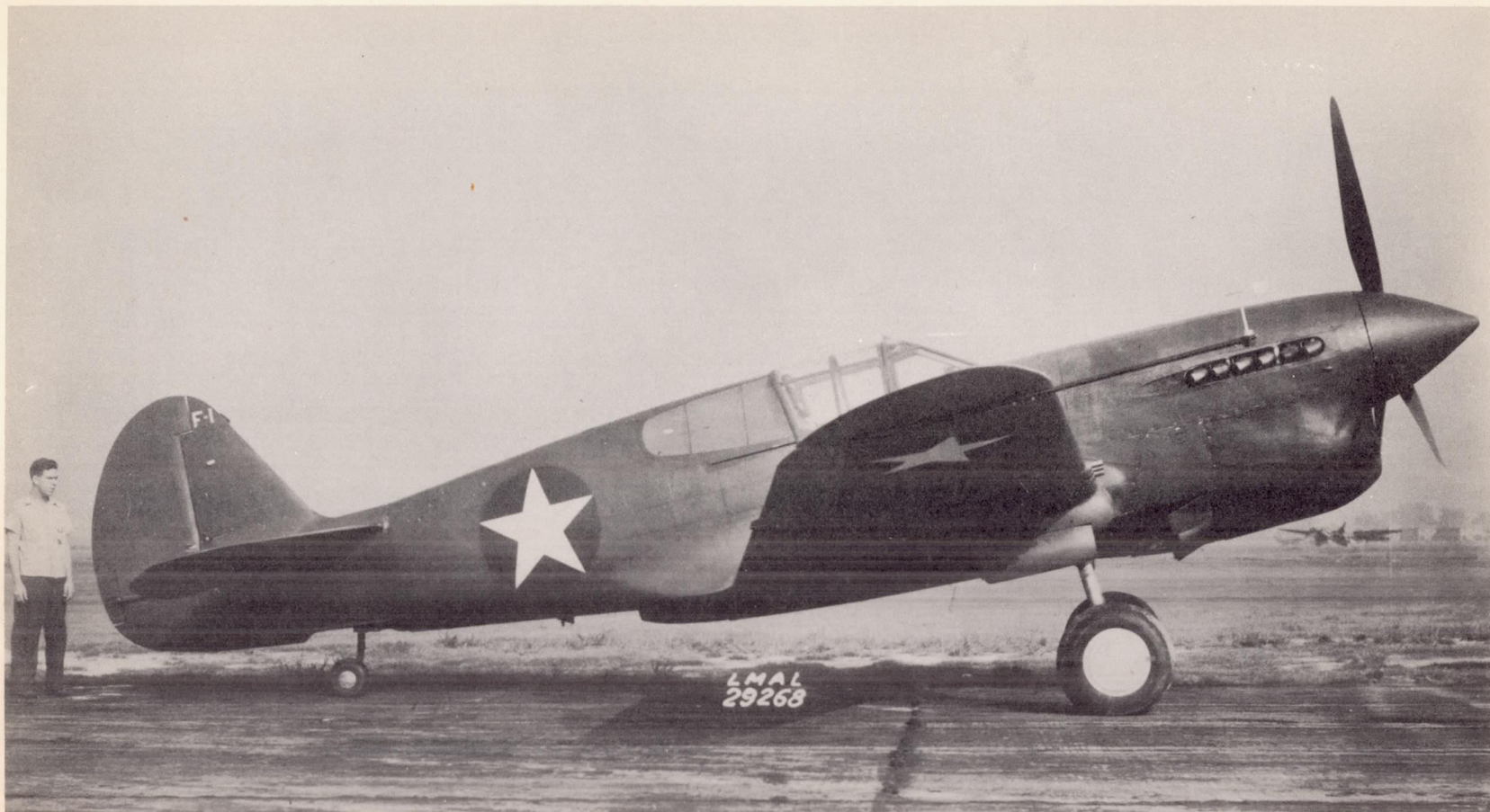

Figure 5.- Side view of Curtiss P-40F airplane with an original vertical tail on a 20-inch fuselage extension.

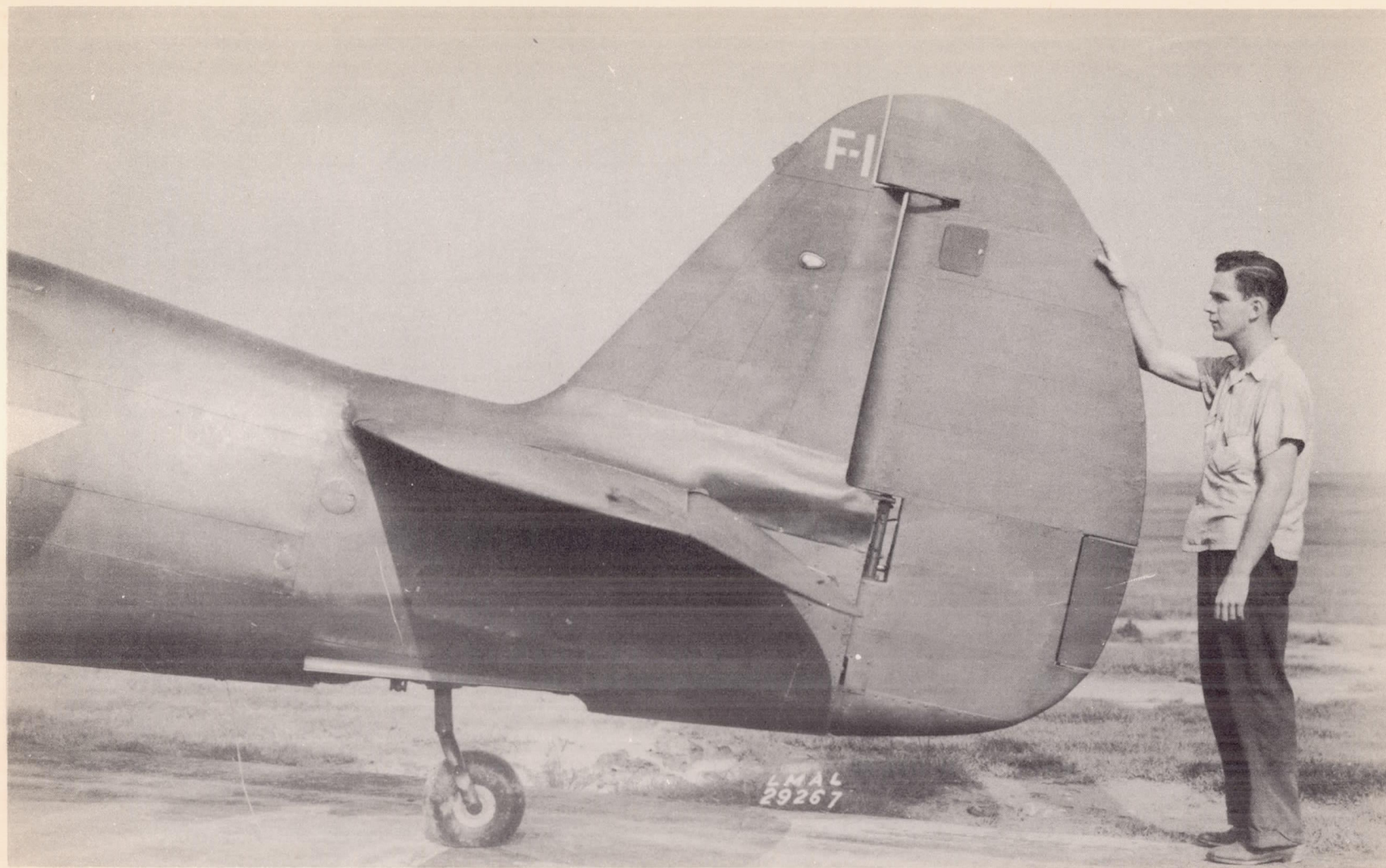

Figure 6.- Side view of original vertical tail on the P-40F airplane with a 20-inch fuselage extension.

Approximate areas, sq. ft.	(a)	(b)	(c)
Total vertical tail area	22.0	23.4	28.7
Fixed fin area	7.5	8.9	15.2
Total rudder area	14.5	14.5	13.5
Rudder area forward of hinge ζ	2.5	2.5	3.8
Rudder area aft of hinge ζ	12.0	12.0	9.7
Rudder tab area	.69	.69	1.10

NATIONAL ADVISORY
COMMITTEE FOR AERONAUTICS

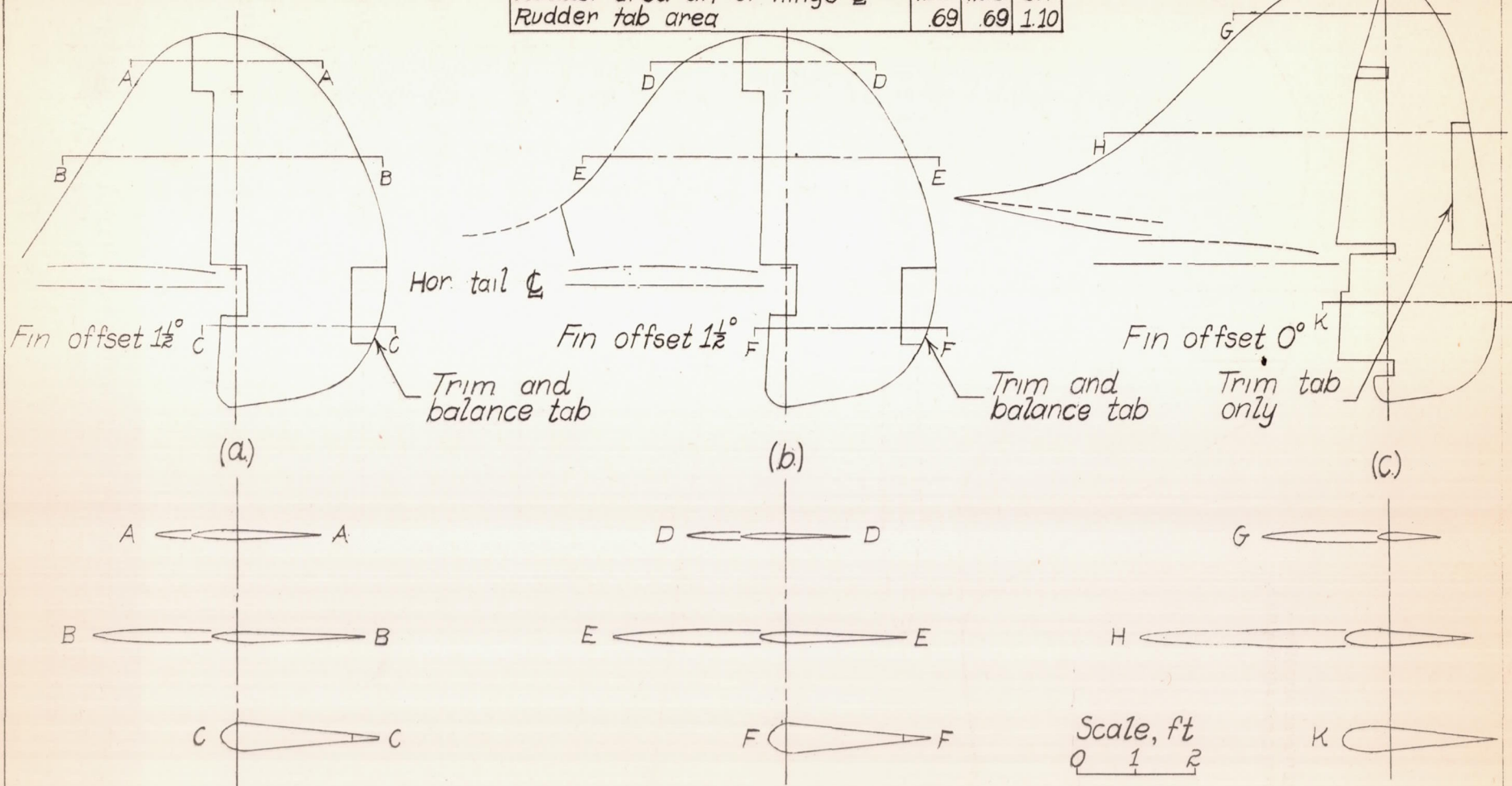
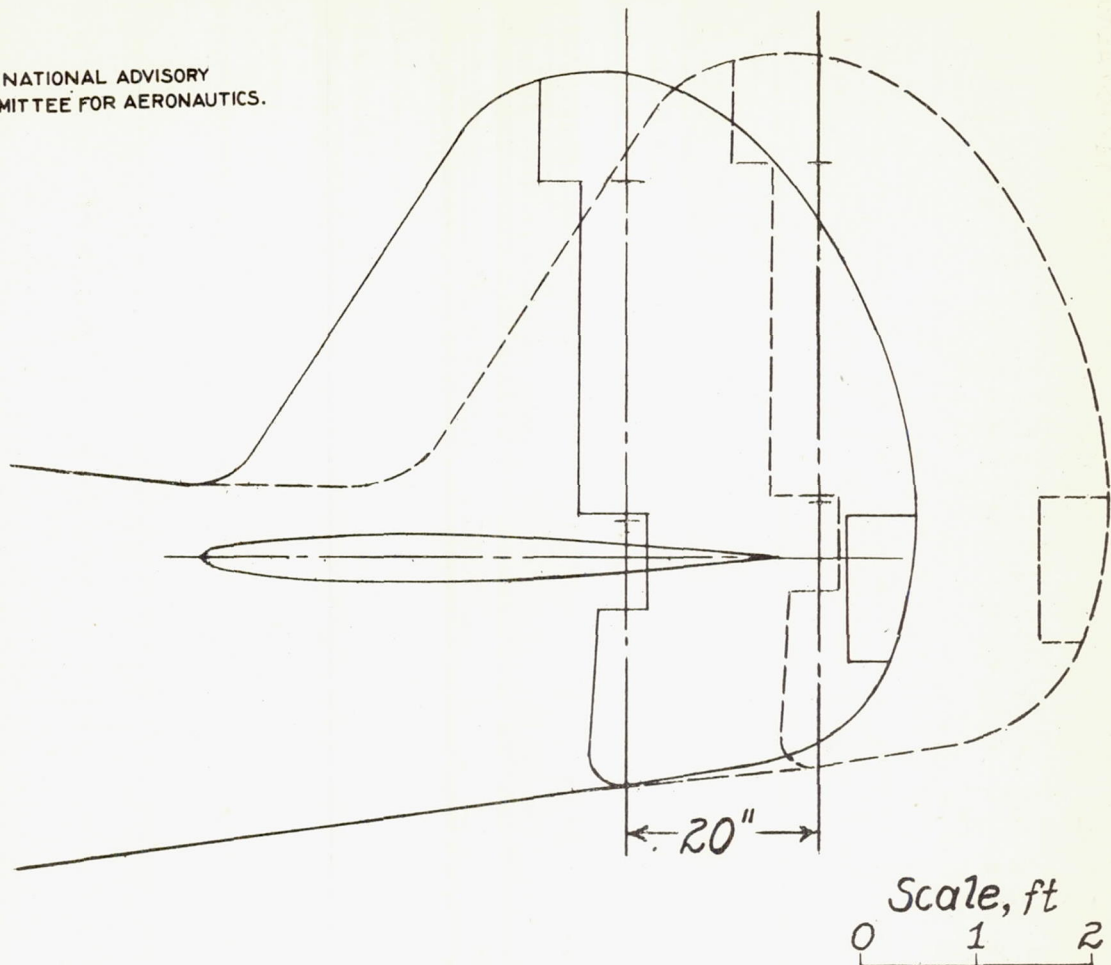

Figure 7a. - Vertical tails tested on P-40E airplane: (a) original P-40E vertical tail; (b) fin extension no. 1 on original vertical tail; (c) fin extension no. 6 on tall fin (Curtiss dwg. SK-5524) and rudder (Curtiss dwg. SK-5676).

NATIONAL ADVISORY
COMMITTEE FOR AERONAUTICS.



- P-40E Airplane
Fin offset $1\frac{1}{2}^\circ$
Trim and balance tab
- P-40F Airplane
Fin offset 0°
Trim tab only
20" fuselage extension

Figure 7b. - Comparison of original vertical tail arrangements tested on the P-40E airplane and on the P-40F airplane with the extended fuselage.

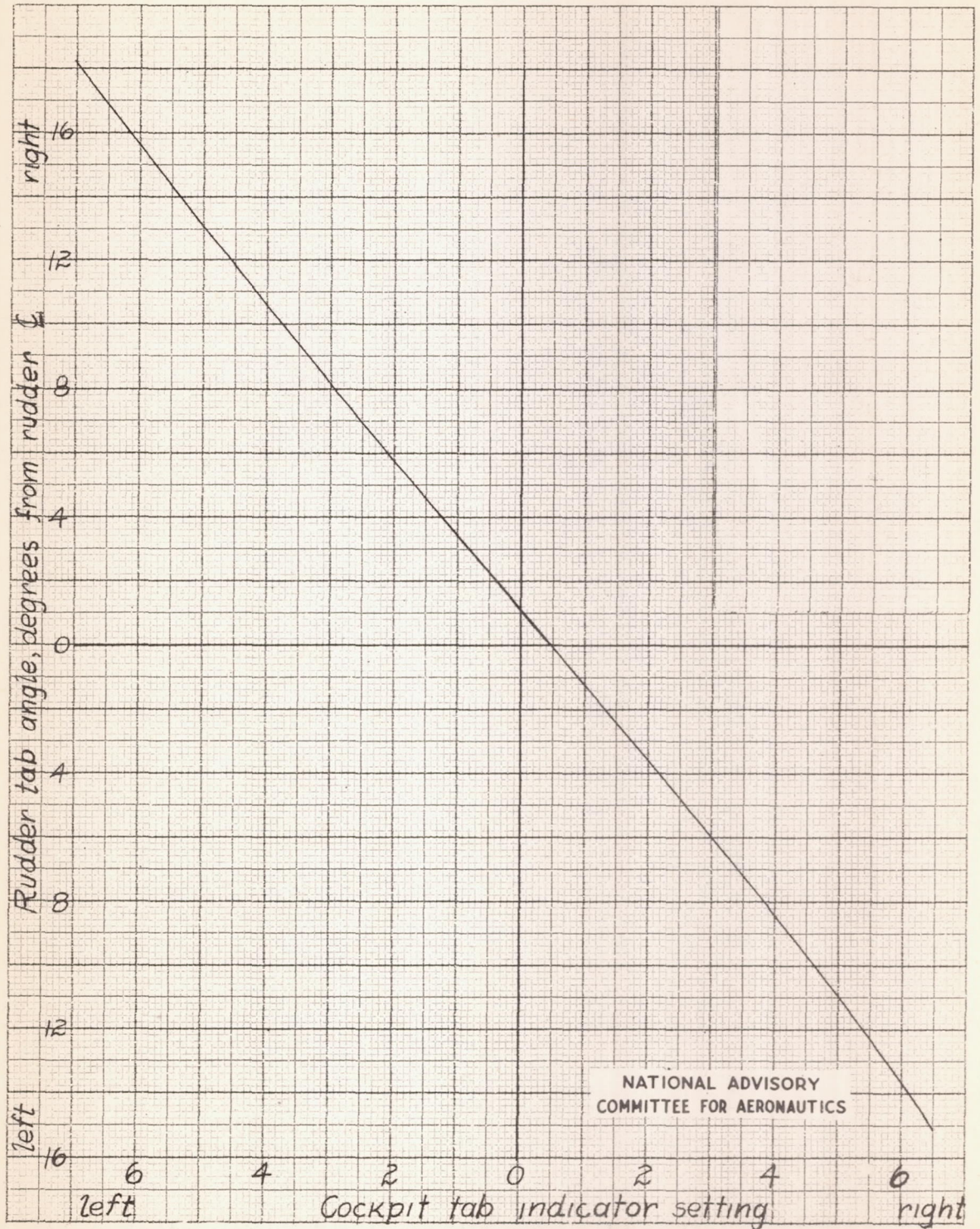

Figure 8.- Relation between rudder tab position and cockpit indicator setting with rudder parallel to thrust axis, P-40E airplane, original vertical tail with and without fin extension no. 1, fin offset 1-1/2°.

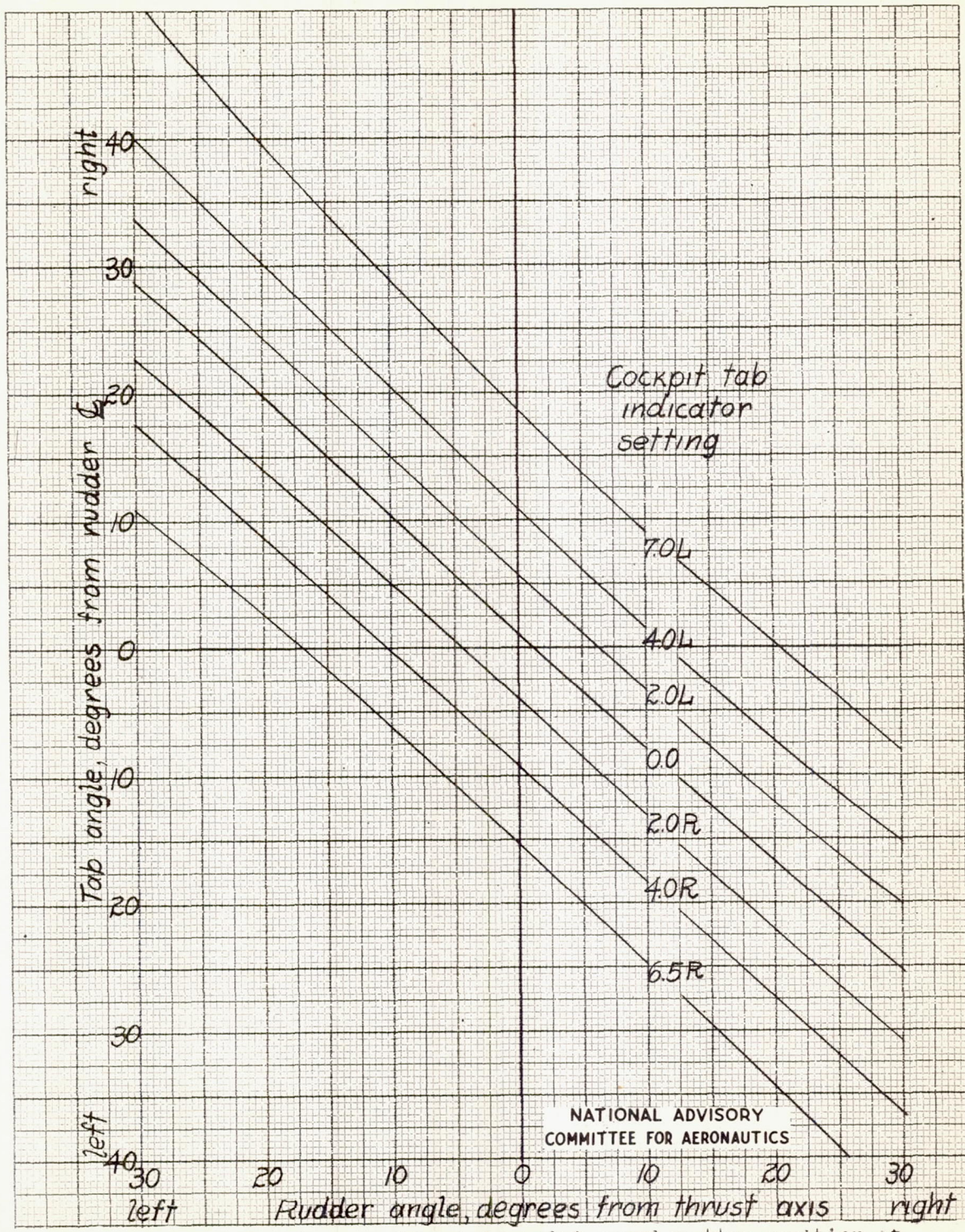

Figure 9.- Relation between rudder tab position and rudder position at various cockpit tab indicator settings, P-40E airplane, original vertical tail with and without fin extension no. 1, fin offset 1-1/2°.

NATIONAL ADVISORY
COMMITTEE FOR AERONAUTICS

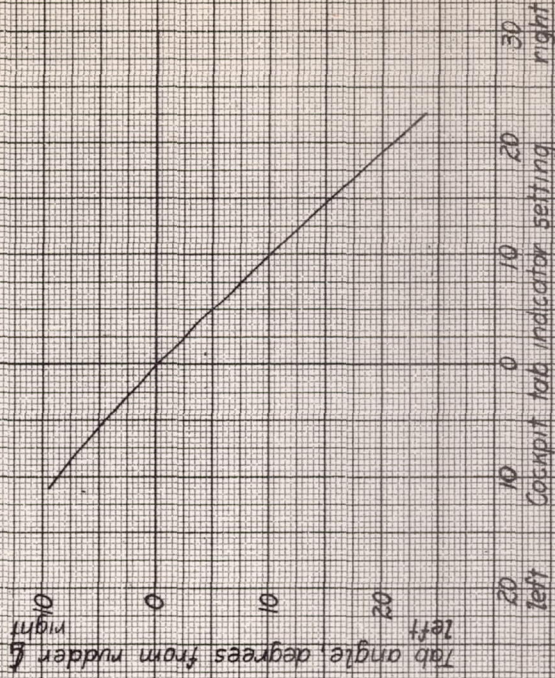

Figure 11. - Relation between rudder trim tab position and cockpit indicator setting, P-40G airplanes, original vertical tail on 20-inch fuselage extension, fin offset 0°.

NATIONAL ADVISORY
COMMITTEE FOR AERONAUTICS

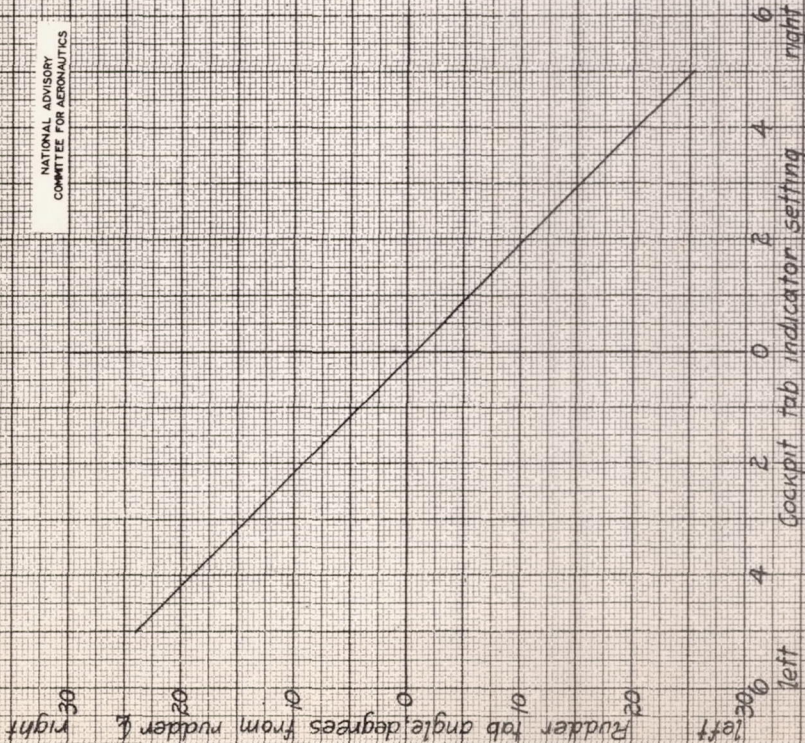

Figure 10. - Relation between rudder trim tab position and cockpit indicator setting, P-40G airplanes, fin extension no. 6 on tall fin and rudder, fin offset 0°.

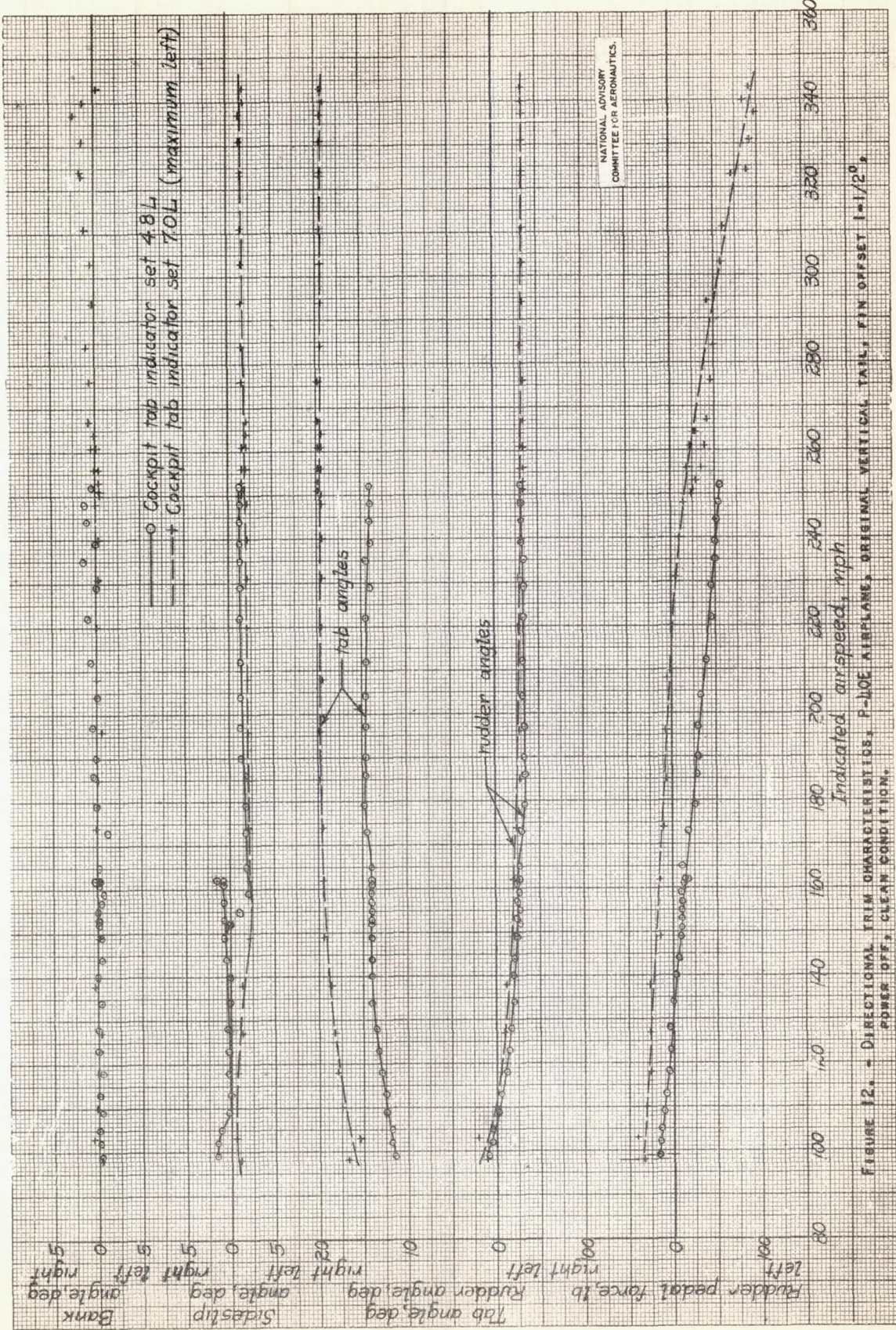

FIGURE 12. - DIRECTIONAL TRIM CHARACTERISTICS, P-10E AIRPLANE, ORIGINAL VERTICAL TAIL, FIN OFFSET 1+1/2", POWER OFF, CLEAN CONDITION.

NATIONAL ADVISORY
COMMITTEE FOR AERONAUTICS

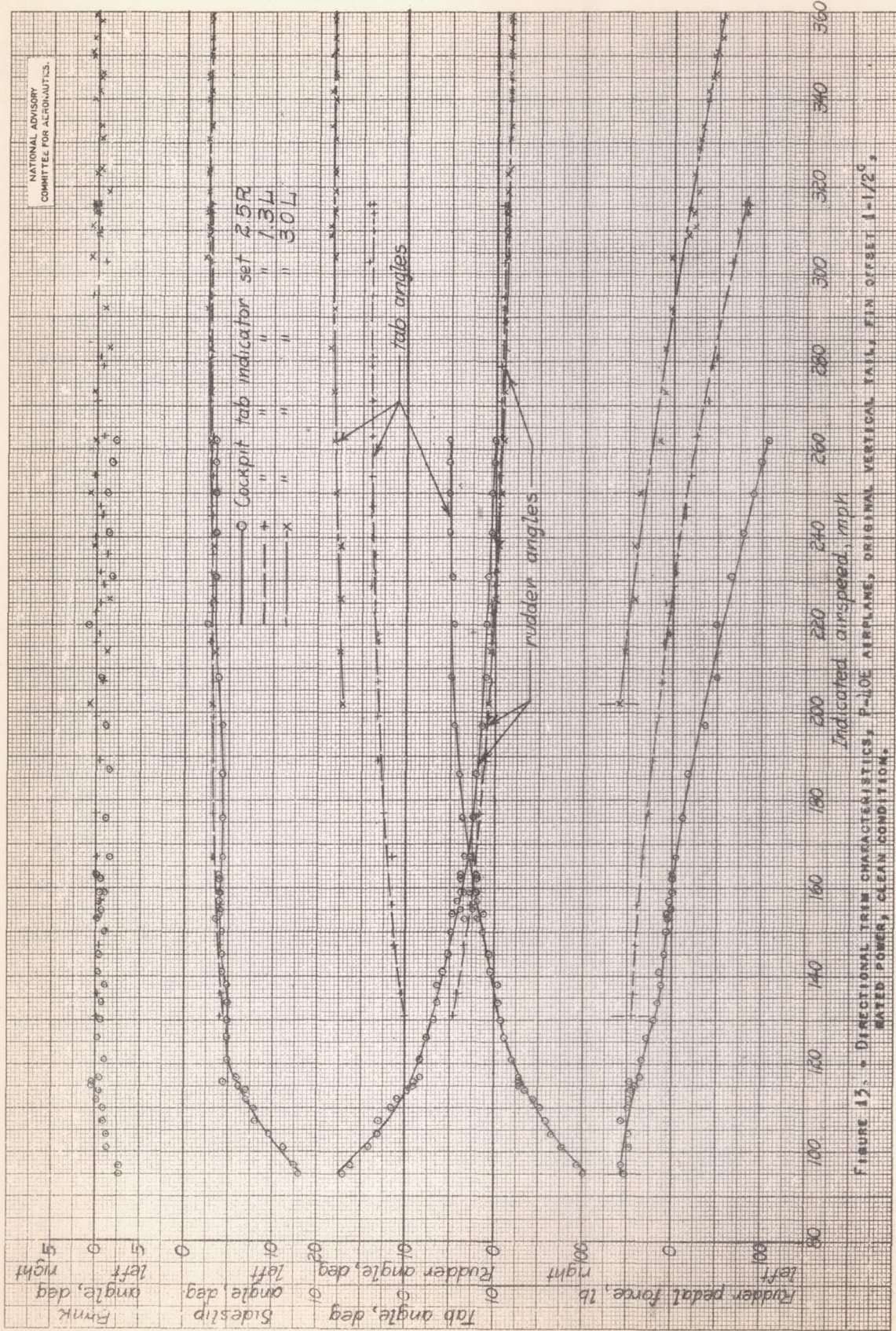
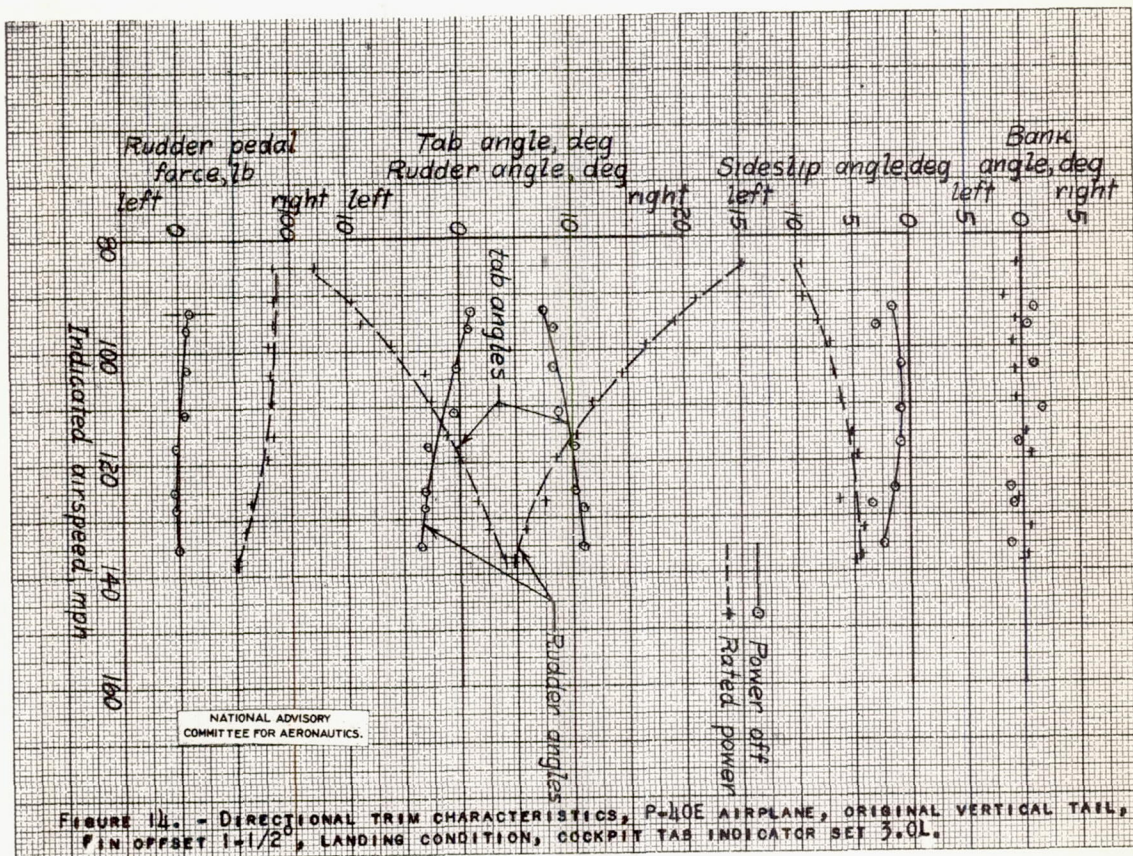

FIGURE 15. DIRECTIONAL TRIM CHARACTERISTICS, P-40E AIRPLANE, ORIGINAL VERTICAL TAIL, FIN OFFSET 1-1/2°, BATED POWER, CLEAN CONDITION.



NATIONAL ADVISORY
COMMITTEE FOR AERONAUTICS.

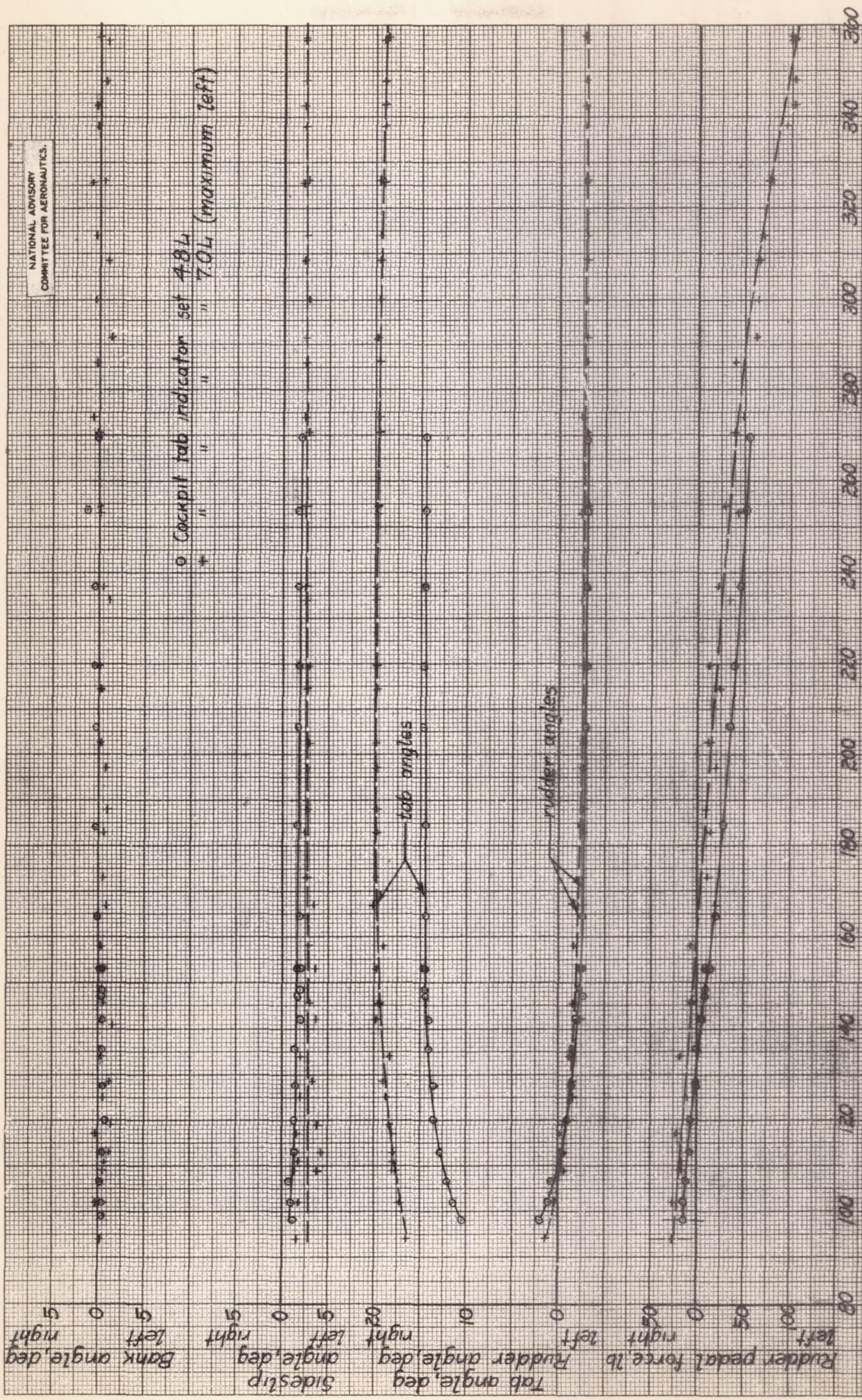

FIGURE 15. - DIRECTIONAL TRIM CHARACTERISTICS, P-30C AIRPLANE, FIN EXTENSION NO. 1 ON ORIGINAL VERTICAL TAIL, FIN OFFSET 1-1/2", POWER OFF, CLEAN CONDITION.

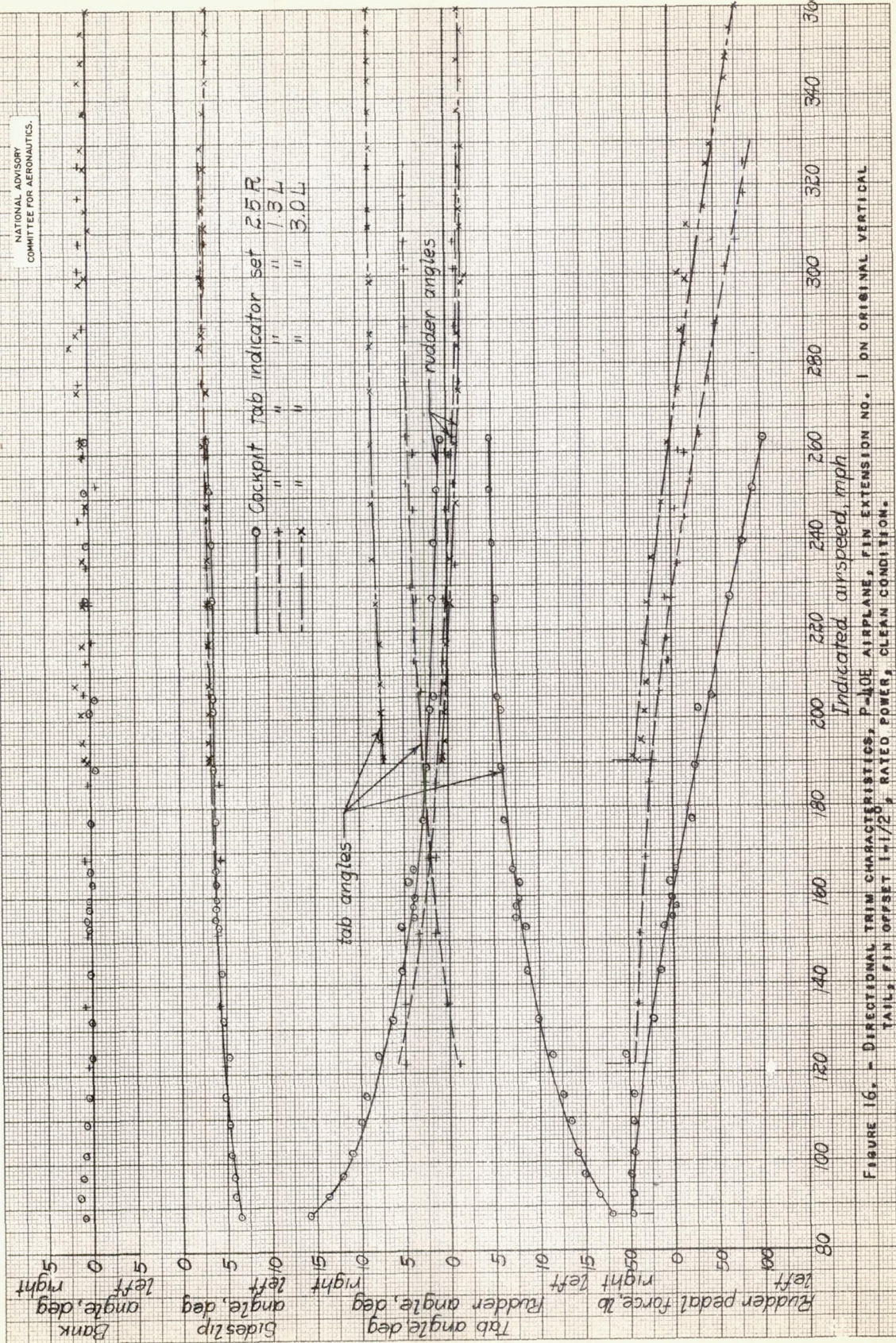
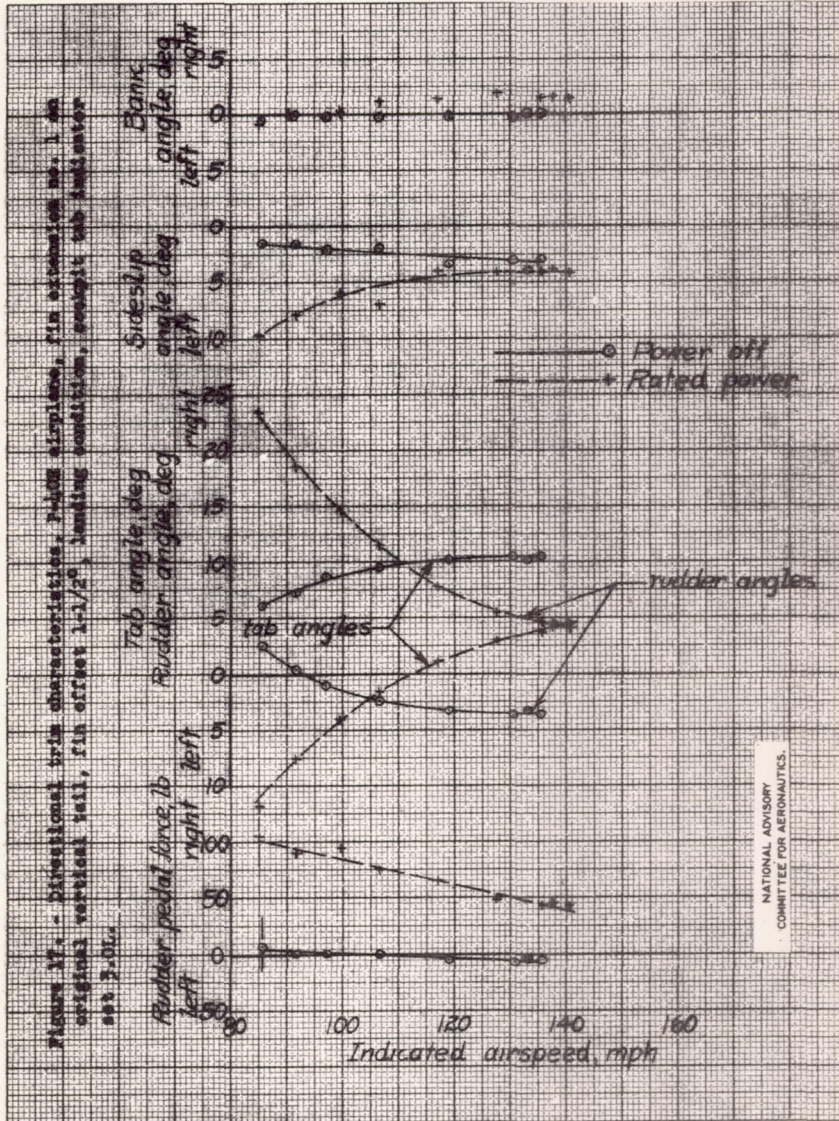

FIGURE 16. - DIRECTIONAL TRIM CHARACTERISTICS, P-10E AIRPLANE, FIN EXTENSION NO. 1 ON ORIGINAL VERTICAL TAIL, FIN OFFSET 1-1/2° RATED POWER, CLEAN CONDITION.



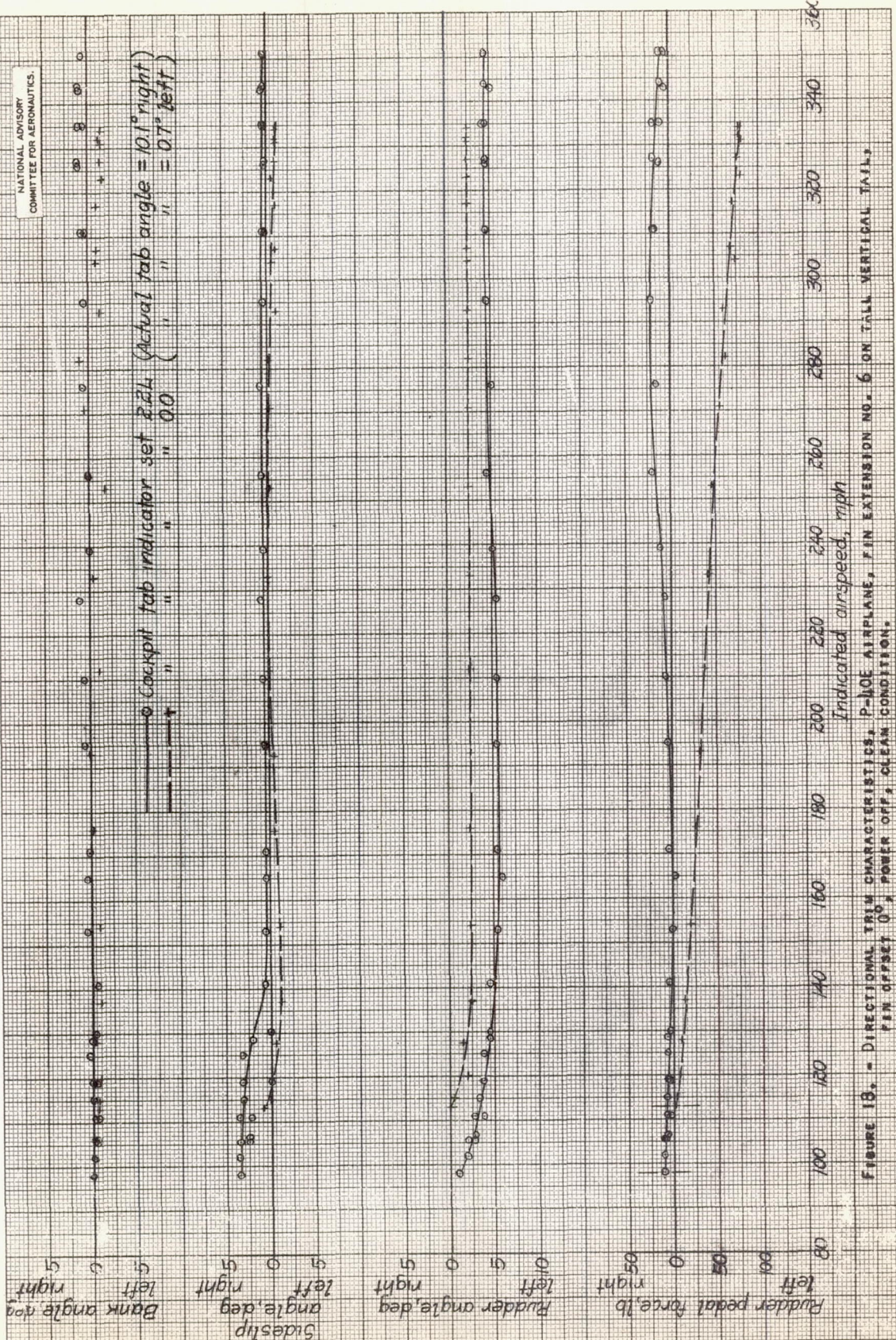

FIGURE 13. - DIRECTIONAL TRIM CHARACTERISTICS, P-10E AIRPLANE, FIN EXTENSION NO. 6 ON TALL VERTICAL TAIL, PEN OFFSET 0, POWER OFF, CLEAN CONDITION.

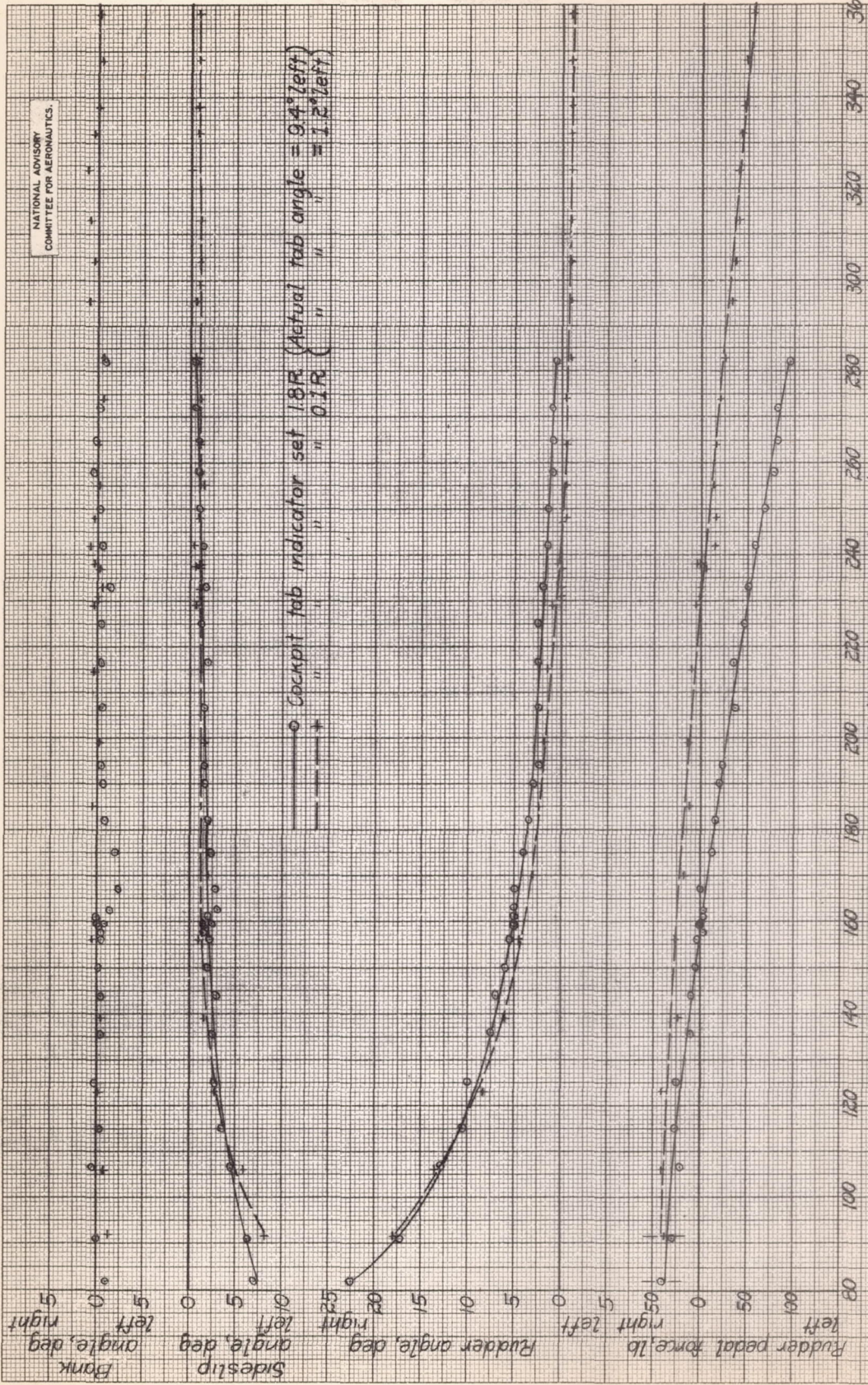

FIGURE 19. - DIRECTIONAL TRIM CHARACTERISTICS, P-10E AIRPLANE, FIN EXTENSION NO. 6 ON TALL VERTICAL TAIL, FIN OFFSET 0°, POWER, CLEAN CONDITION.

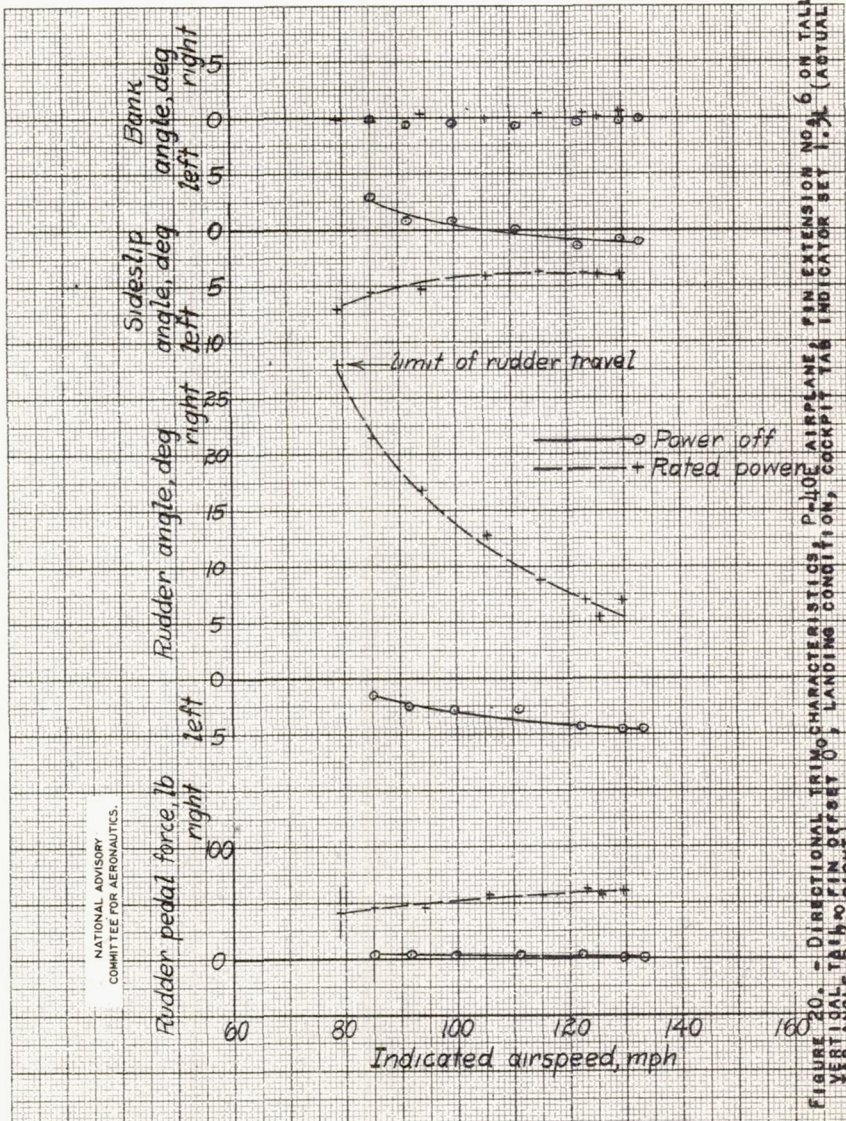

FIGURE 20. - DIRECTIONAL TRIM CHARACTERISTICS, P-40C AIRPLANE, FIN EXTENSION NO. 6 ON TALL VERTICAL TRIM, NO FIN OFFSET 0, LANDING CONDITION, COCKPIT YAG INDICATOR SET 1.0 (ACTUAL YAG ANGLE 5.7° RIGHT).

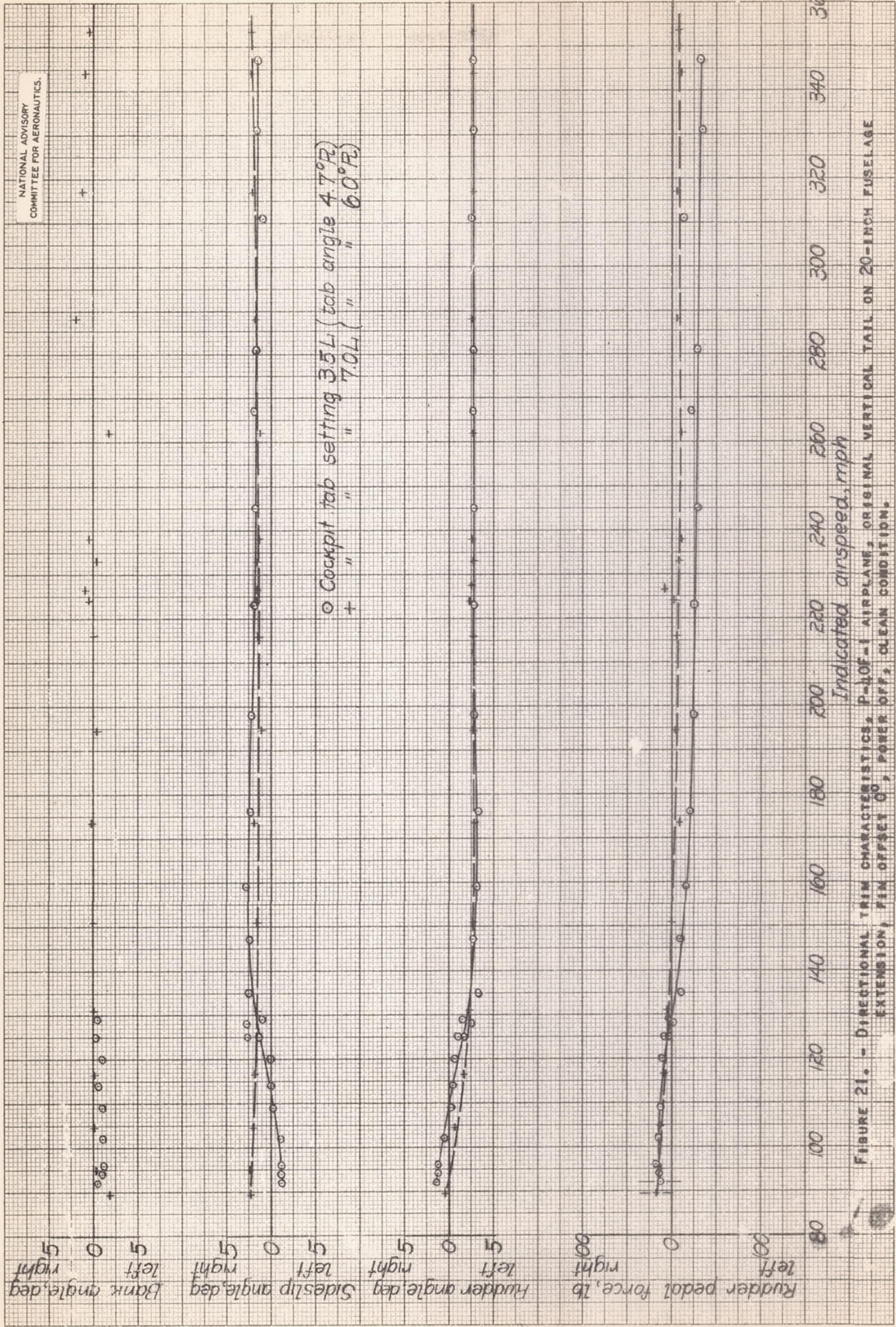

FIGURE 21. - DIRECTIONAL TRIM CHARACTERISTICS, P-40F-1 AIRPLANE, ORIGINAL VERTICAL TAIL ON 20-INCH FUSELAGE EXTENSION, FIN OFFSET 0°, POWER OFF, CLEAN CONDITION.

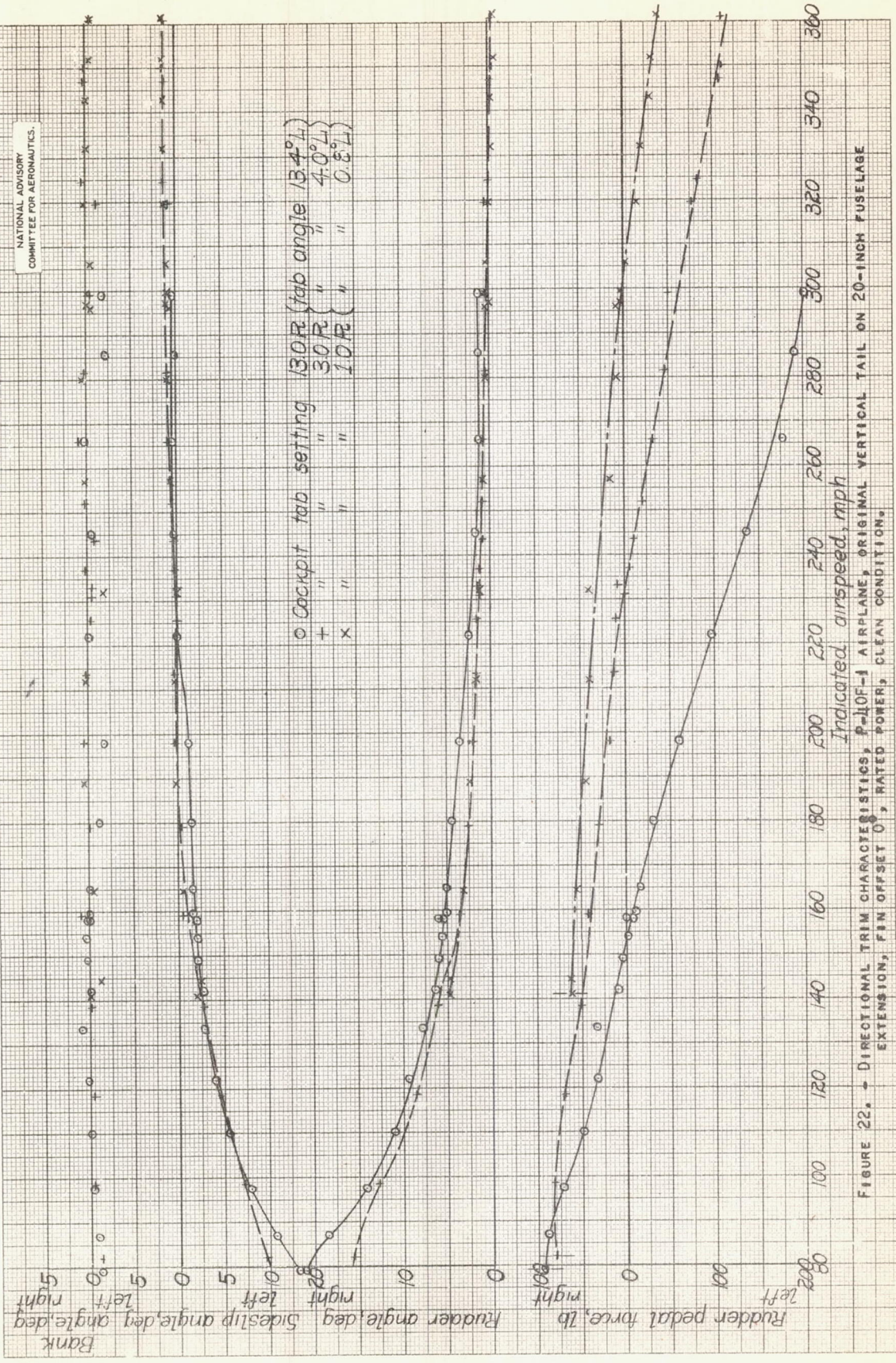
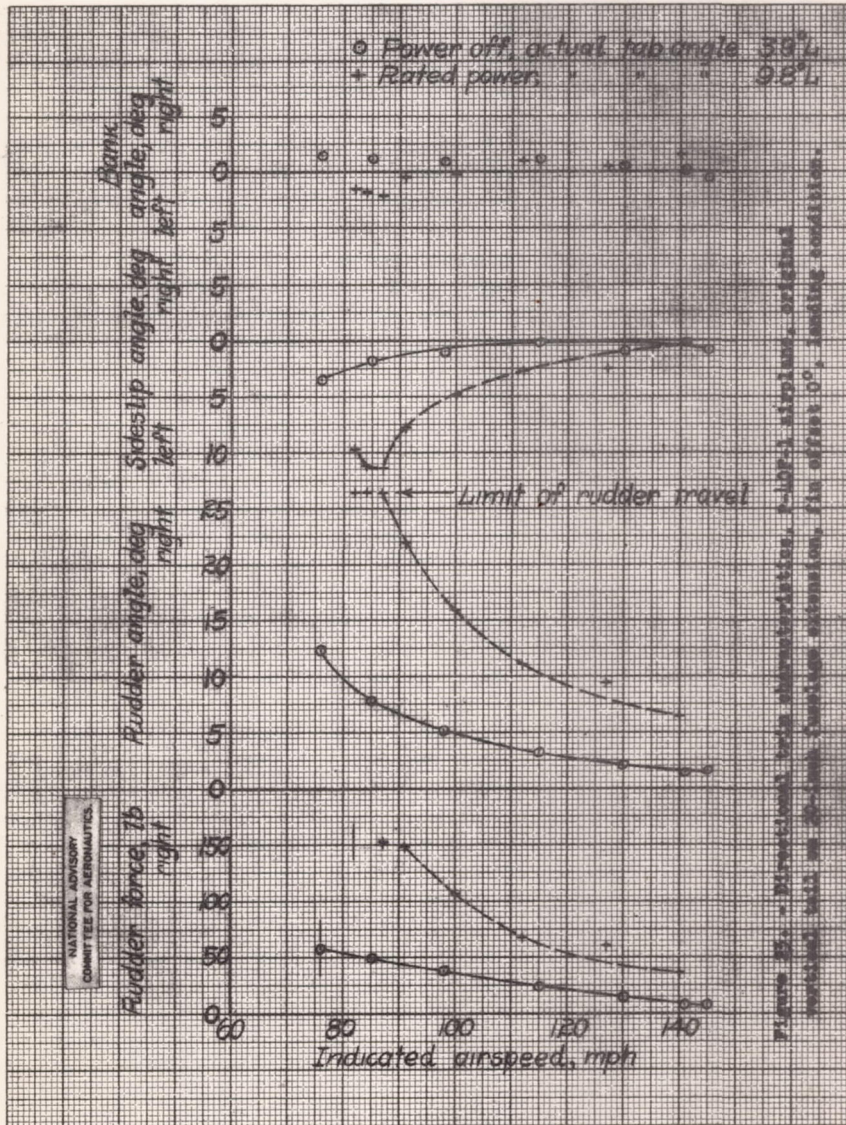

FIGURE 22. + DIRECTIONAL TRIM CHARACTERISTICS, P-10F-1 AIRPLANE, ORIGINAL VERTICAL TAIL ON 20-INCH FUSELAGE EXTENSION, FIN OFFSET 0, RATED POWER, CLEAN CONDITION.



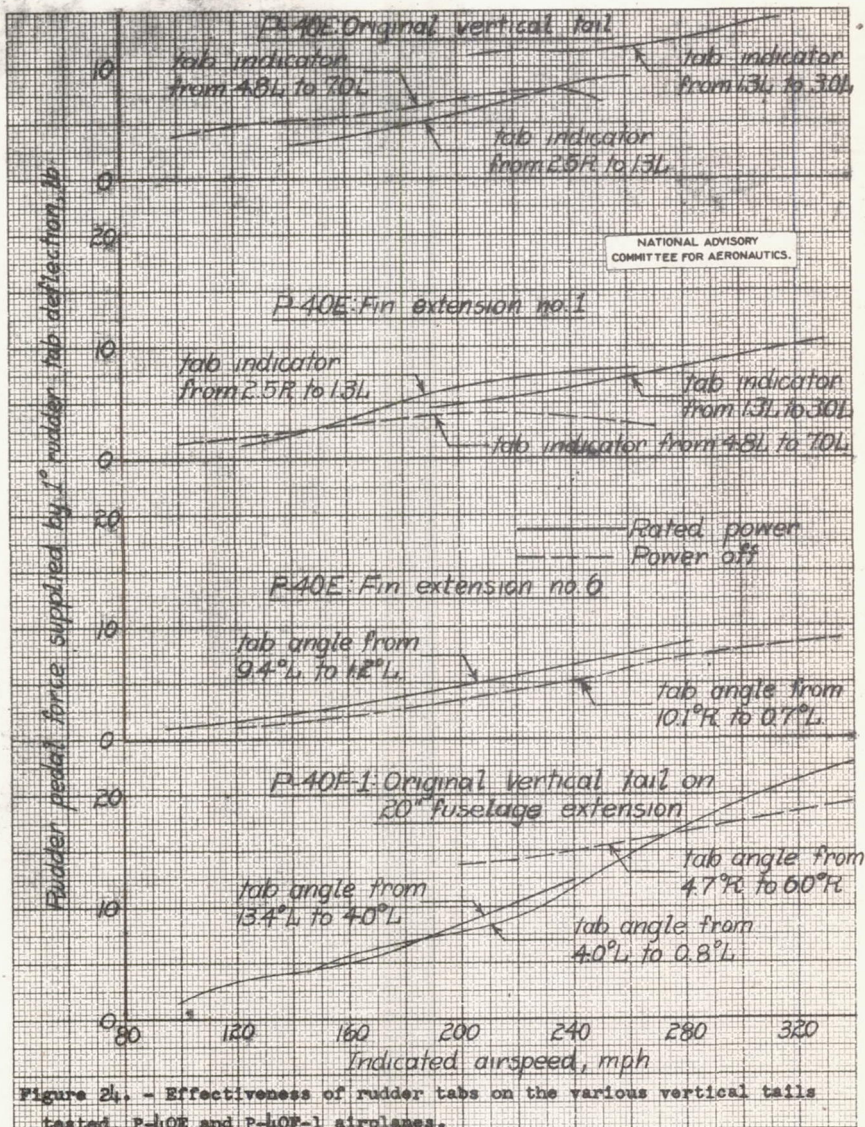

Figure 24. - Effectiveness of rudder tabs on the various vertical tails tested, P-40E and P-40F-1 airplanes.

Original Tail	Fin Ext No 1	Fin Ext No 6
Fin Offset $1\frac{1}{2}^\circ$	Fin Offset $1\frac{1}{2}^\circ$	No Fin Offset
Balance Tab	Balance Tab	No Balance Tab

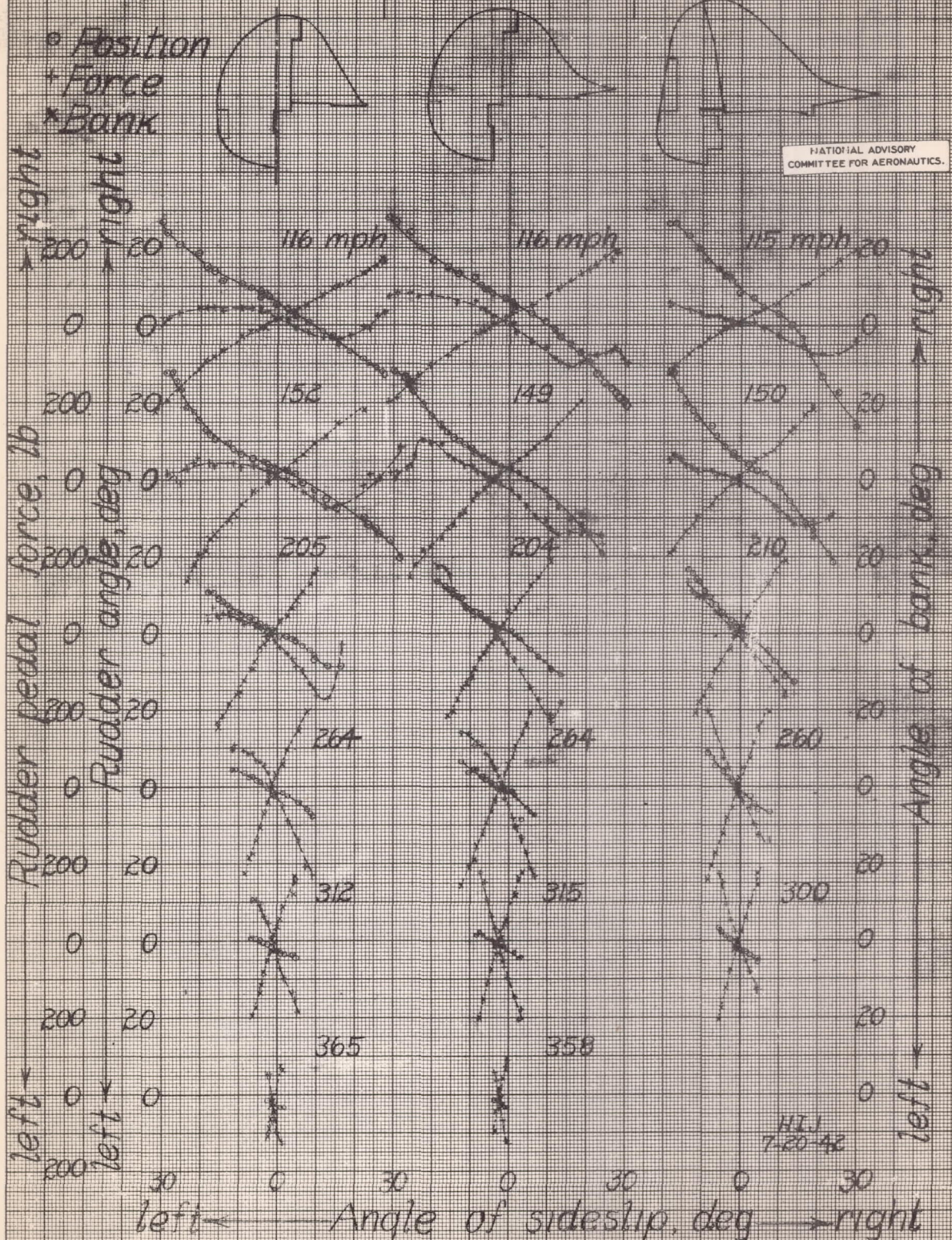

Figure 25 - Sideslip Characteristics of a P-40E Airplane at Various Indicated Airspeeds with Rated Power

P-40E
 Fin Offset $1\frac{1}{2}^\circ$
 Balance Tab
 Original Fuselage

P-40F-1
 Fin Offset 0°
 No Balance Tab
 20" Fuselage Extension

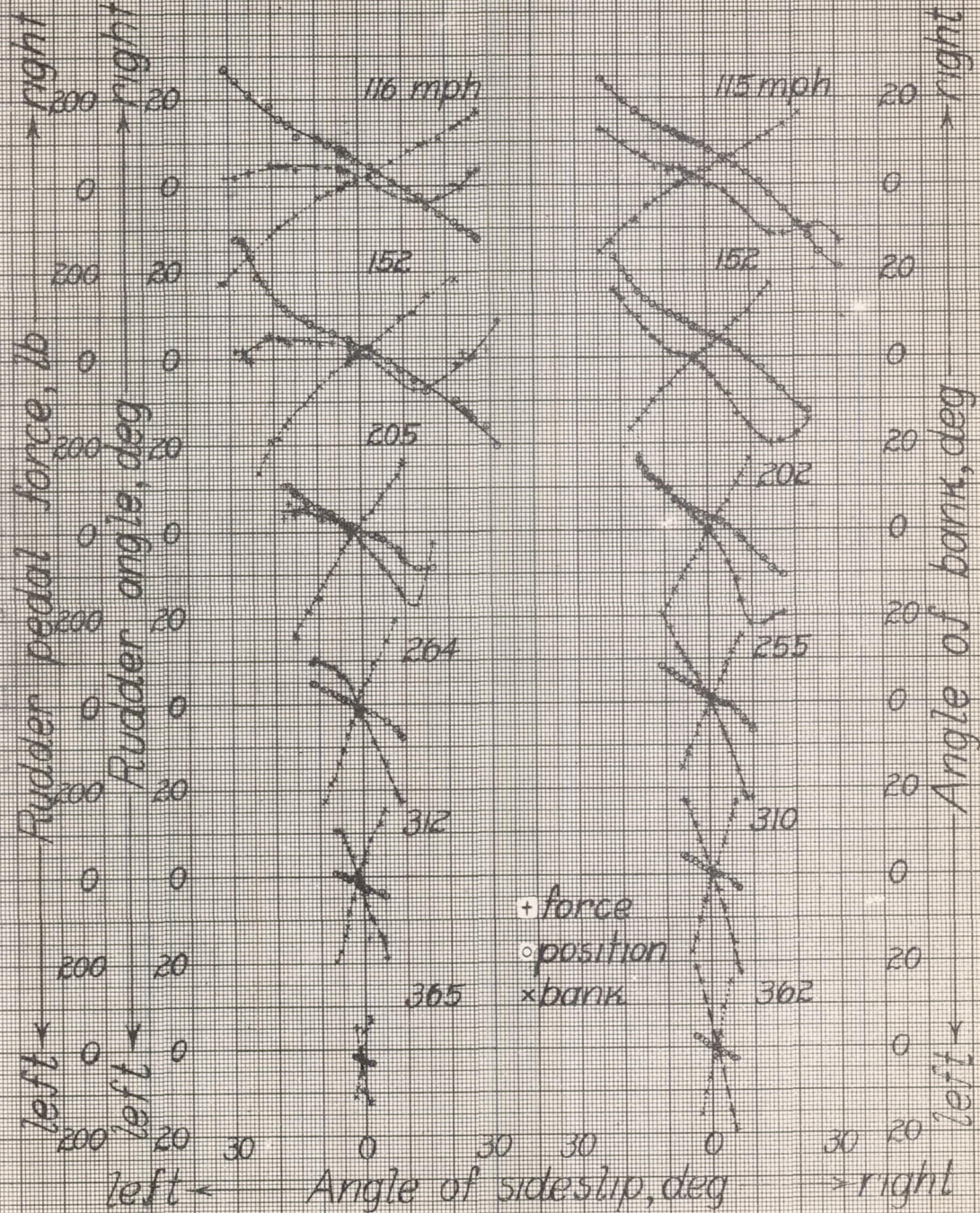

Figure 25a-Sideslip Characteristics of P-40E and P-40F-1 Airplanes with Original Vertical Tails at Various Indicated Airspeeds with Rated Power

1-547

Original Tail	Fin Ext No 1	Fin Ext No 6
Fin Offset 1 1/2°	Fin Offset 1 1/2°	No Fin Offset
Balance Tab	Balance Tab	No Balance Tab

○ Position
 + Force
 × Bank

NATIONAL ADVISORY
 COMMITTEE FOR AERONAUTICS.

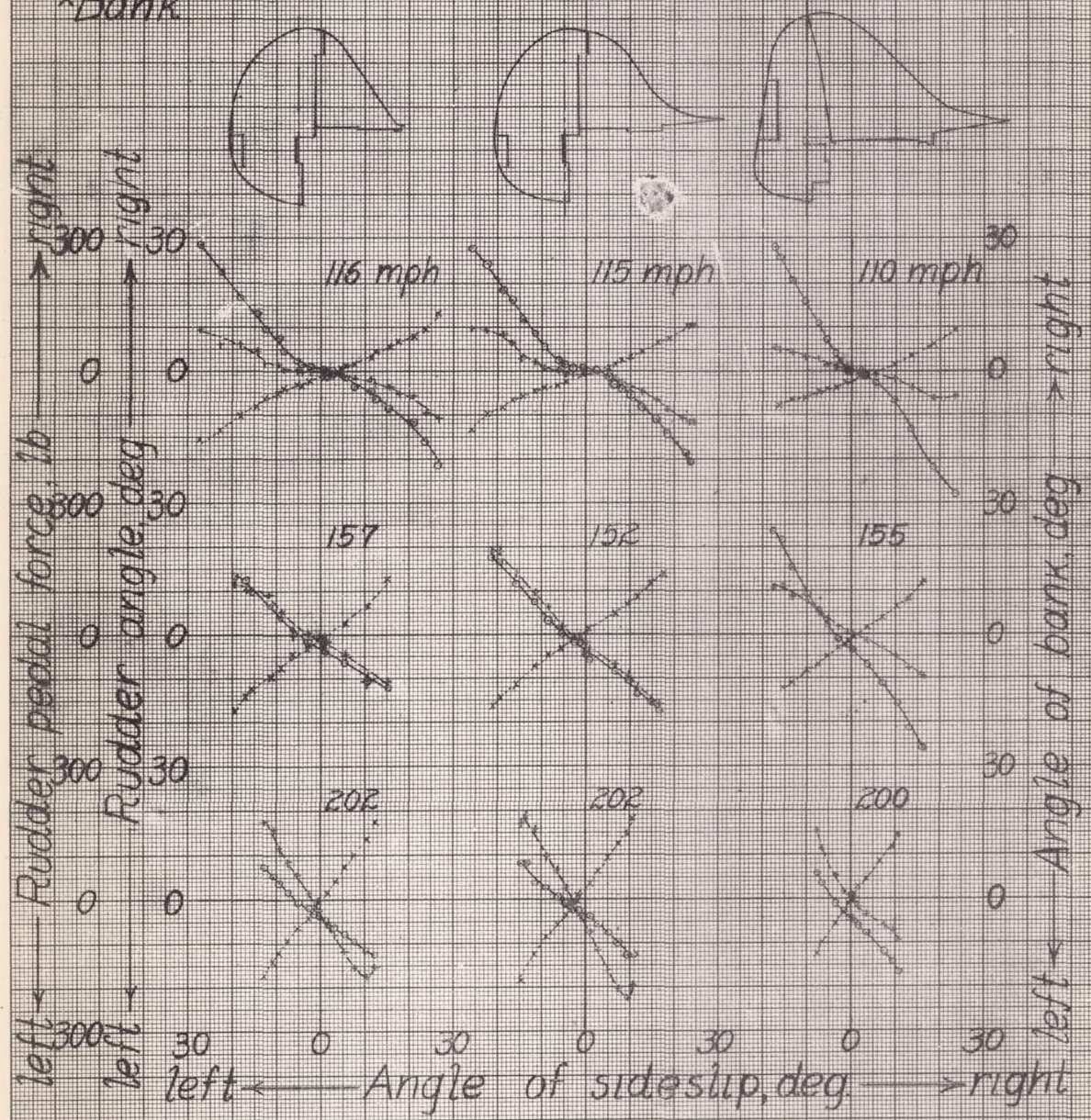

Figure 26 - Sideslip Characteristics of a P-40E airplane at Various Indicated Airspeeds with Power off.

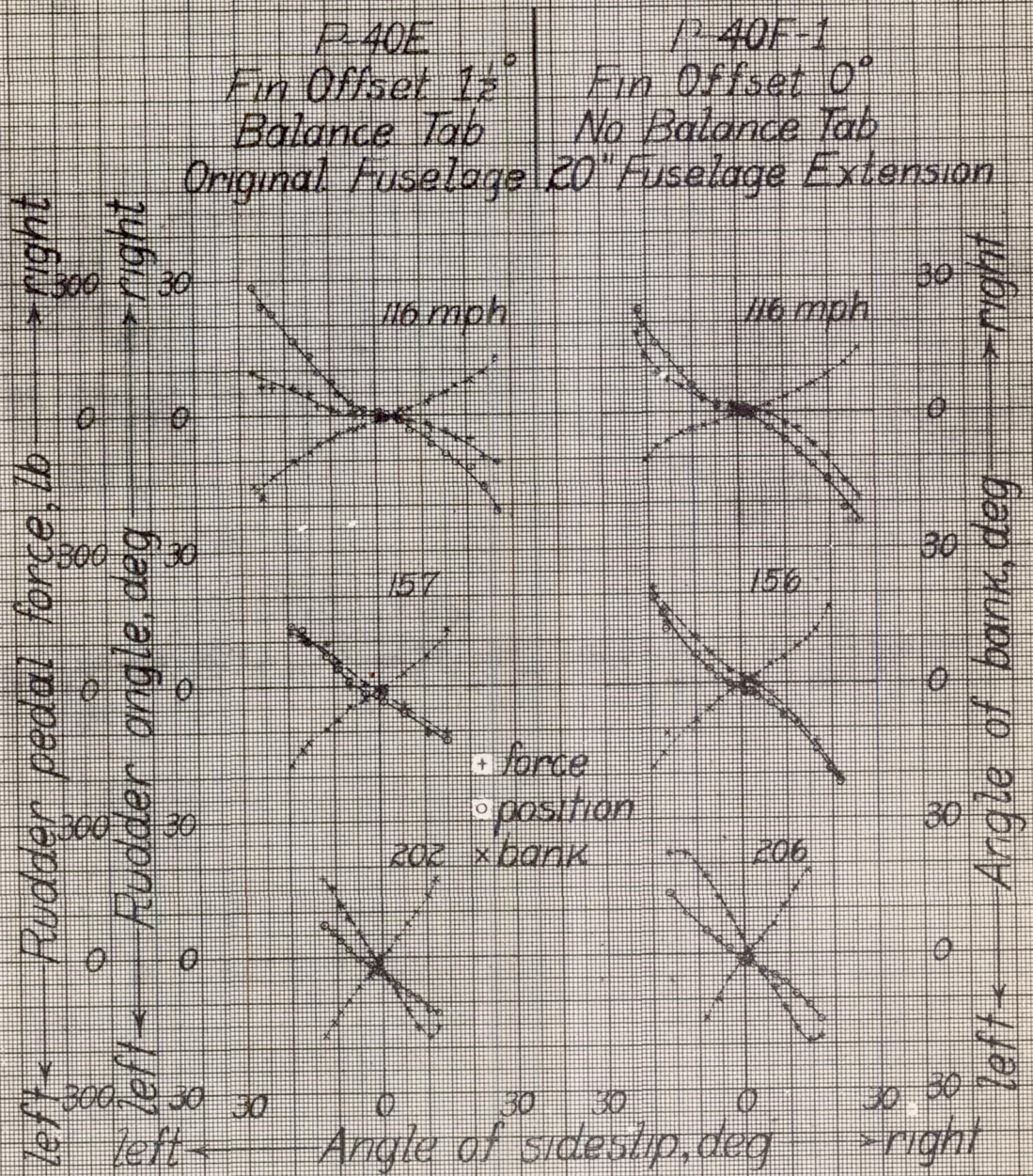

Figure 26a Sideslip Characteristics of P-40E and P-40F-1 Airplanes with Original Vertical Tails at Various Indicated Airspeeds with Power Off

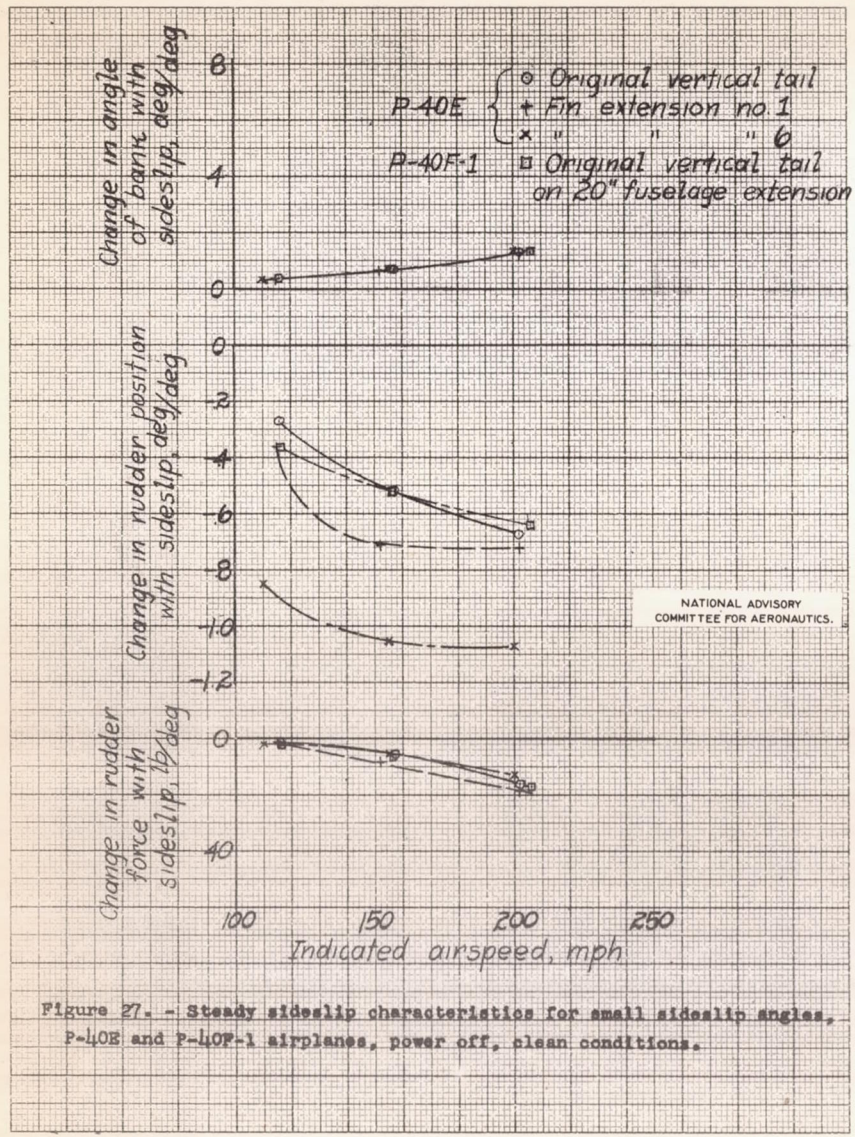

Figure 27. - Steady sideslip characteristics for small sideslip angles, P-40E and P-40F-1 airplanes, power off, clean conditions.

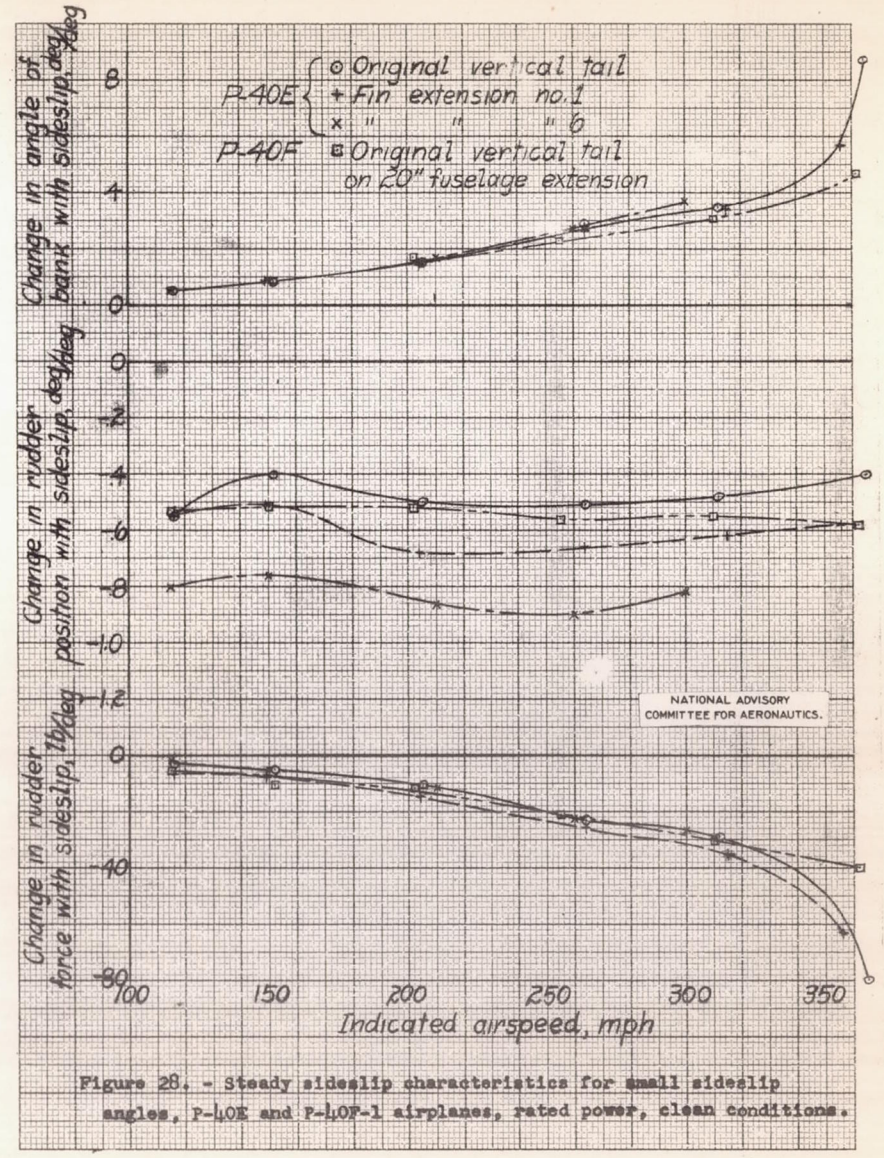

Figure 28. - Steady sideslip characteristics for small sideslip angles, P-40E and P-40F-1 airplanes, rated power, clean conditions.