

CASEFILE  
COPY

ACR Sept. 1942

NATIONAL ADVISORY COMMITTEE FOR AERONAUTICS

# WARTIME REPORT

ORIGINALLY ISSUED  
September 1942 as  
Advance Confidential Report

AN INVESTIGATION OF HYDROFOILS IN THE NACA TANK

I - EFFECT OF DIHEDRAL AND DEPTH OF SUBMERSION

By James M. Benson and Norman S. Land

Langley Memorial Aeronautical Laboratory  
Langley Field, Va.

JPL LIBRARY  
CALIFORNIA INSTITUTE OF TECHNOLOGY

The NACA logo features the word "NACA" in a bold, sans-serif font, centered within a stylized wing shape. The wings are represented by a series of parallel lines that taper outwards, creating a sense of motion and aerodynamics.

WASHINGTON

NACA WARTIME REPORTS are reprints of papers originally issued to provide rapid distribution of advance research results to an authorized group requiring them for the war effort. They were previously held under a security status but are now unclassified. Some of these reports were not technically edited. All have been reproduced without change in order to expedite general distribution.

L - 758

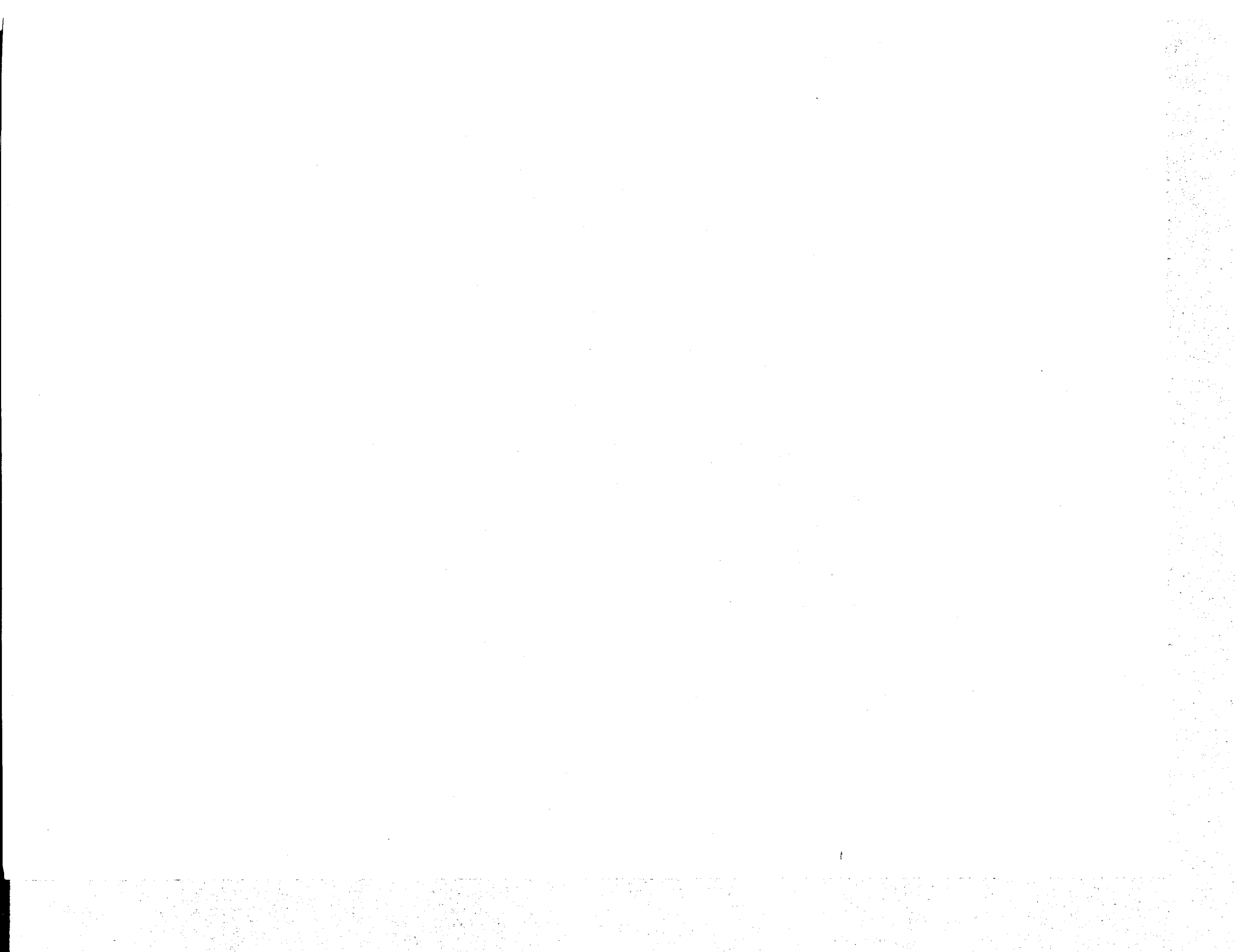

NATIONAL ADVISORY COMMITTEE FOR AERONAUTICS

ADVANCE CONFIDENTIAL REPORT

AN INVESTIGATION OF HYDROFOILS IN THE NACA TANK

I - EFFECT OF DIHEDRAL AND DEPTH OF SUBMERSION

By James M. Benson and Norman S. Land

SUMMARY

Efforts to employ hydrofoils on seaplanes and surface boats have frequently been handicapped by the lack of information on the characteristics of the hydrofoils when near the surface of the water or when breaking the surface. In the present tests a series of hydrofoils, each supported by two struts, was towed at various depths ranging from partial submersions to a depth of 5 chord lengths. Results are presented showing the lift and drag of hydrofoils having a chord of 5 inches, a span of 30 inches, and for angles of dihedral of  $0^\circ$ ,  $10^\circ$ ,  $20^\circ$ , and  $30^\circ$ . The tests included speeds up to 95 feet per second and lift forces up to about 2500 pounds. The hydrofoils tested included two sections, the NACA 16-509 airfoil section and a section derived from the 16-509 by sharpening the leading edge.

At depths greater than 4 or 5 chords the presence of the free water surface appeared not to affect the lift and drag. As the hydrofoil approached the surface, the lift and drag decreased and the speed at which cavitation first appeared on the hydrofoil was increased. In the range of very shallow immersions (less than, say,  $1/2$  chord) abrupt changes in lift and drag occurred when the flow of water over the upper surface separated from the hydrofoil. For applications requiring that the hydrofoil emerge from the water, the larger angles of dihedral ( $20^\circ$  and  $30^\circ$ ) appeared desirable because they produced less abrupt changes in lift and drag.

Two major effects of speed were noted: first, a limitation of the total hydrofoil loading possible (about 2200 lb/sq ft for the depths tested) under conditions of complete upper-surface cavitation; and second, a loss of lift at high speeds and low angles of attack, probably due to lower-surface cavitation.

## INTRODUCTION

To date, the use of hydrofoils on surface craft and seaplanes has been mostly experimental. Although some of the projects making use of hydrofoils may have continued for a considerable time, they appear to have achieved no practical applications that are in service today. One difficulty undoubtedly encountered in the efforts to make use of hydrofoils has been the lack of available information on their fundamental characteristics.

Tests have been made at the NACA tank that answered, in part, this need for preliminary information. The first NACA report on hydrofoils (reference 1) contained data on six zero-dihedral hydrofoils of different sections. Those data gave lift and drag coefficients of each section as affected by angle of attack, speed, and depth below the surface. Speeds at which cavitation first appeared were also given.

The purpose of the tests described herein is to supplement the information given in the first report and to extend it to include the effects of dihedral, of partial submersion, and of sharpening the leading edge. Data are presented to show the effect of these variables upon the lift, the drag, and the cavitation speed. The hydrofoils with sharp leading edges were tested in the belief that, at partial submersions, less spray and consequently less drag might result than from the NACA 16-509 section hydrofoils.

## DESCRIPTION OF HYDROFOILS TESTED

The NACA 16-509 airfoil section is one of a series designed for use at high speeds at which it is advantageous to have a pressure distribution as nearly uniform as possible. The section is designed to have optimum characteristics at a lift coefficient of 0.5 and when used as a hydrofoil, because of its pressure distribution, would be expected to have about as high a cavitation speed as is possible for that particular value of the lift coefficient. The tests of reference 1 showed the NACA 16-509 section would be of some advantage in maintaining satisfactory values of the lift-drag ratio at speeds well beyond those at which cavitation on the more conventional airfoils would

cause a large increase in drag. Consequently it seemed desirable to employ this section in the present tests of hydrofoils with dihedral. Three hydrofoils of this section having dihedral angles of  $10^\circ$ ,  $20^\circ$ , and  $30^\circ$  were constructed. In addition, three hydrofoils with the same dihedral angles but with the section modified to give a sharp leading edge were constructed. Sections of these hydrofoils, normal to the chord plane, are shown in figure 1. The NACA 16-509 section hydrofoil with zero dihedral, which was used in the previous tests, was retested to form a check between the two programs. All these hydrofoils had the same projected area, that is, 30-inch span and 5-inch chord. They were rectangular in plan form with square tips and were machined from hard brass and highly polished.

Each hydrofoil was supported by two struts. Each strut was spaced  $8\frac{1}{16}$  inches from the center section of the hydrofoil. The struts are biconvex in section, approximately 28 inches long, and tapered toward the hydrofoil. At the point of attachment to the upper surface of the hydrofoil, the struts have a chord of 2.9 inches and a thickness of  $\frac{3}{8}$  inch; at the top, the chord of the strut is 4 inches and the thickness is  $\frac{3}{4}$  inch. The center line of the strut intersects the upper surface at the half-chord point. With the struts vertical, the angle of attack of the hydrofoil is  $6^\circ$ . This arrangement (hydrofoil supported from its upper surface by rather large struts) is not ideal from considerations of possible interference effects. This arrangement, however, appears to be necessary in applications employing hydrofoils to lift a surface boat or a seaplane.

#### TOWING APPARATUS

A description of the NACA tank, towing carriage, and the method of measuring carriage speed is given in reference 2.

The special dynamometer used in measuring the lift and drag forces is shown diagrammatically in figure 2. It is of massive construction, because of the large forces to be measured, and is supported by the main structural members of the carriage. This dynamometer set-up is, in general, the same as that used for the earlier tests described in reference 1. Changes were made, however, that improved the accuracy of setting the depth and angle of

attack, eliminating any change in depth as the angle of attack was shifted. Improved spring and dashpot units were constructed also.

The assembly of hydrofoil and supporting struts is bolted to a rigid floating frame in which there is provision for continuously varying the angle of attack and the depth of the hydrofoil within a wide range. This floating frame is suspended by linkages from two heavy cantilever springs, the deflections of which are measured by dial gages. Drag forces are balanced by a combination of dead weights and spring restraint, the spring being that of the regular towing dynamometer as described in reference 2. Counterbalances are provided to minimize the effect of vertical and horizontal accelerations. Guide rollers restrain the floating frame against side motion.

#### PROCEDURE

The force measurements were made at constant speed, angle of attack, and depth of submersion. The range of speeds in most cases extended well beyond the speed at which cavitation started. At low angles of attack, the range of speeds extended to the maximum considered practicable with the apparatus. The depths ranged from 5 chords below the surface (measured from the quarter-chord point of the center section) to partial submersions with half or more of the hydrofoil area out of the water. As the angle of attack was changed, the depth of the quarter-chord point at the center section was held constant. There is then a slight error in referring to the depths of tips as constant. This error is less than the systematic errors involved in measuring the depth. The angle of attack was varied from  $-4^{\circ}$  to  $12^{\circ}$  for most of the tests but was varied over a smaller range for tests at partial submersions. The speed at which cavitation first appeared on the upper surface at each angle of attack was noted.

The supporting struts were towed alone at different depths and the resulting measurements of drag were subtracted from the measurements of drag obtained with complete assemblies of struts and hydrofoils. The lift tares of the struts alone, measured in the same manner, proved to be negligible for all conditions included in the text. The drag tares of the struts (fig. 3) were deducted to facilitate use of the data in designing

assemblies employing struts of lower drag than the biconvex struts. The procedure used in determining tares makes no allowance for interference effects. In most practical applications, however, the same type and the same order of magnitude of interference will most likely be present.

### ACCURACY

The accuracy of the basic measurements is believed to be within the following limits:

Speed, feet per second . . . . .	±0.2
Cavitation speed, percent . . . . .	±2
Depth of immersion (below free water surface), inches . . . . .	±0.2
Angle of attack, degrees . . . . .	±0.1
Drag, pounds . . . . .	±1.0 below cavitation speed ±5.0 with heavy cavitation
Lift, pounds . . . . .	±10.0 below cavitation speed ±20.0 with heavy cavitation

As the amount of cavitation increased, the accompanying vibration caused the force measurements to be less accurate.

### EXPERIMENTAL RESULTS

The experimental results of tests of hydrofoils with the NACA 16-509 section are presented as curves of lift and drag coefficients plotted against speed in figures 4 to 15. Similar results obtained for the hydrofoils with the modified section are not given in their entirety but are discussed later in this report. Each figure shows the variations of the coefficients with change in speed for constant values of the angle of attack and a constant depth below the undisturbed water surface. The lowest speed at which cavitation was observed on the upper surface of the hydrofoil, for a given angle of attack, is indicated on the corresponding curve by a small arrow. With the test set-up used, it was impracticable to determine the speed at which cavitation occurred on the lower surface.

Curves have not been faired through every set of points at constant angle of attack with the hydrofoil partly submerged, because the grouping of points representing the

various angles of attack is rather close for some cases of partial submersions and the accuracy of the measurements was not great enough to warrant expanding the ordinate scales.

The observed forces are reduced to coefficients analogous to the usual aerodynamic form:

$$C_L \quad \text{lift coefficient} \quad \left( \frac{L}{\frac{1}{2} \rho S V^2} \right)$$

$$C_D \quad \text{drag coefficient} \quad \left( \frac{D}{\frac{1}{2} \rho S V^2} \right)$$

where

L lift, pounds

D drag, pounds

$\rho$  mass density of water, 1.968 slugs per cubic foot  
for these tests

V speed, feet per second

S projected area of hydrofoil, 1.042 square feet for these tests

The Reynolds number ( $R = \rho V l / \mu$ ) for any of the data may be computed by using the values

$\mu$  average absolute viscosity of tank water,  $2.25 \times 10^{-5}$  slugs per foot per second for these tests

l characteristic length, or chord, of hydrofoil, 0.417 foot

$$R = 36,500 V$$

The following additional symbols are used:

$\alpha$  geometric angle of attack of hydrofoil measured between chord line at center section and free water surface

c chord of hydrofoil

$V_c$  speed at which cavitation was first observed on the upper surface, feet per second



## DISCUSSION

## Effect of Depth

The effect of depth on lift coefficient for the NACA 16-509 section is shown in figure 16 for angles of attack of  $0^\circ$ ,  $2^\circ$ ,  $4^\circ$ , and  $6^\circ$  and dihedral angles of  $0^\circ$ ,  $10^\circ$ ,  $20^\circ$ , and  $30^\circ$ . This figure presents curves faired through points taken from the faired curves of figures 4 to 15. Points are also shown representing the faired data for the section having a sharp leading edge.

The flow of water over a hydrofoil at depths greater than 4 or 5 chords is apparently not influenced by the surface of the water, and conditions similar to those for an airfoil prevail.

At lesser depths (for example,  $1/2$  to 4 or 5 chords), the influence of the surface of the water is evident from the decrease in lift and the increase in cavitation speeds. As the hydrofoil, while moving with a constant forward velocity, approaches the surface, there is a reduction in the mass of water flowing above the hydrofoil. This change causes a reduction in the absolute value of the negative pressures on the upper surface of the hydrofoil and results in a reduction in lift. The reduction in the absolute value of the negative pressure requires that, for cavitation to appear, the speed must be greater for the lesser depth. (See fig. 17.) The method of computing cavitation speeds given in reference 1 makes no allowance for this effect of decreasing depth.

At very shallow depths (about  $1/2$  chord), a more or less sudden breakdown of the flow over the upper surface occurs. For the NACA 16-509, or the modified sharp-nose, section at an angle of attack above  $4^\circ$ , the breakdown of flow occurs near the leading edge, the water separating almost completely from the upper surface, leaving nearly the whole chord ventilated. At low angles of attack, the breakdown of flow is less sudden and occurs at a lesser depth. The breakdown of flow may occur incompletely and unsymmetrically spanwise, its spanwise extent apparently depending on the angle of dihedral and on the roughness of the surface of the water. Either smooth flow or separated flow over the upper surface may occur at a given operating condition, and alternation between the two types of flow may occur. (See figs. 6, 9, 13, and 14.) When

separation of the flow from the upper surface is definitely established, the changes of lift and drag with change in angle of attack are very small in comparison with the changes that occur when the flow is smooth over the upper surface. (See fig. 18.) When the hydrofoil approaches the free surface, the use of low angles of attack appears desirable in order to reduce the severity of the transition to planing.

Total projected areas were used in computing the coefficients to facilitate use of the data in design. The abrupt change in the slope of the curves (fig. 16) as the tips emerge therefore represents an abrupt change in total lift and not necessarily an abrupt change in section characteristics. Figure 16(c) shows one plot of coefficients based on projected area of the submerged portion of the hydrofoil.

#### Comparison of Tank and Wind-Tunnel Tests

Figure 19 shows a comparison of test results on the NACA 16-509 section from tests in the NACA tank and the 24-inch high-speed tunnel. The results of tests in the wind tunnel as given in reference 3 were converted to an aspect ratio of six for this comparison. The drag coefficients measured in the tank and given in reference 1 included strut drags; consequently, the strut drags were deducted from the published values for the purpose of making this comparison. The data from the present tests were for the zero-dihedral hydrofoil at 40 feet per second.

The agreement between the two series of tank tests is good. Agreement between tank and wind-tunnel tests is reasonably good except for lift at high angles of attack. One reason for the discrepancy in the lift curves is undoubtedly the presence of the relatively large struts used in the tank tests. The agreement is, on the whole, good enough to support the belief that for preliminary design involving hydrofoils operating at depths greater than 4 or 5 chords, and at low speeds, wind-tunnel data may be used.

#### Effect of Dihedral

The effect of dihedral is shown in figure 16. The highest dihedral angle used,  $30^\circ$ , gave the highest lift forces at partial submersions for a given emersion of the

tips. This result is undoubtedly due to the greater immersed area and the greater average depth of that area for a hydrofoil with high dihedral operating at the same tip emersion as a hydrofoil with low dihedral. The change in lift from complete immersion to zero immersion is more gradual for the hydrofoil with high dihedral than for a hydrofoil with low dihedral. If the idea is to secure a relatively gradual drop in lift as a hydrofoil emerges from the water, as in a flying-boat application, as high a dihedral as is consistent with other requirements appears desirable.

In figure 16 the points plotted at zero lift coefficient for each angle of dihedral were not obtained experimentally but were obtained by assuming that the lift would be zero when the quarter-chord point of the center section is at the free surface of the water. It is probable that some planing lift is obtained from the lower surface at this location of the hydrofoil but it would be negligible. A summary of the effects of dihedral is shown in figure 20.

#### Effect of Shape of Nose

The effect upon lift and drag of sharpening the leading edge, as shown in figure 21, varies with speed and angle of attack in such a way that neither section appears, in general, to be definitely superior to the other. Considerably more data were obtained than are included in this report. Those in figure 21 appear to be typical of all the data obtained and a more thorough analysis of the effect appears unjustified except for applications somewhat more specific than may be assumed at present.

The effect of sharpening the leading edge upon the volume and trajectory of the spray for partial submersions was not determined quantitatively. During repeated observations of the spray thrown by the two sections, no significant differences appeared.

#### Effect of Speed

The effect of speed on the characteristics of a 16-509 hydrofoil is shown in figures 4 through 15. Two principal effects of speed may be noticed: first, there is a limit to the maximum hydrofoil loading that can be developed at the higher angles of attack; and second, a complete loss of

lift at low angles of attack (below  $4^\circ$ ) may be experienced at high speeds with this section.

The limitation on the maximum lift is a result of complete upper-surface cavitation. (See fig. 9.) This result verifies the results indicated in figure 3(d) of reference 1. At the depths used in the tests, this maximum is approximately 2200 pounds per square foot; that is, approximately equal to the sum of the atmospheric pressure and the static-pressure head of water above the hydrofoil. (Lower surface lift may continue to increase with speed.)

Loss of lift at low angles may be due to cavitation on the lower surface of the hydrofoil. The speed at which cavitation first appeared on the lower surface could not be determined because the lower surface could not be seen. The presence of low-pressure areas on the under surface of the hydrofoil was indicated by faint streamers of cavitation bubbles, which could be seen leaving the lower surface at the trailing edge during tests at high speeds and low angles of attack. If a 16-509 section hydrofoil is used on a high-speed surface craft, it may be necessary to avoid the use of angles of attack less than about  $4^\circ$ . This effect of speed upon the lift at low angles of attack appears more striking when the total lift in pounds (for the model) rather than the lift coefficient is plotted, as in the dashed curve of figure 12. If the loss of lift at high speeds and low angles of attack is caused largely by cavitation on the lower surface, a section having less camber than the 16-509 section may prove to be much better for some applications.

The biconvex sections used for struts in the present tests, while requiring relatively simple machining for manufacture, evidently are not the best sections for use in supporting hydrofoils below a seaplane or surface boat. A better form such as the 16-009 section (symmetrical, 9 percent thick) designed to have a nearly flat pressure distribution at zero lift would be better. Also, the form of intersection of strut and hydrofoil used in the tests may be improved upon. Observations of the cavitation that appeared during the tests at high speeds and low angles of attack were of considerable interest in showing the excessive drag contributed by the struts and by interference. Cavitation first appeared in the region of interference between struts and hydrofoil, next on the struts, and lastly on the hydrofoil itself. In the development of an efficient assembly of hydrofoil and supporting struts, observations of

the cavitation at high speeds should prove very valuable in rapidly locating the regions in which modifications would be desirable.

## CONCLUSIONS

The conclusions listed below are based on tests of an assembly approximating an arrangement for use under a seaplane or a surface boat.

1. At depths greater than 4 or 5 chords, the influence of the surface of the water is small and a hydrofoil operating at low speeds will have characteristics similar to those of an airfoil of the same section. Preliminary design estimates, including estimates of cavitation speeds, may be made on this basis. In the range of depths between about 4 or 5 chords and approximately  $1/2$  chord, lift and drag forces decrease and cavitation speeds increase as the surface is approached. In the region of very shallow immersions (less than  $1/2$  chord), sudden changes in lift are likely to occur and the exact conditions under which the abrupt change will occur cannot be safely predicted.

2. For applications, such as a seaplane, in which the hydrofoil must emerge from the water, it appears that large angles of dihedral ( $30^\circ$ ) and low angles of attack will be desirable, as they afford smoother change from complete submersion to zero submersion.

3. If a sharp leading edge seems desirable for some reason, no great penalty in lift or drag is necessarily paid for a slight modification of a section such as the 16-509.

4. Two major effects of speed may be noted:

- (a) A limitation of total hydrofoil loading under conditions of complete upper-surface cavitation. This limit is approximately 2200 pounds per square foot for depths tested (25 in. and less).
- (b) Loss of lift on the 16-509 section at high speeds if low angles of attack (below  $4^\circ$ ) are used, probably due to lower-surface cavitation.

5. Additional tests would be desirable to investigate the characteristics of hydrofoils at higher speeds and with lower cambers and to investigate the effect of modifying the section of the struts and the form of the intersection between a hydrofoil and its supporting struts.

Langley Memorial Aeronautical Laboratory,  
National Advisory Committee for Aeronautics,  
Langley Field, Va.

#### REFERENCES

1. Ward, Kenneth E., and Land, Norman S.: Preliminary Tests in the NACA Tank to Investigate the Fundamental Characteristics of Hydrofoils. NACA ACR, Sept. 1940.
2. Truscott, Starr: The Enlarged N.A.C.A. Tank, and Some of its Work. NACA TM No. 918, 1939.
3. Stack, John: Tests of Airfoils Designed to Delay the Compressibility Burble. NACA Rep. No. 763, 1943.

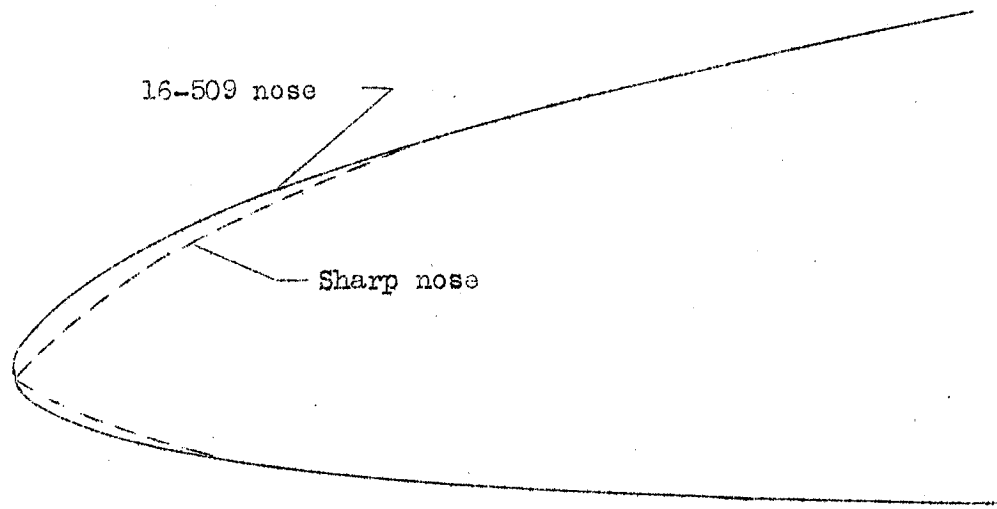

Enlarged nose sections

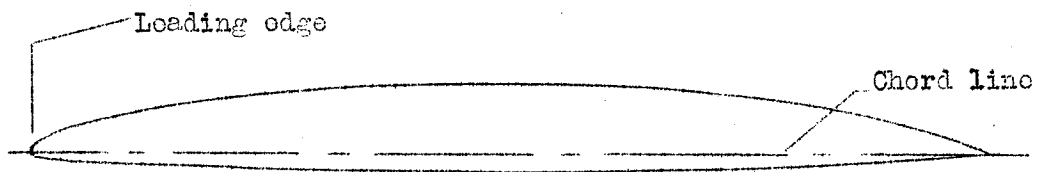

NACA 16-509

Figure 1.- Sections of hydrofoils tested.

- A Hydrofoil
- B Support struts
- C Floating frame
- D Lift springs
- E Dashpots
- F Dial gages
- G Inertia counterweights
- H Resistance dynamometer
- J Coarse drag lever, 10:1
- K Coarse drag weights

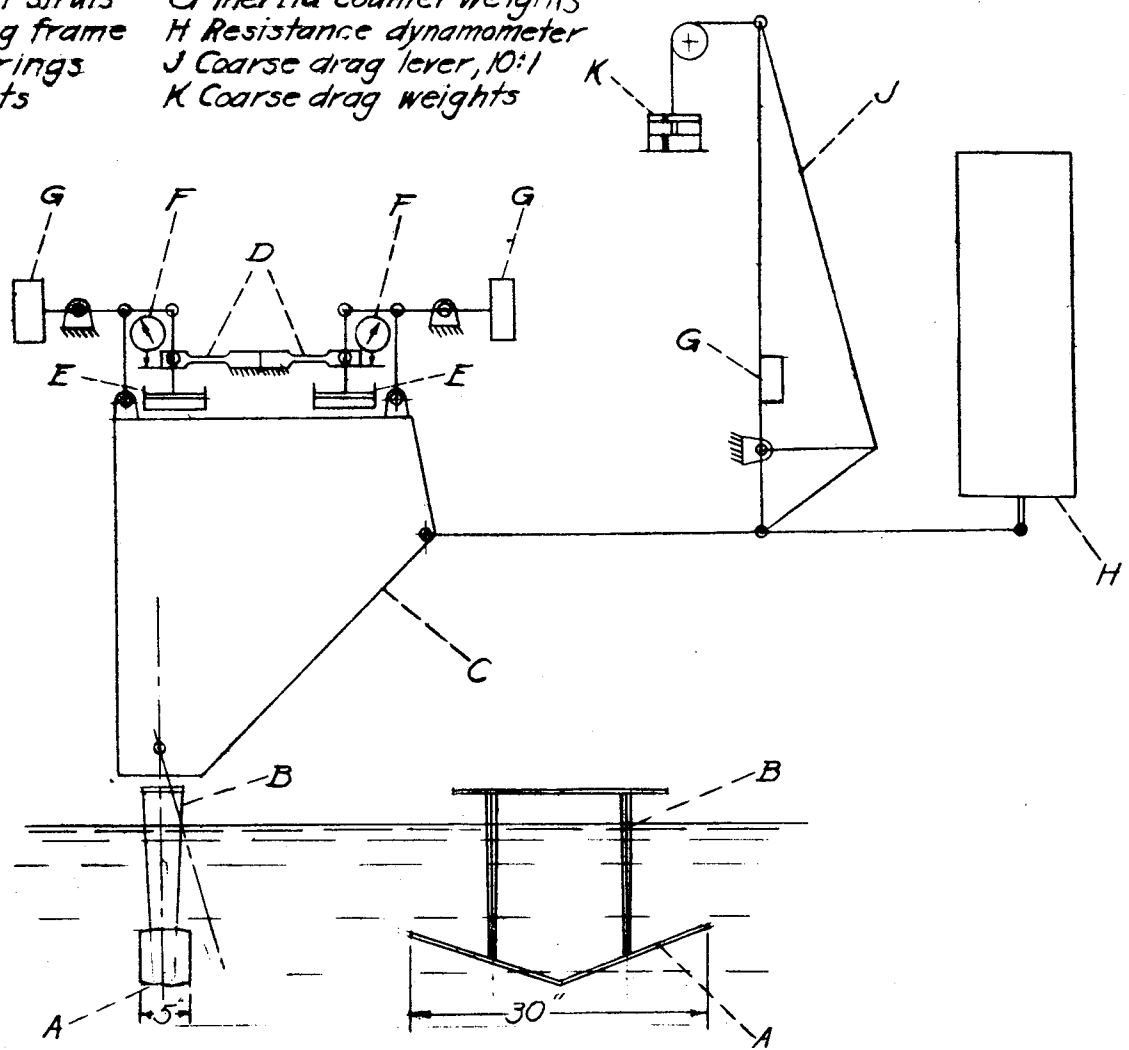

Fig. 2. — Diagrammatic sketch of hydrofoil dynamometer.



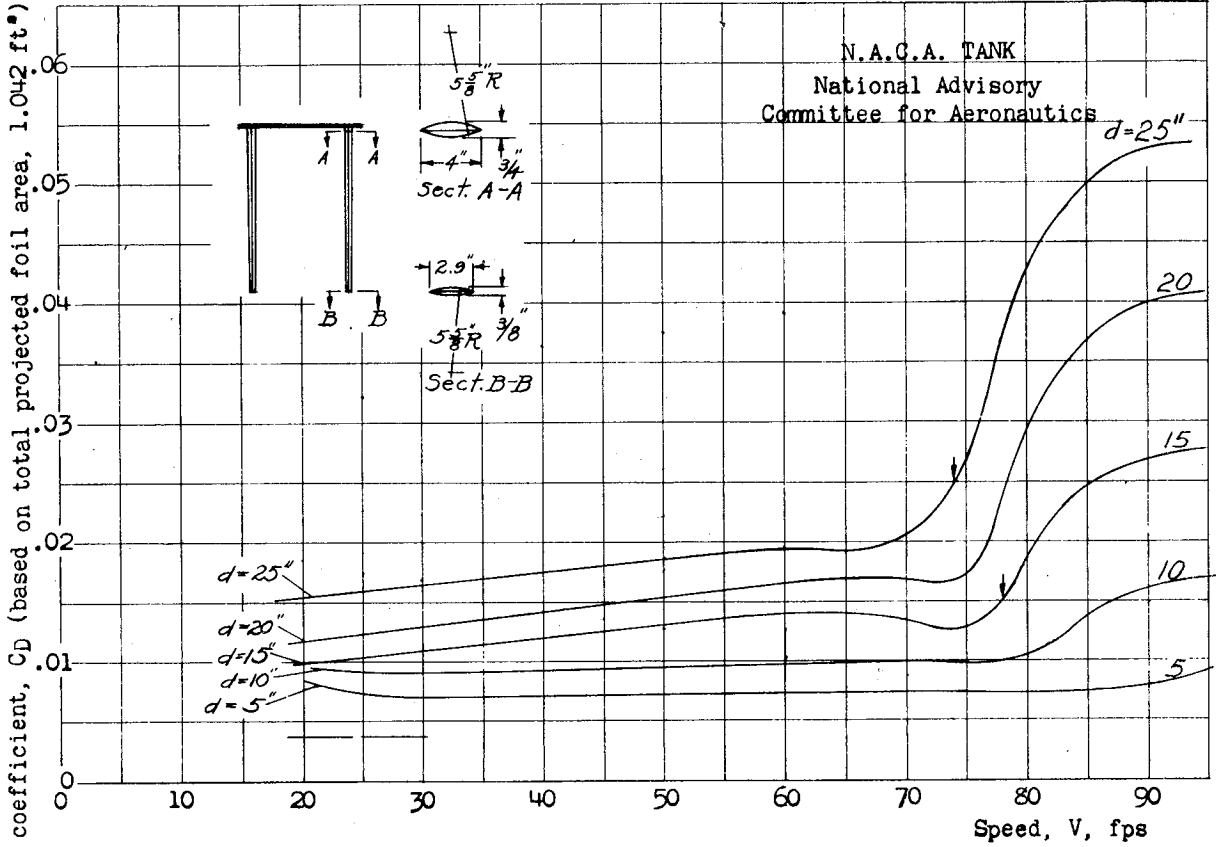

Fig. 3.- Tare drag coefficients for struts used in tests.

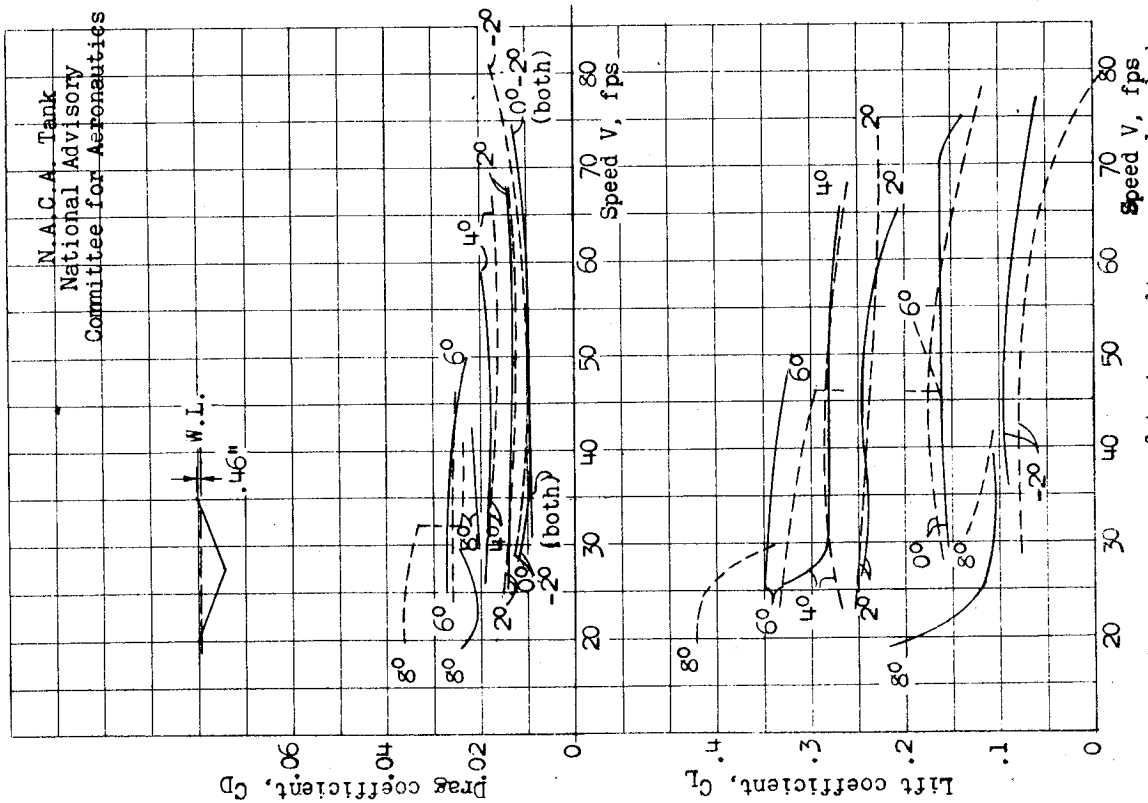

Fig. 2/b. Comparison of test results on normal and sharp leading edge hydrofoils. 200 dihedral. Depth  $c/4$  at tips .46 in. above water line.

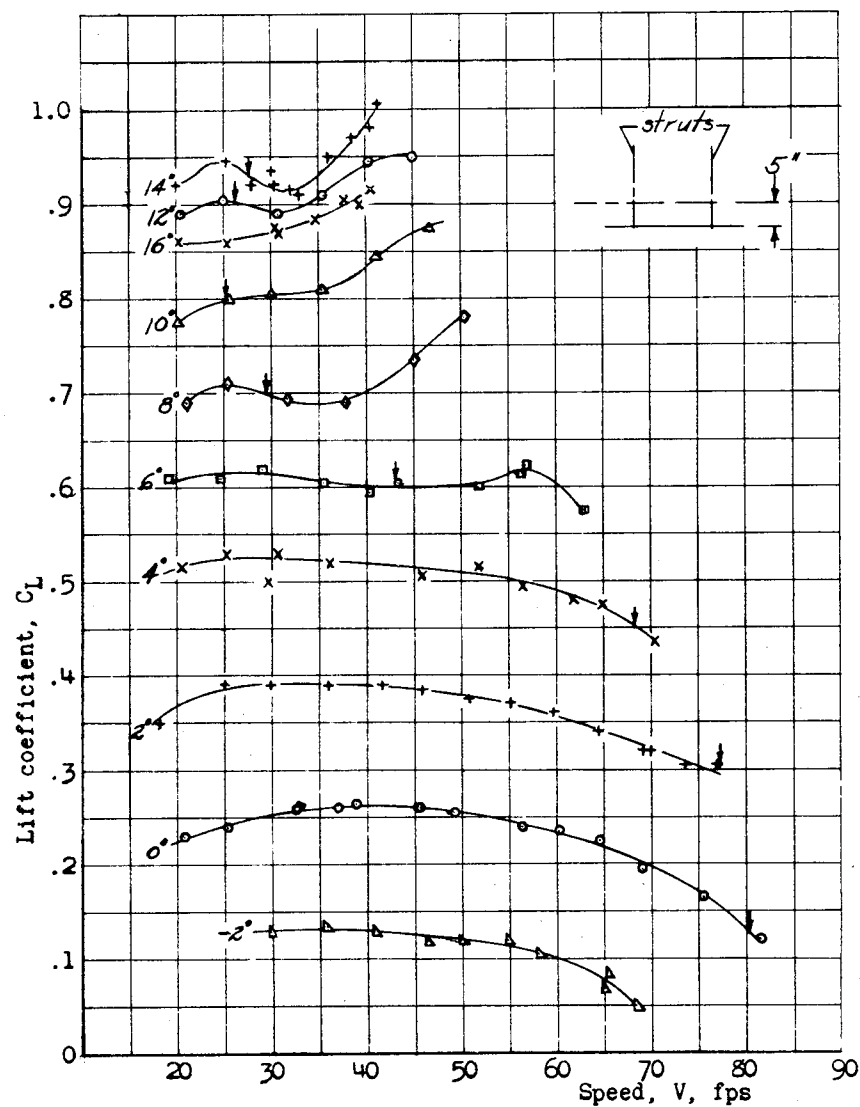
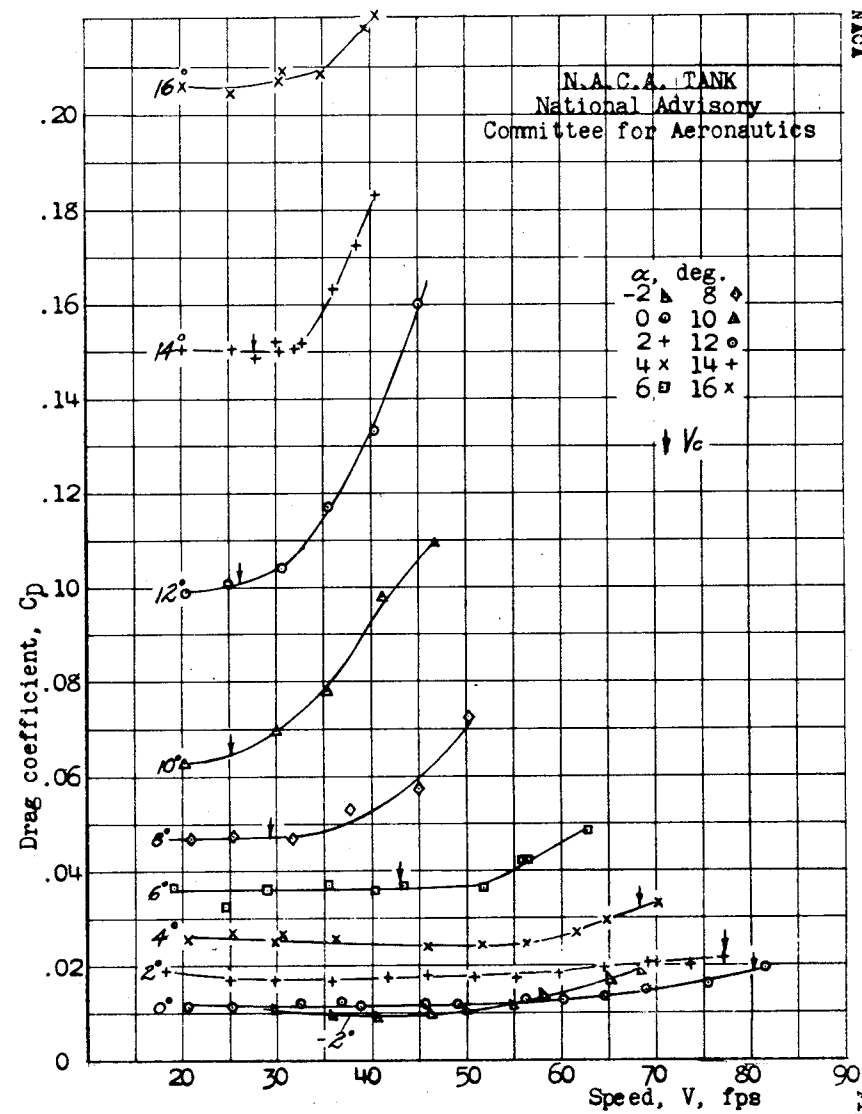

Fig. 4.- NACA 16-509 section hydrofoil.  $0^\circ$  dihedral. Depth, 5 inches to  $c/4$ .



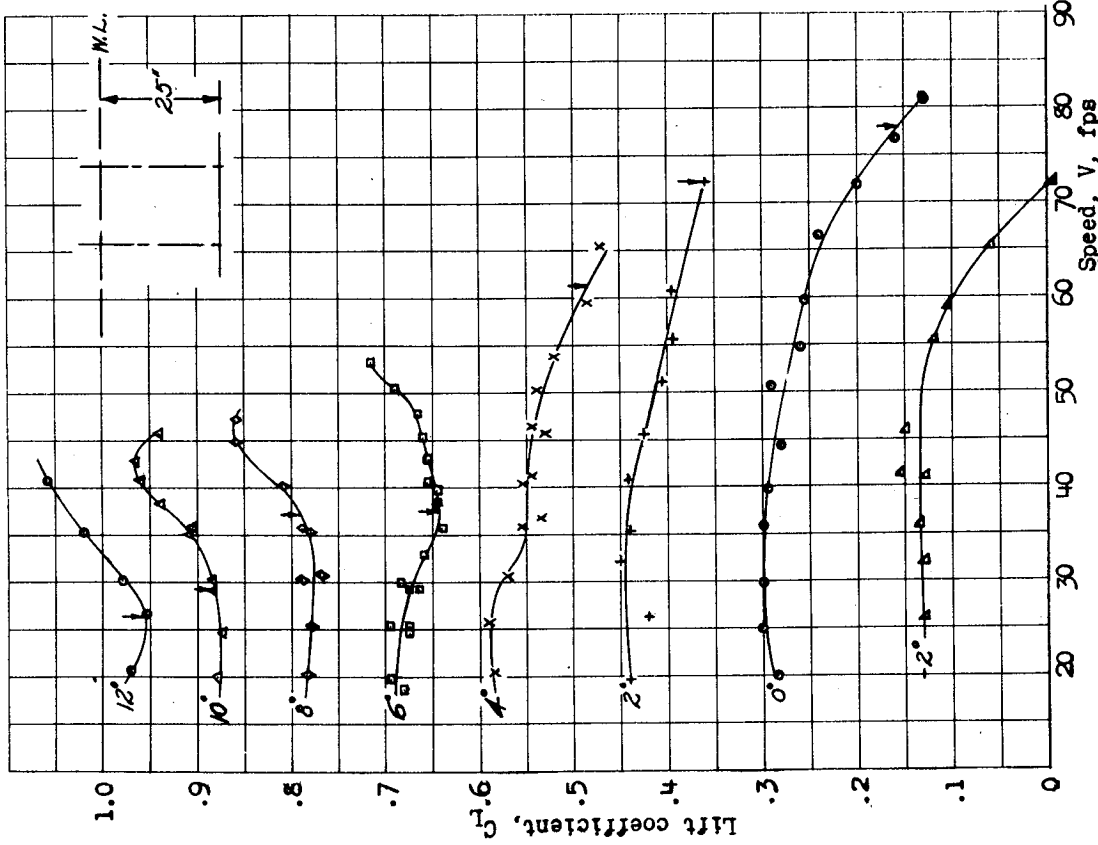
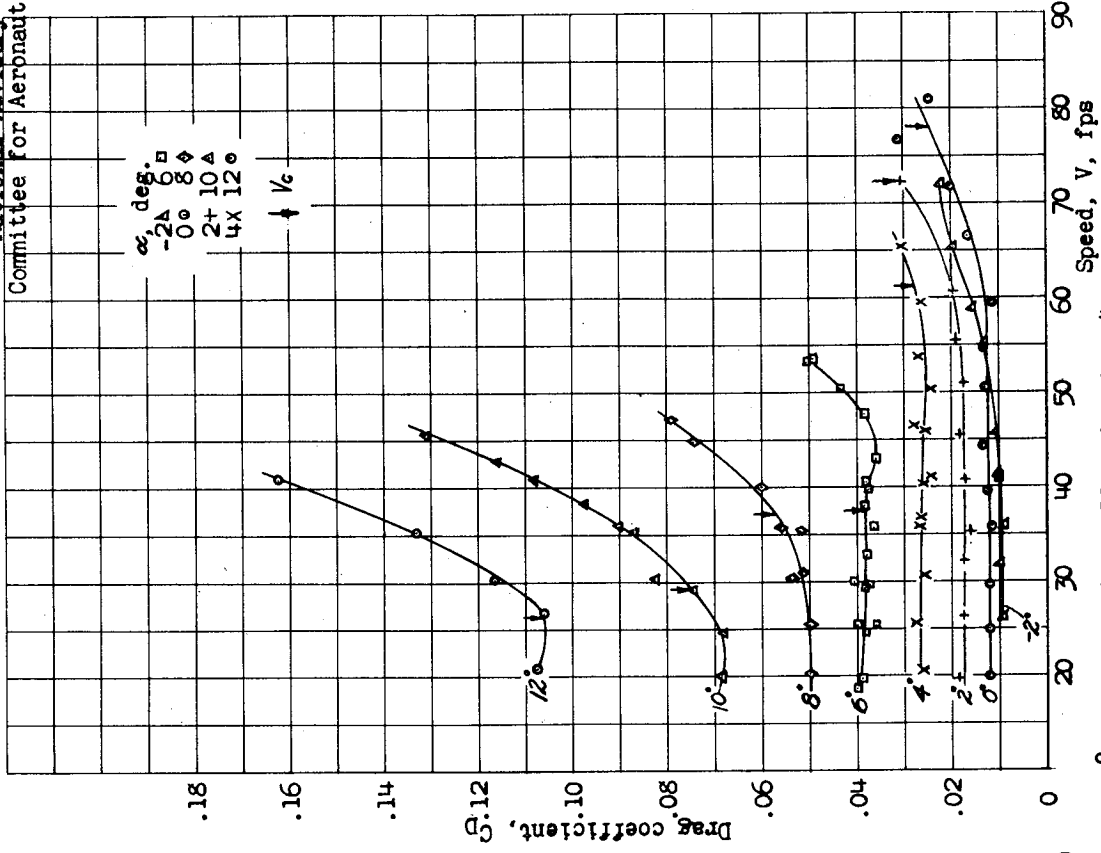
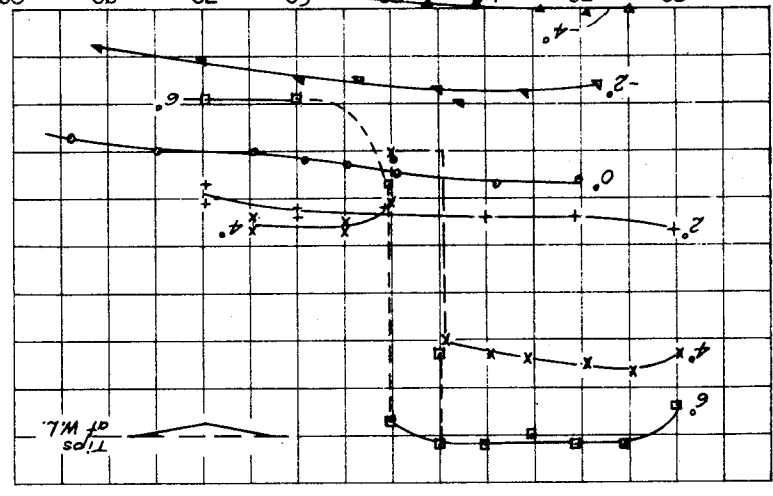
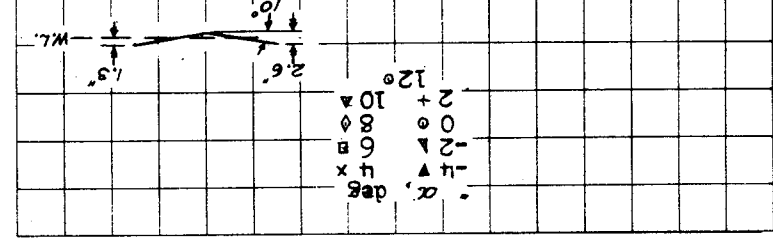
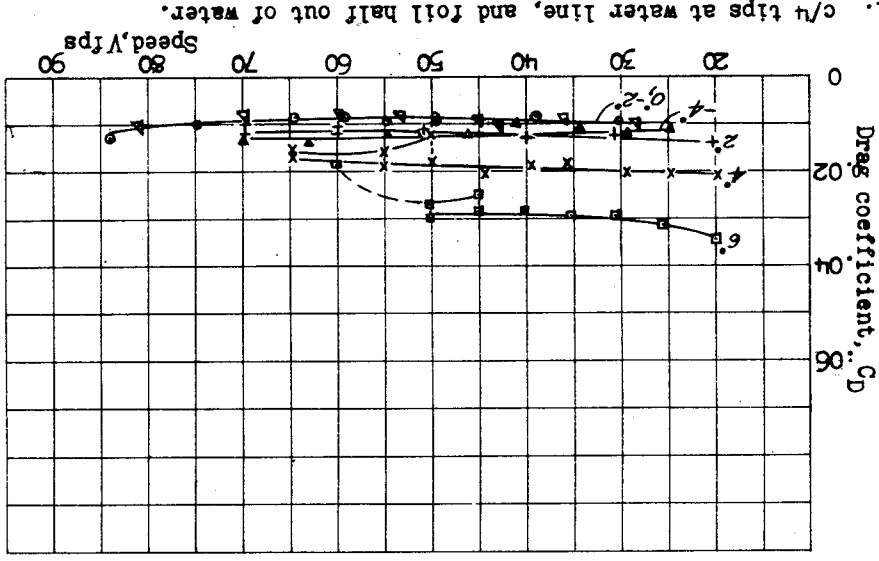
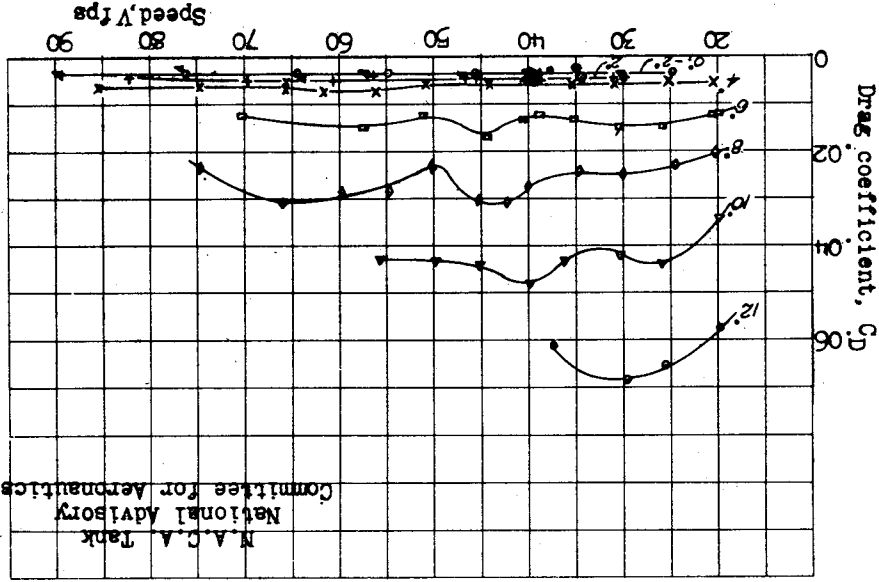

Fig. 5. - NACA 16-509 section hydrofoil. 0° dihedral. Depth, 2.5 inches to  $c/4$ .

N.A.C.A. Tank  
National Advisory  
Committee for Aeronautics



alpha, deg  
 -14 x  
 -12 x  
 -10 x  
 -8 x  
 -6 x  
 -4 x  
 0 o  
 2 +  
 4 +  
 6 +  
 8 +  
 10 +  
 12 +

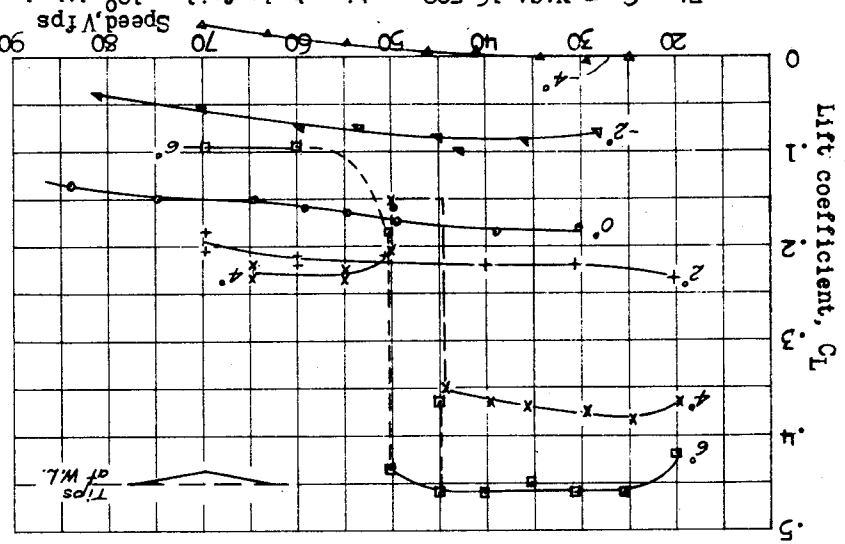
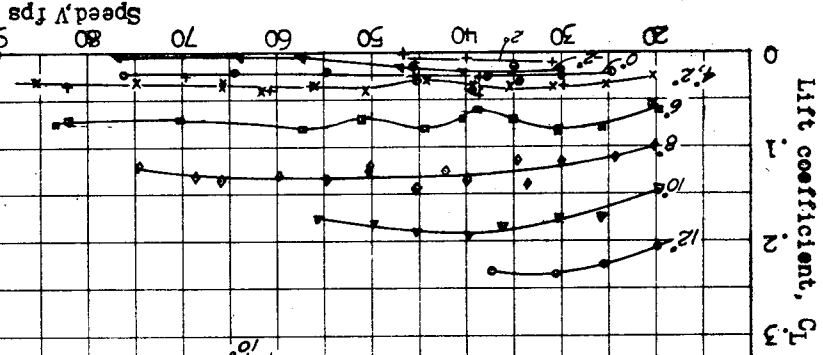

Fig. 6 - NACA 16-509 section hydrofoil, 10° dihedral, c/4 tips at water line, and foil half out of water.

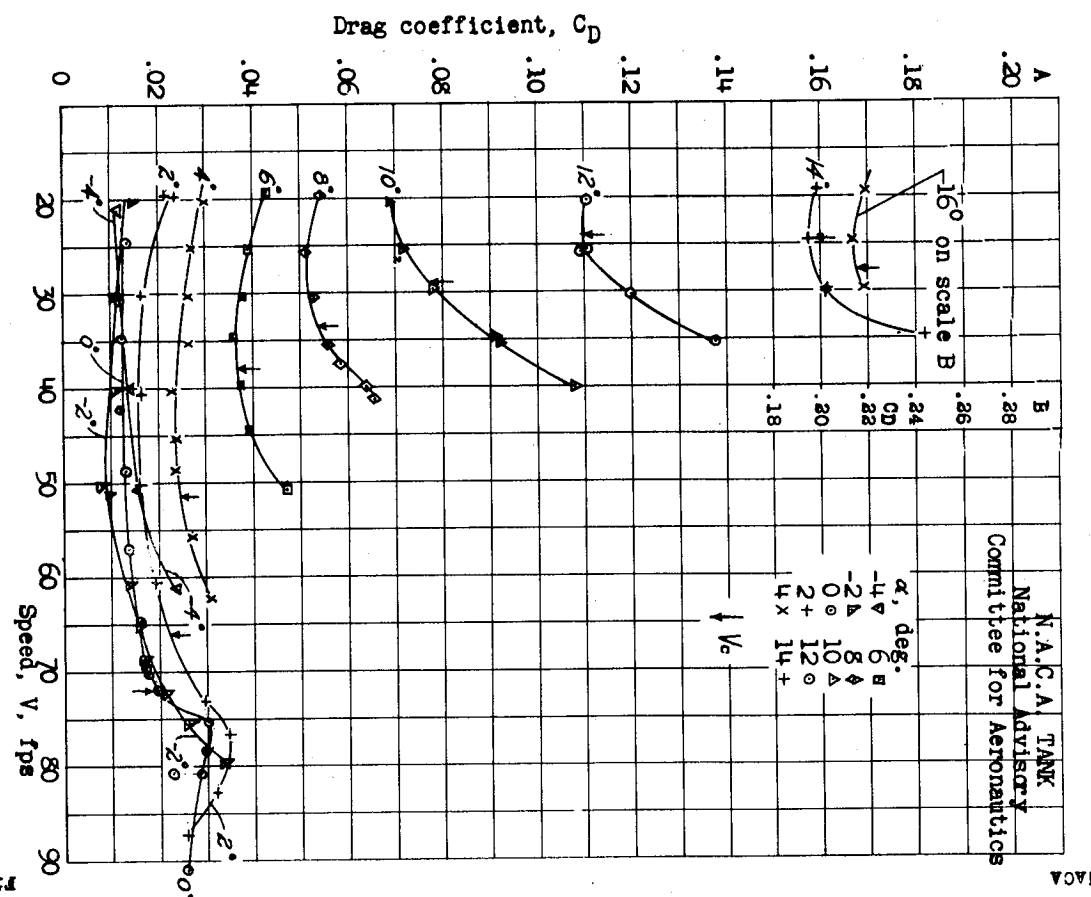
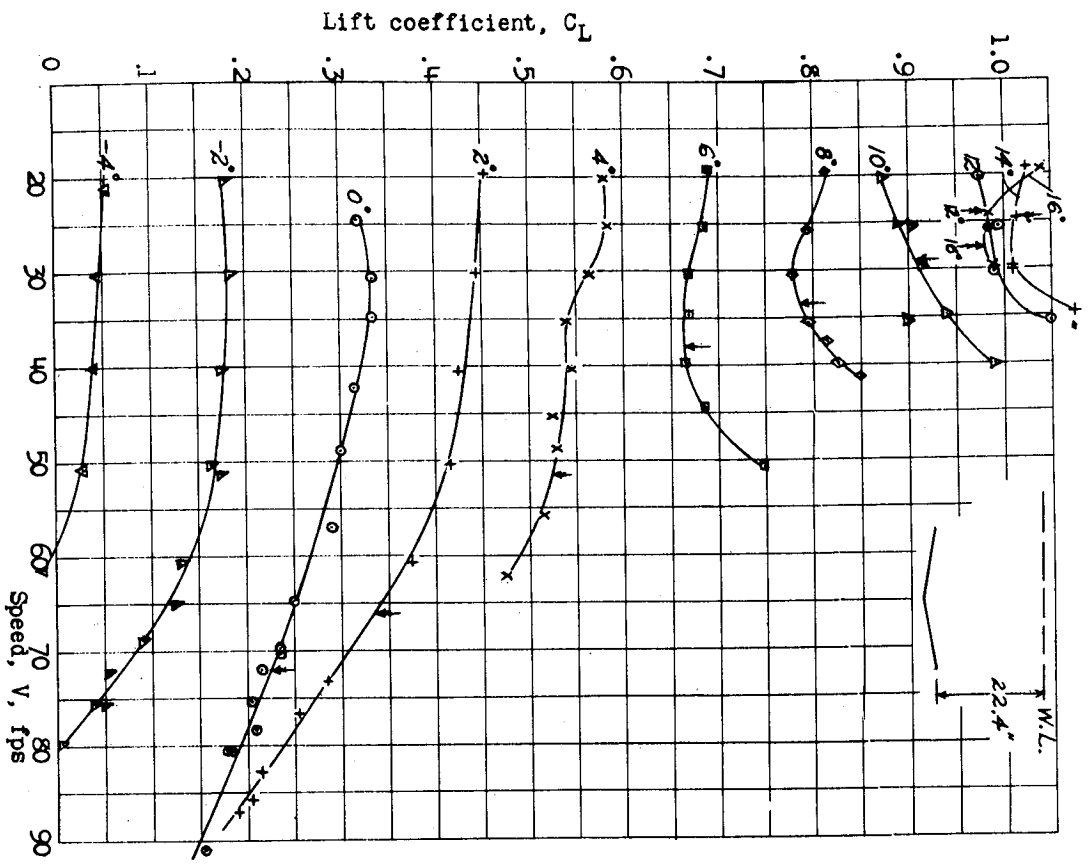

FIG. 7. - NACA 16-509 section hydrofoil.

10° dihedral. Depth 22.4 inches to  $c/4$  at tips.

N.A.C.A. Tank  
National Advisory  
Committee for Aeronautics

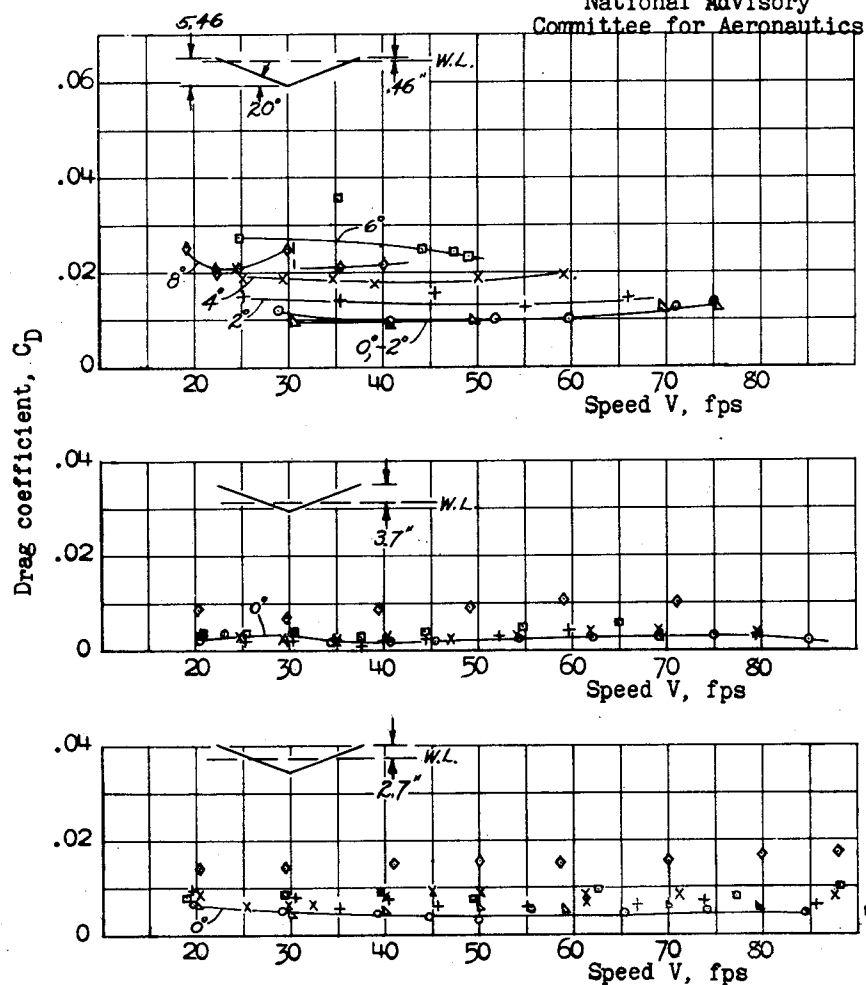
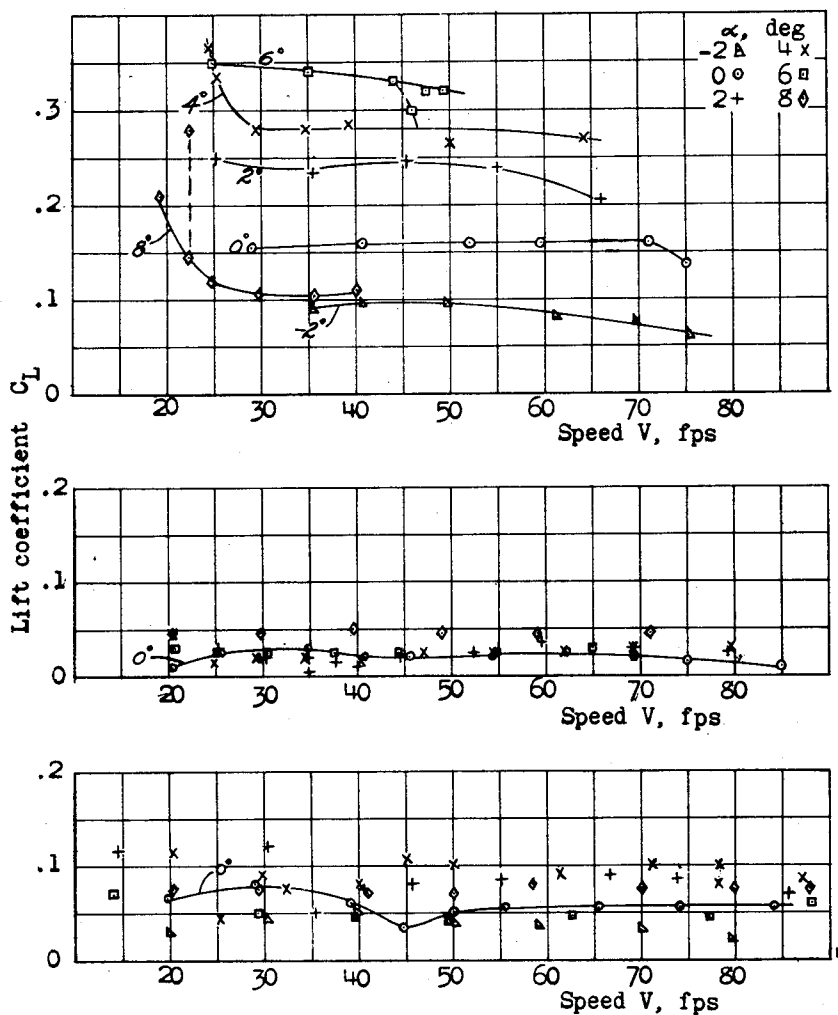

Fig. 8 .- NACA 16-509 section hydrofoil. 20° dihedral. Depths,  $c/4$  at tips above water line, .46, 2.7, and 3.7 inches.

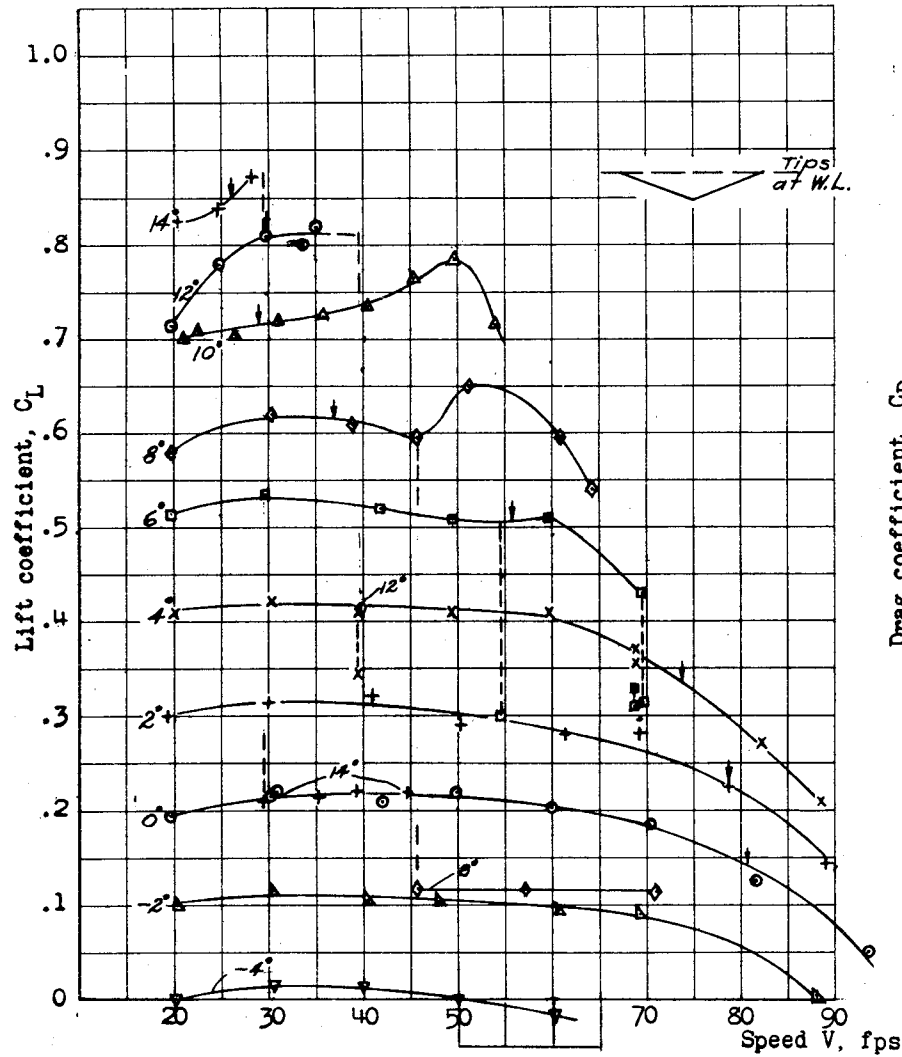
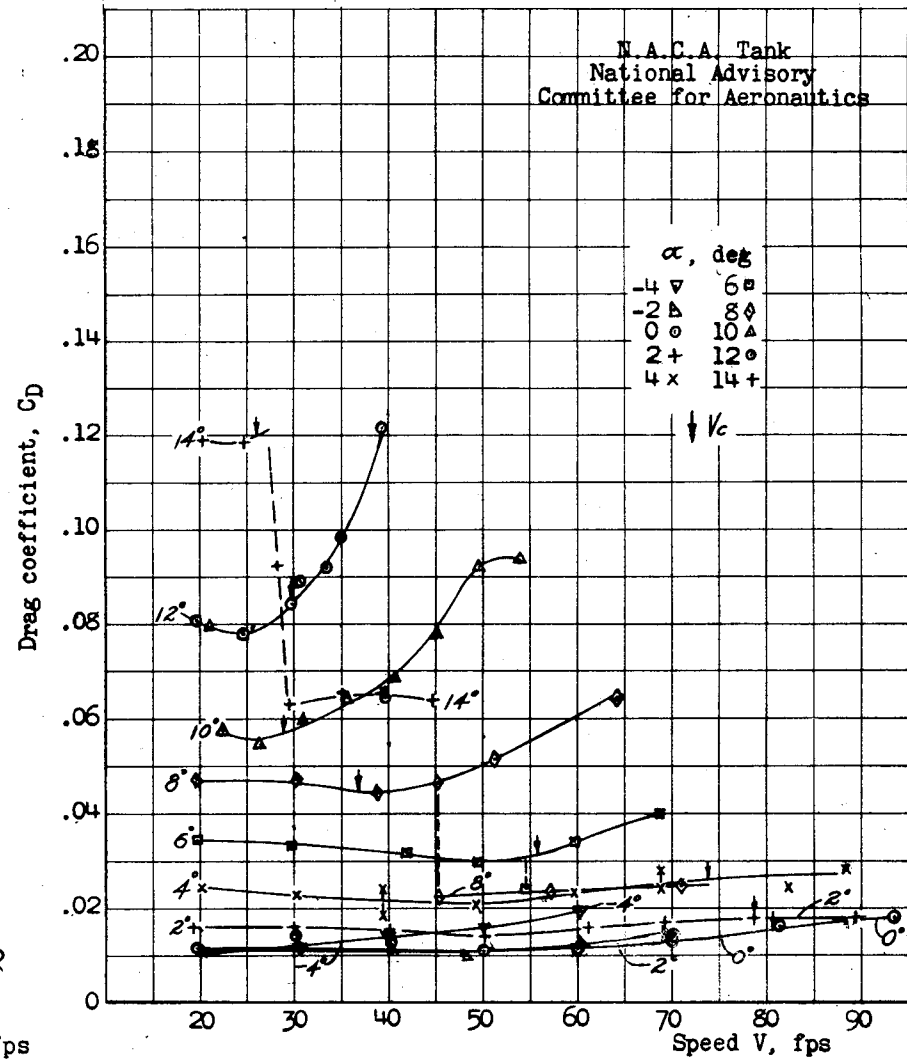

Fig. 9 .- 16-509 section hydrofoil. 20° dihedral. c/4 tips at water line.



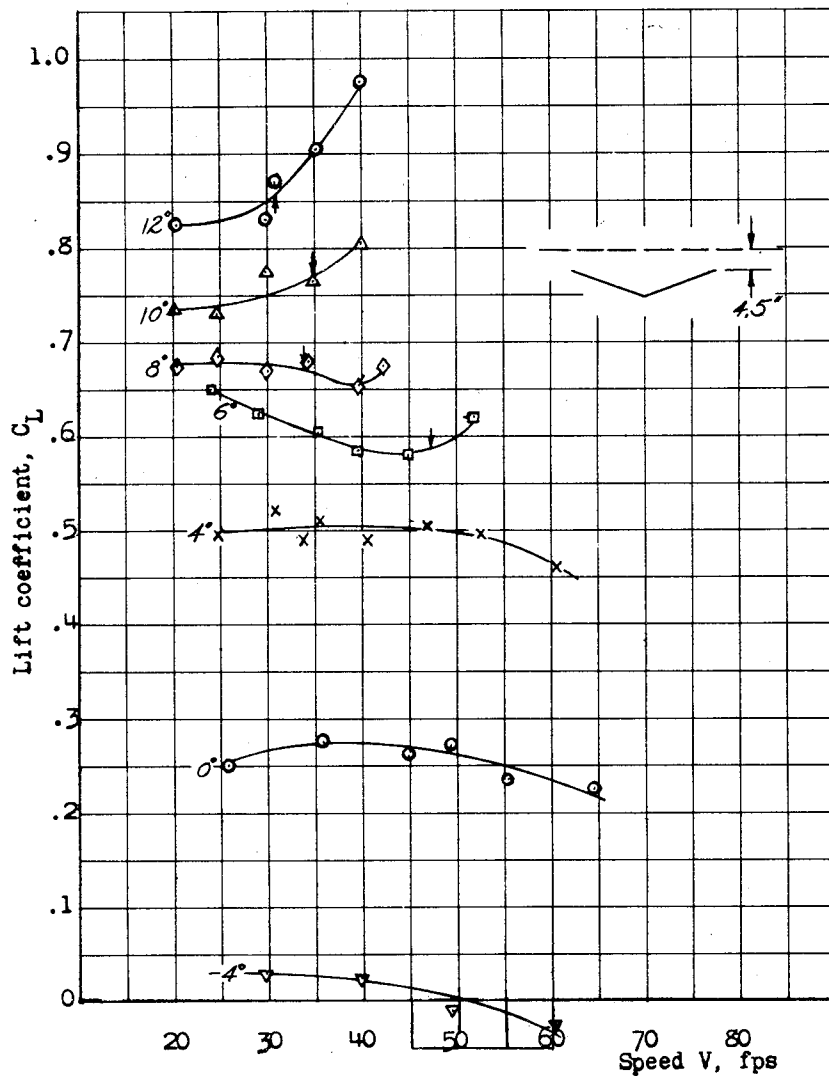

Fig. 10.- NACA 16-509 section hydrofoil.  $20^\circ$  dihedral. Depth 4.5 inches to  $c/4$  at tips.

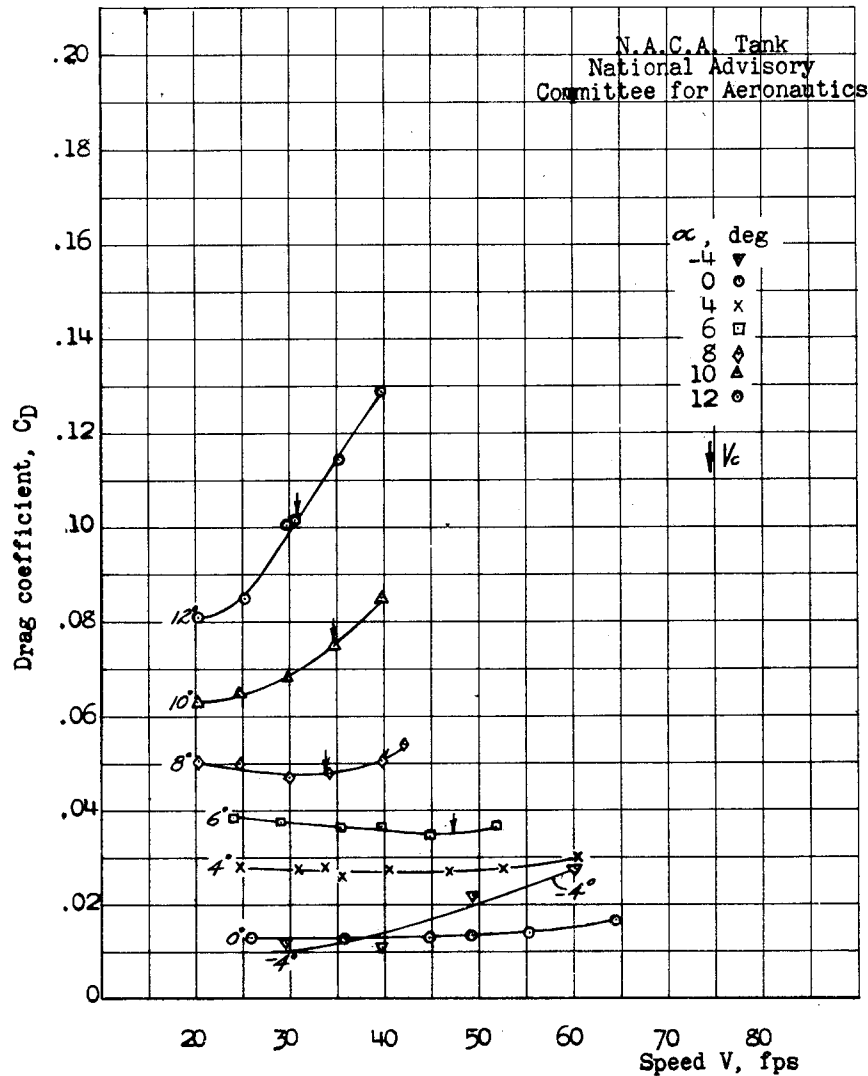
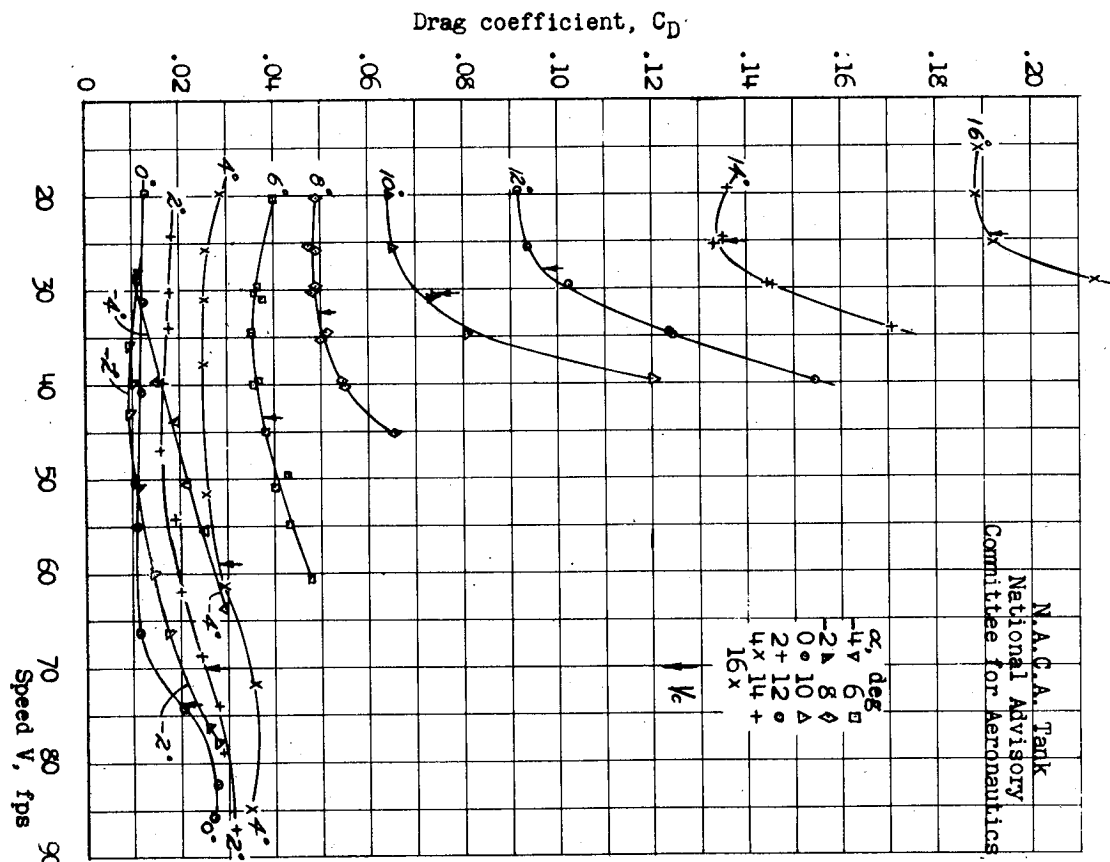
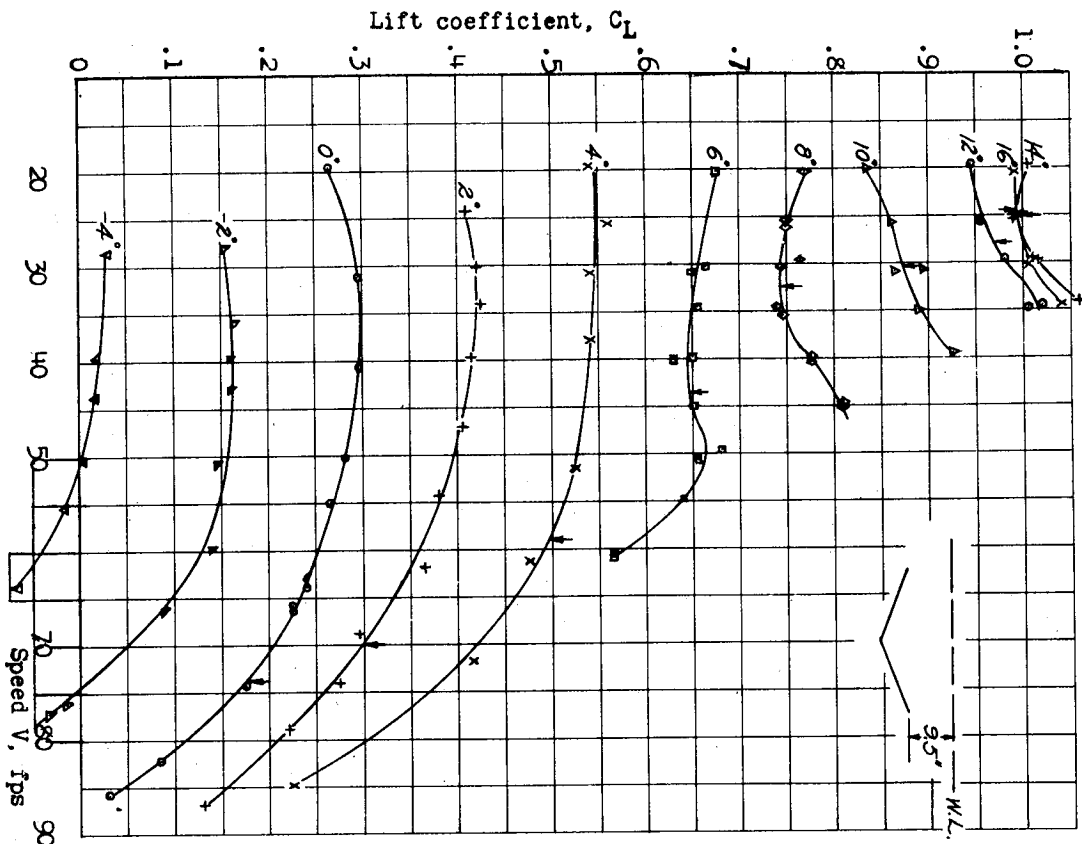

Fig. 10





N.A.C.A. Tank  
 National Advisory  
 Committee for Aeronautics

Fig. 11. - NACA 16-509 section hydrofoil. 20° dihedral. Depth 9.5 inches to  $c/4$  at tips.

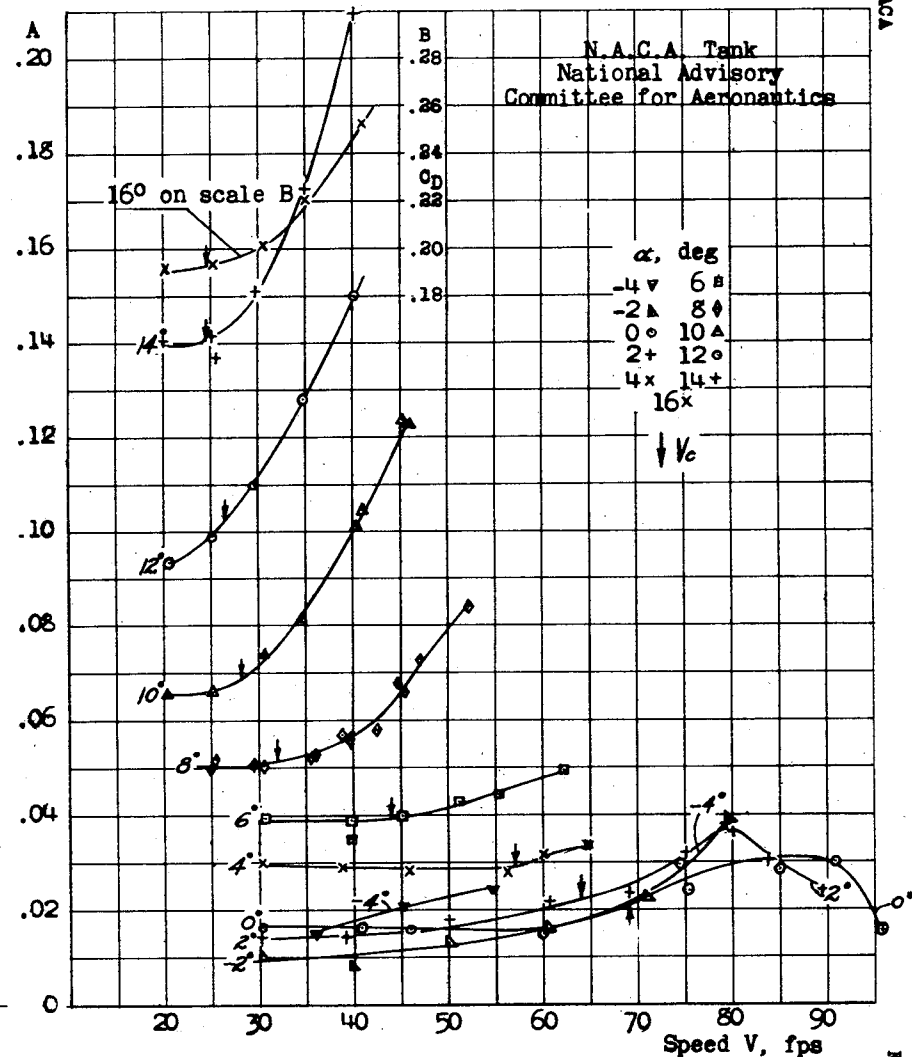
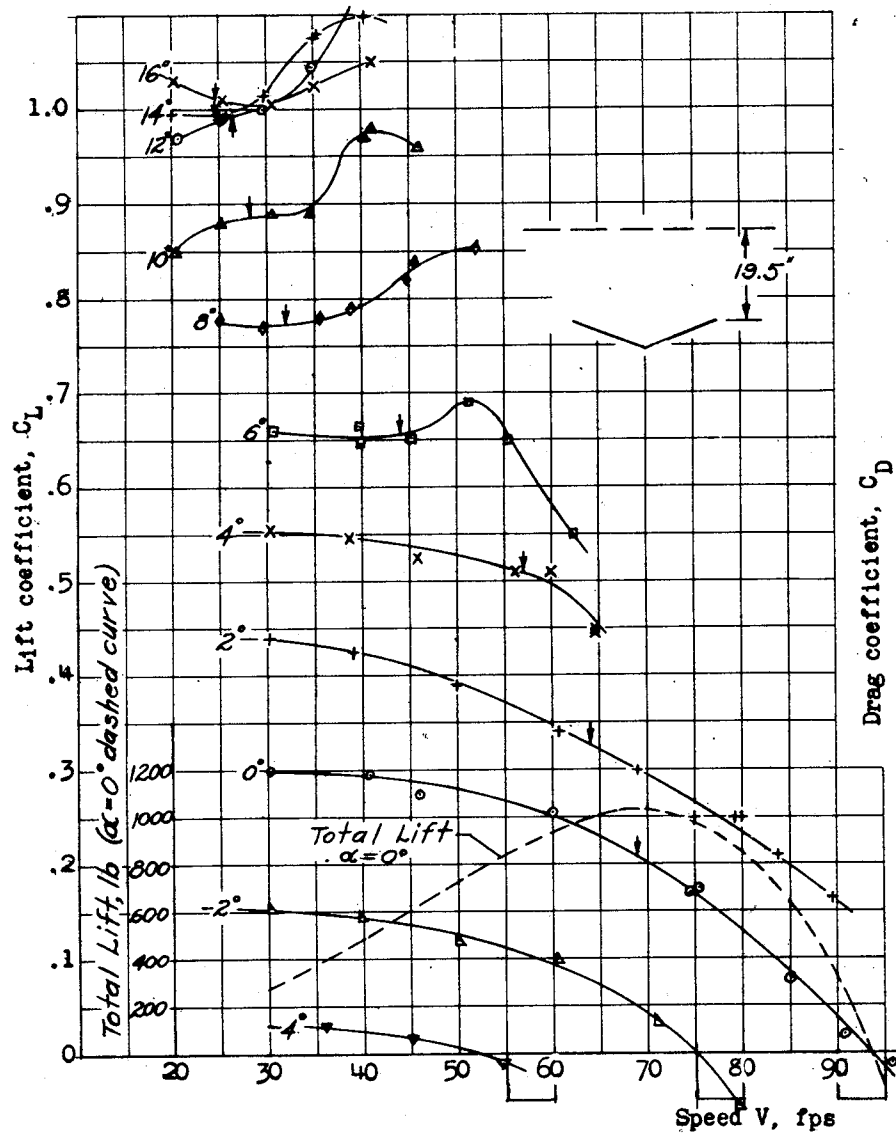

Fig. 12.- NACA 16-509 section hydrofoil.  $20^\circ$  dihedral. Depth 19.5 inches to  $c/4$  at tips.

NACA

FIG. 12

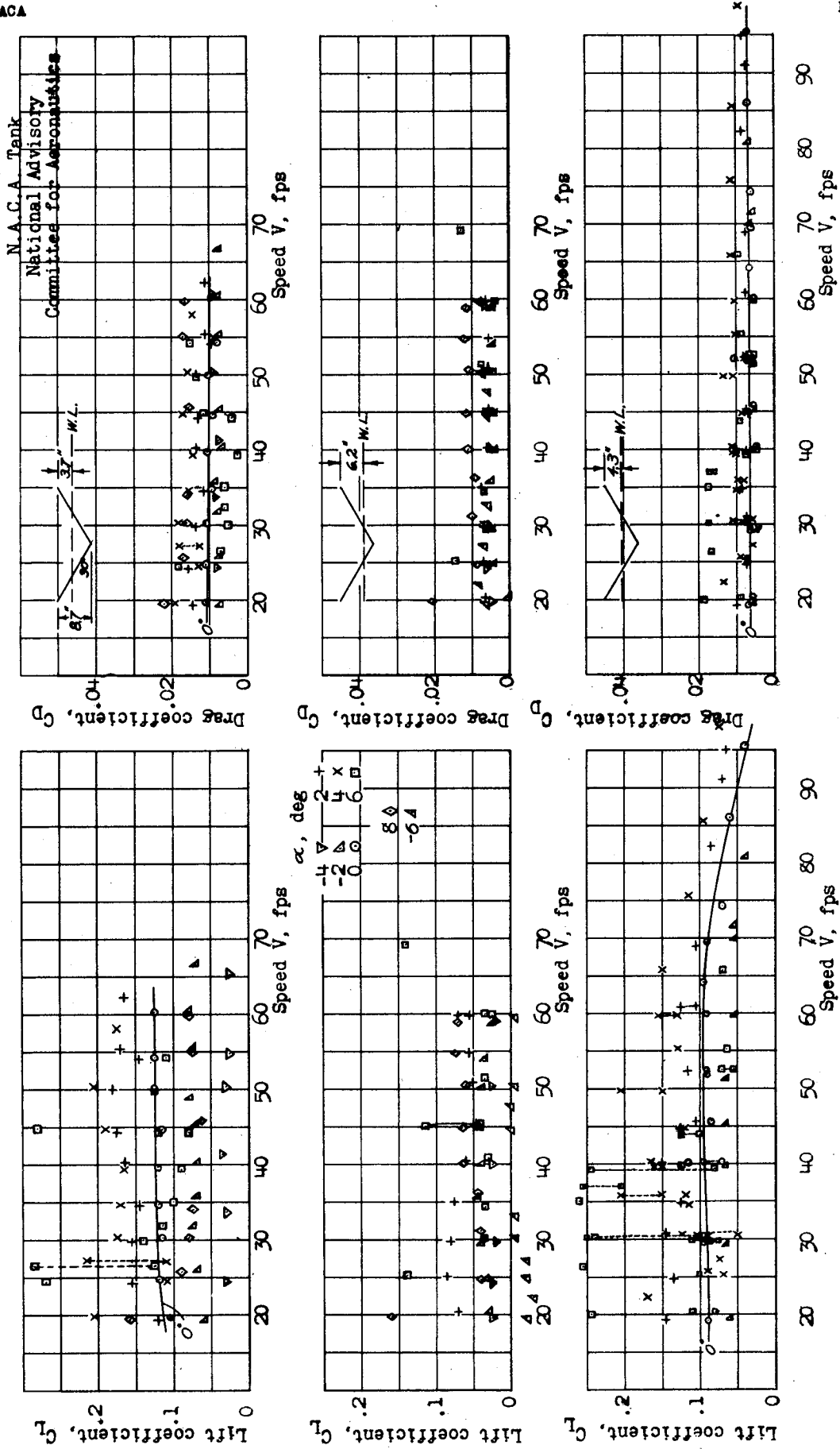

Fig. 13. - NACA 16-509 section hydrofoil. 30° dihedral. Depths, c/4 at tips above water line, 3.7, 4.3, and 6.2 inches.

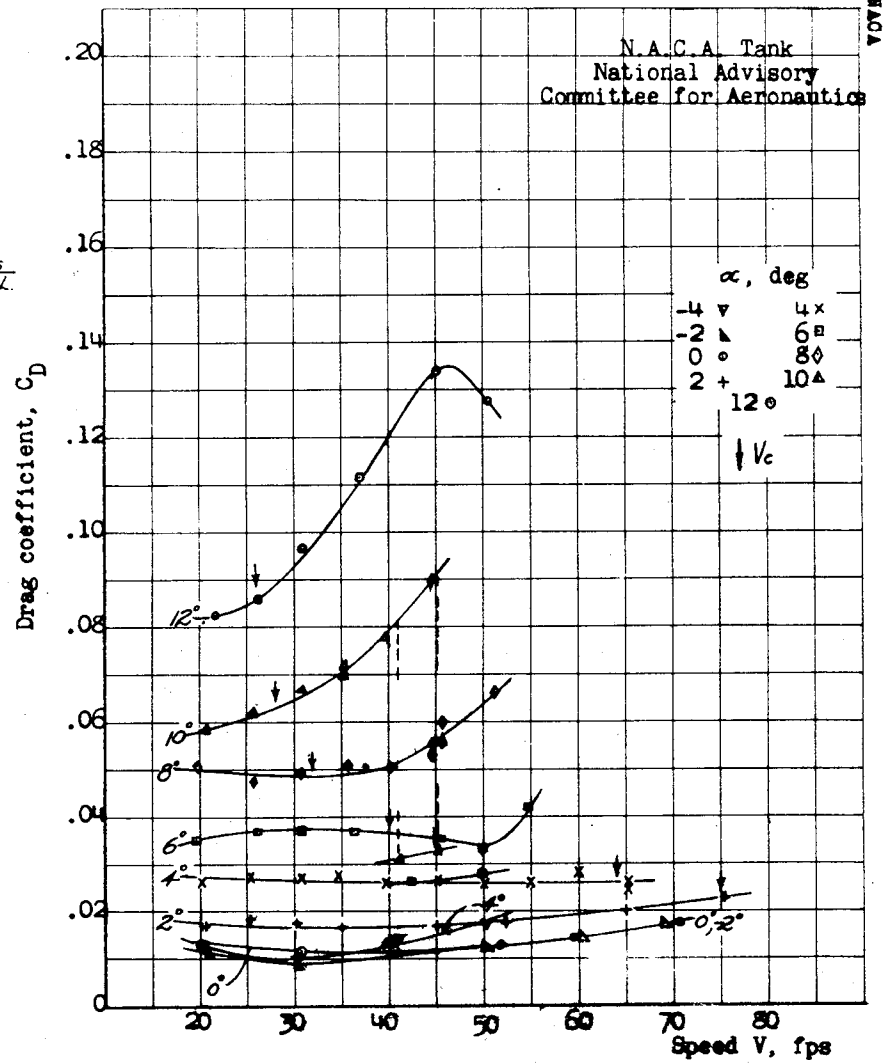
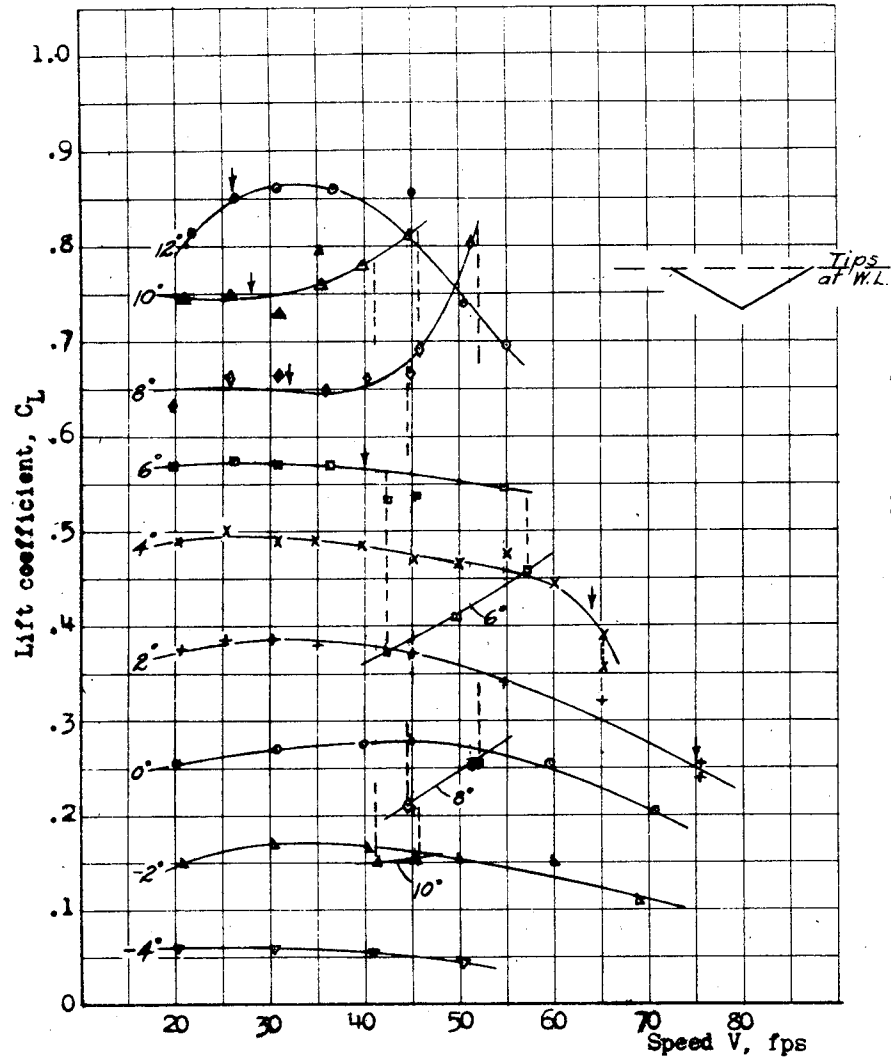

Fig. 14 .- NACA 16-509 section hydrofoil.  $30^\circ$  dihedral. Depths  $c/4$  at tips at water line.

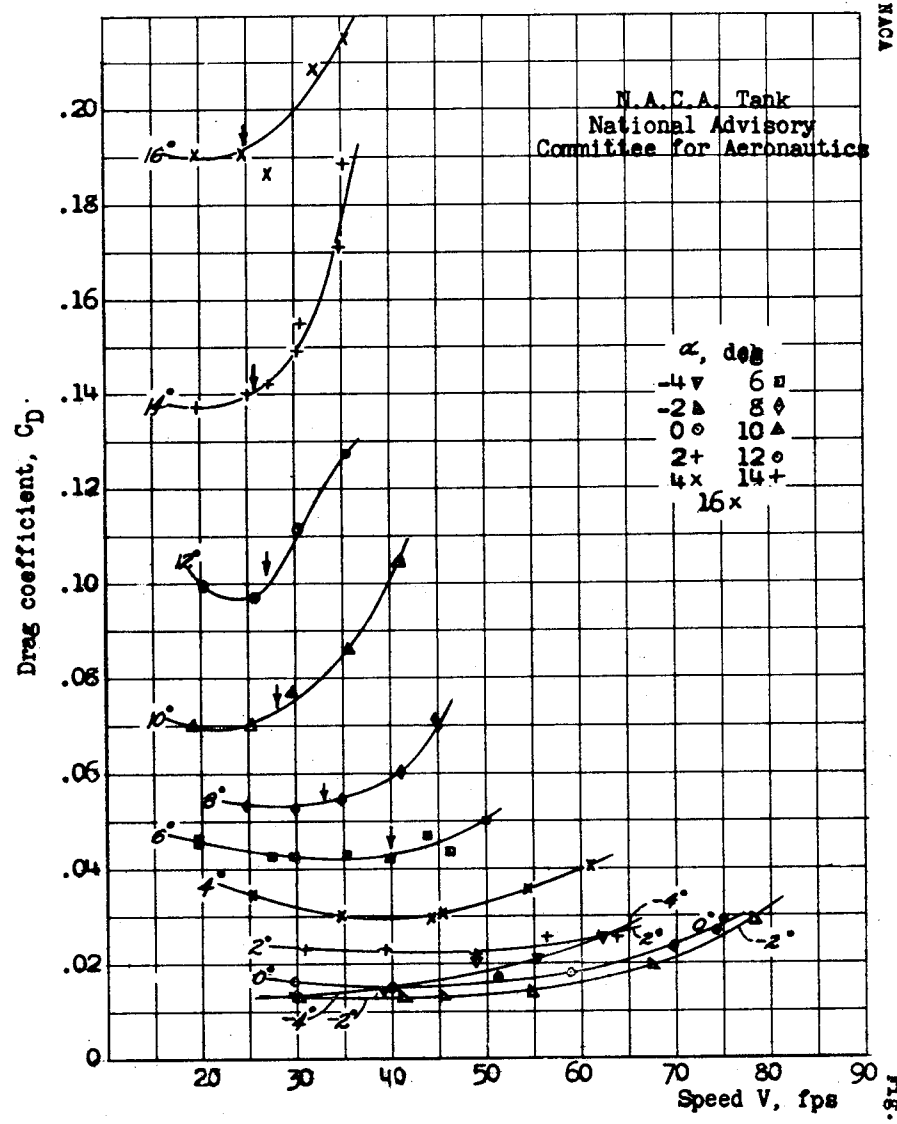
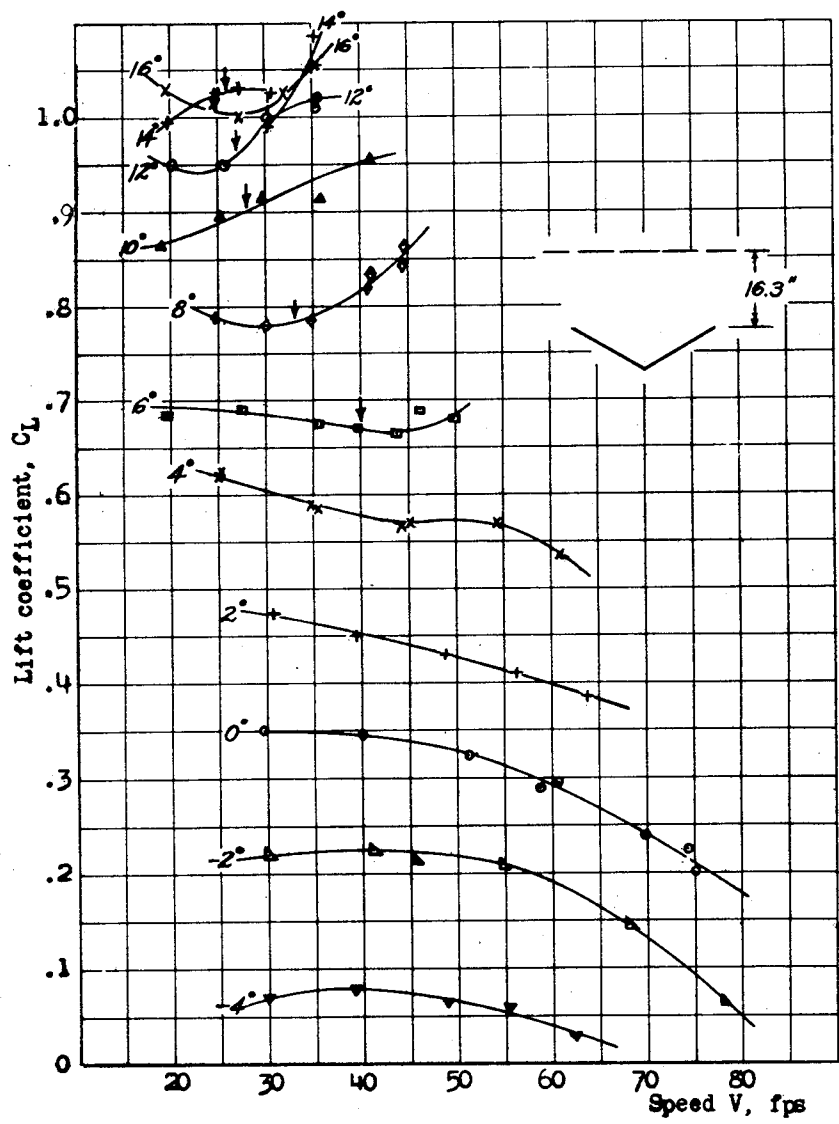

Fig.15 .- NACA 16-509 section hydrofoil. 30° dihedral. Depth, 16.3 inches to  $\epsilon/4$  at tips.

NACA  
FIG. 15

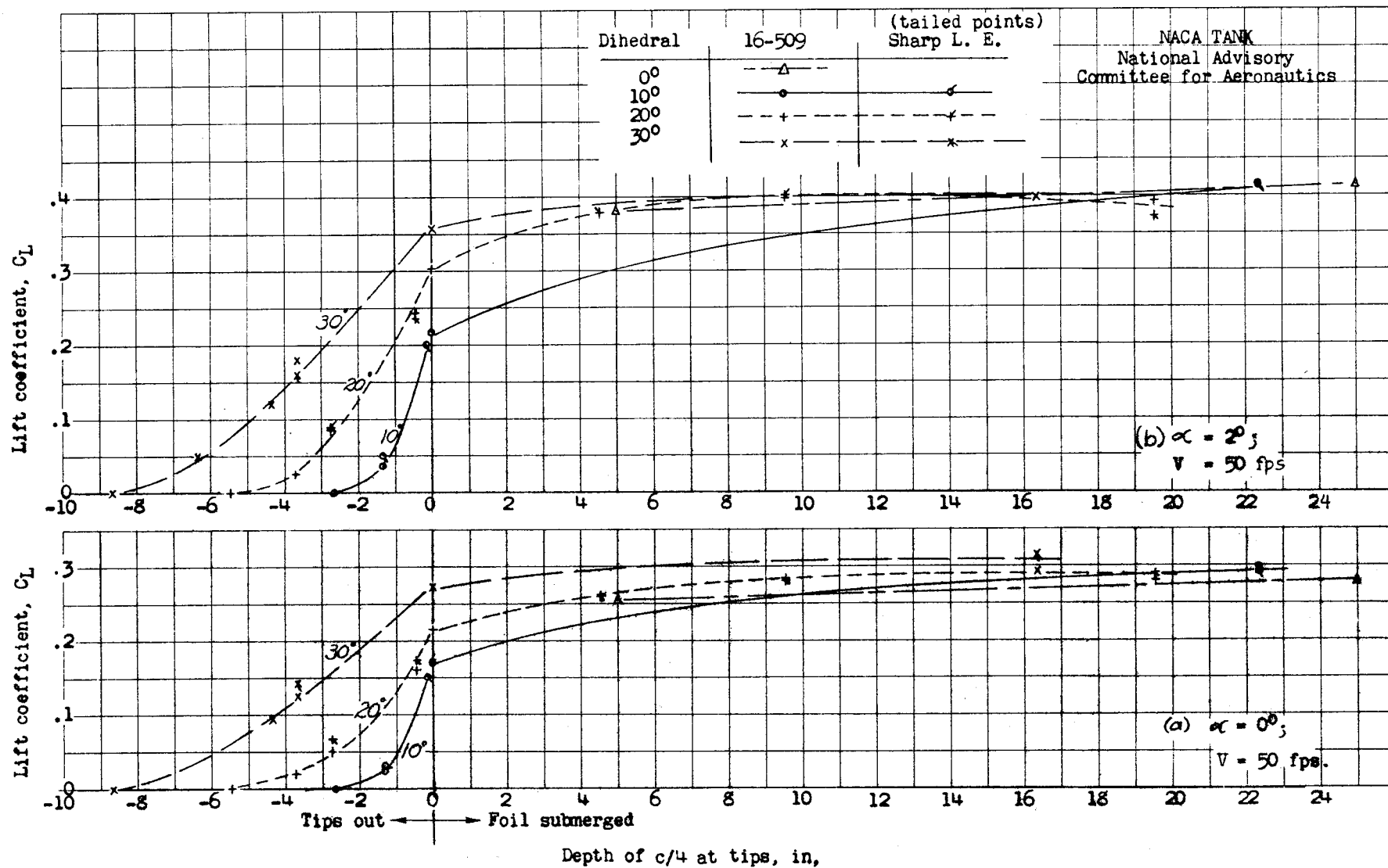

Fig. 16a,b.—Effect of depth on lift coefficient.

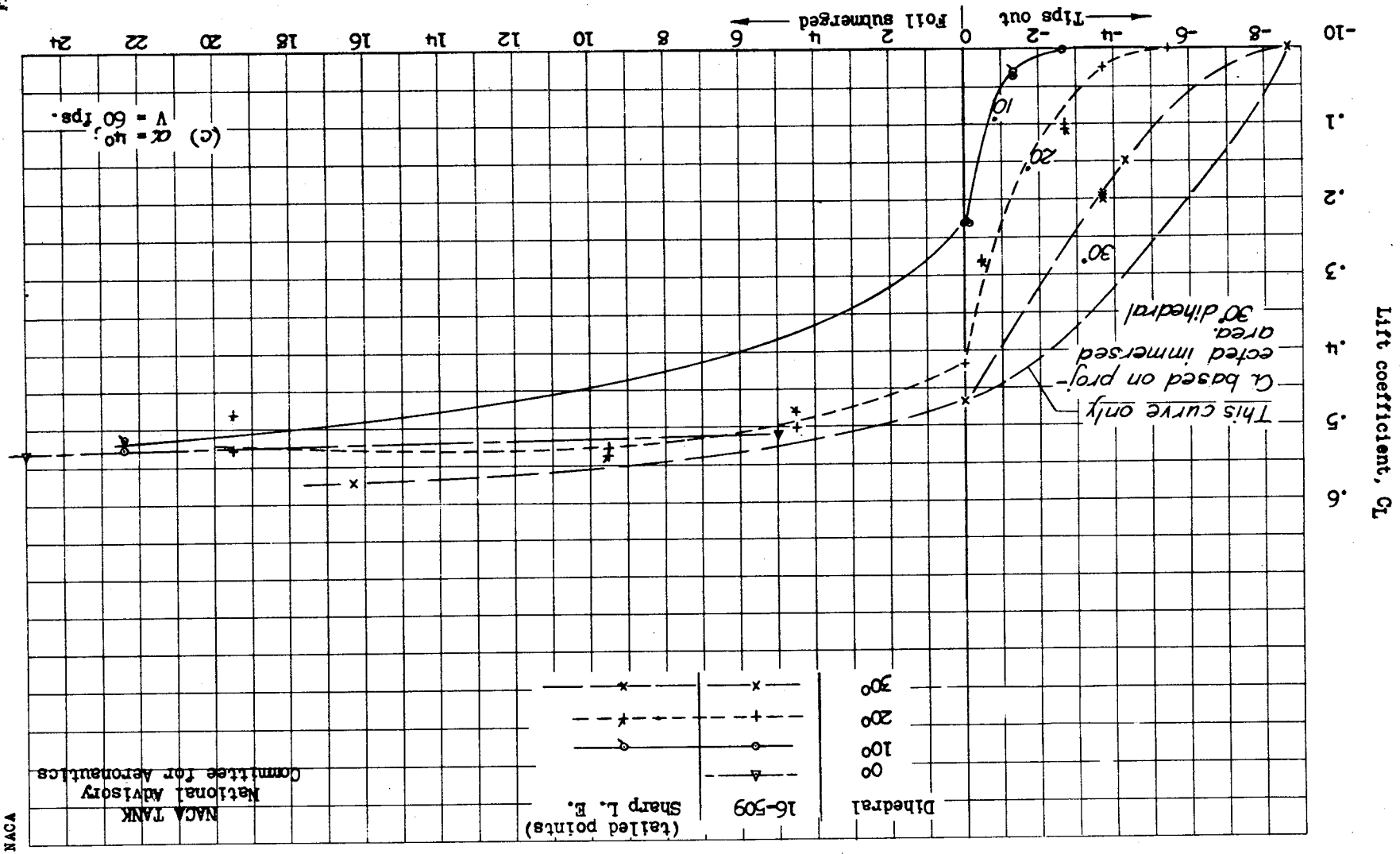

Fig. 16c. - Effect of depth on lift coefficient. Continued.

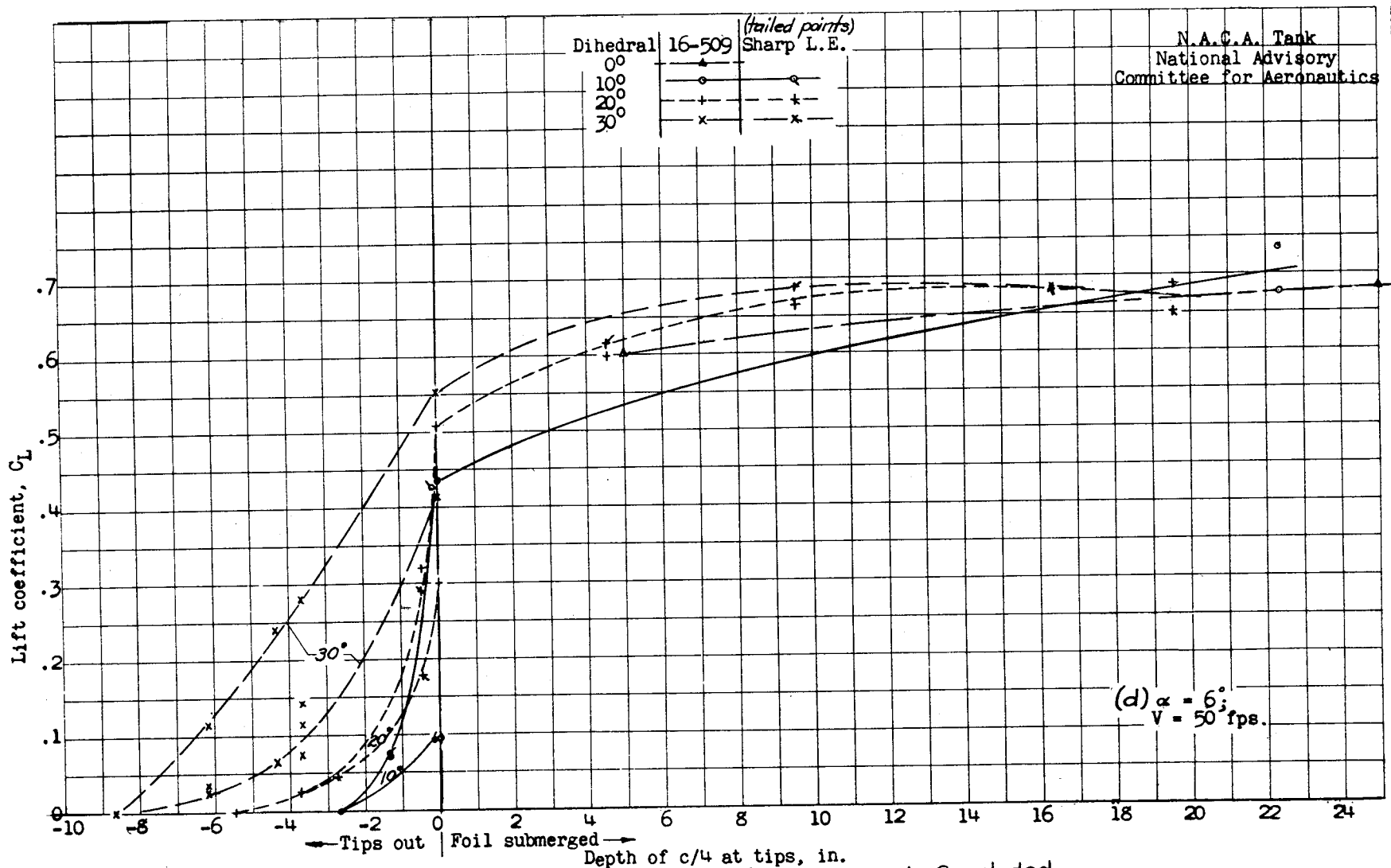

Fig. 16d.- Effect of depth on lift coefficient. Concluded.



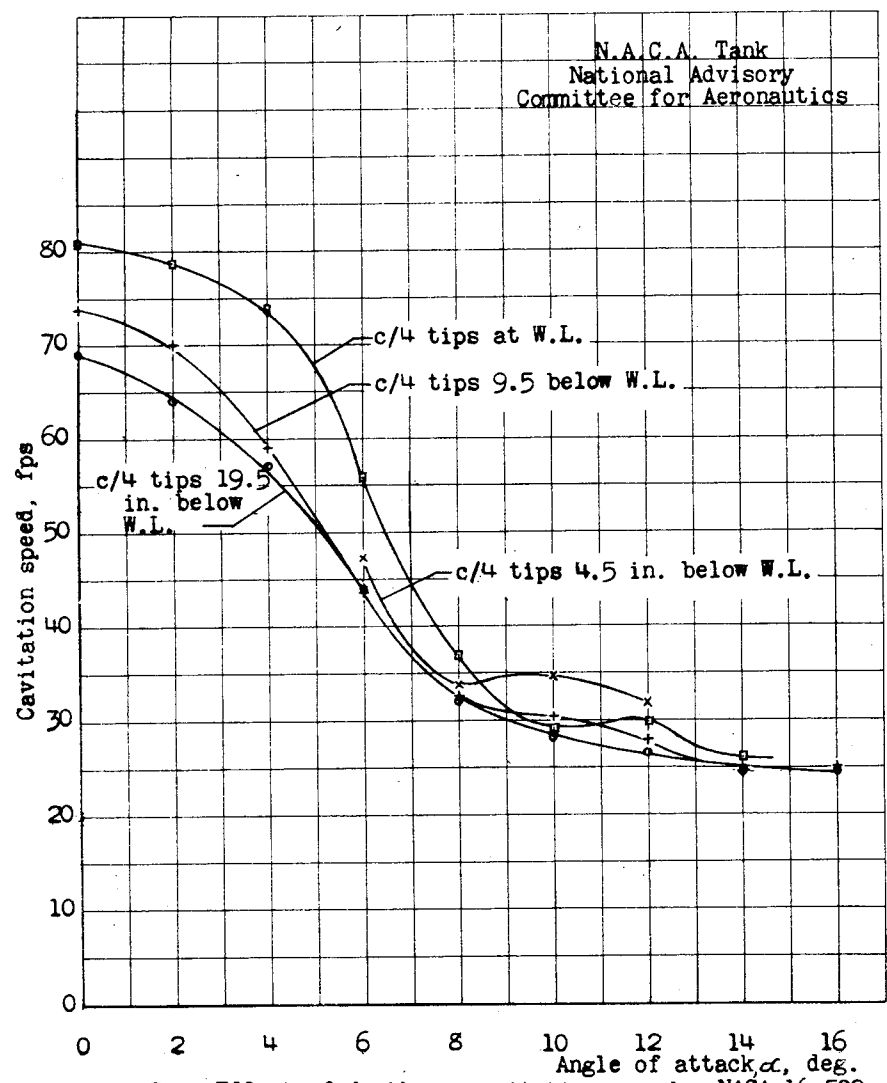

Fig. 17 .- Effect of depth on cavitation speed. NACA 16-509 section hydrofoil.  $20^\circ$  dihedral.

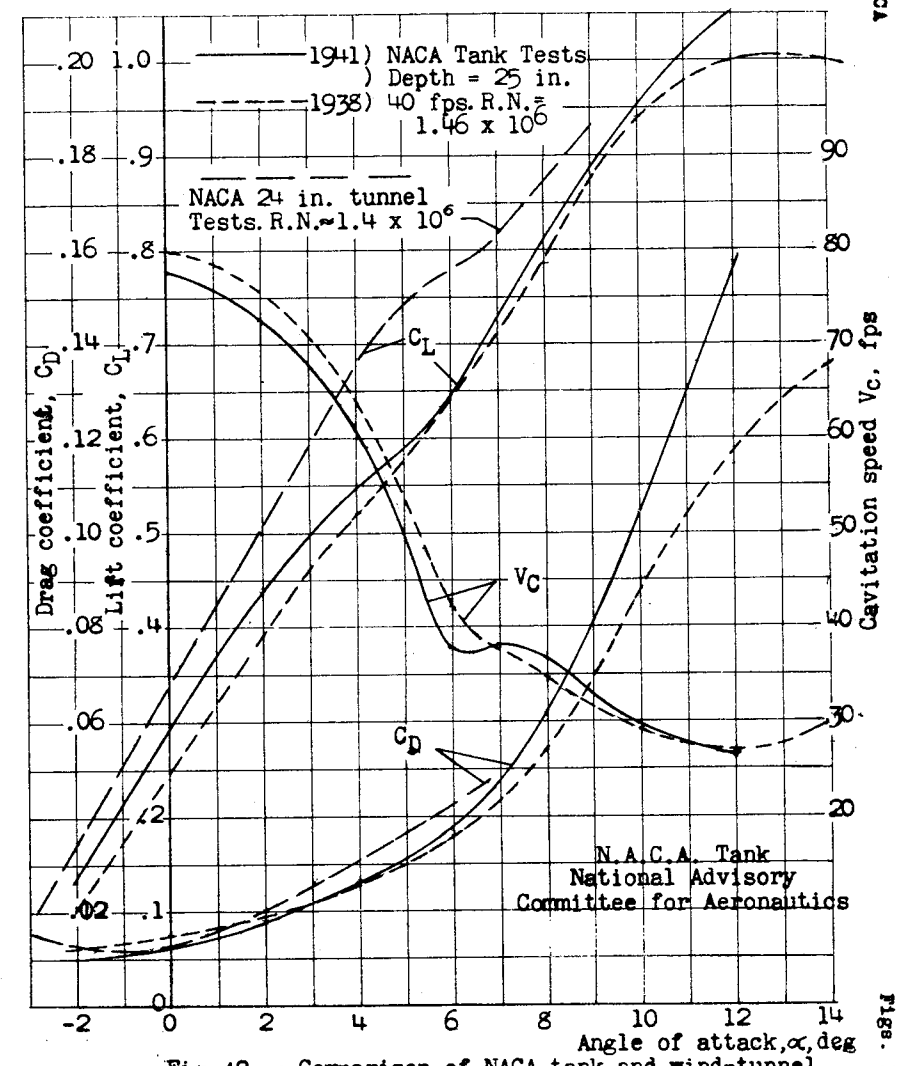

Fig. 19 .- Comparison of NACA tank and wind-tunnel tests on 16-509 section foil.

FIGS. 17, 19

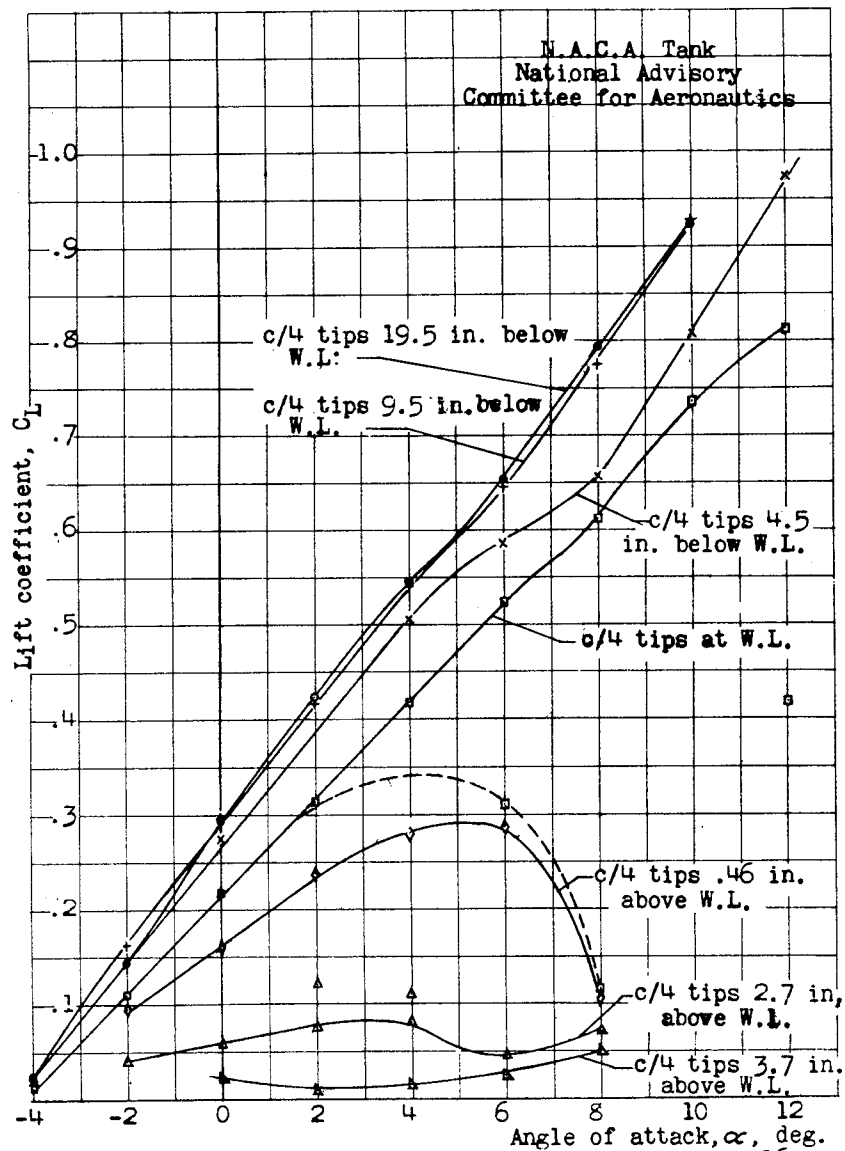

Fig. 18a. Effect of depth on lift coefficient. NACA 16-509 section hydrofoil.  $20^\circ$  dihedral. 40 fps.

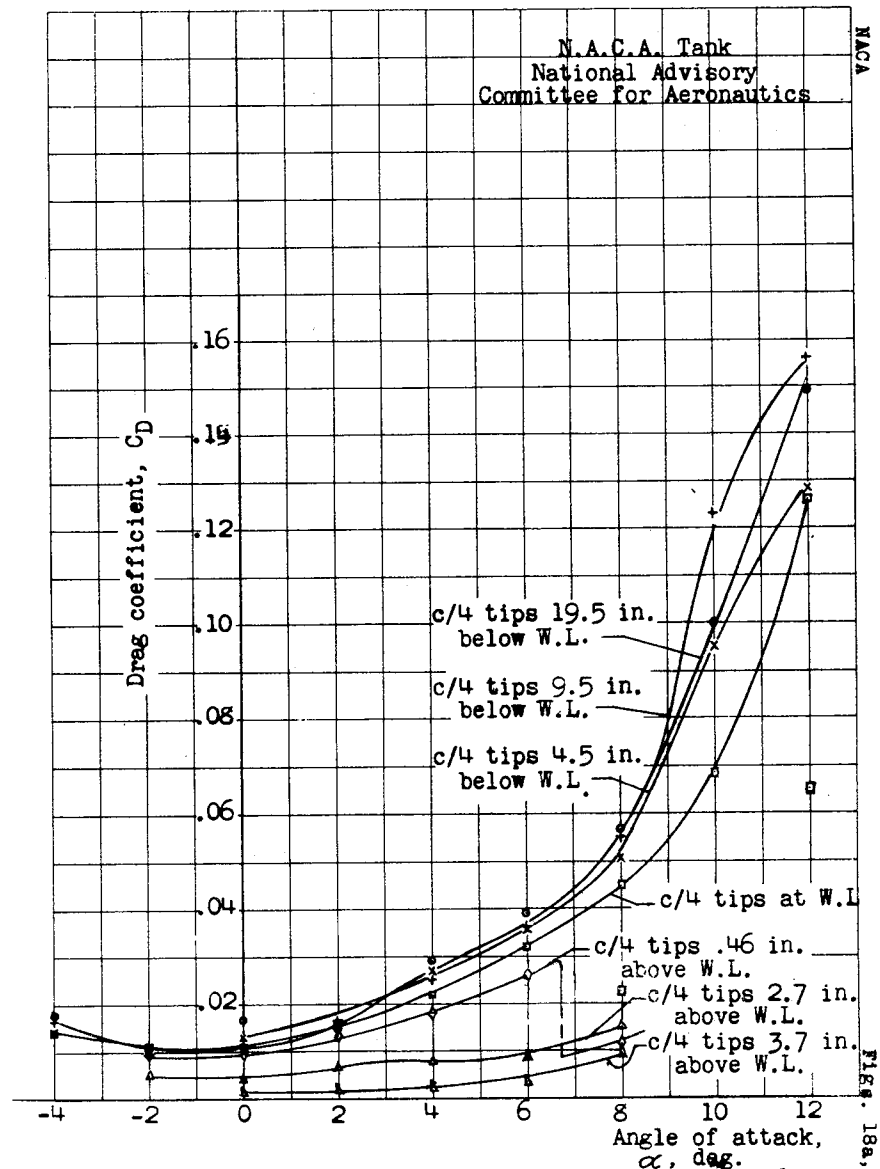

Fig. 18b. Effect of depth on drag coefficient. NACA 16-509 section hydrofoil.  $20^\circ$  dihedral. 40 fps

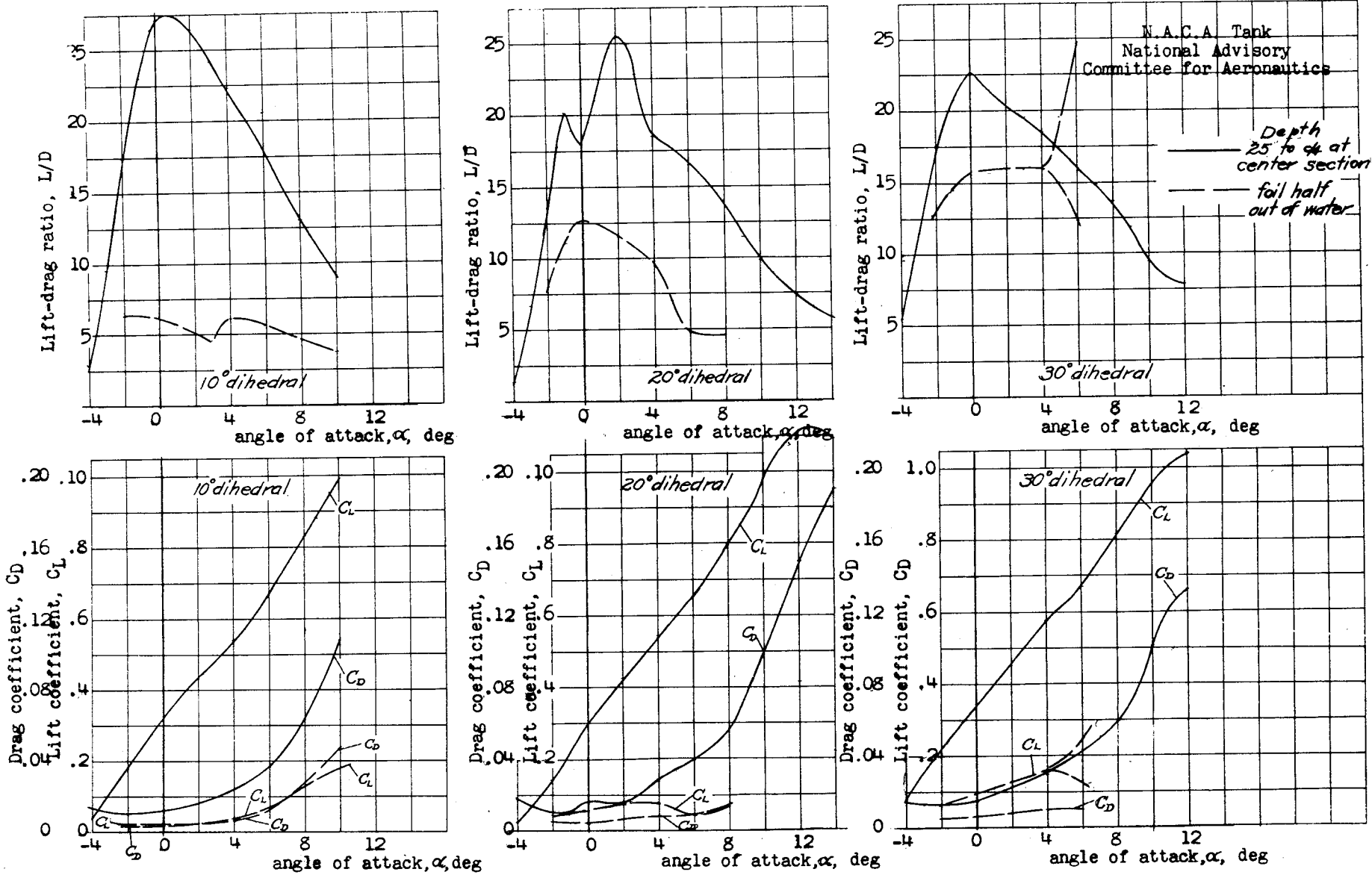

Fig. 20.- Characteristics of 16-509 section hydrofoils with dihedral angles of 10, 20, and 30 degrees at two depths. V = 40 fps  
DWH

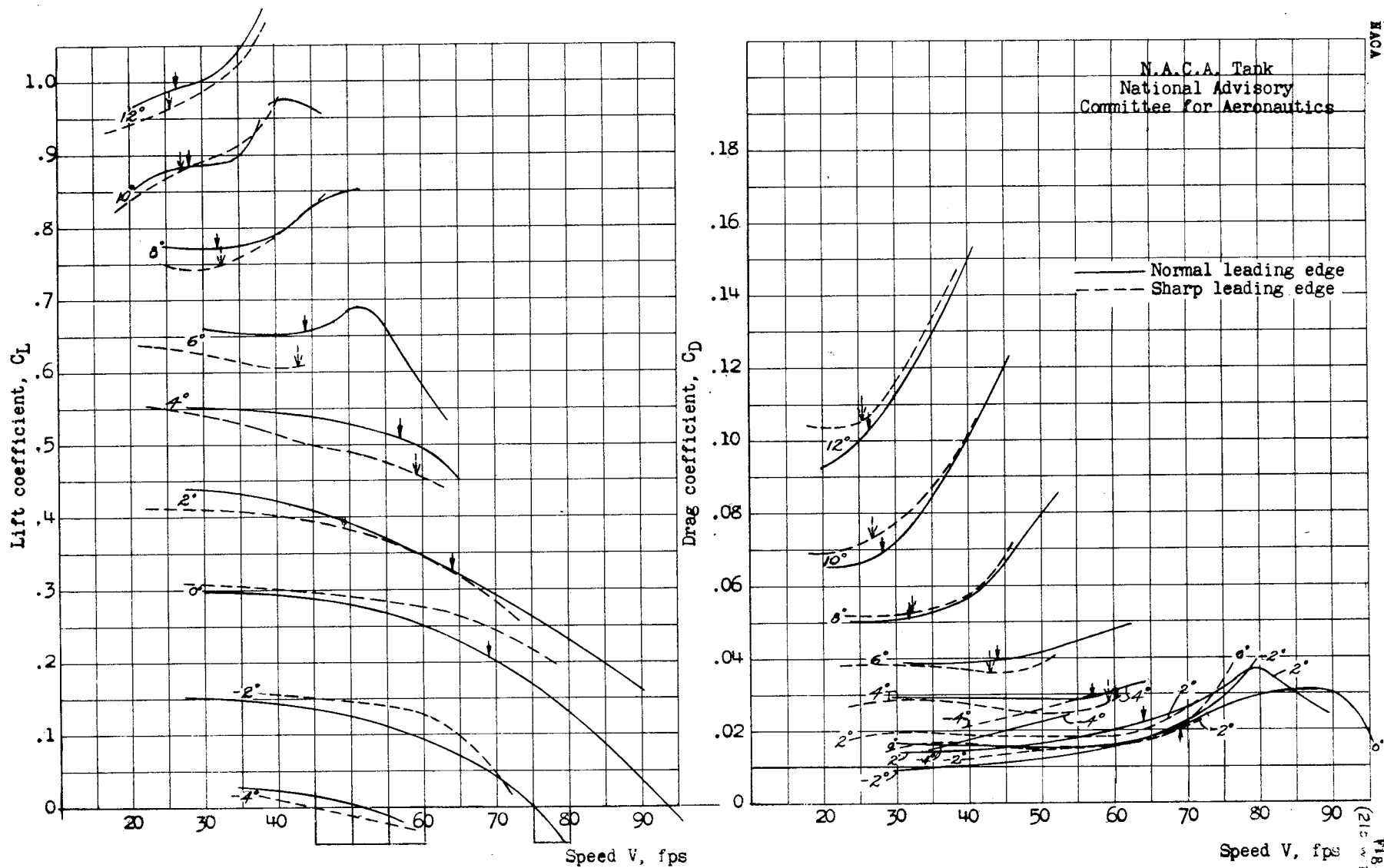

Fig. 21a. - Comparison of test results on normal and sharp leading edge hydrofoils.  $20^\circ$  dihedral. Depth, 19.5 inches to  $c/4$  at tips.

FIG. 21a  
(21c, 21d, 21e, 21f, 21g, 21h, 21i, 21j, 21k, 21l, 21m, 21n, 21o, 21p, 21q, 21r, 21s, 21t, 21u, 21v, 21w, 21x, 21y, 21z)