

**HEAT TRANSFER IN ROCKET ENGINE  
COMBUSTION CHAMBERS AND NOZZLES**

P. G. Anderson, G. C. Cheng and R. C. Farmer

SECA, Inc.  
Huntsville, AL

S1-34

~~43776~~

P-28

1995 116993

**Abstract**

Complexities of liquid rocket engine heat transfer which involve the injector faceplate and regeneratively and film cooled walls are being investigated by computational analysis. A conjugate heat transfer analysis will be used to describe localized heating phenomena associated with particular injector configurations and coolant channels and film coolant dumps. These components are being analyzed, and the analyses verified with appropriate test data. Finally, the component analyses will be synthesized into an overall flowfield/heat transfer model. The FDNS code is being used to make the component analyses. Particular attention is being given to the representation of the thermodynamic properties of the fluid streams and to the method of combining the detailed models to represent overall heating. Unit flow models of specific coaxial injector elements have been developed and will be described.

Since test data from the NLS development program are not available, new validation heat transfer data has been sought. Suitable data was obtained from a Rocketdyne test program on a model hydrocarbon/oxygen engine. Simulations of this test data will be presented.

Recent interest in the hybrid motor have established the need for analyses of ablating solid fuels in the combustion chamber. Analysis of a simplified hybrid motor will also be presented.

PART-2

HEAT TRANSFER IN ROCKET ENGINE  
COMBUSTION CHAMBERS AND NOZZLES

P. G. Anderson, R. C. Farmer and G. C. Cheng  
SECA, Inc.

## OBJECTIVE

To develop and verify a conjugate heat transfer CFD model to describe regenerative cooling of the main combustion chamber and nozzle of a launch vehicle class liquid rocket engine.

## APPROACH

To analyze and verify the critical subprocesses which occur in the combustion chamber and synthesize all such processes into an overall heat transfer design tool.

# HEAT TRANSFER ANALYSIS OF INJECTOR ELEMENTS

- PROVIDE FLUID PROPERTIES OF FUEL AND OXIDIZER AT OUTLET OF MAIN INJECTOR AND BAFFLE ELEMENTS
- ANALYSIS OF INJECTORS FROM LOX DOME TO ELEMENT OUTLETS
- ELEMENT EXTERNAL ENVIRONMENTS OBTAINED FROM FLOW ANALYSES
  - HOT EXHAUST GAS REGION
  - REGION BETWEEN INJECTOR PLATES
- OXYGEN FROM DOME AND COOLANT HYDROGEN ABOVE CRITICAL
  - NOT IDEAL GAS
  - HMBS EQUATIONS INCORPORATED INTO FDNS CODE
- GRIDS
  - AXISYMMETRIC
  - MAIN INJECTOR - 10962 NODES
  - BAFFLE INJECTOR - 10404 NODES

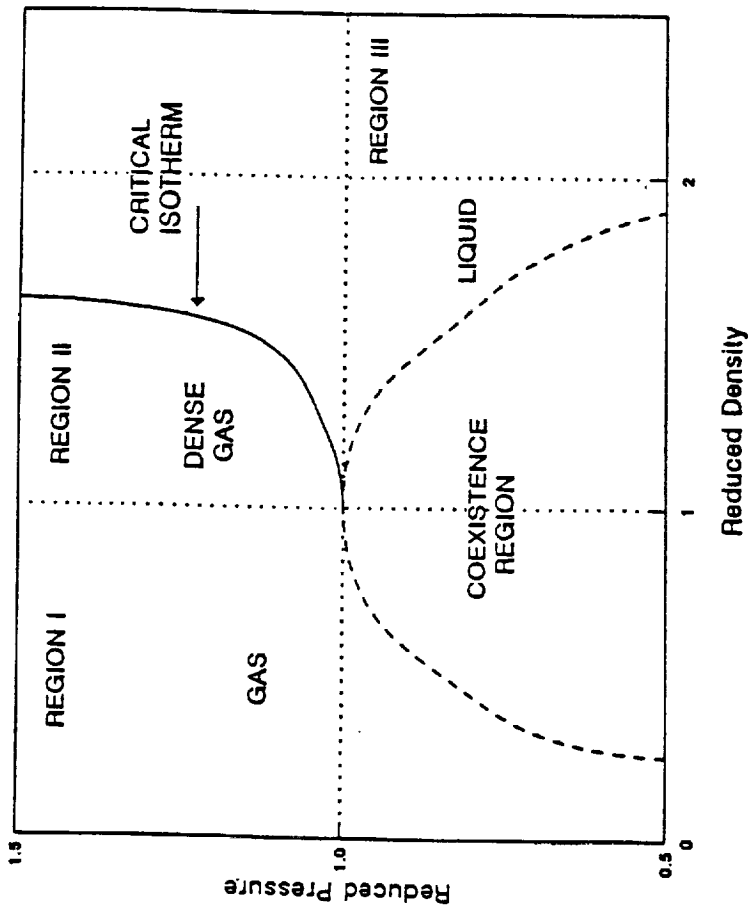

For each region

$$\frac{P}{P_{crit}} = \sum_{j=1}^A t^{j-2} \sum_{l=1}^B B_{lj} \rho^{j-2} + A(t)$$

$$\frac{H-H_0}{RT} = Z_c \int_a^b \left[ \frac{P}{t} - \left( \frac{\delta P}{\delta t} \right)_\rho \right] \rho^{-2} d\rho + Z_c \frac{P}{\rho t} + C(t)$$

Also,  $P_v$ ,  $\rho_l$ ,  $H_0$  are functions of  $t$  and  $\rho_v$  is a function of  $t$  and  $P_v$

MAIN INJECTOR ELEMENT (PARTIAL GRID)

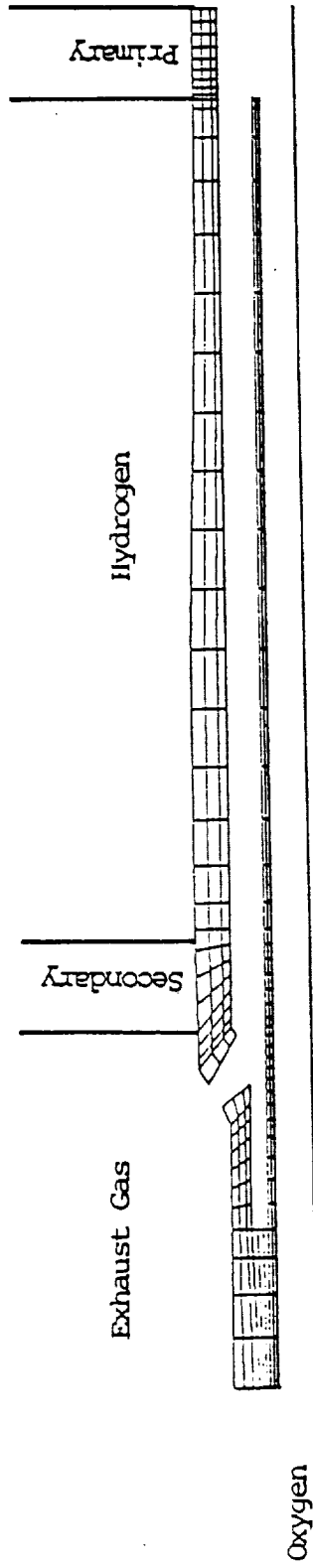

BAFFLE ELEMENT (PARTIAL GRID)

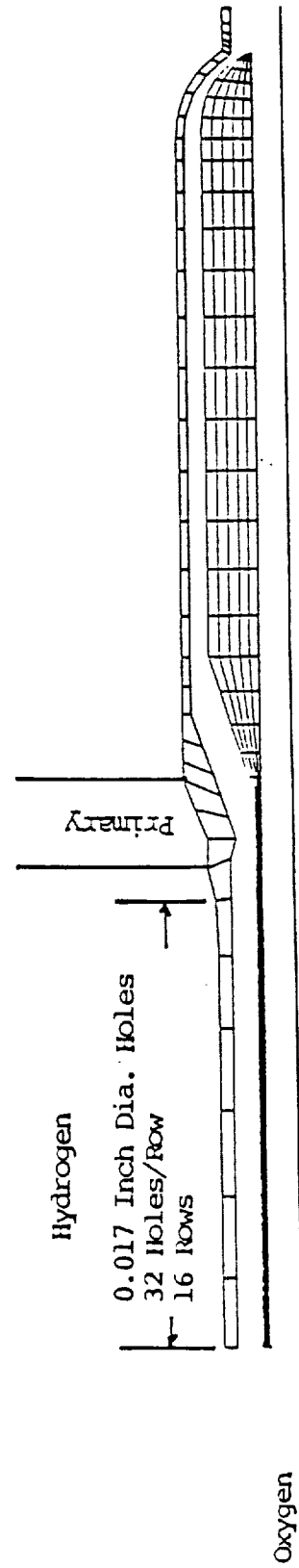

## BOUNDARY CONDITIONS

- MASS FLOW RATE BALANCE FOR INLETS AND OUTLETS
- EXTERNAL SKIN TEMPERATURES COMPUTED EACH ITERATION USING QUASI-ONE DIMENSIONAL HEAT BALANCE BASED ON NUSSELT NUMBER FOR CROSSFLOW IN TUBE BANKS (HEAT AND MASS TRANSFER, WHITE, PP 353-355)
  - AVERAGED IN-LINE AND STAGGERED RESULTS
  - EXTERNAL FLUID TEMPERATURES OBTAINED FROM PREVIOUS ANALYSES BY SECA
- CONDUCTION IN WALLS CALCULATED BY FDNS

# MODIFICATIONS TO FDNS

## PRESSURE-BASED VERSION

- SOLVE MOMENTUM CONSERVATION FOR VELOCITIES
- SOLVE ENERGY CONSERVATION FOR ENTHALPY
- SOLVE SPECIES CONTINUITY FOR SPECIES MASS FRACTIONS
- SOLVE PRESSURE-CORRECTION EQUATION FOR PRESSURE
- USE HMBS MODEL TO OBTAIN DENSITY AND TEMPERATURE (ITERATIVE PROCEDURE HAS CONVERGENCE PROBLEMS IN 2D)

## DENSITY-BASED VERSION

- SAME
- SOLVE ENERGY CONSERVATION FOR TEMPERATURE
- SOLVE SPECIES CONTINUITY FOR SPECIES DENSITIES
- DENSITY = SUM OF SPECIES DENSITIES
- USE HMBS MODEL TO OBTAIN PRESSURE AND ENTHALPY



SPECIES 01  
 MASS FRACT  
 0 50000E-01 A  
 0 15000E+00 B  
 0 25000E+00 C  
 0 35000E+00 D  
 0 45000E+00 E  
 0 55000E+00 F  
 0 65000E+00 G  
 0 75000E+00 H  
 0 85000E+00 I  
 0 95000E+00 J

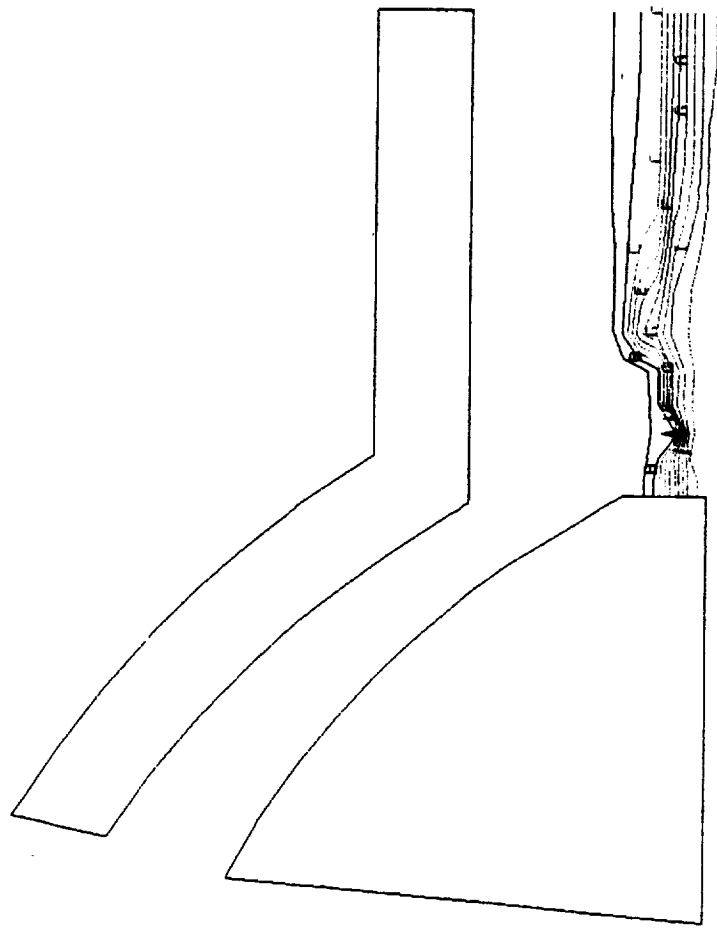

---

OXYGEN MASS FRACTION IN BAFFLE ELEMENT EXIT

VEL VECTOR  
 (FPS)  
 0.0000E+00 A  
 0.1000E+03 B  
 0.2000E+03 C  
 0.3000E+03 D  
 0.4000E+03 E  
 0.5000E+03 F  
 0.6000E+03 G  
 0.7000E+03 H  
 0.8000E+03 I  
 0.9000E+03 J  
 0.1000E+04 K  
 0.1100E+04 L  
 0.1200E+04 M  
 0.1300E+04 N  
 0.1400E+04 O  
 0.1500E+04 P  
 0.1600E+04 Q  
 0.1700E+04 R  
 0.1800E+04 S  
 0.1900E+04 T  
 0.2000E+04 U  
 0.2100E+04 V  
 0.2200E+04 W  
 0.2300E+04 X  
 0.2400E+04 Y  
 0.2500E+04 Z

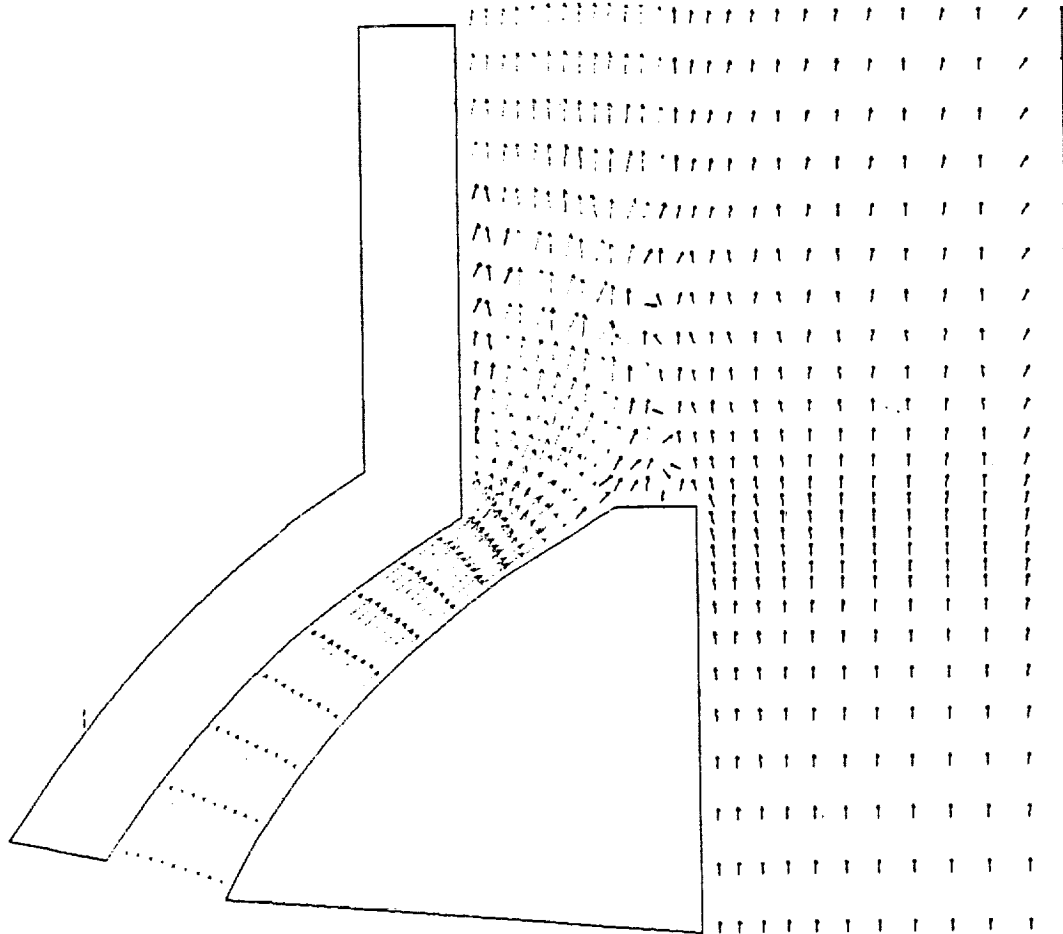

VELOCITY VECTORS IN BAFFLE ELEMENT EXIT

ORIGINAL PAGE IS  
 OF POOR QUALITY

TEMPERATURE  
(DEG R)

- 0.20000E+03 A
- 0.22500E+03 B
- 0.25000E+03 C
- 0.27500E+03 D
- 0.30000E+03 E
- 0.32500E+03 F
- 0.35000E+03 G
- 0.37500E+03 H
- 0.40000E+03 I
- 0.42500E+03 J
- 0.45000E+03 K
- 0.47500E+03 L
- 0.50000E+03 M
- 0.52500E+03 N
- 0.55000E+03 O
- 0.57500E+03 P
- 0.60000E+03 U

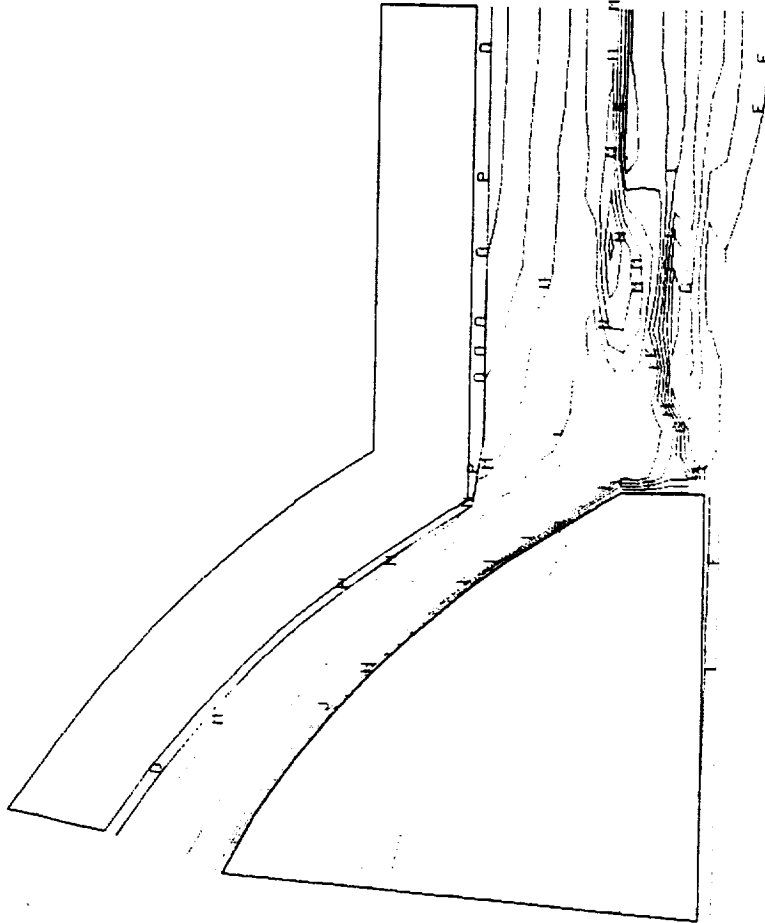

TEMPERATURE IN BAFFLE ELEMENT EXIT

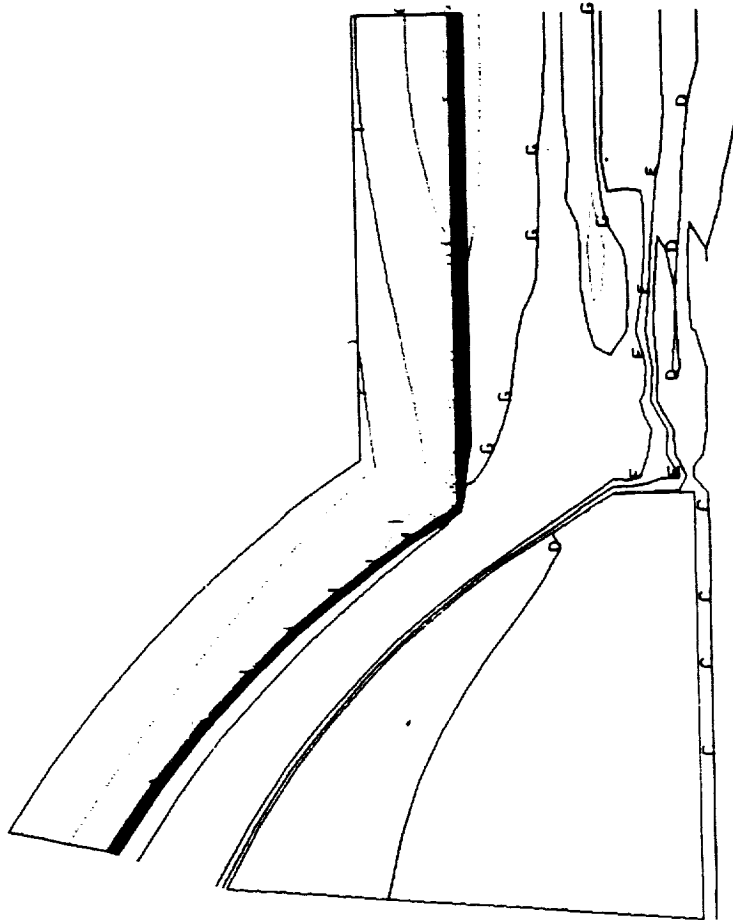

- TEMPERATURE  
(DEG R)
- 0.2000E+03 A
  - 0.2500E+03 B
  - 0.3000E+03 C
  - 0.3500E+03 D
  - 0.4000E+03 E
  - 0.4500E+03 F
  - 0.5000E+03 G
  - 0.5500E+03 H
  - 0.6000E+03 I
  - 0.6500E+03 J
  - 0.7000E+03 K
  - 0.7500E+03 L
  - 0.8000E+03 M
  - 0.8500E+03 N
  - 0.9000E+03 O
  - 0.9500E+03 P
  - 1.000E+04 Q
  - 1.050E+04 R
  - 1.100E+04 S
  - 1.150E+04 T
  - 1.200E+04 U
  - 1.250E+04 V
  - 1.300E+04 W
  - 1.350E+04 X
  - 1.400E+04 Y
  - 1.450E+04 Z
  - 1.500E+04 AA
  - 1.550E+04 AB
  - 1.600E+04 AC
  - 1.650E+04 AD
  - 1.700E+04 AE

TEMPERATURE IN BAFFLE ELEMENT EXIT

ENTR 7575

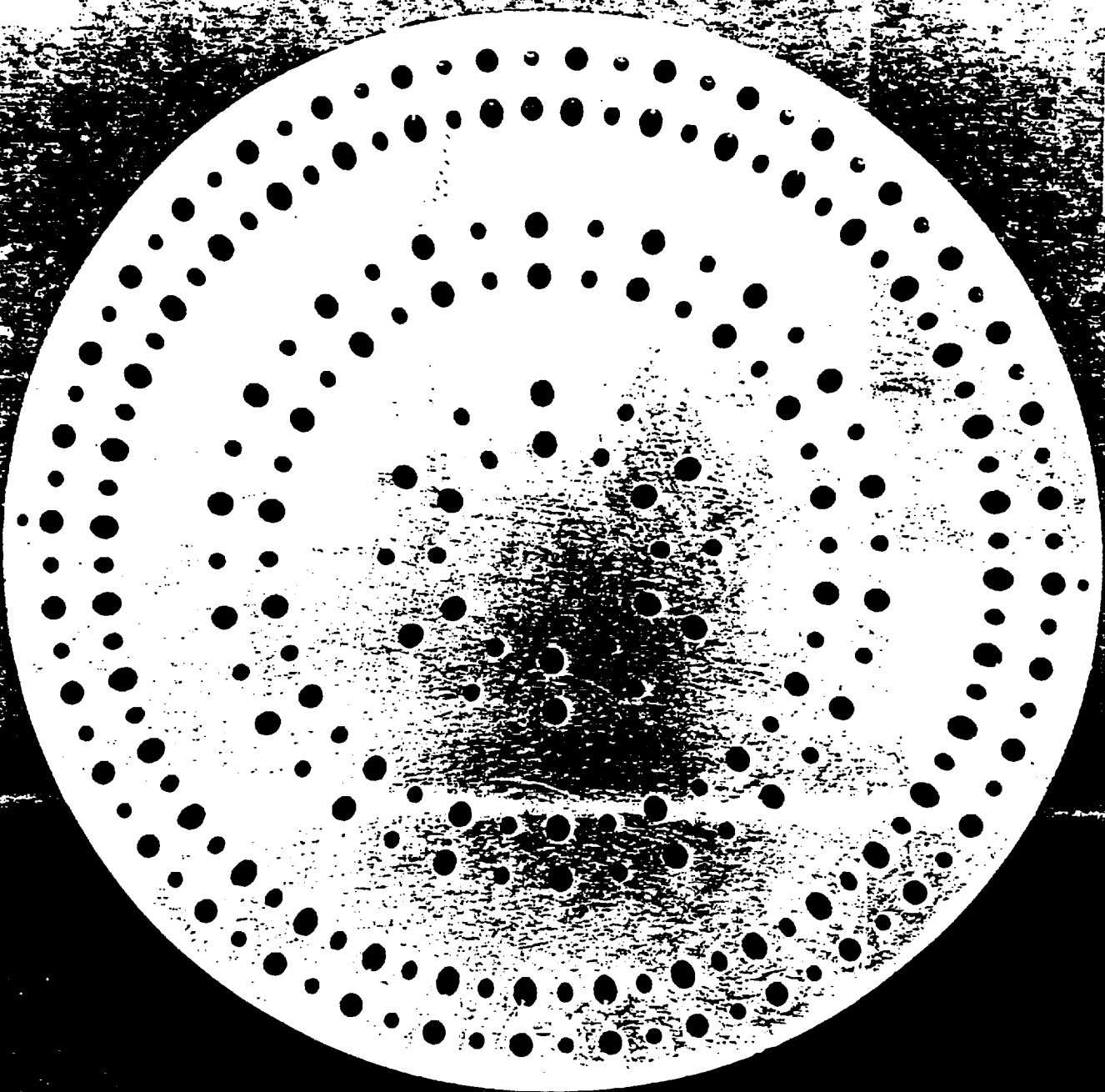

INCHES



2

3

CENTIMETERS

5

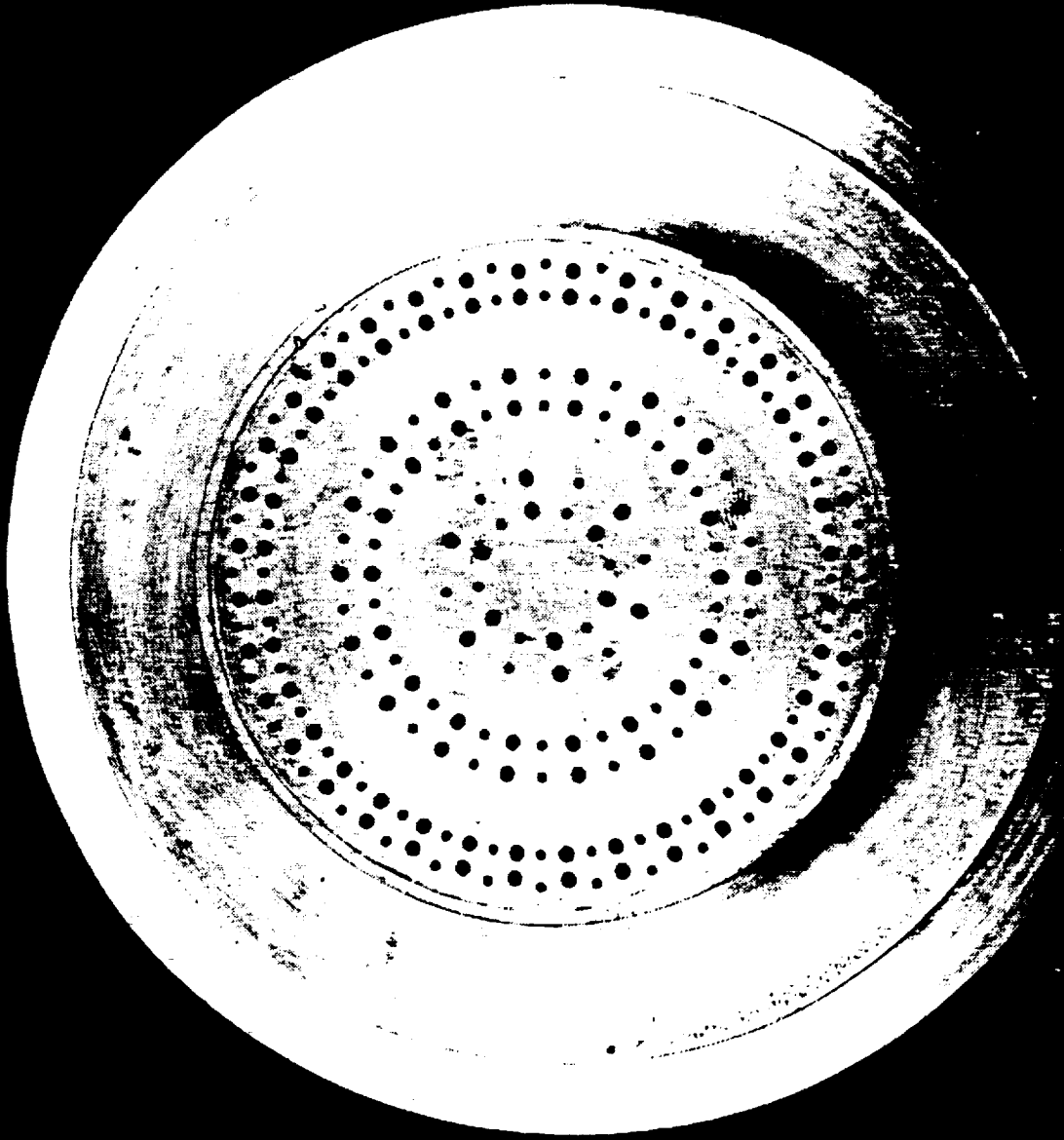

1XZ41-11/20/89.C1D



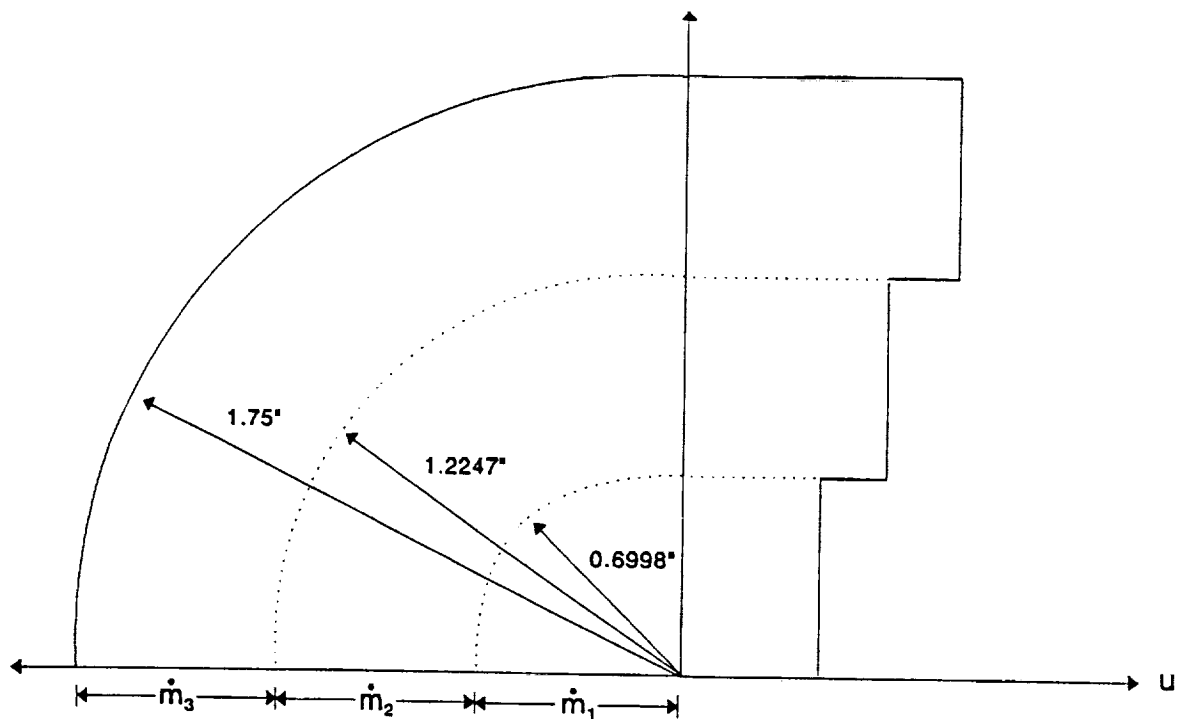

(a) Uniform O/F Distribution

(  $\dot{m}_1 = 4.45 \text{ lb/sec}$ ,  $\dot{m}_2 = 13.35 \text{ lb/sec}$ ,  $\dot{m}_3 = 26.7 \text{ lb/sec}$  )

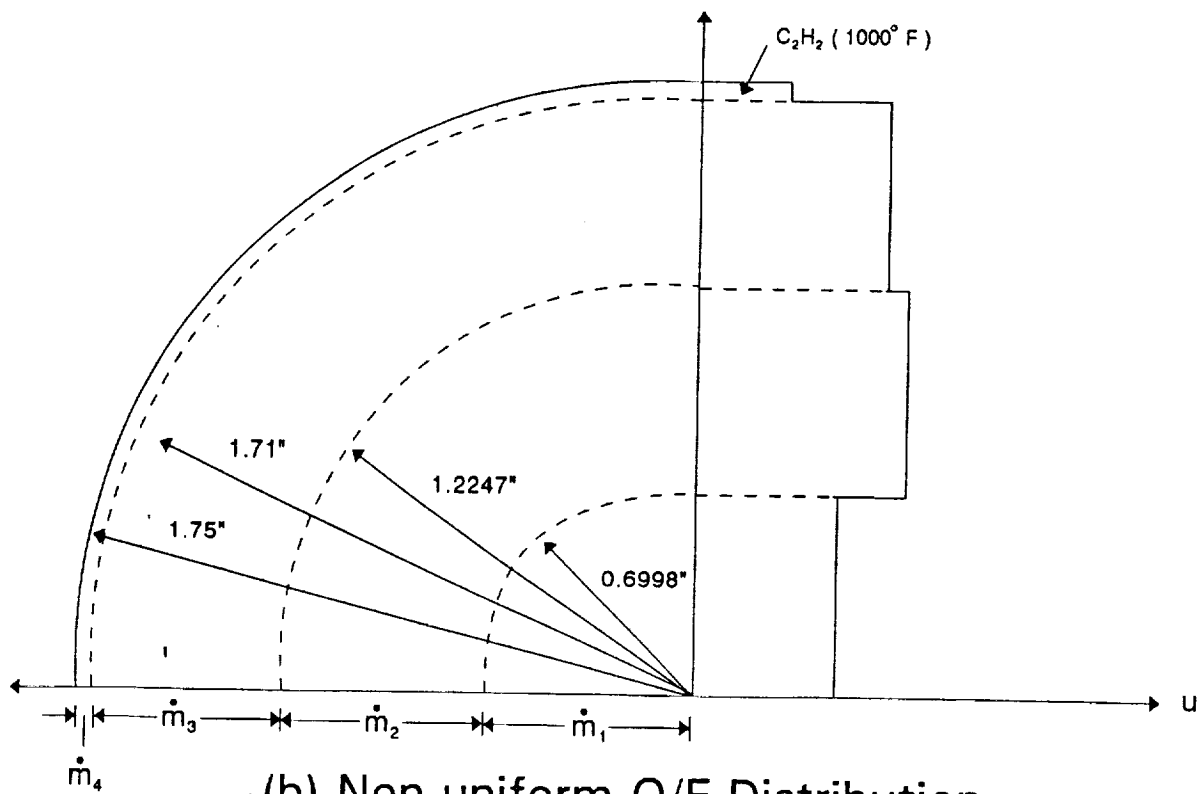

(b) Non-uniform O/F Distribution

(  $\dot{m}_1 = 4.45 \text{ lb/sec}$ ,  $\dot{m}_2 = 13.35 \text{ lb/sec}$ ,  $\dot{m}_3 = 23.13 \text{ lb/sec}$ ,  $\dot{m}_4 = 3.57 \text{ lb/sec}$  )

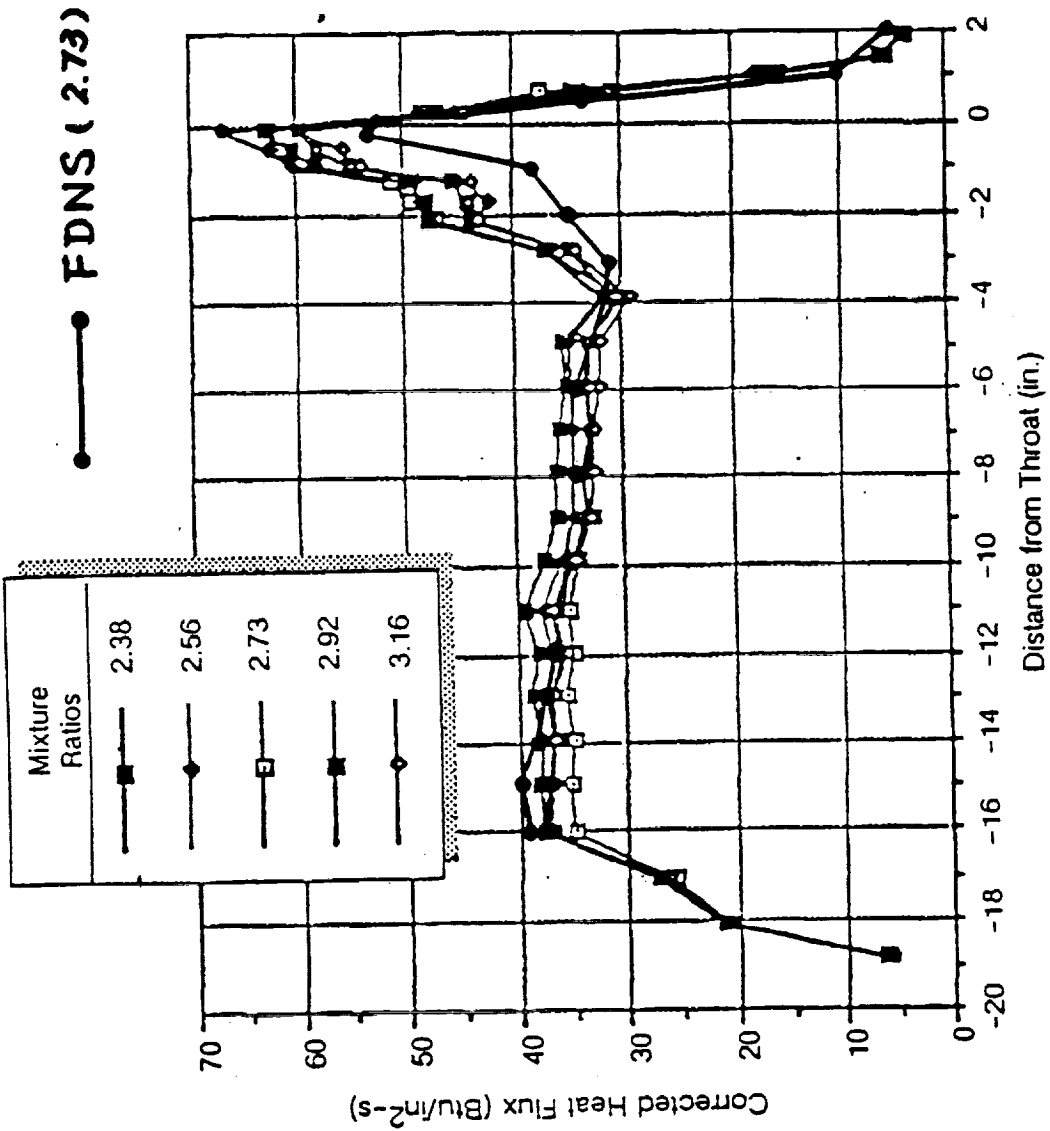

Heat Flux Distribution for the Original Configuration of Rocketdyne's Circumferential Fan Injector



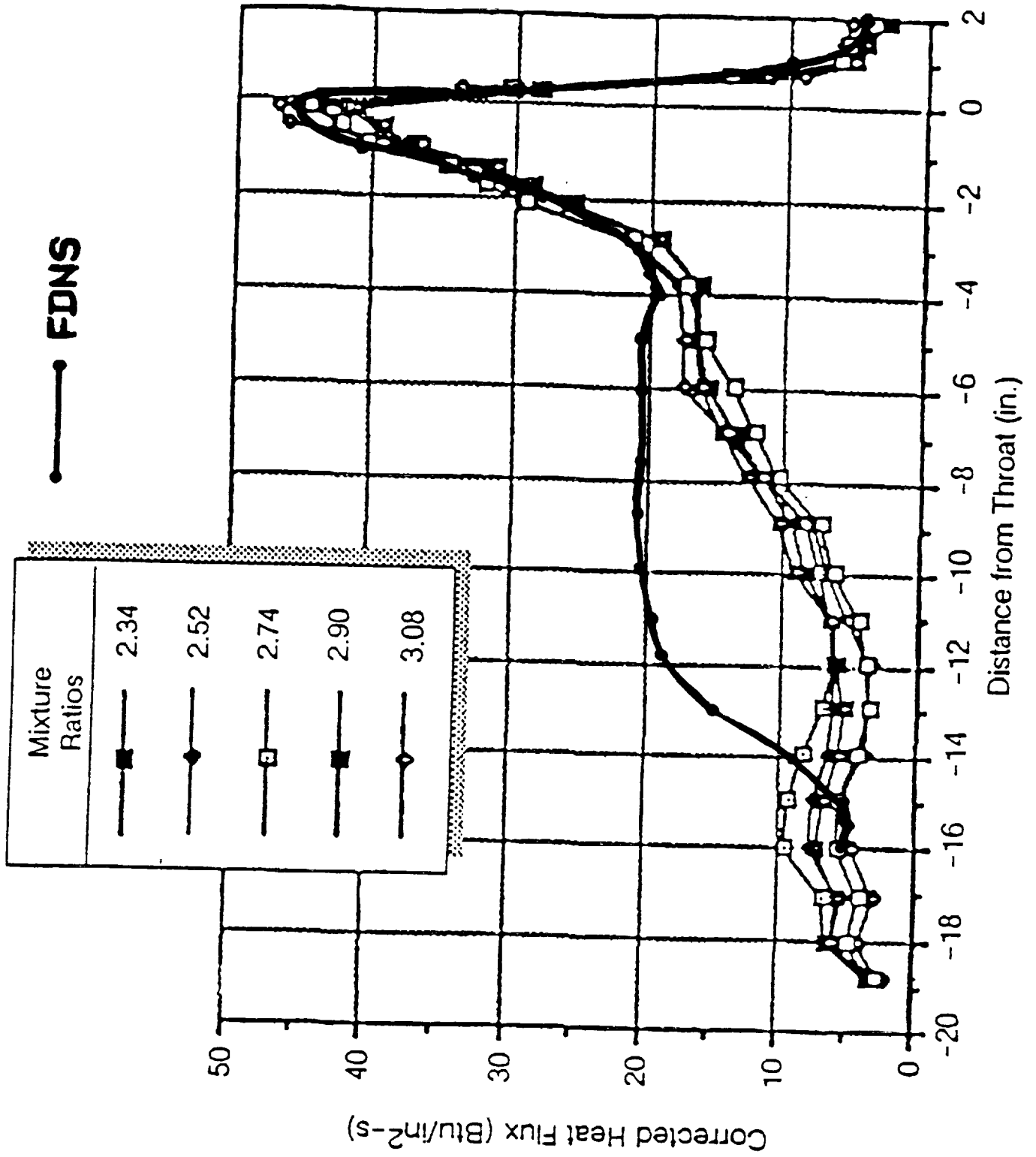

**Table 1**

**SUMMARY OF OXIDIZER AND FUEL INLET BOUNDARY CONDITIONS  
FOR THE HYBRID ROCKET MOTOR NUMERICAL SIMULATION**

Oxidizer Mass flow Rate	620 lb/sec
Oxidizer Inlet Pressure	500 psi
Oxidizer Inlet Temperature	300 °K
Oxidizer Inlet Reynolds Number	$1.76 \times 10^7 \text{ ft}^{-1}$
Fuel Regression Rate	0.088 in/sec
Fuel Injection Density	1.7034 lb/ft <sup>3</sup>
Fuel Injection Temperature	820 °K
Solid Fuel Density	57.553 lb/ft <sup>3</sup>
Overall O/F Ratio	2

Mesh System for 2-D Axisymmetrical Hybrid Rocket Motor

XMIN -4 1826E+01  
XMAX 4 1097E+02  
YMIN -1 7166E+02  
YMAX 2 0816E+02

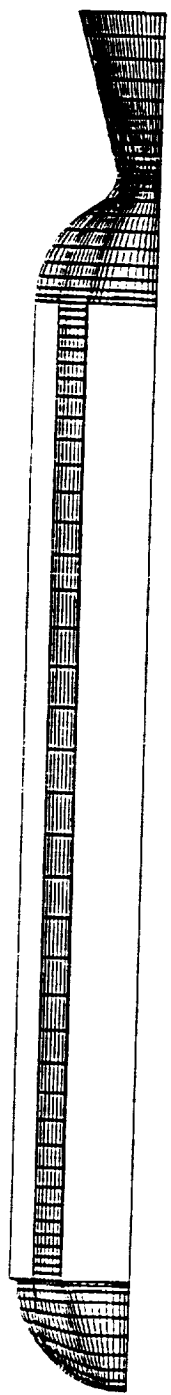

Grid for the Axisymmetric Configuration

Temperature in the axisymmetric hybrid rocket motor (deg. K)

XMIN: -4.4826E+01  
 XMAX: 4.1097E+02  
 YMIN: -9.6724E+01  
 YMAX: 1.3322E+02  
 FMIN: 3.0000E+02  
 FMAX: 4.2259E+03  
 DELF: 3.0000E+02

CONTOUR LEVELS:

ID	VALUES
A	3.0000E+02
B	6.0000E+02
C	9.0000E+02
D	1.2000E+03
E	1.5000E+03
F	1.7999E+03
G	2.0999E+03
K	3.2999E+03
L	3.5999E+03
M	3.9000E+03
N	4.1999E+03

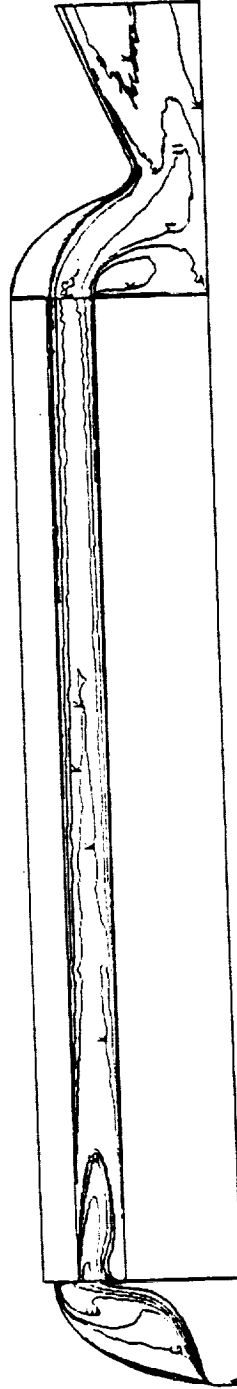

Axisymmetric Hybrid Configuration

Temperature in the head-end region (degree K)

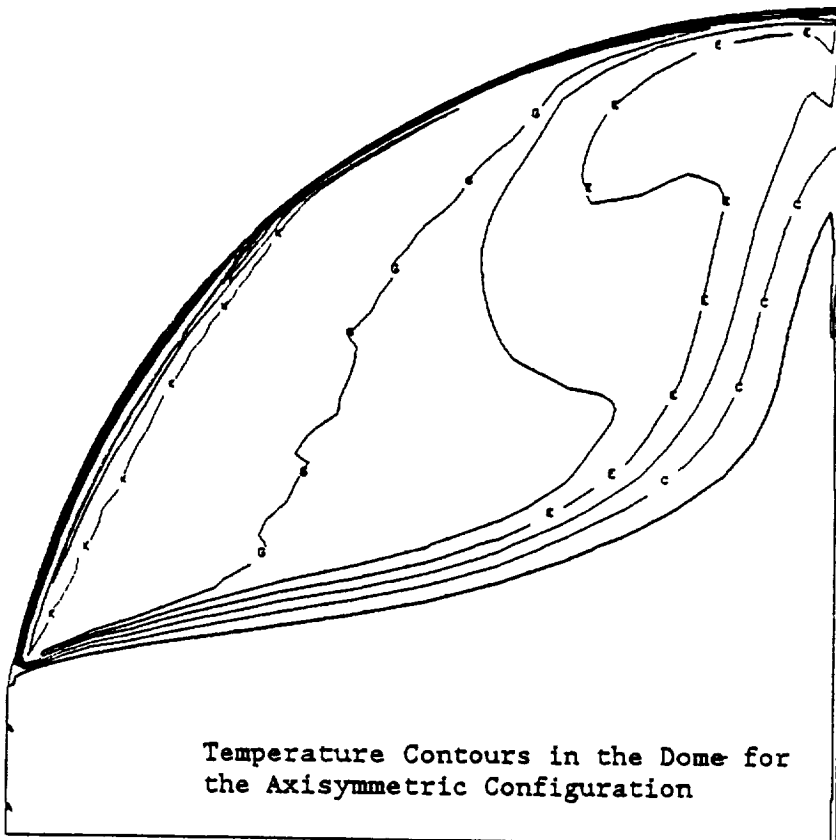

Temperature Contours in the Dome for the Axisymmetric Configuration

XMIN -3 0722E+01  
 XMAX 4 7478E+00  
 YMIN -8 6249E-01  
 YMAX 3 5282E+01

PHIN 3 0000E+02  
 PRAX 4 2239E+03  
 DELT 3 0000E+02

CONTOUR LEVELS:

ID	VALUES
A	3 0000E+02
B	8 0000E+02
C	8 0000E+02
D	1 2000E+03
E	1 5000E+03
F	1 7000E+03
G	2 0000E+03

K 3 2000E+03  
 L 3 3000E+03  
 M 3 3000E+03  
 N 4 1000E+03

H2O mass fraction in the head-end region

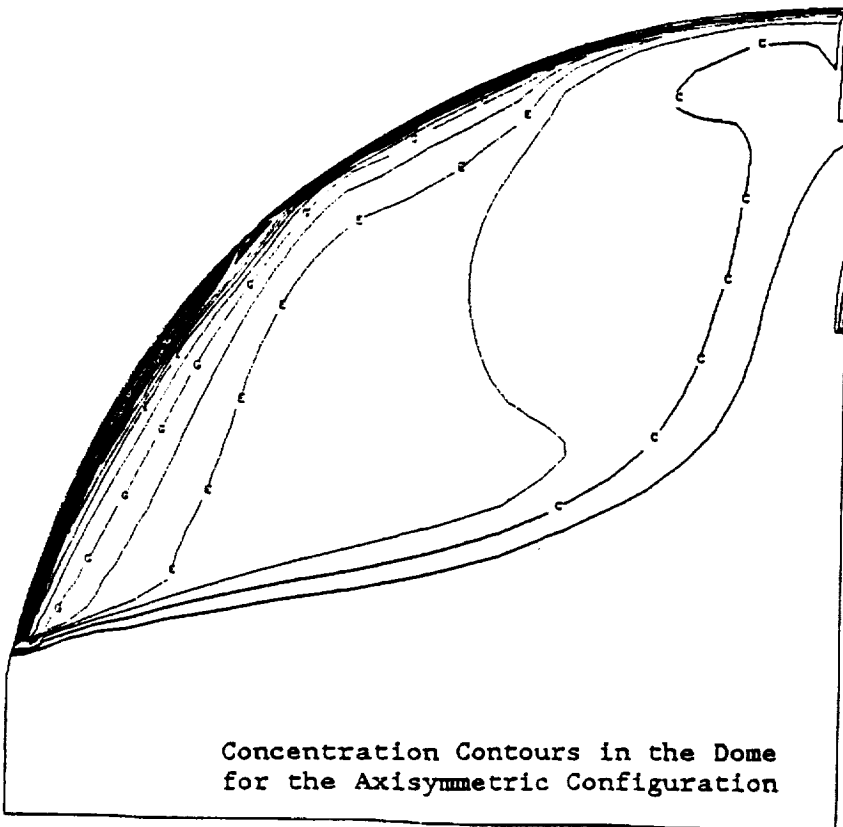

Concentration Contours in the Dome for the Axisymmetric Configuration

XMIN -3 0722E+01  
 XMAX 4 7478E+00  
 YMIN -8 6249E-01  
 YMAX 3 5282E+01

PHIN 0 0000E+00  
 PRAX 2 1017E+01  
 DELT 1 0000E+02

CONTOUR LEVELS:

ID	VALUES
A	0 0000E+00
B	1 0000E-02
C	1 8000E-02
D	2 3000E-02
E	3 3000E-02
F	4 3000E-02
G	5 3000E-02
H	7 0000E-02
I	7 0000E-02
J	9 0000E-02
K	9 0000E-02

P 1 4000E-01  
 Q 1 5000E-01  
 R 1 7000E-01  
 S 1 7000E-01  
 T 1 9000E-01  
 U 1 3000E-01  
 V 2 0000E-01

Temperature in the fuel port region (degree K)

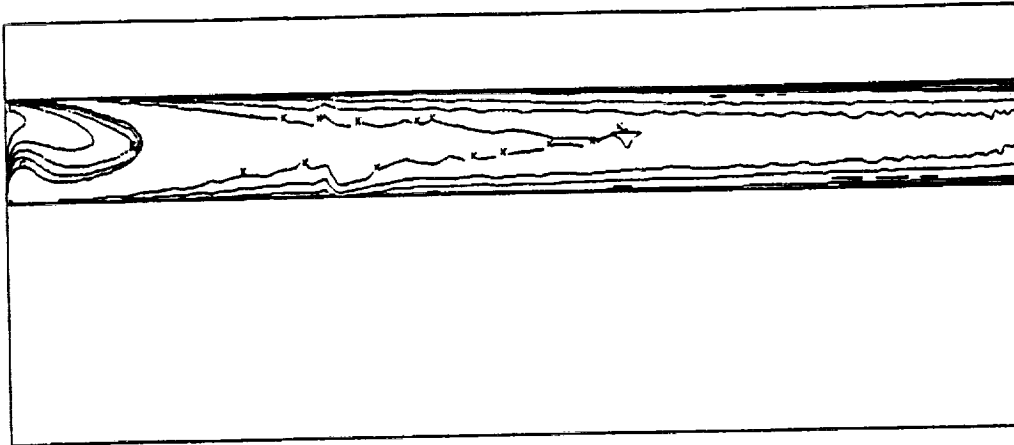

XMIN -7 72+9E+00  
 XMAX 3 1671E+02  
 YMIN -2 007+E+01  
 YMAX 5 657+E+01

PHIN 7 100+E+02  
 PRAX 4 2162E+03  
 DELP 3 0000E+02

CONTOUR LEVELS:

ID	VALUES
A	9.0000E+02
B	8.0000E+02
C	9.0000E+02
D	1.2000E+03
E	1.5000E+03
F	1.7500E+03
G	2.0500E+03

K	3.2500E+03
L	3.5500E+03
M	3.8000E+03
N	4.1500E+03

Temperature Contours in the Port for the Axisymmetric Configuration

H2O mass fraction in the fuel port region

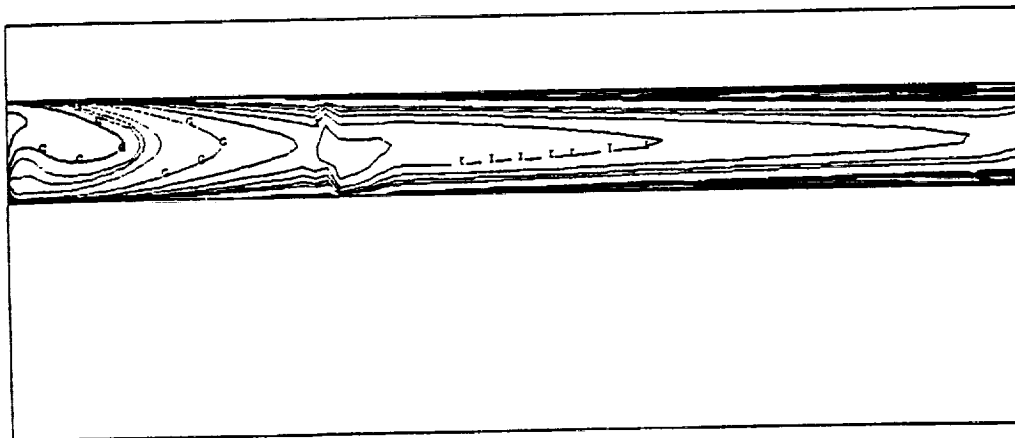

XMIN -7 72+9E+00  
 XMAX 3 1671E+02  
 YMIN -2 007+E+01  
 YMAX 5 657+E+01

PHIN 0 0000E+00  
 PRAX 2 2200E+01  
 DELP 1 0000E+02

CONTOUR LEVELS:

ID	VALUES
A	0.0000E+00
B	1.0000E-02
C	1.0000E-02
D	2.3999E-02
E	3.3999E-02
F	4.3999E-02
G	5.9399E-02
H	7.0000E-02
I	7.9399E-02
J	9.0000E-02
K	9.9399E-02

Q	1.5000E+01
R	1.7000E+01
S	1.7000E+01
T	1.9000E+01
U	1.9000E+01
V	2.0000E+01
W	2.2000E+01

Concentration Contours in the Port for the Axisymmetric Configuration

Temperature in the nozzle region (degree K)

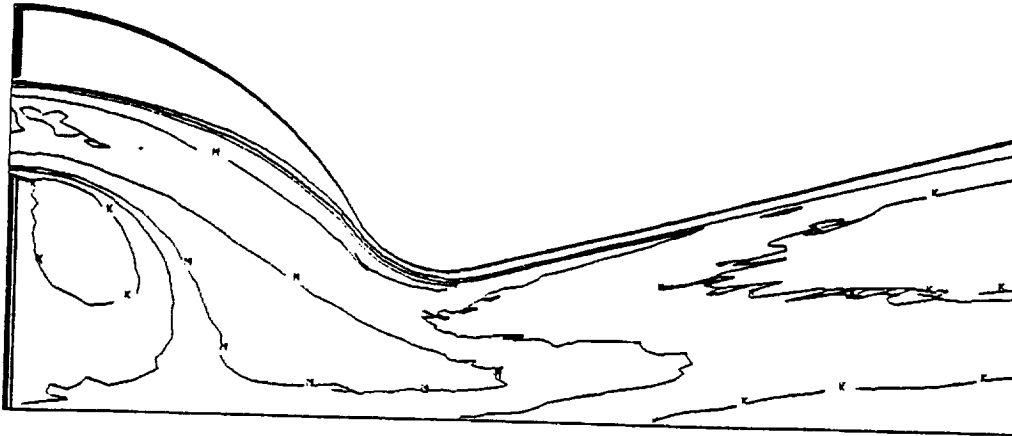

XMIN 3.0872E+02  
 XMAX 4.0239E+02  
 YMIN -2.1814E+01  
 YMAX 5.0114E+01

FMIN 8.1999E+02  
 FMAX 4.1984E+03  
 DELP 3.0000E+02

CONTOUR LEVELS:

ID	VALUES
A	3.0000E+02
B	8.0000E+02
C	9.0000E+02
D	1.2000E+03
E	1.5000E+03
F	1.7999E+03
G	2.0999E+03

K	3.2999E+03
L	3.5999E+03
M	3.9000E+03
N	4.1999E+03

Temperature Contours in the Nozzle for the Axisymmetric Configuration

H2O mass fraction in the nozzle region

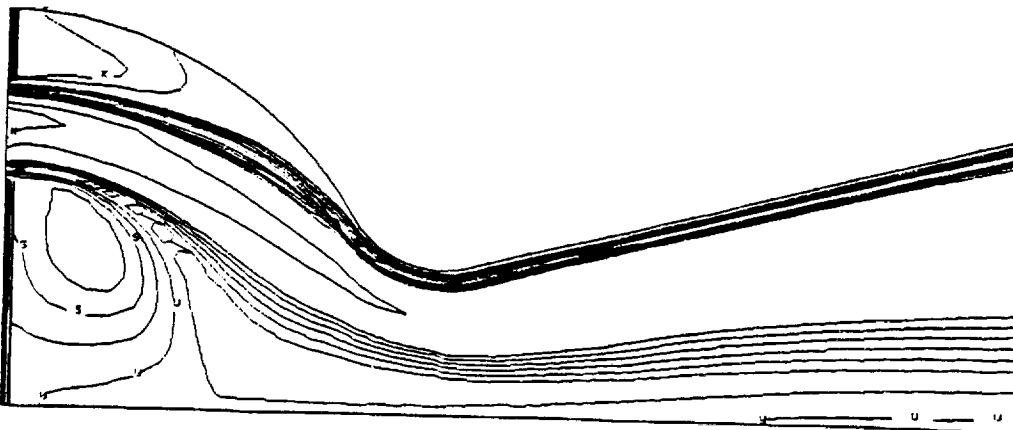

XMIN 3.0872E+02  
 XMAX 4.0239E+02  
 YMIN -2.1814E+01  
 YMAX 5.0114E+01

FMIN 0.0000E+00  
 FMAX 2.2170E-01  
 DELP 1.0000E-02

CONTOUR LEVELS

ID	VALUES
A	0.0000E+00
B	1.0000E-02
C	1.9099E-02
D	2.9999E-02
E	3.9999E-02
F	4.9999E-02
G	5.9999E-02
H	7.0000E-02
I	7.9999E-02
J	9.0000E-02
K	9.9999E-02

Q	1.9999E-01
R	1.7000E-01
S	1.7999E-01
T	1.9000E-01
U	1.9999E-01
V	2.9999E-01
W	2.2000E-01

Concentration Contours in the Nozzle for the Axisymmetric Configuration

Velocity vectors in the head-end region

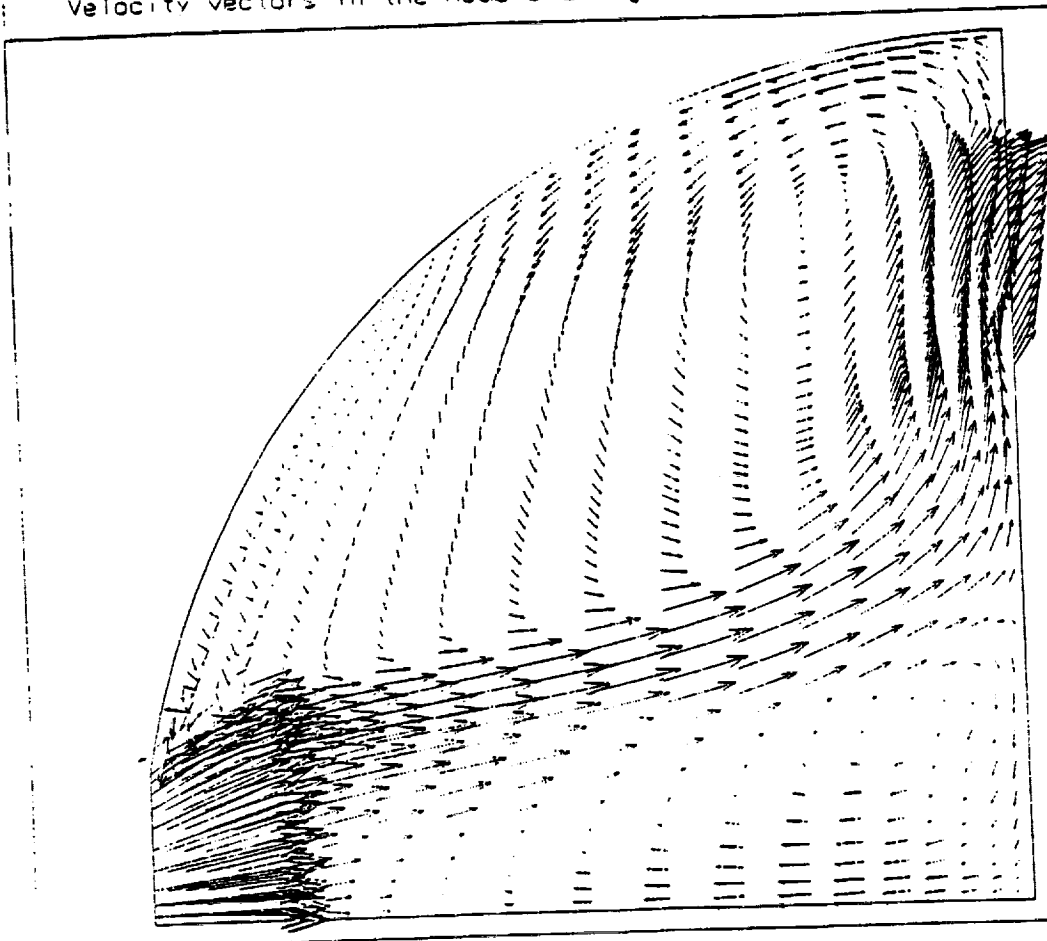

XMIN -3 8722E-01  
XMAX 4 7478E+00  
YMIN -8 8249E-01  
YMAX 3 5382E-01

Velocity Vectors in the Heat - End of the Axisymmetric Configuration



Axial velocity contours in the fuel part

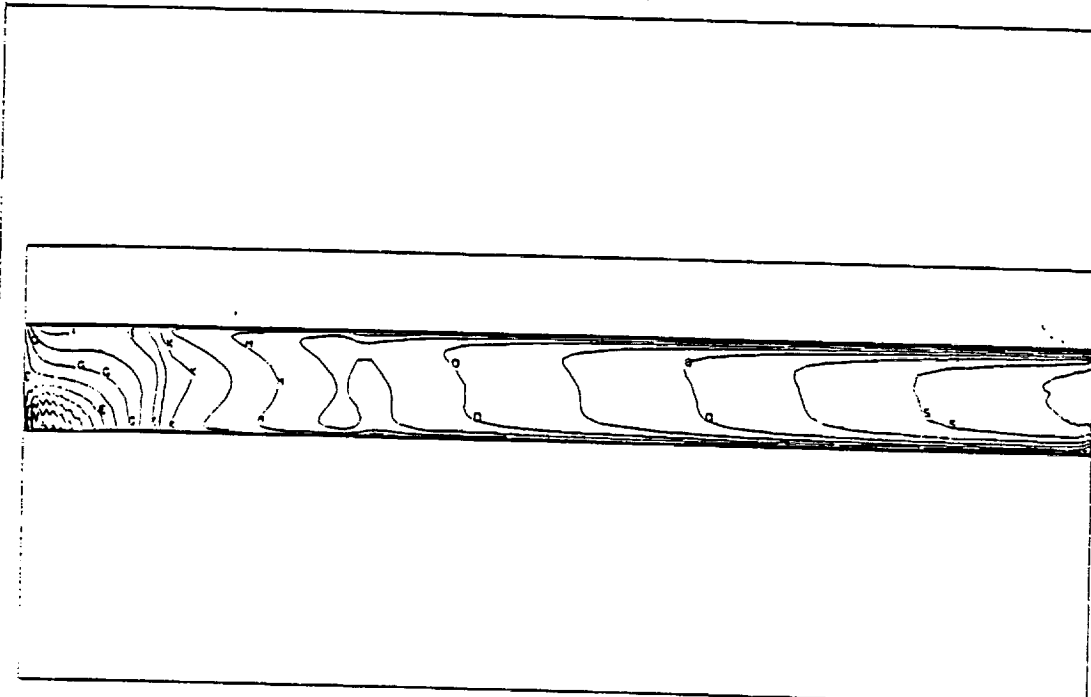

XMIN -7 7249E-06  
 XMAX 3 1672E-02  
 YMIN -2 9074E-01  
 YMAX 5 6574E-01  
 ZMIN -1 9101E-01  
 ZMAX 1 9237E-02  
 DELT 9 9355E-00

CONTOUR LEVELS

ID	VALUES
A	-1 5565E-01
B	-6 6263E-00
C	3 3131E+00
D	1 3252E-01
E	2 3192E-01
F	3 3131E-01
G	4 3071E-01
H	5 3010E-01
I	6 2950E-01
J	7 2889E-01
K	8 2829E-01
L	9 2768E-01
M	1 2708E-01
N	1 2648E-01
O	1 2588E-01
P	1 2528E-01
Q	1 2468E-01
R	1 2408E-01
S	1 2348E-01
T	1 2288E-01
U	1 2228E-01

Axial Velocity Contours in the Port of the Axisymmetric Configuration

Velocity vectors in the nozzle region

XMIN 3 3672E-02  
XMAX 4 9239E-02  
YMIN -2 1614E-01  
YMAX 5 8114E-01

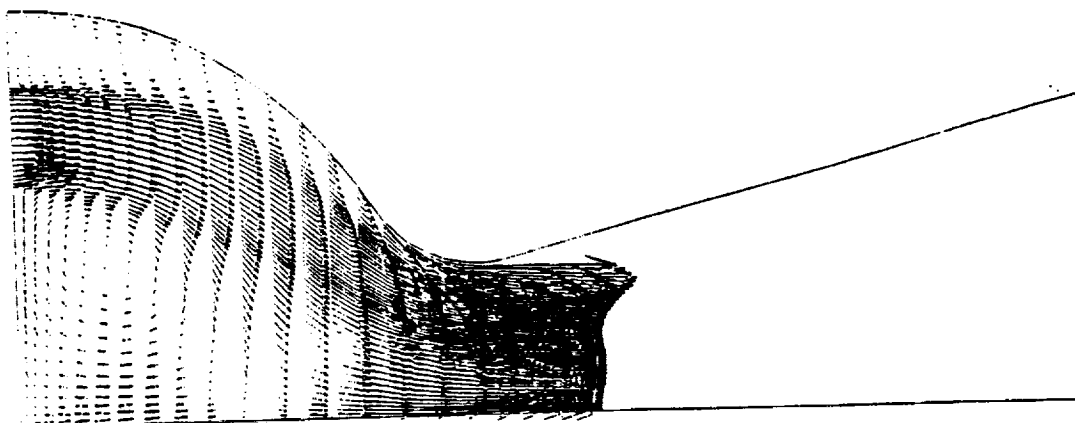

Velocity Vectors in the Aft-End of the Axisymmetric Configuration

ORIGINAL PAGE IS  
OF POOR QUALITY

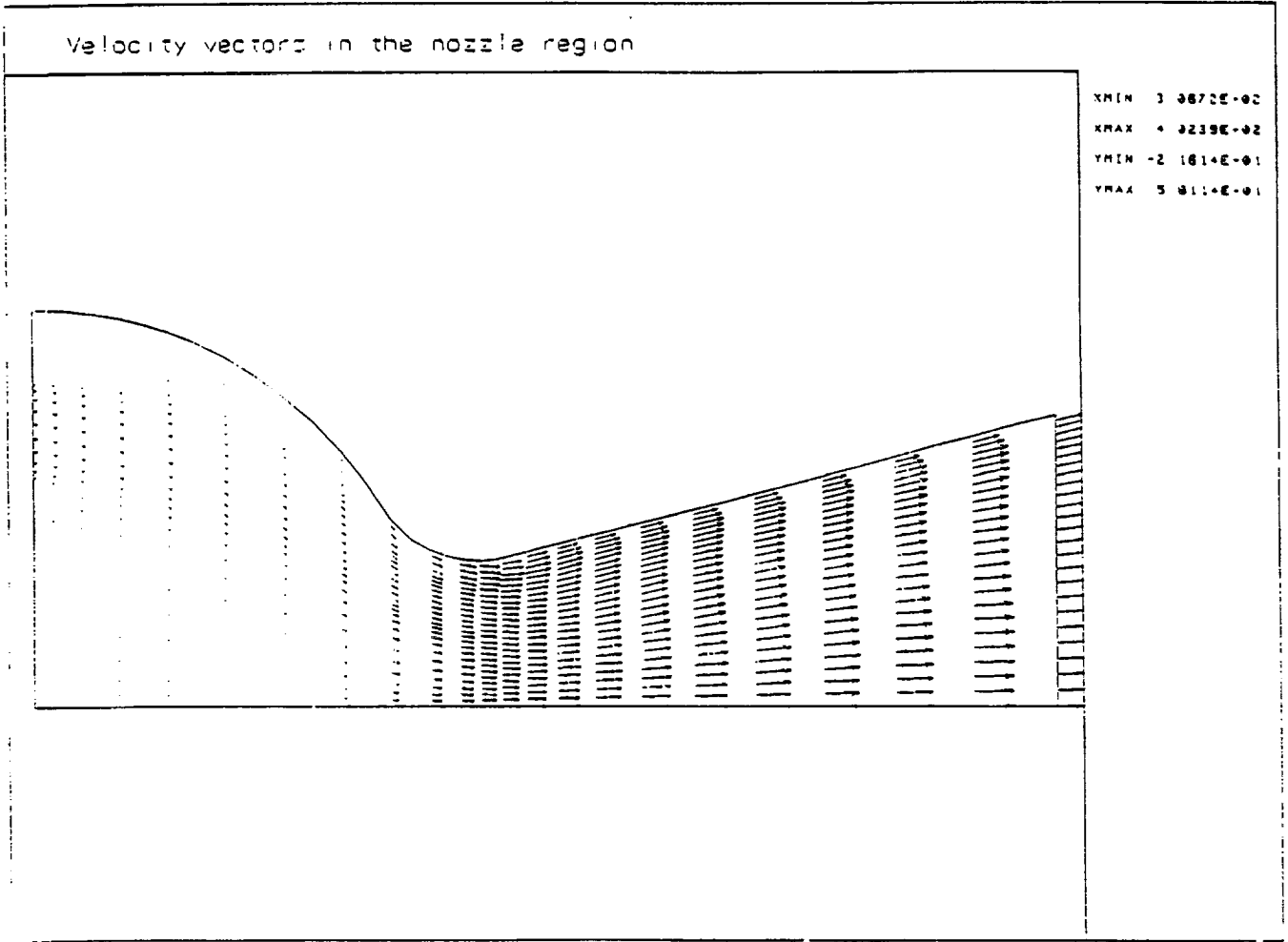

Velocity Vectors in the Nozzle of the Axisymmetric Configuration

## CONCLUSIONS

- Conjugate heat transfer of single injector elements is efficiently treated with the density based version of the FDNS code for any fluid state.
- Heat transfer to combustion chamber walls is accurately simulated with the FDNS code.
- The head-end, port, and aft sections of a hybrid motor are well simulated with respect to finite-rate combustion and turbulent mixing processes.