

GGOT TOTAL PRESSURE LOSS CONTROL CONCEPT EVALUATION ^{1995 117007}

R. F. BLUMENTHAL
AEROJET PROPULSION DIVISION
SACRAMENTO, CA

S15-34
~~43790~~ p. 38

Total pressure loss is one of the most important parameters in the design of a turbine. This parameter effects not only the turbine performance, but consequently the engine power balance and engine performance. Computational Fluid Dynamics (CFD) can be an effective tool in predicting turbine total pressure loss, and also for performing sensitivity studies to achieve an optimal design with respect to pressure loss. In the present study, the AEROVISC code was used to predict the total pressure loss in the Turbine Technology Team Gas Generator Oxidizer Turbine (GGOT).

The objectives in this study are two-fold. It is first necessary to determine an optimal methodology in predicting total pressure loss. The type of grid, grid density and distribution are parameters which may effect the loss prediction. Also, the effect of using a standard K- ϵ turbulence model with wall functions versus a two-layer turbulence model needs to be investigated. The use of grid embedding to resolve areas with high flow gradients needs to be explored. The second objective of the study is to apply the optimal methodology toward evaluating different tip leakage control concepts.

The approach taken in this study was as follows:

- 1) A nominal baseline case was run (baseline grid with standard wall functions)
 - a) Grid parametrics were performed on grid density
 - b) Grid embedding was applied to the rotor leading and trailing edges, and in the tip region.
 - c) Evaluation of a two-layer turbulence model (in progress)

Each of the above cases were assessed in terms of total pressure loss in comparison with the baseline case, and in terms of the difference in secondary flow resolution in comparison with the baseline case.

- 2) The optimal methodology from Step 1 is applied towards evaluating different tip leakage control concepts which will include
 - a) Hollow rotor
 - b) Hollow rotor with partitions (labyrinth seal approach)
 - c) Hollow rotor with partitions and suction-side rotor slots (to reduce fluid impingement angle)

As this work is still in progress, conclusions are not available at this time.



Propulsion Division

**GGOT TOTAL PRESSURE LOSS
CONTROL CONCEPT EVALUATION**

**R. F. BLUMENTHAL
AEROJET PROPULSION DIVISION**

APRIL 22, 1993

OXIDIZER TURBINE BASELINE DESIGN

Full Scale Turbine Flowpath

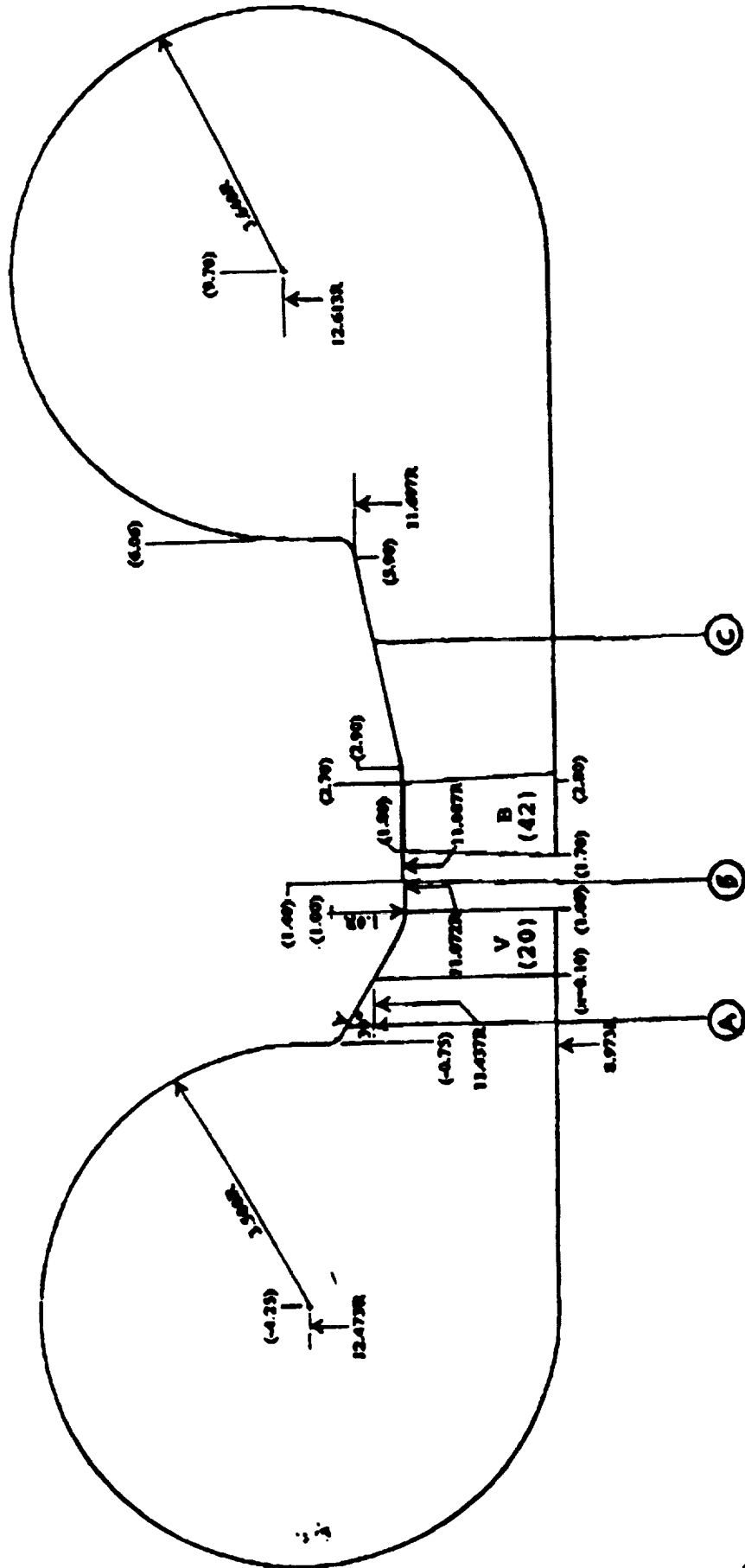

Axial Location - ()

① STATION LETTER

**GGOT TOTAL PRESSURE LOSS
CONTROL CONCEPT EVALUATION**

**OBJECTIVE : EVALUATE TIP LEAKAGE CONTROL CONCEPTS
WHICH REDUCE TIP LEAKAGE AND TOTAL PRESSURE
LOSS**

APPROACH : 1.) PERFORM GRID DEPENDENCY STUDY

**RUN NOMINAL BASELINE CASE WITH BASELINE GRID
USING AEROVISC CODE AND STANDARD LOG-LAW
WALL FUNCTION**

- a.) PERFORM GRID PARAMETERS ON GRID DENSITY
 - b.) EVALUATE MERITS OF GRID EMBEDDING
 - c.) EVALUATE TWO-LAYER TURBULENCE MODEL
- 2.) EVALUATE TIP TREATMENT CONCEPTS , INCORPORATING
OPTIMAL METHODOLOGY/PROCEDURE FROM STEP 1**

GGOT ROTOR CFD MODEL

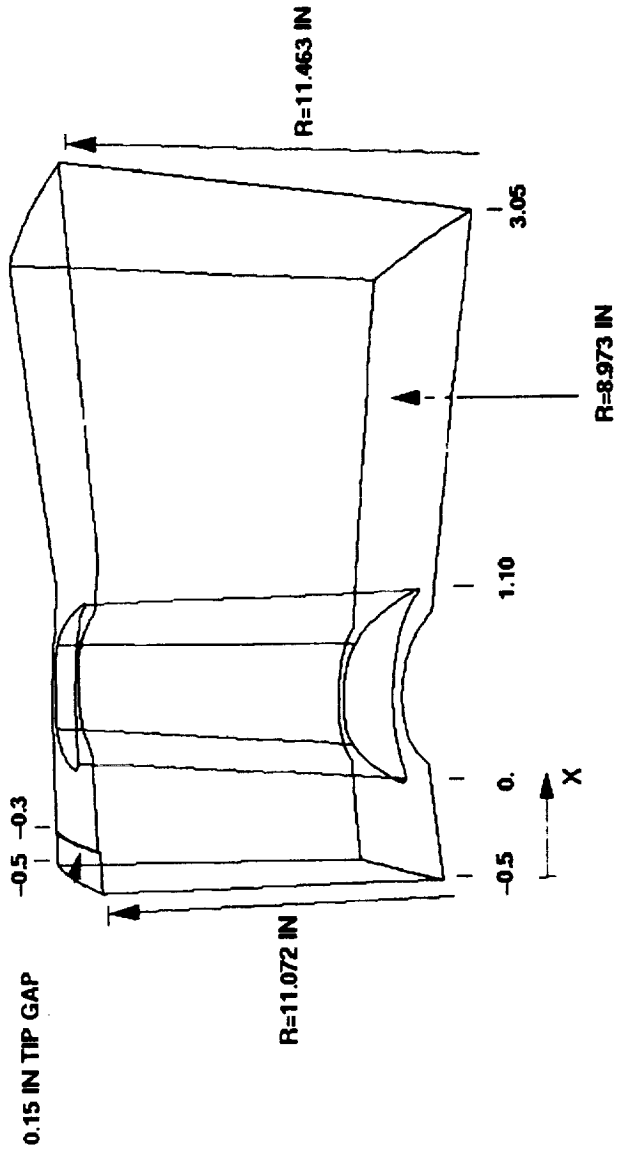

**GGOT TOTAL PRESSURE LOSS/
GRID DEPENDENCY STUDY**

APPLIED BOUNDARY CONDITIONS

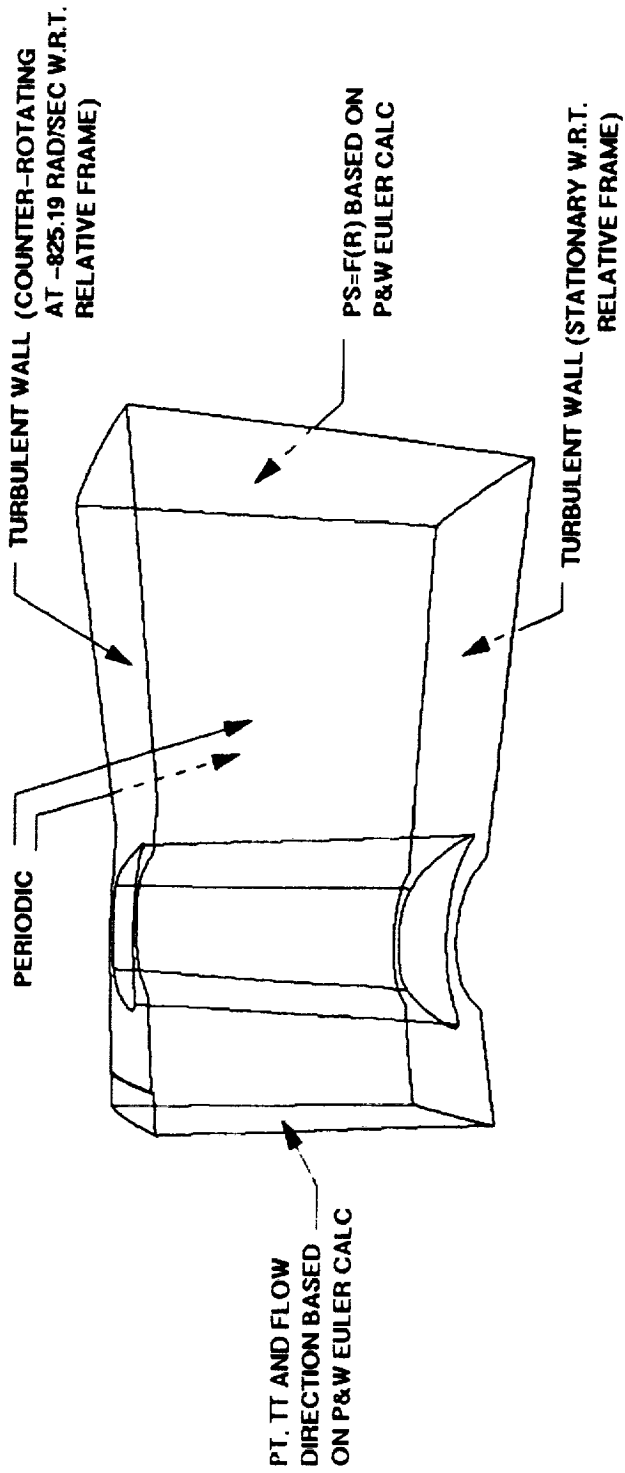

GGOT TOTAL PRESSURE LOSS/
GRID DEPENDENCY STUDY

GRID PARAMETRIC APPROACH AND RESULTS

- BASELINE GGOT ROTOR GRID (82 x 41 x 24 w/ 5 GRIDS IN TIP GAP RADIAL DIRECTION)
- GRID PARAMETERICS PERFORMED BY INCREASING GRID COUNT UNIFORMLY IN EACH PARAMETRIC DIRECTION (AXIAL, CIRCUMFERENTIAL, RADIAL). THREE CASES IN EACH DIRECTION WERE RUN, FOR A TOTAL OF TEN CASES (INCLUDING THE BASELINE).
- ALL CASES WERE RUN UNTIL A SIMILAR CONVERGENCE LEVEL WAS ACHIEVED

BASELINE ROTOR GRID

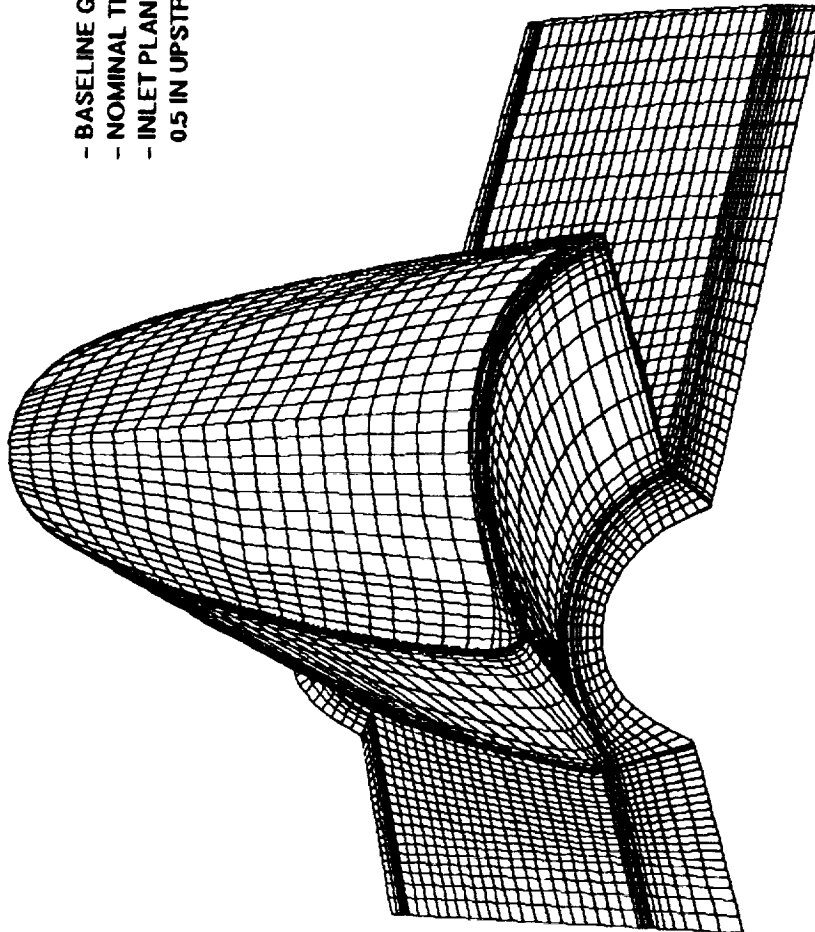

- BASELINE GRID (82 x 41 x 24)
- NOMINAL TIP GAP=0.015 IN
- INLET PLANE AXIAL LOCATION
0.5 IN UPSTREAM OF LEADING EDGE

GGOT TOTAL PRESSURE LOSS/
GRID DEPENDENCY STUDY

GRID PARAMETRIC APPROACH AND RESULTS

CASE	I-DIR	J-DIR	K-DIR	TIP GAP	TOTAL
BASELINE	82	41	24	5	80688
CASE 1A	106	41	24	5	104304
CASE 1B	131	41	24	5	128904
CASE 1C	237	41	24	5	233208
CASE 2A	82	53	24	5	104304
CASE 2B	82	67	24	5	131856
CASE 2C	82	120	24	5	236160
CASE 3A	82	41	34	6	100860
CASE 3B	82	41	34	7	121032
CASE 3C	82	41	72	13	242064

AXIAL DIR (I)

CIRCUM. DIR (J)

RADIAL DIR (K)



Propulsion Division

GGOT TOTAL PRESSURE LOSS/
GRID DEPENDENCY STUDY

GRID PARAMETRIC APPROACH AND RESULTS (PRELIMINARY)

CASE	PT REL (INLET) [PSI]	PT REL (EXIT) [PSI]	DPT REL [PSI]	PLOSS= DPT REL/PT REL (INLET)	PLOSS/ PLOSS BASE
BASE	457.498	365.800	91.698	0.2004	1.0000
CASE 1A	459.075	368.364	90.711	0.1976	0.9859
CASE 1B	459.446	368.627	90.819	0.1977	0.9862
CASE 2A	458.853	367.871	90.982	0.1983	0.9893
CASE 2B	458.978	367.607	91.371	0.1991	0.9912
CASE 3A	455.961	367.574	88.387	0.1939	0.9672
CASE 3B	456.026	367.613	88.413	0.1939	0.9673

NOTE: ALL PRESSURES ARE BASED ON MASS-AVERAGED VALUES

EXIT STATIC PRESSURE USED FOR PRELIMINARY PARAMETERS
BASED ON STATIC PRESSURE SPECIFIED AT ONE NODE IN EXIT PLANE
(PS=215.5 PSI AT CENTER OF EXIT PLANE)

GGOT TOTAL PRESSURE LOSS/
GRID DEPENDENCY STUDY

GRID PARAMETRIC APPROACH AND RESULTS

CASE	PT REL (INLET) [PSI]	PT REL (EXIT) [PSI]	DPT REL [PSI]	PLOSS= DPT REL/PT REL (INLET)	PLOSS/ PLOSS BASE
BASE	456.352	375.839	80.513	0.1764	1.0000
CASE 1C	456.987	373.528	83.459	0.1826	1.0351
CASE 2C	456.788	375.805	80.983	0.1773	1.0051
CASE 3C	456.890	376.620	80.270	0.1757	0.9960

NOTE: ALL PRESSURES ARE BASED ON MASS-AVERAGED VALUES
EXIT STATIC PRESSURE BASED ON RADIAL PRESSURE DISTRIBUTION
PROVIDED BY P&W FROM EULER CALC

**BASELINE RESULTS
VELOCITIES IN MID-GAP REGION (K=22)
HIGH TIP FLOW VELOCITIES COUPLED WITH LARGE IMPINGEMENT
ANGLE INFLUENCE MAINSTREAM FLOW AT SOME DISTANCE
DOWNSTREAM OF ROTOR**

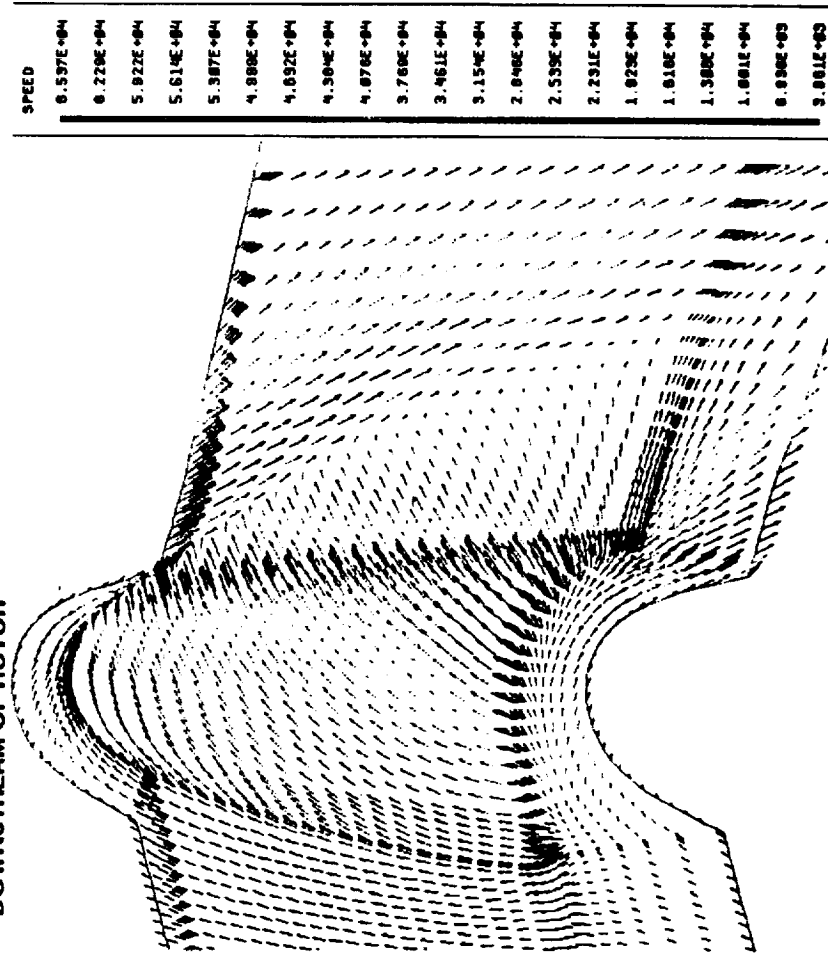

**STREAKLINES AT TIP SHOW DEVELOPING PASSAGE VORTEX
(PARTICLES RELEASED IN MID-GAP REGION)**

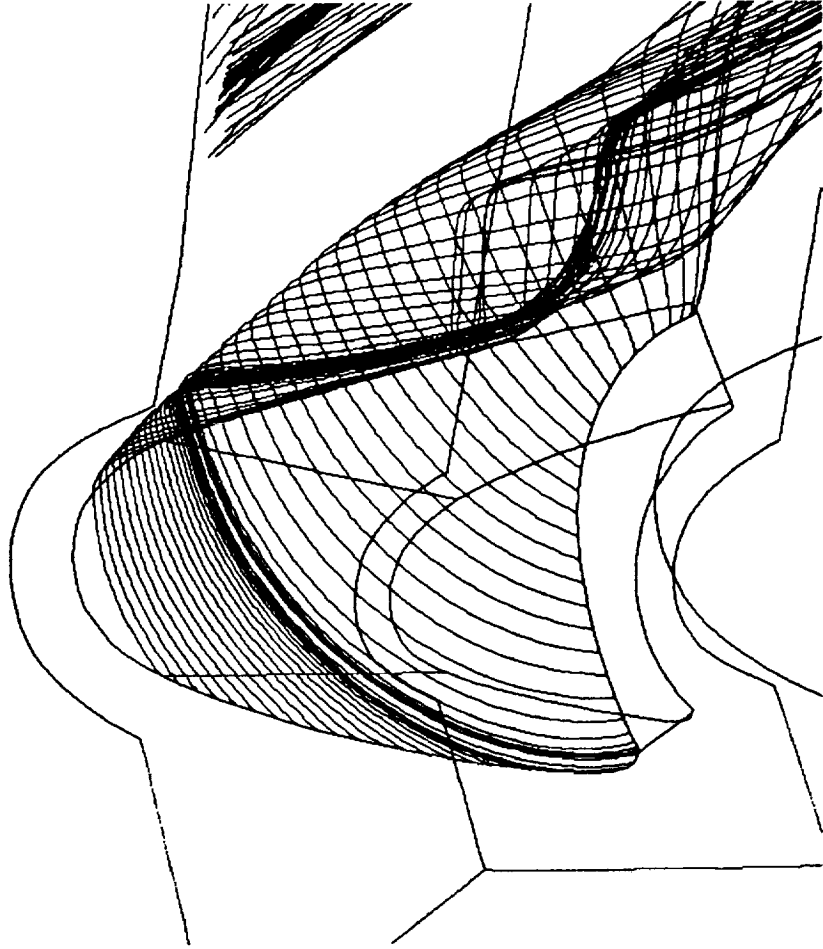

BASELINE RESULTS

**RELATIVE TOTAL PRESSURE LOSS DUE TO TIP GAP FLOW
HIGH LOSS GRADIENT EXISTS NEAR TIP**

PIR (PTOT REF (INLET AVT)) P101 REF (PTOT REF (INLET AVT))

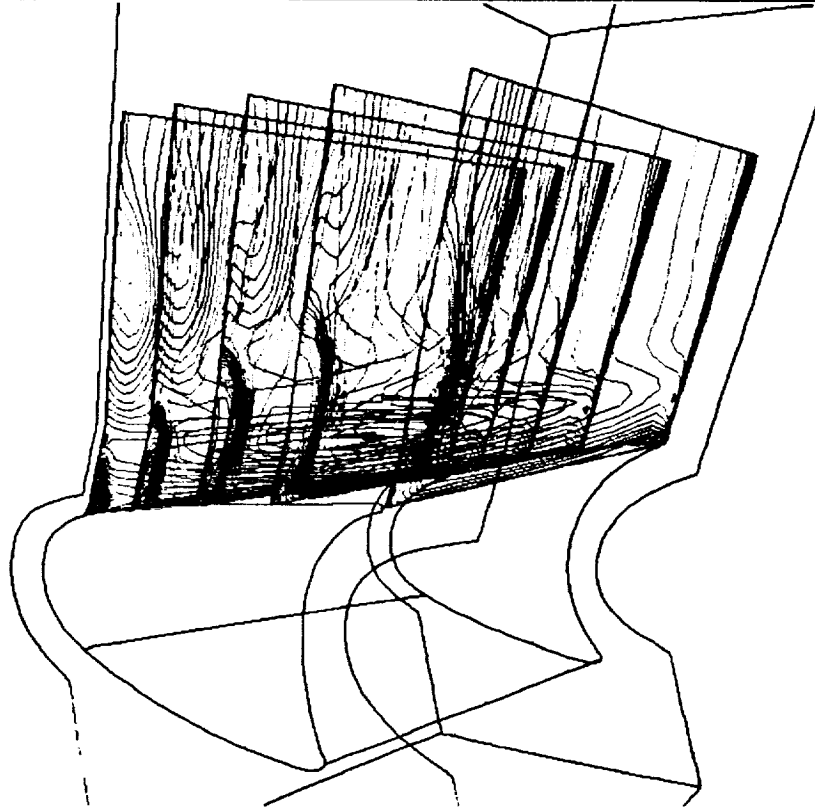

PTOT
7.338E-01
6.983E-01
6.597E-01
6.238E-01
5.864E-01
5.487E-01
5.131E-01
4.784E-01
4.398E-01
4.031E-01
3.685E-01
3.298E-01
2.932E-01
2.585E-01
2.199E-01
1.832E-01
1.486E-01
1.099E-01
7.338E-02
3.685E-02
0.000E+00

BASELINE RESULTS

VELOCITY CONTOURS SHOW EFFECT OF TIP LEAKAGE ON MAINSTREAM FLOW
CONSIDERABLE FLOW DECELERATION OCCURS

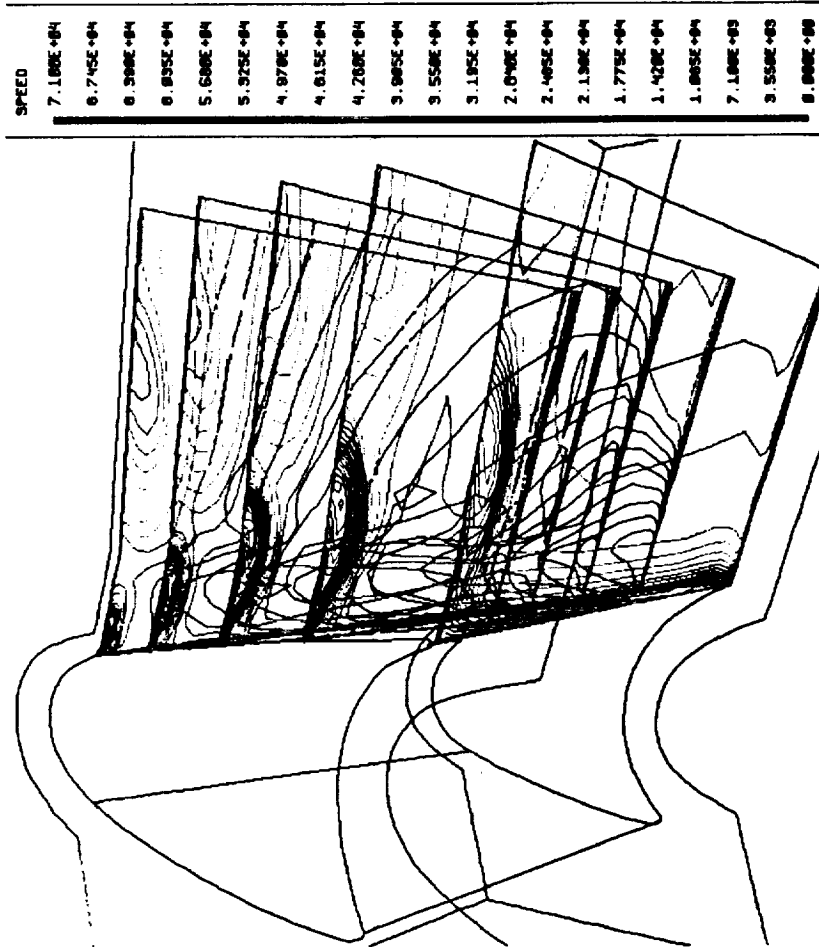

LEADING EDGE EMBEDDING - (31 x 25 x 70)
(EMBEDDED GRIDS EXTEND FROM HUB TO TIP ENDWALL)

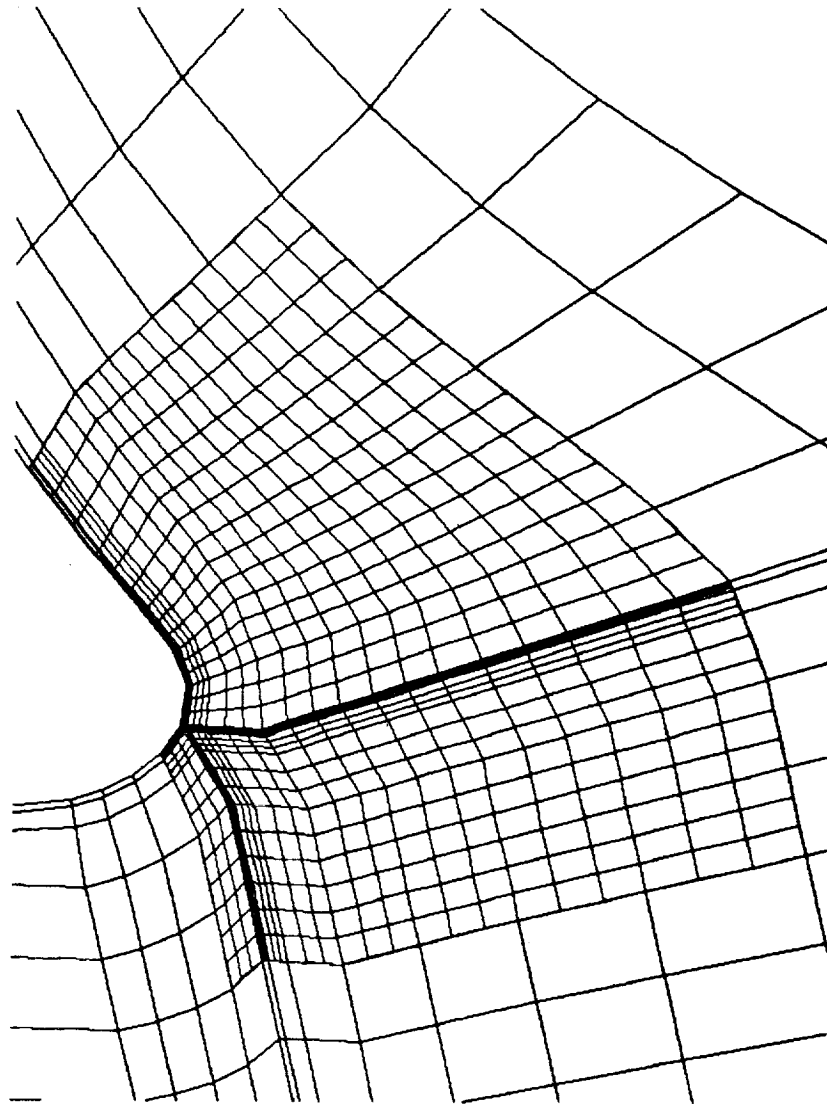

GGOT TOTAL PRESSURE LOSS/
GRID DEPENDENCY STUDY

GRID EMBEDDING AT TRAILING EDGE (22 x 43 x 70)
(EMBEDDED GRIDS EXTEND FROM HUB TO TIP ENDWALL)

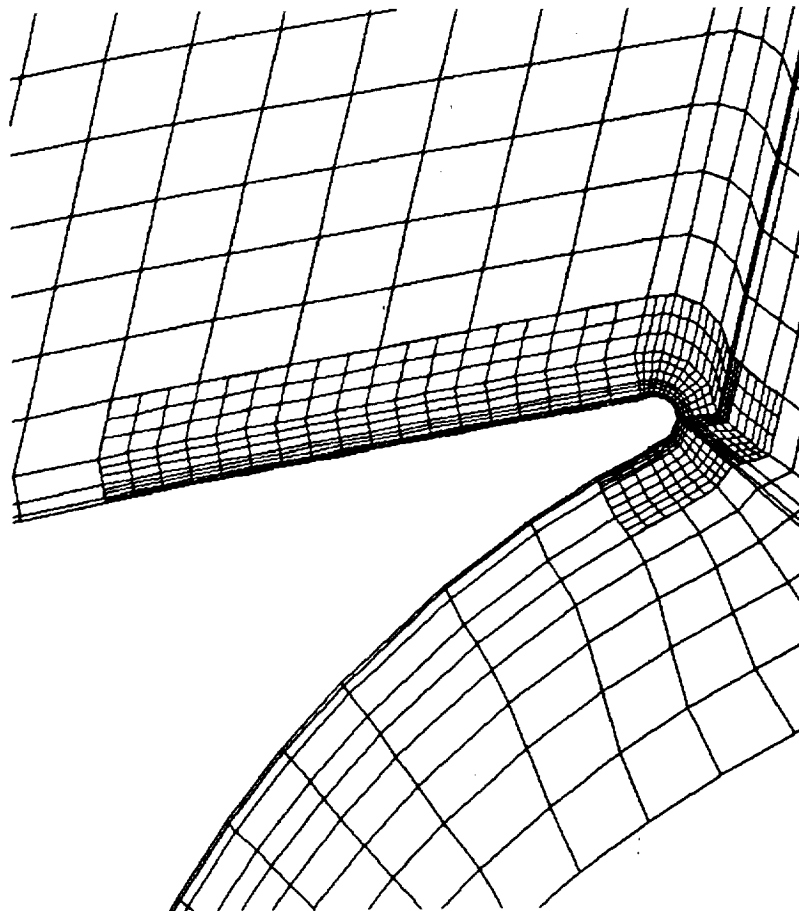

**GGOT TOTAL PRESSURE LOSS/
GRID DEPENDENCY STUDY**

**GRID EMBEDDING IN THE TIP GAP REGION (103 x 91 x 13)
(EMBEDDED GRIDS EXTEND FROM ROTOR TIP TO ENDWALL)**

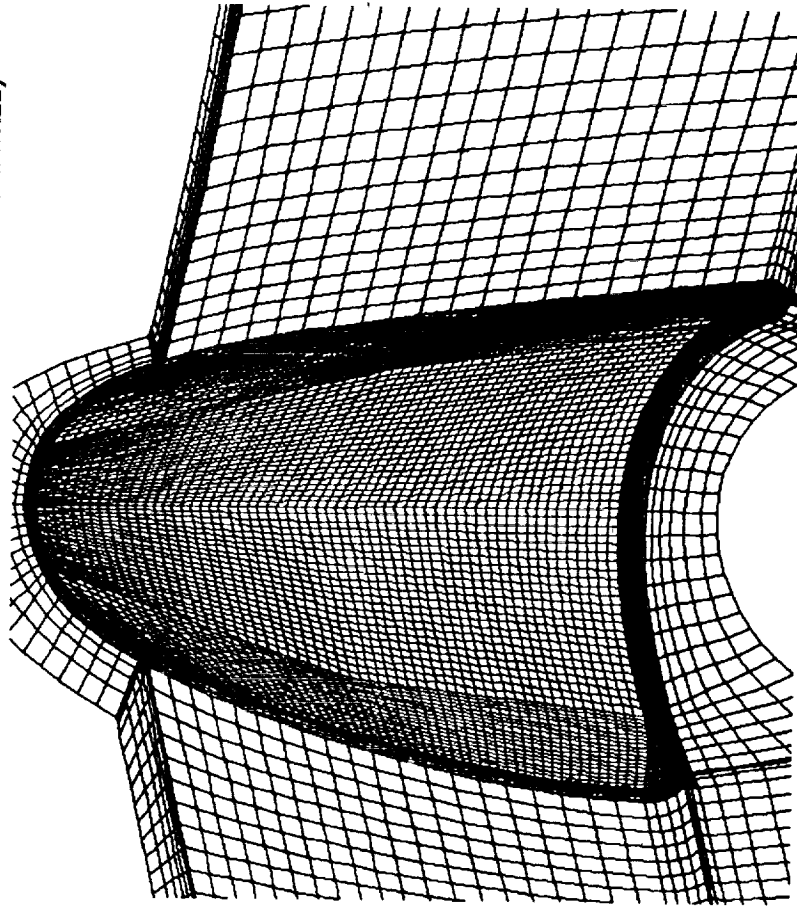

**GGOT TOTAL PRESSURE LOSS/
GRID DEPENDENCY STUDY**

**BASELINE GRID STREAKLINES NEAR LEADING EDGE (K=2)
GRID LACKS RESOLUTION NEEDED TO RESOLVE SADDLEPOINT**

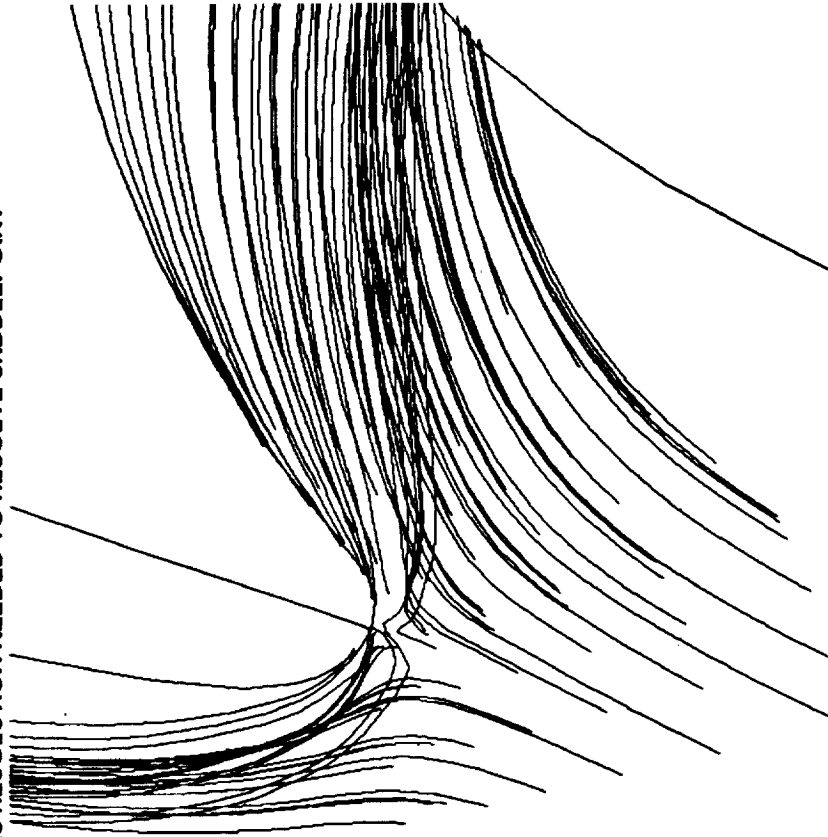

GGOT TOTAL PRESSURE LOSS/
GRID DEPENDENCY STUDY

GRID EMBEDDING AT LEADING EDGE IS USEFUL IN DEFINING IMPORTANT FLOW
FEATURES SUCH AS THE SADDLEPOINT OF THE LIMITING STREAMLINES AT THE HUB

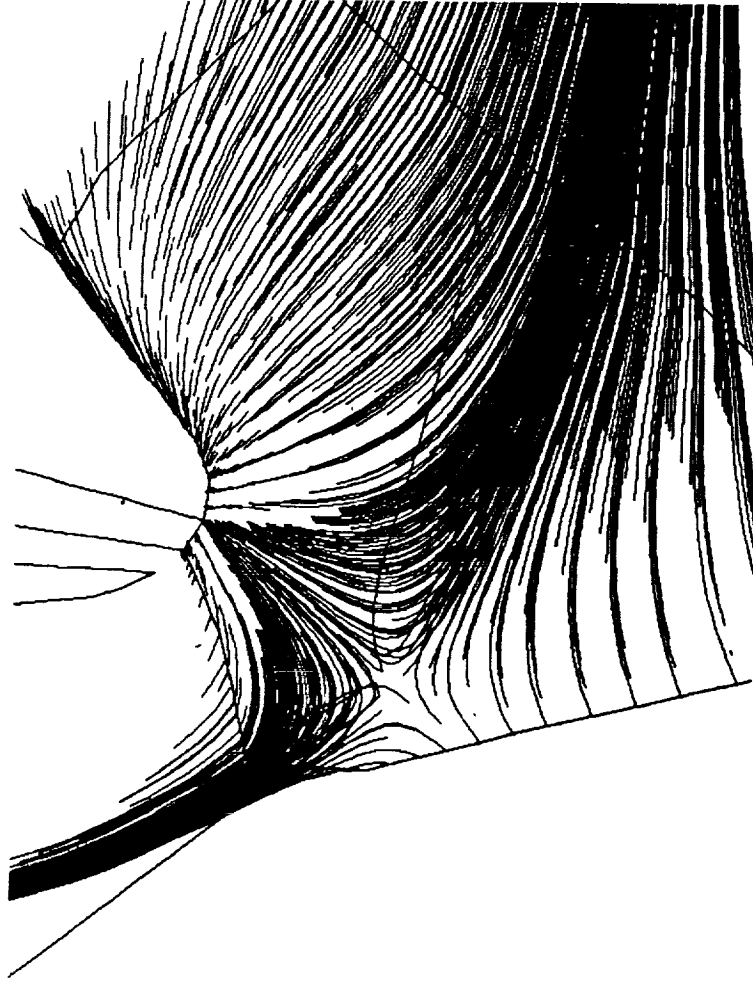

**GGOT TOTAL PRESSURE LOSS/
GRID DEPENDENCY STUDY**

BASELINE RESULTS (PRELIMINARY)
RELATIVE TOTAL PRESSURE LOSS AT MIDGAP (K=22)
PTR=[PT_REL(IN AVE) - PT_REL]PT_REL(IN AVE)

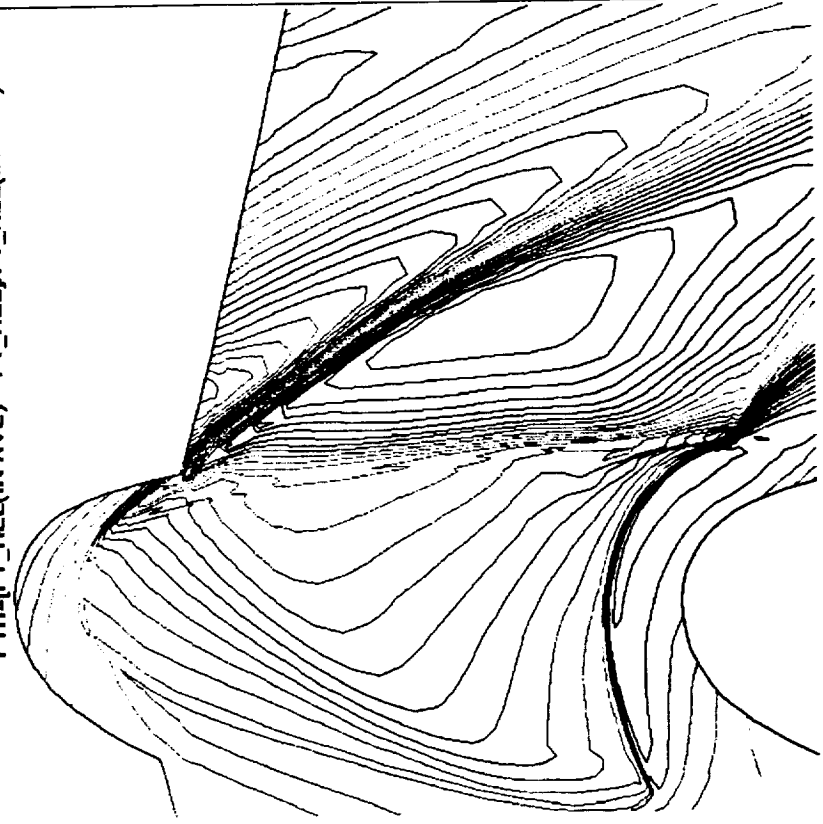

PTR
5.010E-01
6.393E-01
5.057E-01
4.780E-01
4.504E-01
4.227E-01
3.951E-01
3.675E-01
3.398E-01
3.122E-01
2.845E-01
2.569E-01
2.292E-01
2.016E-01
1.740E-01
1.463E-01
1.187E-01
9.100E-02
6.344E-02
3.588E-02
8.104E-03

**GGOT TOTAL PRESSURE LOSS/
GRID DEPENDENCY STUDY**

Propulsion Division

GRID EMBEDDING IN TIP GAP
RELATIVE TOTAL PRESSURE LOSS AT MIDGAP (K=22)
PTR=[PT_REL(IN AVE) - PT_REL]/PT_REL(IN AVE)

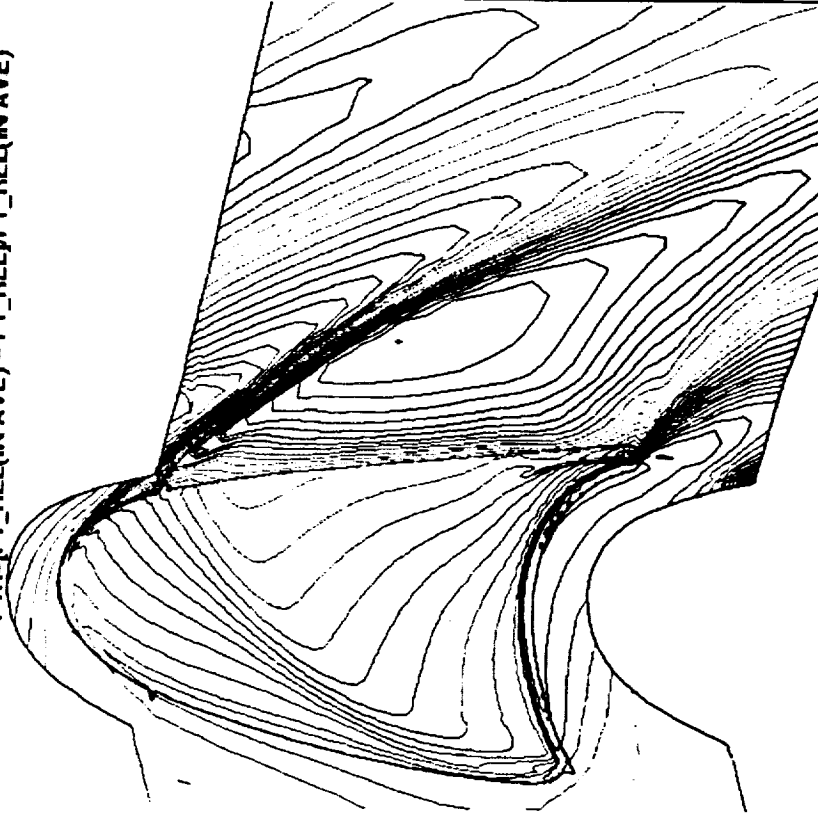

PTR
5.510E-01
5.236E-01
4.982E-01
4.688E-01
4.415E-01
4.141E-01
3.867E-01
3.594E-01
3.320E-01
3.046E-01
2.773E-01
2.499E-01
2.225E-01
1.952E-01
1.678E-01
1.404E-01
1.131E-01
8.574E-02
5.837E-02
3.100E-02
3.646E-03

**GGOT TOTAL PRESSURE LOSS/
GRID DEPENDENCY STUDY**

**TRAILING EDGE GRID EMBEDDING NEAR HUB PLANE (K=2)
EMBEDDING HELPS TO RESOLVE SUCTION SIDE RECIRC**

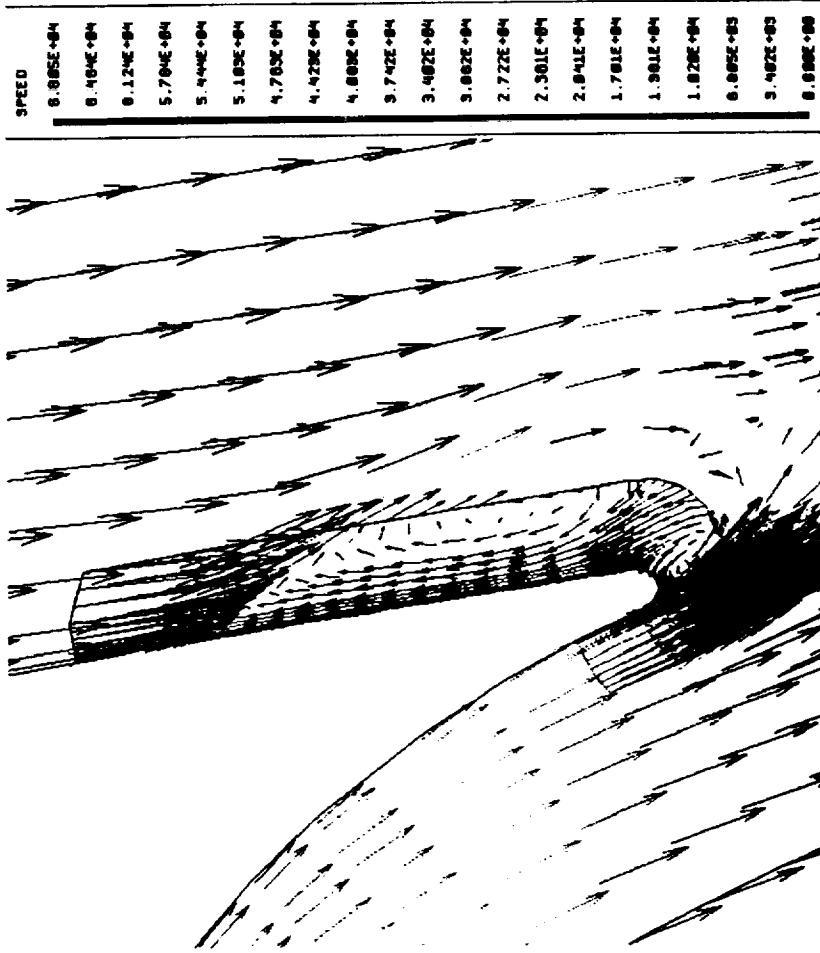

GGOT TOTAL PRESSURE LOSS/
GRID DEPENDENCY STUDY

BASELINE TRAILING EDGE GRID NEAR HUB PLANE (K=2)

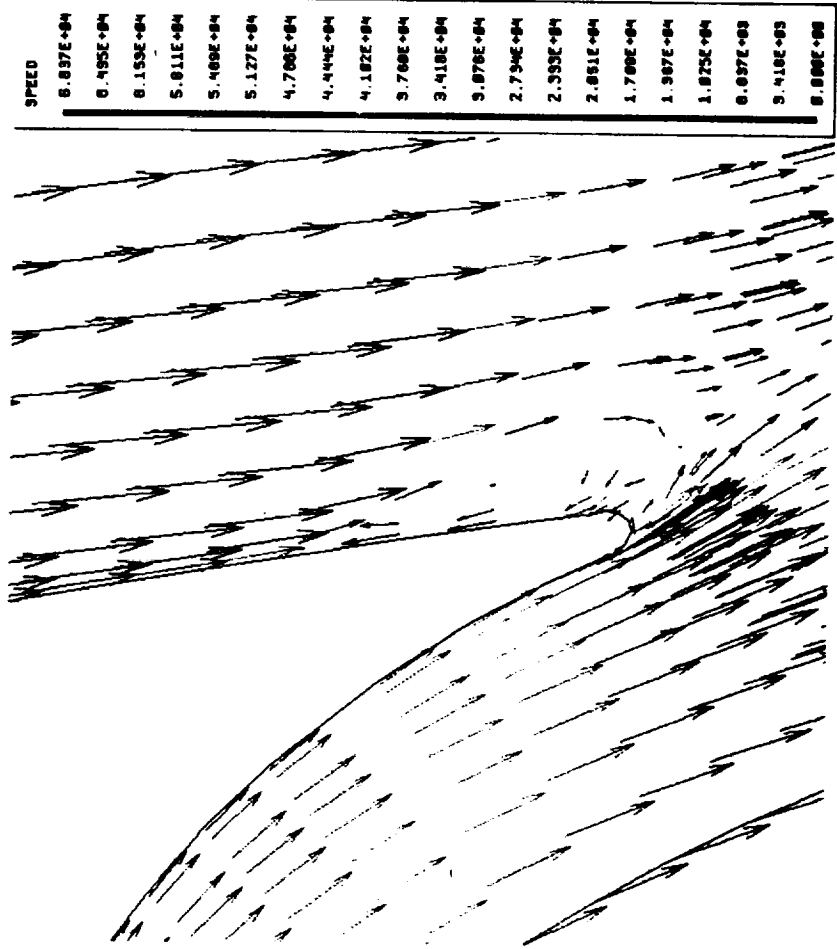

**GGOT TOTAL PRESSURE LOSS/
GRID DEPENDENCY STUDY**

GRID EMBEDDING RESULTS

CASE	PT REL (INLET) [PSI]	PT REL (EXIT) [PSI]	DPT REL [PSI]	PLOSS= DPT REL/PT REL (INLET)	PLOSS/ PLOSS BASE
BASE	457.498	365.800	91.698	0.2004	1.0000
LEADING EDGE	458.104	369.822	88.282	0.1927	0.9614
TIP GAP	458.554	370.401	88.152	0.1922	0.9589
TRAILING EDGE	458.292	369.162	89.130	0.1945	0.9704

**NOTE: ALL PRESSURES ARE BASED ON MASS-AVERAGED VALUES
EXIT STATIC PRESSURE USED FOR PRELIMINARY PARAMETERS
BASED ON STATIC PRESSURE SPECIFIED AT ONE NODE IN EXIT PLANE
(PS=215.5 PSI AT CENTER OF EXIT PLANE)**

TWO-LAYER TURBULENCE MODEL

RESULTS PRESENTED THUS FAR ARE BASED ON THE STANDARD K-E TURBULENCE MODEL WHICH EMPLOYS WALL FUNCTIONS TO MODEL THE VISCOUS NEAR-WALL LAYER. THE ADVANTAGE OF THIS APPROACH IS THAT THE WALL FUNCTION ELIMINATES THE NECESSITY OF NUMERICALLY RESOLVING THE LARGE GRADIENTS IN THE THIN NEAR-WALL REGION, THUS CONSERVING COMPUTER RESOURCES. THE DISADVANTAGE IS THAT CERTAIN ASSUMPTIONS MUST BE MADE WHICH MAY NOT BE ACCURATE IN ALL FLOW SITUATIONS, ESPECIALLY WHERE THERE ARE SEPERATED FLOWS.

THE TWO-LAYER TURBULENCE MODEL EMPLOYS THE STANDARD TWO-EQUATION K-E MODEL AWAY FROM THE NEAR WALL REGION, AND USES A ONE-EQUATION TURBULENCE MODEL IN THE NEAR-WALL REGION. IN ORDER TO CORRECTLY APPLY THE TWO-LAYER MODEL, NODES MUST BE CLUSTERED NEAR THE WALLS SUCH THAT THE DAMPING FUNCTIONS f_{μ} AND f_{ν} (USED TO CALCULATE TURBULENT VISCOSITY AND DISSIPATION RATE) CAN BE RESOLVED. IT IS RECOMMENDED THAT AT LEAST 5 NODES BE IN THE REGION $YPLUS < 5$ AND AT LEAST 15 NODES IN THE REGION $YPLUS < 100$.

STATUS: MODEL IS CURRENTLY RUNNING. CONVERGENCE DIFFICULTIES HAVE BEEN ENCOUNTERED, PROBABLY RELATED TO HIGH ASPECT RATIOS (~ 25000 AT BLADE SURFACE AT MID-SPAN). SOLUTIONS BEING EXAMINED INCLUDE INCREASING NODE COUNT IN RADIAL DIRECTION, RUNNING CODE IN DOUBLE PRECISION.

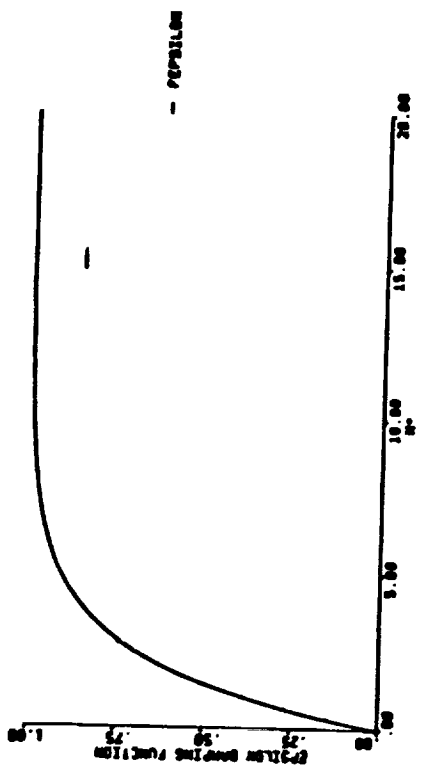

Figure 39: f_c versus n^+

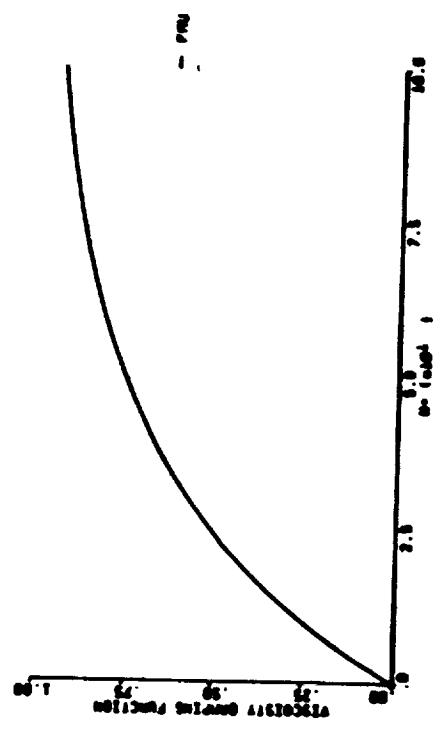

Figure 40: f_p versus n^+

TWO-LAYER TURBULENCE MODEL

USING BASELINE GRID, 15 NODES WERE ADDED BETWEEN THE WALL AND THE FIRST NODE AWAY. NODES ARE CLUSTERED SUCH THAT 5 NODES ARE WITHIN $YPLUS=5$ (ASSUMING $YPLUS$ VARIES LINEARLY AWAY FROM WALL.)

112 x 71 x 24 (190848 NODES)

LEADING EDGE (K=1)

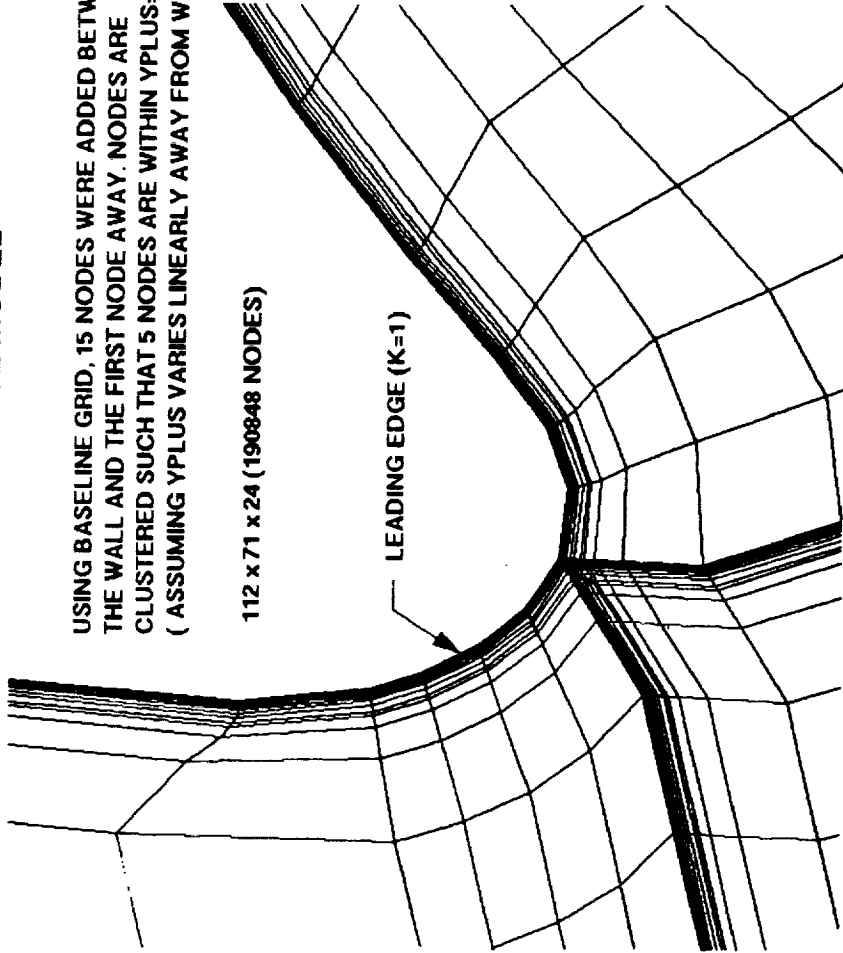

IN ORDER TO QUANTIFY THE BENEFITS OF POSSIBLE TIP TREATMENTS, THE BASELINE GRID WAS RUN AT ZERO GAP AND AT A MAXIMUM GAP OF 0.030 IN. THE NODE COUNT IN THE TIP GAP FOR THE MAX CLEARANCE CASE WAS INCREASED FROM 5 TO 11 FOR A GRID DIMENSION OF 82 x 41 x 30.

CASE	CLEARANCE [IN]	PLOSS	PLOSS/PLOSS NOM.
ZERO GAP	0.	0.1572	0.8912
NOM. GAP	0.015	0.1764	1.
MAX GAP	0.030	0.1810	1.0261

AS A RESULT OF THE GRID DEPENDENCY STUDY , THE AMOUNT OF VARIATION IN PRESSURE LOSS CALCULATED WAS +/- 4 % . IN ORDER TO ADEQUATELY ASSESS DIFFERENT TIP TREATMENTS, THE FOLLOWING PROCEDURES ARE SUGGESTED:

- 1.) SIMILAR GRIDS FOR ASSESSING TIP TREATMENTS SHOULD BE USED, WHEN POSSIBLE.
- 2.) TIP TREATMENT CASES SHOULD BE FIRST EVALUATED AT THE MAXIMUM GAP (0.030 IN) IN ORDER TO MAXIMIZE DIFFERENCES BETWEEN DIFFERENT TREATMENTS. GOOD TIP TREATMENT CANDIDATES WILL THEN BE ASSESSED AT THE NOMINAL CLEARANCE.

GIVEN THE RELATIVELY LARGE SURFACE AREA AT THE BLADE TIP, A PROMISING METHOD FOR REDUCING TIP LEAKAGE MAY BE TO CREATE A POCKETED SURFACE ON THE ROTOR TIP, SIMILAR TO A LABYRINTH SEAL.

IN ORDER TO DETERMINE THE SENSITIVE PARAMETERS INVOLVED, IT IS USEFUL TO EXAMINE A LABYRINTH SEAL FLOW EQUATION. THE FOLLOWING IS A METHOD PROPOSED BY VERMES (1961) WHICH IS A MODIFICATION OF MARTIN'S FORMULA FOR LABYRINTHS:

$$W = 5.76 \cdot K \cdot A \cdot P_O \cdot \text{BETA} / R \cdot \text{TO} \cdot (1 - \text{ALPHA})^{0.5}$$

W=WEIGHT FLOW [LB/SEC]
K = f(RE, L/C) - CLEARANCE FACTOR OF SINGLE ANNULAR ORIFICE
A=ANNULAR ORIFICE FLOW AREA [IN²]
P_O=UPSTREAM TOTAL PRESSURE [PSI]
T_O=UPSTREAM TOTAL TEMPERATURE [DEG R]
ALPHA=8.52/[(P-L)/C+7.23] - RESIDUAL ENERGY FACTOR
P=DISTANCE BETWEEN TEETH [IN]
L=TOOTH TIP WIDTH [IN]
C=CLEARANCE [IN]
BETA={1-(PN/PO)²}/[N-LN(PN/PO)]^{0.5} - GLAND FACTOR
PN=STATIC PRESSURE AT EXIT OF LAST TOOTH [PSI]
N=NUMBER OF TEETH
R=GAS CONSTANT FT/DEG R

GGOT TIP TREATMENT EVALUATION
STUDY

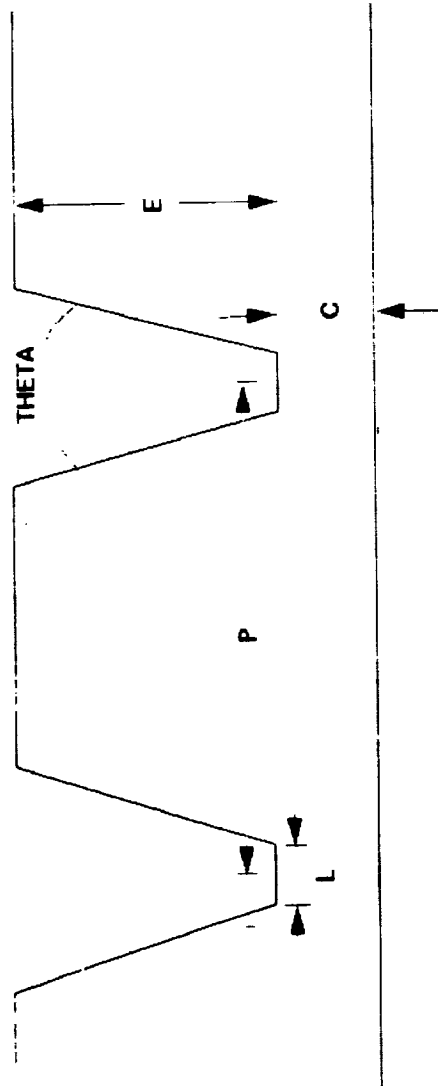

LABYRINTH GEOMETRY DEFINITION



GGOT TIP TREATMENT EVALUATION STUDY Propulsion Division

ASSUMING PRESSURES, TEMPERATURES, SEAL CLEARANCE AND TOTAL SEAL LENGTH ARE DEFINED, THE REMAINING DESIGN PARAMETERS ARE NUMBER OF TEETH AND TOOTH WIDTH. ASSUMING MINIMUM TOOTH WIDTH (DETERMINED BASED ON STRUCTURAL REQUIREMENTS), THE ONLY REMAINING PARAMETER WHICH MAY BE MODIFIED IS THE NUMBER OF TEETH

THE VERMES FORMULA MAY BE HELPFUL IN TERMS OF A 1-D APPROACH IN DETERMINING THE APPROXIMATE NUMBER OF TEETH NECESSARY AND THEIR LOCATION IN ORDER TO MINIMIZE TIP LEAKAGE AS APPLIED TO THE GGOT. DUE TO THE COMPLICATED NATURE OF THE FLOW IN THE TIP GAP WITH THE COUNTER-ROTATING ENDWALL RETARDING THE FLOW THROUGH THE GAP, THE VERMES FORMULA WOULD PROBABLY NOT BE VERY USEFUL IN PREDICTING THE ACTUAL TIP LEAKAGE.

AS AN EXAMPLE APPLIED TO THE GGOT, A TYPICAL STREAMLINE STARTING NEAR THE LEADING EDGE IS SELECTED FROM THE MAX CLEARANCE CASE. THE ASSUMED PARAMETERS ARE:

L=.030 IN C=.030 IN PO=419.5 PSI PN=197.8 TO=1261.2 LTOT=0.927 IN

Table with 6 columns: NTEETH, PITCH, ALPHA, BETA, MDOT (NORM.), and OPTIMAL TOOTH NUMBER. Row 4 is highlighted with an arrow pointing to the MDOT value 0.9597.

VALIDATION CASE FOR LABYRINTH SEAL BASED ON VERMES TEST DATA

FLUID: AIR

**L=0.015 IN
E=0.25 IN
P=0.25 IN
C=0.030 IN
R=5 IN
THETA=14 DEG
NTEETH=10**

**PO=73.5 PSI
TO=530 DEGR**

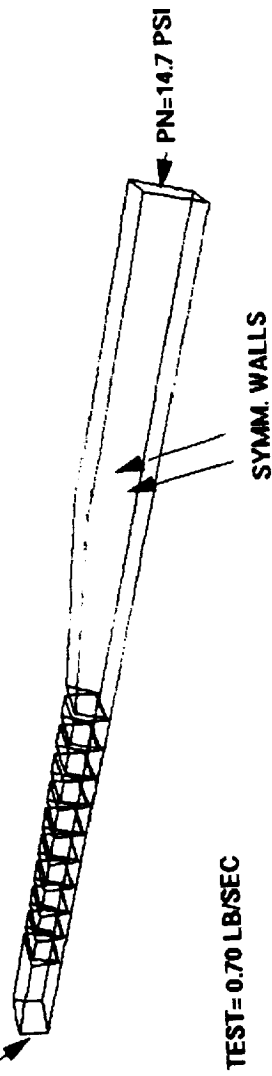

MDOT TEST = 0.70 LB/SEC

MDOT CFD = 0.91 LB/SEC

VALIDATION CASE FOR LABYRINTH SEAL BASED ON VERMES TEST DATA

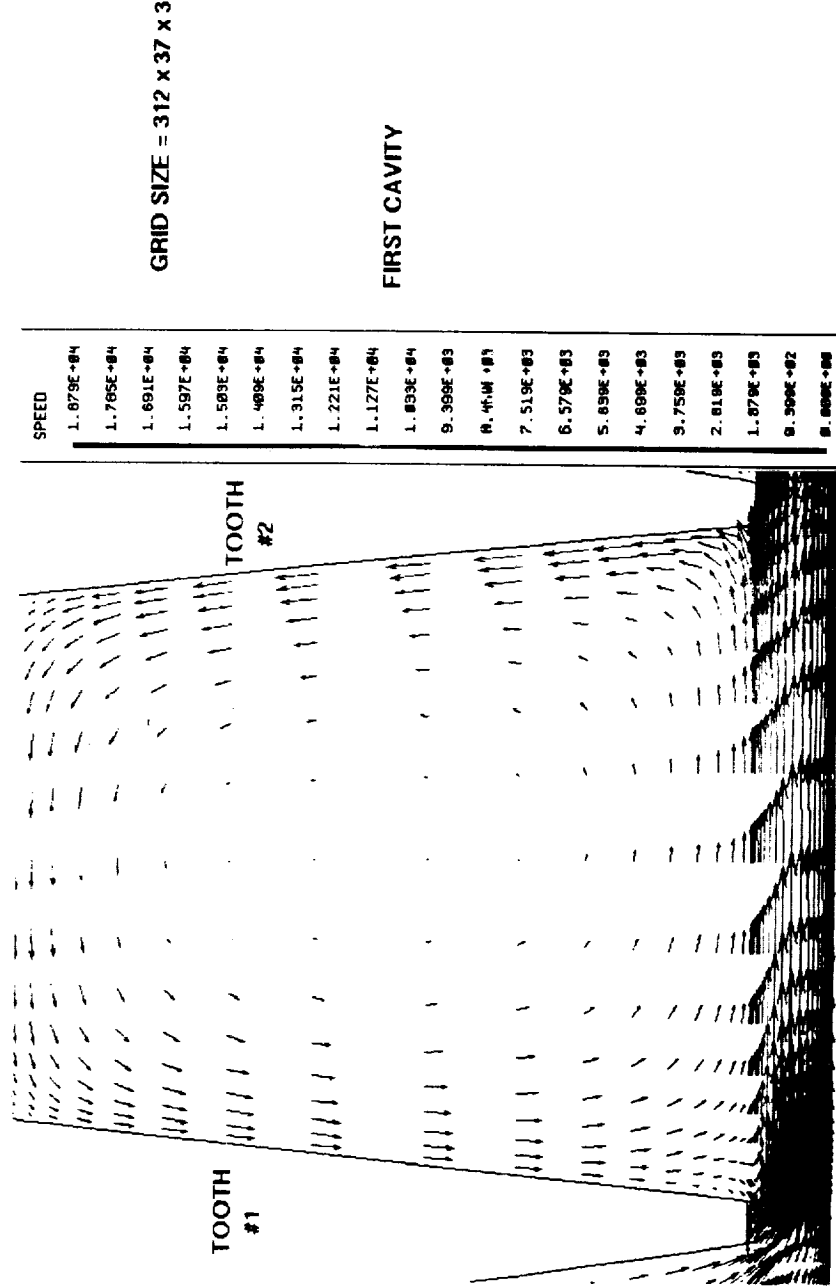

**GGOT TIP TREATMENT EVALUATION
STUDY**

VALIDATION CASE FOR LABYRINTH SEAL BASED ON VERMES TEST DATA

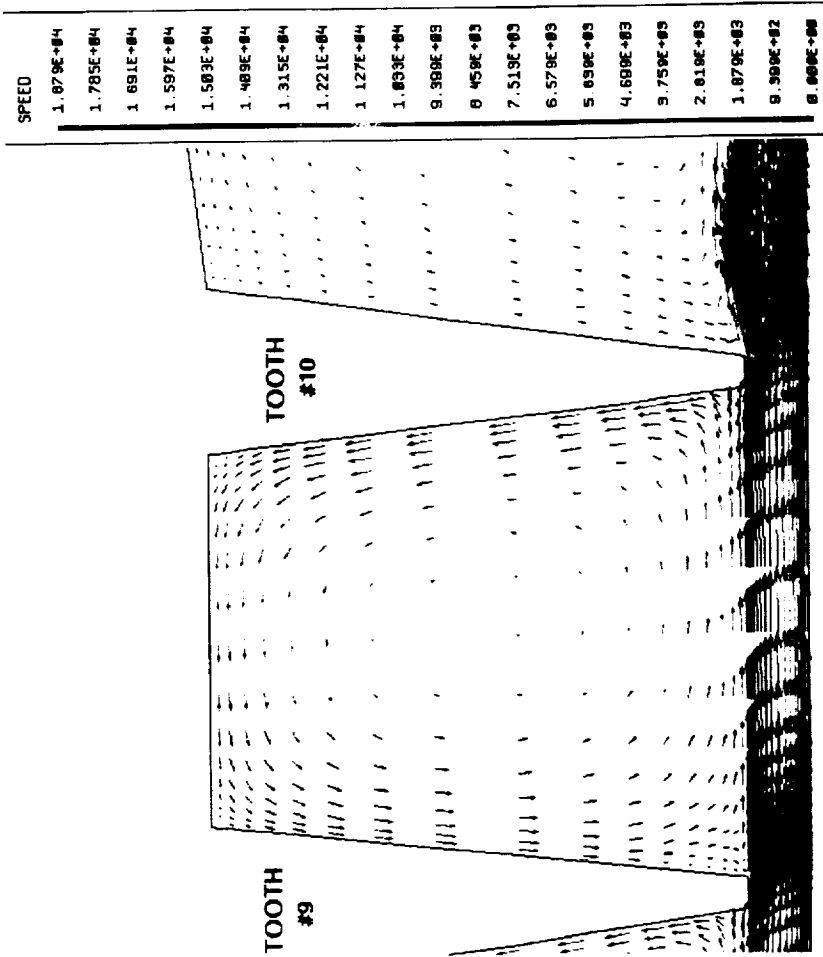

CURRENT STATUS:

- 1.) RUNNING HOLLOW BLADE CASE (TWO-TOOTH LABYRINTH)
 - 104 x 62 x 30 (10 NODES IN TIP GAP RADIAL DIRECTION)
 - 0.030 IN WALL THICKNESS WITH 0.030 IN TIP CLEARANCE.
 - HOLLOW PORTION OF BLADE EXTENDS FROM MIDSPAN TO TIP.
 - RESULTS WILL BE COMPARED WITH SOLID BLADE TO ASSESS BENEFITS IN TERMS OF LOSS REDUCTION/ REDUCED LEAKAGE.

- 2.) CONSTRUCTING ROTOR GRID FOR BASELINE MULTI-TOOTH LABYRINTH TIP SEAL (USING GRID EMBEDDING)
 - PARAMETERS WILL BE NECESSARY TO OPTIMIZE DESIGN

- 3.) INVESTIGATING OTHER TIP TREATMENTS WHICH MAY REDUCE RELATIVE TOTAL PRESSURE LOSSES
 - SUCTION SIDE TRAILING EDGE SLOT TO PROVIDE FLOW GUIDANCE (TO REDUCE IMPINGEMENT ANGLE OF TIP LEAKAGE FLOW ON MAINSTREAM FLOW)

GGOT TIP TREATMENT EVALUATION
STUDY

PARTIALLY HOLLOW BLADE WITH 0.030 IN WALL THICKNESS
104 x 62 x 30 (10 NODES IN TIP GAP RADIAL DIRECTION)

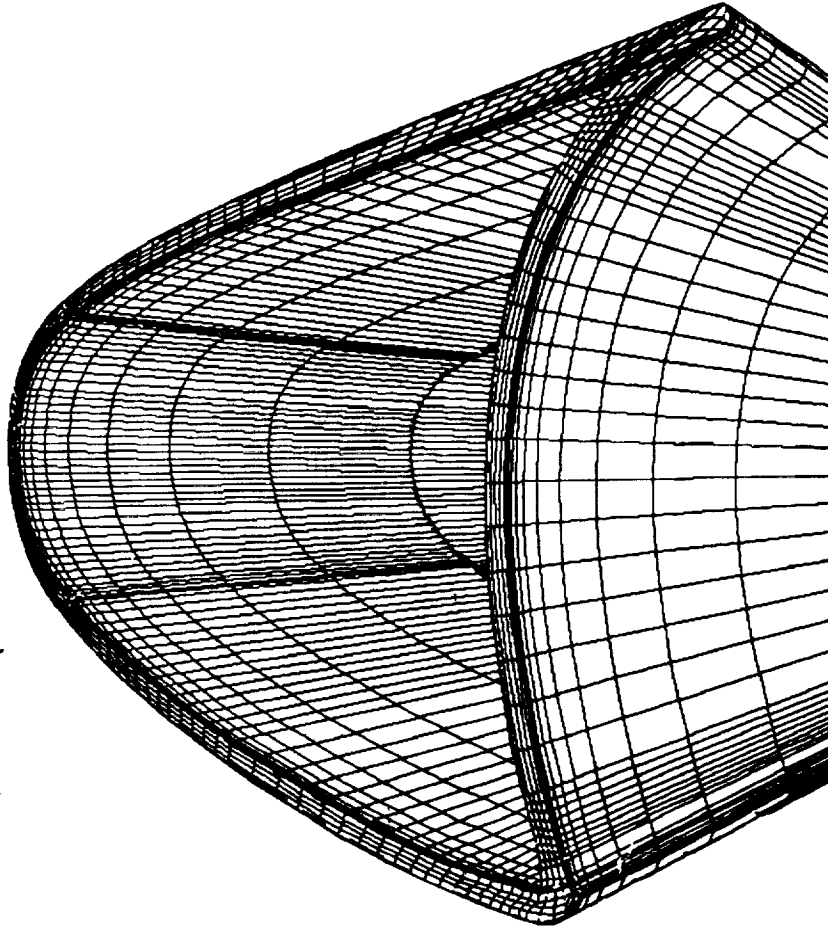

ALTERNATE TIP TREATMENT METHODS - TRAILING EDGE SUCTION - SIDE SLOT

OBJECTIVE: PROVIDE FLOW GUIDANCE TO REDUCE TIP LEAKAGE IMPINGEMENT ANGLE

- ISSUES:**
- 1.) NEED TO MAXIMIZE SLOT ANGLE TO PROVIDE MAXIMUM GUIDANCE.**
 - 2.) RESISTANCE PATH THROUGH SLOT SHOULD BE LESS THAN OVER TIP TO INDUCE FLOW THROUGH SLOT (FUNCTION OF FLOW AREA).**
 - 3.) SLOT DEPTH SHOULD BE MINIMIZED TO LOCALIZE EFFECTS TO TIP REGION.**

