

1995 117020

IMPELLER FLOW FIELD CHARACTERIZATION WITH A LASER TWO-FOCUS VELOCIMETER

L. A. Brozowski, T. V. Ferguson, L. Rojas

Rockwell International - Rocketdyne Division
Canoga Park, California

528-34

43803

P. 54

ABSTRACT

Use of Computational Fluid Dynamics (CFD) codes, prevalent in the rocket engine turbomachinery industry, necessitates data of sufficient quality and quantity to benchmark computational codes. Existing data bases for typical rocket engine configurations, in particular impellers, are limited. In addition, traditional data acquisition methods have several limitations: typically transducer uncertainties are 0.5 percent of transducer full scale and traditional pressure probes are unable to provide flow characteristics in the circumferential (blade-to-blade) direction. Laser velocimetry circumvents these limitations by providing ± 0.5 percent uncertainty in flow velocity and ± 0.5 degree uncertainty in flow angle. The percent of uncertainty in flow velocity is based on the measured value, not full range capability. The laser electronics multiple partitioning capability allows data acquired between blades as the impeller rotates, to be analyzed separately, thus providing blade-to-blade flow characterization. Unlike some probes, the non-intrusive measurements made with the laser velocimeter does not disturb the flow.

To this end, and under Contract (NAS8-38864) to the National Aeronautics and Space Administration (NASA) at Marshall Space Flight Center (MSFC), an extensive test program was undertaken at Rocketdyne. Impellers from two different generic rocket engine pump configurations were examined. The impellers represent different spectrums of pump design: the Space Shuttle Main Engine (SSME) high pressure fuel turbopump (HPFTP) impeller was designed in the 1970's, the Consortium for CFD Application in Propulsion Technology Pump Stage Technology Team (Pump Consortium) optimized impeller was designed with the aid of modern computing techniques. The tester configuration for each of the impellers consisted of an axial inlet, an inducer, a diffuser, and a crossover discharge.

While the tested configurations were carefully chosen to be representative of generic rocket engine pumps, several features of both testers were intentionally atypical. A crossover discharge, downstream of the impeller, rather than a volute discharge was used to minimize asymmetric flow conditions that might be reflected in the impeller discharge flow data. Impeller shroud wear ring radial clearances were purposely close to minimize leakage flow, thus increasing confidence in using the inlet data as an input to CFD programs.

The empirical study extensively examined the flow fields of the two impellers via performance of laser two-focus velocimeter surveys in an axial plane upstream of the impellers and in multiple radial planes downstream of the impellers. Both studies were performed at the impeller design flow coefficients.

Inlet laser surveys that provide CFD code inlet boundary conditions were performed in one axial plane, with ten radial locations surveyed. Three wall static pressures, positioned circumferentially around the impeller inlet were used to identify asymmetrical pressure distributions in the inlet survey plane. The impeller discharge flow characterization consisted of three radial planes for the SSME HPFTP impeller and two radial planes for the Pump Consortium optimized impeller. Housing wall static pressures were placed to correspond to the radial locations surveyed with the laser velocimeter. Between five and thirteen axial stations across the discharge channel width were examined in each radial plane during the extensive flow mapping.

The largely successful empirical flow characterization of two different impellers resulted in a substantial contribution to the limited existing data base, and yielded accurate data for CFD code benchmarking.

**IMPELLER FLOW FIELD CHARACTERIZATION WITH A LASER TWO-FOCUS
VELOCIMETER**

1636

22 April 1993

**L. A. Brozowski
T. V. Ferguson
L. Rojas**

IMPELLER FLOW FIELD CHARACTERIZATION WITH A LASER TWO-FOCUS VELOCIMETER

- Background
- Test Objectives
- Nondimensionalization
- Configuration Geometry
 - Configuration - 1
 - Configuration - 2
- Test Facility and Conditions
- Laser Survey Locations
 - Impeller Inlet Survey
 - Impeller Discharge Survey
- Results Configuration - 1
- Results Configuration - 2
- Conclusion

PUMP CFD CODE VALIDATION TESTS

Background

- **NASA-MSFC Contract: Advanced Design-Verification Methodology for Pump-Fed Earth-to-Orbit Propulsion Systems**
 - Increasing use of CFD codes throughout rocket engine propulsion industry
 - Limited benchmark quality data available for pump CFD code validation
- **Approach**
 - Geometry representative of current rocket engine turbomachinery pump configurations
 - Use laser two-focus velocimeter to obtain flow characteristics (velocity and angle)
 - Non-intrusive measurement
 - Allows blade-to-blade flow characterization
 - Accuracy better than typical measurements
 - Velocity uncertainty ± 0.5 percent of measured velocity value
 - Flow angle uncertainty ± 0.5 degree

PUMP CFD CODE VALIDATION TESTS

Data Nondimensionalization

- Nondimensionalization of data allows generalization of comparison between empirical data and CFD codes
- Length - nondimensionalized by impeller tip diameter

$$L_{\text{nondim}} = \frac{L}{D_{\text{tip}}}$$

- Head - nondimensionalized by impeller tip speed squared

$$H_{\text{nondim}} = \frac{g^*H}{2 U_{\text{tip}}^2}$$

- Velocity - nondimensionalized by impeller tip speed

$$V_{\text{nondim}} = \frac{V}{U_{\text{tip}}}$$

PUMP CFD CODE VALIDATION TESTS

Standard Coordinate System

- **Right Hand Coordinate System**
- **Circumferential reference - 0 degrees at impeller trailing edge intersection with hub, positive angle increase in counterclockwise (against impeller rotation) direction**
- **Axial reference - 0 at impeller leading edge intersection with shroud, negative upstream (pump inlet) positive toward pump discharge**
- **Radial reference - 0 at shaft centerline**
- **Data in standard plot3d (i, j, k) format**
 - **i-axis: meridional direction**
 - **j-axis: blade-to-blade direction**
 - **k-axis: hub-to-tip direction**

PUMP CFD CODE VALIDATION TESTS

Pictorial of Coordinate System

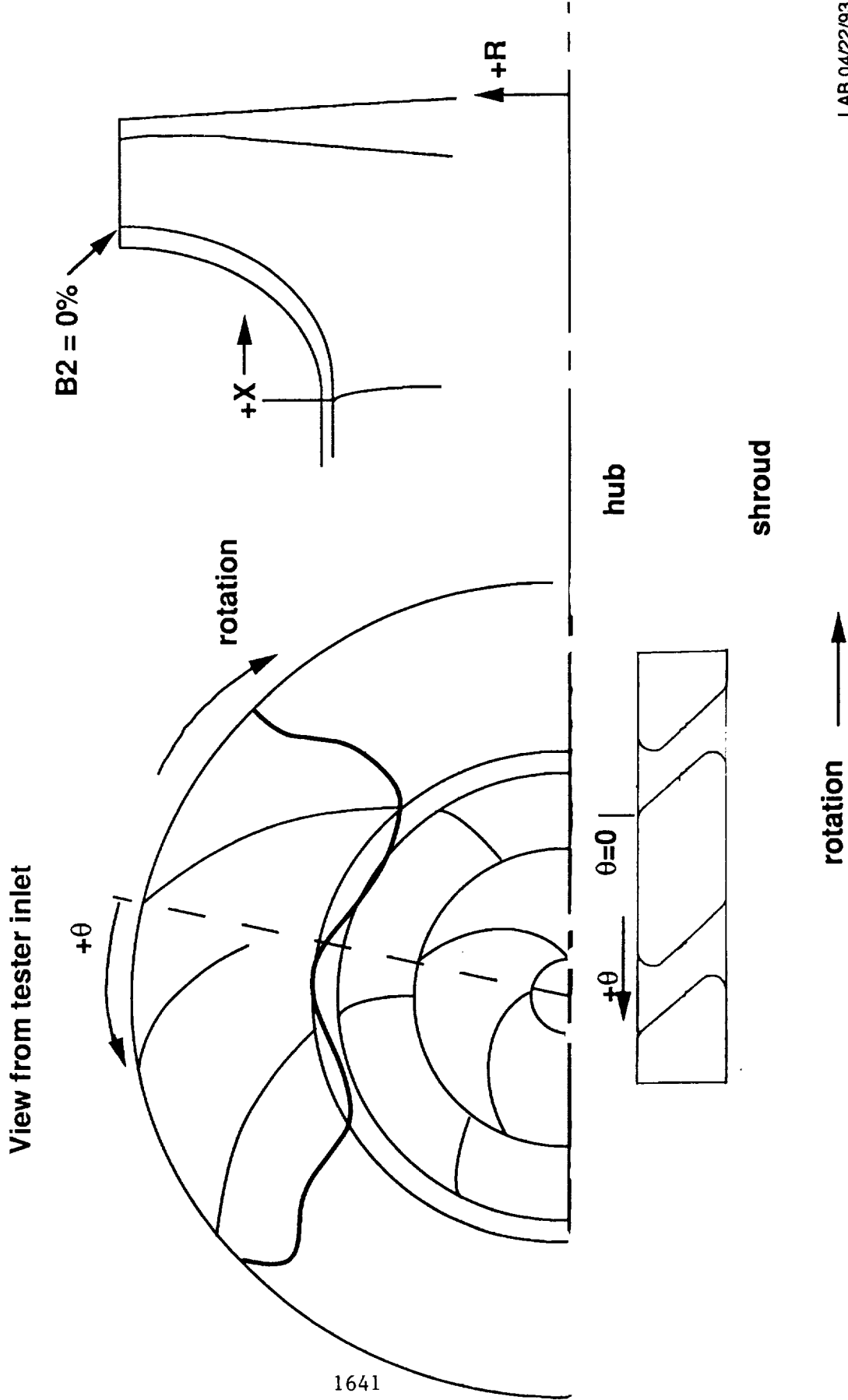

1641

PLOT3D i,j,k Convention

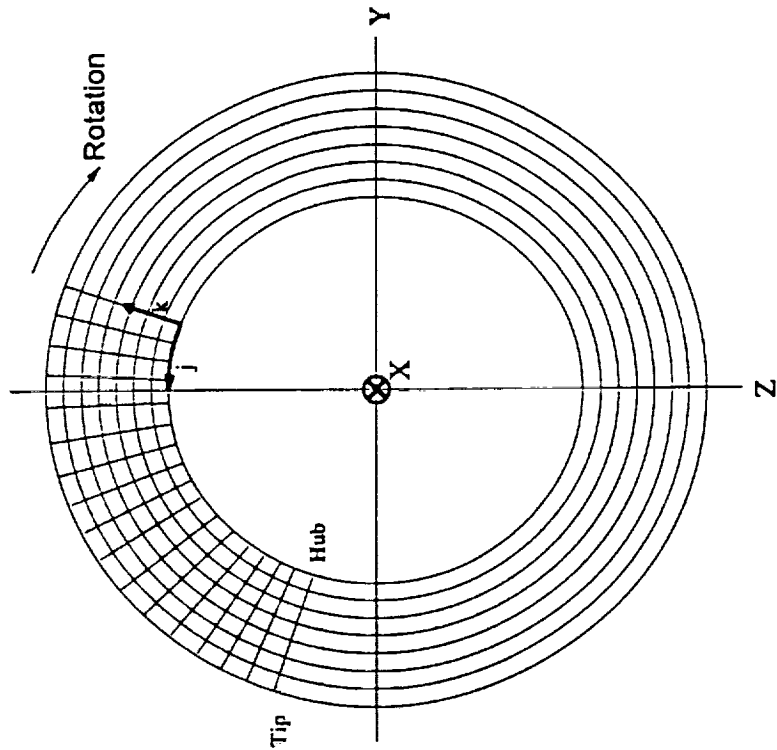

Impeller Inlet Grid

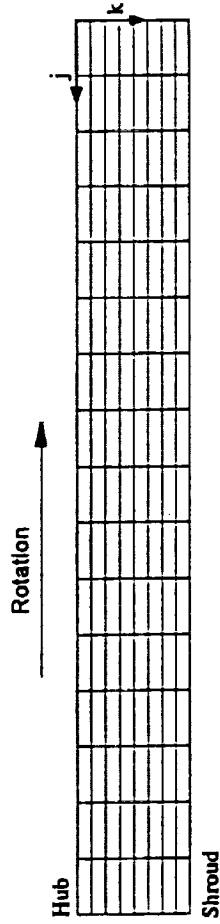

Impeller Discharge Grid

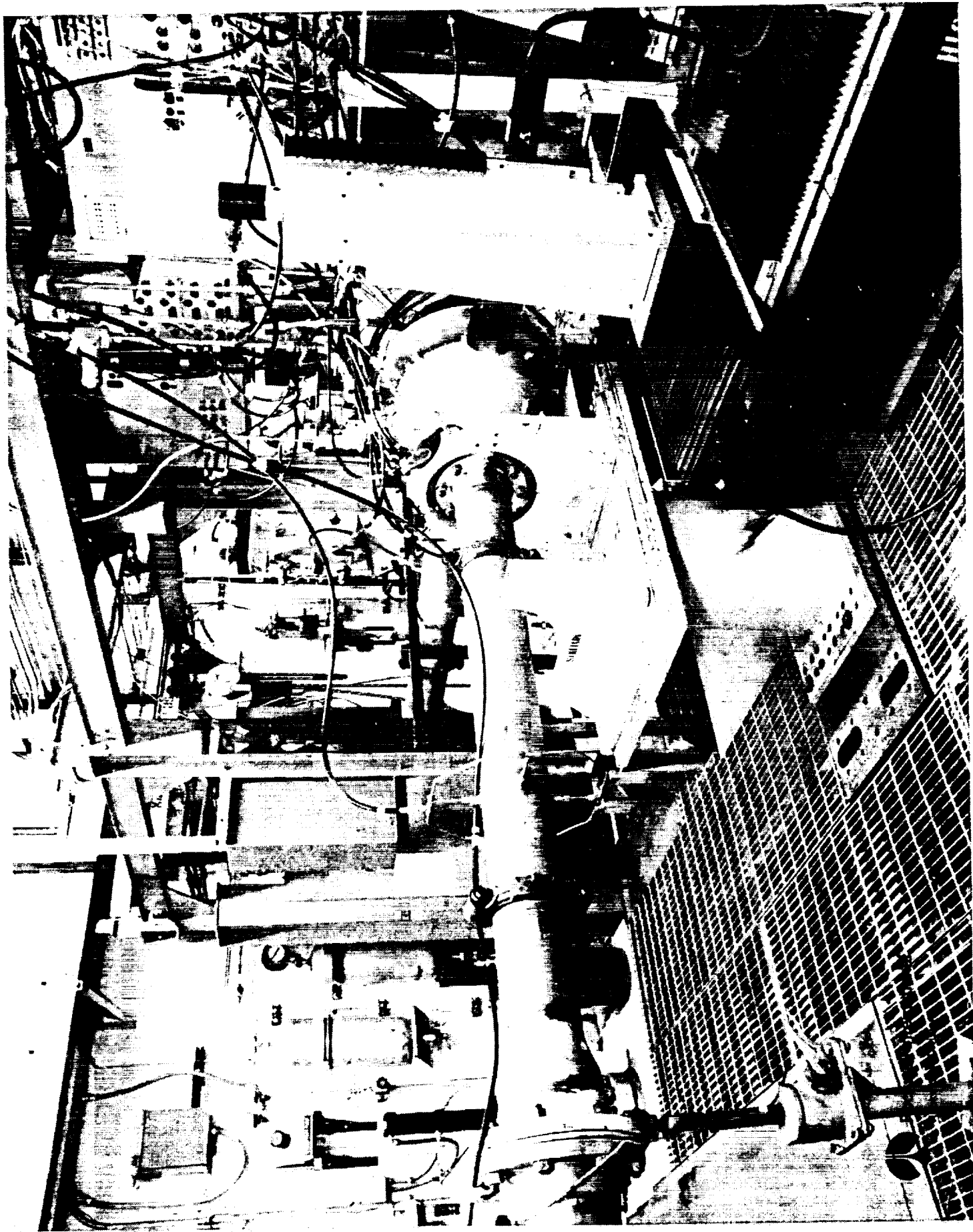

PUMP CFD CODE VALIDATION TESTS

Two Pump Configurations Tested

- Axial Inlet, Diffuser, Crossover, Volute Used in Both Configurations
- Configuration 1 - Space Shuttle Main Engine High Pressure Fuel Turbopump
 - SSME HPFTP prototype inducer - unshrouded with six blades
 - Inducer tip nondimensional radial clearance 0.000636
 - SSME HPFTP shrouded impeller trimmed to 92 percent of original tip diameter
 - Shrouded impeller with six full blades
 - Six long partial blades, twelve short partial blades
 - Diffuser-crossover located at nondimensional radius of 0.5545
 - Impeller shroud leakage minimized with nondimensional shroud wear ring nominal radial clearance 0.000136

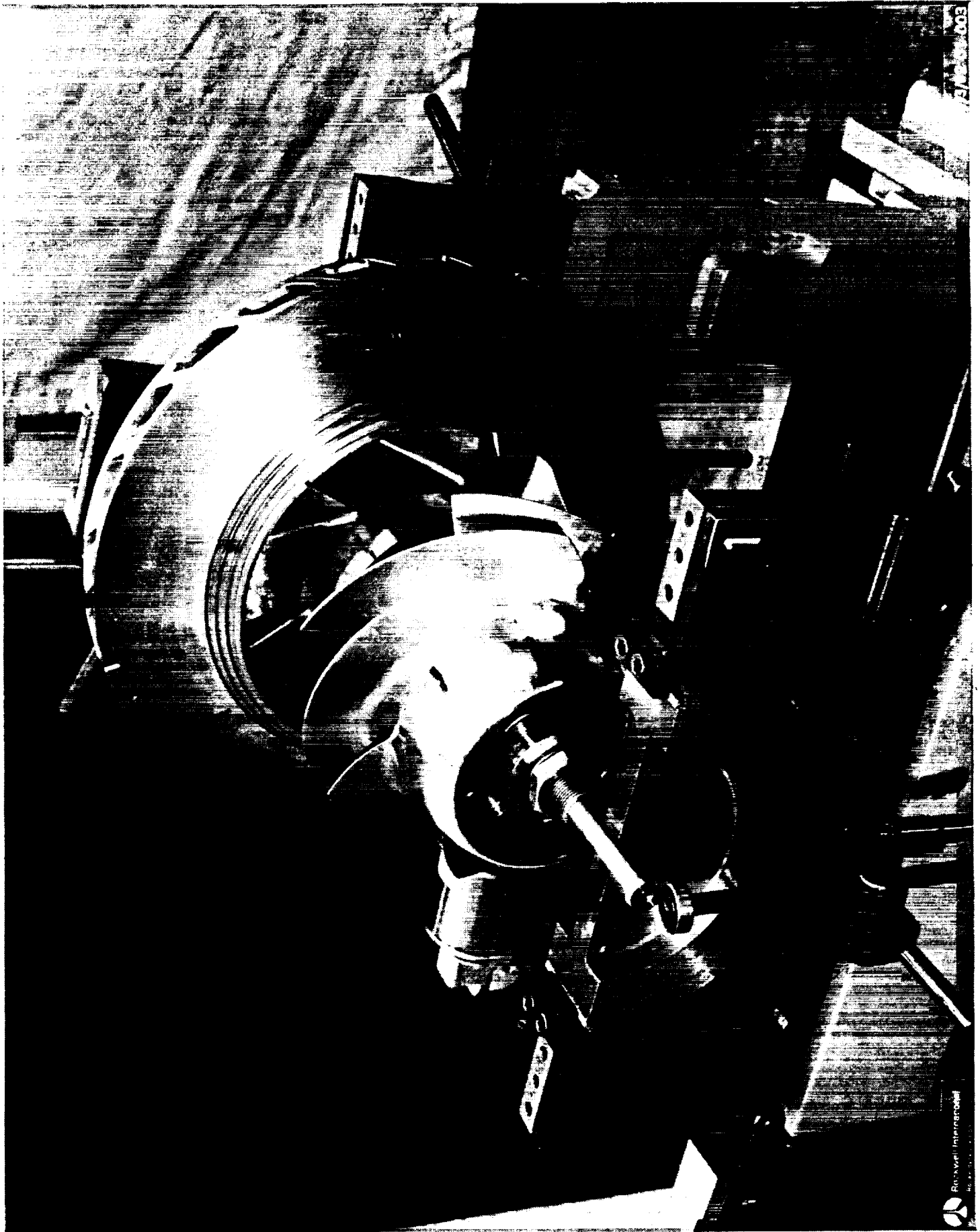

1645

ORIGINAL PAGE
BLACK AND WHITE PHOTOGRAPH

SSME HPFTP IMPELLER LASER VELOCIMETER SURVEY TESTER
CROSS-SECTION

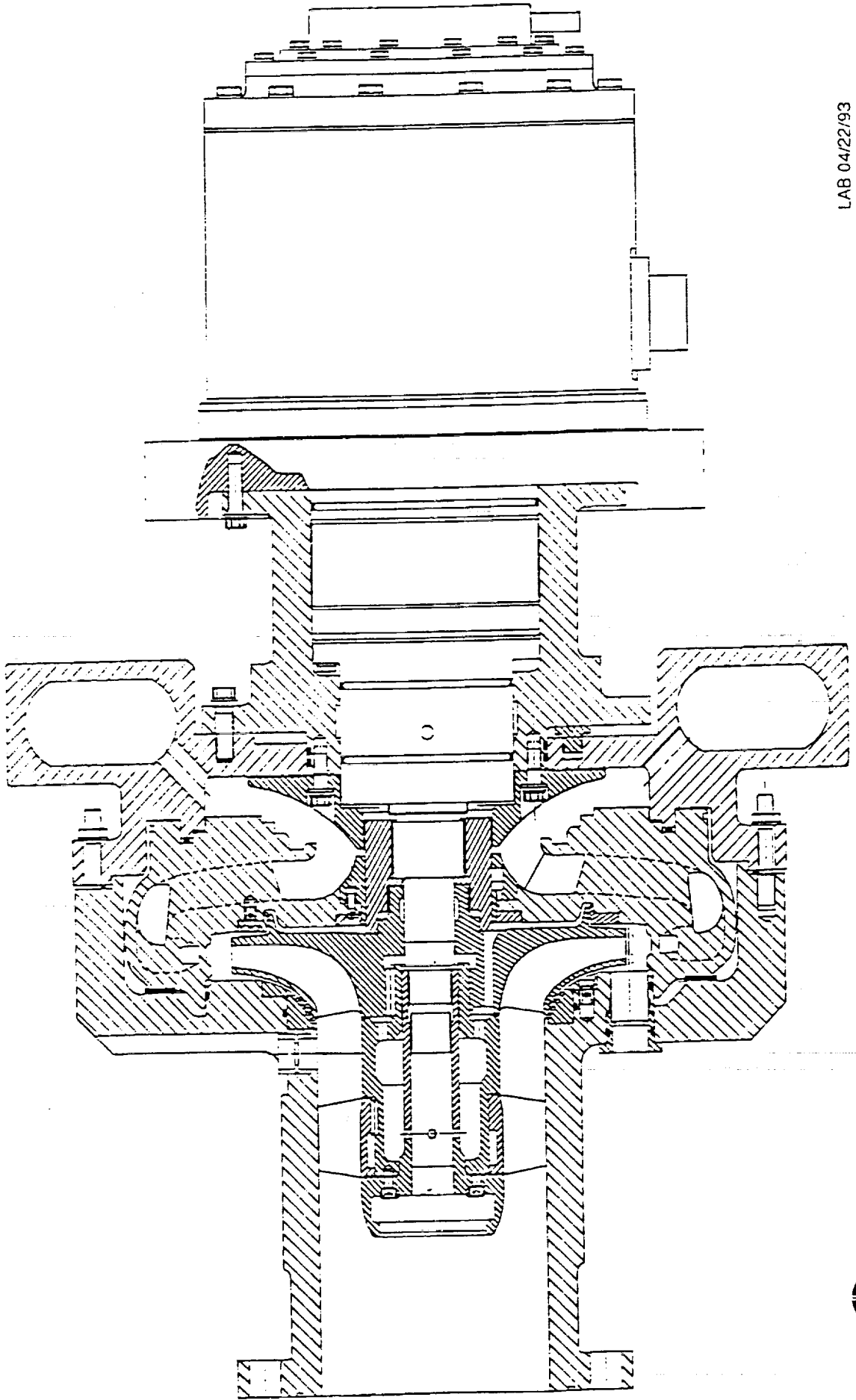

LAB 04/22/93

PUMP CFD CODE VALIDATION TESTS

Two Pump Configurations Tested

- Configuration 2 - Pump Consortium
 - Unshrouded inducer with four blades
 - Inducer tip nondimensional radial clearance 0.000967
 - Impeller design based on Consortium for CFD application in Propulsion Technology Pump Stage Technology Team requirements - Pump Consortium optimized impeller (designated Pump Consortium baseline impeller for this empirical study)
 - Shrouded impeller with six full blades, six partial blades
 - Diffuser-crossover located at nondimensional radius of 0.6711
 - Impeller shroud leakage minimized with nondimensional wear ring nominal radial clearance -0.000166

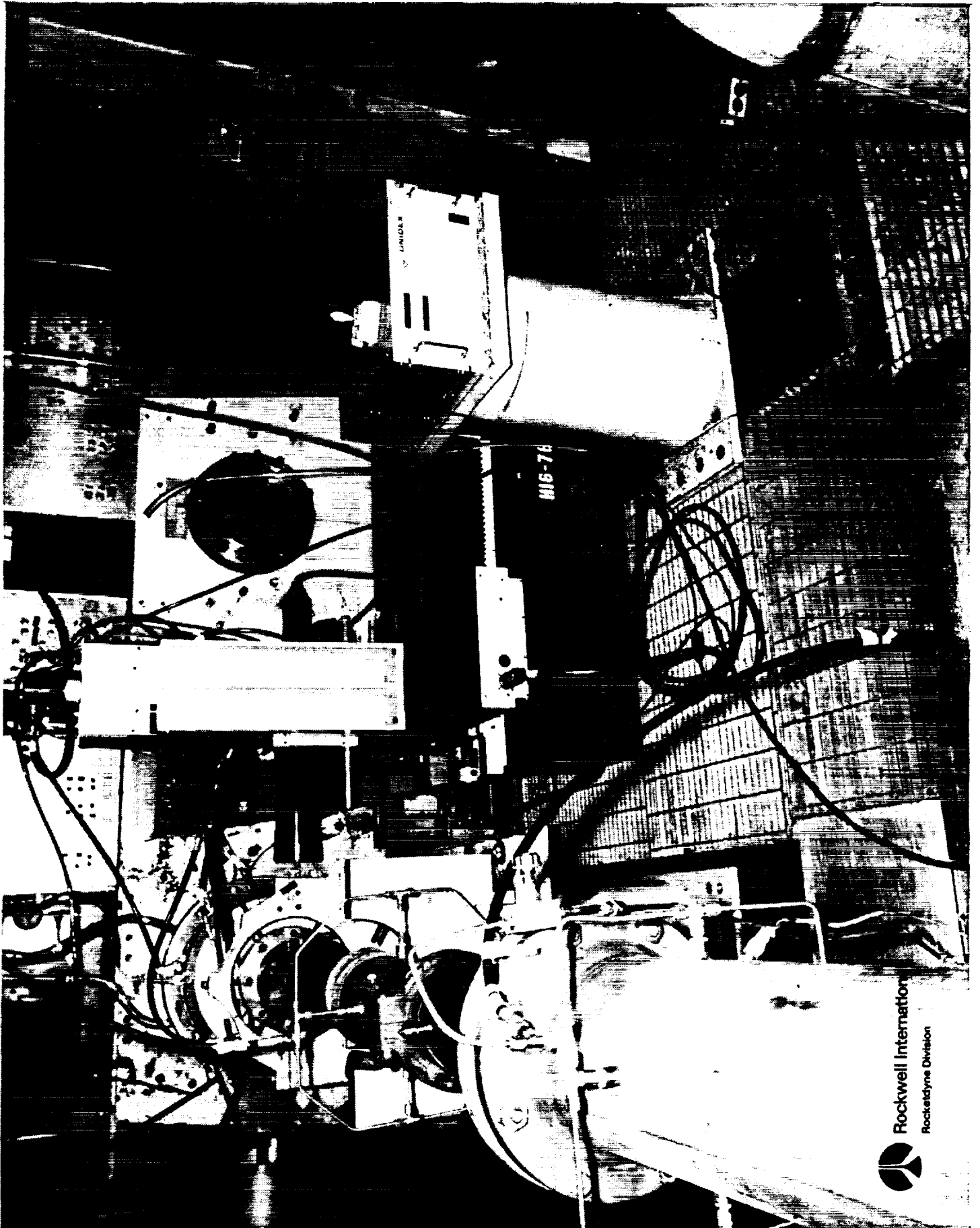

 Rockwell International
Rocketdyne Division



CONSORTIUM BASELINE IMPELLER LASER VELOCIMETER SURVEY TESTER
CROSS-SECTION

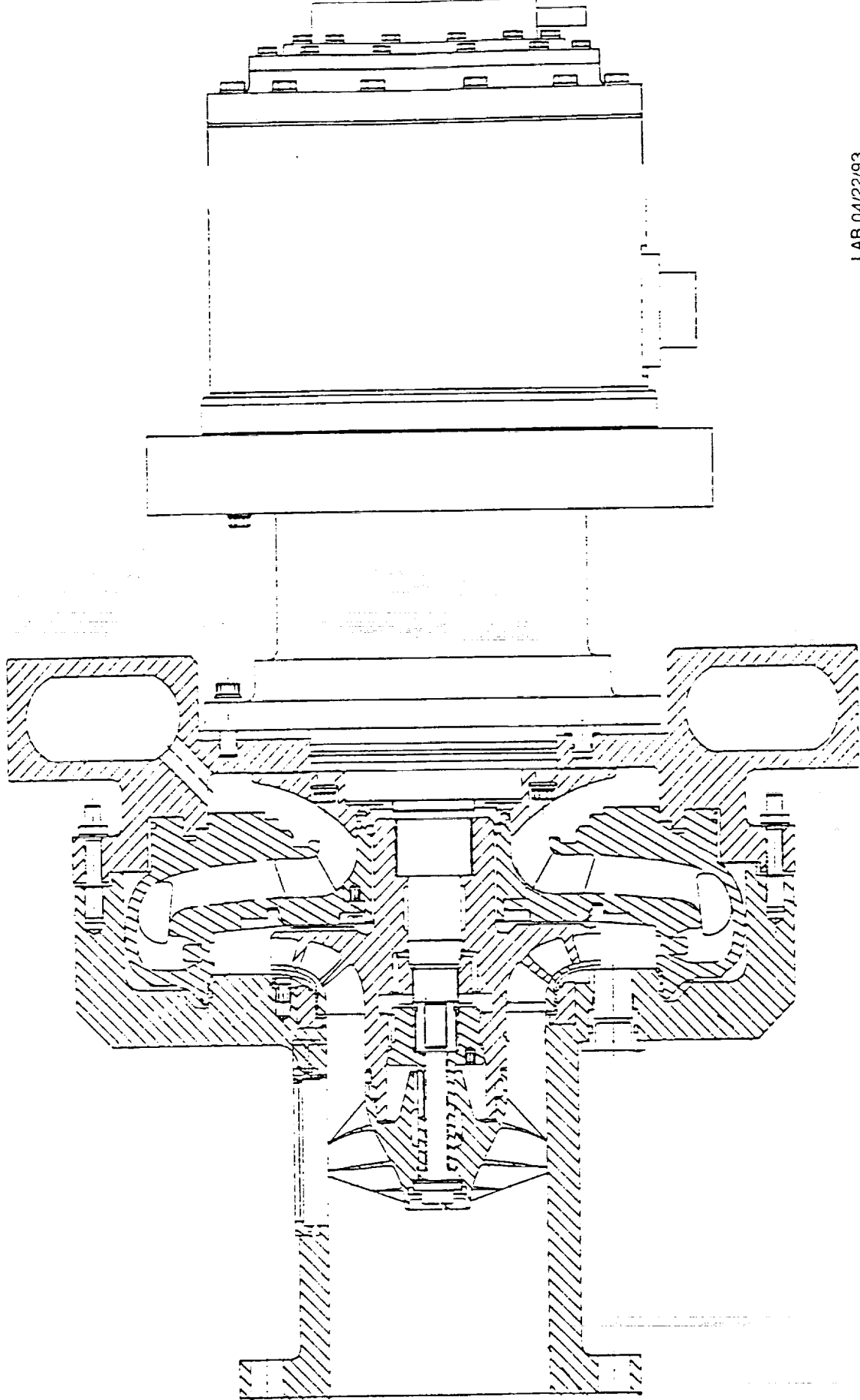

LAB 04/22/93

PUMP CFD CODE VALIDATION TESTS Test Facility and Test Conditions

- **Rocketdyne's Engineering Development Laboratory Pump Test Facility**
 - **7600 gallon closed-loop flow facility**
 - **4000 HP reversible, synchronous motor**
 - **128 channel static data acquisition system - 1 data sample every 6 seconds**
- **Both test configurations tested at 6322 rpm with ambient water**
 - **Configuration 1 - SSME HPFTP impeller**
 - **Impeller discharge tip speed = 92.487 m/s**
 - **Impeller inlet design flow coefficient (based on discharge tip speed) = 0.256**
 - **Configuration 2 - Consortium baseline impeller**
 - **Impeller discharge tip speed = 76.049 m/s**
 - **Impeller inlet design flow coefficient (based on discharge tip speed) = 0.144**

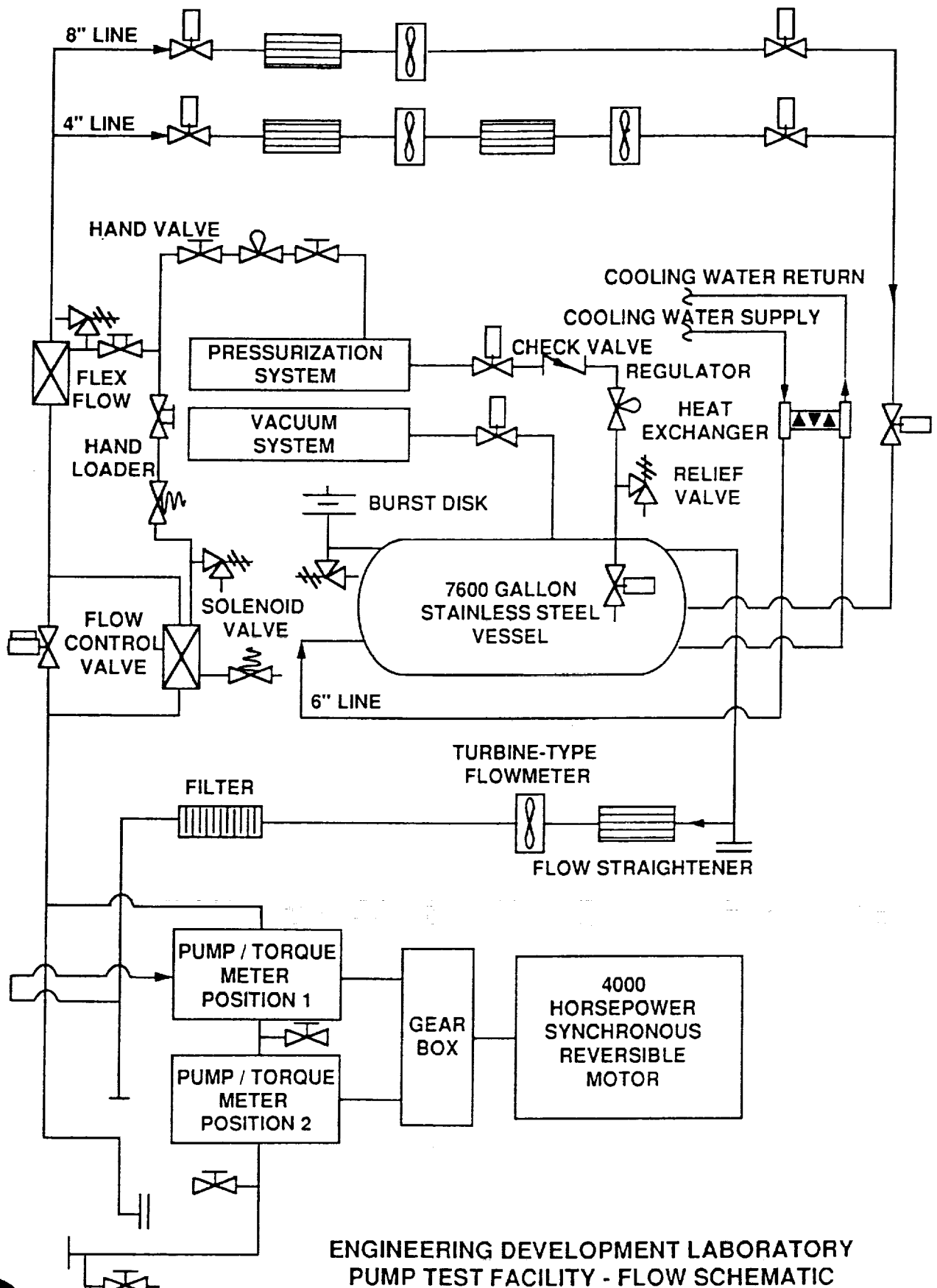

ENGINEERING DEVELOPMENT LABORATORY
PUMP TEST FACILITY - FLOW SCHEMATIC



Rockwell International
Rocketdyne Division

04/22/92

PUMP CFD CODE VALIDATION TESTS

Configurations 1 & 2 Laser Two-Focus Velocimeter Surveys

- Impeller Inlet Survey Data Locations
 - Ten radial positions (% of annulus height, 0% at hub)
 - 10, 15, 25, 35, 45, 55, 65, 75, 85, 95
 - Each radial survey referenced to impeller timing mark
 - Impeller inlet timing mark - axial projection of impeller leading edge tip
 - Configuration 1 - one axial plane located at nondimensional axial position -0.0893 (upstream of impeller leading edge tip)
 - 60 degrees blade-to-blade surveyed partitioned into 16 data windows (3.75 arc deg)
 - Data ensemble averaged over all six blade passages
 - Configuration 2 - one axial plane located at nondimensional axial position -0.1290 (upstream of impeller leading edge tip)
 - 90 degrees inducer blade-to-blade surveyed partitioned into 16 windows (5.625 arc deg)

- Data not ensemble averaged

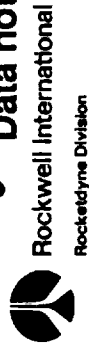

LAB 04/22/93

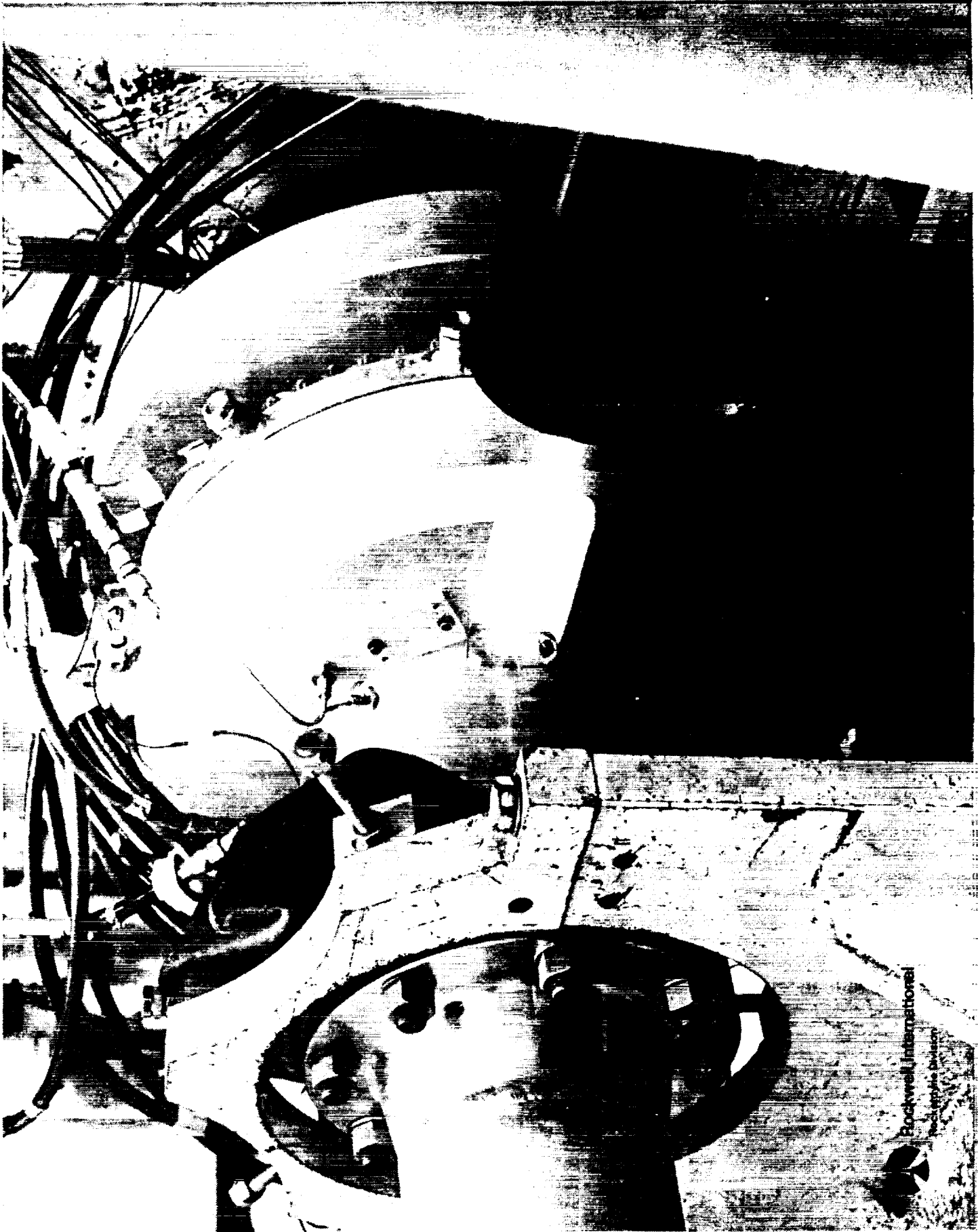

Rockwell International
Rockwell Division

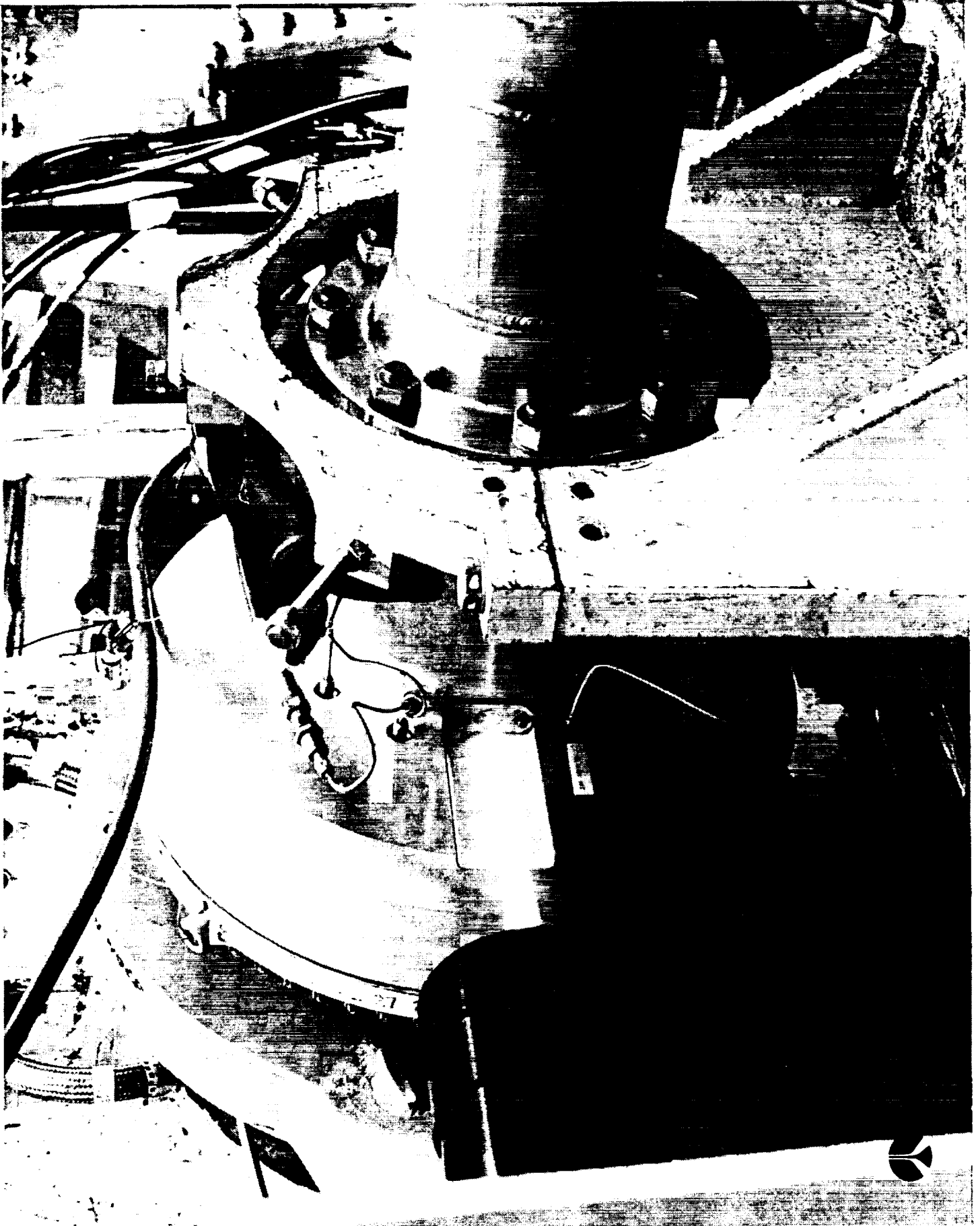

SSME HPFTP IMPELLER LASER VELOCIMETER DATA SURVEY LOCATIONS

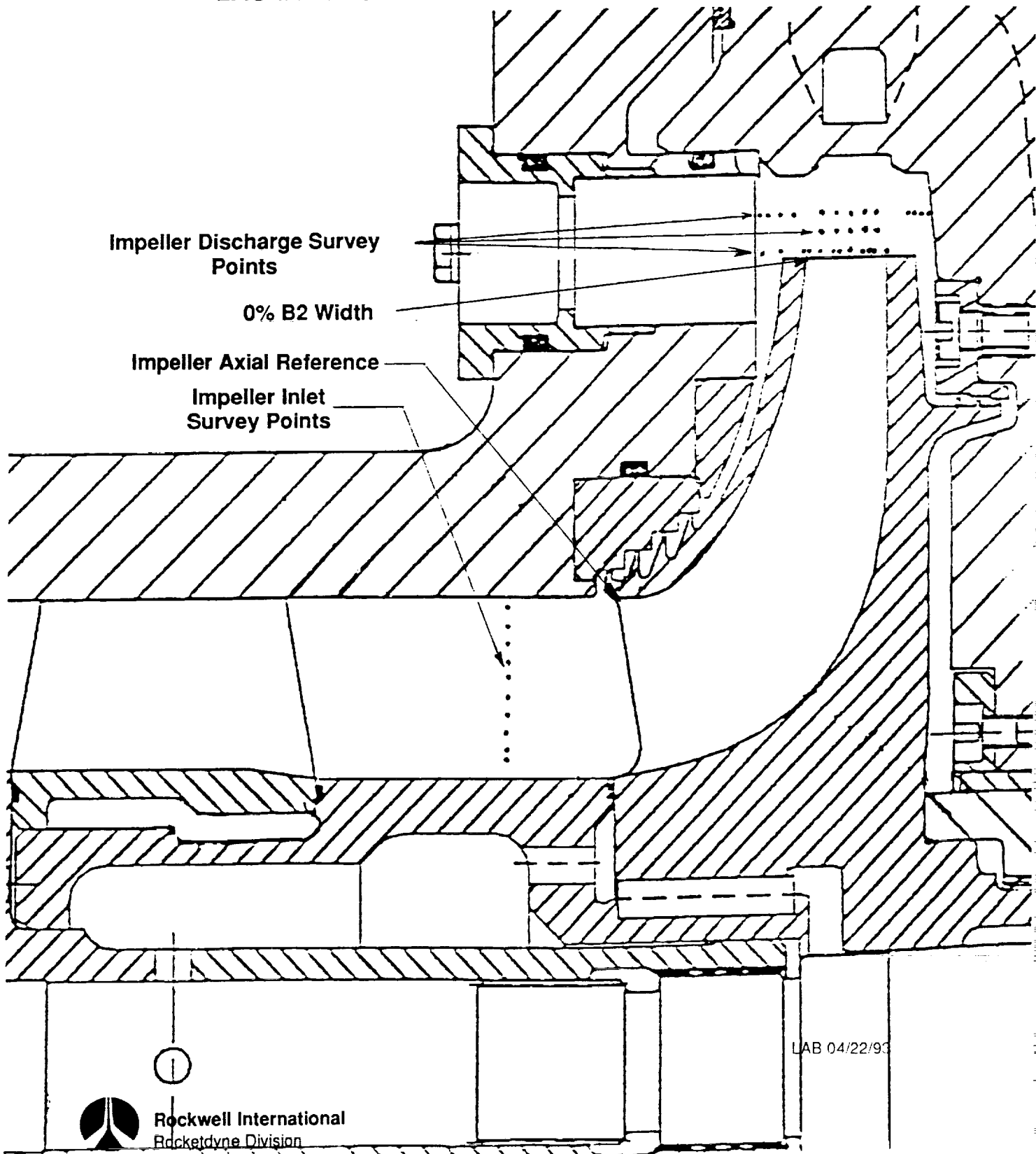

LAB 04/22/93

PUMP CFD CODE VALIDATION TESTS
Consortium Baseline Impeller
Laser Velocimeter Data Survey Locations

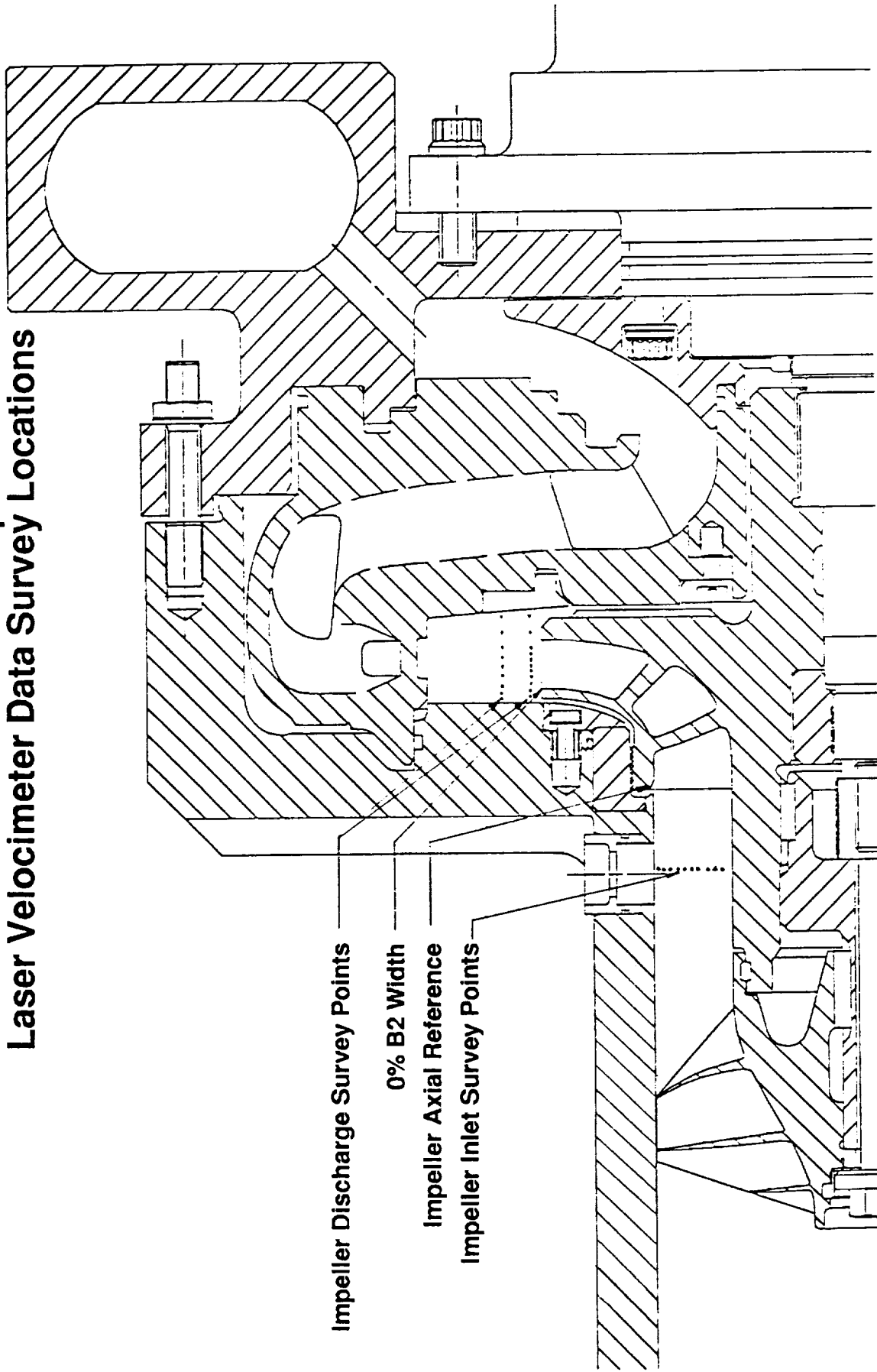

LAB 04/22/93

SSME HPFTP IMPELLER
LASER VELOCIMETER DATA SURVEY LOCATIONS

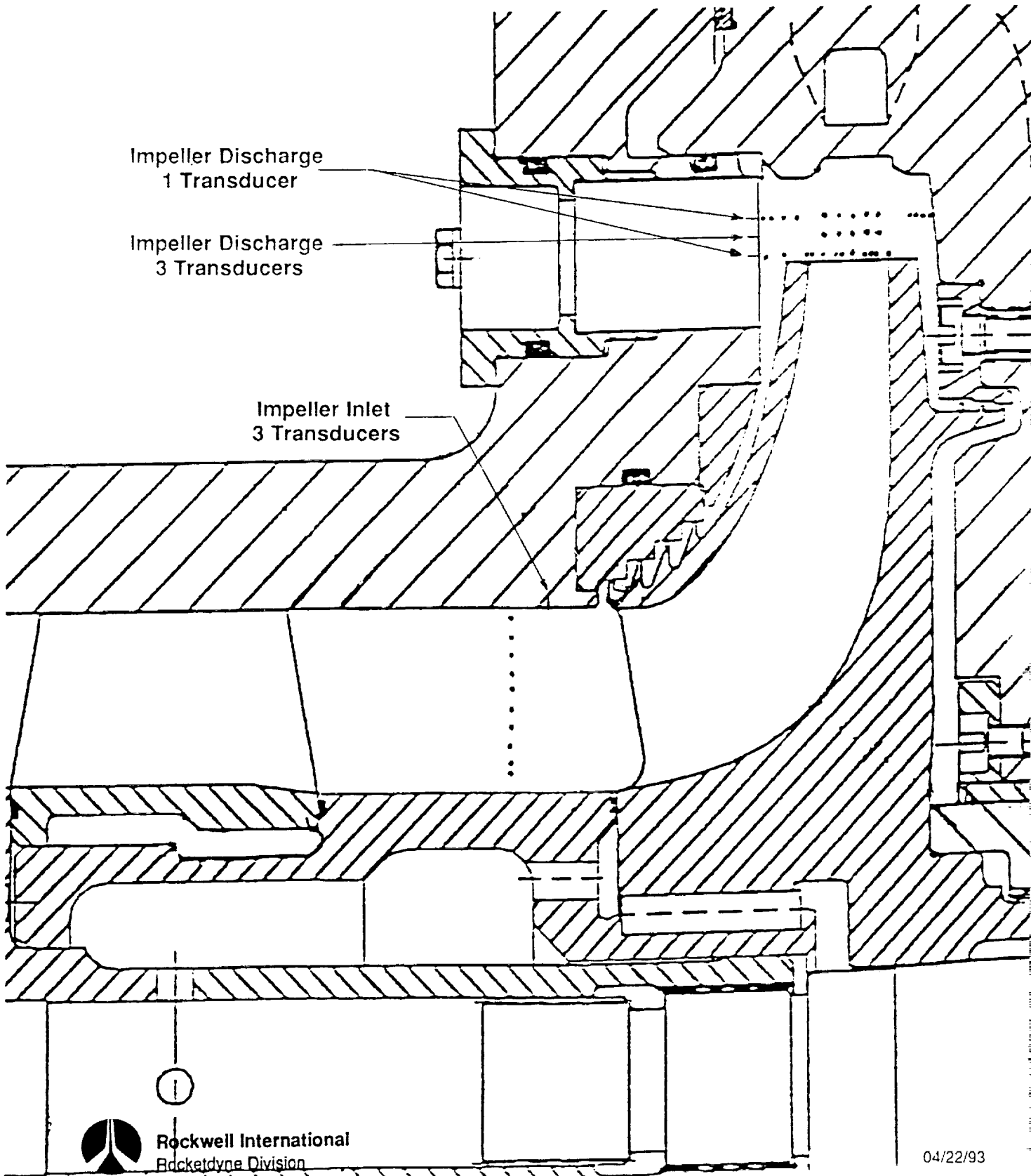

Rockwell International
Rocketdyne Division

04/22/93

CONSORTIUM BASELINE IMPELLER WALL STATIC PRESSURE MEASUREMENT LOCATIONS

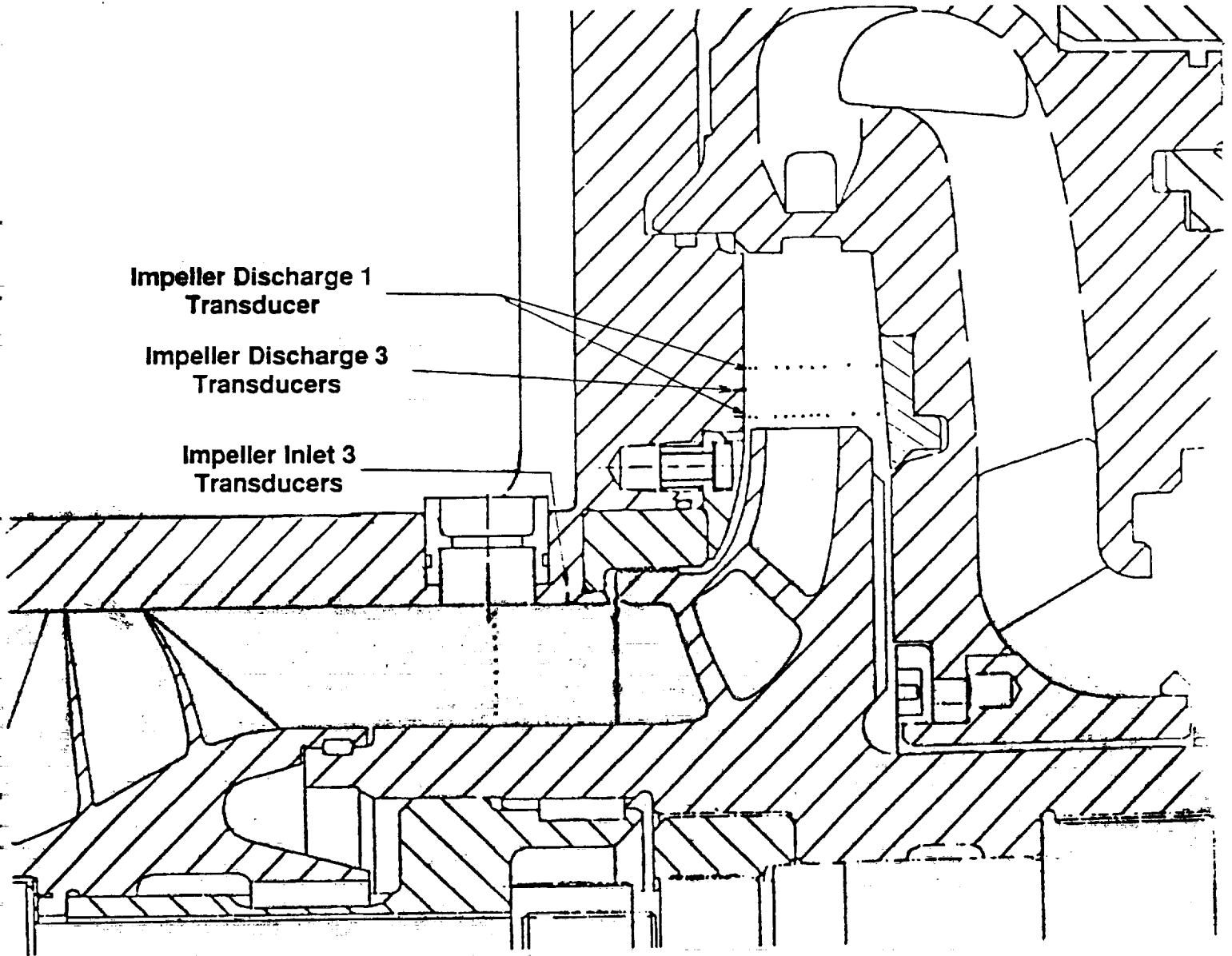

LAB 04/22/93



Rockwell International
Rocketdyne Division

PUMP CFD CODE VALIDATION TESTS

Configurations 1 & 2 Laser Two-Focus Velocimeter Surveys

- **Impeller Discharge Survey Data Locations**
 - **60 Circumferential full-blade-to-full-blade degrees surveyed**
 - **2 Adjacent 30 degree arcs each partitioned into 16 data windows - 1.875 arc degrees**
 - **Each axial survey referenced circumferentially to impeller discharge timing mark**
 - **Timing mark between suction and pressure side of blade at impeller tip shroud**
 - **Data not ensemble averaged**
 - **Configuration 1 - three radial survey planes**
 - **Immediately downstream of impeller discharge - 0.5064 nondimensional radius**
 - **Middle discharge plane - 0.5183 nondimensional radius**
 - **Diffuser-side discharge plane - 0.5303 nondimensional radius**
 - **Configuration 2 - two radial survey planes**
 - **Immediately downstream of impeller discharge - 0.5138 nondimensional radius**
 - **Diffuser-side discharge plane - 0.5507 nondimensional radius**



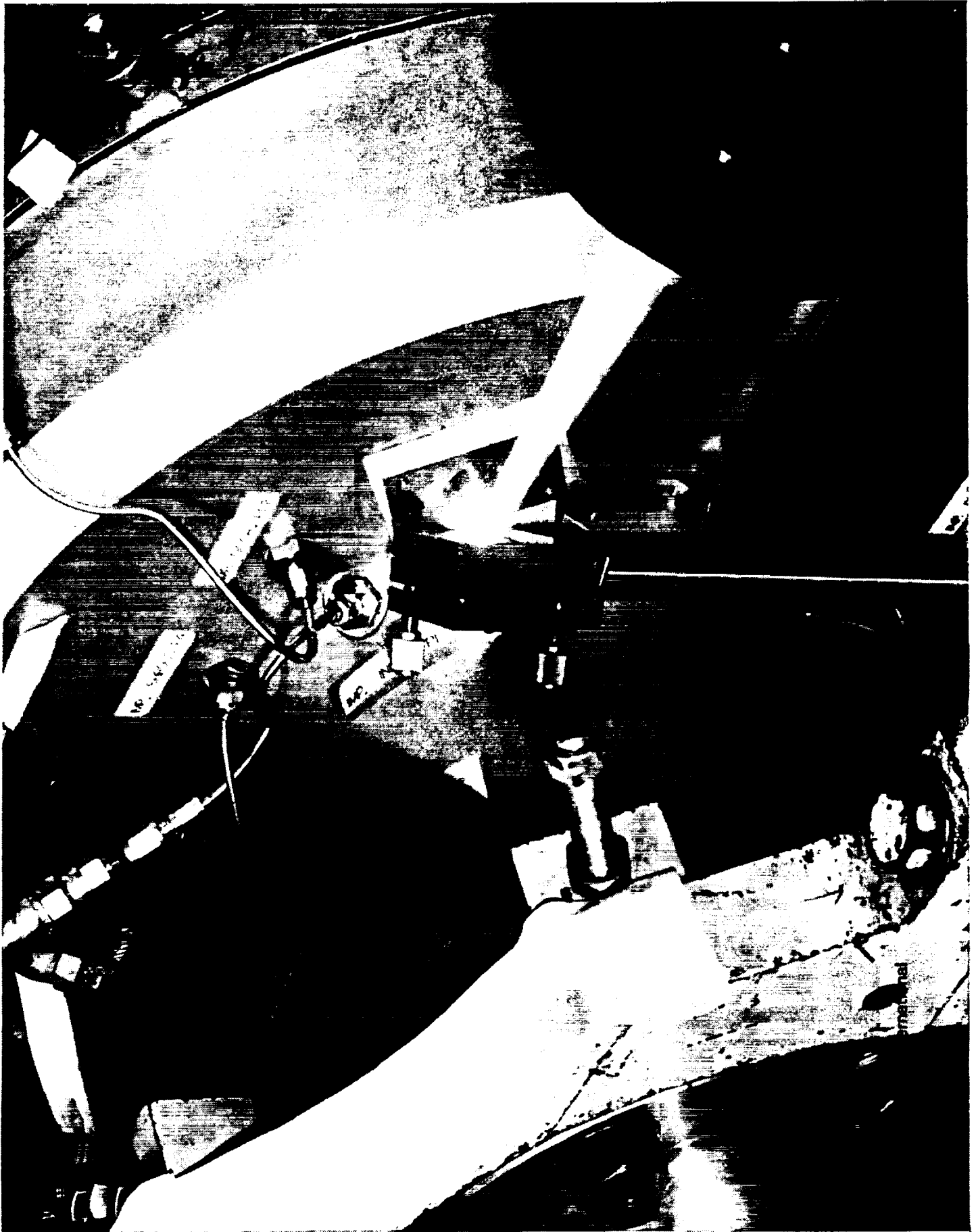

1661

ORIGINAL PAGE
BLACK AND WHITE PHOTOGRAPH



SSME HPFTP IMPELLER DISCHARGE LASER VELOCIMETER DATA CIRCUMFERENTIAL REFERENCE

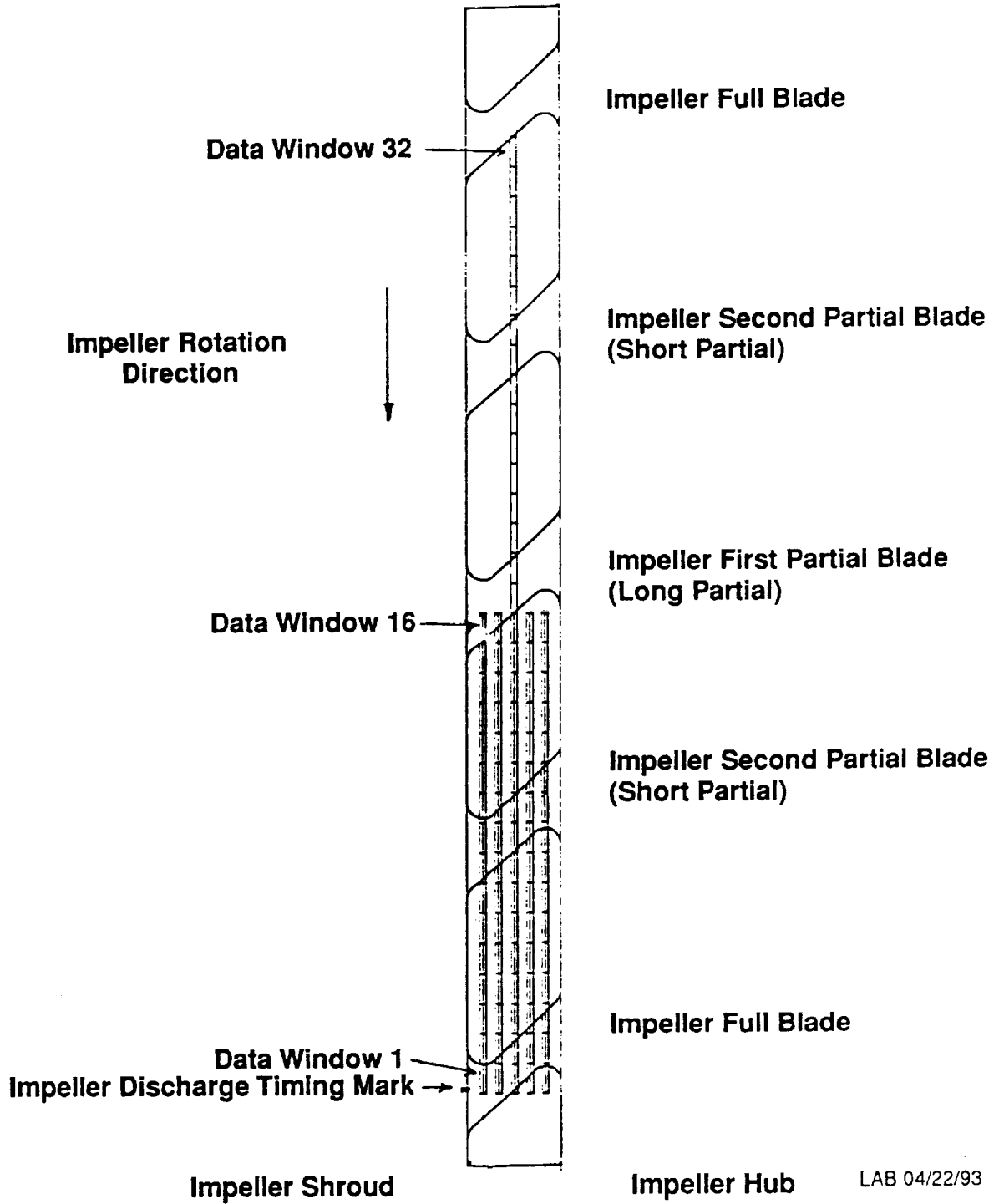

LAB 04/22/93



Rockwell International
Rocketdyne Division

CONSORTIUM BASELINE IMPELLER DISCHARGE LASER VELOCIMETER DATA CIRCUMFERENTIAL POSITIONS

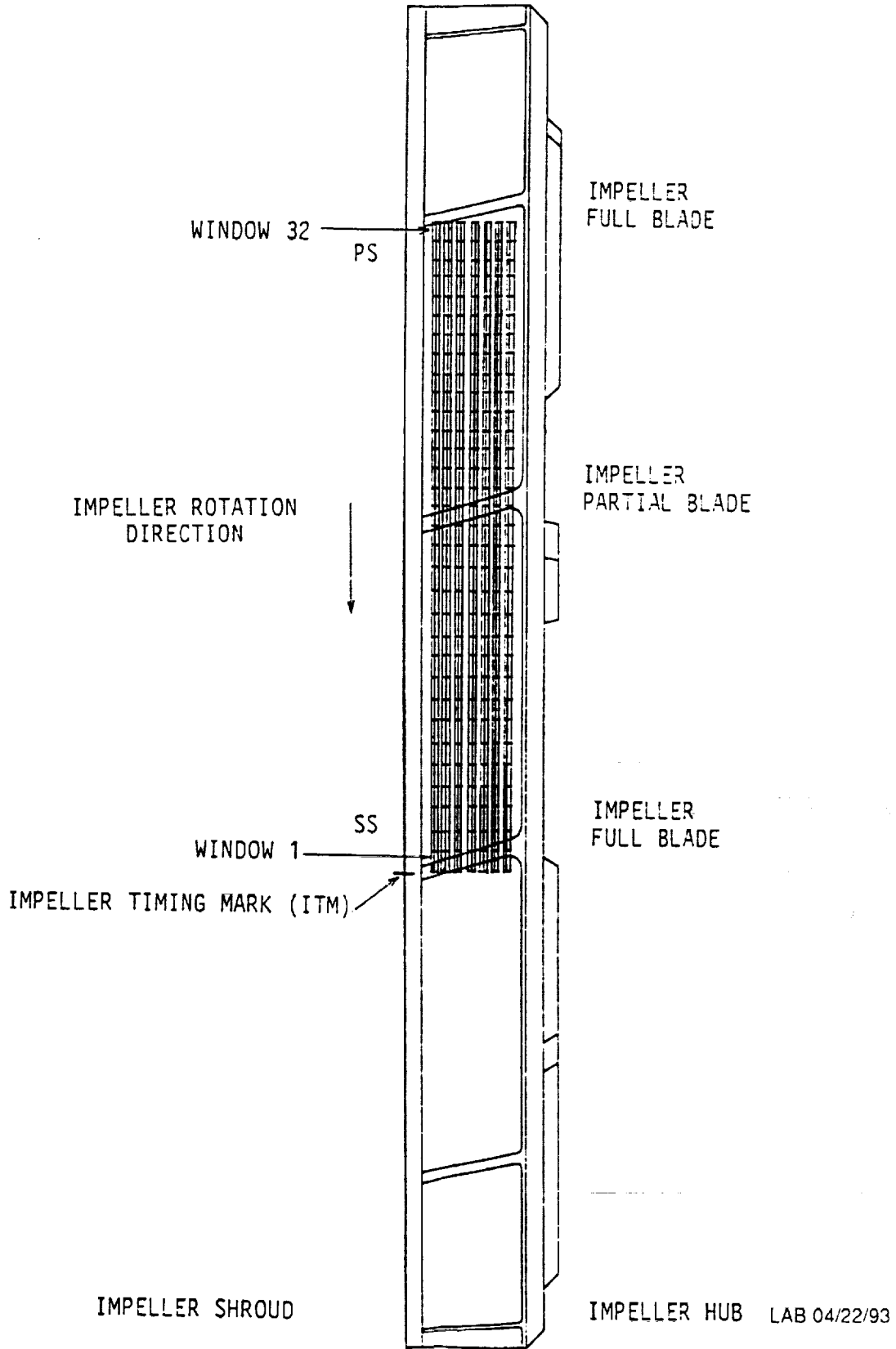

Rockwell International
Rocketdyne Division

PUMP CFD CODE VALIDATION TESTS

Configuration 1 & 2 Laser Two-Focus Velocimeter Surveys

- **Axial positions chosen to adequately characterize flow**
 - **Configuration 1**
 - **Impeller discharge plane - 12 axial positions across B2 width and shroud side**
 - **Middle plane - 5 positions across B2 width**
 - **Diffuser-side plane - 13 axial positions across entire channel width**
 - **Configuration 2**
 - **Impeller discharge plane - 11 axial positions across channel, 7 within B2 width**
 - **Diffuser-side plane - 9 axial positions across channel, 5 within B2 width**

PUMP CFD CODE VALIDATION TESTS
LASER VELOCIMETER RESULTS
CONFIGURATION 1 - SSME HPFTP IMPELLER

1666

LAB 04/22/93

PUMP CFD CODE VALIDATION TESTS

Configuration 1 - Laser Velocimeter Survey

- Data Integrity Checks
 - Flow continuity
 - Impeller inlet plane - 98.6%
 - Circumferential variation
 - Impeller inlet circumferential pressure variations within transducer accuracy
 - Impeller discharge middle plane exhibits minimal pressure variation
 - Adjacent impeller discharge passages exhibit similar flow velocities and angles
 - Test conditions monitored over entire laser survey duration - repeatability shown

PUMP CFD CODE VALIDATION TESTS SSME HPFTP Impeller Inlet Laser Survey

Impeller Inlet Laser Survey Plane

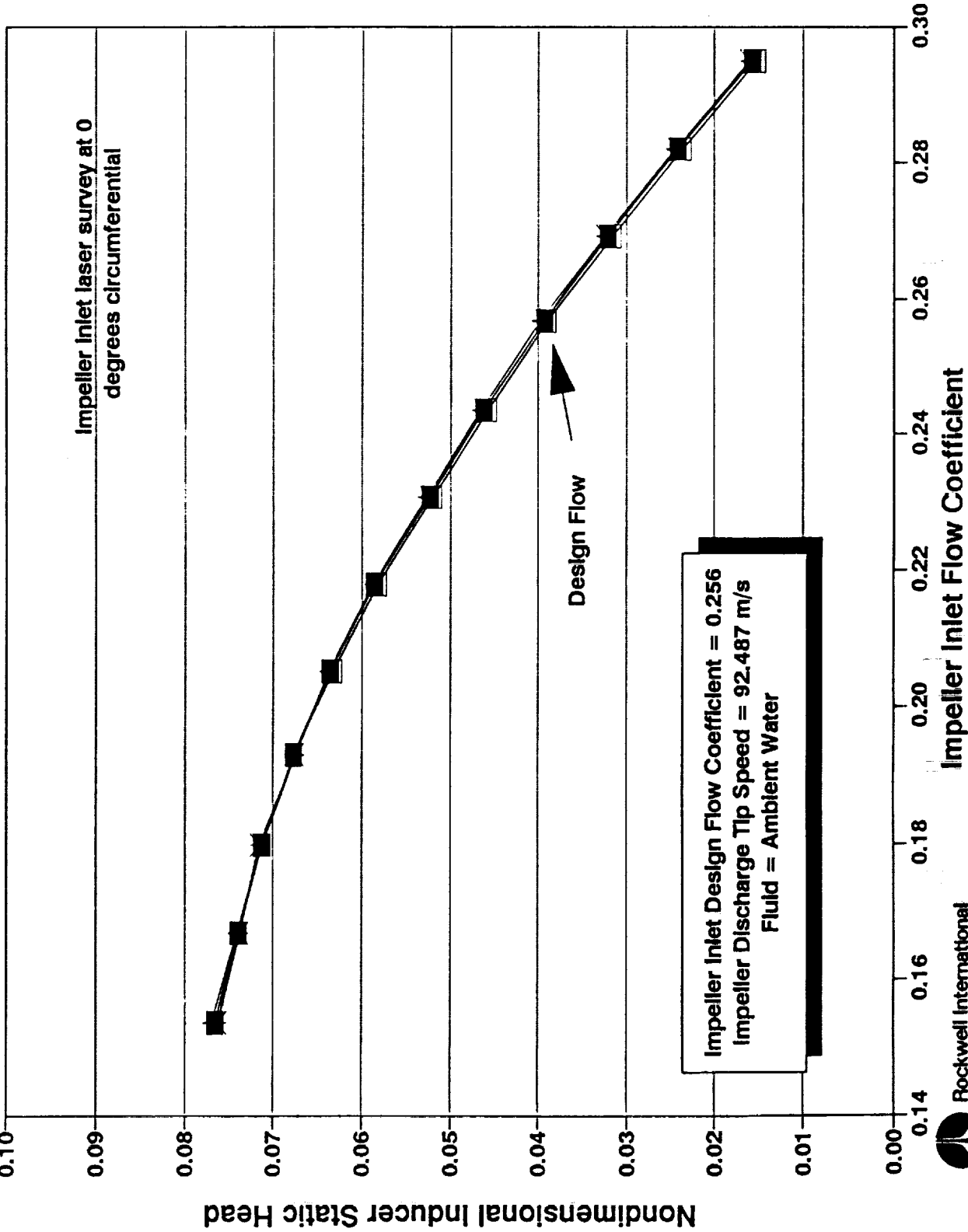

- Inducer Circum. Avg
- Inducer 60 degrees
- Inducer 180 degrees
- Inducer 330 degrees

PUMP CFD CODE VALIDATION TESTS

SSME HPFTP Impeller Inlet Laser Survey

Impeller Discharge Laser Survey Plane 2 (Middle)

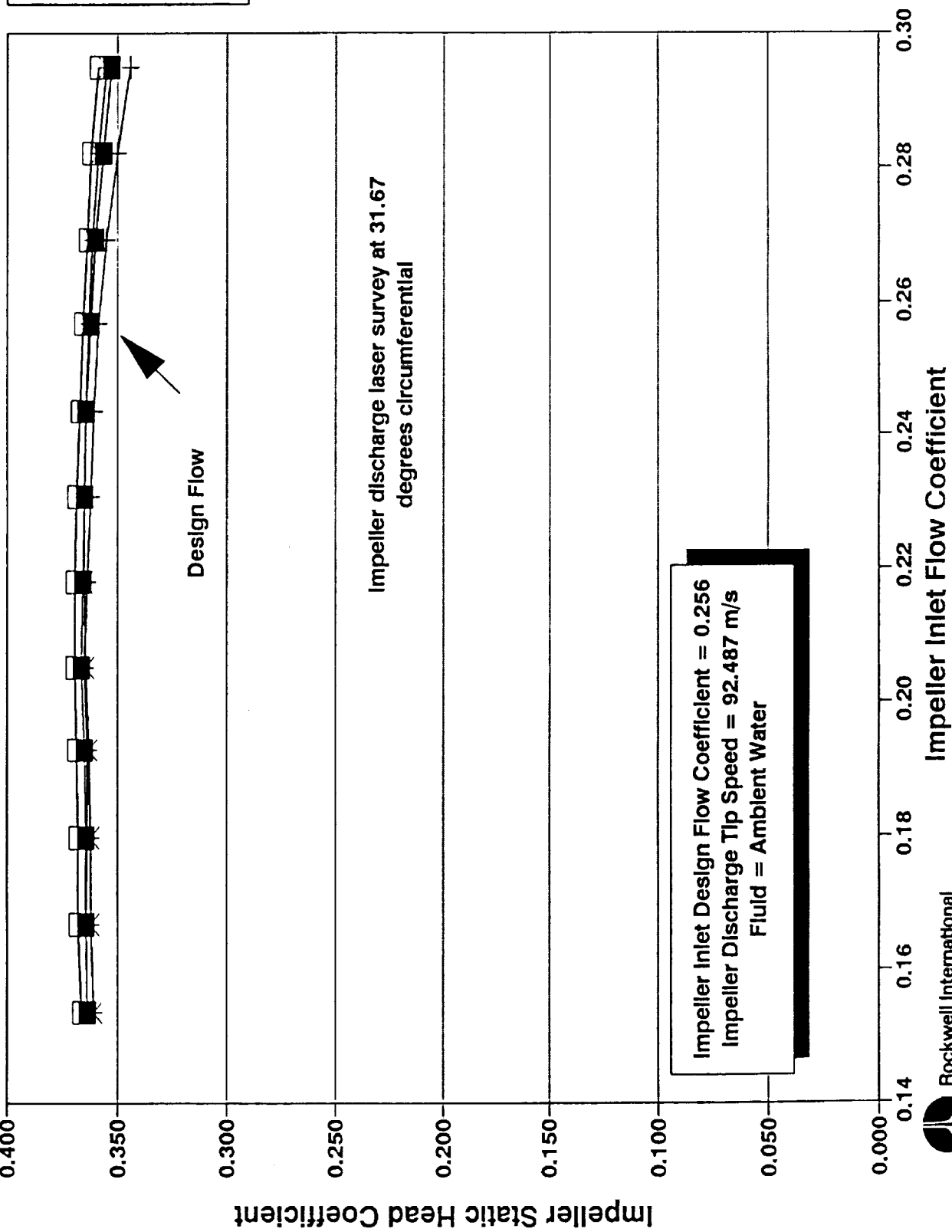

PUMP CFD CODE VALIDATION TESTS
SSME HPFTP Impeller Discharge Laser Survey Plane 1 (Impeller)
 Test Impeller Inlet Flow Coefficient = 0.256

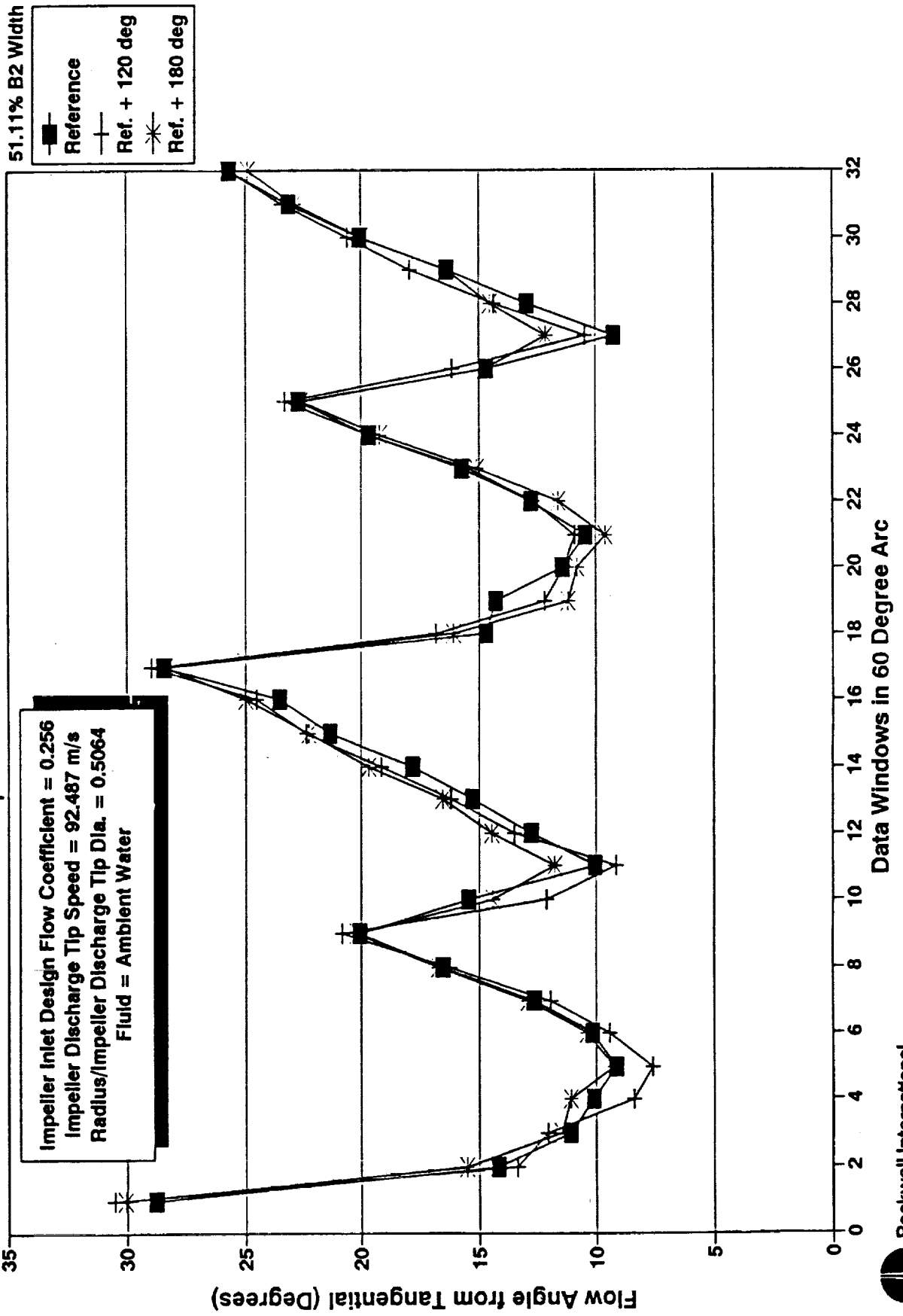

PUMP CFD CODE VALIDATION TESTS
SSME HPFTP Impeller Discharge Laser Survey Plane 1 (Impeller)
 Test Impeller Inlet Flow Coefficient = 0.256

51.11% B2 Width

■	Reference
+	Ref. + 120 deg
*	Ref. + 180 deg

Impeller Inlet Design Flow Coefficient = 0.256
 Impeller Discharge Tip Speed = 92.487 m/s
 Radius/Impeller Discharge Tip Dia. = 0.5064
 Fluid = Ambient Water

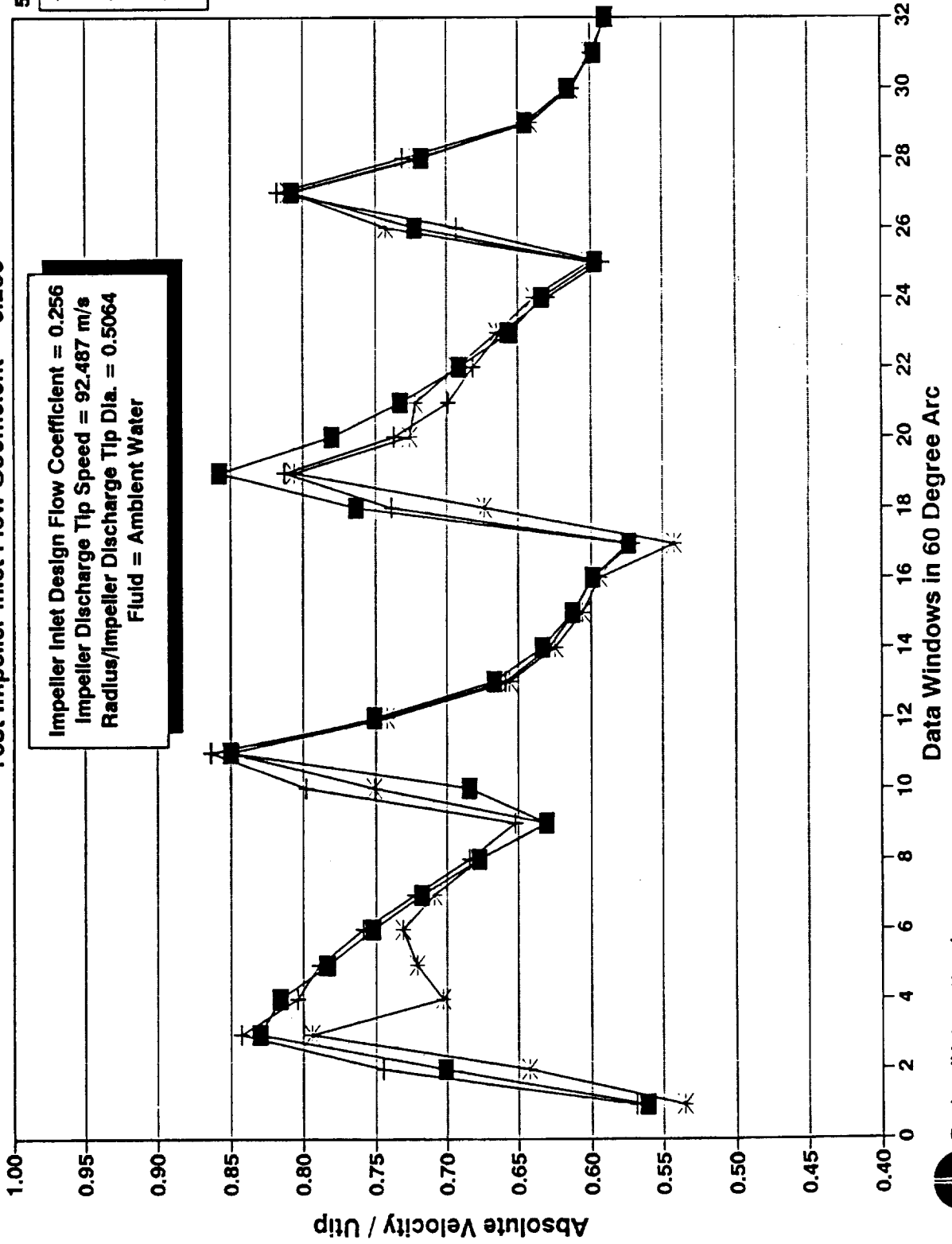

Data Windows in 60 Degree Arc

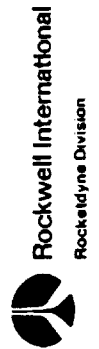

**PUMP CFD CODE VALIDATION TESTS
SSME HPFTP Impeller Inlet Laser Survey**

Test Impeller Inlet Flow Coefficient = 0.256

Nondimensional Axial
Plane

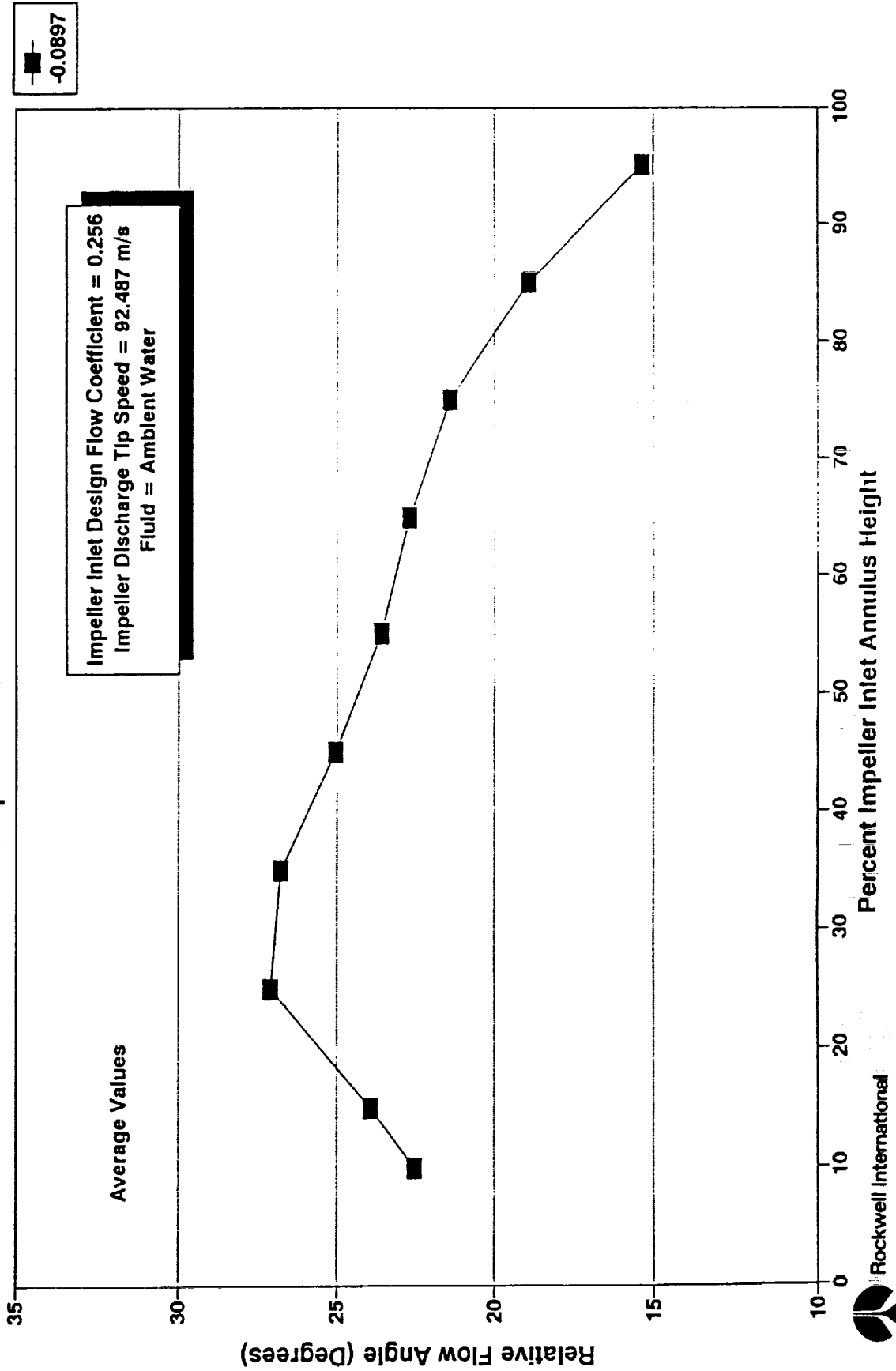

PUMP CFD CODE VALIDATION TESTS
SSME HPFTP Impeller Inlet Laser Survey
 Test Impeller Inlet Flow Coefficient = 0.256

Nondimensional Axial Plane

■ -0.0897

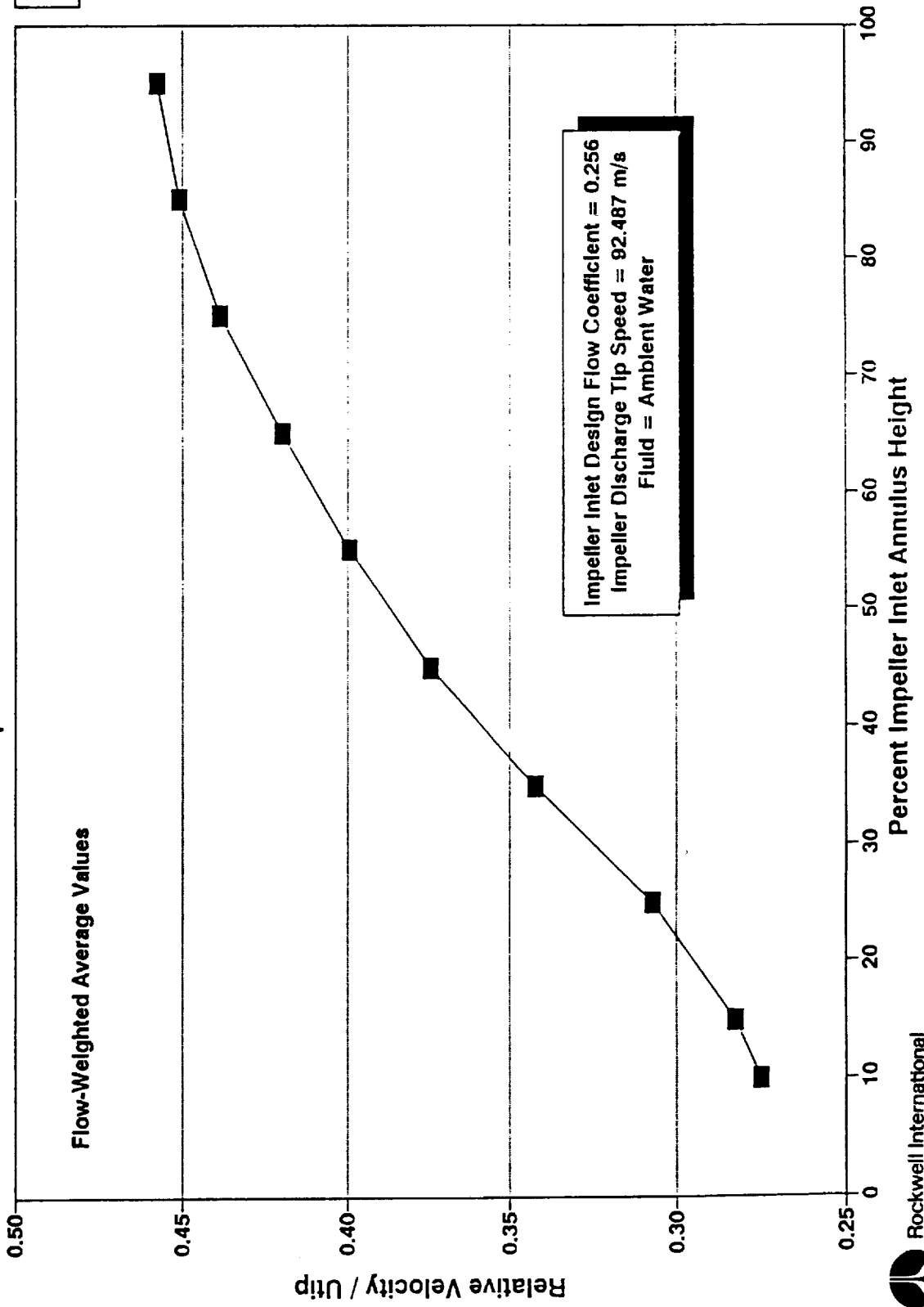

11 INCH SSME HPFTP IMPELLER LASER VELOCIMETER TEST DATA

R=5.833"

R=5.701"

R=5.570"

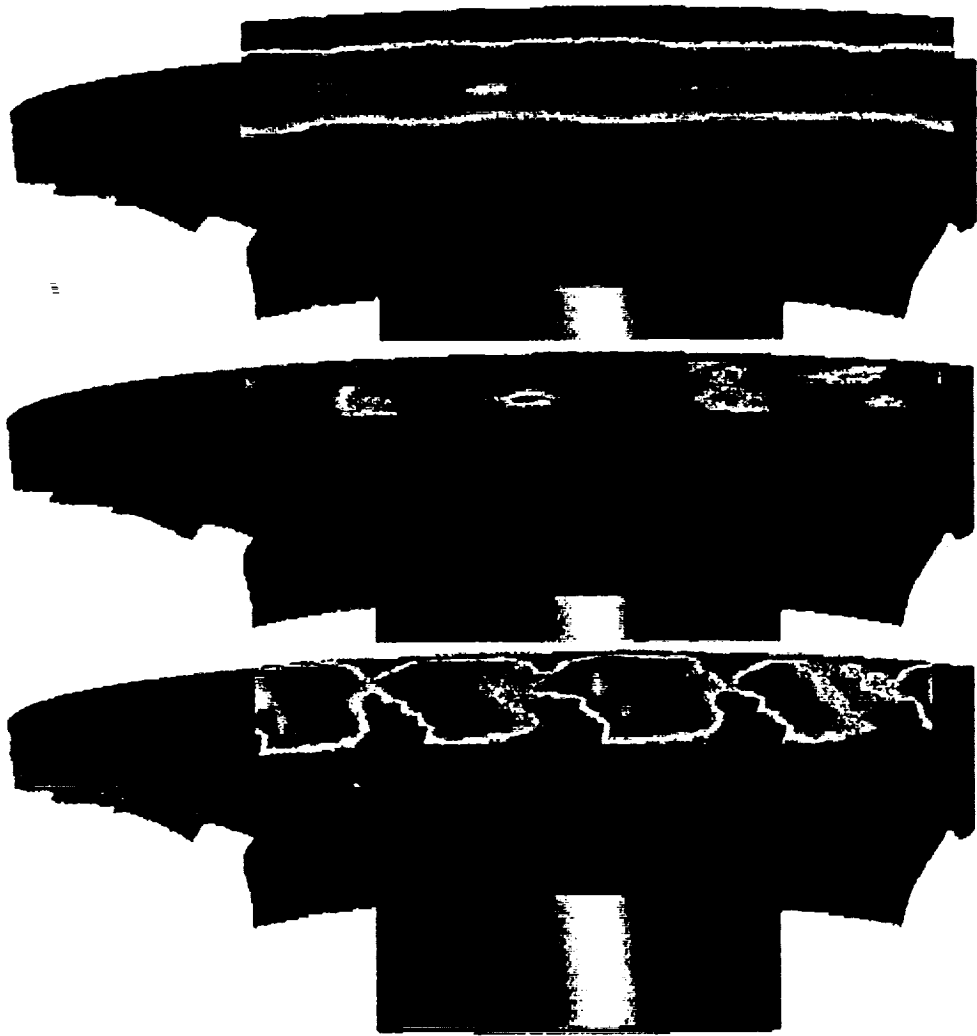

ABSOLUTE FLOW VELOCITY
REFERENCE FROM THERMOCOUPLER

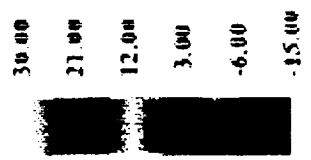

11 INCH SSME HPFTP IMPELLER
LASER VFI OCIMFTFR TEST DATA

ORIGINAL PAGE IS
OF POOR QUALITY

R=5.833"

R=5.701"

R=5.570"

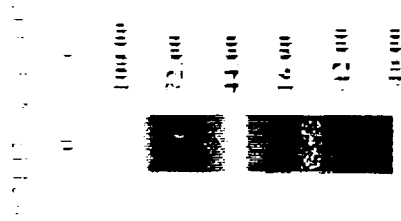
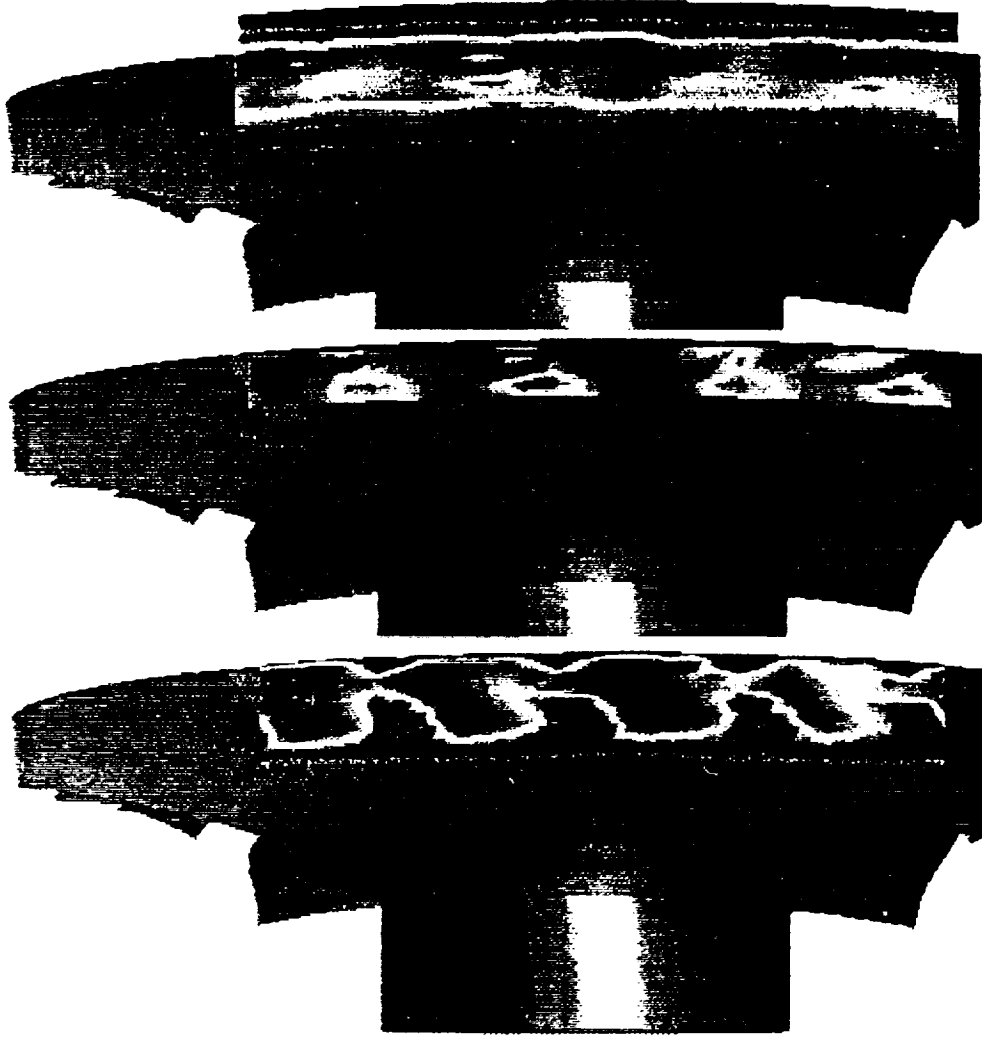

PUMP CFD CODE VALIDATION TESTS
LASER VELOCIMETER RESULTS
CONFIGURATION 2 - PUMP CONSORTIUM BASELINE IMPELLER

1676



LAB 04/22/93

PUMP CFD CODE VALIDATION TESTS

Configuration 2 - Laser Velocimeter Survey

- Data Integrity Checks
- Flow continuity
 - Impeller inlet plane - 98.2%
- Circumferential variation
 - Impeller inlet circumferential pressure variations within transducer accuracy
 - Adjacent impeller inlet passages exhibit similar flow velocities and angles
 - Impeller discharge middle plane exhibits minimal pressure variation
 - Adjacent impeller discharge passages exhibit similar flow velocities and angles
- Test conditions monitored over entire laser survey duration - repeatability shown

PUMP CFD CODE VALIDATION TESTS

Consortium Baseline Imp. Inlet Survey

Impeller Inlet Laser Survey Plane

Impeller Inlet Design Flow Coefficient = 0.144
 Impeller Discharge Tip Speed = 76.049 m/s
 Fluid = Ambient Water

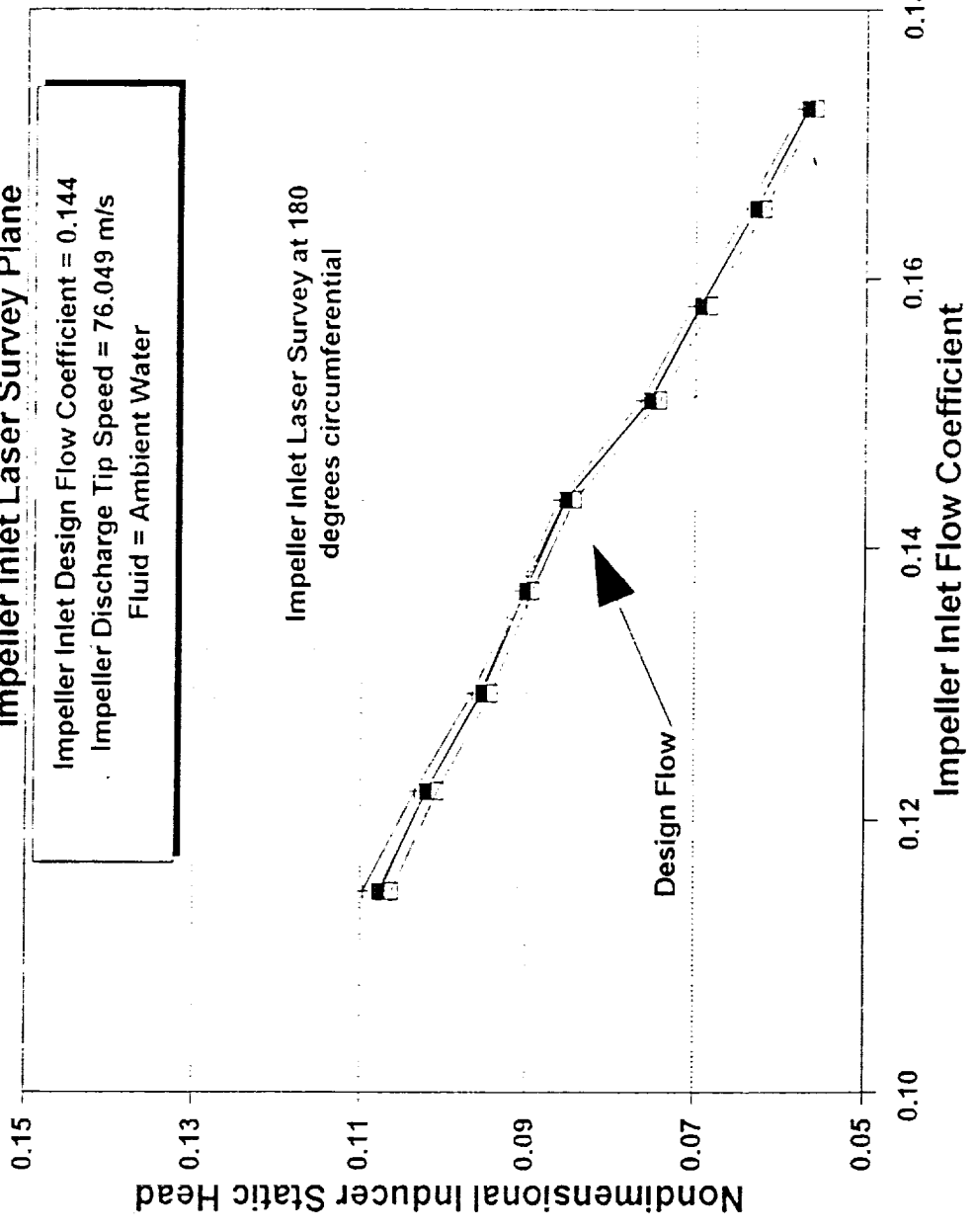
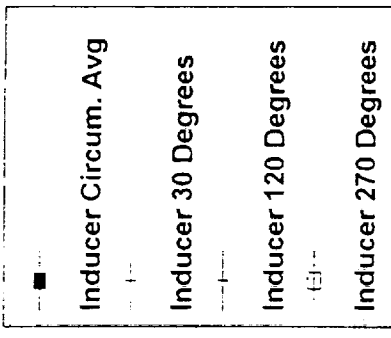

PUMP CFD CODE VALIDATION TESTS
Consortium Baseline Imp. Inlet Survey
Impeller Discharge Laser Survey Plane 2 (Middle)

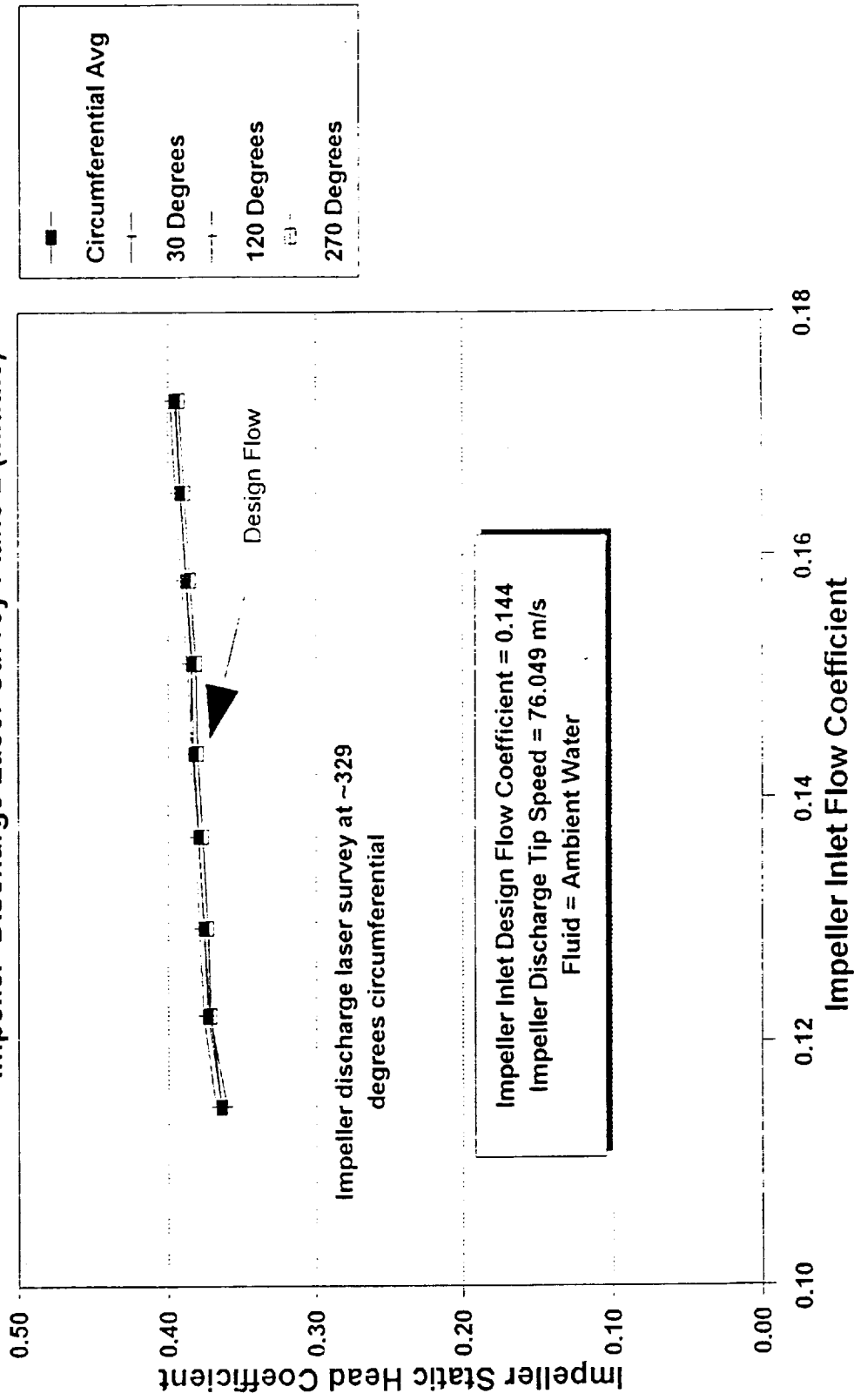

PUMP CFD CODE VALIDATION TESTS

Consortium Baseline Imp. Inlet Survey

Test Impeller Inlet Flow Coefficient = 0.144

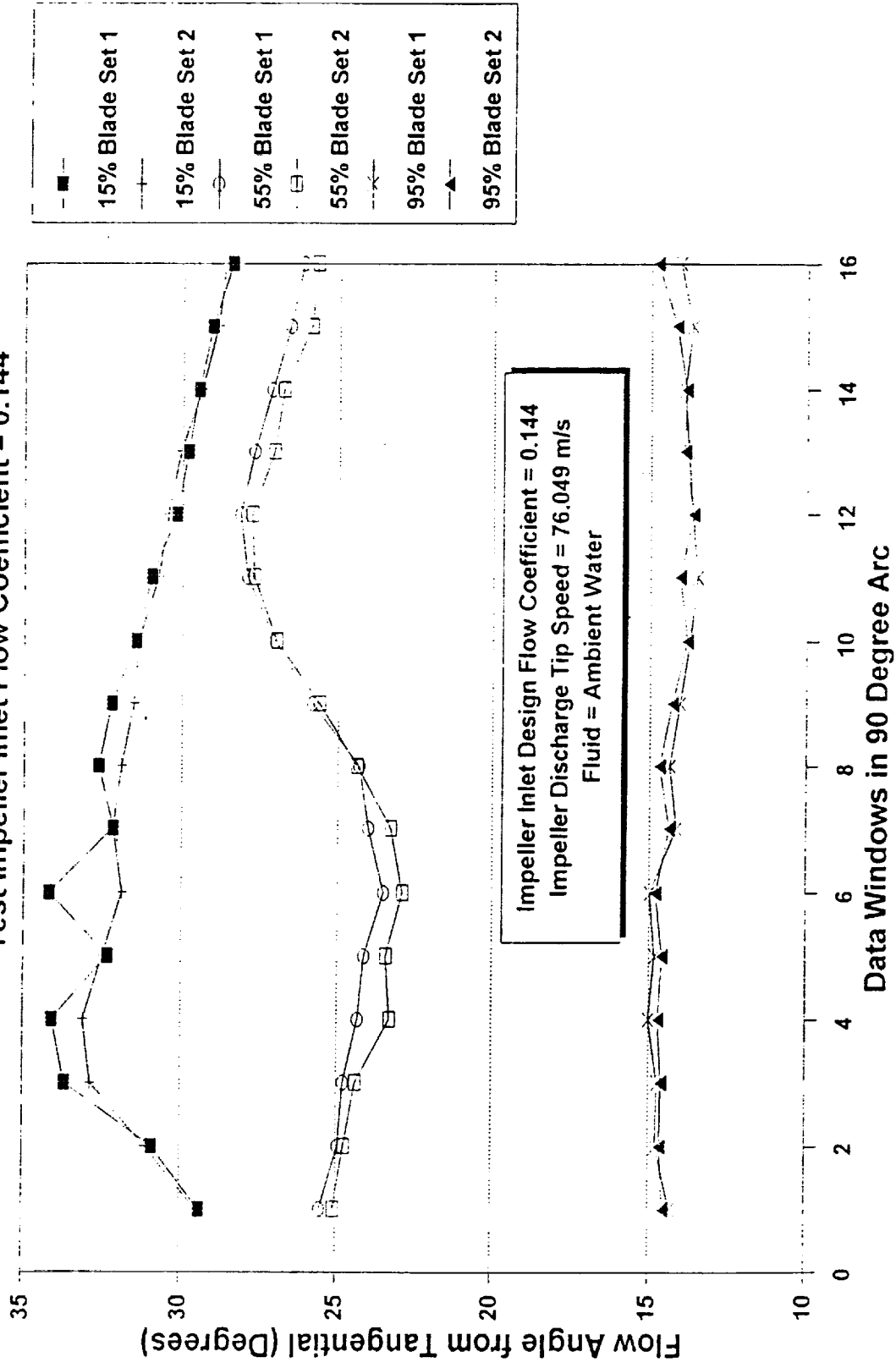

PUMP CFD CODE VALIDATION TESTS
Consortium Baseline Imp. Inlet Survey
Test Impeller Inlet Flow Coefficient = 0.144

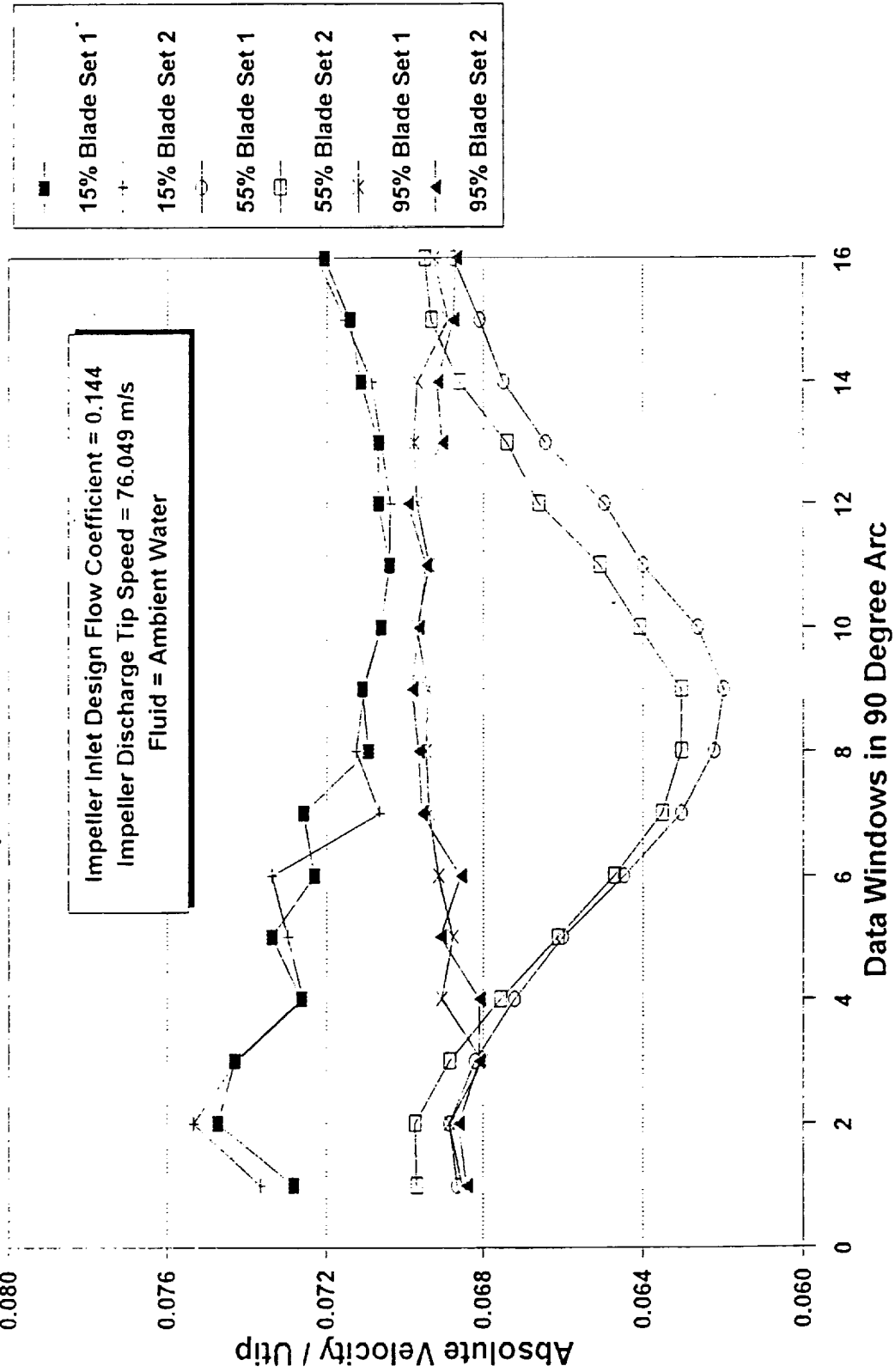

PUMP CFD CODE VALIDATION TESTS

Consortium Baseline Imp. Discharge Laser (Impeller)

Test Impeller Inlet Flow Coefficient = 0.144

50% B2 Width

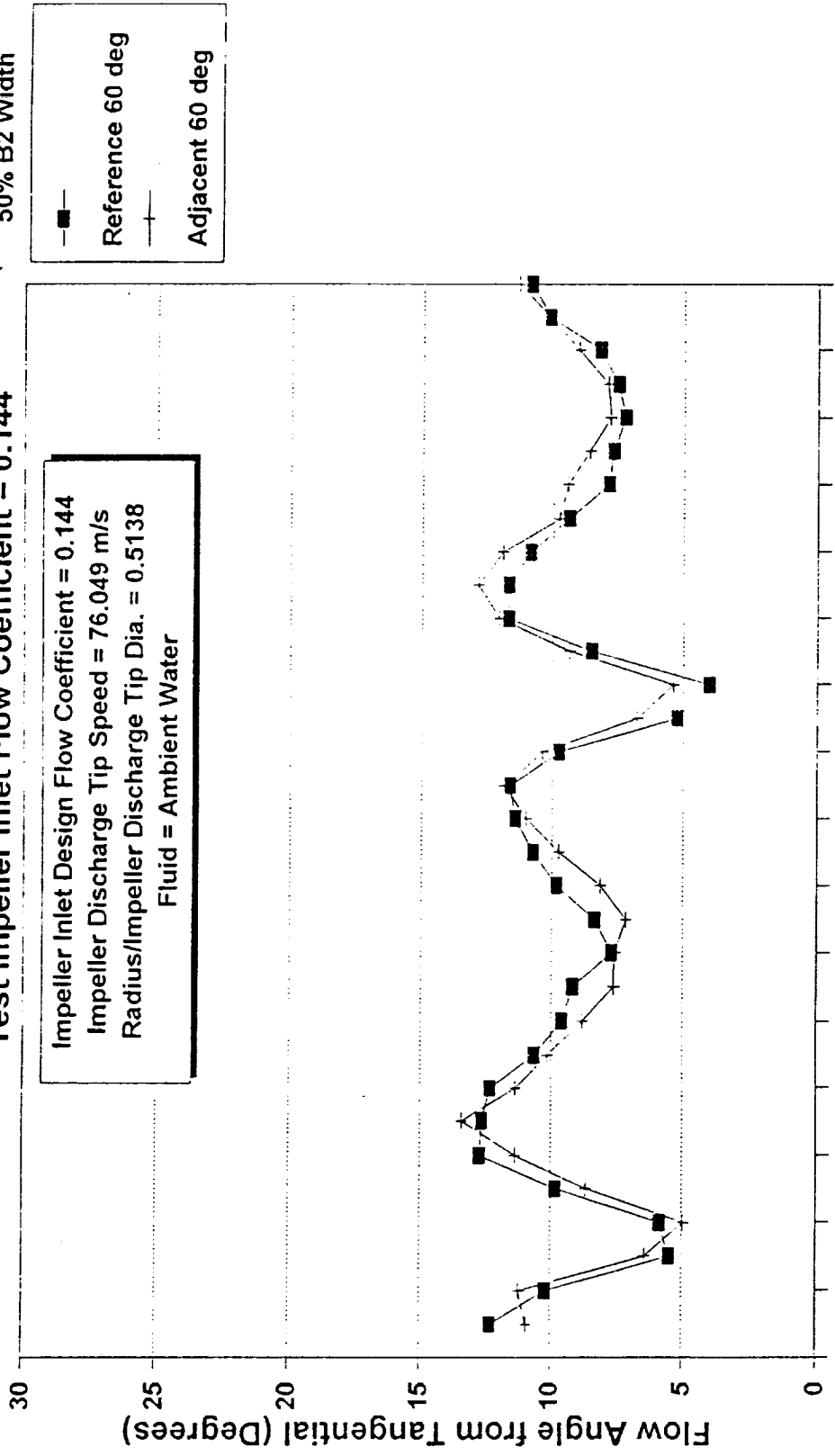

Impeller Inlet Design Flow Coefficient = 0.144
 Impeller Discharge Tip Speed = 76.049 m/s
 Radius/Impeller Discharge Tip Dia. = 0.5138
 Fluid = Ambient Water

50% B2 Width
 Reference 60 deg
 Adjacent 60 deg

Data Windows in 60 Degree Arc

PUMP CFD CODE VALIDATION TESTS

Consortium Baseline Imp. Discharge Survey (Impeller)

Test Impeller Inlet Flow Coefficient = 0.144

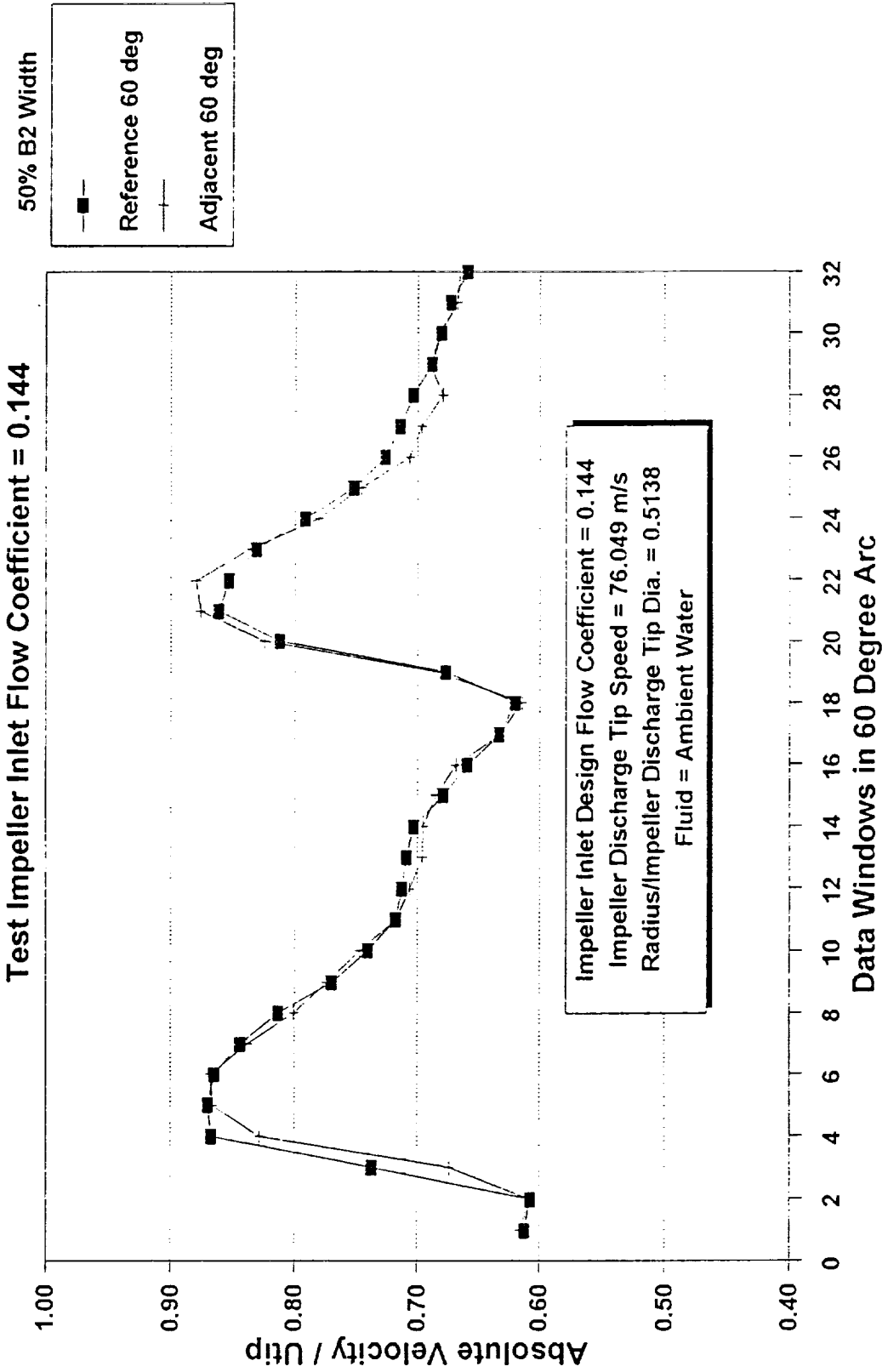

PUMP CFD CODE VALIDATION TESTS
Consortium Baseline Imp. Inlet Survey
 Test Impeller Inlet Flow Coefficient = 0.144

Nondimensional Axial Plane

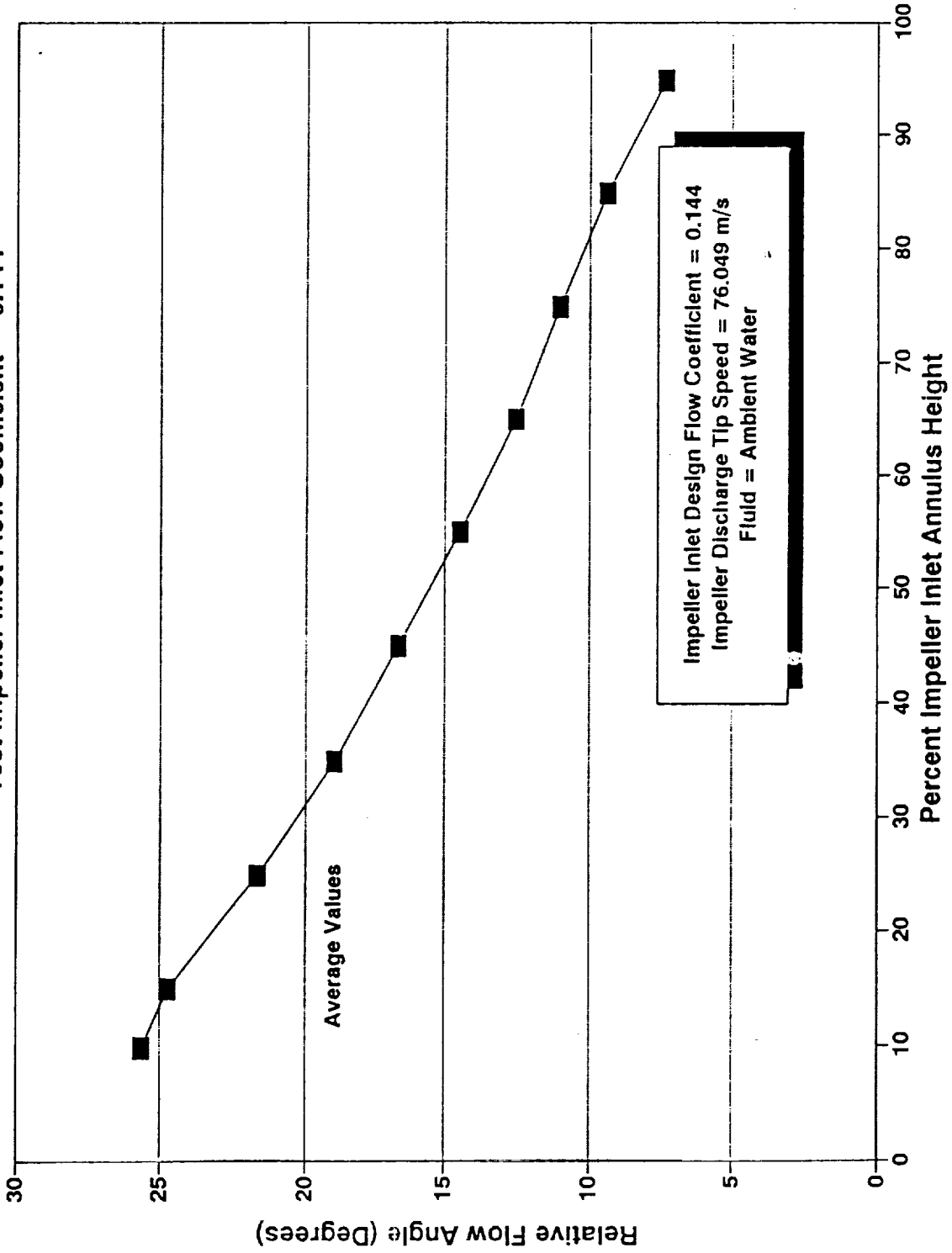
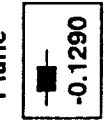

Impeller Inlet Design Flow Coefficient = 0.144
 Impeller Discharge Tip Speed = 76.049 m/s
 Fluid = Ambient Water

PUMP CFD CODE VALIDATION TESTS
Consortium Baseline Imp. Inlet Survey
Test Impeller Inlet Flow Coefficient = 0.144

Nondimensional Axial Plane

■ -0.1290

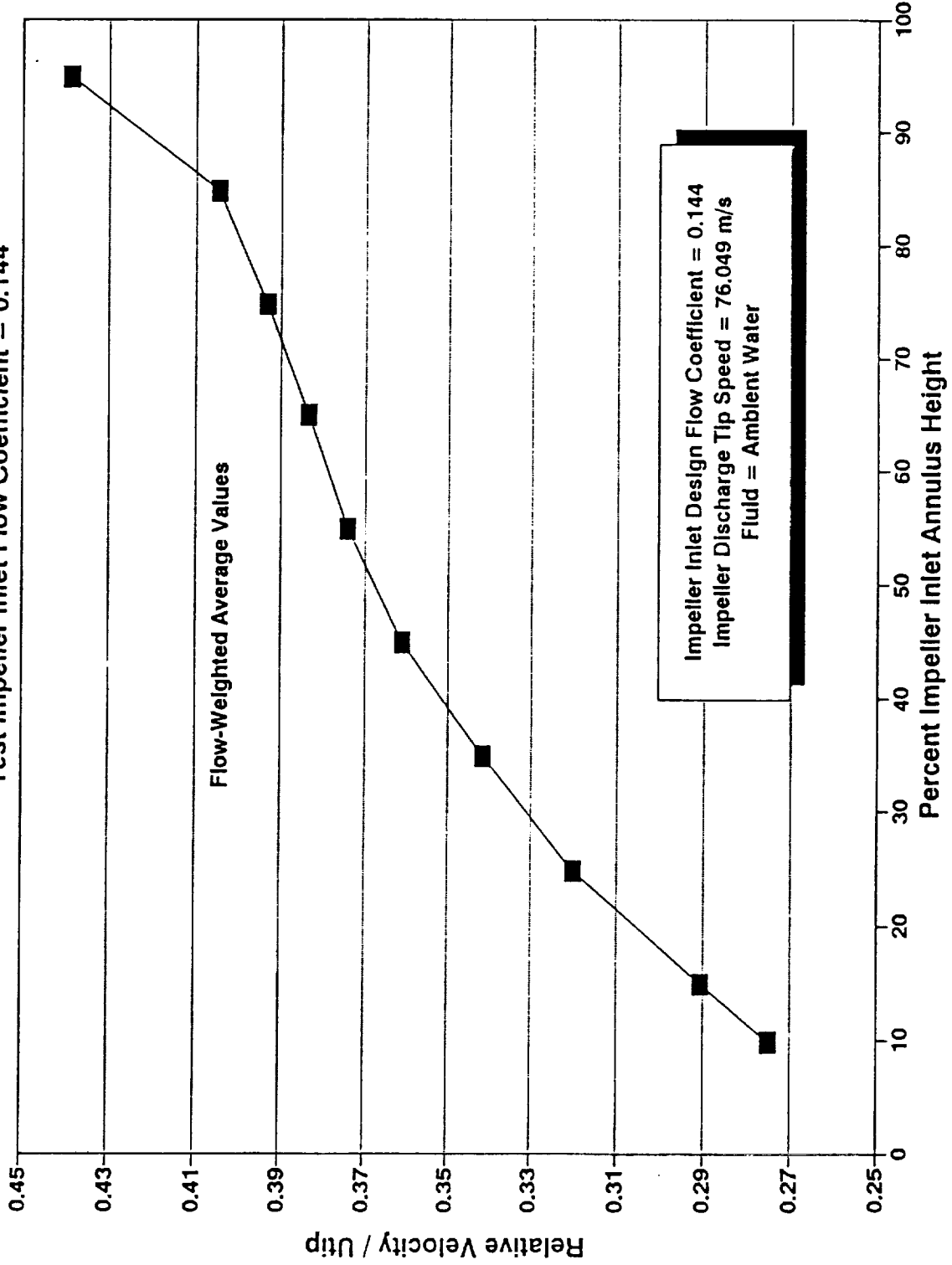

PUMP CFD CODE VALIDATION TESTS
Consortium Baseline Impeller Discharge Laser Survey
Nondimensional Radial Planes 0.5138, 0.5597, Impeller Inlet Flow Coefficient = 0.144
Absolute Flow Angle From Tangential (Degrees)

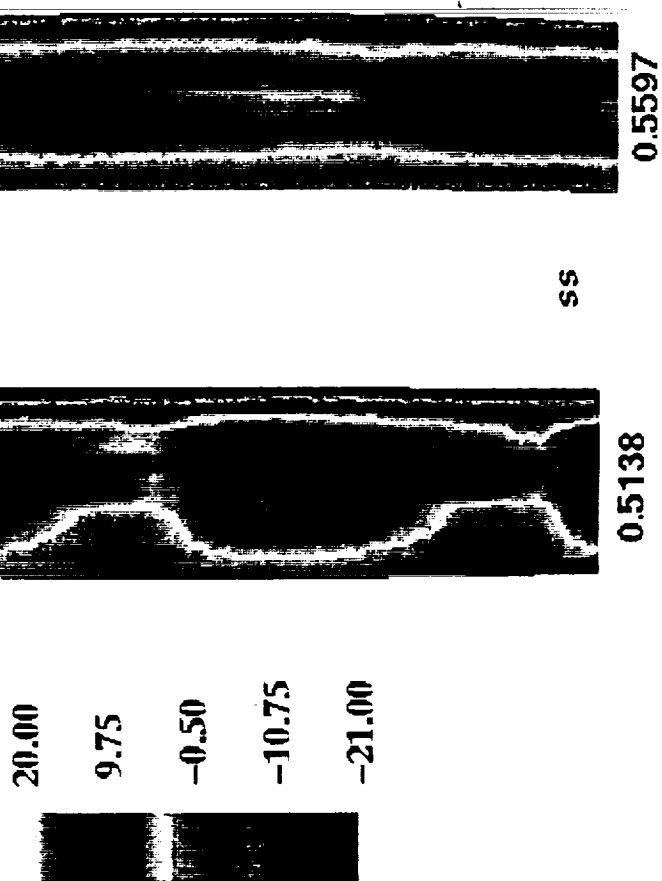

PUMP CFD CODE VALIDATION TESTS
Consortium Baseline Impeller Discharge Laser Survey
Nondimensional Radial Planes 0.5138, 0.5597, Impeller Inlet Flow Coefficient = 0.144

Nondimensional Absolute Velocity C

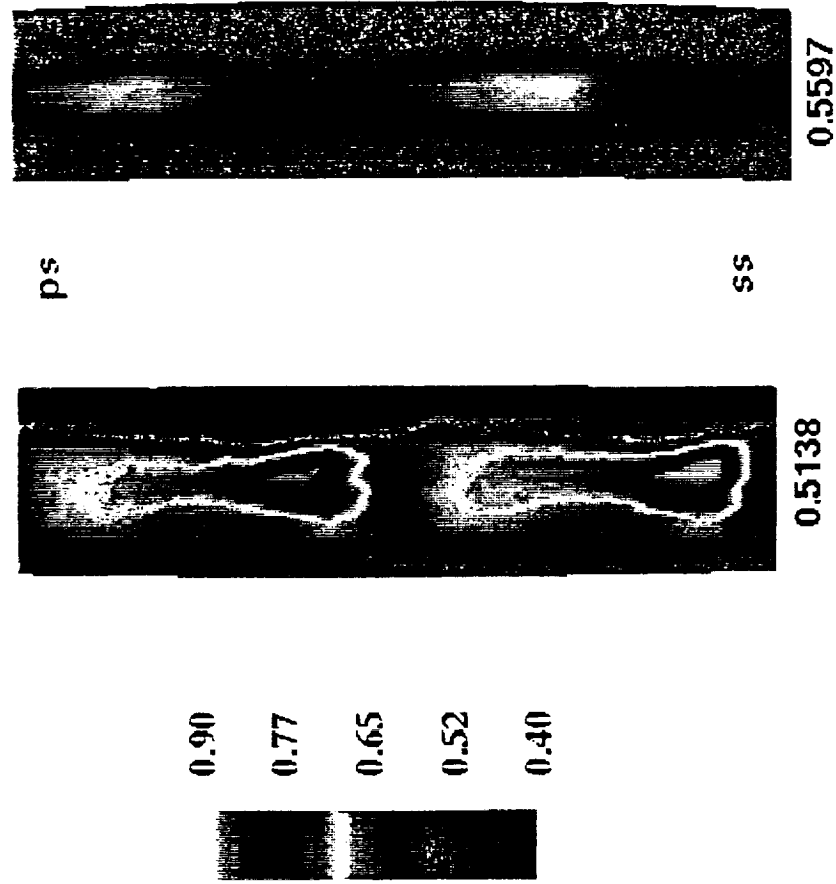

PUMP CFD CODE VALIDATION TESTS

Conclusion

- **Test Program Provides Essential Impeller Flow Data**
- **Detailed blade-to-blade flow characterization obtained**
- **Quality of laser velocimeter data substantiated**
- **No significant impeller discharge circumferential variation**
- **Test operating conditions demonstrated time independence**
- **Impeller laser surveys exhibited blade passage independence**
- **Impeller inlet flow continuity matches reinforces laser data accuracy**
- **Data available in PLOT3D format**