

1991 22422

N95-28843

A WEIGHT-EFFICIENT DESIGN STRATEGY FOR
CUTOUTS IN COMPOSITE TRANSPORT STRUCTURES*

S. G. Russell
J. Hangen
T. E. Palm

520-34

~~1992~~

Northrop Corporation
Aircraft Division
Hawthorne, California

ABSTRACT

Two design procedures for composite panels with cutouts are described and illustrated by example applications. One of these procedures uses a specialized cutout analysis code to obtain preliminary sizing information for the panel laminate, cutout padup, and cutout stiffener reinforcements. The other procedure uses a finite element based structural optimization code to develop a minimum weight panel design. The best features of both procedures form the basis of a design strategy for weight-efficient cutout panels.

INTRODUCTION

Composite structural concepts for commercial transport aircraft must possess significantly reduced weight relative to conventional metallic designs to be economically viable over the life of the aircraft. This need for weight savings has motivated substantial interest in the development of efficient design procedures and tailoring methods for composite aircraft structures. Cutout panels are one class of structural elements where these methods can be profitably applied to realize weight savings while satisfying strength requirements.

Numerous design and analysis procedures have been devised for composite structural elements containing cutouts. A number of the more commonly used procedures are discussed in Reference 1, which also introduces a new methodology for sizing composite panels subjected to prescribed loads. This methodology, which was developed at Northrop under NASA Contract NAS1-18842, contains procedures for sizing the cutout panel base laminate as well as the padups and stiffener reinforcements required to ensure that the panel meets strength requirements. Recently, an alternative approach using the finite element based design optimization code ASTROS (Reference 2) has also been applied to the cutout design problem. This procedure is attractive from the structural efficiency standpoint because it generates a minimum weight design for the cutout panel.

* This work was performed under NASA/Northrop Contract NAS1-18842 entitled "Innovative Structural Concepts for Supersonic Transports."

The purpose of this paper is to describe how the NASA/Northrop cutout design methodology (Reference 1) and the ASTROS optimal design methodology (Reference 2) can be used to provide a weight-efficient design strategy for cutouts in composite transport structures. To this end, both procedures are described and illustrated by examples. The weight savings potential associated with optimal design is illustrated for an application involving a highly loaded wing skin with access cutout. The roles of the NASA/Northrop and ASTROS design procedures in cutout applications are discussed. Finally, the best features of both techniques are combined to suggest a basic approach to weight efficient design of composite cutout panels. This approach is illustrated by revisiting the lower wing skin access cutout design used in the discussion of the optimal design methodology.

NASA/NORTHROP CUTOUT DESIGN METHODOLOGY

Under NASA contract, Northrop has developed a systematic preliminary design methodology for composite panels containing cutouts. The procedure uses modified Boeing design guidelines (Reference 3) to place bounds on the panel sizing problem. Base laminate, padup, and reinforcing stiffener sizing equations are then used to develop a panel design that satisfies the design guidelines and strength requirements. The NASA/Northrop procedure assumes a constant thickness base laminate, a fixed padup geometry, and a conventional picture-frame cutout stiffener arrangement.

The NASA/Northrop cutout design methodology requires an analysis procedure to predict panel strains and generate panel strength predictions. A specialized analysis code named RARICOM (Reference 4) was developed for this purpose. RARICOM uses the Rayleigh-Ritz method to perform stress analysis of stiffened panels with elliptical cutouts and padups under generalized in-plane loading conditions. The ratio of major to minor cutout dimensions must be less than 2. Panel strength predictions are generated using a generalized version of the average stress criterion (Reference 5).

The following paragraphs summarize design guidelines and sizing procedures for rectangular panels containing cutouts with padups. To permit application of the RARICOM code, elliptical cutout and padup geometries are assumed; however, the design methodology can be generalized to other cutout and padup geometries provided that suitable stress analysis techniques are available. An example involving design of a spar shear web containing an access cutout is provided to illustrate the methodology.

Design Guidelines

Consider a cutout panel with an integral padup reinforcement, as shown in Figure 1. In the thickness direction, the padup is assumed to be symmetric with respect to the mid-plane of the base laminate. The following guidelines are used for the sizing of the panel:

- (i) The panel is sized with the notched allowable design strains used for the design of panels without cutouts.
- (ii) The panel contains a minimum of 12.5 percent 0° plies, 25 percent ±45° plies, and 12.5 percent 90° plies.
- (iii) Cutout dimensions and panel dimensions as defined in Figure 1 satisfy the relations $a/S < 0.67$, $b/H < 0.5$.
- (iv) Reinforcing plies in the integral padup are placed so that the base laminate and padup region elastic constants are approximately equal.
- (v) The padup area dimensions defined in Figure 1 satisfy the relations $a_1 \geq 2a$, $b_1 \geq 2b$. The padup thickness dimension satisfies the relation $t_p \leq 3t$, where t_p is the padup thickness and t is the base laminate thickness.
- (vi) Ply dropoff rates from the padup region to the base laminate are $\leq 5^\circ$. A drop off rate of 2° is preferred if the panel can accommodate it.

These design guidelines provide bounds for the base laminate and padup sizing operations.

Base Laminate Sizing

Let N_x , N_y , N_{xy} be the panel design loads expressed as laminate stress resultants. The following equations determine the number of plies required for each major ply orientation in the base laminate:

$$\begin{aligned}
 \# 0^\circ \text{ plies} &= \frac{2N_x}{E_1^t \epsilon_1^t t \text{ ply}} \\
 \# 45^\circ \text{ plies} &= \frac{2N_{xy}}{E_1^t \epsilon_1^t t \text{ ply}} \\
 \# -45^\circ \text{ plies} &= \frac{-2N_{xy}}{E_1^c \epsilon_1^c t \text{ ply}}
 \end{aligned} \tag{1}$$

$$\# 90^\circ \text{ plies} = \frac{2N_y}{E_1^t \epsilon_n^t t_{\text{ply}}}$$

where E_1^t , E_1^c are the ply elastic moduli in the fiber direction; ϵ_n^t , ϵ_n^c are notched tension and compression design allowable strains, and t_{ply} is the ply thickness. The factor of 2 in these equations is intended to reduce the amount of reinforcing material required in padups. This minimizes the thickness discontinuity caused by the padup and makes it easier for padup designs to satisfy the thickness dimension guideline introduced previously.

The results of Equation (1) can be used to establish a practical layup for the cutout panel base laminate. Strength analysis by RARICOM or other suitable procedures then provides a margin of safety MS for the unreinforced cutout panel. If $MS > 0$, the panel is adequately sized and there is no need for panel reinforcement. If $MS < 0$, a padup design can be generated.

Padup Sizing

Padups are required when the margin of safety MS for strength failure of the unreinforced cutout panel is less than zero. The padup sizing can be performed by the following steps:

- (i) Let MS be the margin of safety from the strength analysis of the unreinforced panel ($MS < 0$). An initial estimate for the padup region layup can be obtained by multiplying the base laminate ply requirements from Equation (1) by the factor $1/(1+MS)$. Padup area dimensions a_1 and b_1 are set at their minimum permissible values, $a_1 = 2a$ and $b_1 = 2b$. The padup area dimensions a_2 and b_2 are calculated to satisfy the ply dropoff guideline quoted previously. For the initial padup design, RARICOM can be used to determine an updated margin of safety. Let this result be $MS^{(1)}$.
- (ii) If $MS^{(1)} < 0$, repeat Step (i) using $MS^{(1)}$ in place of MS. Let the updated margin of safety be $MS^{(2)}$.
- (iii) If $MS^{(2)} < 0$, additional updated estimates for the padup thickness can be generated from the previous two estimates by the Secant Method:

$$t_p^{(i)} = t_p^{(i-1)} - \frac{MS^{(i-1)}[t_p^{(i-1)} - t_p^{(i-2)}]}{MS^{(i-1)} - MS^{(i-2)}} \quad (2)$$

where i is the iteration number, $i \geq 3$. It will be necessary to specify a padup layup and calculate new padup elastic constants for each padup thickness t_p calculated in this manner.

The padup sizing procedure terminates when a positive margin of safety is obtained.

For highly loaded panels, it is often impossible to specify a padup that satisfies the guidelines for thickness, areal dimensions, and ply dropoffs. In these cases, the cutout panel with a permissible padup design can be further reinforced by picture frame stiffeners surrounding the cutout. The logic of the stiffener sizing procedure, discussed in References 1 and 4, is similar to the padup sizing procedure except that stiffener axial stiffness is used as the design variable in the iterations. Alternately, the base laminate can be thickened and the padup sizing procedure repeated.

Example: Spar Shear Web With Cutout

To illustrate the NASA/Northrop design methodology, consider a 20 inch by 20 inch spar shear web with a 6 inch diameter central circular cutout, as shown in Figure 2(a). The shear web is fabricated from AS/3501-6 graphite/epoxy material. The ply properties and notched allowable design strains for 250°F/wet conditions are

$$\begin{array}{lll}
 E_1^t = 18.7 \text{ Msi} & \nu_{12} = 0.30 & \epsilon_{n=}^t = 4550\mu \\
 E_1^c = 17.3 \text{ Msi} & G_{12} = 0.42 \text{ Msi} & \epsilon_{n=}^c = -4550\mu \\
 E_2^t = 1.74 \text{ Msi} & t_{\text{ply}} = 0.0052 \text{ in} & \\
 E_2^c = 0.91 \text{ Msi} & &
 \end{array}$$

The design loads for the shear web are $N_x = N_y = 0$, $N_{xy} = 1500 \text{ lb/in}$.

Following base laminate sizing by Equation (1), a (14/72/14) layup, i.e. 14 percent 0° plies, 72 percent $\pm 45^\circ$ plies, and 14 percent 90° plies, was selected. The resulting base laminate thickness was $t = 0.1456 \text{ in}$, with 4 0° plies, 10 $\pm 45^\circ$ ply sets, and 4 90° plies. A RARICOM strength analysis for the unreinforced cutout panel gave $MS = -0.412$. Figure 3 shows the critical strain distribution for this case, which occurs along the x' axis oriented 45° counterclockwise with respect to the x axis.

To alleviate the strain concentration around the padup, the padup sizing feature of the NASA/Northrop design methodology was applied. With $1/(1+MS) = 1.7 \approx 2$, the initial padup region thickness was $t_p = 0.2912 \text{ in}$, which is twice the thickness of the base laminate. Setting $a_1 = 2a = 6 \text{ in}$, $b_1 = 2b = 6 \text{ in}$ and using a 2° ply dropoff angle, the outer padup dimensions were found to be $a_2 = b_2 = 8.1 \text{ in}$. Laminate elastic constants for the padup and base laminate regions were taken to be equal. A schematic of the padup reinforced panel design is shown in Figure 2(b).

Execution of the RARICOM strength analysis for the initial padup design yielded $MS = 0.086$, which is satisfactory for design purposes. Figure 3 shows the critical strain distribution for the padup-reinforced panel.

OPTIMAL DESIGN METHODOLOGY

For highly loaded structure, substantial amounts of material are often required to attain acceptable margins of safety. Significant weight savings can be realized by using a minimum weight structural optimization procedure in place of conventional approaches in this class of design problems. Cutout design problems in highly loaded structure are good candidates for optimal design since substantial ply buildups or padups are usually placed around the periphery of the cutout to meet strength requirements.

Under NASA/Northrop Contract NAS1-18842, minimum weight designs for cutout panels have been obtained using ASTROS, a finite element based structural optimization code developed at Northrop under Air Force contract (Reference 2). ASTROS is a multidisciplinary optimization tool capable of generating minimum weight structural designs based on strength, aeroelastic, buckling, and flutter constraints. The present paper considers only minimum weight cutout panel designs based on strength constraints.

Finite element modeling of flat composite panels with cutouts can be accomplished using triangular membrane, isoparametric quadrilateral membrane or quadrilateral shell elements available in the ASTROS element library. The membrane elements lump all plies of common orientation in the laminate into a layer. The thicknesses of these layers are design variables in the optimization process. The shell element, which models both membrane and bending deformation, possesses the general capability to treat individual plies of a laminate as separate design variables.

In principle, the layer thickness variables for every element in a structural model could be used as independent variables in the optimization process. This practice, however, would make the optimization process very unwieldy. To reduce the optimization problem to a tractable level, ASTROS offers an option called shape function linking. Shape function linking allows the user to define element layer thicknesses over a specified region of the structure by means of a polynomial shape function. The shape function is of the form

$$t(\xi, \eta) = \sum_{i=1}^3 \sum_{j=1}^3 a_{ij} \xi^{i-1} \eta^{j-1} \quad (3)$$

where t is the layer thickness variable, and ξ and η are local coordinates spanning the specified region of the structure. Equation (3) defines local design variables, or element layer thicknesses, as the weighted sum of several global design variables, the coefficients a_{ij} . The global variables a_{ij} are then adjusted during the optimization process.

The minimum weight design of cutout panels is carried out by constraining fiber direction strains in 0° , $+45^\circ$, -45° , and 90° layers of composite shell elements to lie within a specified range defined by tension and compression allowable strains. Additional constraints on percentage of plies with a particular orientation can also be used. These constraints allow the user to satisfy minimum gage requirements as well as practical ply distribution guidelines for composite laminates.

The ASTROS code uses a mathematical programming procedure based on the MICRO-DOT algorithm to obtain the minimum weight design. The MICRO-DOT algorithm (References 6 and 7) is a direct optimization method that uses constraint information directly in the optimization process. It combines features from feasible directions (Reference 8) and generalized reduced gradient (Reference 9) algorithms to provide an efficient search procedure. ASTROS terminates the optimization procedure when the structural weight change following a redesign operation differs by less than 0.5 percent from the previous iteration.

Example: Lower Wing Skin With Access Cutout

Consider a 90 in by 30 in rectangular lower wing skin panel with an 18 in by 10 in elliptical access cutout as shown in Figure 4. The panel is fabricated from IM7/5260 composite material. The ply properties and allowable design strains are

$$\begin{array}{lll}
 \begin{array}{l} t \\ E_1 = 22.0 \text{ Msi} \end{array} & \begin{array}{l} \nu_{12} = 0.32 \end{array} & \begin{array}{l} t \\ \epsilon_n = 7350\mu \end{array} \\
 \begin{array}{l} c \\ E_1 = 22.0 \text{ Msi} \end{array} & \begin{array}{l} G_{12} = 0.86 \text{ Msi} \end{array} & \begin{array}{l} c \\ \epsilon_n = -4600\mu \end{array} \\
 \begin{array}{l} t \\ E_2 = 1.4 \text{ Msi} \end{array} & \begin{array}{l} t \\ \text{ply} = 0.0052 \text{ in} \end{array} & \\
 \begin{array}{l} c \\ E_2 = 1.4 \text{ Msi} \end{array} & &
 \end{array}$$

The design loads for the panel are $N_x = 30,000 \text{ lb/in}$, $N_y = N_{xy} = 0$.

The ASTROS finite element mesh for minimum weight design of the panel is shown in Figure 5. Due to the symmetry of the deformation and loading, the model was restricted to a single panel quadrant. Thirty-seven QUAD4 shell elements were used to discretize the panel quadrant.

The shape function linking option in ASTROS was used to formulate the panel sizing optimization problem. For this purpose, nine thickness shape function variables spanning various regions of the panel were defined. The shape function variables allow for constant or linear layer thickness variation over all or part of the panels, as defined by the shaded regions shown in Figure 6. As discussed previously, the shape function variables are adjusted in the optimization procedure to obtain the minimum weight panel design.

For modeling of the composite skin laminate, the QUAD4 elements were divided into 0°, 45°, -45°, and 90° layers. The following constraints were imposed:

- (i) layer thickness of no less than 10 percent of the total panel thickness
- (ii) 0° layer thickness of no more than 60 percent of the total panel thickness
- (iii) minimum layer thickness of 0.10 inch, leading to a minimum laminate thickness of eight plies
- (iv) equal 45° and -45° layer thicknesses

Subject to these restrictions, the layer thicknesses were each allowed to vary as defined by the shape functions shown in Figure 6.

A schematic of the minimum weight wing skin panel design is shown in Figure 7. Thickness contours are shown to illustrate the distribution of material in the minimum weight solution. Outside the immediate vicinity of the cutout, the laminate ply mix varies little from a (60/30/10) arrangement. Along the cutout periphery, the laminate ply mix varies from (60/20/20) at the point of maximum tensile stress concentration, at the intersection with the ellipse minor axis, to (10/66/24) at the point of maximum compressive stress concentration, at the intersection with the ellipse major axis. The maximum laminate thickness of 0.913 inch occurs along the cutout periphery in the region of maximum tensile stress concentration.

In the ASTROS design, the thickness is reinforced along the longitudinal edges of the panel to divert load away from the cutout region. The overall design suggests longitudinal stiffening for cutout load relief, and a localized padup to relieve stress and strain concentration effects adjacent to the hole.

DISCUSSION OF PANEL DESIGN APPROACHES

The two design approaches discussed in previous sections can be used to formulate a weight efficient strategy for design of cutout panels in composite aircraft structures. The key to this strategy is an understanding of the strengths and weaknesses of each methodology, and an appreciation of the appropriate role of each technique in the design process. By exploiting the strengths of each approach, a realistic, weight-efficient panel design can be obtained.

The NASA/Northrop design methodology, and its counterpart analysis code RARICOM, are most effective when used in the preliminary stages of the cutout design process. Preliminary design requires iterative use of stress and strength analysis procedures to establish initial sizing information for the panel base laminate and conventional reinforcement details, such as padups and stiffener frames around the cutout. The RARICOM code is well-suited for this

purpose, since these characteristics of the design can be varied and re-evaluated with minimal effort. RARICOM is also useful for evaluation of localized cutout effects, such as the influence of panel reinforcement details on stress and strain gradients at the periphery of the hole.

With its foundation in modified Boeing cutout design guidelines (Reference 3), the NASA/Northrop procedure produces conservative panel designs that converge rapidly to satisfy panel strength requirements. The panel base laminate is designed to two times the prescribed load level so that reinforcement details can be sized to satisfy design guidelines. Failure assessment is based upon notched strain allowables for the composite material system. The simplicity of the reinforcement details considered in the NASA/Northrop methodology makes these designs relatively simple to manufacture.

The ASTROS code provides an optimal design methodology that can be used to obtain minimum weight designs for cutout panels. ASTROS designs satisfy strength requirements, based on an evaluation of the maximum strain failure criterion in each element. Rod elements with negligible stiffness connect the nodes along the cutout periphery to facilitate evaluation of the failure criterion in regions of maximum stress and strain concentration. Finite element mesh refinement around the cutout is necessary to accurately model stress and strain gradients at the periphery of the hole.

Some ASTROS designs may be difficult to manufacture, particularly if a large number of shape functions are used in the optimization process. Despite this shortcoming, the ASTROS design is extremely valuable for identifying material distribution trends for weight-efficient design. An example of this type of trend was shown in Figure 7, where ply buildups were placed along the longitudinal edges of the panel to channel load away from the cutout region. This feature of the ASTROS solution could be easily implemented to obtain weight savings in the final panel design.

WEIGHT EFFICIENT DESIGN STRATEGY

The strengths of the two design approaches discussed in this paper can be exploited to develop a weight efficient design strategy for composite cutout panels in transport aircraft structures. This strategy consists of four steps: conventional and optimal sizing, design revision, and final analysis.

Step 1: Conventional Sizing

Conventional sizing consists of sizing the base laminate, padup, and stiffener reinforcements for the prescribed design loads. The NASA/Northrop design methodology and RARICOM analysis code are useful for this purpose, since they provide a systematic approach for evaluating these features of the panel. Results of the conventional sizing step can be viewed as a first attempt at the panel design.

Step 2: Optimal Sizing

Optimal sizing of the cutout panel can be accomplished using the ASTROS computer code. As a first step, the results of the conventional sizing are converted into a finite element model. After an ASTROS solution is obtained, weight savings associated with the minimum weight design can be evaluated by comparison with the conventional design in Step 1. If the weight savings prove to be minimal, the conventional design can be prepared for manufacturing implementation.

Step 3: Design Revision

Weight savings associated with the optimal design may indicate a number of improvements that can be made to the conventional design. In these cases, general material distribution trends from the optimal design can be assessed to reveal base laminate and padup design features that can be made more weight efficient.

In the design revision process, panel design features must be modified with manufacturing producibility in mind. Simple spanwise and chordwise ply buildups and dropoffs can be used to tailor the base laminate. Care must be taken to ensure that ply buildups and dropoffs are sufficiently gradual to facilitate smooth load transfer throughout the panel. Otherwise, structural discontinuity effects could induce out-of-plane failure of the panel.

ASTROS designs for the localized padup around the cutout must be examined with care. The optimal solution tends toward a variable thickness padup with variable fiber orientation around the periphery of the hole. This design is difficult to manufacture and may not reflect the influence of localized stress and strain gradients immediately adjacent to the hole. The padup configuration used in the NASA/Northrop design methodology, which features a constant thickness padup surrounding the hole and a linear ply dropoff between the padup and base laminate, is more appropriate for the final design.

Step 4: Final Analysis

After the revised panel design is obtained, the structural model of the conventional panel design must be modified to incorporate design changes. This model can be used to establish final safety margins for the cutout panel.

Example: Lower Wing Skin Access Cutout Revisited

To illustrate the application of the weight efficient design strategy, consider the lower wing skin access cutout design used in the discussion of the optimal design methodology. The first step in the strategy involves conventional sizing with the NASA/Northrop design methodology and RARICOM analysis code. Using the panel design data given previously, the preliminary cutout panel design is shown in Figure 8. The base laminate contains a (61/25/14) ply mix with total thickness of 0.6136 inch. An elliptical padup with identical ply mix is used to reinforce the cutout.

The elliptical padup in the preliminary design attains a maximum thickness of 1.0296 inch at the cutout boundary and is blended into the base laminate by a linearly tapered ply dropoff region. Referring to Figure 1, the

padup areal dimensions are $a_1 = 10$ in, $b_1 = 6$ in, $a_2 = 12.5$ in, $b_2 = 8.5$ in. Picture frame stiffeners with axial stiffness $EA = 22 \times 10^6$ lb are required to eliminate negative strength margins in the compressive stress concentration regions at the ends of the major axis of the elliptical cutout. The stiffener length and width as defined in Figure 1 are $L_{st} = 26$ in and $W_{st} = 18$ in. Using a material density of 0.057 lb/in³ for IM7/5260, the preliminary panel design weighs 97 lb.

The minimum weight optimal design for the lower wing skin access cutout has been discussed and is shown in Figure 7. This design weighs 46.5 lb, which is substantially less than the weight of the preliminary design. Examination of the minimum weight solution reveals the following features:

- (i) the base laminate thickness away from the immediate cutout region is less than half the base laminate thickness used in the preliminary design
- (ii) the variable thickness padup surrounding the cutout is rich in $\pm 45^\circ$ and 90° plies away from the small region of maximum tensile stress concentration
- (iii) the ply buildup region along the longitudinal edges of the panel extends across approximately one quarter of the panel width, with an average thickness of about 0.35 inch and a ply mix of roughly (60/30/10)

These material distribution trends provide insight into the modifications required for weight savings in the preliminary panel design.

A modified conventional design that satisfies panel strength requirements is shown in Figure 9. The base laminate has a (60/27/13) ply mix and 0.312 inch thickness obtained by sizing the unnotched panel to the given design load (as opposed to twice the design load in the preliminary design). The padup contains a (25/29/46) ply mix with a maximum thickness of 1.04 inch adjacent to the cutout. The padup areal dimensions are the same as in the preliminary design. Finally, a (60/27/13) ply buildup with total width of 7.5 inch and maximum thickness of 0.352 inch is present along the longitudinal edges of the panel. The final strength check on the modified conventional design was performed with the RARICOM code. The ply buildup along the longitudinal edges of the panel was treated as an equivalent axial stiffener located at the centroid of the ply build-up.

The weight of the modified conventional panel design is 53 lb, only 6.5 lb more than the optimal design. In this example, substantial weight savings have been obtained by modifying the preliminary panel design to include weight saving features identified in the minimum weight optimal design.

SUMMARY

Two design procedures for composite panels with cutouts have been reviewed and illustrated by examples. The first procedure, developed at Northrop under NASA contract, is appropriate for preliminary sizing of the

panel base laminate and simple reinforcement features, such as padups and stiffener frames surrounding the hole. The second procedure uses a finite element based structural optimization code to obtain a minimum weight cutout panel design. Material distribution trends suggested by the optimal solution can be used to modify the NASA/Northrop panel design for improved weight efficiency.

REFERENCES

1. Russell, Steven G., "A Rayleigh-Ritz Design Methodology for Cutouts in Composite Structures," Proceedings of the 33rd AIAA/ASME/ASCE/AHS/ASC Structures, Structural Dynamics, and Materials Conference, April 1992, pp. 181-189.
2. Johnson, E. H. and Venkayya, V. B., "Automated Structural Optimization System (ASTROS), Volume I - Theoretical Manual," USAF Contract Report AFWAL-TR-88-3028, Volume I, December 1988.
3. Advanced Composites Design Handbook, Book 1, REV E, Boeing Commercial Airplane Company, October 1986.
4. Russell, Steven G., "A Rayleigh-Ritz Analysis Methodology for Cutouts in Composite Structures," First NASA Advanced Composites Technology Conference, NASA CP 3104, Part 2, 1991, pp. 901-920.
5. Whitney, J. M. and Nuismer, R. J., "Stress Fracture Criteria for Laminated Composites Containing Stress Concentrations," Journal of Composite Materials, Volume 8, 1974, pp. 253-265.
6. Vanderplaats, G. N., "An Efficient Feasible Directions Algorithm for Design Synthesis," AIAA Journal, Vol. 22, No. 11, November 1984, pp. 1633-1640.
7. MICRO-DOT User's Manual, Version 1.0, Engineering Design Optimization, Inc., Santa Barbara, California, 1985.
8. Vanderplaats, G. N. and Moses, F., "Structural Optimization By Methods of Feasible Directions," Journal of Computers and Structures, Vol. 3, July 1973, pp. 739-755.
9. Gabriele, G. A. and Ragsdell, K. M., "Large Scale Nonlinear Programming Using the Generalized Reduced Gradient Method," Journal of Mechanical Design, Vol. 102, No. 3, July 1980, pp. 566-573.

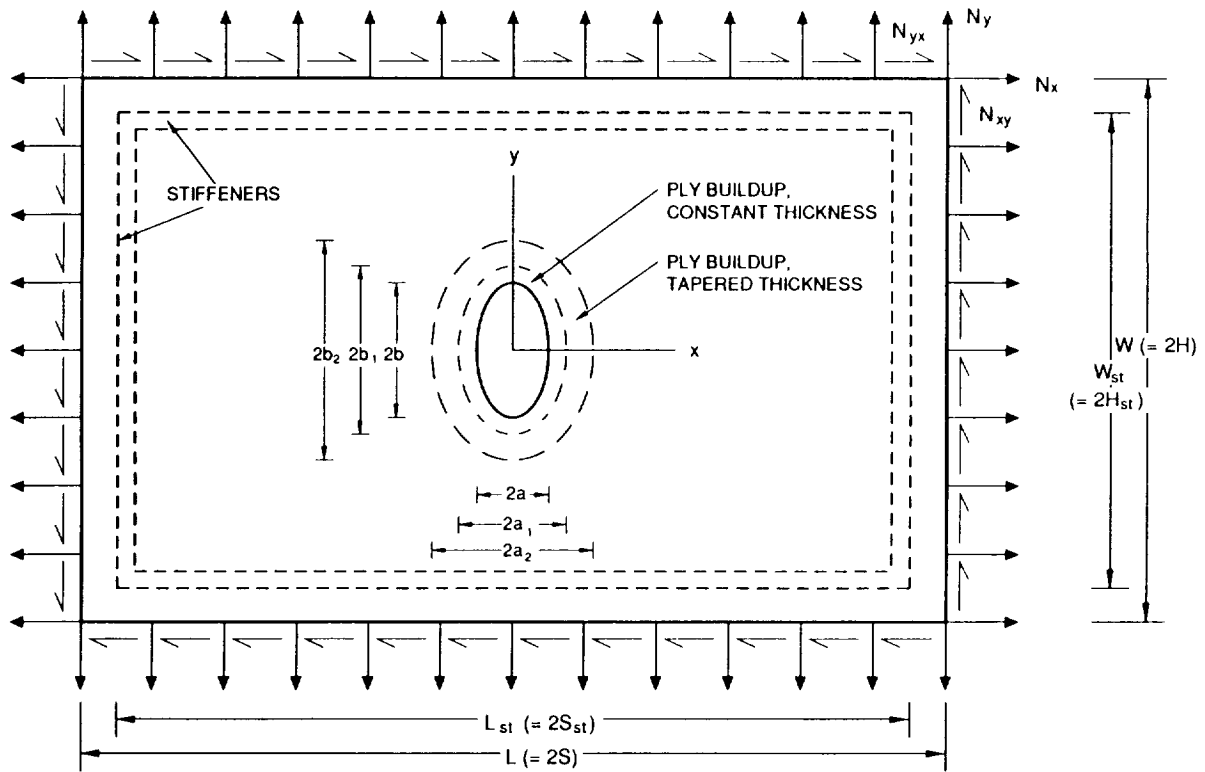

Figure 1. Elliptical Cutout in a Reinforced Panel Under Generalized In-Plane Loading.

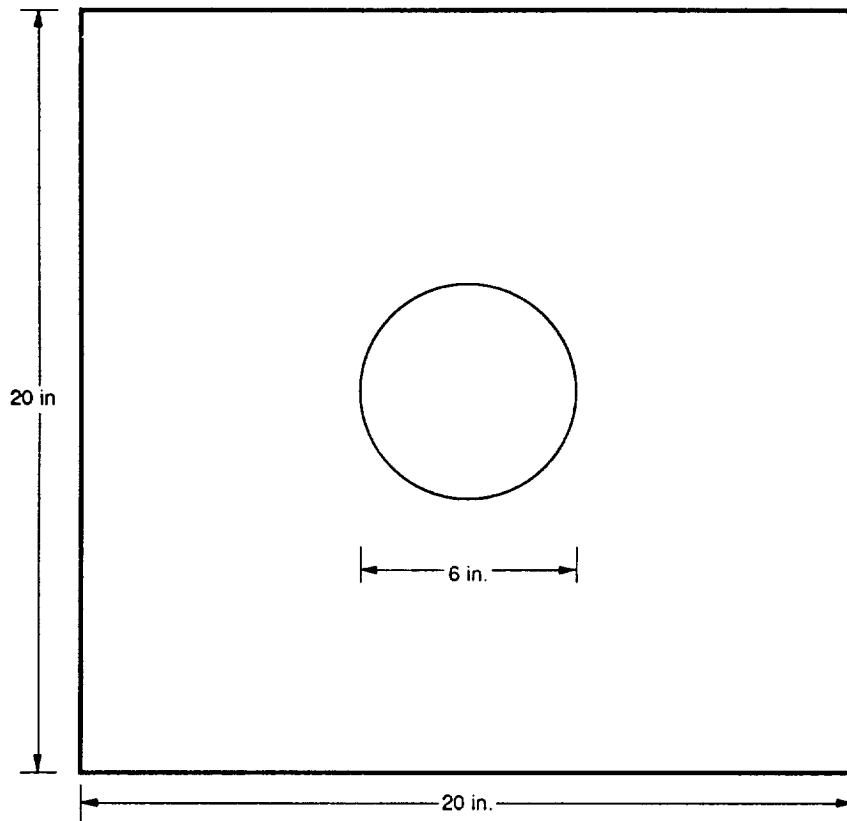

Figure 2(a). Spar Shear Web With Circular Cutout.

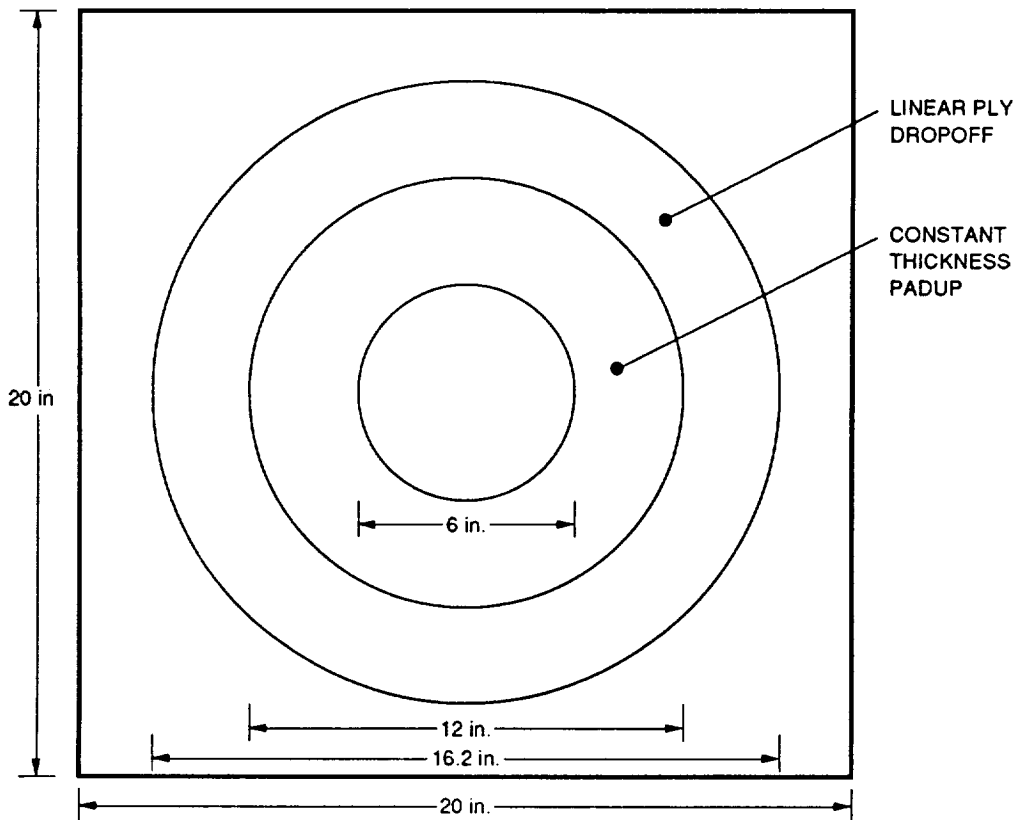

Figure 2(b). Padup for Spar Shear Web Cutout.

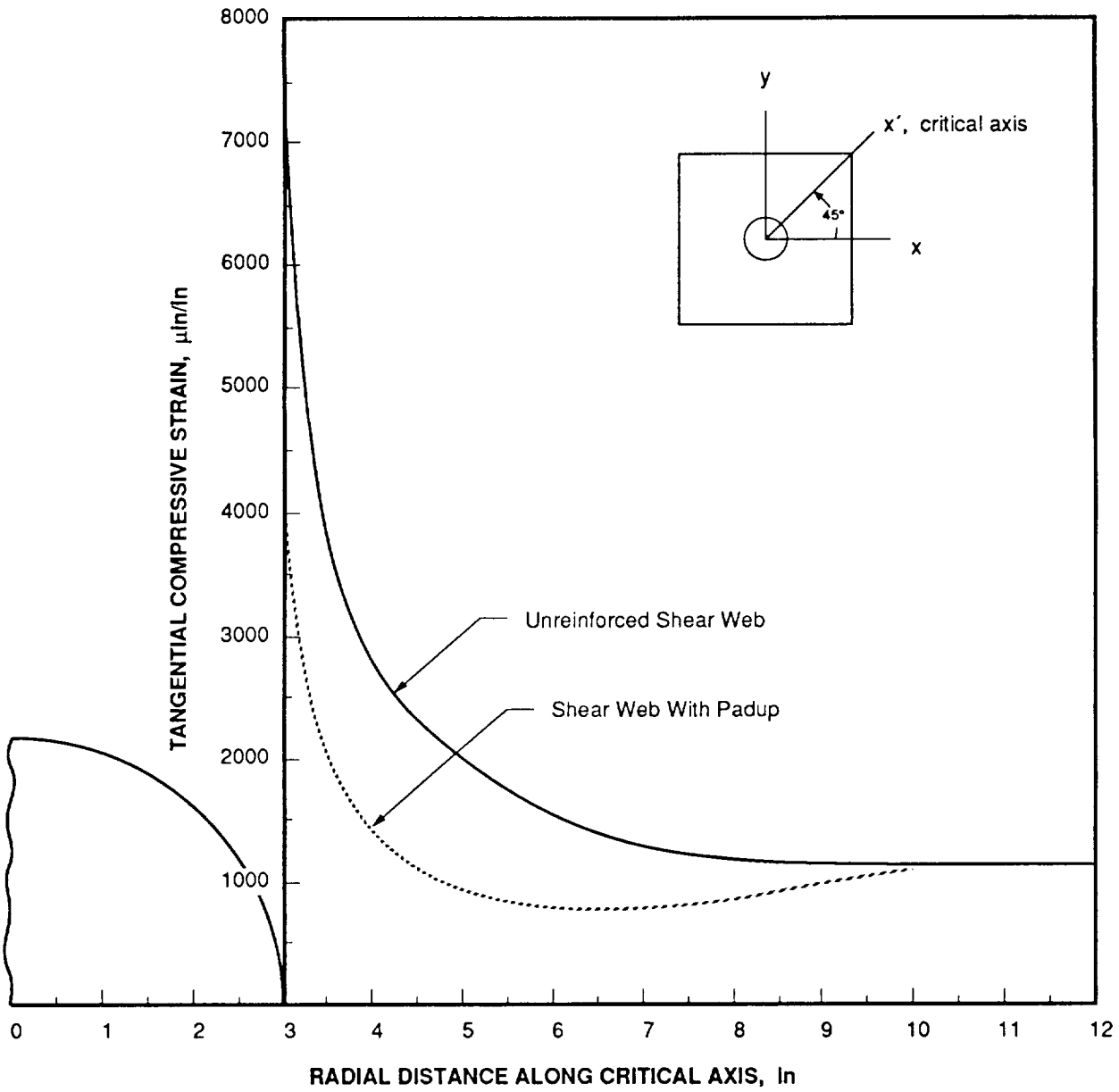

Figure 3. Critical Strain Distributions in Spar Shear Web Design.

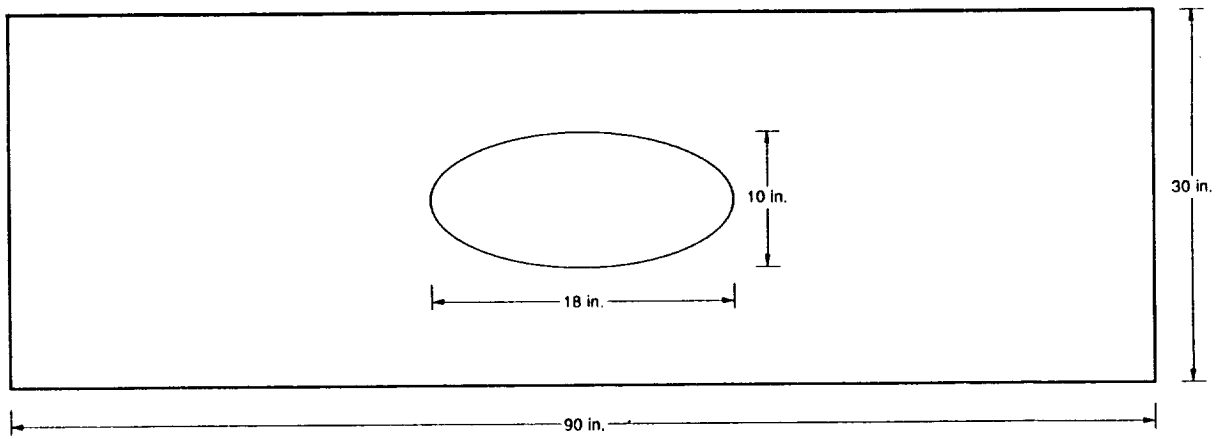

Figure 4. Lower Wing Skin With Access Cutout.

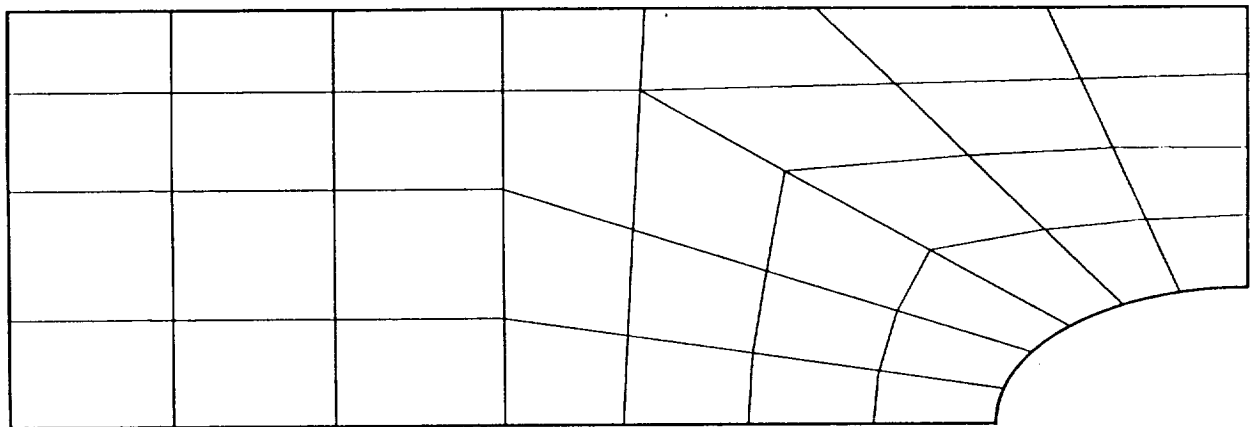
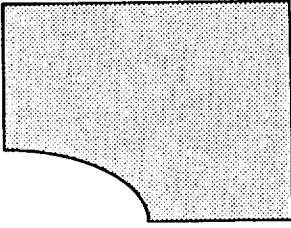
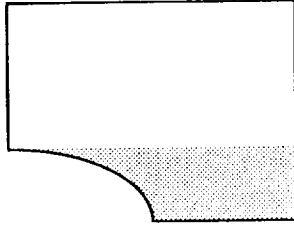

Figure 5. ASTROS Finite Element Mesh for Lower Wing Skin Panel.

SHAPE 1: CONSTANT PANEL



SHAPE 2: CONSTANT STRIP



SHAPE 3: CONSTANT INNER PADUP

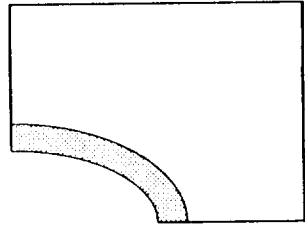

SHAPE 4: CONSTANT OUTER PADUP

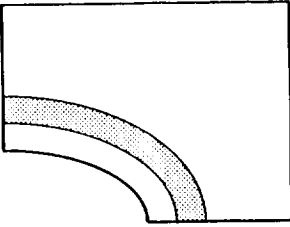

SHAPE 5: LINEAR SPANWISE STRIP

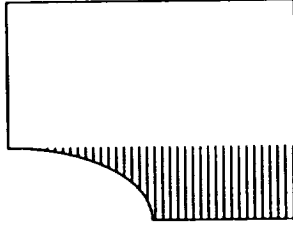

SHAPE 6: LINEAR INNER PADUP

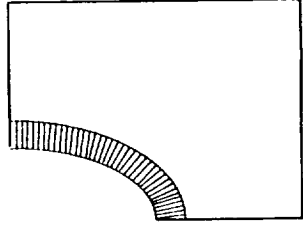

SHAPE 7: LINEAR SPANWISE PANEL

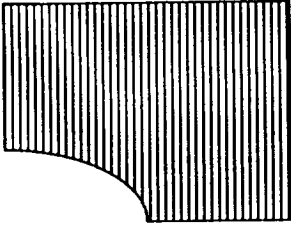

SHAPE 8: LINEAR CHORDWISE PANEL

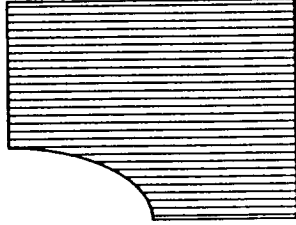

SHAPE 9: LINEAR OUTER PADUP

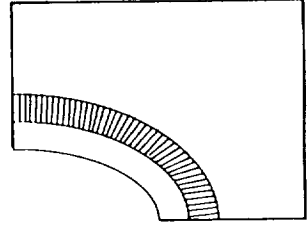

PANEL LOADS: $N_x = 30,000 \text{ lb/in}$, $N_{xy} = 0 \text{ lb/in}$

Figure 6. Shape Function Definitions for ASTROS Design.

ASTROS 60% 0° Fiber Orientation Solution

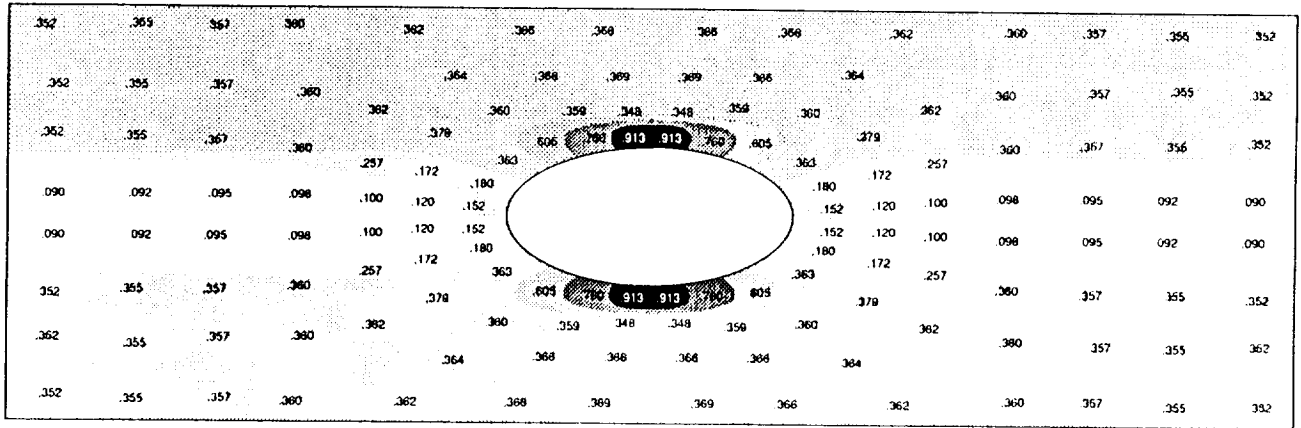

LAMINATE THICKNESS RANGES

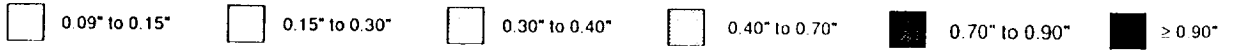

PANEL WEIGHT = 46.5 lb

Figure 7. Thickness Contours from ASTROS Panel Design.

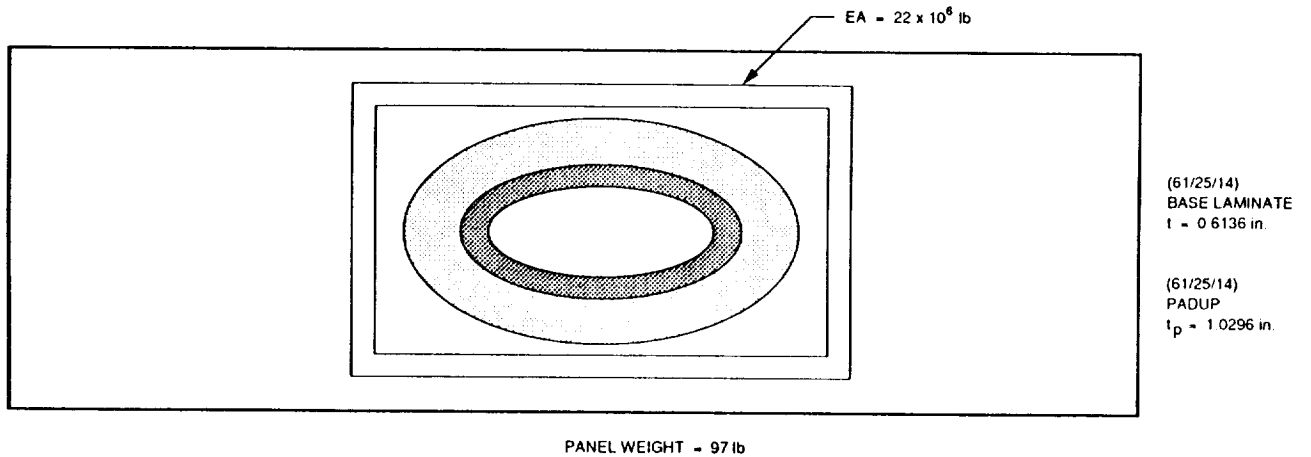

Figure 8. Preliminary Design for Lower Wing Skin Access Panel.

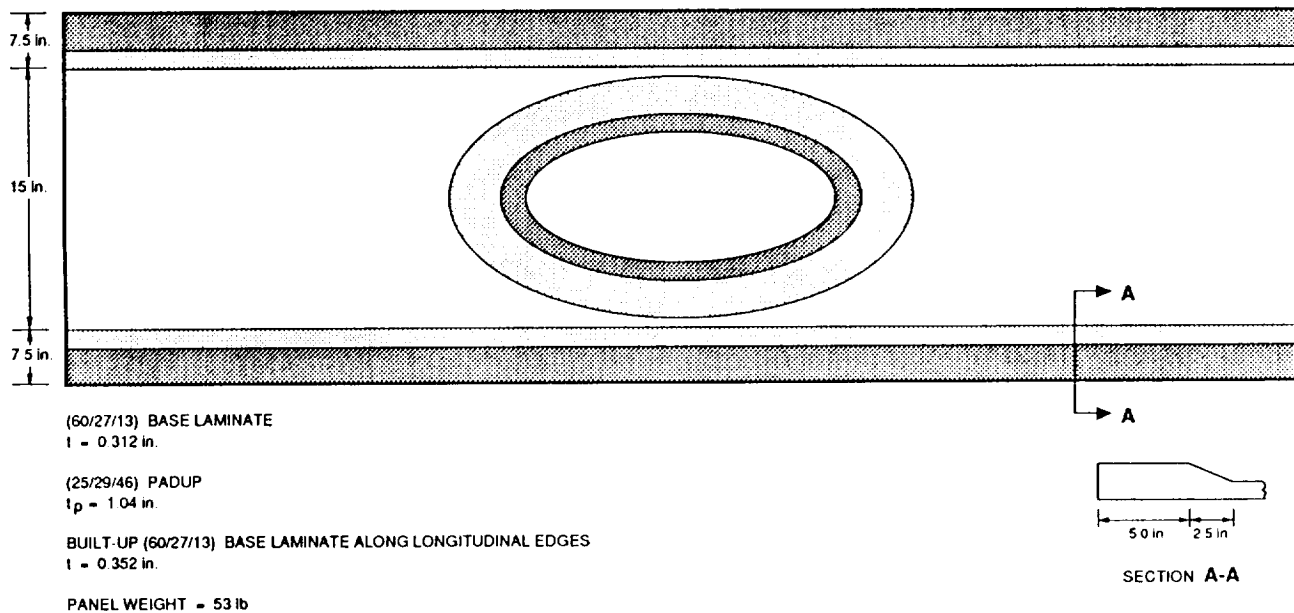

Figure 9. Modified Design for Lower Wing Skin Access Panel.

