

1995 NASA/ASEE SUMMER FACULTY FELLOWSHIP PROGRAM
JOHN F. KENNEDY SPACE CENTER
UNIVERSITY OF CENTRAL FLORIDA

54-51

7744
p. 34

ON-LINE REMOVAL OF VOLATILE FATTY ACIDS FROM CELSS
ANAEROBIC BIOREACTOR VIA NANOFILTRATION

Dr. Guillermo Colon
Associate Professor
Chemical Engineering Department
University of Puerto Rico
Mayaguez, Puerto Rico

KSC Colleague - John C. Sager
Life Sciences

Contract Number NASA-NGT-60002
Supplement 19

August 9, 1995

ACKNOWLEDGMENTS

I would like to express my appreciation for being selected to participate in the 1995 NASA/ASEE Summer Fellowship Program. To Dr. E. Ramon Hosler (University of Central Florida) and to Mr. Gregg Burkingham (NASA University Manager) my congratulations, for their capable administration of the program.

I also want to thank my NASA colleague Dr. John C. Sager for his invaluable support and friendship during this summer. Special thanks are extended to Mr. Barry Finger, Mr. Michael Alazraki and Dr. Richard F. Strayer for their continuous support and arranging of the laboratory facilities to carry out the experimental work reported in this document. Thanks to Barbara Peterson and Teresa Englert for their support with the analyses of VFA, inorganic and TOC and to Mr. Jeff Ruddell for his continuous computer assistance.

My gratitude goes also to Ms. Kari Stiles for her dedication and invaluable assistance during my stay in KSC, and to Dr. Raymond Wheeler for his friendship and numerous rides from Titusville to NASA -KSC facilities.

In general I made lots of friends in NASA Kennedy Space Center that I will never forget.

ABSTRACT

The CELSS resource recovery system, which is a waste processing system, uses aerobic and anaerobic bioreactors to recover plants nutrients and secondary foods from the inedible biomass. The anaerobic degradation of the inedible biomass by means of culture of rumen bacteria, generates organic compounds such as volatile fatty acids (acetic, propionic, butyric, VFA) and ammonia. The presence of VFA in the bioreactor medium at fairly low concentrations decreases the microbial population's metabolic reactions due to end-product inhibition. Technologies to remove VFA continuously from the bioreactor are of high interest.

Several candidate technologies were analyzed, such as organic solvent liquid-liquid extraction, adsorption and/or ion exchange, dialysis, electro dialysis, and pressure driven membrane separation processes. The proposed technique for the on-line removal of VFA from the anaerobic bioreactor was a nanofiltration membrane recycle bioreactor. In order to establish the nanofiltration process performance variables before coupling it to the bioreactor, a series of experiments were carried out using a 10,000 MWCO tubular ceramic membrane module. The variables studied were the bioreactor slurry permeation characteristics, such as, the permeate flux, VFA and nutrient removal rates as a function of applied transmembrane pressure, fluid recirculation velocity, suspended matter concentration, and process operating time.

Results indicated that the permeate flux, VFA and nutrients removal rates are directly proportional to the fluid recirculation velocity in the range between 0.6 to 1.0 m/s, applied pressure when these are lower than 1.5 bar, and inversely proportional to the total suspended solids concentration in the range between 23,466 to 34,880. At applied pressure higher than 1.5 bar the flux is not more linearly dependent due to concentration polarization and fouling effects over the membrane surface. It was also found that the permeate flux declines rapidly during the first 5 to 8 hours, and then levels off with a diminishing rate of flux decay.

SUMMARY

NASA has been studying the viability of a controlled ecological life support system (CELSS) for long term space missions for several years. The purpose of this system is to provide all the basic human needs required for life support (food, water, oxygen). Previous studies have been carried out using aerobic and anaerobic bioreactors to recover plant nutrients and secondary foods from the inedible biomass. The anaerobic degradation of the inedible biomass by mean of culture of rumen bacteria , generates organic compounds such as volatile fatty acids (VFA) and ammonia. The presence of VFA in the bioreactor medium at fairly low concentration decreases the microbial metabolic reactions due to end-product inhibition. Technologies to remove VFA from the anaerobic bioreactor is therefore of high interest.

The technique proposed for the on-line removal of VFA from the anaerobic bioreactor broth was a nanofiltration membrane recycle bioreactor. In order to establish the nanofiltration process performance variables before coupling it to the anaerobic bioreactor a series of experiments were carried out using a 10,000 MWCO tubular ceramic membrane module. The variables studied were the bioreactor slurry membrane permeation characteristics such as, the permeate flux, VFA and nutrients removal rates as a function of applied transmembrane pressure, fluid recirculation velocity, suspended matter content, and process operating time.

Results show that the permeate flux, VFA and nutrients removal rates are directly proportional to the fluid recirculation velocity in the range between 0.6 to 1.0 m/s, applied pressure when these are lower than 1.5 bar, and inversely proportional to the bioreactor effluent total suspended solids concentration. The operation at applied pressure higher the 1.5 bar, the permeate flux was not more linearly dependent on applied pressure. The asymptotic flux-pressure relationship observed at high applied pressure is due to concentration polarization and fouling effects over the membrane surface. The permeate flux decreased exponentially with the total suspended solids concentration due to the increase of medium viscosity and polarization and gel layers hydraulic resistances. The VFA and nutrients removal rates were found to be proportional to the total fluid filtration rate and component composition in the bioreactor effluent. It was also found that the permeate flux declined rapidly during the first 5 to 8 hours and then leveled off with a diminishing rate of decay. This phenomena occurred as consequence of the accumulation of suspended matter over the membrane surface which no longer participates in the mass-transport to or away from the membrane.

TABLE OF CONTENTS

<u>Section</u>	<u>Title</u>	<u>Page</u>
I	INTRODUCTION	1
1.1	BACKGROUND	1
1.2	CANDIDATE TECHNOLOGIES FOR THE ON-LINE REMOVAL OF VFA FROM THE ANAEROBIC BIOREACTOR	4
1.2.1	Organic solvent liquid-liquid extraction	4
1.2.2	Adsorption and/or ion exchange	4
1.2.3	Dialysis	4
1.2.4	Electrodialysis	4
1.2.5	Pressure driven membrane separation processes	4
1.3	PROPOSED TECHNOLOGY	5
1.4	OBJECTIVE	6
II	EXPERIMENTAL SET-UP	7
2.1	EXPERIMENTAL EQUIPMENT	7
2.2	ANALYTICAL METHODS	7
III	RESULTS AND DISCUSSION	8
3.1	MEMBRANE CHARACTERIZATION	8
3.2	ANAEROBIC BIOREACTOR EFFLUENT CHARACTERISTICS	9
3.3	EFFECT OF APPLIED TRANSMEMBRANE PRESSURE AND FLUID RECIRCULATION VELOCITY ON TOTAL FLUID PERMEATE FLUX, VFA AND NUTRIENT REMOVAL RATES	9
3.4	EFFECT OF TOTAL SUSPENDED SOLIDS CONCENTRATION ON PERMEATE FLUX, VFA AND NUTRIENT REMOVAL RATES	12
3.5	EFFECT OF PROCESS OPERATING TIME ON FLUID PERMEATE FLUX	17
IV	CONCLUSIONS	24
V	REFERENCES	25

LIST OF ILLUSTRATIONS

Figure	Title	Page
1	Proposed Nanofiltration Membrane Recycle Bioreactor for On-line Removal of VFA from CELSS Anaerobic Bioreactor	5
2	Nanofiltration Experimental Equipment Flow Diagram	7
3	De-ionized Water Permeate Flux vs Transmembrane Pressure at Different Recirculation Velocities	8
4	Bioreactor Effluent Permeate Flux vs Transmembrane Pressure at Different Fluid Recirculation Velocities	11
5	Bioreactor Effluent Permeate Flux vs Fluid Recirculation Velocity at Different Applied Transmembrane Pressure	11
6	Volatile Fatty Acid Removal Rate from Bioreactor Effluent at a Recirculation Velocity of 0.65 m/s	13
7	Volatile Fatty Acid Removal Rate from Bioreactor Effluent at a Recirculation Velocity of 0.9 m/s	13
8	Volatile Fatty Acid Removal Rate from Bioreactor Effluent at a Recirculation Velocity of 1.0 m/s	14
9	Nutrients Removal Rate from Bioreactor Effluent at a Recirculation Velocity of 0.65 m/s	14
10	Nutrients Removal Rate from Bioreactor Effluent at a Recirculation Velocity of 0.9 m/s	15
11	Nutrients Removal Rate from Bioreactor Effluent at a Recirculation Velocity of 1.0 m/s	15
12	Effect of Bioreactor Effluent Total Suspended Solids Concentration on Permeate Flux at U = 0.9 m/s	16
13	Effect of Bioreactor Effluent Total Suspended Solids Concentration on Permeate Flux at U = 0.9 m/s (Semi-log Plot)	16

14	Effect of Applied Transmembrane Pressure on Permeate Flux at Different TSS Concentration at $U = 0.9$ m/s	18
15	Effect of Bioreactor Broth Total Suspended Solids Concentration on VFA Removal Rate at TMP = 0.6 bar and $U = 0.9$ m/s	19
16	Effect of Bioreactor Broth Total Suspended Solids Concentration on VFA Removal Rate at TMP = 1.0 bar and $U = 0.9$ m/s	19
17	Effect of Bioreactor Broth Total Suspended Solids Concentration on VFA Removal Rate at TMP = 1.4 bar and $U = 0.9$ m/s	20
18	Effect of Total Suspended Solids Concentration on Nutrients Removal Rate at TMP = 0.6 bar and $U = 0.9$ m/s	20
19	Effect of Total Suspended Solids Concentration on Nutrients Removal Rate at TMP = 1.0 bar and $U = 0.9$ m/s	21
20	Effect of Total Suspended Solids Concentration on Nutrients Removal Rate at TMP = 1.4 bar and $U = 0.9$ m/s	21
21	Variation of Permeate Flux with Time at Different Applied Transmembrane Pressure at $U = 0.9$ m/s	22

LIST OF TABLES

<u>Table</u>	<u>Title</u>	<u>Page</u>
1	Anaerobic Bioreactor Effluent Average Composition	10

ABBREVIATIONS, ACRONYMS AND NOMENCLATURE

BPC	= Biomass Production Chamber
CELSS	= Controlled Ecological Life Support System
CSTR	= Continuous Stirred Tank Reactor
g	= gram
hr	= hour
L	= liter
LMWS	= low molecular weight solute
MRB	= membrane recycle bioreactor
MW	= molecular weight
MWCO	= molecular weight cut-off
NF	= nanofiltration
TMP	= transmembrane pressure
TSS	= total suspended solids
VSS	= volatile suspended solids
VFA	= volatile fatty acid
H ₂ SO ₄	= sulphuric acid
NH ₄	= ammonium
PO ₄	= phosphate
Fe	= iron
Ca	= calcium
A	= experimental constant
A _w	= water membrane permeability constant, L/hr-m ²
C _B	= bulk solute concentration, mg/L or mMole
C _p	= permeate solute concentration, mg/L or mMole
C _w	= membrane wall solute concentration, mg/L or mMole
D	= molecular diffusivity, m ² /s
d _H	= hydraulic diameter, m
k	= polarization boundary layer mass transfer coefficient, m/s
J _v	= permeate flux, L/hr-m ²
R _{ads}	= adsorbed solute hydraulic resistance, bar-s ² /kg
R _{cp}	= concentration polarization hydraulic resistance, bar-s ² /kg
R _g	= gel layer hydraulic resistance, bar-s ² /kg
R _m	= intrinsic membrane hydraulic resistance, bar-s ² /kg
U, u	= fluid recirculation velocity, m/s
α	= experimental constant
β	= experimental constant
ΔP _m	= transmembrane pressure, bar
Δπ	= transmembrane osmotic pressure, bar
μ	= viscosity, kg/m-s
ρ	= density, kg/m ³

I. INTRODUCTION

The National Aeronautical and Space Administration (NASA) has been studying the viability of Controlled Ecological Life Support System (CELSS) for long term space missions for several years. The purpose of this system is to provide all the basic human needs required for life support. The CELSS breadboard project is a large-scale integration system with two main components, a full-scale Biomass Production Chamber (BPC) and the Resource Recovery system. The BPC is a closed system where plants are grown under controlled hydroponic conditions. The plants in CELSS generate oxygen, purified water, and produce edible foods. The resource recovery system which is a waste processing unit uses aerobic and anaerobic bioreactor processes to recover plants nutrients and secondary foods from the inedible biomass. The anaerobic bioreactor is actually operated in a feed and bleed mode of operation. The bioreactor is fed with a microbial population obtained from the cow's rumen together with the inedible portion of plants. Anaerobic degradation of inedible biomass, generates organic compounds such as volatile fatty acids (acetic, propionic, butyric, VFA) and ammonia. The presence of VFA in the fermentation medium at fairly low concentrations decrease the microorganism's metabolic reaction rate due to end-product inhibition. Technologies to remove VFA from the anaerobic bioreactor are therefore of high interest.

1.1 BACKGROUND

Anaerobic digestion is a naturally occurring biological process in which organic material is converted to reduced end products. The anaerobic decomposition of solid organic wastes proceeds in two consecutive steps, liquification and methanogenesis (1, 2). In the first step, microorganisms hydrolyze various components of the solid matter into smaller soluble molecules like sugars and amino acids. These soluble products are adsorbed by the microbes and are rearranged into CO₂ and volatile fatty acids (acetic, propionic, butyric). The first phase of the anaerobic digestion is known as the acidogenic phase. In the second phase a second group of organisms, the methanogens, complete the digestion process converting the VFA to highly reduced CH₄ and CO₂. Manipulation of bioreactor conditions allow for higher production of VFA and less production of methane. Previous studies have indicated that these acids are phytotoxic at certain concentrations (3). VFA at fairly low concentrations in the fermentation medium cause inhibition of the degradation of complex plant polymers, such as cellulose and hemicellulose (4). In order to obtain higher anaerobic conversions of the inedible biomass, it is important to remove VFA to non-toxic levels. One way to remove continuously the VFA from the anaerobic bioreactor fermentation broth is by mean of a membrane recycle bioreactor (MRB).

Basically a membrane recycle bioreactor (MRB) is a reaction vessel, operated as a stirred tank reactor, is coupled in a semi closed-loop configuration via suitable pump to a membrane module containing the appropriate semi-permeable membrane. The membrane should be chosen to retain the microorganisms, enzymes, and most macromolecules while minimizing retention of end-products that affect microorganisms metabolic reactions. For example, in the production of ethanol by yeast, alcohol productivity at 6% (v/v) is only half that at the zero alcohol level, while

it is only 1/100 at 12% (5). Gerhardt and coworkers performed several pioneering experiments on the use of *in vitro* dialysis culture systems for a variety of applications (6). They showed that continuous removal of metabolic products would result in a superior fermentation process. The ethanol productivity using MRB was found to be 30-50 times higher than batch ethanol fermentation (5). The production of propionic acid utilizing culture of *Propionibacterium acid-propionici*, using renewable resources has been found to be a slow rate fermentation process due to strong product inhibition (7). The use of membrane filter systems for cell recycling improved greatly the fermentation process, allowing to maintain a continuous high-cell-density culture by removing inhibitory metabolic products (8). Propionic acid productivity was 17 times greater than obtained using a continuous stirred tank bioreactor (CSTR). Xavier et al. (9) studied the lactic acid production with cell recycling on an ultrafiltration tubular membrane reactor. They found that the volumetric productivity (36 g/L-hr) was larger than the traditional batch fermentation (3 g/L-hr), or others continuous systems, i.e., CSTR (6 g/L-hr) and immobilized bioreactor (20 g/L-hr).

Nanofiltration (NF) is a rate governed process in which the pressure is the driving force. The feed solution containing macromolecular solutes is introduced into the membrane separator where the solvent and certain microsolute pass through a semi-permeable membrane and is collected as nanofiltrate. Both theoretically and practically, NF offers an attractive alternative to a number of unit operations in food processing, chemical processing, pharmaceutical, and biotechnological industries. The major limiting step in the use of pressure driven membrane processes (such as NF), particularly with multicomponents feed streams, is the decline of permeate flux as a function time caused by "fouling" of the membrane (10, 11). The decline of flux in NF of a solution or suspension is attributed to concentration polarization and fouling phenomena (such as adsorption, pore blocking, and deposition of solidified solutes, a long term and more or less irreversible process).

During nanofiltration of macromolecular solutes, the linear relationship between permeate flux (J_v) and applied transmembrane pressure (ΔP_m) does not hold very well. At this point solutes get accumulated near the membrane causing permeate flow resistance to rise. The flux become independent of pressure at higher values of ΔP_m . This gives rise to the phenomenon of concentration polarization (10, 12). The steady state mass balance based on the relative rates of solutes transport to the membrane surface by convection and back diffusion, give the following equation for the region where the permeate flux is practically independent on pressure (13):

$$J_v = k \ln \left[\frac{C_w - C_p}{C_B - C_p} \right] \quad (1)$$

The polarization boundary layer mass transfer coefficient, k , is correlated to the solution physical properties, flow channel dimensions and operating parameters exist in the literature (14, 15). As the solutes bulk concentration increases, the permeate flux decreases exponentially. Using the π

theorem, one can obtain a general correlation of the form:

$$\frac{k d_h}{D} = A \left(\frac{\rho U d_H}{D} \right)^\alpha \left(\frac{\mu}{\rho D} \right)^\beta \quad (2)$$

As can be observed in the above equation the mass transfer coefficient depends on fluid recirculation velocity (U), solution physical properties (μ , ρ , D), and flow channel dimensions (d_H). The boundary layer mass transfer coefficient is proportional to the fluid velocity, which mean that increasing the fluid velocity reduces greatly the concentration polarization layer.

The water flux through the porous membrane can be describe by Darcy's law:

$$J_v = \frac{\Delta P_m}{R_m \mu_w} = A_w \Delta P_m \quad (3)$$

where R_m , is the intrinsic hydraulic membrane resistance and A_w , is the water membrane permeability constant. It is a function of pore size, tortuosity, membrane thickness, porosity and inversely proportional to fluid viscosity. The permeate flux through the membrane is directly proportional to the applied transmembrane pressure when there is not evidence of concentration polarization and fouling over the membrane surface. From the concentration-polarization model it is evident that the concentration polarization on the membrane polarization will be considerably higher than that in the bulk. This high concentration on one side of the membrane and the very low concentration on the other side create an osmotic pressure difference ($\Delta\pi$) which acts opposite to the applied pressure (ΔP_m). So in Eq. 3, ΔP_m is now replaced by the effective pressure ($\Delta P_m - \Delta\pi$),

$$J_v = \frac{\Delta P_m - \Delta\pi}{R_m \mu_s} \quad (4)$$

However, this equation is still not adequate to predict the flux. Solutes may get adsorbed, which also cause fouling and also form a distinct polarized layer. These phenomena are accommodated by introducing the resistance in series model (16),

$$J_v = \frac{\Delta P_m - \Delta\pi}{\mu_s (R_m + R_{ads} + R_{cp} + R_g)} \quad (5)$$

where R_{ads} is the resistance of solutes adsorbed onto the membrane surface or the pore walls, R_{cp} is the resistance of the concentration polarization boundary layer and R_g is the resistance of a

layer of concentrate at the membrane surface (often referred to as the gel layer). The influence of the different resistances may be established by varying the shear rate.

1.2 CANDIDATE TECHNOLOGIES FOR THE ON-LINE REMOVAL OF VFA FROM THE ANAEROBIC BIOREACTOR

- 1.2.1 Organic solvent liquid-liquid extraction. This technology requires to put the fermentation broth in contact with solvents that have high selectivity for VFA. There are few organic solvents with this capability, but have been found to be toxic to the microbial population (17).
- 1.2.2 Adsorption and/or ion-exchange. This technique has received attention for removal of VFA from dilute fermentation broth using basic polymer sorbents. Sorbents containing basic groups provide selective removal of VFA from complex solutions (18). The CELSS anaerobic bioreactor fermentation broth contains a large variety of chemical compounds, such as: proteins, enzymes, inorganics, polysaccharides, ammonia, and many others. Many of these compounds compete for sorbent sites, which require continuous sorbent regeneration and difficult down-stream separation processes.
- 1.2.3 Dialysis. This is a diffusion mass transfer membrane process. This system provides the capability to remove selectively the compounds of interest by controlling membrane opposite side solution composition (dialyzant). Due to the nature of this process, which is diffusion mass transfer controlled, it takes a long period of time to obtain the desired separation (19)
- 1.2.4 Electrodialysis. This is a thin ion-exchange membrane compartments between a pair of electrodes separation process. It contains inter-membrane spacers, which are very susceptible to clog by suspended matter. All the ionic compounds, including broth nutrients will also be removed together with the VFA (20, 21).
- 1.2.5 Pressure driven membrane separation processes. These membrane permselective separation processes are based on particle or molecular size, shape, and other factors affecting the separation. The five major membrane separation processes are: reverse osmosis, for separation of low molecular weight compounds (MW < 1,000); nanofiltration, for molecules with molecular weight (MW) in the range between 1,000 - 10,000; ultrafiltration, for separation of macromolecules with MW in the range of 10,000 to 500,000; and microfiltration for the separation of fine particles in the range of 0.1 to 10 microns. Due to the wide separation spectrum of this technology, many biotechnological separations can be carried out by means of selecting the appropriate membranes and optimum operating conditions.

1.3 PROPOSED TECHNOLOGY

The technique proposed for the on-line removal of VFA from the anaerobic bioreactor fermentation broth is a nanofiltration membrane recycle bioreactor (MRB, see Fig. 1). This system consists of a reaction vessel operated as a stirred tank reactor, which is coupled in a semi-closed loop via a suitable pump to a membrane filtration module. The content of the bioreactor is continuously pumped through the membrane module and recycled back to the vessel. The membrane should be chosen to retain the microorganisms, suspended matter, enzymes, and most macromolecules, while minimizing retention of end-products. A MBR using nanofiltration membranes with nominal molecular weight cut-off (MWCO) between 1,000 to 10,000 will greatly remove VFA from the anaerobic bioreactor inedible biomass medium. Due to the high content of suspended matter and large particle sizes of the bioreactor medium is recommended to use tubular membrane configuration systems with large internal diameter. The membrane module selected to accomplish with this requirement was a porous carbon support, internally coated with a ZrO_2 - TiO_2 layer, with a length of 0.4 m and an internal diameter of 0.6 cm (Rhône-Poulenc Tech-Sep, Cranbury, New Jersey).

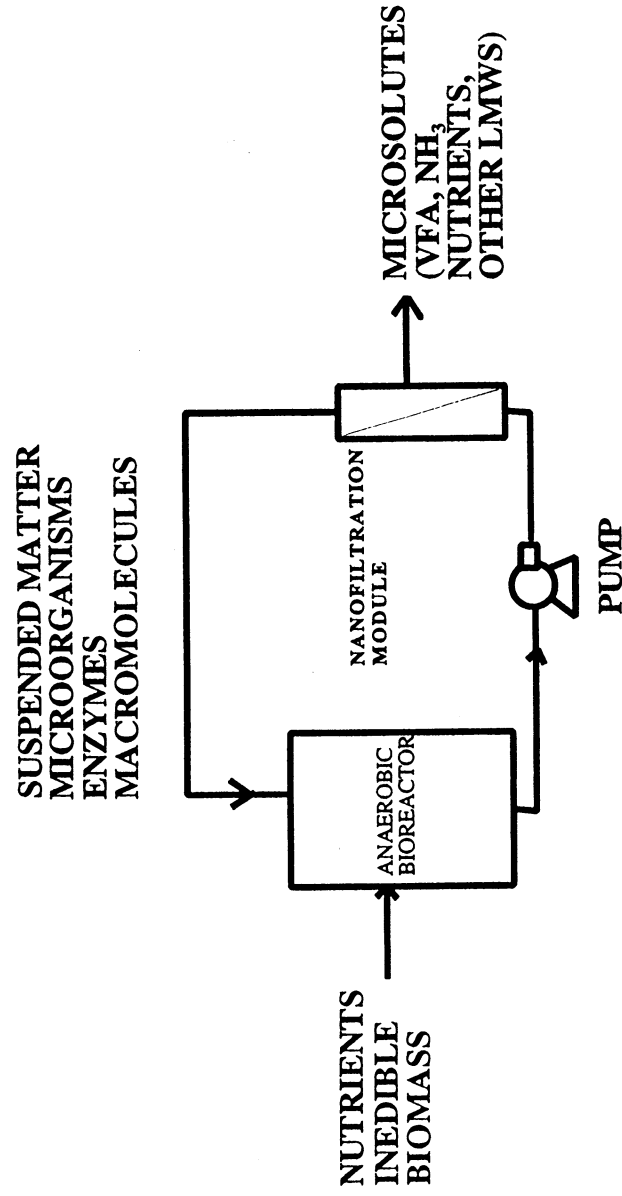

Figure 1. Proposed Nanofiltration Membrane Recycle Bioreactor for On-line Removal of Volatile Fatty Acids from CELSS Anaerobic Bioreactor.

1.4 OBJECTIVE

The main objective of this summer project was to determine the nanofiltration membrane separation process performance variables using a 10,000 MWCO tubular ceramic membrane module before coupling it to the anaerobic bioreactor. The variables to be studied are: the bioreactor slurry permeation characteristics such as; permeate flux as a function of transmembrane pressure, the effects of dissolved and suspended matter content on permeate flux, the effects of the recirculation hydrodynamic conditions on membrane fouling, on-line VFA removal rate and nutrients removal rate.

II. EXPERIMENTAL SET-UP

2.1 EXPERIMENTAL EQUIPMENT

The experimental equipment flow diagram is shown in Fig. 2. The nanofiltration module is constituted of a tubular ceramic membrane composed of a porous carbon support internally coated with a ZrO_2 - TiO_2 layer, with a length of 0.4 m and an internal diameter of 0.6 cm (Rhône-Poulenc Tech-Sep, Cranbury, New Jersey). The total membrane filtration surface area is 0.008 m^2 and has a nominal molecular weight of 10,000 Molecular Weight Cut-Off (MWCO).

2.2 ANALYTICAL METHODS

Volatile fatty acids (VFA), such as acetic, propionic, and butyric acid concentrations were determined with a Perkin Elmer Series 4 High Performance Liquid Chromatograph, using a Bio-Rad Aminex HPX-87H column. The mobile phase was a $0.008N \text{ H}_2\text{SO}_4$ solution at a flow rate of 1 mL/min and 55°C . Detention was performed with a Perkin Elmer UV Detector at a wavelength of 210 nm. Samples were prepared by mixing 5 mL of the original sample with 1 mL of 25%(w/v) metaphosphoric acid to separate out the VFA and then centrifuged for 20 min at 14,000 rpm.

Inorganic analysis of calcium, phosphate, ammonium, and iron concentrations were carried out using EPA methods: EPA 200.7, EPA 365.1, and EPA 350.1. Analyses of total organic carbon (TOC) concentrations were determined using the EPA method: EPA 415.1. Total suspended solids (TSS) concentrations were determined by weighting known samples volume previously dried in a vacuum oven at 75°C and 0.5 bar of vacuum for 24 hours.

Fig. 2. Nanofiltration Experimental Equipment Flow Diagram

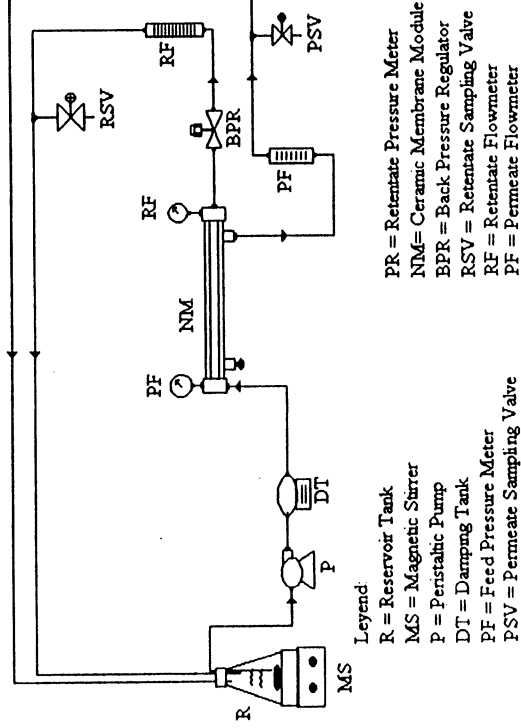

III. RESULTS AND DISCUSSION

3.1 MEMBRANE CHARACTERIZATION

The hydraulic permeability of the membrane was determined before subsequent use in the separation studies. Fig. 3. shows the de-ionized water permeate flux versus applied transmembrane pressure relationship at three different recirculation velocities. The average membrane water permeability constant, A_w , as determined by Eq. 3, is $89.2 \text{ L/hr-m}^2\text{-bar}$. It is almost independent on fluid recirculation velocity. The membrane does not have any degree of compressibility under pressure, as indicated there is not deviation from linearity in the profile. After each experimental run using the effluent of the anaerobic bioreactor the membrane was cleaned, following manufacturer procedures for biotechnology fluids. After the cleaning procedure the de-ionized water permeability constant was checked to be at least 95% of the initial value.

Fig. 3. De-ionized Water Permeate Flux vs Transmembrane Pressure at Different Recirculation Velocities

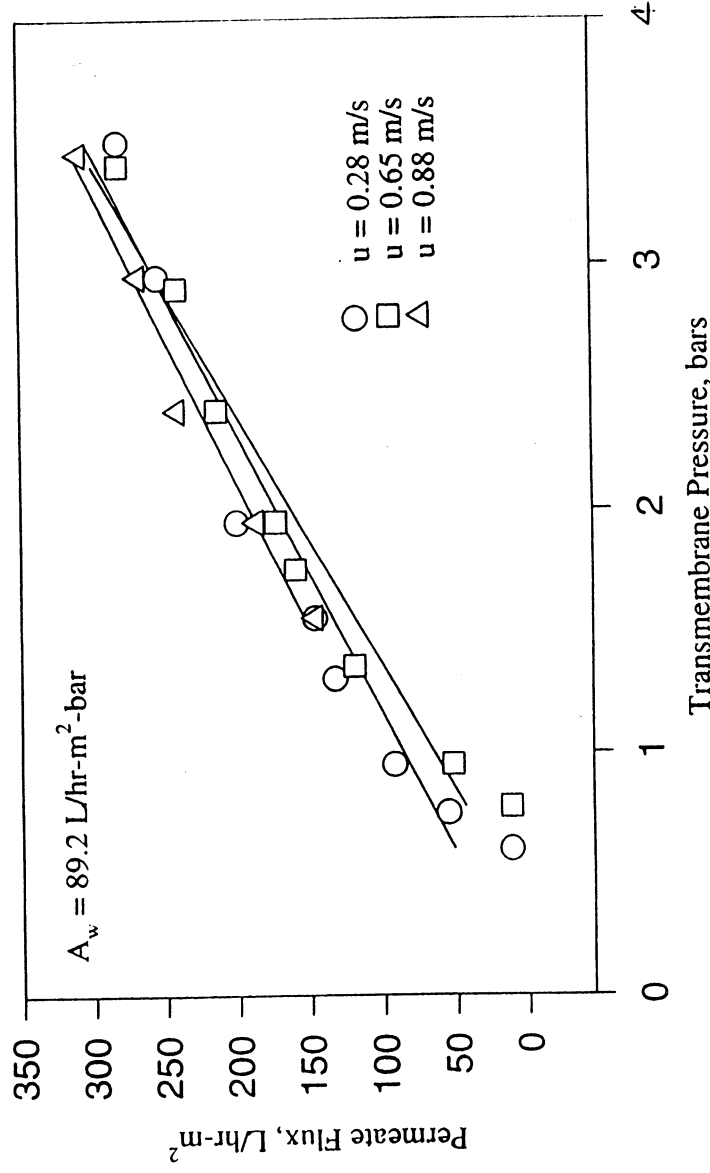

3.2 ANAEROBIC BIOREACTOR EFFLUENT CHARACTERISTICS

The CELSS bench-scale anaerobic bioreactor is a 8 liter working volume reactor. The bioreactor is fed with a previously dried and ground potato inedible plant parts, and is inoculated with culture of rumen bacteria. This microbial population has the enzymatic capability to degrade the cellulose and hemicellulose portion of the biomass. Nitrogen is pumped into the bioreactor so that pressure is high enough to keep oxygen from flowing in, therefore maintaining the anaerobic nature of the system. The bioreactor is operated in a feed and bleed mode of operation, one liter of the bioreactor effluent is harvested each day and replaced with one liter of de-ionized water and 50 g of inedible biomass.

To carry out each nanofiltration experimental run 3 liters of harvested bioreactor effluent were collected. The bioreactor effluent composition of total suspended solids (TSS), volatile suspended solids (VSS), total organic carbon (TOC), volatile fatty acids, and some inorganic nutrients is given in Table 1. The bioreactor effluent V.A. composition is about 84% acetic acid, 8.6% propionic acid, and 7.4% butyric acid (molar percent). As can be observed from Table 1, it contains a large amount of suspended matter.

The bioreactor effluent also contained some large particles, which clogged the back pressure regulator connected at the outlet of the nanofiltration module. To apply a given transmembrane pressure, it is required to close this valve slowly, reducing the available fluid flowing opening area. Some of the larger particles contained in the bioreactor effluent clogged it and the pressure rise-up drastically, producing unstable operating conditions. To solve this problem the bioreactor effluent was filtered with an 0.04 x 0.04 mm opening stainless steel wire mesh. The filtration step reduced the total suspended solids concentration from 36,972 to 24,648 mg/L (33% reduction on TSS concentration). The total suspended solids concentration of the bioreactor effluent before and after the filtration step changed from one to another harvest. The filtered effluent total suspended solids concentration varied from 26,500 to 23,000 mg/L. In practice this filtration step can be done by installing an on-line filter probe to the bioreactor when it will be coupled to the nanofiltration module.

3.3 EFFECT OF APPLIED TRANSMEMBRANE PRESSURE AND FLUID RECIRCULATION VELOCITY ON TOTAL FLUID PERMEATE FLUX, VFA AND NUTRIENT REMOVAL RATES.

Several experiments were carried out to establish the best nanofiltration operating conditions. At fluid recirculation velocities lower than 0.5 m/s, the pump was not able to keep a constant flow rate operation. This phenomenon is mostly produced due to the high content of suspended matter and high viscosity of the anaerobic bioreactor effluent, where the pressure forces are not enough to overcome viscous forces. The operation at fluid velocities higher than 1.2 m/s generated a persistent foam which produced pump cavitation. Therefore, the most stable fluid recirculation velocities were found to be between 0.6 to 1.0 m/s.

Table 1. Anaerobic Bioreactor Effluent Average Composition.

Analysis	Composition
TSS, mg/L	36,972
VSS, mg/L	25,819 (70% of TSS)
TOC, mg/L	4215
Acetic Acid, mMole	147.4
Propionic Acid, mMole	15
Butyric Acid, mMole	13.1
PO ₄ -P, mg/L	233.3
NH ₄ -N, mg/L	532
Calcium, mg/L	75.6
Iron, mg/L	12.1

The permeate flux as a function of applied transmembrane pressure at three different velocities is shown in Fig. 4. As can be observed, the permeate flux increases with applied transmembrane pressure and fluid recirculation velocity. At applied pressure lower than 1.5 bar the permeate flux is directly proportional to the transmembrane pressure. At applied pressure higher than 1.5 bar the permeate flux is not more linearly dependent on pressure. This asymptotic flux-pressure relationship observed at high applied pressure is due to the effects of the concentration polarization and fouling over the membrane surface. As shown in Fig. 5, the permeate flux is also directly proportional to the fluid velocity. This means that increasing the tangential fluid velocity increases the boundary layer mass transfer coefficient, thus minimizing the concentration polarization layer and therefore produce higher permeate flux. For example, the operation at ΔP_m of 1.5 bar and $u = 0.65$ m/s the permeate flux is close to 15 L/hr-m², while at the same applied pressure but at velocity of 1.0 m/s, the flux is 30 L/hr-m². The filtration rate is increased by 100% when the fluid recirculation velocity is increased by 67 %.

Figures 6, 7 and 8 show the effect of applied transmembrane pressure and fluid recirculation velocity on VFA removal rate. As can be observed in these Figures, the VFA removal rates have a similar permeate flow pattern as the bulk fluid filtration rate. The VFA removal rate is directly proportional to the bulk permeate flux, because these acids are practically not retained by the membrane. It was found that the concentration of these acids in the feed stream to the membrane module was very similar to those in the permeate stream. The rate of

Fig. 4. Bioreactor Effluent Permeate Flux vs Transmembrane Pressure at Different Fluid Recirculation Velocities

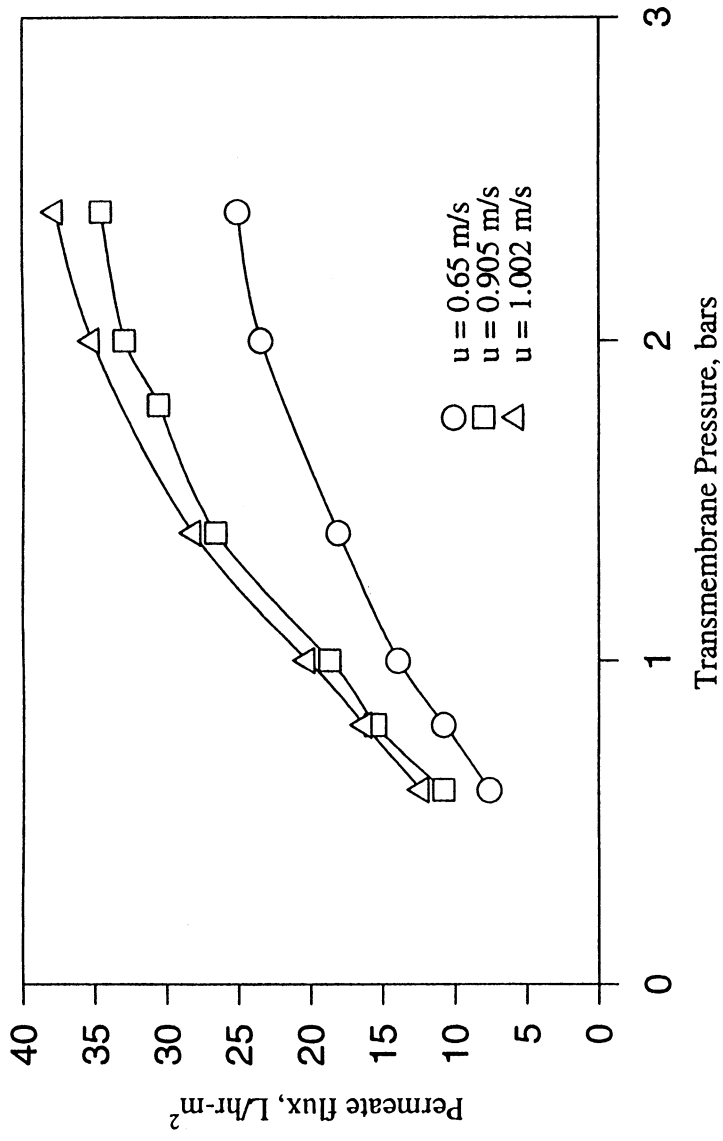
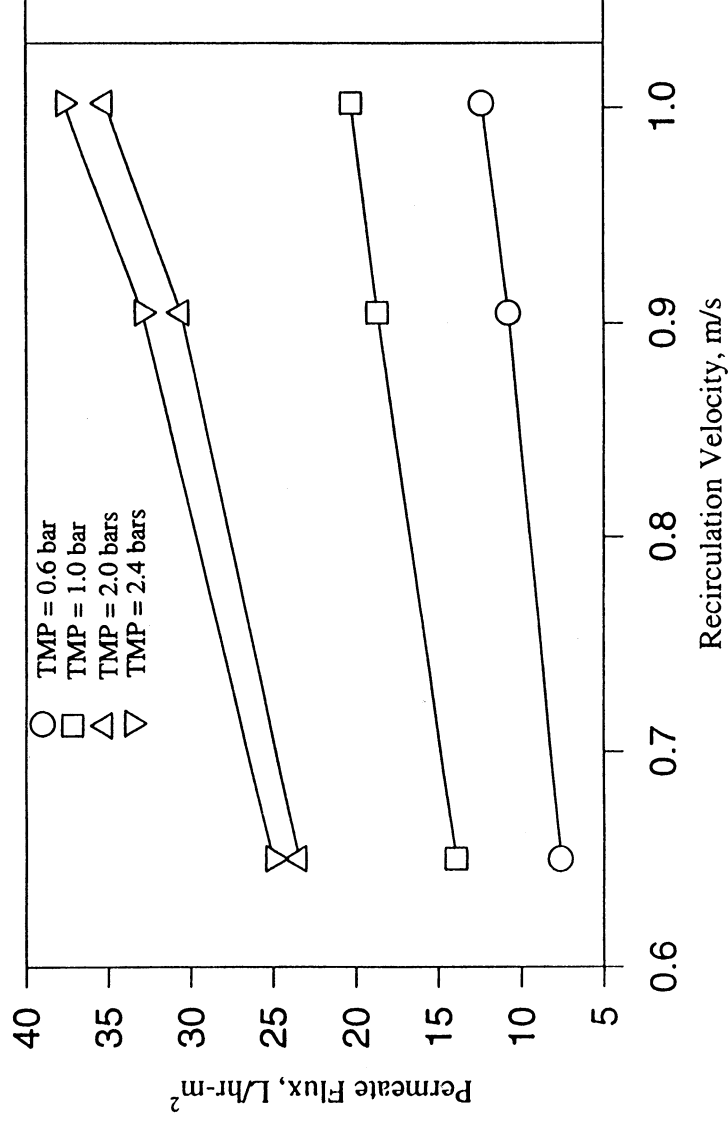

Fig. 5. Bioreactor Effluent Permeate Flux vs Fluid Recirculation Velocity at Different Applied Transmembrane Pressure



removal of acetic acid is higher than both propionic and butyric acids together. The rate of acids removal is proportional to their concentration in the feed stream. As can be observed in Table 1., the VFA is mostly composed of acetic acid. Other possible reason is that acetic acid has a molecular size smaller than propionic and butyric acid, which let it to pass through the membrane pores with less restriction . It is possible to obtain low total VFA removal rate as 60 g/hr-m^2 at $\Delta P_m = 0.6 \text{ bar}$ and $u = 0.65 \text{ m/s}$, and high removal rate as 340 g/hr-m^2 at $\Delta P_m = 2.4 \text{ bar}$ and $u = 1.0 \text{ m/s}$.

Figures 9, 10 and 11 show the effect of applied transmembrane pressure and fluid recirculation velocity on some bioreactor effluent nutrients removal rates. The rate of removal of these nutrients depends on the nutrient concentration in the bioreactor effluent and the rate of total fluid permeation rate. Also, it was observed that the nanofiltration membrane did not retain any of these nutrients. It was found that the concentrations of these nutrients in the bioreactor effluent were similar to that of the filtrate stream. Therefore, for a proper anaerobic bioreactor operation to avoid nutrients wash-out when coupled to a nanofiltration module it is then required to supply them at the same rates as they are removed by the nanofiltration system. One possible alternative is to remove the VFA from the membrane permeate stream by means of an anion ion exchange process and then recycled back these nutrients to the bioreactor and/or plants.

3.4 EFFECT OF TOTAL SUSPENDED SOLIDS CONCENTRATION ON TOTAL PERMEATE FLUX, VFA AND NUTRIENT REMOVAL RATES.

To study the effect of total suspended solids (TSS) concentration on nanofiltration process performance, a high recirculation velocity of 0.9 m/s , and applied transmembrane pressures in the range of 0.6 to 1.5 bar were selected. The reason to select these operating conditions was obtained from previous experiments as shown in Fig. 4., which demonstrated that the operation at pressure lower than 1.5 bar and high fluid recirculation velocity higher than 0.6 m/s reduced greatly the concentration polarization and fouling effects over the membrane surface.

Figure 12 shows the effect of feed TSS concentration on the membrane filtration rate for process applied pressure ranging from 0.6 to 1.4 bar . As can be observed, the permeate flux decreased exponentially with the feed TSS concentration. A plot of the permeate flux versus the natural logarithm of TSS is shown in Fig. 13. All the experimental data fitted very well with a correlation coefficient of 0.99 . All the regression lines at different applied pressures are almost parallel, which means that the operation at a fluid recirculation of 0.9 m/s produce the same degree of mixing or turbulence over the membrane boundary layer and is independent of the applied pressure. The average boundary layer mass transfer coefficient obtained from the slopes of the regression lines and using Equation 1., is $5.98 \times 10^6 \text{ m/s}$. It is found to be almost independent of applied TMP.

Fig. 6. Volatile Fatty Acids Removal Rate from Bioreactor Effluent at a Recirculation Velocity of 0.65 m/s

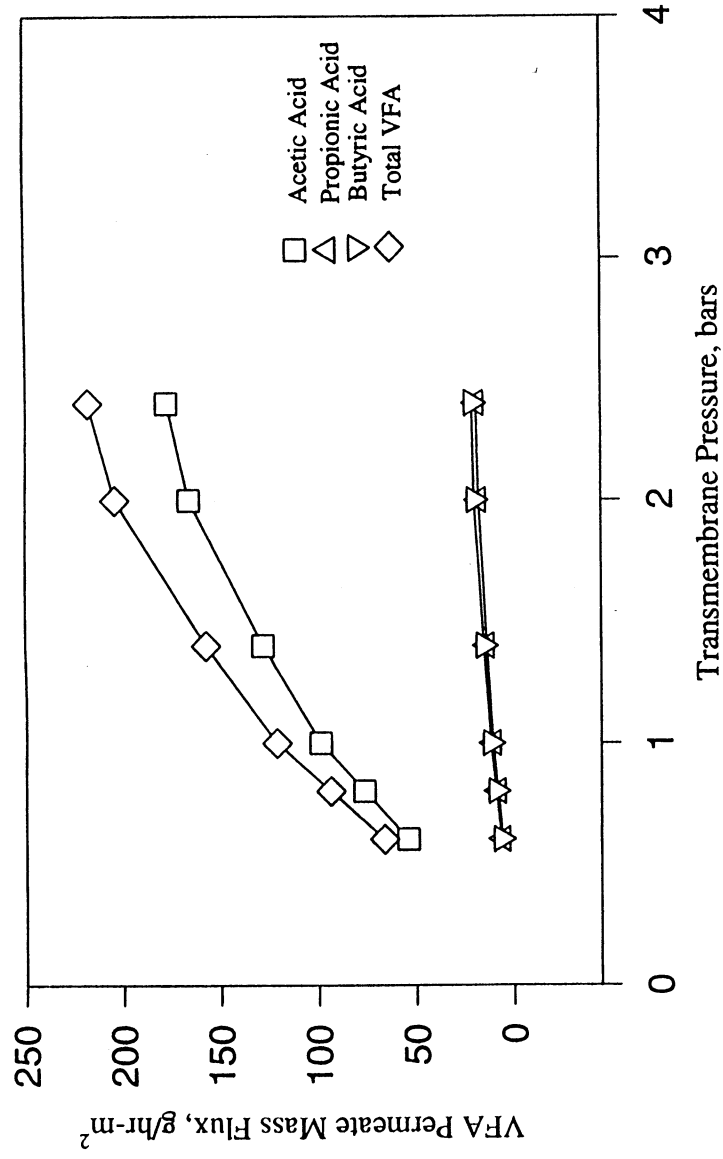

Fig. 7. Volatile Fatty Acid Removal Rate from Bioreactor Effluent at a Recirculation Velocity of 0.90 m/s

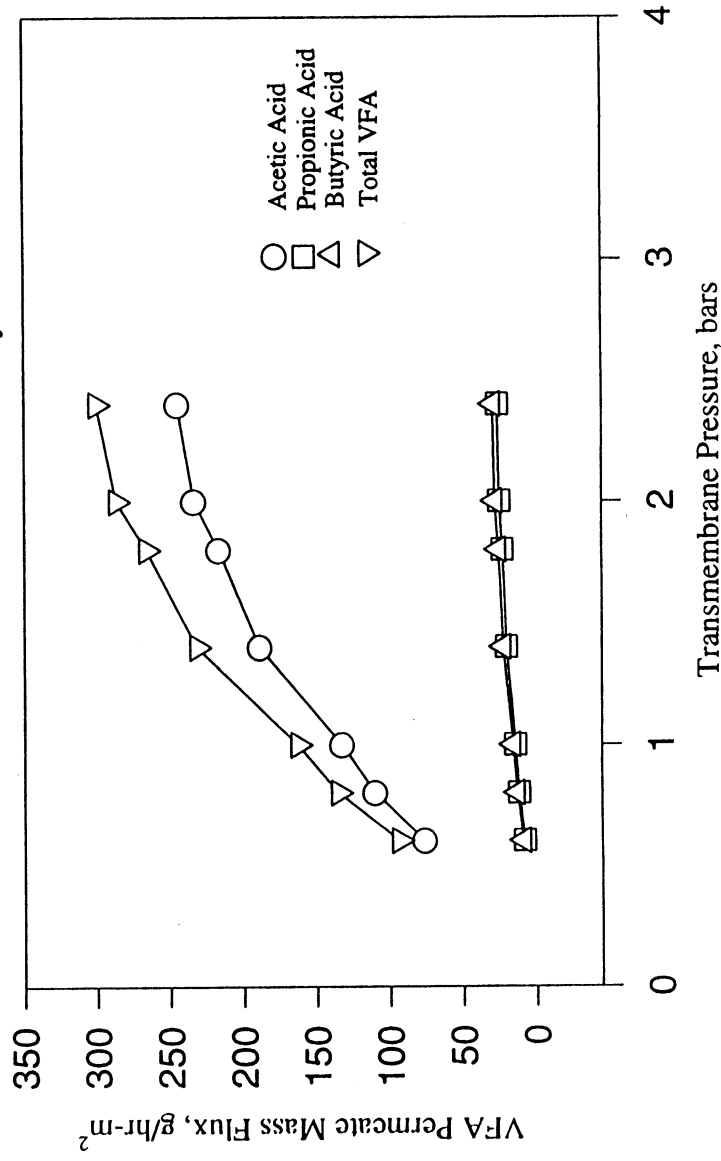

Fig. 8. Volatile Fatty Acids Removal Rate from Bioreactor Effluent At a Recirculation Velocity of 1.0 m/s

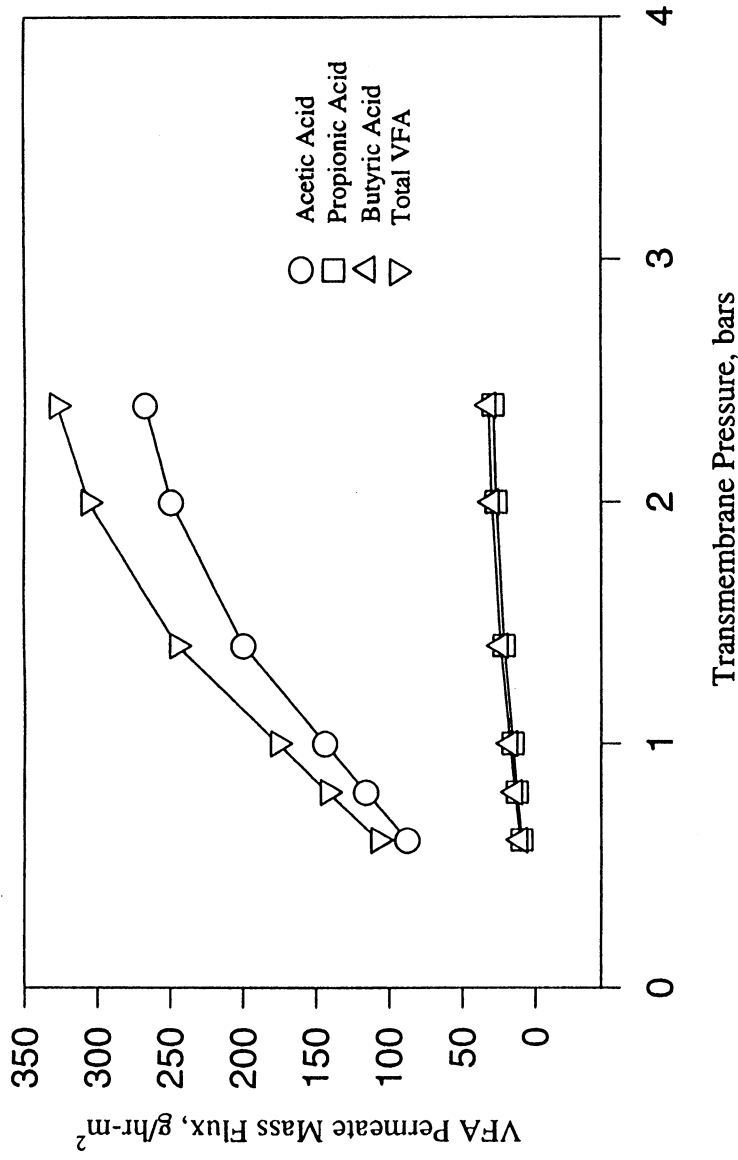

Fig. 9. Nutrients Removal Rate from Bioreactor Effluent at a Recirculation Velocity of 0.65 m/s

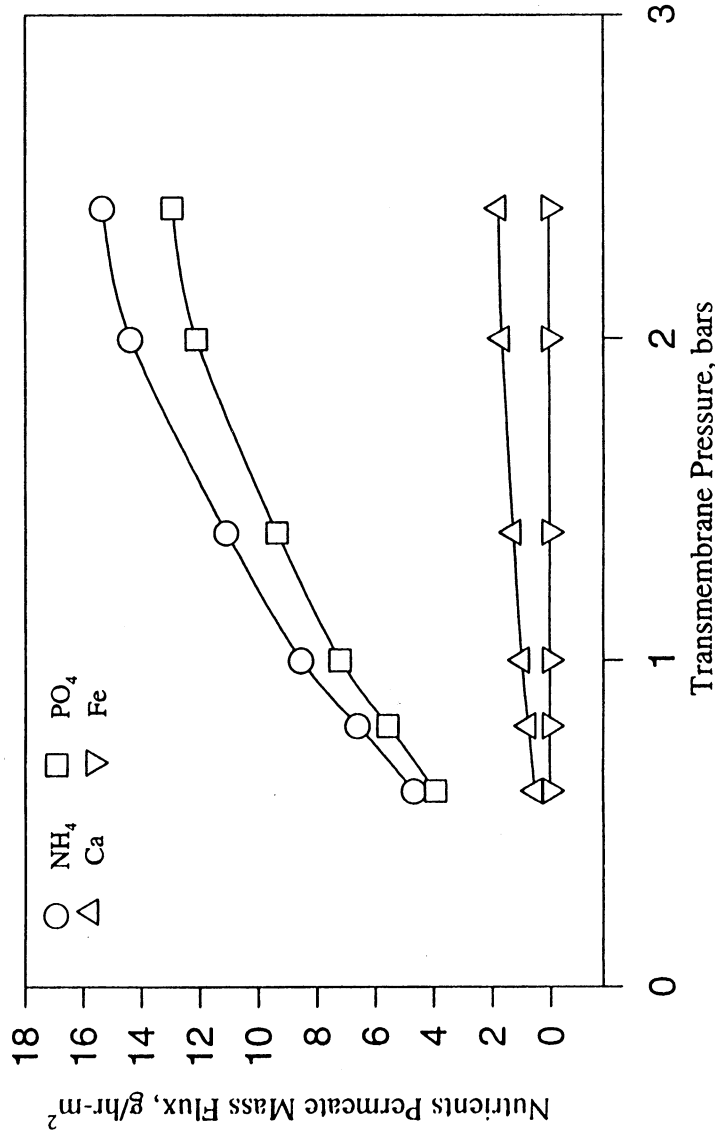

Fig. 10. Nutrients Removal Rate from Bioreactor Effluent at a Recirculation Velocity of 0.90 m/s

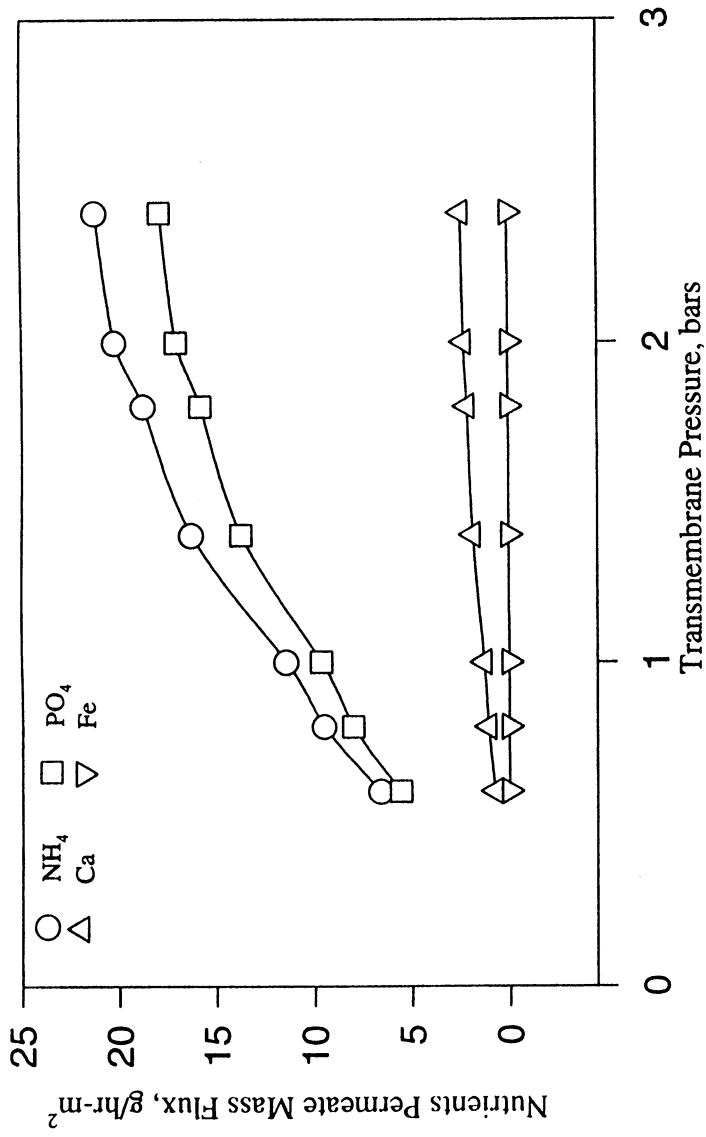

Fig. 11. Nutrients Removal Rate from Bioreactor Effluent at a Recirculation Velocity of 1.0 m/s

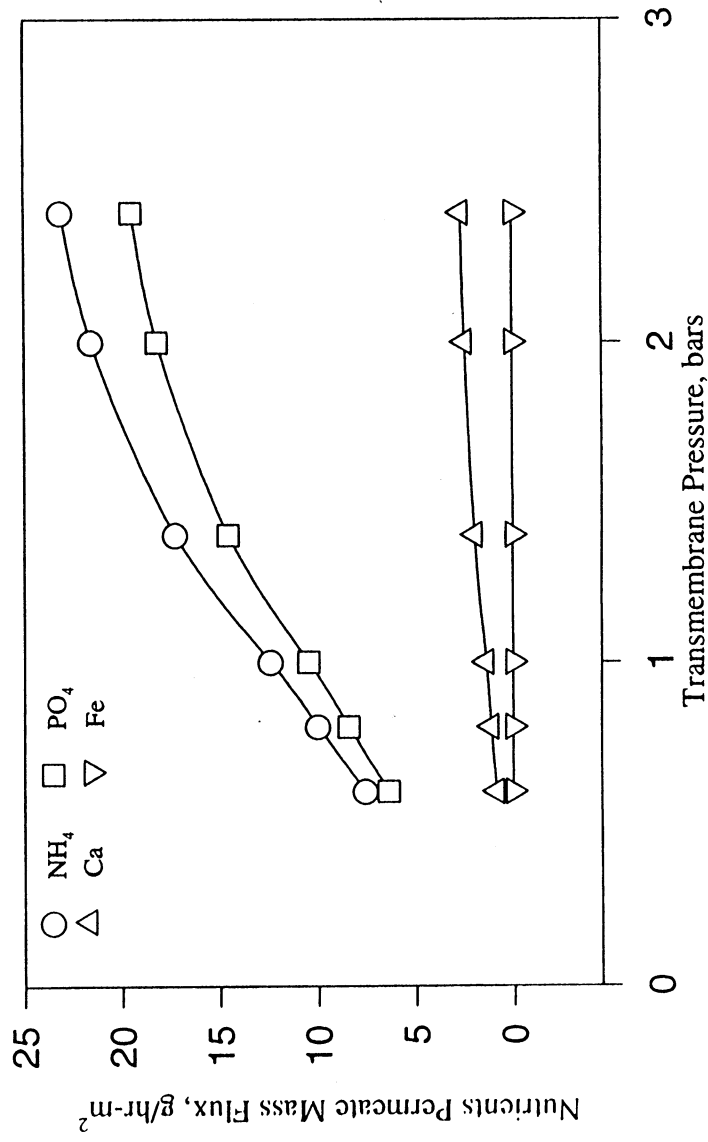

Fig. 12. Effect of Bioreactor Effluent Total Suspended Solids Concentration on Permeate Flux at $U = 0.9$ m/s

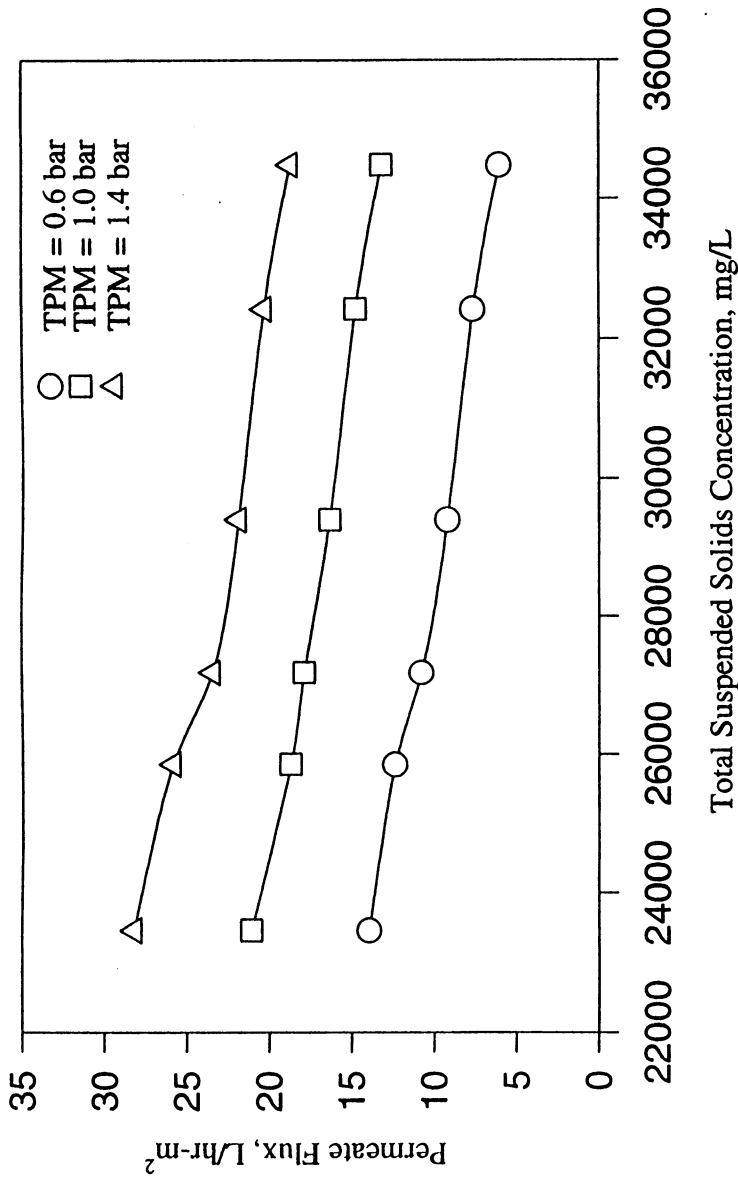
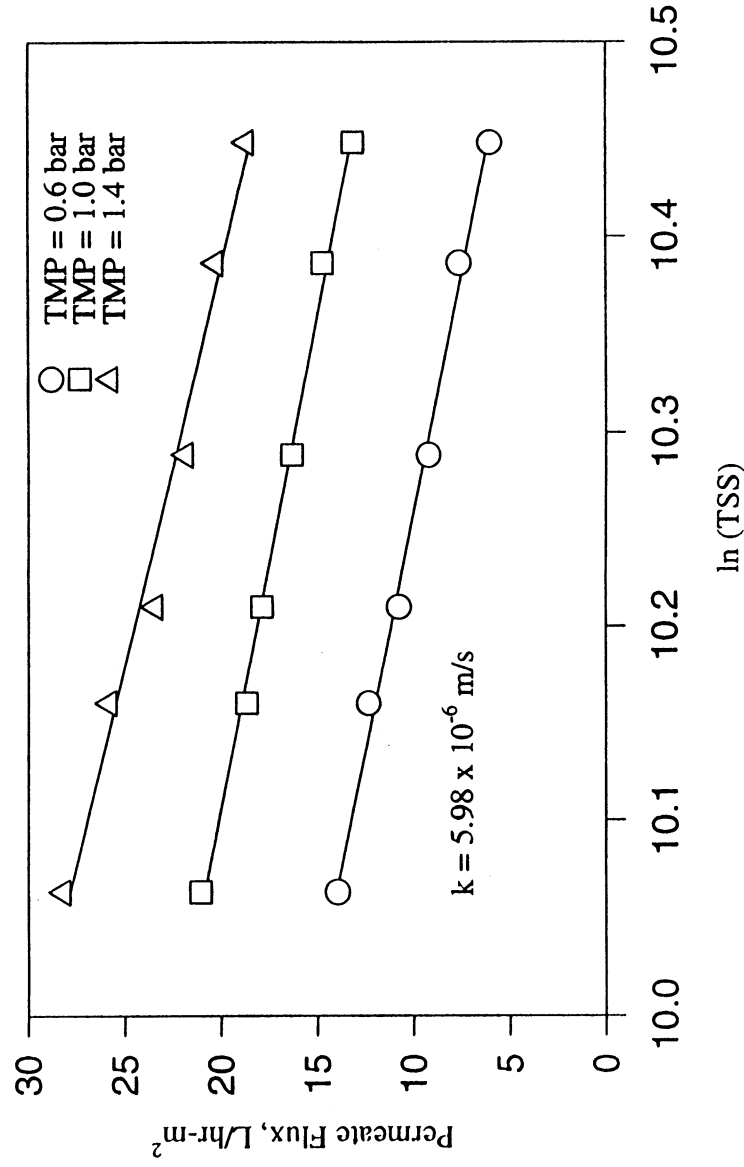

Fig. 13. Effect of Bioreactor Effluent Total Suspended Solids Concentration on Permeate Flux at $U = 0.9$ m/s (Semi-log Plot)



As noted in Equation 3, 4, and 5 the permeate flux is inversely proportional to solution viscosity. Any increase in the feed concentration will also increase the medium viscosity and therefore, affect inversely the membrane filtrate rate. Also, as the feed TSS concentration increases, there is more resistance of the fluid moving from the solution bulk to the membrane surface due to polarization and gel layers over the membrane surface.

The feed TSS concentration was changed from 23,466 to 34,880 mg/L, which represent a 47% increase in TSS concentration. For this increase in TSS concentration, the permeate flux was reduced from 13.9 to 6.0 L/hr-m² (59% reduction) at $\Delta P_m = 0.6$ bar, from 21.1 to 13.2 L/hr-m² (37% reduction) at $\Delta P_m = 1.0$ bar, and from 28.2 to 18.7 L/hr-m² at $\Delta P_m = 1.4$ bar. As observed in Fig. 14, the permeate flux is directly proportional to the applied pressure for all the bioreactor effluent feed TSS concentrations. The operation at $u = 0.9$ m/s and $\Delta P_m < 1.5$ bar keep the filtration operation with minimum effects of polarization and fouling.

Figures 15, 16, and 17 show the effect of TSS concentration on VFA removal rates operating at $u = 0.9$ m/s and applied pressure ranging from 0.6 to 1.4 bar. For and increase of feed TSS concentration from 23,466 to 34,880 mg/L, the total VFA removal rate was reduced from 108.8 to 48.0 g/hr-m² (56% reduction) at $\Delta P_m = 0.6$ bar, from 164.4 to 104.8 g/hr-m² (36% reduction) at $\Delta P_m = 1.0$ bar, and from 220 to 148 g/hr-m² (32% reduction) at $\Delta P_m = 1.4$ bar. This means that the total VFA removal rate is directly proportional to the applied pressure, but is inversely proportional to the feed TSS concentration. As observed in these Figures, the removal rate of acetic acid is much higher than the removal rates of both propionic and butyric acids, but the total reduction percent in removal rates due to the increase in TSS concentration are almost the same for the acids.

Figures 18, 19, and 20 show the effect of TSS concentration on some bioreactor effluent nutrients removal rates. The nutrients removal rates were found to be directly proportional to the applied pressure, total filtrate rate, nutrient concentration in the bioreactor effluent (see Table 1), and inversely proportional to the TSS concentration.

3.5 EFFECT OF PROCESS OPERATING TIME ON FLUID PERMEATE FLUX.

Figure 21 shows the effect of the nanofiltration membrane separation process operating time on permeate flux at $u = 0.9$ m/s and applied pressure ranging from 0.6 to 1.5 bar. The concentration of feed TSS was kept constant at 23,780 mg/L during all the transient period. As can be observed, the permeate flux declines rapidly during the first 5 to 8 hours, and then levels off with a diminishing rate of flux decay. This occurred as consequence of the accumulation of suspended and some dissolved matter over the membrane surface which no longer participates in the mass-transport to or away from the membrane. A cake or gel layer may be formed which constitutes a considerable hydraulic resistance. At operating time higher than 8 hours the flux-time relationship reaches asymptotically steady-state operating conditions. This means that the

Fig. 14. Effect of Applied Transmembrane Pressure on Permeate Flux at Different TSS Concentration at $U = 0.9$ m/s

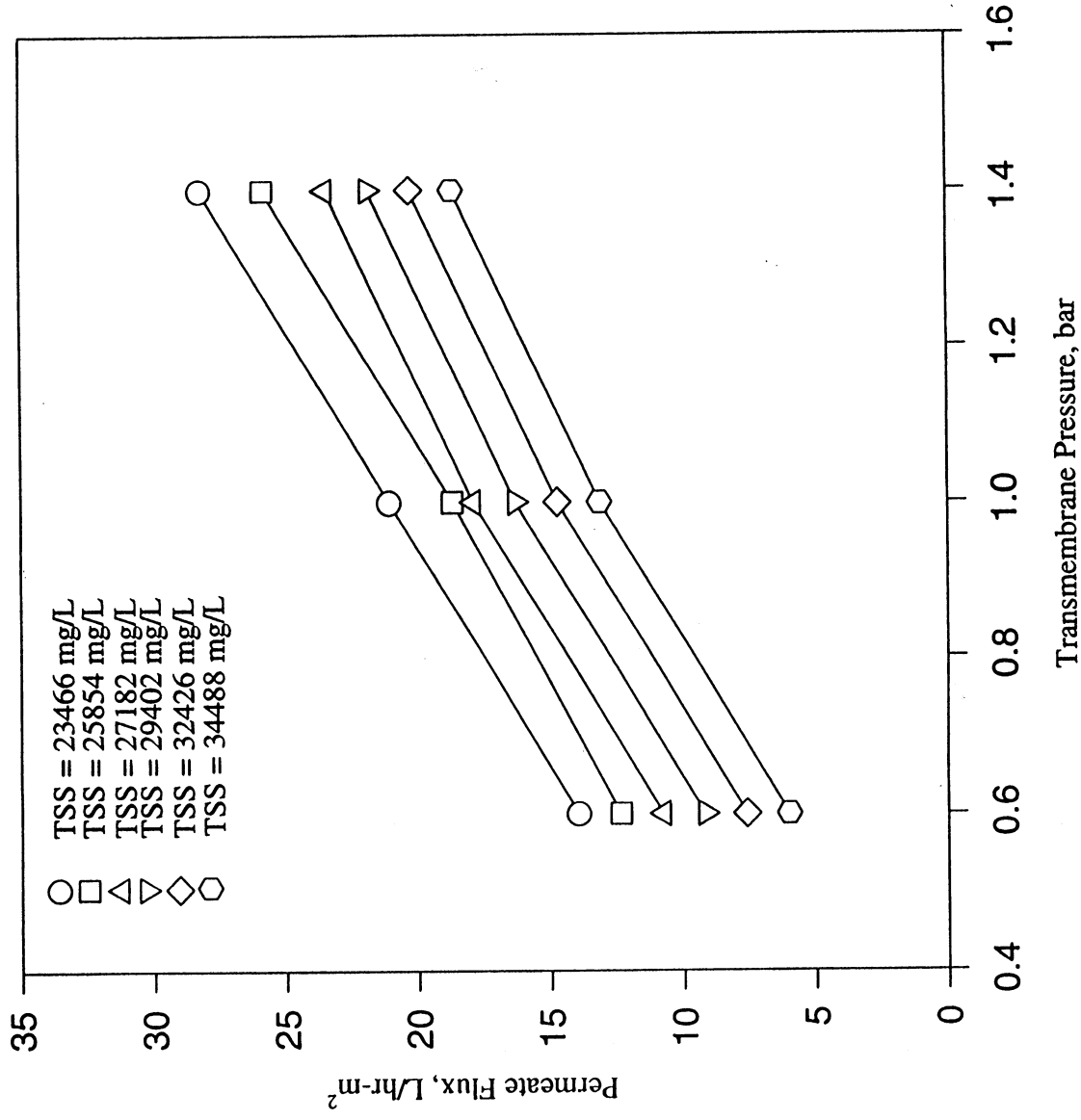

Fig. 15. Effect of Bioreactor Broth Total Suspended Solids Concentration on VFA Removal Rate at TMP = 0.6 bar and $U = 0.9$ m/s

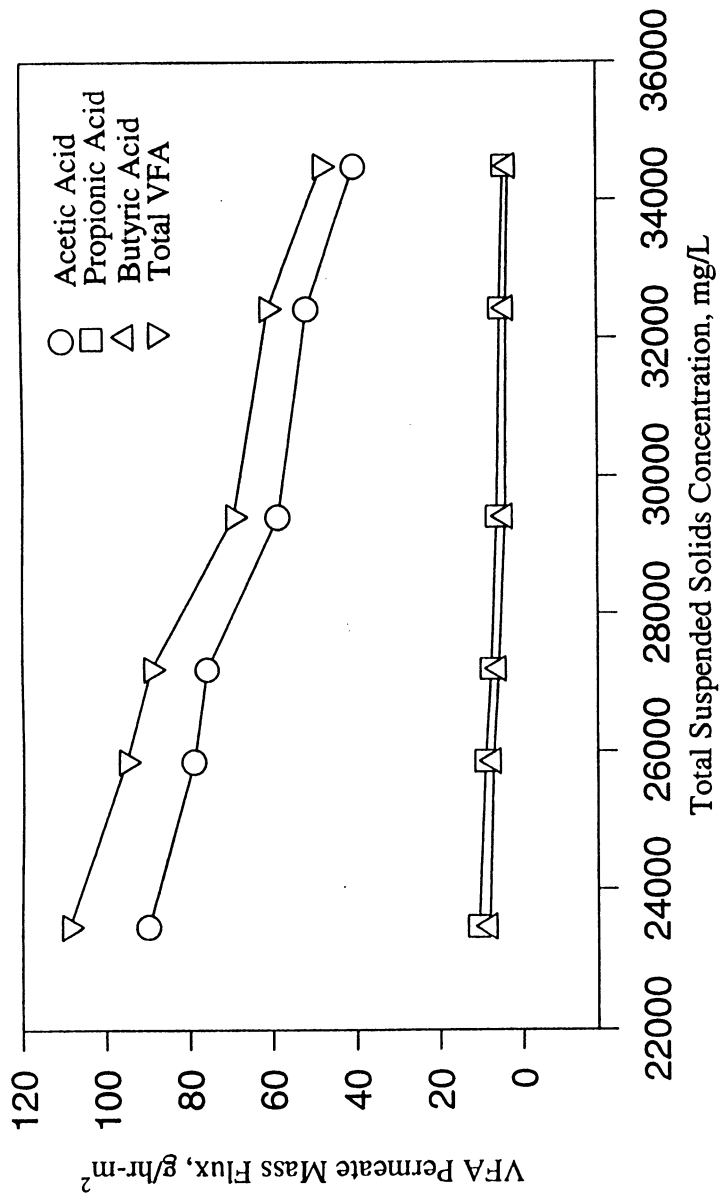

Fig. 16. Effect of Bioreactor Broth Total Suspended Solids Concentration on VFA Removal Rate at TMP = 1.0 bar and $U = 0.9$ m/s

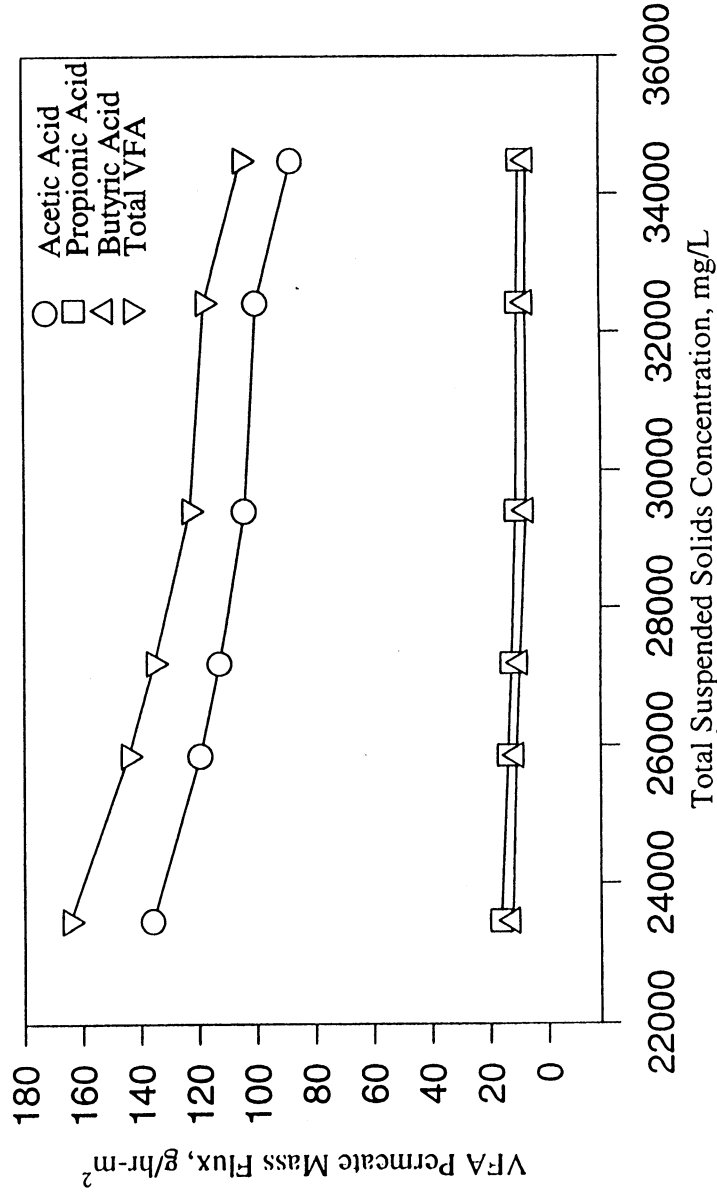

Fig. 17. Effect of Bioreactor Broth Total Suspended Solids Concentration on VFA Removal Rate at TMP = 1.4 bar and $U = 0.9$ m/s

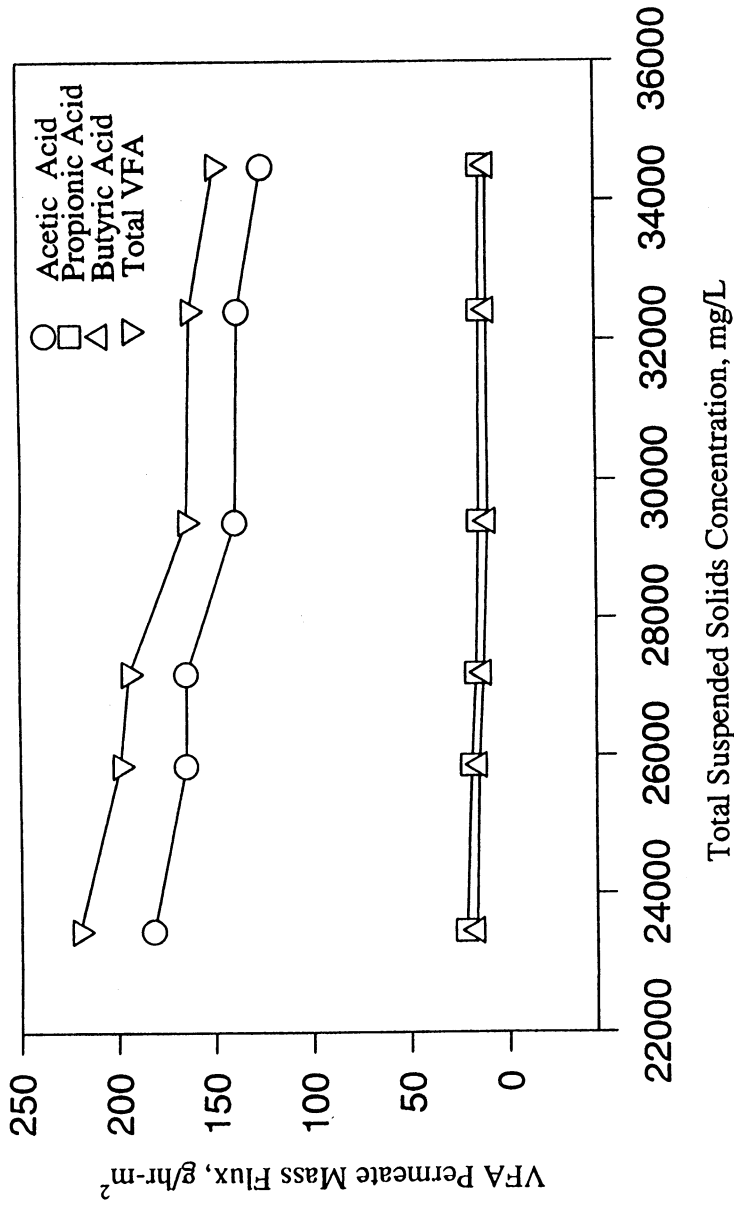

Fig. 18. Effect of Total Suspended Solids Concentration on Nutrients Removal Rate at TMP = 0.6 bar and $U = 0.9$ m/s

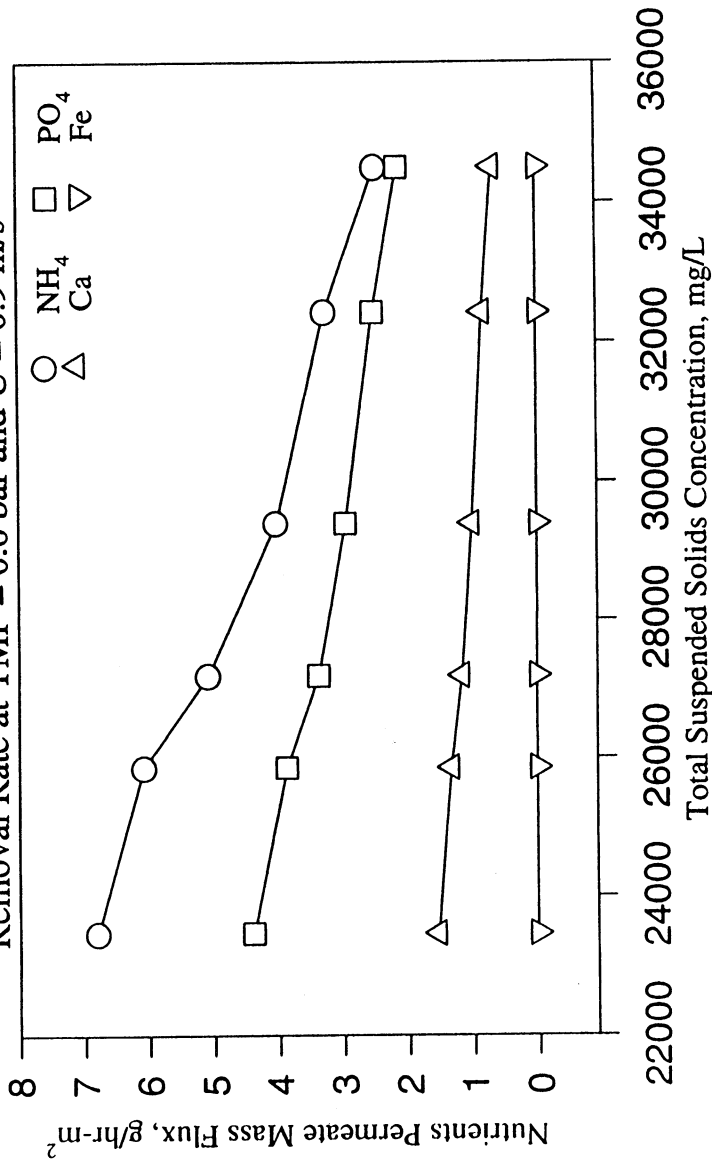

Fig. 19. Effect of Total Suspended Solids Concentration on Nutrients Removal Rate at TMP = 1.0 bar and $U = 0.9$ m/s

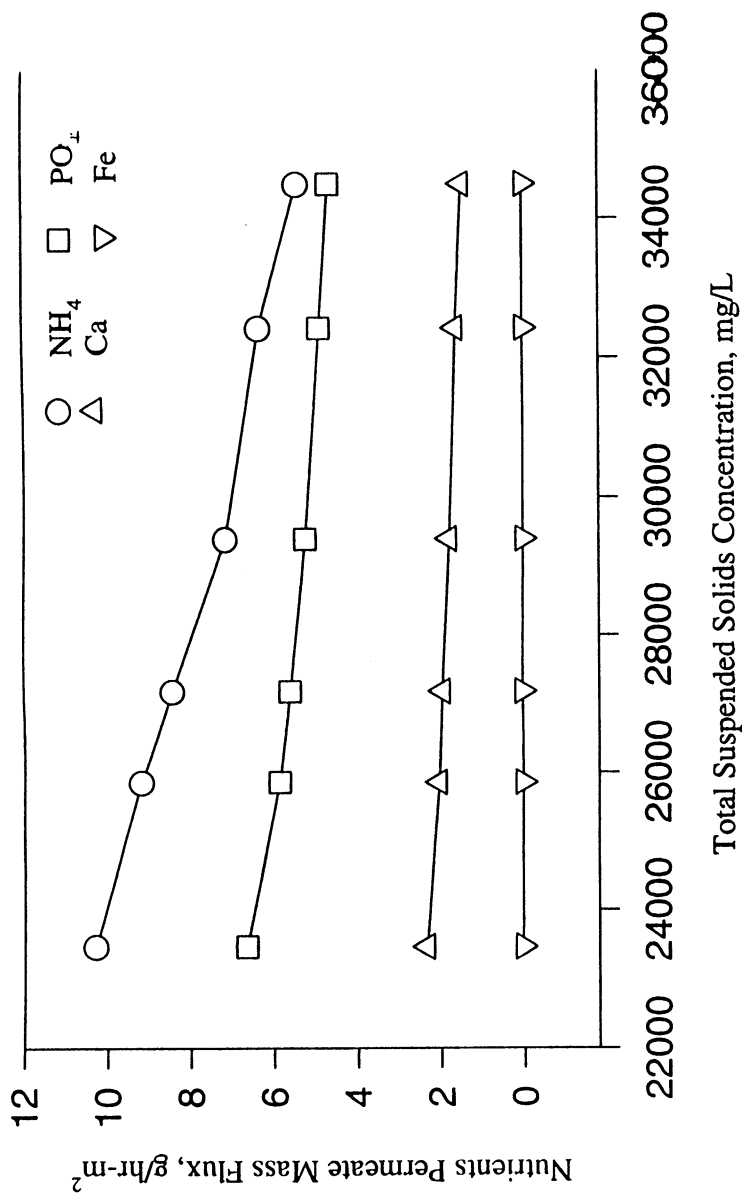

Fig. 20. Effect of Total Suspended Solids Concentration on Nutrients Removal Rate at TMP = 1.4 and $U = 0.9$ m/s

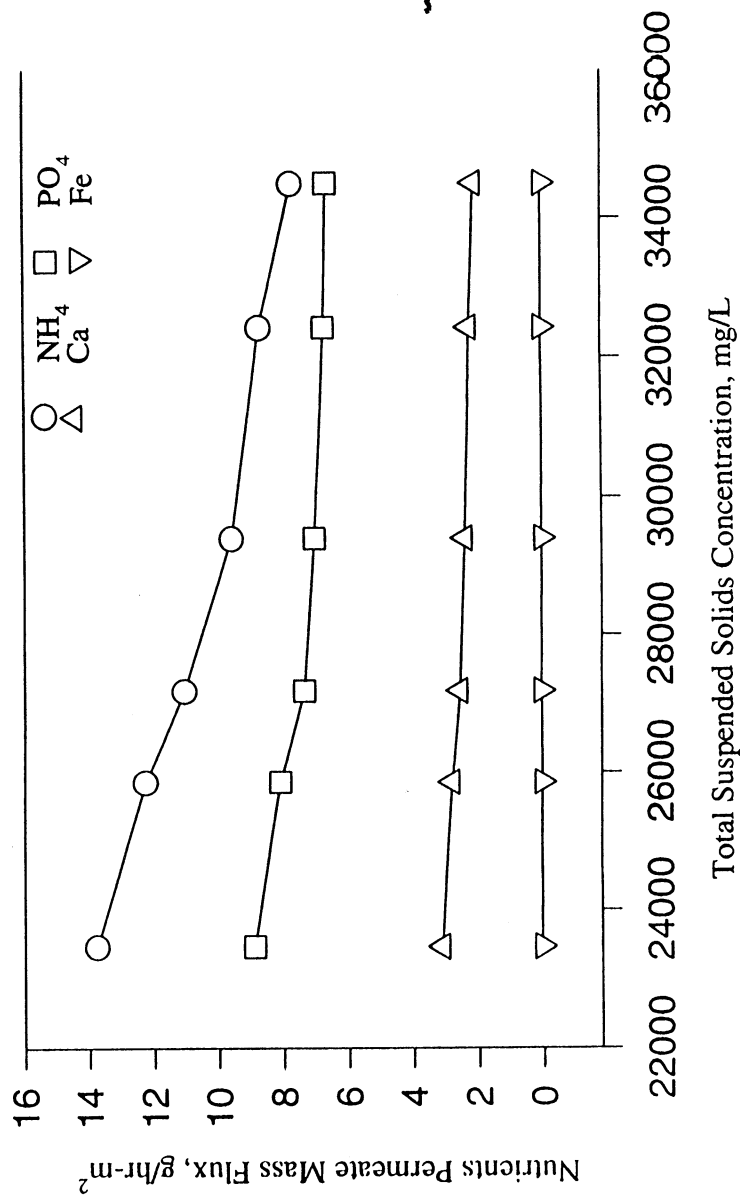
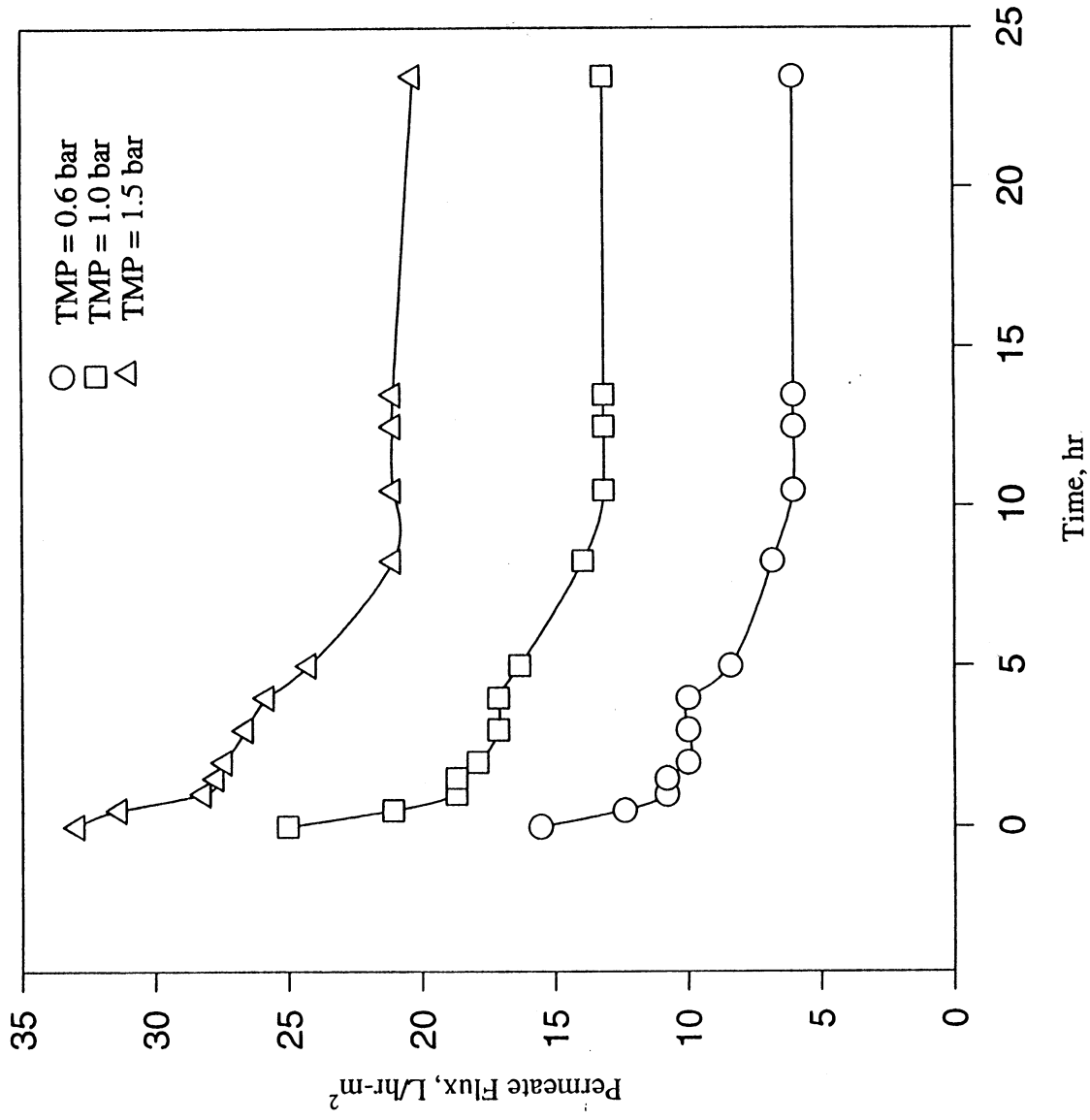

Fig. 21. Variation of Permeate Flux with Time at Different Applied Transmembrane Pressure at $U = 0.9 \text{ m/s}$



gel layer thickness is highly susceptible to the shear rate produced by the fluid hydrodynamic conditions (16). The layer thickness reached a finite value which is controlled by the fluid shear rate, and any additional suspended matter deposited over this layer is swept away by the cross-flow fluid.

During the flux-time decline period (0 to 10 hours) the flux decreased from 15.5 to 6.0 L/hr-m² (61% flux reduction) at $\Delta P_m = 0.6$ bar, from 25 to 13 L/hr-m² (38% flux reduction) at $\Delta P_m = 1.0$ bar, and from 33 to 21 L/hr-m² (36% flux reduction) at $\Delta P_m = 1.5$ bar. One practical way to restore the permeate flux is by means of high cross-flow velocities, which produce higher shear rate conditions to sweep deposited matter away, also by interrupting the permeate flux. As the permeate flux is interrupted the cake is not longer forced against the membrane surface by the permeate flux and may flow laterally over the membrane surface and is discharged with the retentate stream.

IV. CONCLUSIONS

Based on the results obtained using a nanofiltration tubular ceramic membrane module to study the anaerobic bioreactor permeation characteristics, the following conclusions were reached:

The bioreactor effluent permeate flux is directly proportional to the fluid recirculation velocity in the range between 0.6 to 1.0 m/s and to the applied transmembrane pressure when this is lower than 1.5 bar. The filtrate rate flux is significantly affected by polarization and fouling effects at pressure higher than 1.5 bar. The total permeate flux decreases exponentially with the increasing of the bioreactor effluent total suspended solids concentration. The permeate flux declines rapidly during the first 5 to 8 hours and then levels off with a diminishing rate of decay. This occurred as result of the accumulation of suspended matter over the membrane surface which no longer participates in the mass-transport to or away from the membrane. One practical way to restore the permeate flux is by means of high cross-flow velocities, which produce high shear rate conditions to sweep deposited matter away, also by means of interrupting the permeate flux.

The volatile fatty acids removal rate from the bioreactor effluent is proportional to the applied pressure, fluid recirculation velocity, acid concentration in the fermentation broth, and permeate flux, but inversely proportional to the total suspended solids concentration. Fermentation medium nutrient, such as ammonium, phosphate, calcium, and iron are also removed in the permeate stream at rates proportional to nutrient concentration in bioreactor medium, total permeate flux, and inversely proportional to TSS concentration.

The nanofiltration separation using ZrO_2 - TiO_2 membrane over a carbon support with large internal diameter enough to avoid system clogging proved to be an acceptable technique for the on-line removal of VFA from the CELSS anaerobic bioreactor. Due to bioreactor effluent's nutrients are also removed simultaneously with VFA when coupling it to the bioreactor, it is highly recommended to supply them at the same rate as they are removed. One possible alternative to recover permeate stream nutrients is to remove the VFA by mean of basic ion-exchange resins and then recycle the nutrients to the bioreactor.

V. REFERENCES

1. Chynoweth, D.P., "Overview. In D.P. Chynoweth and R. Isaacson (Ed.). *Anaerobic Digestion of Biomass*, Elsevier Applied Science, London, (1987) p. 171.
2. Rijken, B.A. Anaerobic digestion of solid organic matter. In: O. Kitanic and C.W. Hall (Ed.), *Biomass Handbook*. Gordon and Beach Science Publishers, New York, NY, (1989) p 319.
3. Buller, D.C., W. Parker, and J.S.G. Reid. Short-chain fatty acids as inhibitors of gibberellin-induced amylolysis in barley endosperm. *Nature*, 260 (1976) 169.
4. Russell, J.B. and D.B. Dombrowski. Effect of pH on efficiency of growth by pure culture of rumen bacteria in continuous culture. *Appl. Environ. Microbiol.* 32 (1980) 604.
5. Cheryan, M., M.A. Mehaia. Ethanol production in a membrane recycle bioreactor. Conversion of glucose using *Saccharomyces cerevisiae*. *Process Biochem.*, 19, (1984) 204.
6. Abbott, B.J. and P. Gerhardt. Dialysis fermentation I. Enhanced production of salicylic acid from naphthalene by *pseudonoma fluorescens*. *Biotechnol. Bioeng.* 12 (1970) 577.
7. Carrondo, M.J.T., J.P.S.G. Crespo, and M.J. Moura. Production of propionic acid using xylose utilizing *Propionibacterium*. *Appl. Biochem. Biotechnol.*, 17 (1988) 295.
8. Crespo, J.P.S.G., M.J. Moura, J.S. Almeida, and M.J.T. Carrondo. Ultrafiltration membrane cell recycle for continuous culture of *Propionibacterium*. *J. Membrane Sci.*, 61 (1991) 303.
9. Xavier, A.M.R.B., L.M.D. Goncalves, J.L. Moreira, and M.J.T. Carrondo. Operational Patterns affecting lactic acid production in ultrafiltration cell recycle bioreactor. *Biotechnol. Bioeng.* 45 (1995) 320.
10. Blatt, W.F., A. Dravid, A.S. Michels, and L. Nelson. Solute polarization and cake formation in membrane ultrafiltration: Causes, consequences, and control technique, in J.E. Flinn (Ed.), *Membrane Sciences and Technology*, Plenum, New York, NY, (1970) 47.
11. Trettin, D.R. and M.R. Doshi. In *Synthetic Membranes: Hyperfiltration and ultrafiltration uses*. A.F. Turbak (Ed.), American Chem. Soc., Washington, D.C., 1981.
12. Porter, M.C. Concentration polarization with membrane ultrafiltration. *Ind. Eng. Chem. Prod. Res. Dev.*, 11, (1972) 234.

13. Bhattacharjee, C. and P.K. Bhattacharya. Flux decline analysis in ultrafiltration of kraft black liquor. *J. Membrane Sci.*, **82**, (1993) 1.
14. Treybal, R.E., Mass Transfer Operation, McGraw Hill, New York, NY. 1980)
15. Sherwood, R.K., R.L. Pigford, and C.R. Wilke, Mass Transfer, McGraw Hill, New York, NY, (1975).
16. Jönsson, A-S. Influence of shear rate on the flux during ultrafiltration of colloidal substances. *J. Membrane Sci.*, **72**, (1993) 93.
17. Althouse, J.W. and L.L. Tavlarides. Analysis of organic extractant systems for acetic acids removal for calcium magnesium acetate production. *Ind. Chem. Chem. Res.* **31** (1992) 1971.
18. Garcia, A.A. and C.J. King. The use of basic polymers sorbents for the recovery of acetic acid from aqueous dilute solution. *Ind. Chem. Chem. Res.* **28** (1989) 2104.
19. Steiber, R.W. and P. Gerhardt. Dialysis continuous process for ammonium lactate fermentation: Simulated prefermentor and cell recycling systems. *Biotechnol. Bioeng.* **23** (1981) 523.
20. Colon, G. and J.R. Rosenau. Lactic acid recovery from fermented acid-chesse whey via electro dialysis. Paper presented in the 1987 Annual AIChE Meeting, New York, NY.
21. Weir, A.J., B.A. Glatz, and C.E. Glatz. Recovery of propionic acid from fermentation broth by electro dialysis. *Biotechnol. Prog.* **8** (1992) 479.