

Energy Beam Highways Through The Skies

by

Leik N. Myrabo
Associate Professor
Rensselaer Polytechnic Institute
Troy, NY 12180-3590
Fax: 518-276-2623
Email: myrabl@rpi.edu

Sp 25
39550

for

"Transportation Beyond 2000: Engineering Design for the Future"

National Aeronautics and Space Administration
Langley Research Center
Hampton, VA 23681-0001
September 26-28, 1995

Energy Beam Highways Through The Skies

**Leik N. Myrabo
Associate Professor
Rensselaer Polytechnic Institute
Troy, NY 12180-3590**

Abstract:

The emergence of Energy Beam Flight Transportation Systems could dramatically change the way we travel in the 21st Century. A framework for formulating "Highways of Light" and the top level architectures that invoke radically new Space Power Grid infrastructure, are introduced. Basically, such flight systems, hereafter called Lightcraft, would employ off-board energy beam sources (either laser or microwave) to energize on-board dependent "motors" -- instead of the traditional autonomous "engines" with their on-board energy sources (e.g., chemical fuels).

Extreme reductions in vehicle dry mass appear feasible with the use of off-board power and a high degree of on-board artificial intelligence. Such vehicles may no longer need airports for refueling (since they require no propellant), and could possibly pick up travelers at their homes -- before motoring over to one of many local boost stations, for the flight out. With off-board power, hyper-energetic acceleration performance and boost-glide trajectories become feasible. Hypersonic MHD airbreathing propulsion can enable boosts up to twice escape velocity, which will cut trip times to the moon down to 5.5 hours. The predominant technological, environmental and social factors that will result from such transportation systems will be stressed.

This presentation first introduces the remote source siting options for the space power system infrastructure, and then provides three representative laser/microwave Lightcraft options (derived from historical Case Studies): i.e., "Acom", "Toy Top" and "Disc." Next the gamut of combined-cycle engine options developed for these Lightcraft are examined -- to illuminate the 'emerging technologies' that must be harnessed to produce flight hardware. Needed proof-of-concept experiments are identified, along with the Macro-Level Issues that can springboard these revolutionary concepts into hardware reality.

Presentation Outline

- **Introduction**
- **Open Maglev Interstate Highway System**
- **Shuttle Delivered Space Assets**
- **Satellite Solar Power ("Floatilla")**
- **Beam-Powered Flight (laser/microwave)**
- **Human Factors in 21st Century Flight**
- **Summary & Conclusions**

SSP-Powered Transportation & G/B Electric Grid

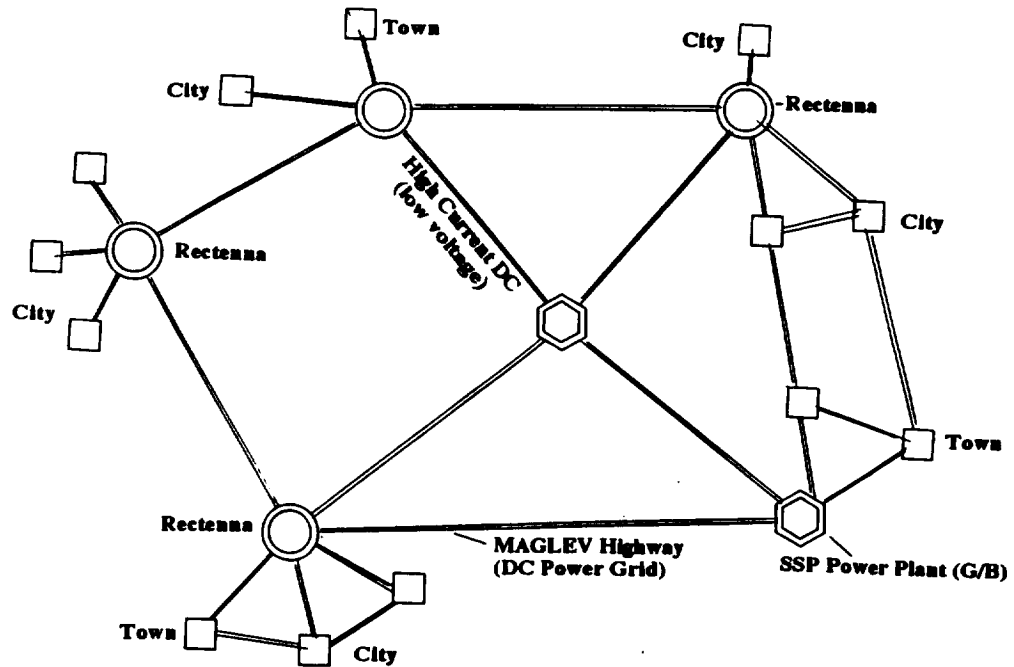

*SMES in Power Grid.

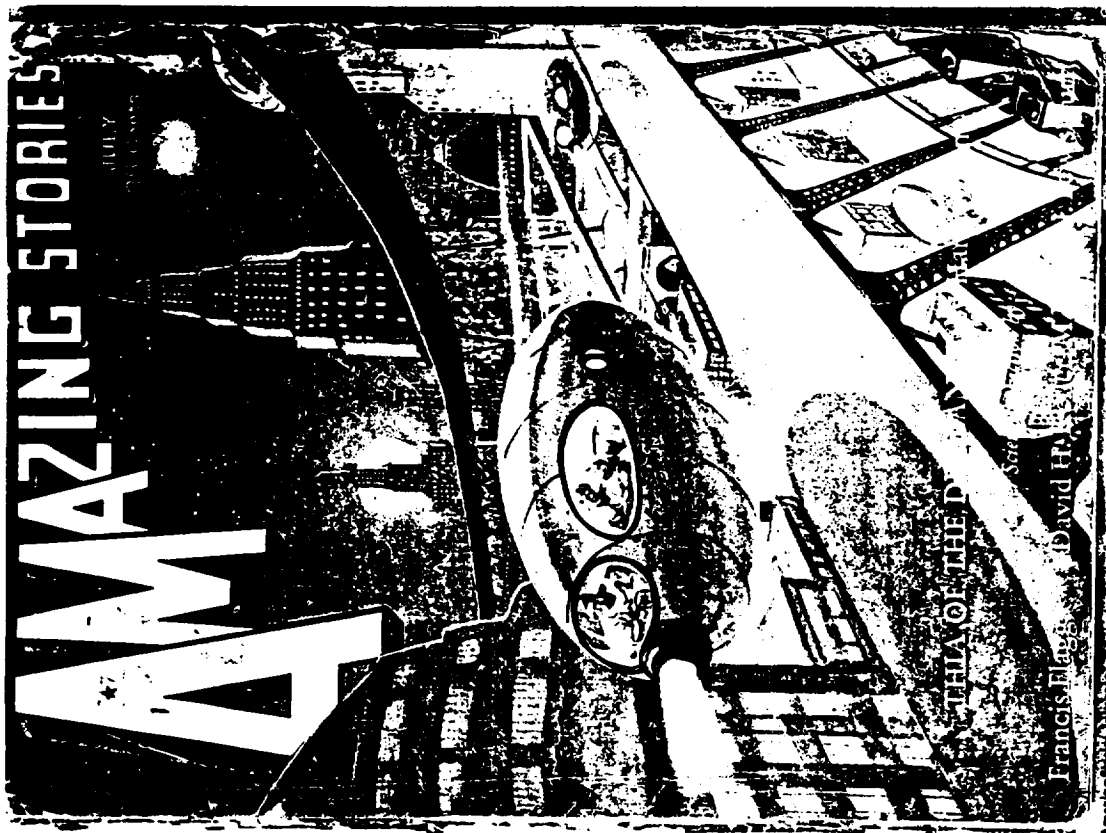

SSP-Powered Interstate Transportation **(Integrated with Ground-Based DC Electric Grid)**

- **Low Voltage, High Current DC Transmission**
(instead of present AC high voltage, low current)
- **High Temperature Superconductor Cable Network**
(connects rectenna receivers and ground-based SSP plants to cities, towns and industrial customers)
- **Superconducting Cables Provide Magnetic Fields for**
MAGLEV Highway (and SMES in the Power Grid)
- **Ideal Match With Developing Nation's Energy Needs**
(i.e., SSP-supplied, non-polluting electric transportation and base load power)
- **Entire DC Power Grid Might Be Modulated to Provide**
Ultra-Low Frequency Communications to Underwater
Communities and Submarines.



Superconductor DC Current Levitation System

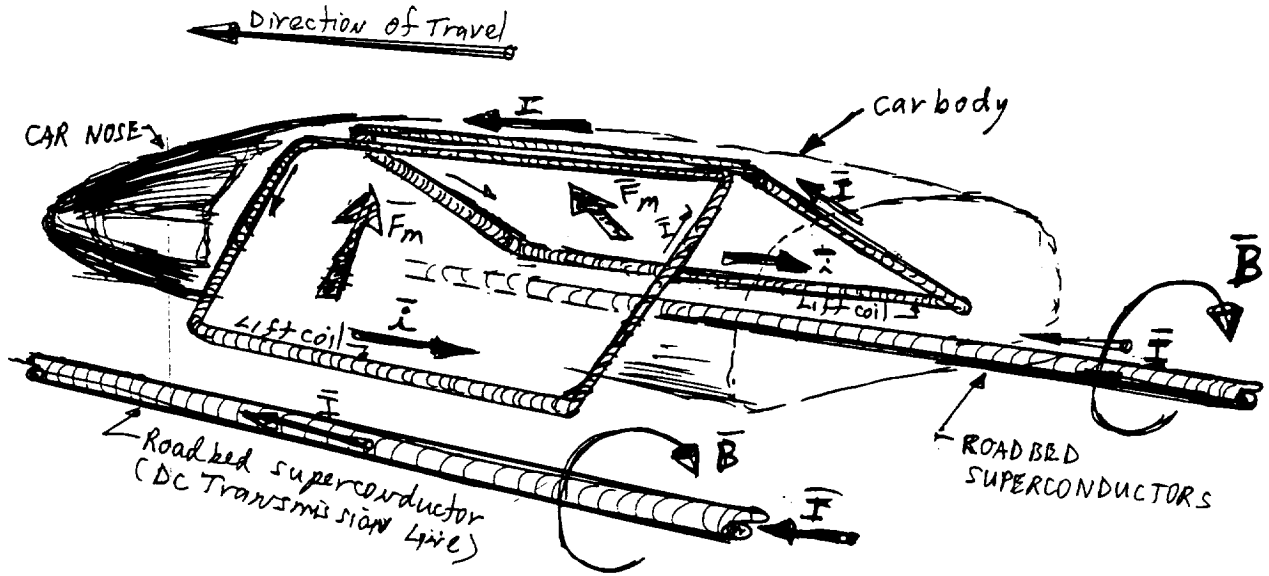

Note:
 $B \propto (1/r)$ for Roadbed superconductors.

End View of MAGLEV Auto and Levitating Roadbed (showing location of tractor coils)

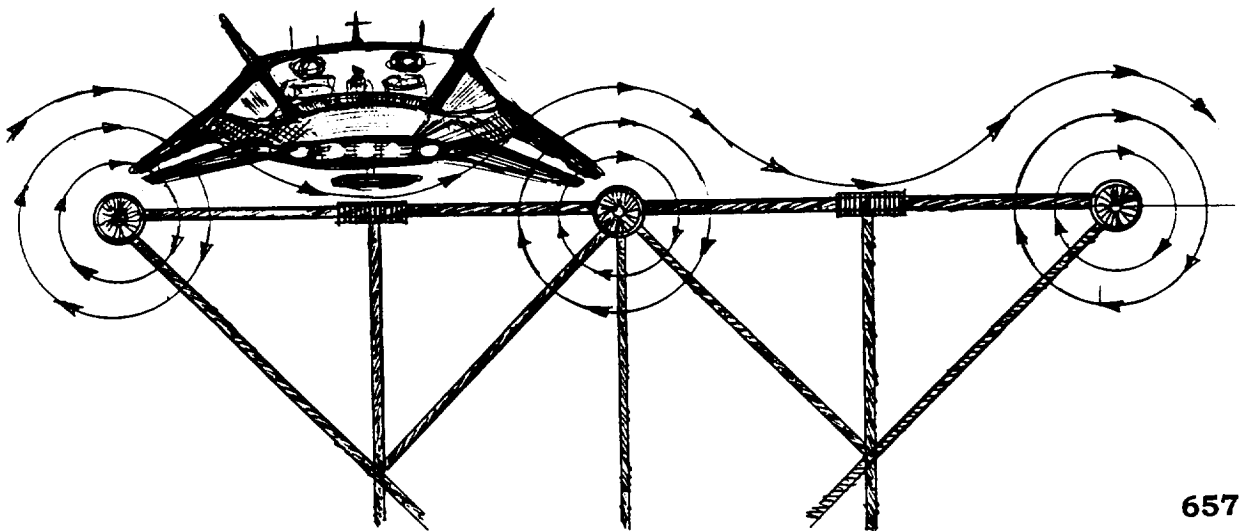

MAGLEV-HYPERCARS

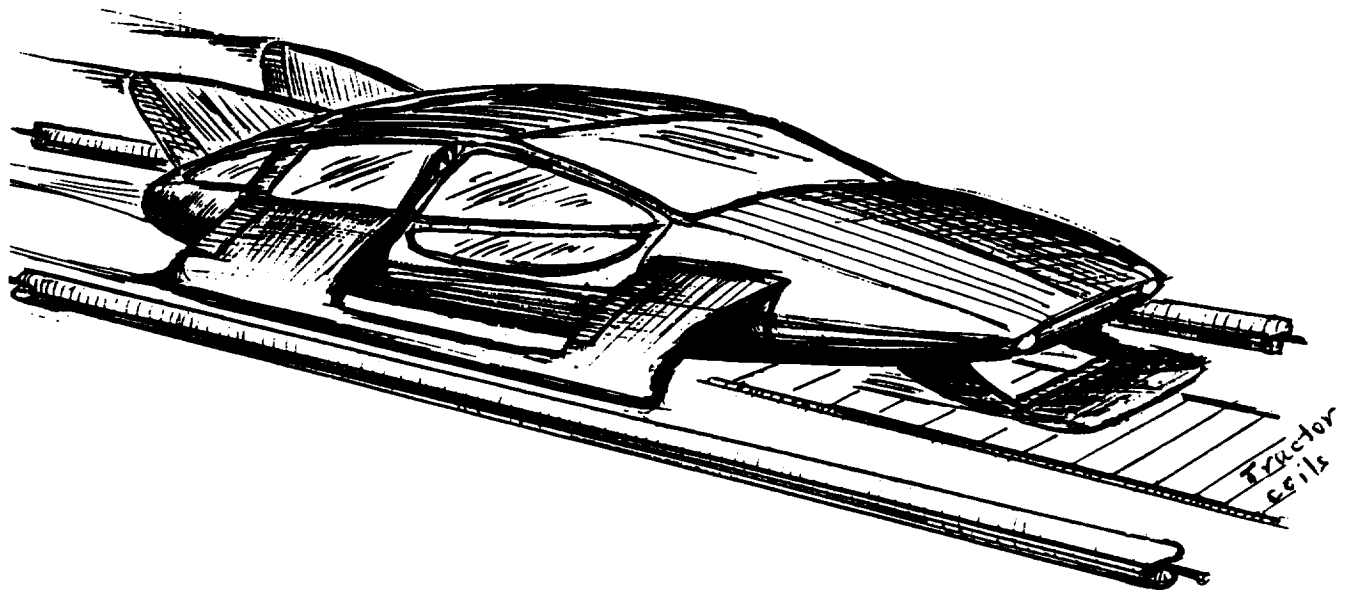

Ridin' The Rails: Beyond 2000

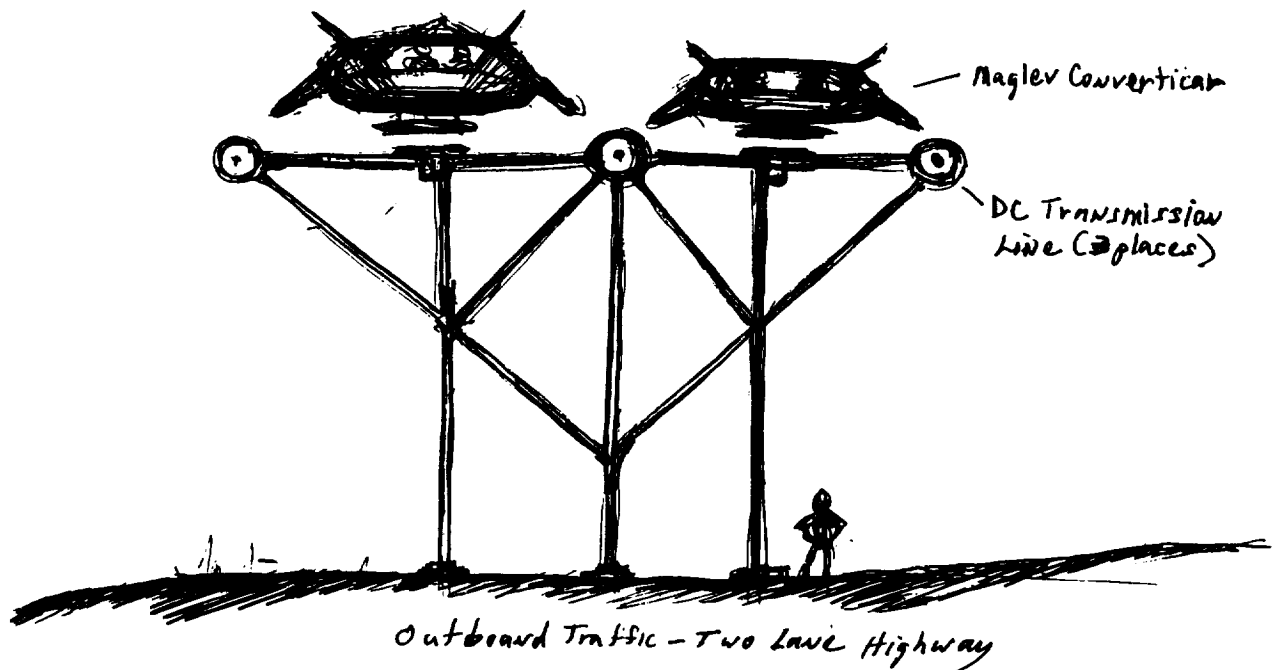

MAGLEV Personal Converter Concept
(shown with wheels retracted and stabilizing fins extended)

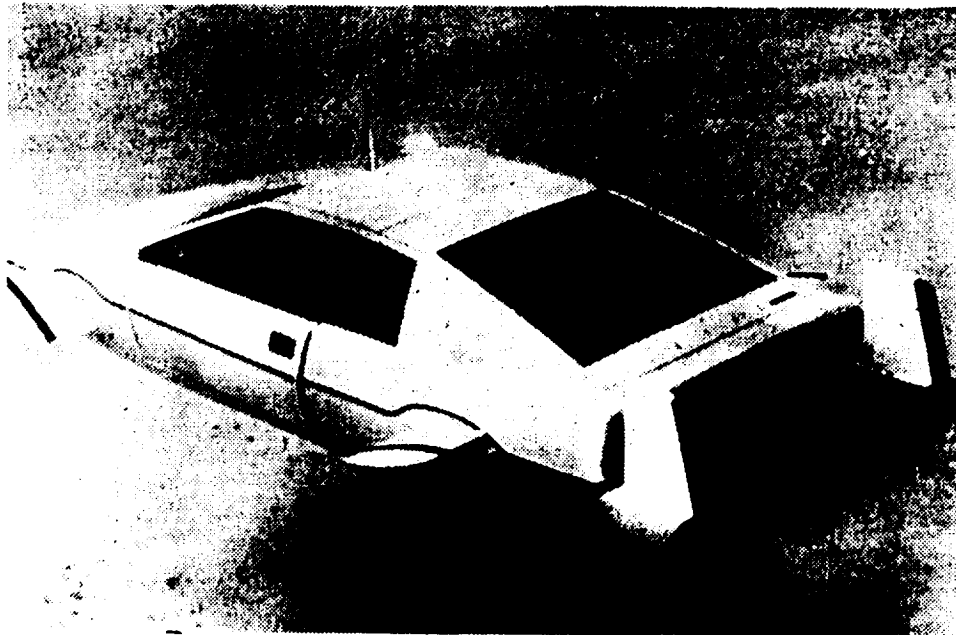
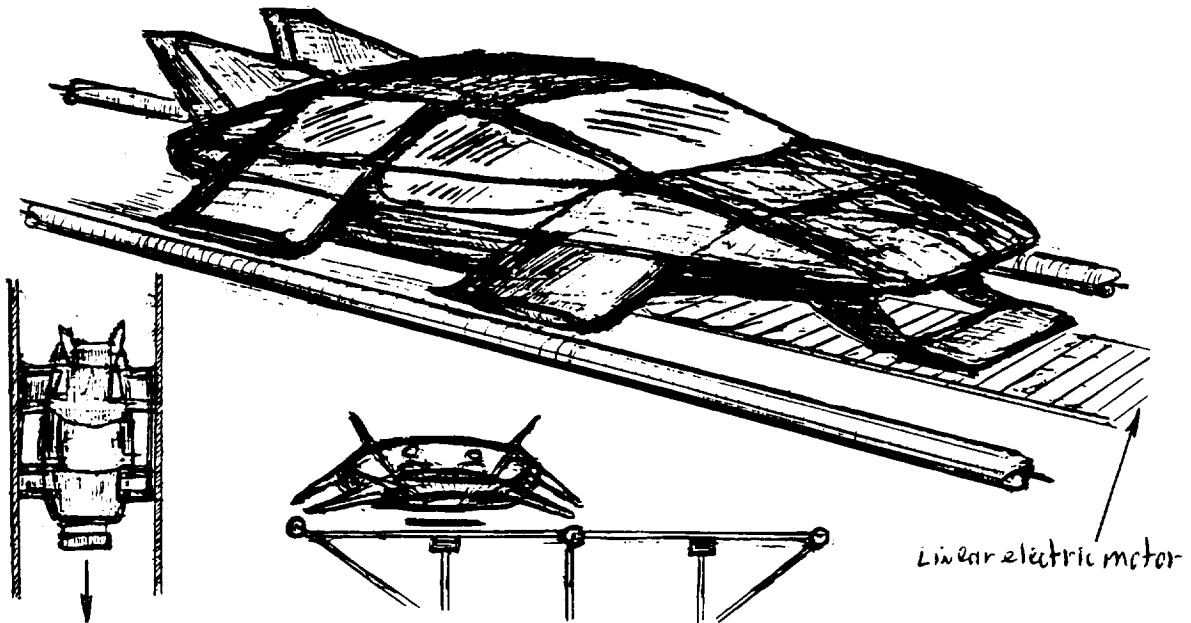

THE SPY WHO LOVED ME

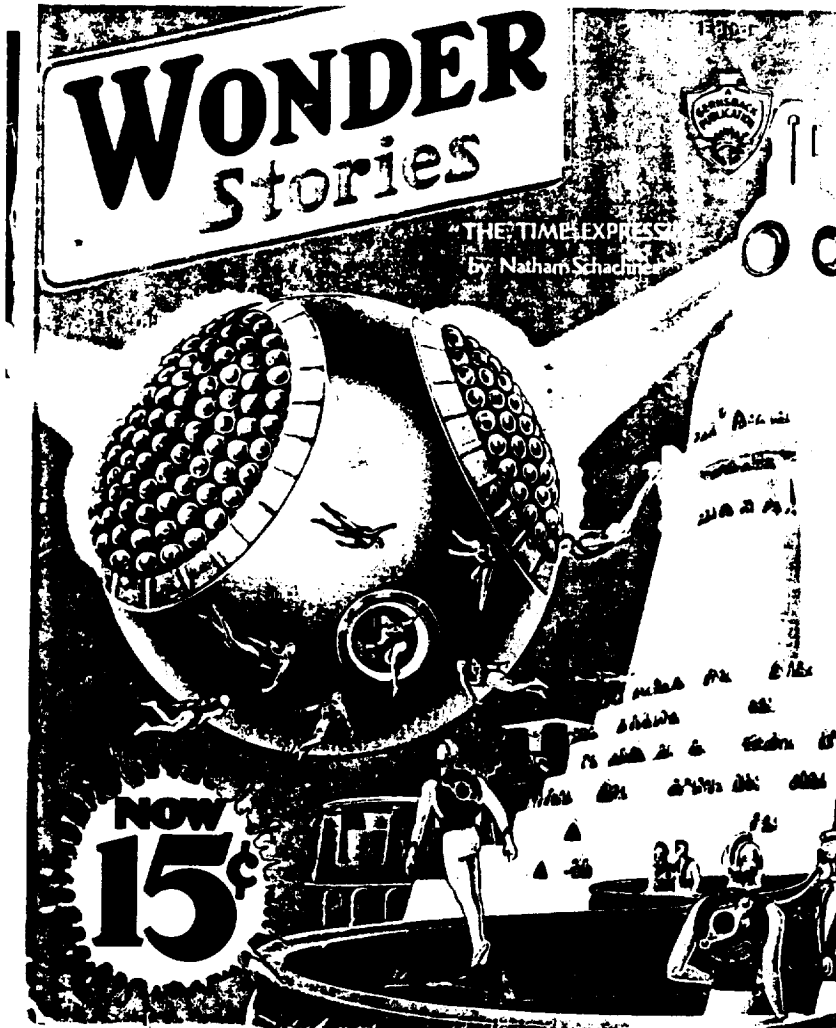
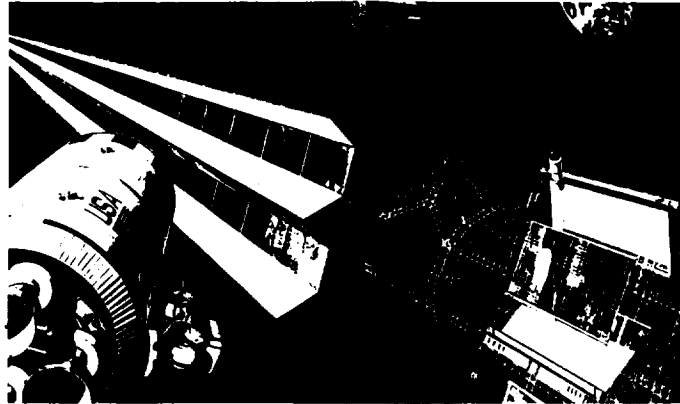

MultiPurpose SSP in LEO With SMES Functions

● Solar Charge Option

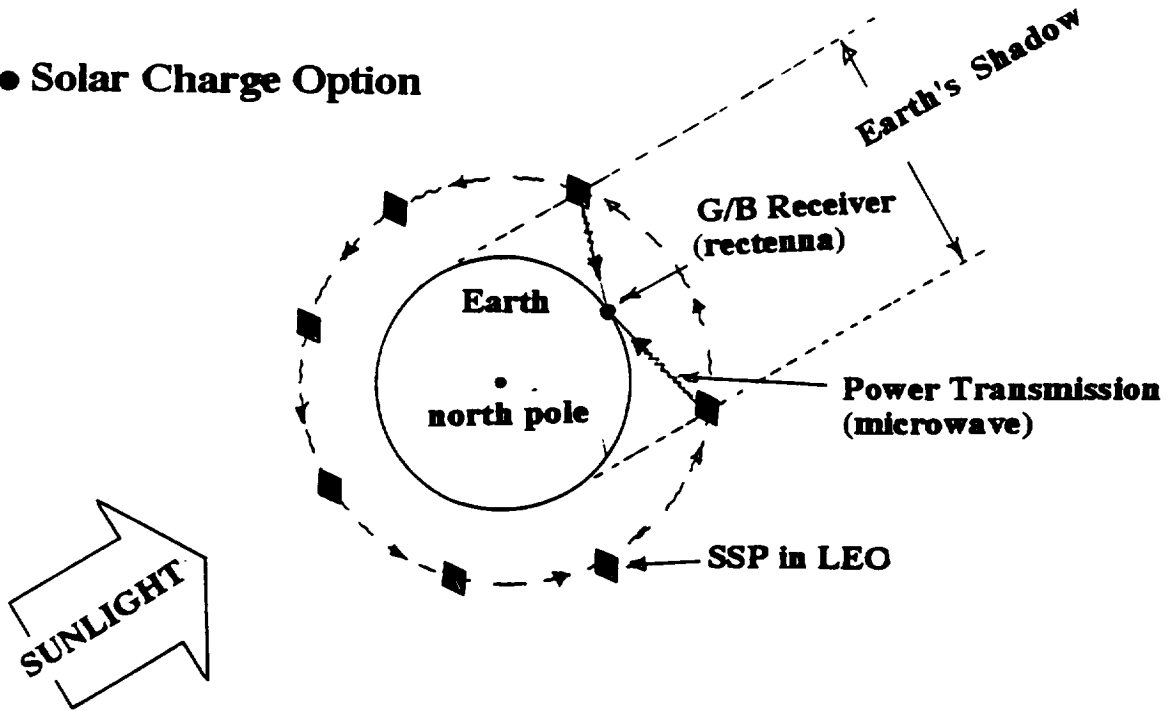

● Power Relay Option (from G/B grid)

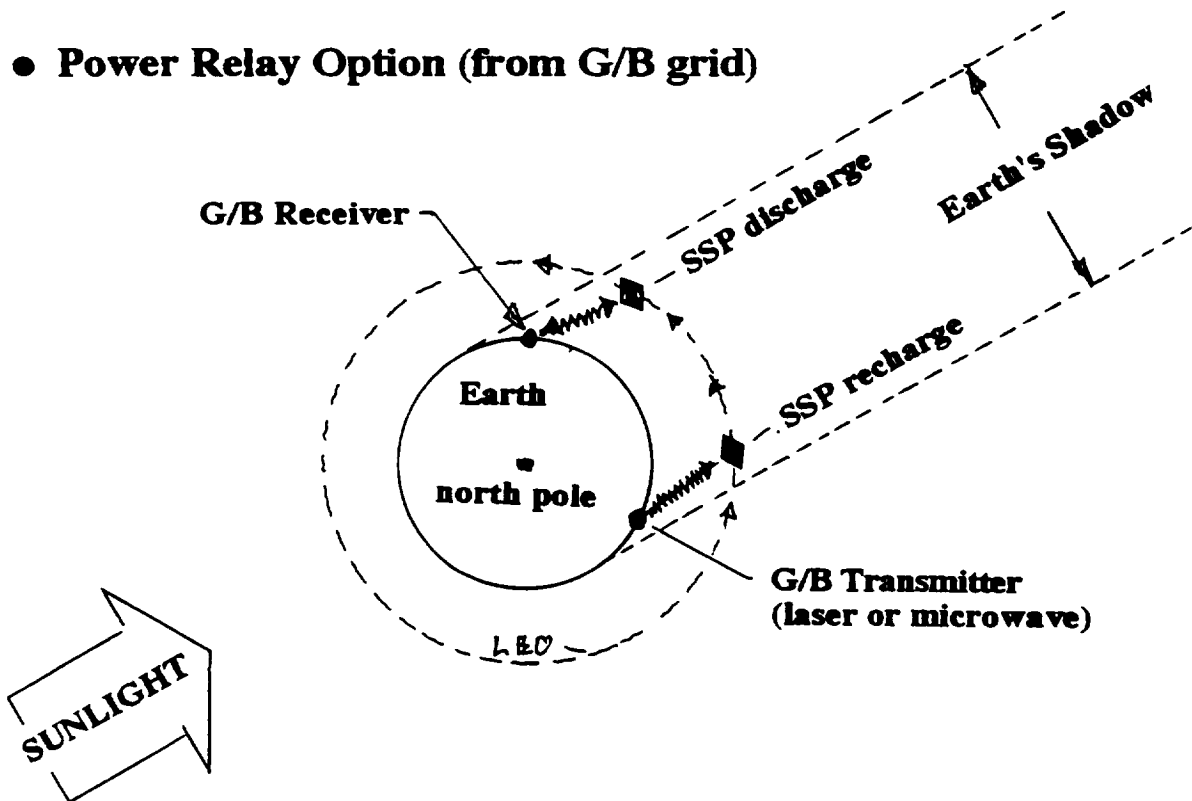

Modularized Inflatable

[Kato et. al. 1989]

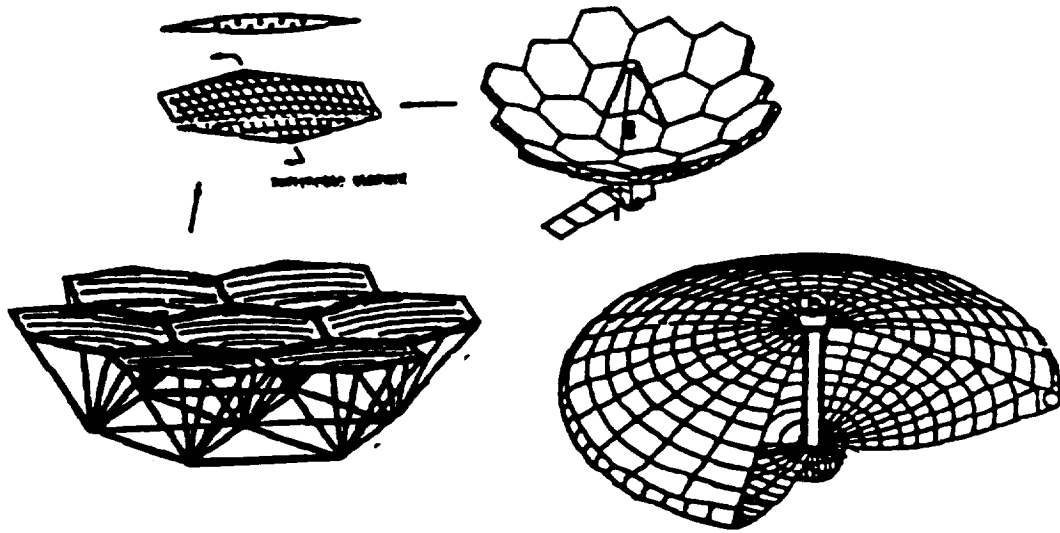

MODULAR INFLATABLE SPACE STATION CONCEPT

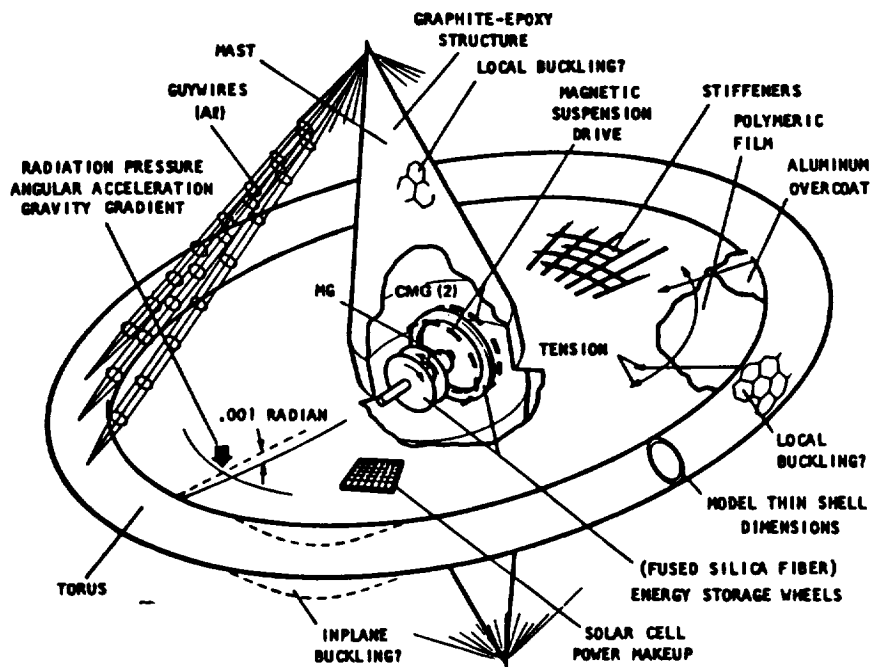

(NASA Photo)

Inflatable Gossamer SSP with SMES (functional development)

- Structurally Unsound

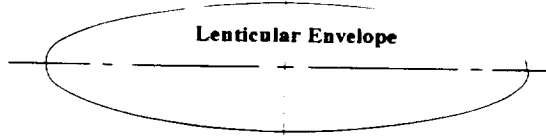

- Stable (using toroid for pneumatic inflation)

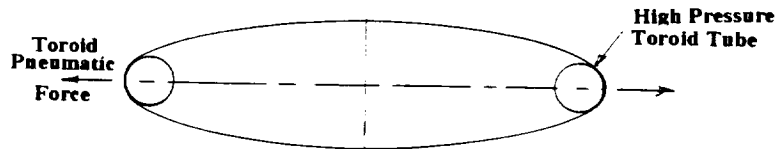

- Stable (using SMES for magnetic inflation)

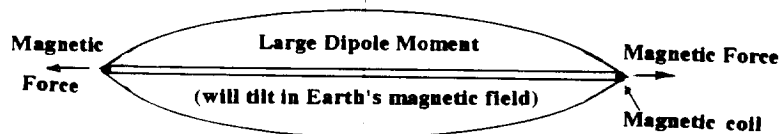

- Spin-Stabilized with Dual-Coil SMES

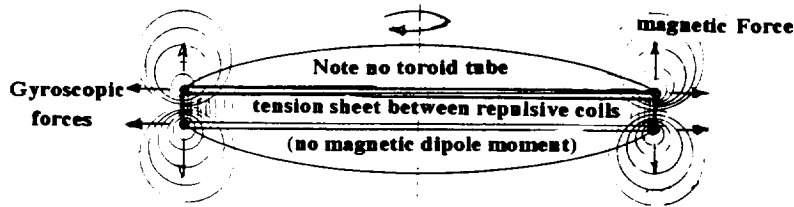

- Toroid with Dual Coil SMES

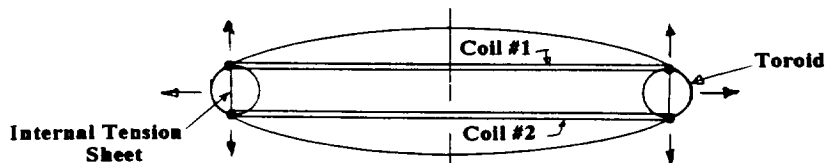

- Add Solar Cells and Solid State Phased Array Transmitter

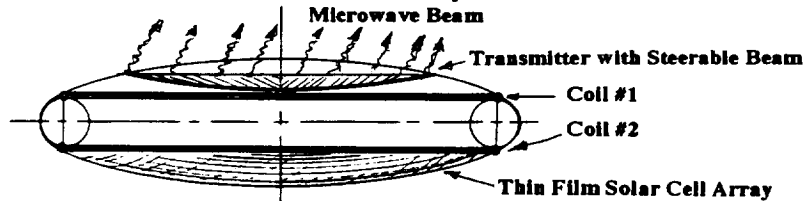

- Add Forced Convection Cooling for High Power Operation

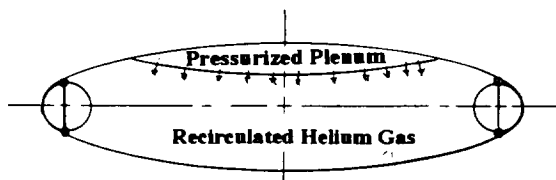

Flotilla SPS Construction Concept

- **Mass Produced Modules Built on Earth surface**
 - Covered with thin film solar cells
 - Integral transceiver rectennas
 - On-board superconducting energy storage
- **Direct Microwave Boost to LEO or GEO**
- **Robotic Link-up with other Flotilla Modules**
- **Each Module Becomes Phase Locked With All Others**
- **Potential Module Platform Geometries :**

- Hexagonal



- Triangular



- Circular

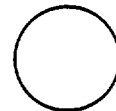

- Square



GUIDING IMAGERY -- VISION DESCRIPTIONS

For HMM - Leaps of the Imagination*

- "Highways of Light"; "Energy-Beam Highway to Space"
- Space Links in a Beamed-Energy Infrastructure
- Invisible Airport, with Airborne Hubs - (Runways don't exist)
- Non-Intrusive Aerospacecraft - (Environmentally Stealthy)
 - Noise at, or below, background levels
 - Zero NOX, Soot, CO, HC's
 - Actually enhances the environment

* After John L. Anderson

Source Siting Options (for space power system infrastructure)

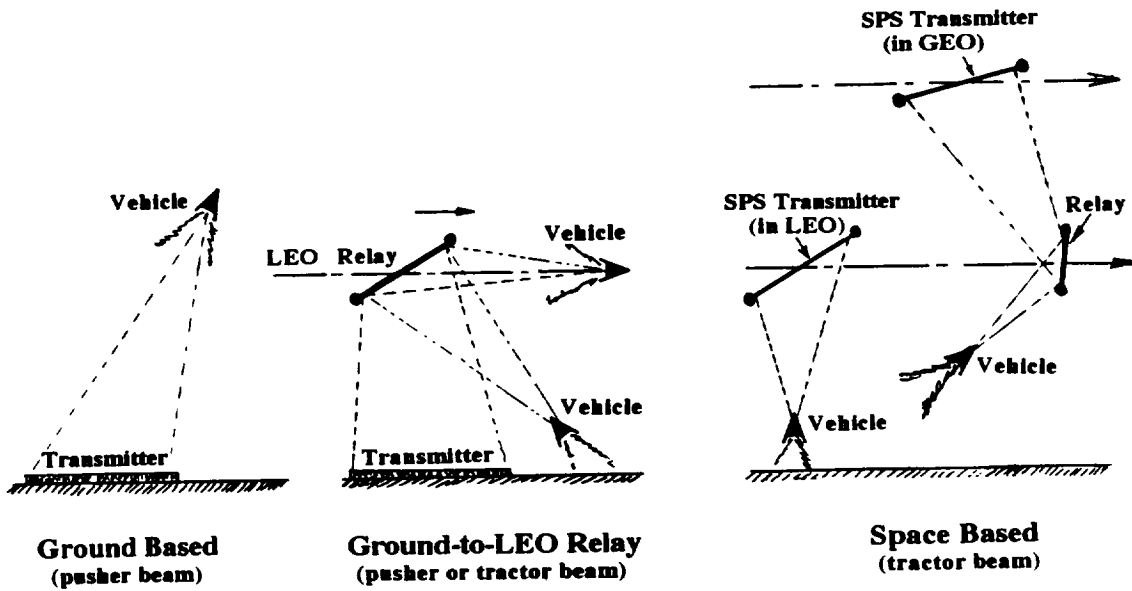

Microwave Relay Options for Lightcraft Powering

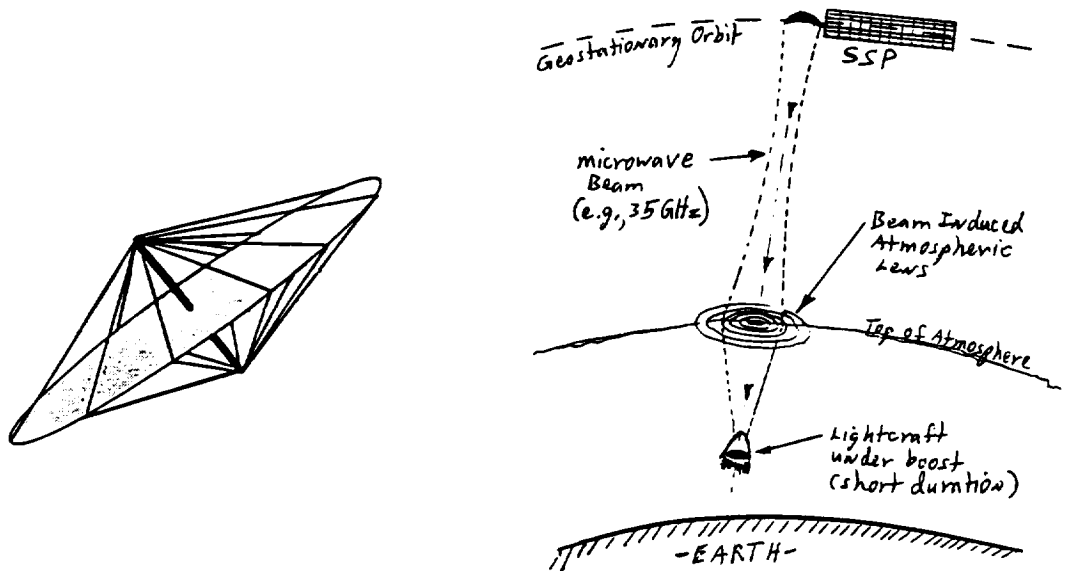

- **Ultralight LEO Reflector Option**
"Bicycle-Wheel" Concept
(could also be transmissive)
Fresnel lens - thin film

- **Atmospheric Transmissive Lens Option**
(created by microwave beam heating)

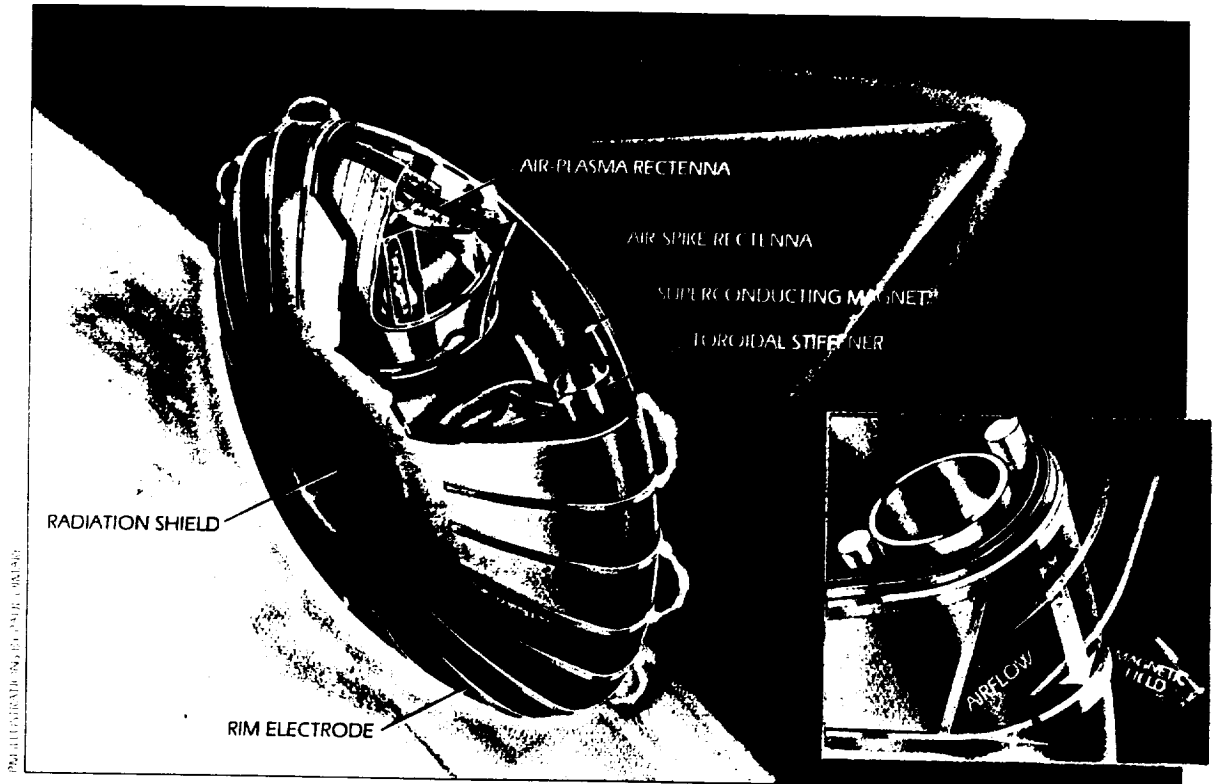

Framework for Very Advanced HRST Formulation

- **Off-Board, Beamed-Energy Source (Microwave or Laser)**
- **Substitution of Off-Board Energy for HRST Mass**
- **Substitution of On-Board Intelligence for HRST Mass**
- **Use of "Motors" instead of "Engines"**
- **Hypersonic MHD Airbreathing Propulsion to Orbit**
- **Flight Vehicles with "Zero" Propellant**
- **Hyper-Energetic HRST Performance**
- **Ultra-strength, High Temperature Ceramic Structures**

"AIR SPIKE" PROOF-OF-CONCEPT EXPERIMENT: A SUCCESS!

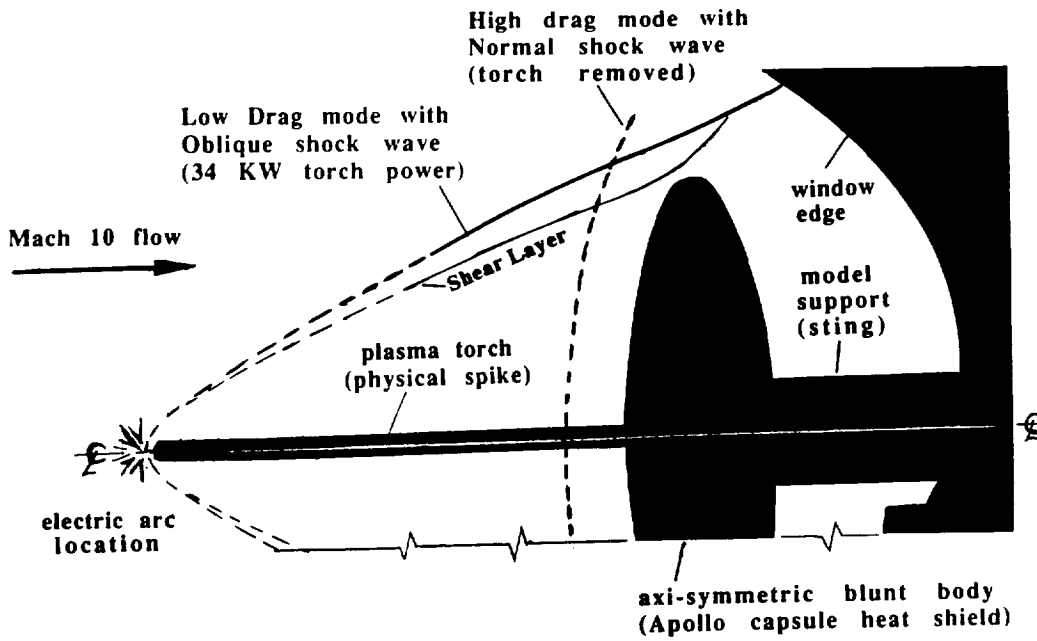

*Confirmed 4/24/95 @ 10:30 PM



Microwave Powered 'Lightcraft'

To reach speeds up to Mach 3, antennas focus microwaves at points just outside the craft's rim, heating the air and turning it into an ionized gas known as plasma. Magnetic fields act as nozzles, compressing and aiming the plasma to generate thrust (bottom).

For space launches (near left), the craft acts like an electric motor. An internal antenna focuses microwaves ahead of the craft, creating an air 'spike.' The spike acts as a nose cone, greatly reducing drag. It also sets up a shock wave, forcing compressed air past high-voltage electrodes along the rim. When ionized, air acts as a conductor for current to flow between the electrodes. Interaction of flowing current and magnetic fields along the rim speeds air downward, boosting the craft.

MICROWAVE-GENERATING SATELLITE



MICROWAVE POWER BEAM

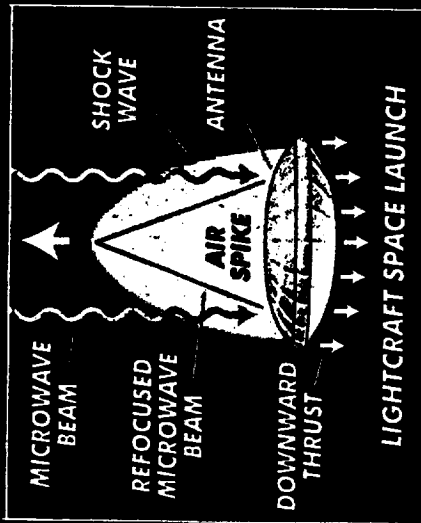

LIGHTCRAFT IN LATERAL FLIGHT

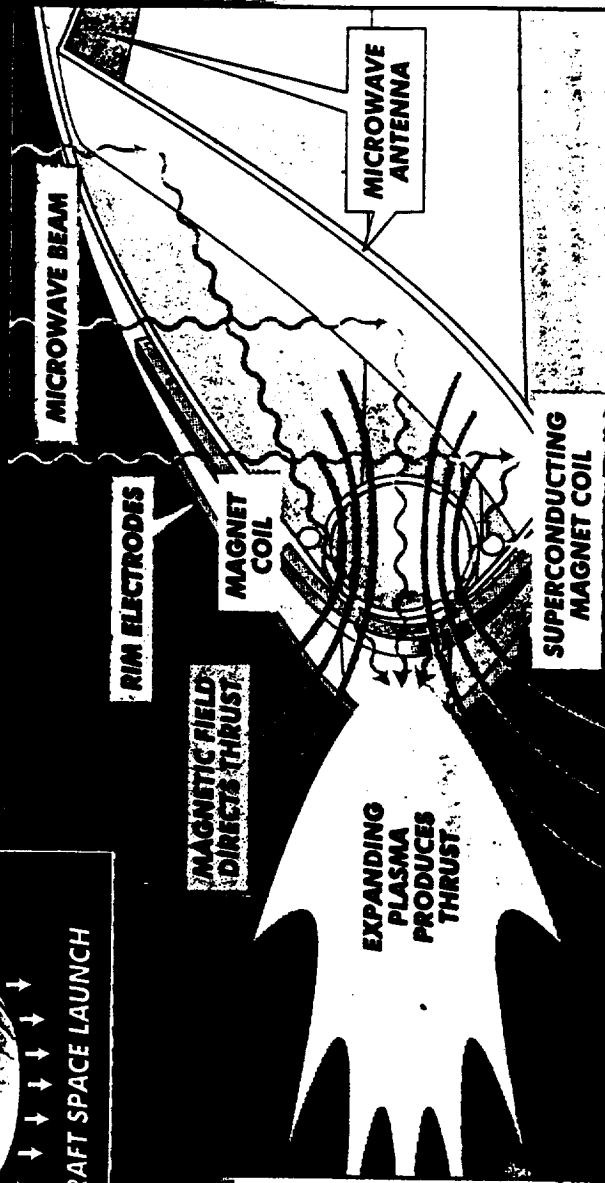

Source: Left: NASA; Right: Science Fiction

Microwave 'Beam Rider' Propulsion System Elements

- "Air Spike" inlet ● MHD-Fanjet ● Rectifying Antenna

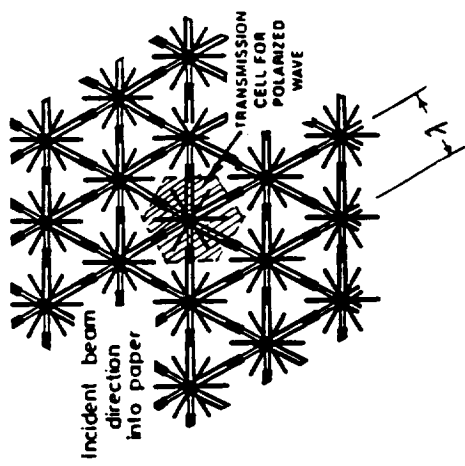
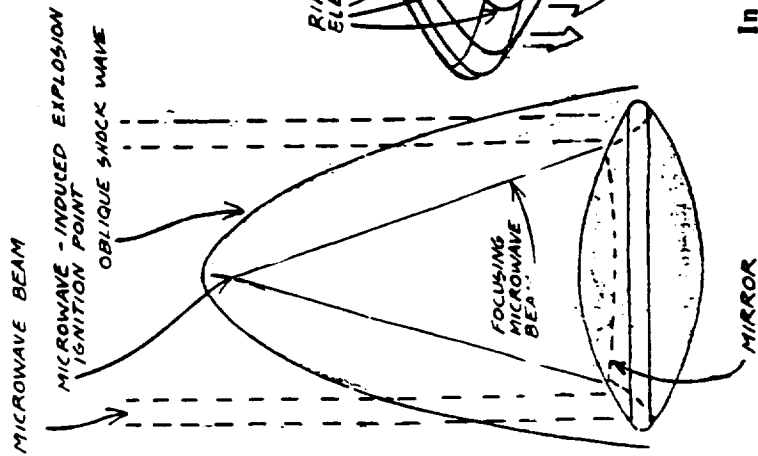

Microwave beam energy is converted to electricity by large rectifying antenna (85% efficient) for MHD Fanjet.

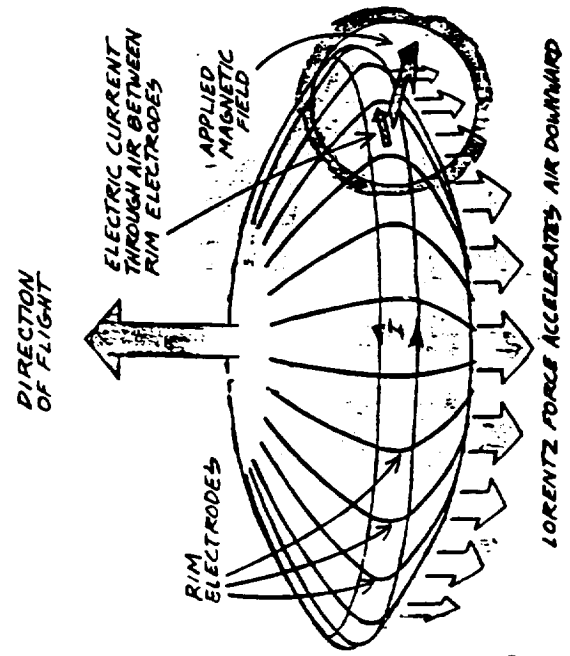

In hypersonic flight, externally - powered Lightcraft uses magnetohydrodynamic effect to accelerate air past its hull.

Focused microwaves shape bow shock wave ahead of ship to act as an inlet spike for the MHD Fanjet.

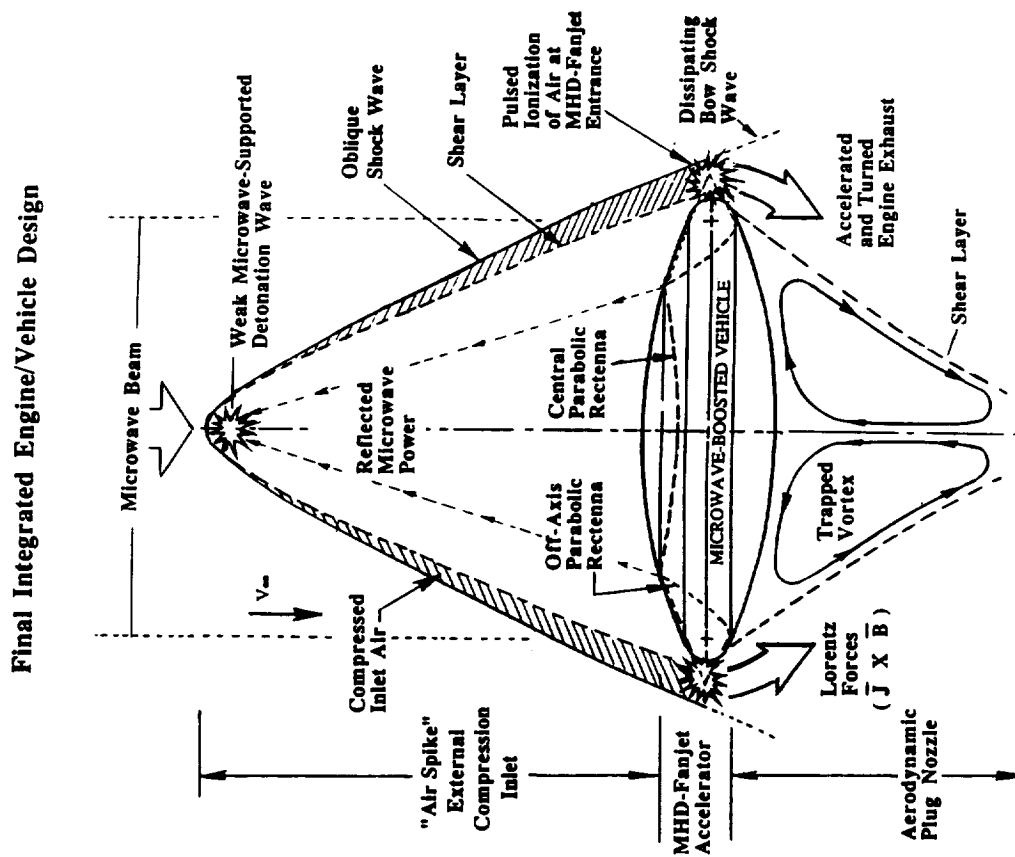

**HUMAN FACTORS CONSIDERATIONS
FOR "PASSENGER MOONSHIPS"**

- Radiation shielding (200 MeV Solar Proton Storms)
- Pressurized, Closed-Cycle Life Support Systems
- Artificial Lunar Gravity (1/5-1/6th G, Rotate at 3 RPM)
- Comfortable Physical & Psychological Spaces (e.g. 10 to 40 cubic meters per person)
- Companionship: 3 to 5 passengers per vehicle
- High Quality Audio/Visual Communications (Virtual Reality)
- Ultra-G Protection (Launch Vehicles are Hyper-Energetic)
- Individual Escape Pod & Mini Re-Entry Lifeboats (Multiple Independent Re-entry Vehicles-MIRV)

CIVILIAN "SPACE SUIT" FOR LUNAR MICROWAVE LIGHTCRAFT

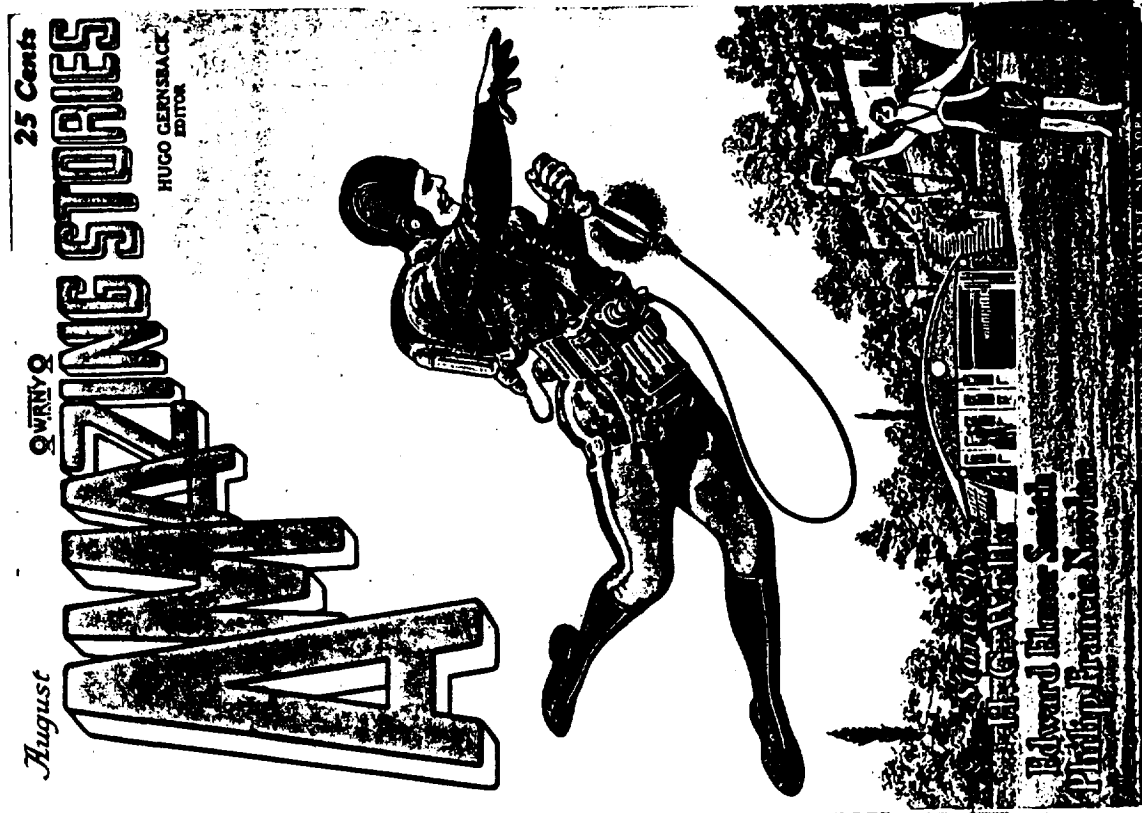
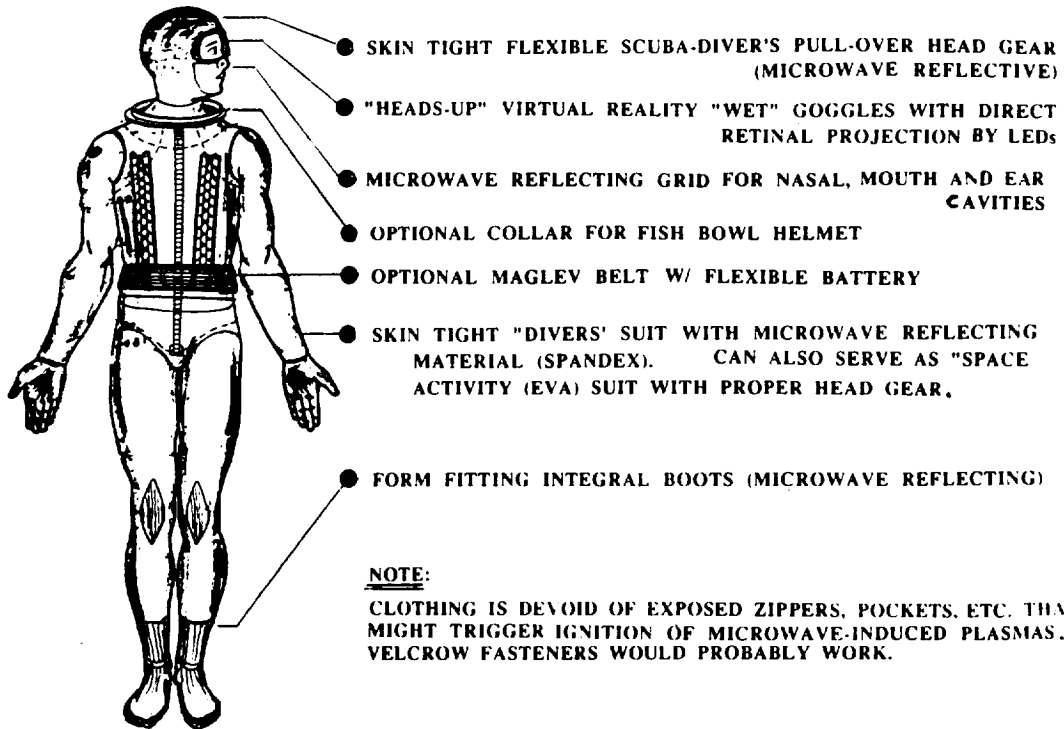

"MAGLEV BELT" CREW TRANSFER CALCULATION

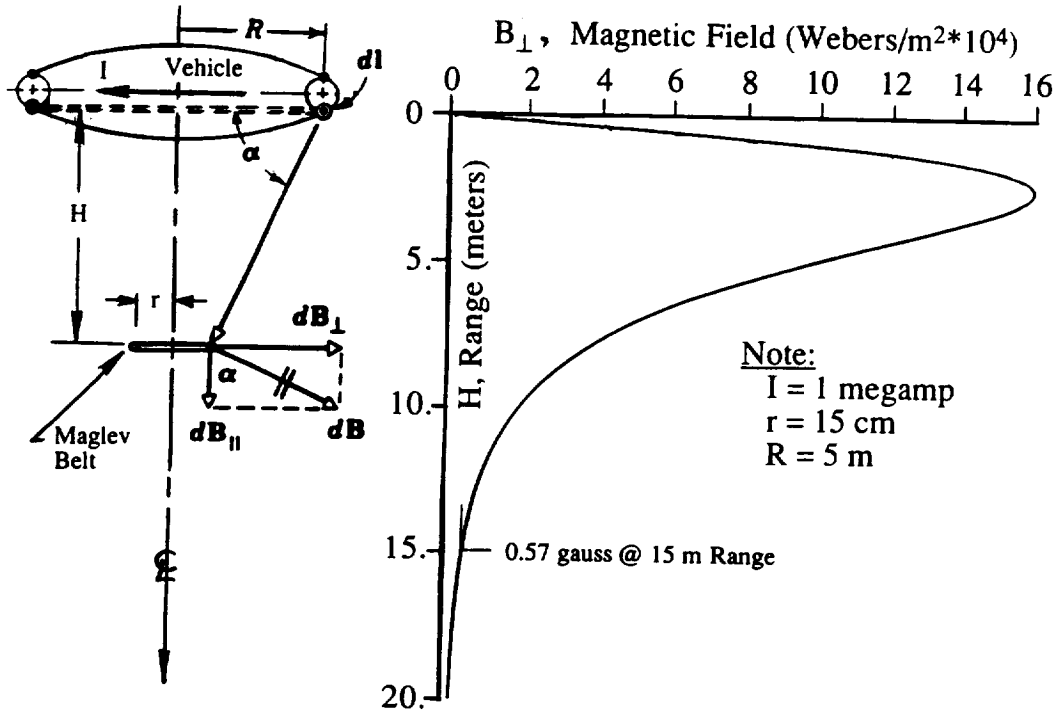

"MAGLEV BELT" CREW TRANSFER CALCULATIONS

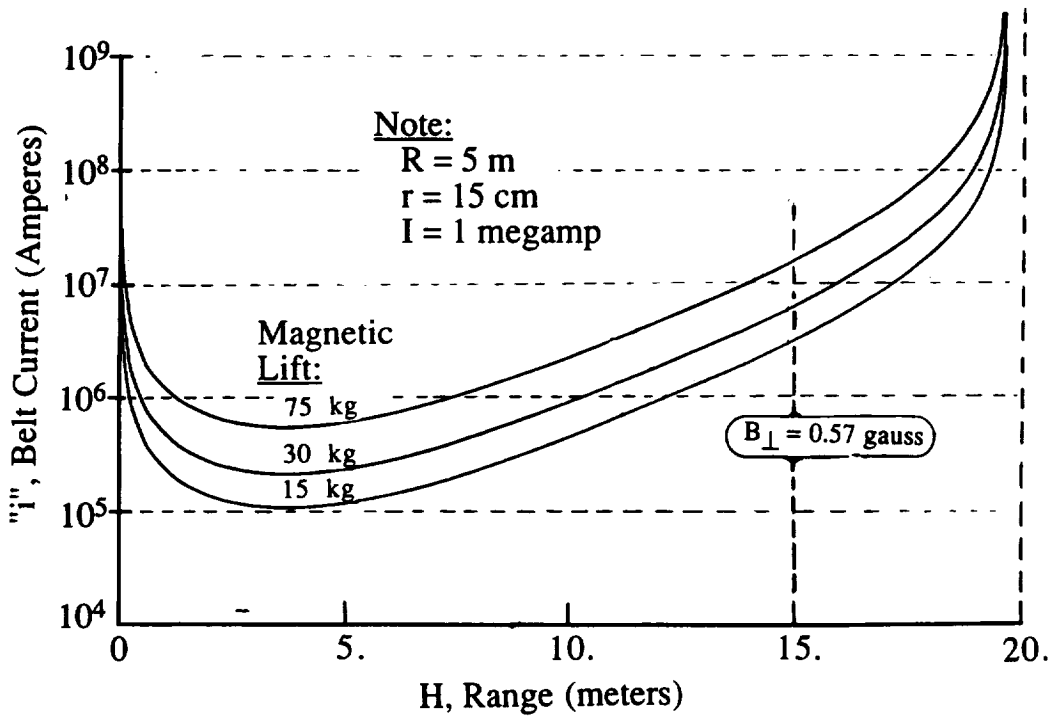

BUGS ROGERS



ALTERNATIVE MAGLEV CREW TRANSFER MODE

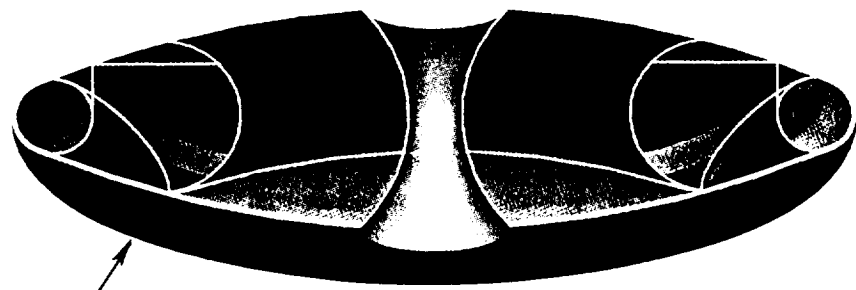

Buoyant Lightcraft in hover mode with perimeter magnets energized (shown inverted for deployment)



Maglev crew transfer pod is NASA Tension Aeroshell (e.g., see NASA TN-D-2994)

Ground

Factors That Will Lead To A Revolution **(in the way we will travel in the 21st Century)**

- **Inflatable, Gossamer Space Structures**
- **Satellite Solar Power Station Grid**
- **Microwave and Laser Power Transmission**
- **High Temperature Superconductors & SMES**
- **Open MAGLEV Interstate Highway System**
- **Beam Propelled Flight Transportation**
(with environmentally friendly propulsion systems)
- **Ultra-G Protection Systems - Human Factors**
(with liquid ventilation & liquid immersion)