

11/15/95
11/15/95

Highly Nonplanar Lifting Systems

**Ilan Kroo, Stanford University
John McMasters, Boeing Commercial Airplane Group
and Stephen C. Smith, NASA Ames Research Center**

**Transportation Beyond 2000:
Technologies Needed for Engineering Design**

September 26-28, 1995

Outline

This paper deals with nonplanar wing concepts — their advantages and possible application in a variety of aircraft designs. A brief review and assessment of several concepts from winglets to ring wings is followed by a more detailed look at two recent ideas: exploiting nonplanar wakes to reduce induced drag, and applying a "C-Wing" design to a large commercial transport. Results suggest that potential efficiency gains may be significant, while several non-aerodynamic characteristics are particularly interesting.

Outline

I. Introduction and Background

II. Some Results: What Is Possible?

III. A Closer Look At Two Concepts

1. Exploiting Nonplanar Wakes
2. A Very Nonplanar Wing: The C-Wing Concept

IV. Conclusions and Postscript

Introduction

Nonplanar wings include configurations such as biplanes, box-planes, ring-wings, joined wings, and wings with winglets. Apart from configuration differences related to stability and trim, variations in nonplanar geometry represent one of the few major differences in aircraft conceptual design.

Such designs may be of interest because of their potential for lower vortex drag at a fixed span, a key constraint for many aircraft, including very large commercial transport concepts. However, several non-aerodynamic features are of interest as well including effects on stability and control, characteristics of wake vortices, and structural implications of the nonplanar design.

This paper reviews some of the concepts that have been pursued and discusses some of their possible advantages or disadvantages. We consider the potential of some of the concepts to improve performance incrementally or to change the configuration significantly.

Nonplanar wing concepts may be divided into a few categories based on their primary geometric or aerodynamic characteristics. These include:

- Multiplanes (e.g. biplanes, triplanes)
- Closed Systems (box planes, ring wings)
- Strut-Braced Systems (Lifting struts, joined wings)
- Nonplanar monoplanes (wings with winglets and other tip devices)
- Planar wings with nonplanar wakes (Crescent wings, Split-tips)

Examples: Multiplanes

Multiplanes include biplanes such as the Wright 1902 glider shown below. Although the Wright brothers exploited the structural advantages of biplanes, rather than the lower vortex drag for fixed span and lift, their motivation was partly aerodynamic. Based on their own tests and those of Otto Lilienthal, it was apparent that at very low Reynolds numbers (typical of test conditions used by these pioneers) highly cambered, thin sections performed much better than thicker sections, making the cable-braced Lilienthal designs or the Wright biplane concepts especially attractive. Because of the low flight speeds required for Lilienthal's take-offs and landings and for the power plants available to the Wrights, the designs needed to be light and incorporate large wing areas. This requirement was satisfied well with the biplane configuration.

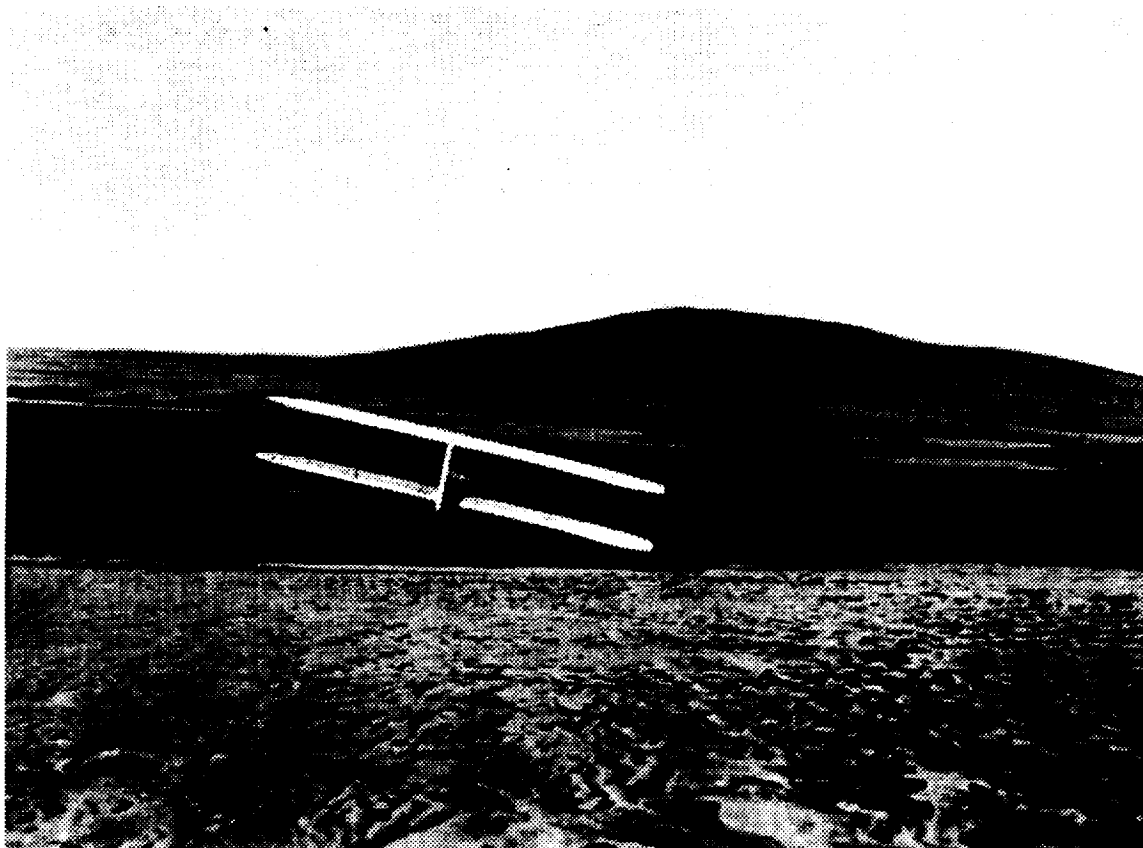

Examples: Multiplanes

The multiplane concept was taken to extremes by Phillips in 1904. The aircraft shown below with 20 wings would have had a high span efficiency, but the very low Reynolds number of each wing would lead to poor performance. The struts and cables of early bi-plane designs also led to large parasite drag, so the effects of improved span efficiency were not obvious. Several modern proposals for cantilevered or semi-cantilevered bi-planes have emphasized the lower vortex drag of such configurations at the expense of structural efficiency, Reynolds number, and fuel volume.

The induced drag of a multiplane may be lower than that of a monoplane of equal span and total lift because the nonplanar system can influence a larger mass of air, imparting to this air mass a lower average velocity change, and therefore less energy and drag. For a biplane, if the two wings are separated vertically by a very large distance, each wing carries half of the total lift, so the induced drag of each wing is $1/4$ that of the single wing. The inviscid drag of the system is then half that of the monoplane.

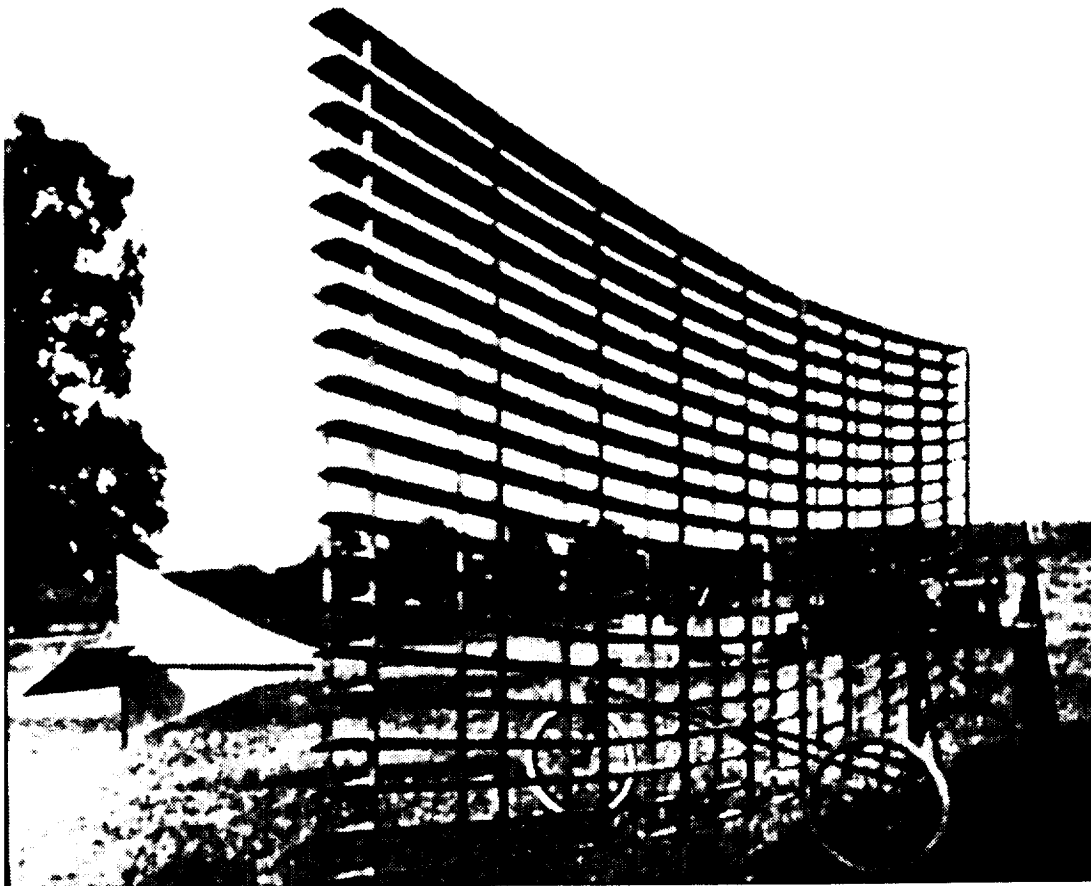

Examples: Multiplanes

In addition to the well-known advantages in vortex drag, the favorable interference between two wings of a closely-coupled biplane can be used to improve the section performance. The lower-than-freestream velocity at the trailing edge of the forward wing and the new boundary layer on the downstream wing can be exploited and some of the difficulties with lower Reynolds numbers for the biplane as compared with a monoplane can be alleviated if not turned to advantage. Gains in $C_{L_{max}}$, width of laminar drag bucket, and drag divergence Mach number at fixed t/c are possible with good multiple element section design. As an example, a single fully-laminar section (100% laminar flow on upper and lower surfaces) can support a C_L of about 0.4. A 2-element wing can be designed with an overall C_L of about 0.75. This may help to explain the preference for biplanes in the low Reynolds number world of insects.

Favorable interference for biplanes:

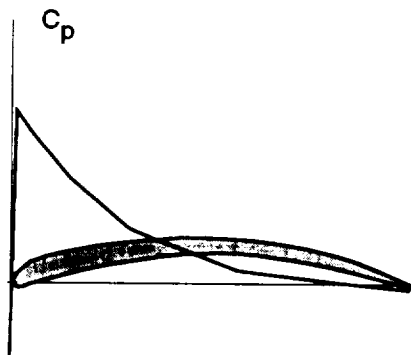

All laminar section: $C_L = 0.4$

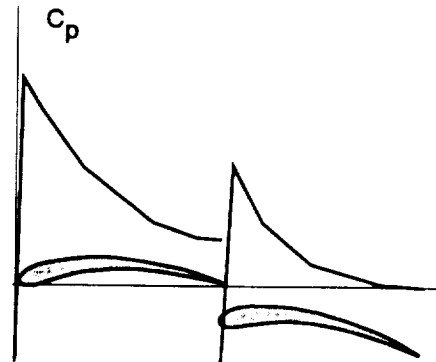

$C_L = 0.75$

Examples: Closed Systems

The aerodynamics of nonplanar wing systems that form closed loops are very interesting. Such configurations include box-planes, ring wings, joined wings, and “spiroid-tip” devices. Wings that form closed loops, such as the ring-wing illustrated below, do not eliminate the “tip vortices” or trailing vortex wakes even though the wing has no tips. Still, the vortex drag of the circular ring wing is just 50% that of a planar wing with the same span and total lift and the concept has been studied at several organizations, including early aviation pioneers, a major aircraft manufacturer, as well as several toy companies.

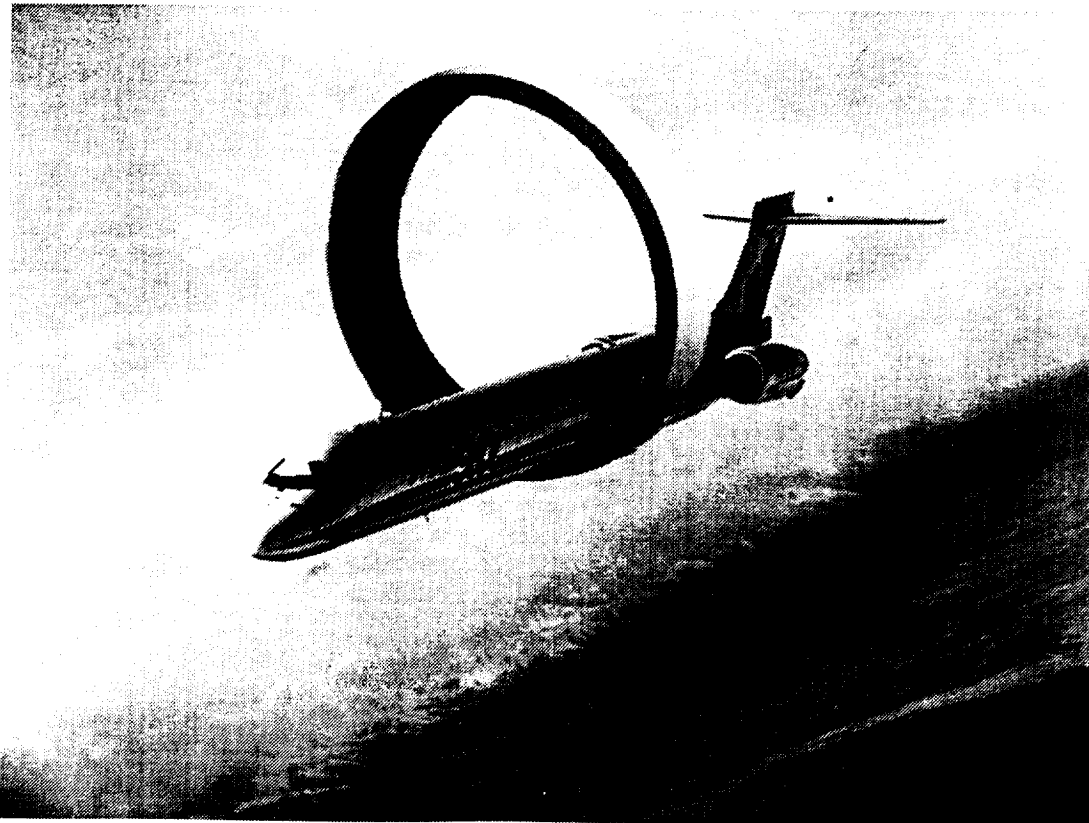

Examples: Closed Systems

The Lockheed box-plane, shown below, achieves even greater drag reduction at a given span and height than the circular ring wing (in fact the theoretical minimum vortex drag) in a configuration with reasonable high-speed performance (note the desirable transonic area-ruling) and some structural advantages. Fuel volume, landing gear integration, $C_{L_{max}}$ penalties, and lower section Reynolds numbers are some of the disadvantages for this concept.

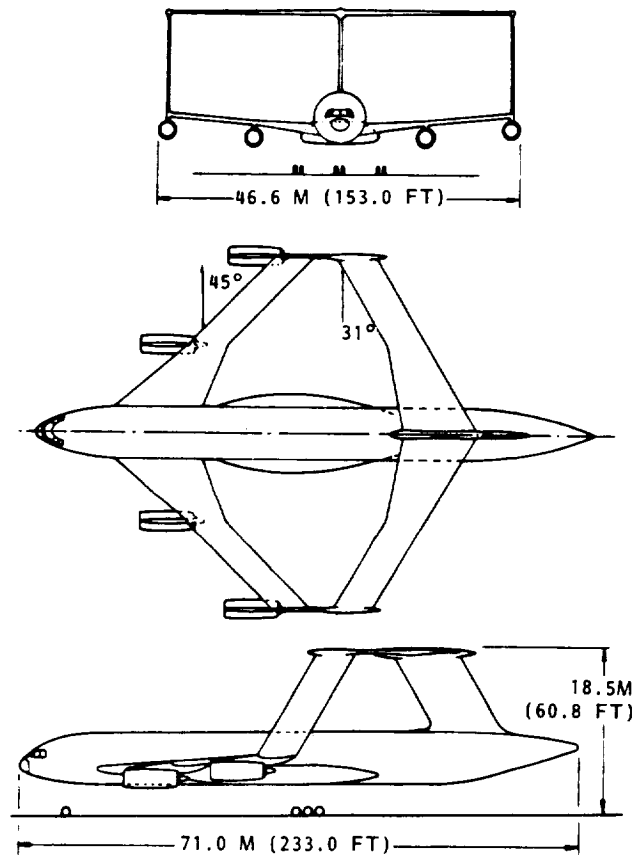

SPEED	0.95
PAYLOAD	84,800 LB
RANGE	5500 NM
OPERATING WT	281,392 LB
GROSS WT	664,896 LB

Examples: Closed Systems

The recently-patented “spiroid wing tip” produces a reduction in induced drag, much like that of a winglet. However, its closed planform shape may make it possible to reduce local lift coefficients—often a problem for winglets.



Closed Systems: How they Work

Although a closed lifting system may eliminate the wing tips, it does not eliminate the trailing vortex wake. In fact, the lift produced by the system can be directly related to the velocities in the wake that lead to induced drag. These systems are still interesting because one may add a constant circulation vortex ring to the system without changing the wake. Such a constant strength vortex distribution does not add any lift, but it may be used to produce moments without induced drag penalties or to manipulate section lift coefficients in a desirable way.

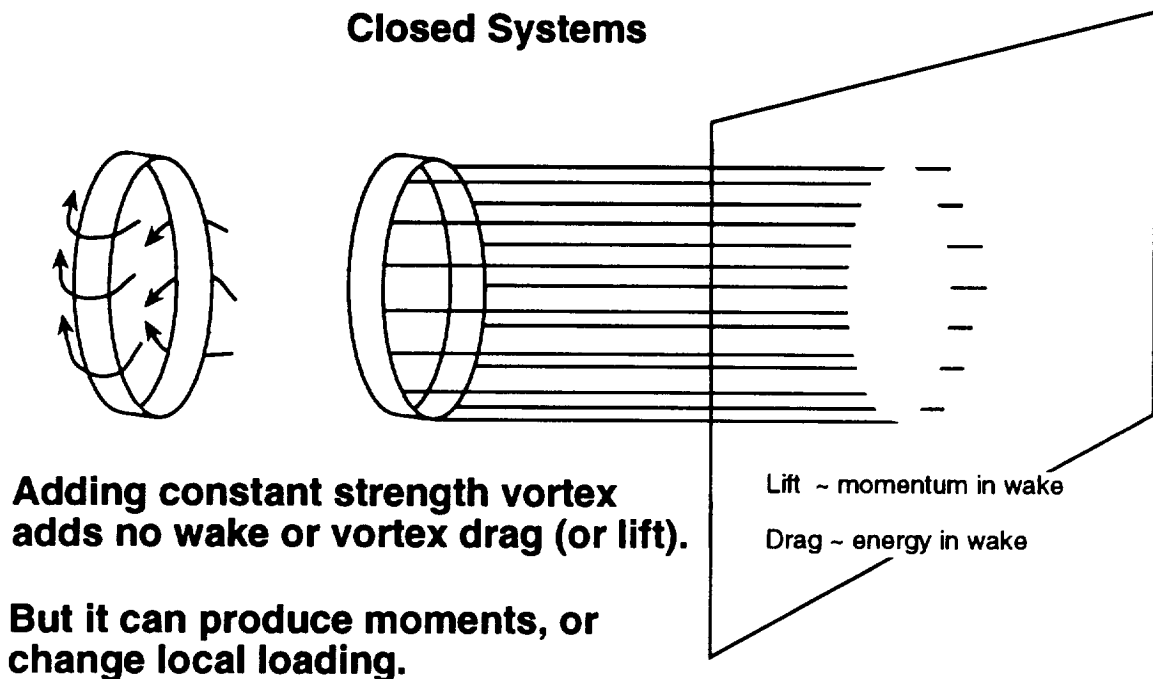

Examples: Strutted-Wings

Aircraft concepts that employ auxiliary aerodynamic surfaces as struts to improve both aerodynamic and structural efficiency have been studied extensively.

- In joined-wing designs (below) the horizontal tail sweeps forward and joins the main wing, forming a strut. The tail is then in compression, reducing wing bending moments. If the tail is large enough to be positively loaded, some induced drag savings is achieved, while if it is carrying a down-load, the closed loop feature of the system minimizes trim drag. The concept was studied by Boeing as a radar platform and by others as a commercial transport.
- Pfenninger's laminar designs with lifting struts exploit the nonplanar strut geometry primarily for structural weight and stiffness, although some induced drag reduction may be achieved.

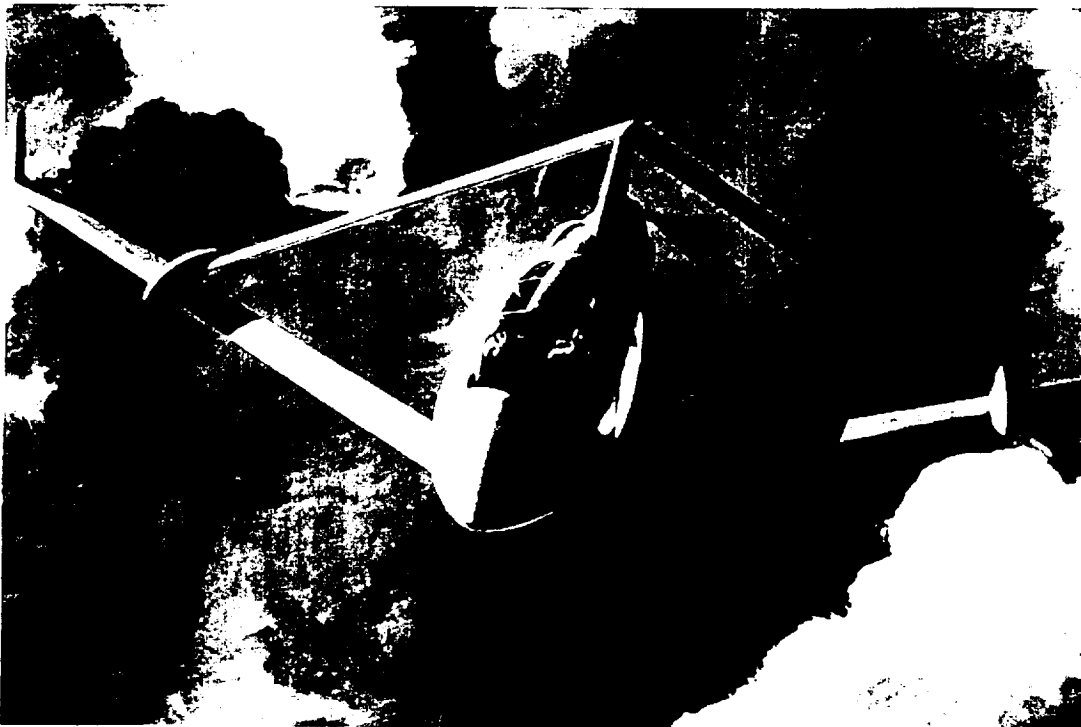

4-PLACE GENERAL AVIATION AIRPLANE

Examples: Winglets

The most common contemporary nonplanar wing configuration is the wing with winglets, as seen below on the McDonnell-Douglas MD-11. These surfaces do reduce induced drag for a given span, as well as providing a means of quickly distinguishing the airplane from a DC-10. The MD-11 design includes small downward winglets, while the 747-400 employs a full-chord single winglet, and many other variations are possible.

A variant of the winglet concept, the C-wing is discussed later in this paper. It involves adding a horizontal winglet extension (a wingletlet?) and has interesting aerodynamic, structural, and control implications.



Examples: Nonplanar Wakes

The induced drag of a nonplanar system can be lower than that of a planar system of the same lift and span. This is true even when the wing surfaces themselves are coplanar, but their vortex wakes are not. Examples of this phenomena include:

- America's Cup sailboat keels. Here the keel and rudder (or twin keel surfaces) are coplanar, but due to the substantial leeway angle and longitudinal displacement of the two surfaces, the wake downstream of the boat resembles that of a biplane system and the induced drag is reduced substantially.
- Crescent wings. This phenomenon was postulated as the reason for the distinctive planform shape of some bird wings and fish fins, although the effect is almost unmeasurable.
- Split-Tips. This design was created to exploit the nonplanar wake geometry and is discussed in more detail in a subsequent section of this paper.

Nature had crescent-shaped wings in mind

How to fly like a fish

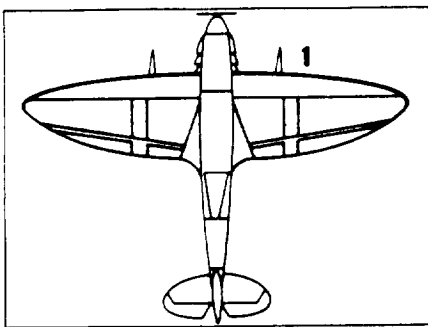

A Spitfire's wing is roughly elliptical ...

■ Engineers have discovered a trick of aerodynamics that birds, fish and whales have known for eons—and as a result, airplane wings, whose basic shape has remained unchanged for half a century, may take on a radical new look.

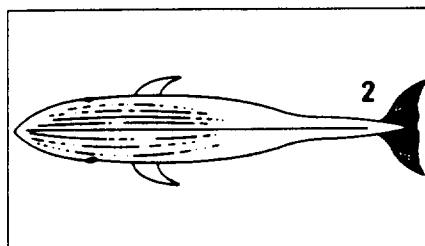

a whale's tail flares back at the tips ...

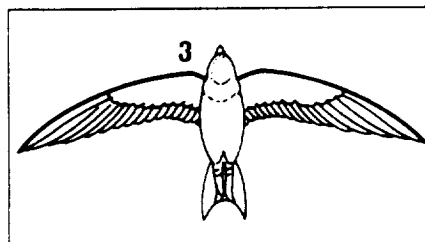

and the swift's wing is crescent-shaped

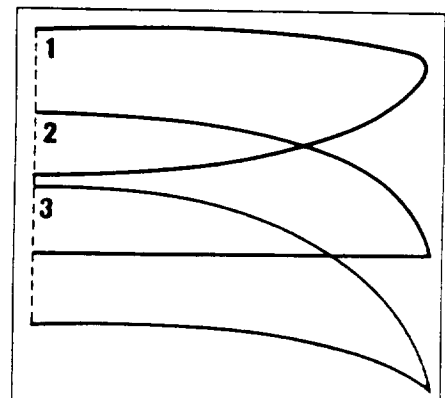

Three designs: (1) Classic elliptical wing; (2) the whale's tail with curved leading edge; (3) the swift's crescent with back-curved leading and trailing edges

What is Possible?

Each of these configurations provides particular advantages and disadvantages, although each benefits from some reduction in induced drag compared with the conventional monoplane. The reduction in vortex drag is shown below for biplanes, boxplanes, and winglets with varying ratios of height to span. These results were computed using an optimizing vortex lattice code, but agree with classical solutions from Prandtl, von Karman and Burgers, Cone, and Jones. Note that the boxplane achieves the lowest drag for a given span and height, although winglets are quite similar. Considerable savings in induced drag are possible for a fixed span if large vertical extents are permitted.

What is Possible?

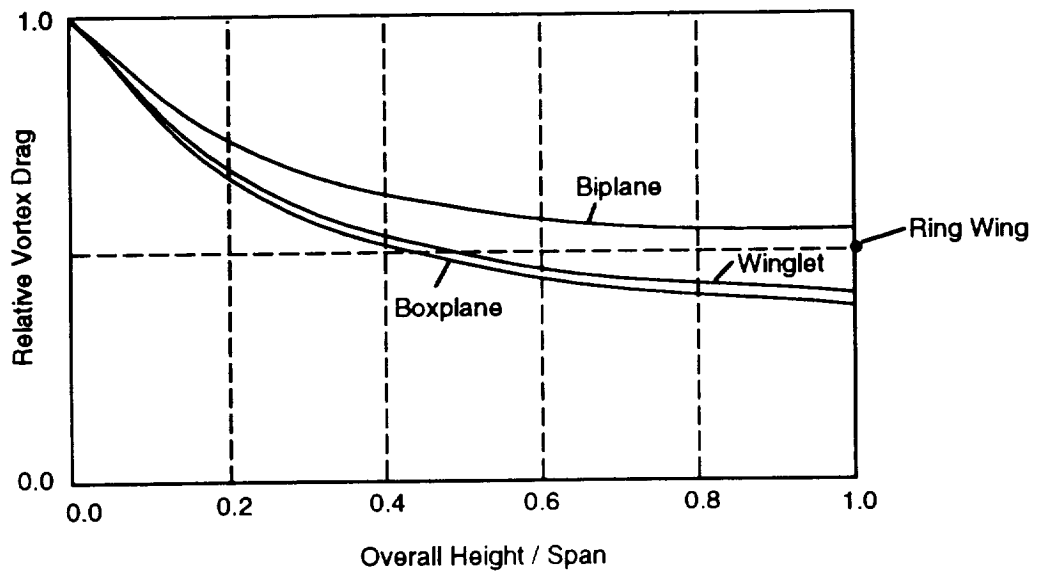

What is Possible?

Of course, adding vertical surfaces such as winglets add wetted area and weight due to higher bending moments, while the weight of a cantilevered biplane is increased since for a fixed total area, the chords (and dimensional thickness) of each wing are halved. Jones showed that with fixed integrated bending moment (a rough indicator of wing weight) winglets produced about as much drag savings as planar tip extensions. More recent analyses using more realistic weight estimation methods have yielded similar results (but with much a less broad optimum).

For some applications, this discouraging result is not relevant since the aircraft must operate with a span constraint, or because the structural arrangement is not simply analyzed.

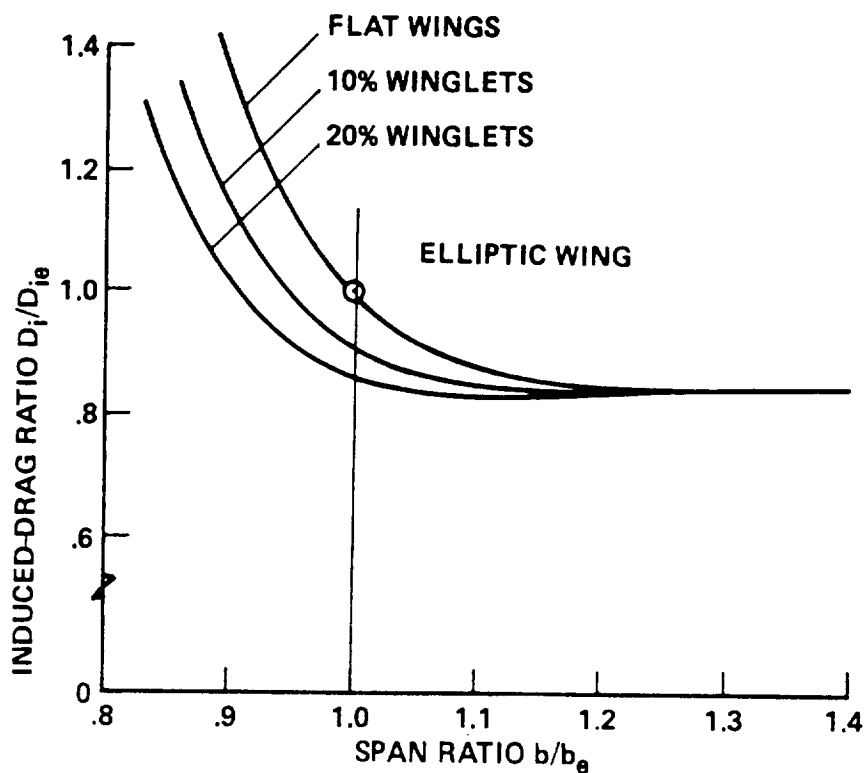

Induced drag of wings having the same bending moment at the wing root.

What is Possible?

The figure below illustrates the effect of nonplanar wing shape on span efficiency. Each of the geometries, shown in front view below, is permitted a vertical extent of 20% of the wing span. Each design has the same projected span and total lift. The results were generated by specifying the geometry of the trailing vortex wake and solving for the circulation distribution with minimum drag. So, each of the designs is assumed to be optimally twisted. This was done by discretizing the vortex wake and solving a linear system of equations for minimum drag with a constraint on overall lift. Similar results for a variety of shapes have been described by Cone, Munk, Letcher, Jones, and others.

The results illustrate the variability in span efficiency among these designs. Note the relatively small gain for the diamond-shaped device and the wing with dihedral, while the C-wing shape achieves essentially the same drag as the boxplane.

Span Efficiency of Various Nonplanar Shapes Height / Span = 0.2

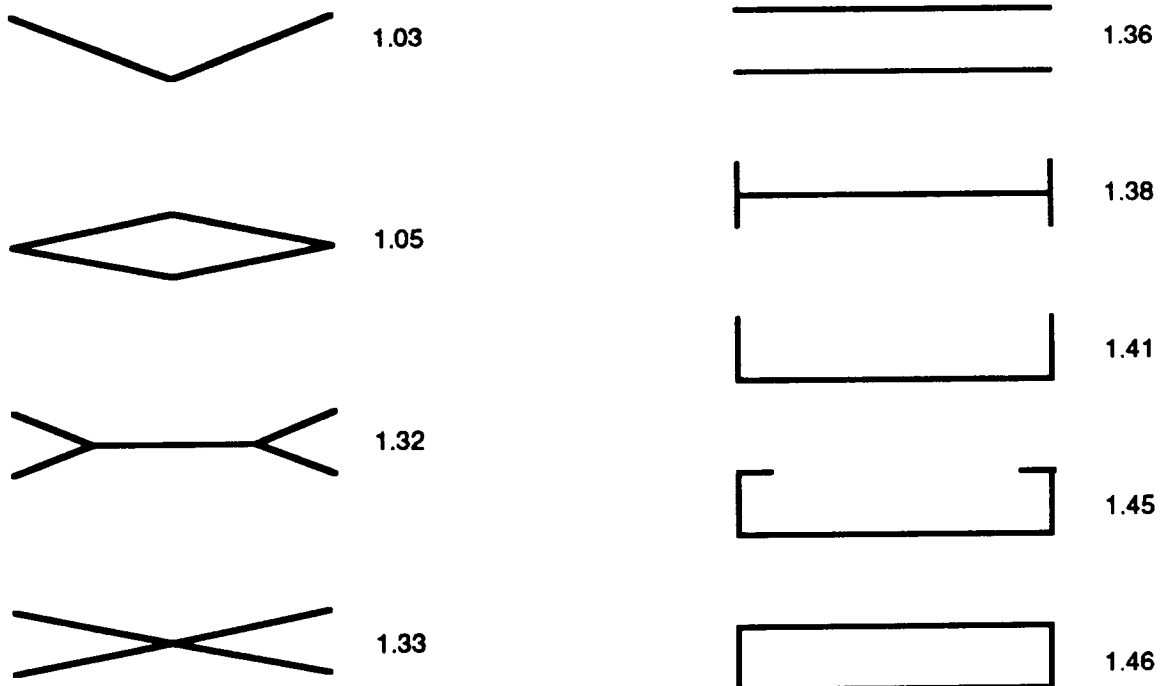

Nonplanar Wakes: The Split Tip

From among this list of possible designs, we choose two ideas to look at in a bit more detail. The first concept is based on the notion that it is the shape of the wake, not the shape of the wing that is important to the total vortex drag. By sweeping the trailing edge of the wing sharply backward or forward and placing the wing at an angle of attack, one may generate a wake shape that looks very much like the wake of a wing / winglet combination. The difficulty here is that we must twist the wing or create a planform shape that achieves the optimal load distribution that corresponds to this geometry. Moreover, for reasonable wing planforms, the amount of out-of-plane wake deformation is very limited. For this reason the potential gains associated with crescent-shaped wings or wings with highly forward-swept trailing edges are very small ($\sim 1\%$ or less) unless the wing has a very low aspect ratio.

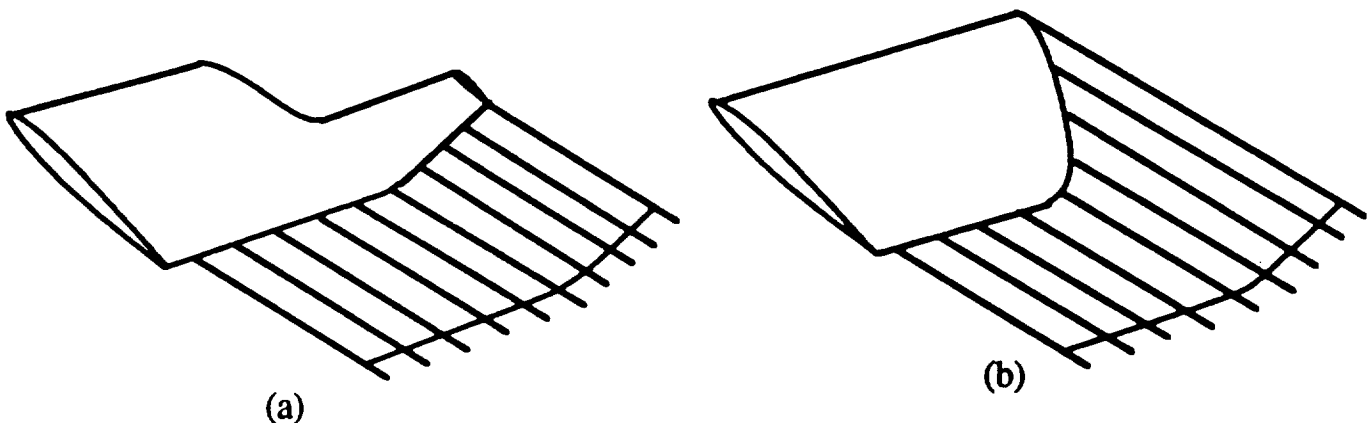

Nonplanar Wakes Shed from Wing with Winglet (a), and Planar Wing (b).

Nonplanar Wakes: The Split Tip

To exaggerate this effect, a wing with the geometry shown below was created. The idea here was to generate a shape whose potential span efficiency gain for a given amount of out-of-plane deformation was large. Based on the previous figure, a split tip geometry for the wake was selected as a shape that could be generated by wake deflection and the wing planform shown below was investigated. The figure shows the planform shape and the shape of the wake trace when the wing is at 9 degrees incidence. Based on this wake shape, an induced drag savings of about 5% is possible when the wing is optimally loaded, and more as the angle of attack is increased.

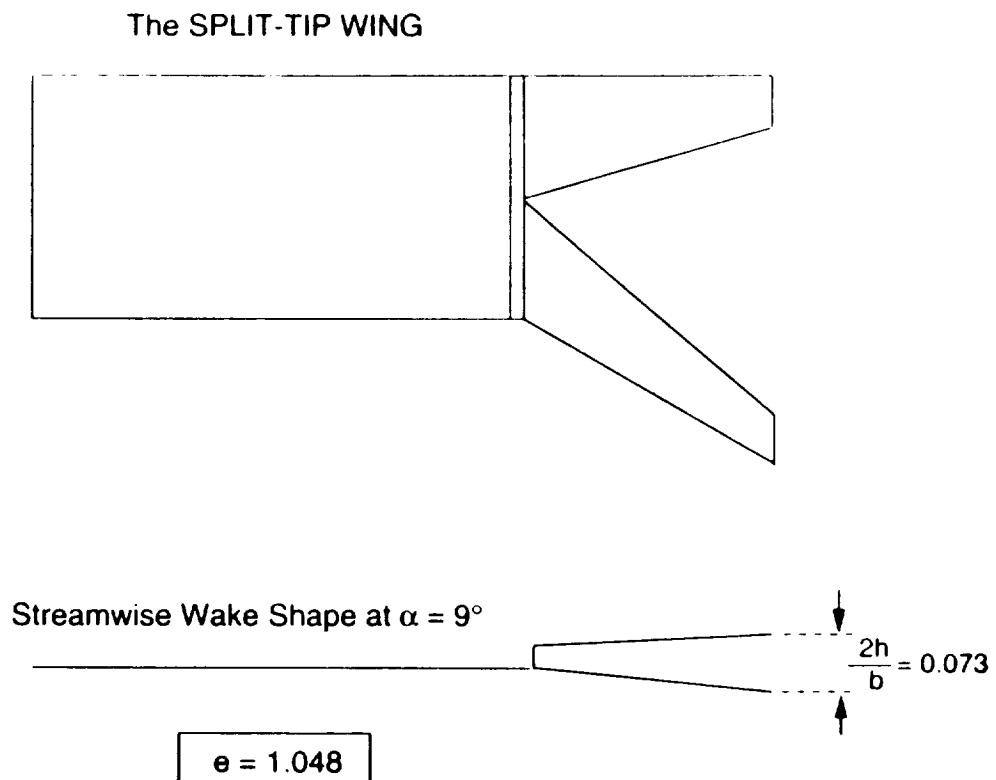

Nonplanar Wakes: The Split Tip

Of course, the wake does not trail from the wing in the streamwise direction and careful computation of rolled-up wake geometry and inviscid drag shows that the effect of wake-rollup is to roughly double the gain expected for a streamwise wake. The 11% increment in span efficiency was significant and the concept was studied in more detail both theoretically and experimentally. The figure below shows the computed wake geometry and wing paneling used to compute vortex drag with the high-order panel code A502.

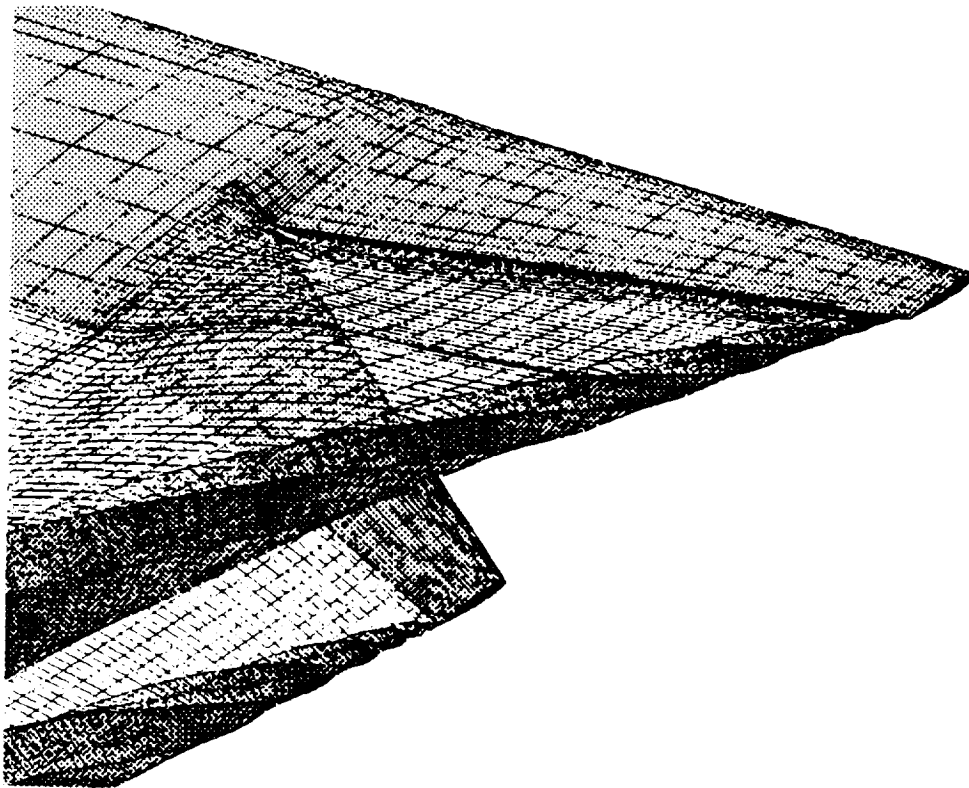

Nonplanar Wakes: The Split Tip

Two wings were constructed and tested at NASA's Ames Research Center. The first was an untwisted planform with an elliptical chord distribution, unswept quarter chord line, and an NACA 0012 airfoil section. The second wing of the same area and span, also untwisted with a 0012 airfoil section, incorporated the split tip geometry. Both models were designed to incorporate a sensitive internal balance so as to minimize support interference. The figure below shows the ratio of lift to drag for each of these wings confirming the predicted lower drag of the split tip geometry.

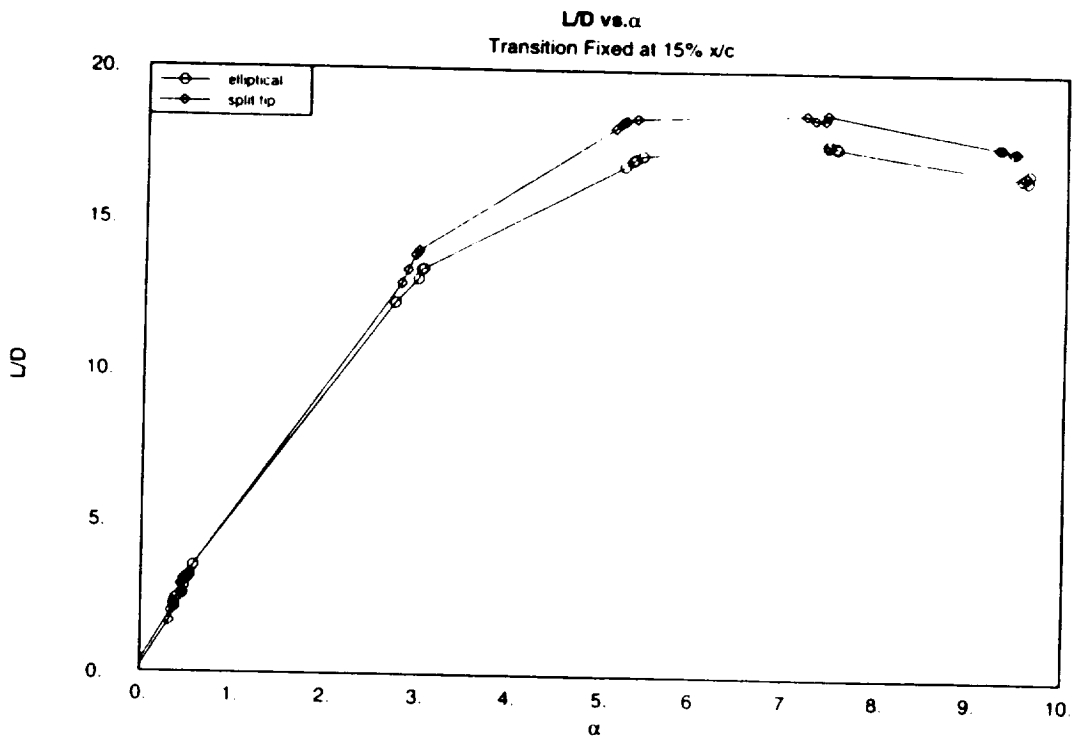

Nonplanar Wakes: The Split Tip

To further confirm the theoretical predictions, estimates of vortex drag and wake shape were compared from calculations, balance data, and a detailed wake survey. From the wake survey, an explicit estimate for the vortex drag can be obtained. This value agrees well with the computed result and the balance data.

The results are intriguing, and although the configuration was selected to exaggerate a particular effect rather than to serve as a good airplane wing, its application to aircraft, propellers, and rotors is currently under investigation.

The effect is significant, but not large and we next consider a design with more substantial implications for aircraft design.

TOTAL PRESSURE CONTOURS from WAKE SURVEY
COMPARED WITH
COMPUTED FORCE-FREE WAKE SHAPE

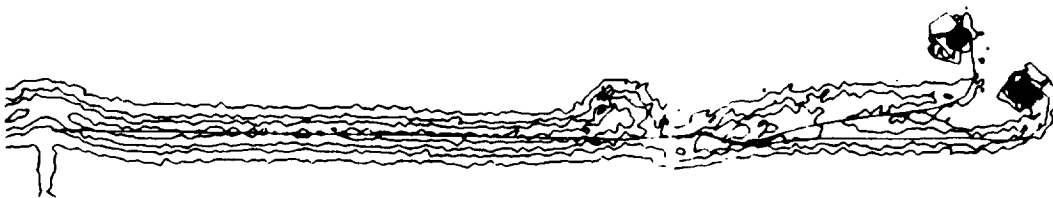

Span Efficiency	Computed	$C_D - C_{Dp}$	Survey
Elliptical Wing	0.970	0.98	0.972
Split Tip	1.113	1.10	1.096

The C-Wing: A Novel Nonplanar Wing Configuration

From the survey of nonplanar wing geometries discussed previously, one is struck by the fact that one need not produce a closed system such as the box plane to achieve essentially all of the induced drag savings that this configuration offers. In particular, extending the upper part of the box only 10% of the span inward from the tip achieves a span efficiency within about 1% of the complete box. Thus, one could achieve the drag savings of the box plane without the Reynolds number and fuel volume penalties of the two-wing design. Furthermore, the small horizontal tip extensions have some interesting implications for airplane design. This configuration was independently “discovered” by a genetic algorithm that was asked to find a wing of fixed lift, span, and height with minimum drag. The system was allowed to build wings of many individual elements with arbitrary dihedral and optimal twist distributions. The figure below depicts front views of the population of candidate designs as the system evolves. On the right, the best individual from a given generation is shown.

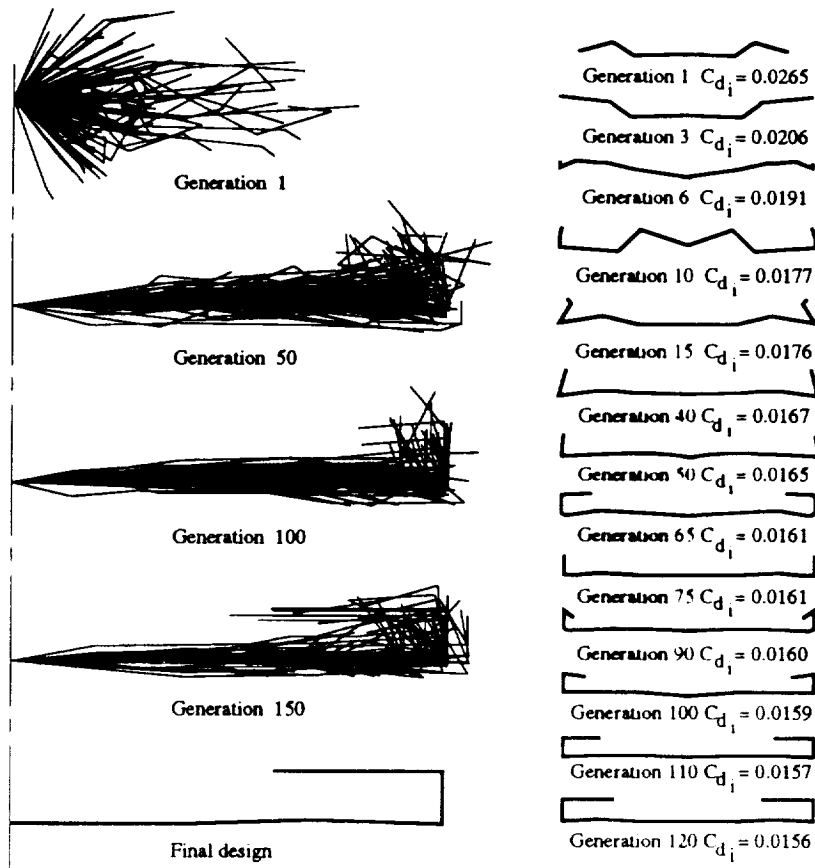

C-Wing Configuration

The optimal loading of this lifting system is shown in the figure below. The circulation of the main wing is carried onto the winglet so that the winglet is loaded inward. When the horizontal extension is added to the winglet, forming the "C" shape, the circulation is extended from the winglet as well, producing a surface that is loaded downward for minimum induced drag at fixed total lift. It is only when the lifting surface is extended to the centerline to form a box plane that the upper wing can efficiently carry an upload. This is because, as mentioned previously in connection with closed systems, we can superimpose a constant circulation ring on the closed system to redistribute the lift without changing the wake.

This download on the C-wing horizontal surfaces affects structural weight and trim and the implications for aircraft configuration concepts was intriguing.

Geometries Analyzed

All with fixed span, area, and total lift

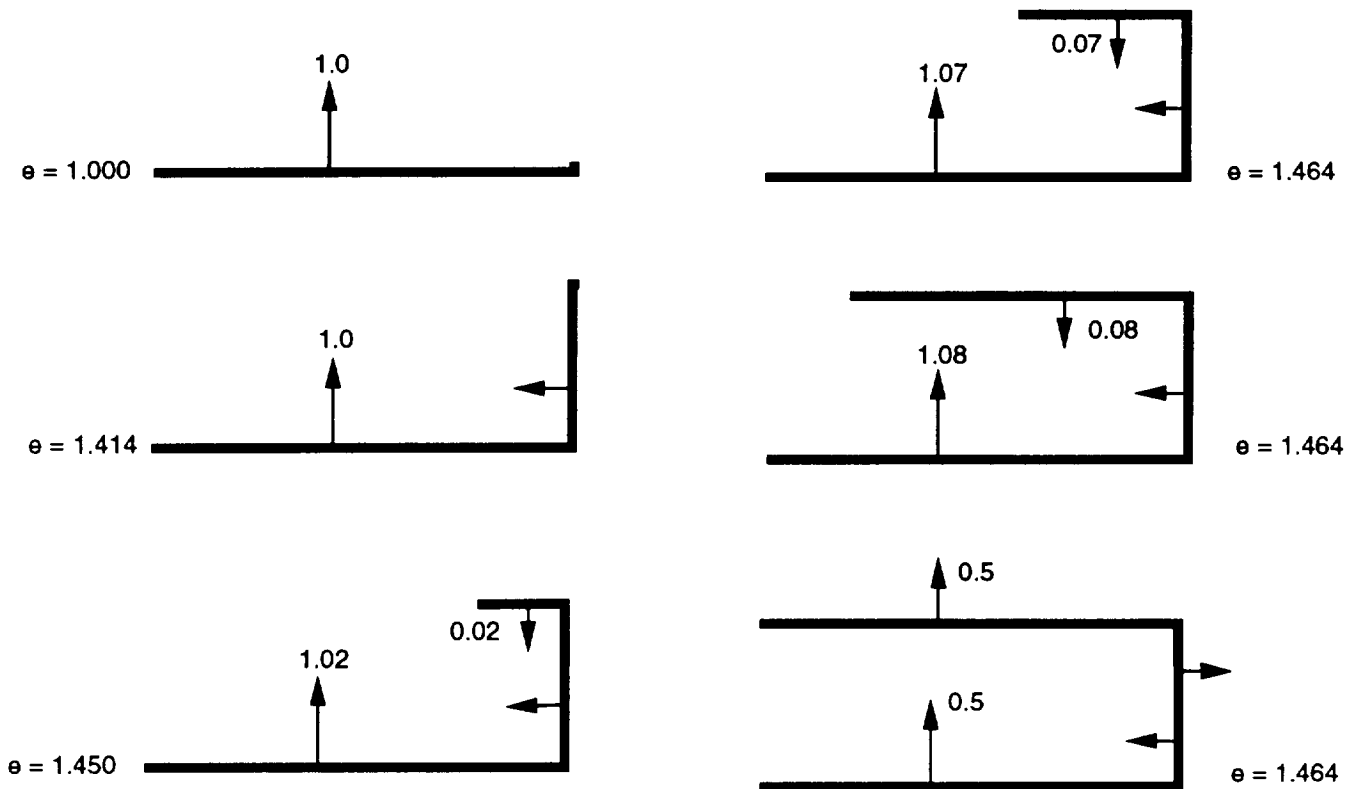

C-Wing: Application to Large Aircraft

The first application of this concept to an aircraft design study was in connection with recent interest in very large civil transports. Many of the issues listed in the figure below are problematic for the conventional configuration. Airport and manufacturing constraints limit the span of a new large aircraft. The location of the outboard engine is a problem, and the height of the vertical tail becomes excessive.

LARGE AIRCRAFT ISSUES

Problem:

- Runway limits
- Taxiway limits
- Gate limits
- Emergency evacuation
- Community noise
- Wake vortices
- Structural limits

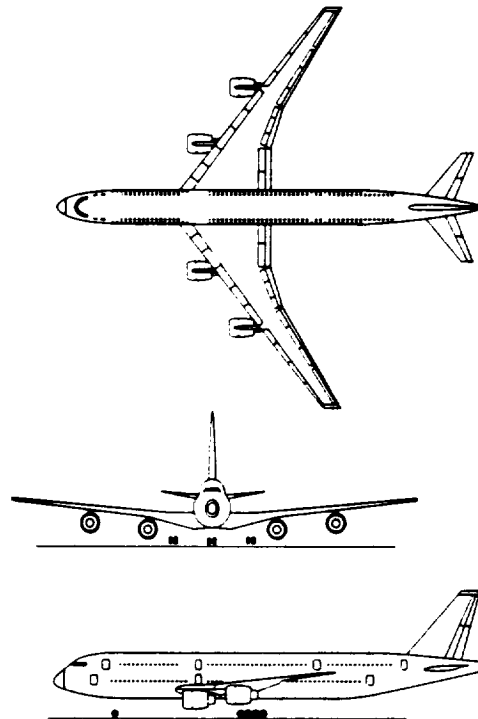

C-Wing: Application to Large Aircraft

Using the C-Wing configuration, the span of an otherwise conventional large aircraft can be reduced. Because the fuselage tends to be rather short on double deck configurations, the horizontal tail location is not much farther aft than the wing tips making it possible to consider using the C-wing as the primary pitch control surfaces. (The horizontal C-wing surfaces provide more stability for a given area as they are not affected by the aft fuselage flow field and are less affected by wing downwash. Moreover, they provide a positive trimming moment when optimally loaded.) The removal of the horizontal tail makes the use of aft-fuselage-mounted engines a possibility, eliminating some of the severe problems with the original outboard engine location. Despite some attractive features, however, the performance advantages for this configuration are not substantial, and probably not worth the risk associated with the unconventional design.

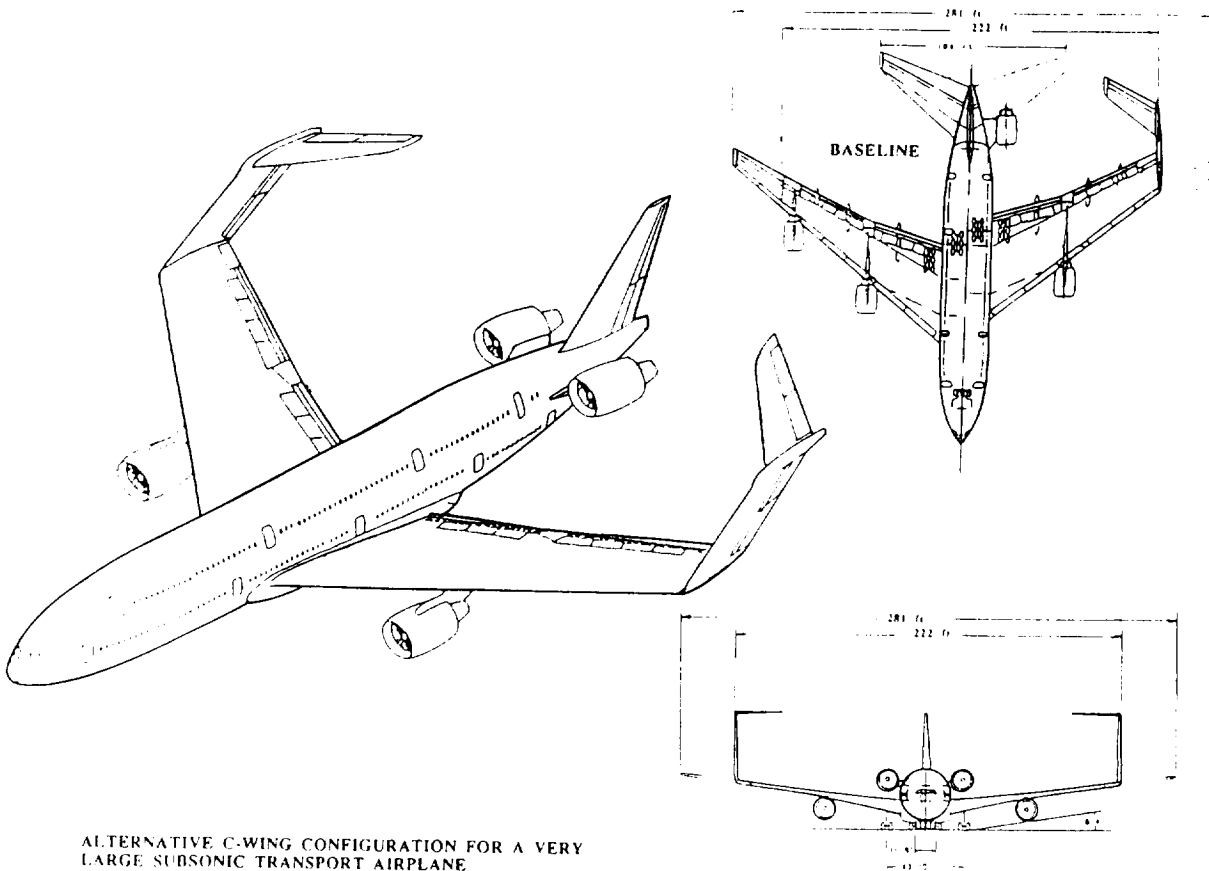

ALTERNATIVE C-WING CONFIGURATION FOR A VERY LARGE SUBSONIC TRANSPORT AIRPLANE

C-Wing: Application to Large Aircraft

As the number of passengers reaches 600-800, the possibility of including some passenger cabin area inside the wing appears more attractive. For the C-Wing configuration the wing span is reduced and the wing chord increased to maintain the desired lifting area and structural support for the tip surfaces, making this idea even more appealing. Furthermore, when a long empennage is no longer required for horizontal and vertical tail surfaces, one is led to the rather unconventional large aircraft configuration pictured below.

This design comprises a three-surface configuration providing a large allowable c.g. range, with a relatively lightly loaded wing to simplify high-lift system requirements and accommodate passenger cabins in the wing. The vertical and horizontal tip extensions provide an efficient means of satisfying stability and control constraints.

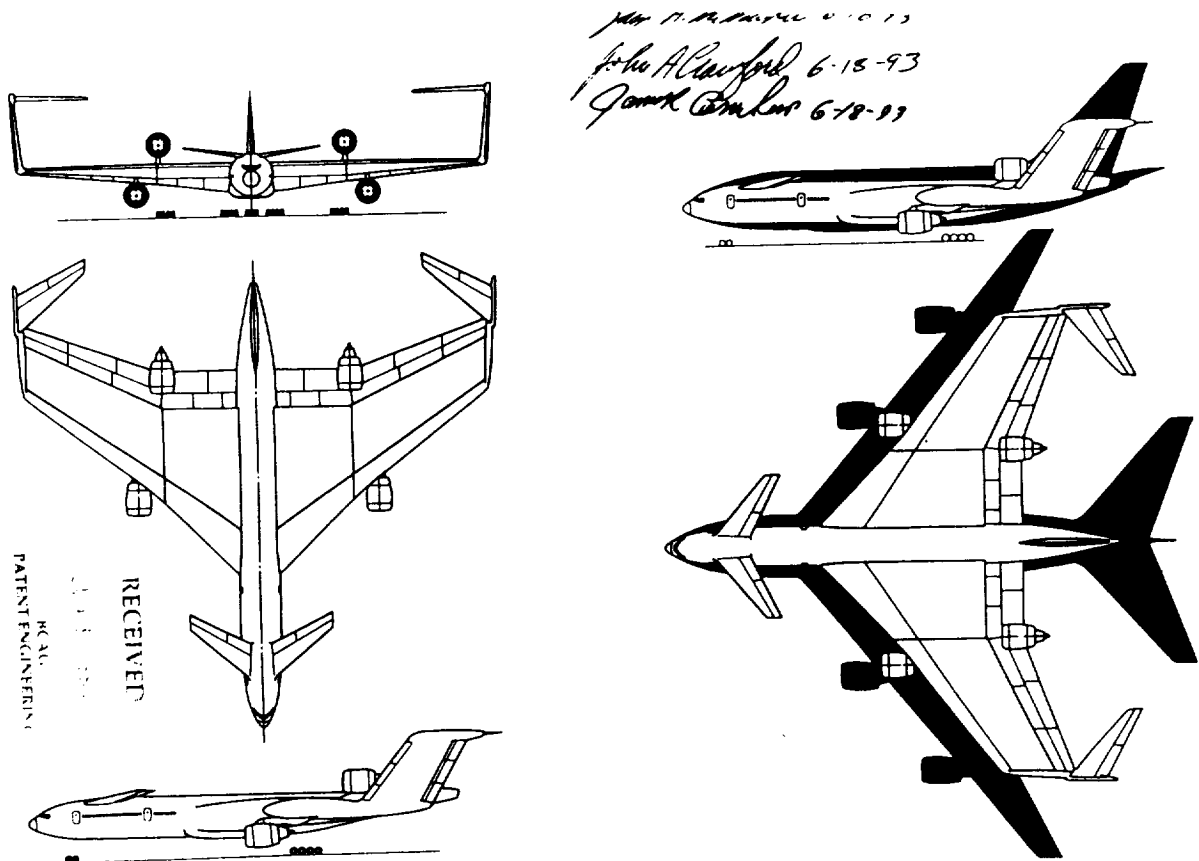

C-Wing: Application to Large Aircraft

As the design evolved to the tri-jet shown below, the wing span was increased, but remained substantially lower than the conventional design. More efficient use was made of the existing 777 fuselage area and the thick inner wing section was modified based on an investigation of high-speed thick sections.

The basic idea in this conceptual design study was not to obtain the highest performance for this large aircraft, but rather to provide a feasible solution to the large aircraft problem. The design addresses many of the problems that arise from the simple scaling-up of the conventional design.

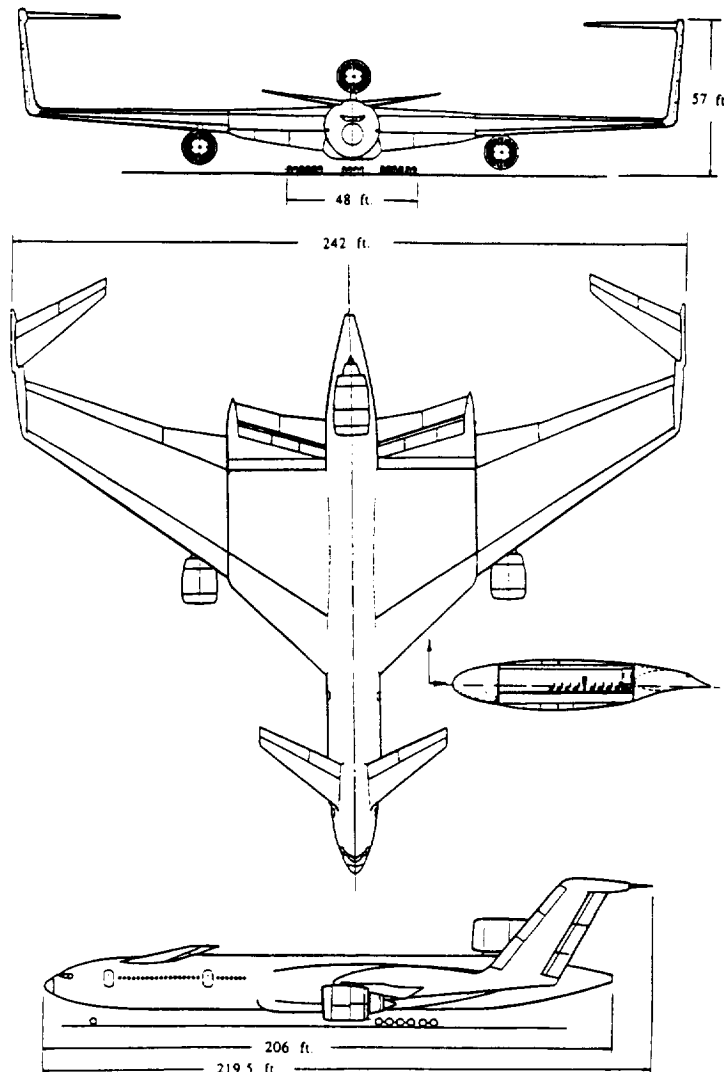

C-Wing: Application to Large Aircraft

The layout of passengers and accommodations (LOPA) for this aircraft is shown below.

By including passenger cabins in the inner wing area, it is possible to accommodate all 600+ passengers (tri-class) in a single deck arrangement. This resolves many of the difficult loading and emergency egress issues associated with double deck cabins. The use of the cylindrical fuselage section of a Boeing 777 keeps most of the passengers near the centerline, provides windows for many, and permits some growth by conventional fuselage stretching.

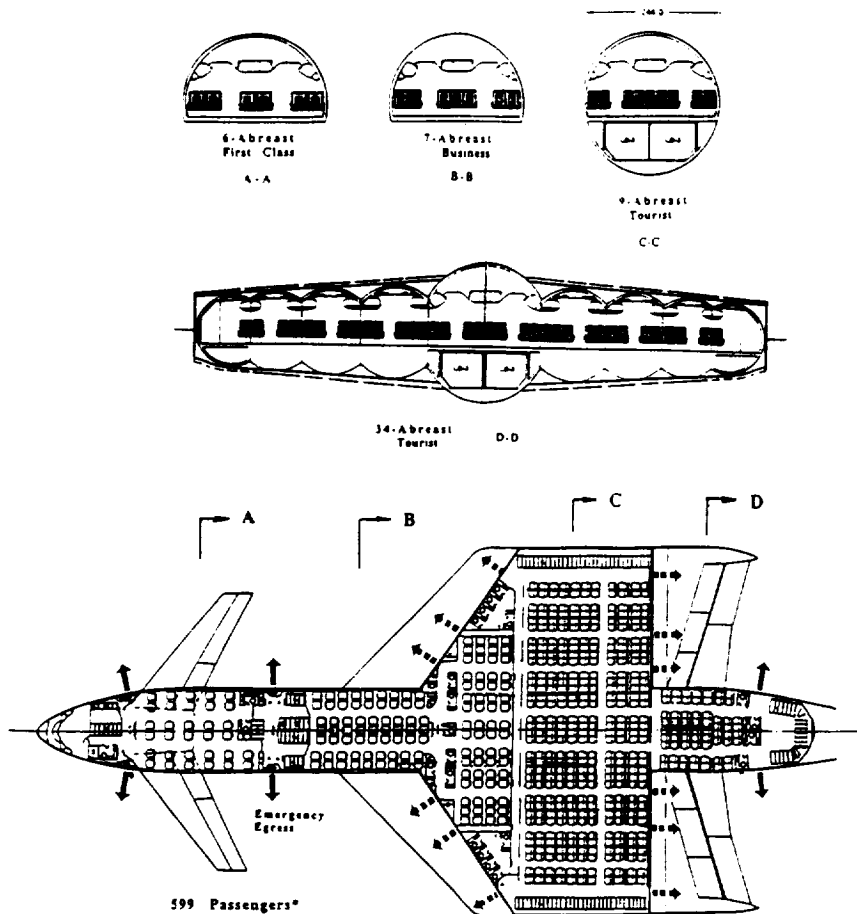

	32 First	127 Business	440 Tourist	
	Class (%)	Galley Ratio (cu ft/ pass)	Carts (qty)	Lavatory Ratio (pass/lav)
First	5.3	15.5	24	1.1
Business	21.2	7.7	40	1.8
Tourist	73.5	2.7	33	4.0



[*Approximately 750 passengers in an All Tourist configuration]

C-Wing: Application to Large Aircraft

Studies at Stanford and Boeing were undertaken as part of NASA's Advanced Concepts Program in 1995. Concurrently, initial sizing and optimization of the original concept were pursued at NASA's Langley Research Center.

Each of these studies involved analysis and numerical optimization of the basic concept. At Langley the FLOPS computer program was modified to handle this geometry. At Stanford and Boeing, the PASS and ACSYNT codes were also modified to analyze this design. Existing engine decks representative of modern high bypass ratio engines were used rather than estimating the performance of future technology. This represents a rather conservative approach. Additional analysis with ADP engines and laminar flow control remains to be completed, but several aspects of the design suggest that gains from such technologies may exceed those obtained with conventional designs.

DESIGN AND ANALYSIS METHOD

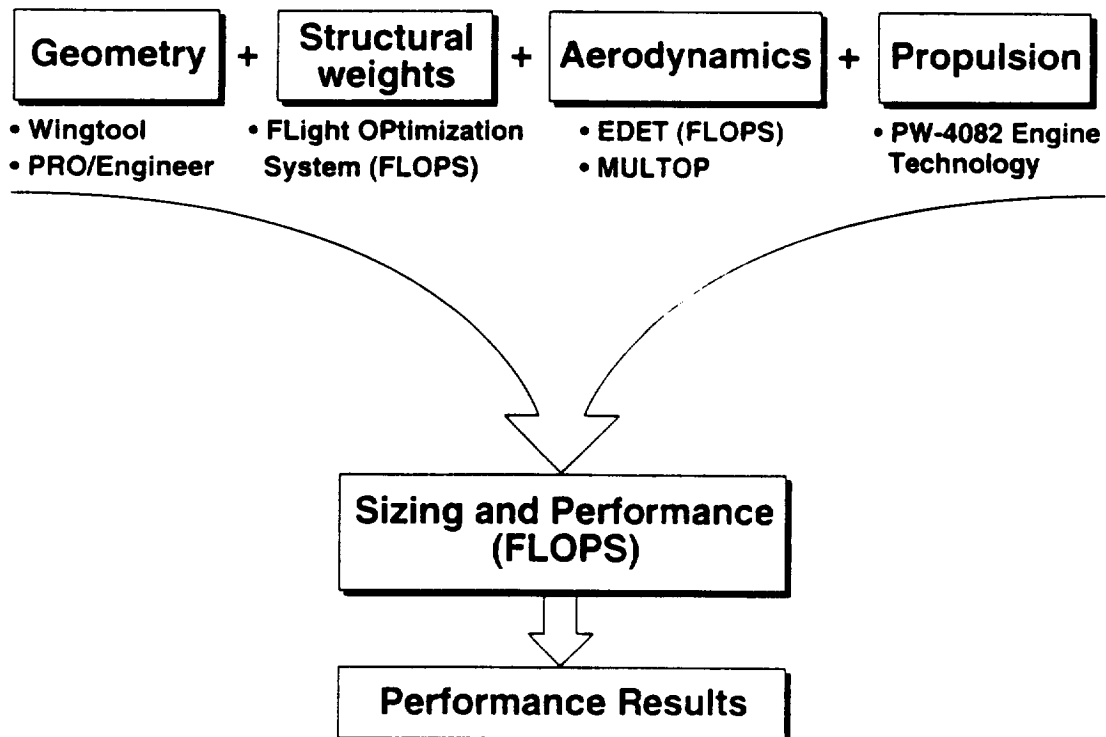

C-Wing: Optimization

The figure below illustrates example results from one of these studies with the following assumptions:

Design Mission and Constraints

Parameter	Langley	Boeing/Stanford
Range	7000 nmi	7000 nmi
Mach	0.85	0.82
Passengers	800	600 (tri-class)
Field Lengths	12000	11000
# Engines	4	3
Approach	150 kts	

Other constraints typical of FAR Part 25.

The results indicate that substantial reductions in take-off weight are possible, even though the concept was aimed primarily at resolving some of the problems associated with very large aircraft rather than providing much better performance.

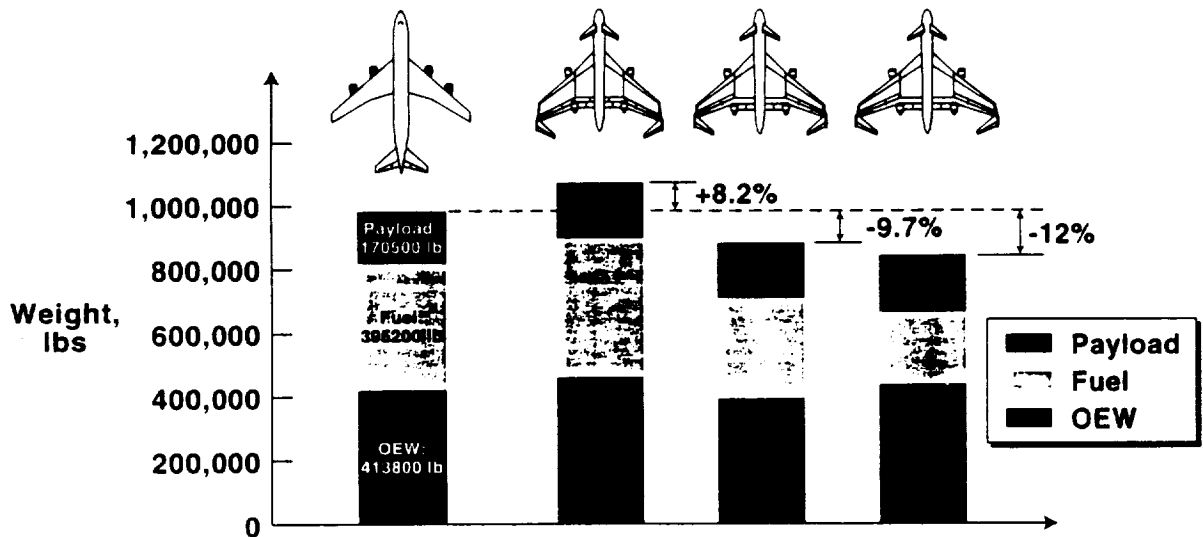

Model	Conventional Baseline	C-Wing 1	C-Wing 2	C-Wing 3
Material	Composite	Composite	Composite	Composite
AR	8.42	4.07	6	6
Wing area, ft	8136	15116	11052	12514
Thrust/Engine, lb	52509	74399	46691	45251
Span, ft	229	236	245	260
Goldschmied factor	-	1.0	1.0	2.0
TOGW	979500	1060200	884900	861500

C-Wing: Application to Large Aircraft

The results suggested that, at least with the original LOPA concept, the design improved with very thick sections inboard. In conjunction with related studies at M.I.T., Purdue, and the University of Illinois, a set of airfoils well-adapted to the inboard wing sections of this concept were developed and their performance was modeled in the aircraft sizing studies. These sections utilized suction on the aft area of the section to extend the region of high thickness aft and to reduce superelevations over the upper surface. Some ideas for the integration of these sections with the passenger compartment and high lift system are illustrated below.

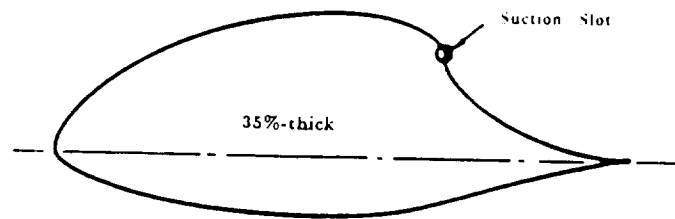

(a) Classic Very Thick Subsonic Griffith Airfoil

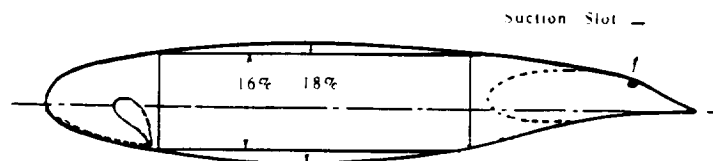

(b) Possible 18% Transonic Griffith Airfoil

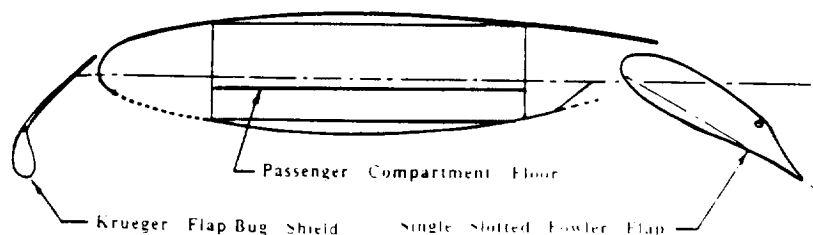

(c) High-Lift System Concept for a Transonic Griffith Airfoil

C-Wing: Application to Large Aircraft

One of the possible advantages of the C-Wing concept involves the development of the trailing vortex wake system from this geometry. A major concern with large aircraft is the hazard of the trailing vortex wake to other aircraft. The C-wing distributes the vorticity in the wake over a longer distance, reducing the intensity of the wake sheet, but the vortices shed from the wing tips and the tips of the C-Wing extensions are closer together than they would be for a conventional design, accelerating the breakdown of the wake system. Preliminary studies of this phenomena were undertaken at Tuskegee University and are not complete, but do illustrate some of the differences between the wake of the C-Wing and that of a conventional design.

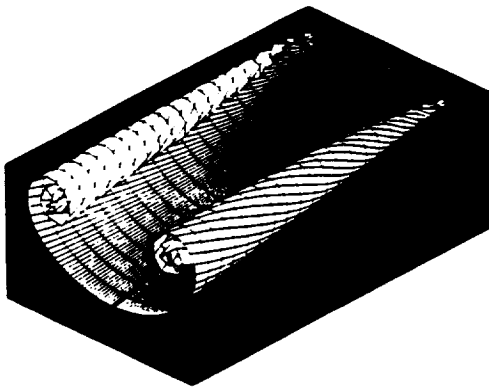

ELLIPTIC WING VORTEX SHEET ROLLUP

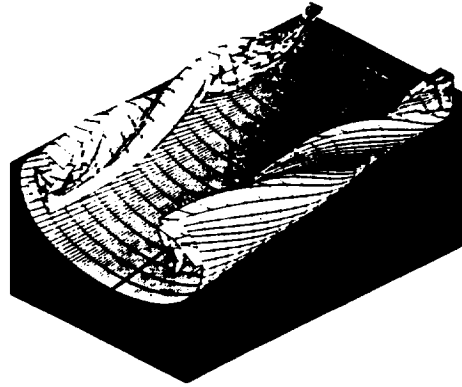
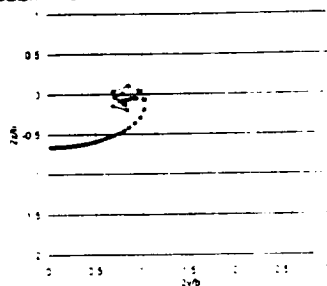

CWING VORTEX SHEET ROLLUP

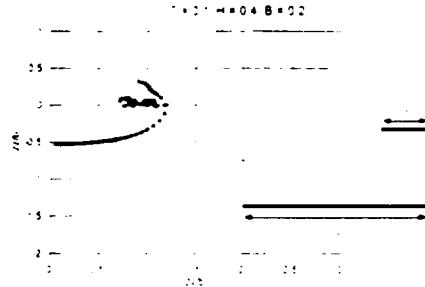

C-Wing: Application to Large Aircraft

A significant concern for this type of configuration is its aeroelastic stability characteristics. The swept C-wing design might be expected to lower the torsional frequencies of the system and permitting additional coupling between primary bending and torsion modes. The lifting surfaces near the tips do introduce substantial damping to the torsion modes so that the flutter characteristics of this design are not obvious. One of the attractive features of the C-Wing geometry, however, is that even if the uncontrolled flutter modes are less stable than a conventional wing, the system is more controllable. With control surfaces on the main wing and the horizontal tip extension, one may independently control lift and torsion. This makes the system more easily controlled than a conventional wing in which deflection of an aileron introduces both torsion and bending perturbations. The figure below shows how this concept may be used to eliminate aileron reversal for the C-wing design.

C-Wing Aeroelastic Features

**Independent control over lift / torsion prevents
aileron reversal, increases control of flutter modes**

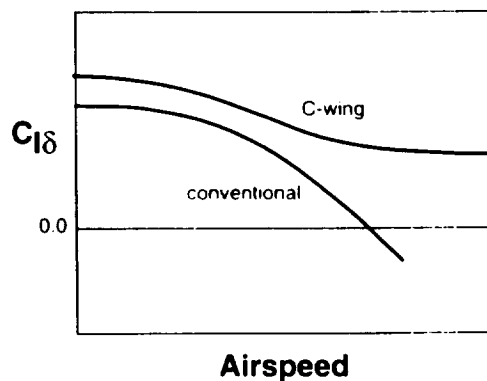
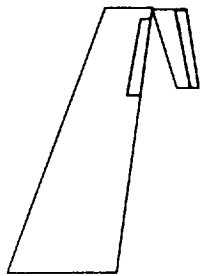

C-Wing: Application to Large Aircraft

A second round of conceptual design iteration remains to be completed, however, designs such as that shown below are under investigation. In this design, the platform is modified slightly to permit larger root t/c's. A 747-based fuselage is used to accommodate more of the payload in a conventional environment (more windows, conventional egress) and reduce the passenger lateral extent. These two changes may make conventional airfoil sections (without boundary layer control) more attractive. By removing the canard from the design, efficient trim is still possible without active controls.

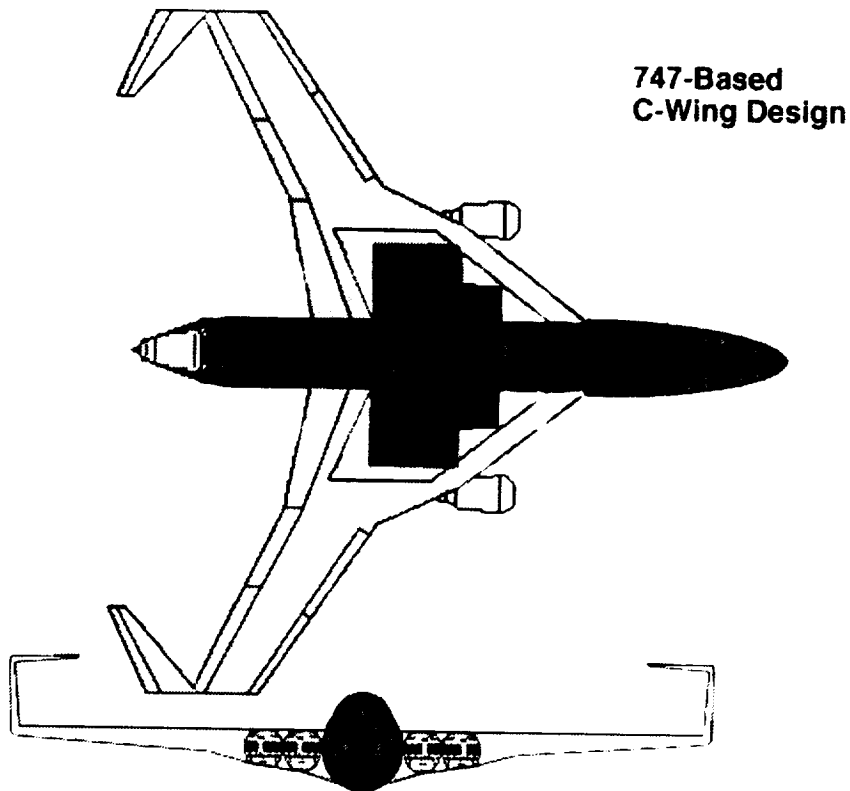

C-Wing: Application to Large Aircraft

The figure below shows the addition of C-Wing tips to the McDonnell-Douglas Blended Wing Body concept. The addition of these surfaces would permit the BWB configuration as currently envisioned to fly with positive static stability with no change to the aerodynamic design of the highly-loaded, thick transonic wing. The added weight and skin friction drag of these surfaces may be partly offset by a reduction in induced drag and by the relaxed moment constraints on the main wing sections. Although the concept remains to be studied in any detail, its implications for controllability and efficient trim of this flying wing design are promising.

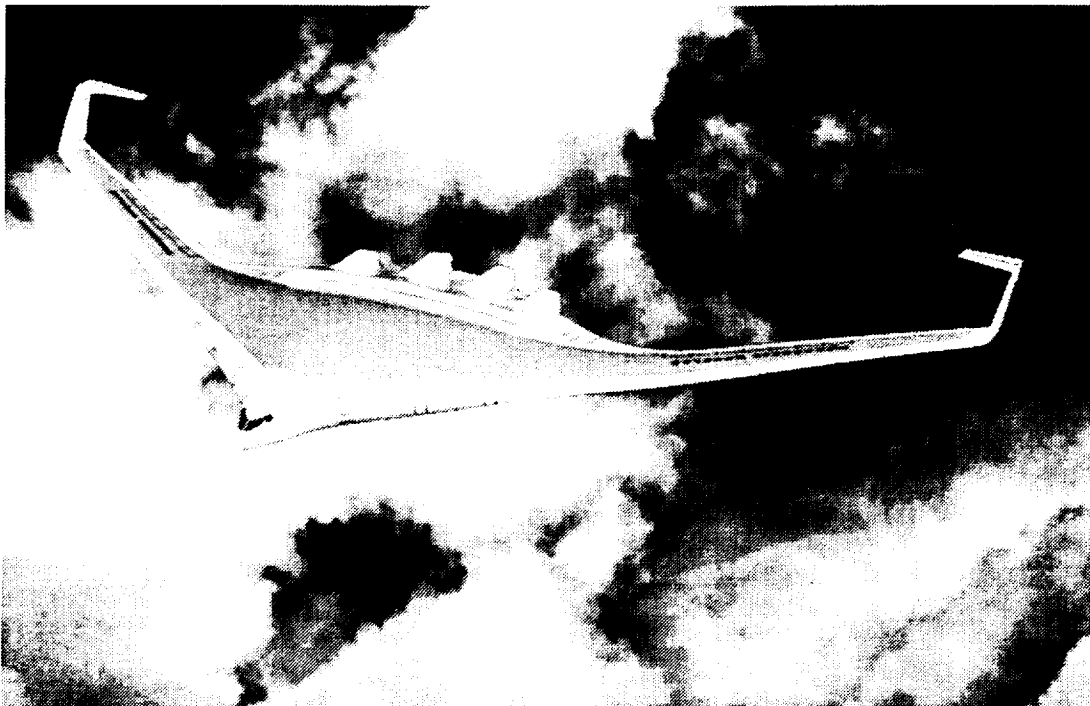

C-Wing Summary

The advantages of the C-wing configuration for a large capacity subsonic transport are listed below. They include those directly associated with the nonplanar wing geometry and those that arise indirectly from the overall configuration shown on previous pages.

Nonplanar Wing:

1. Reduced span or reduced vortex drag at fixed span
2. Efficient trim with short fuselage
3. Improved lateral handling (lower effective dihedral, reduced adverse yaw)
4. Potential for aeroelastic control: prevent aileron reversal, active flutter control
5. Reduced tendency for pitch-up, control at high alpha
6. Reduced vertical tail height
7. Possible reduction in wake vortex strength

Configuration:

1. Improved aero/structural performance through span loading, potential for reduced wetted area
2. Effective use of redistributed wetted area reduces high lift system cost or TO thrust / noise, potential for laminarization.
3. Some advantages of all-wing design with reduced risks: egress, windows, growth, structure, acceptability
4. 2 wing-mounted engines reduce obstacle problem with outer engine / engine out yaw
5. Single deck in wing facilitates loading, emergency egress

Disadvantages:

1. Details of emergency egress remain uncertain
2. Aerodynamics of thick inboard sections still an issue
3. Aeroelastics may be controllable but may need to be controlled

Conclusions

A look at nonplanar wing concepts suggests that such configurations do offer potential performance benefits. This is especially true when the concept is fully exploited by re-sizing or even redesigning the aircraft.

In addition to reductions in vortex drag, some of configurations mentioned here have desirable effects on structures, stability and control characteristics, vortex wake hazards, and other practical considerations.

The split tip design demonstrates that by manipulating the wake shape as well as the wing shape, some of the advantages of nonplanar wings may be obtained even with planar wings, and the possible applications of this idea warrant further study.

The C-wing configuration remains an intriguing design concept with many beneficial characteristics when applied to a large aircraft design. The implications of this approach remain to be more fully explored.

Conclusions

- **Nonplanar wings provide potential performance benefits**
- **Other useful characteristics**
- **Split tip demonstrates high span efficiency**
- **C-Wing characteristics intriguing but not fully explored**

Post Script

The direct application of these concepts to an existing aircraft are less than overwhelming. As illustrated in the figure below, if a 20% reduction in vortex drag were achieved by an existing airplane and the airlines passed the savings on to the customers directly, we would see a very modest reduction in ticket price (about \$3 on a \$300 ticket). Although this savings would have major implications for airline profitability, most passengers would not be impressed by the savings. If the concept is used to redesign the airplane, as in the C-wing example here, not only is the savings increased, but an otherwise infeasible design may become feasible.

The Bigger Picture

Aerodynamics and Ticket Price

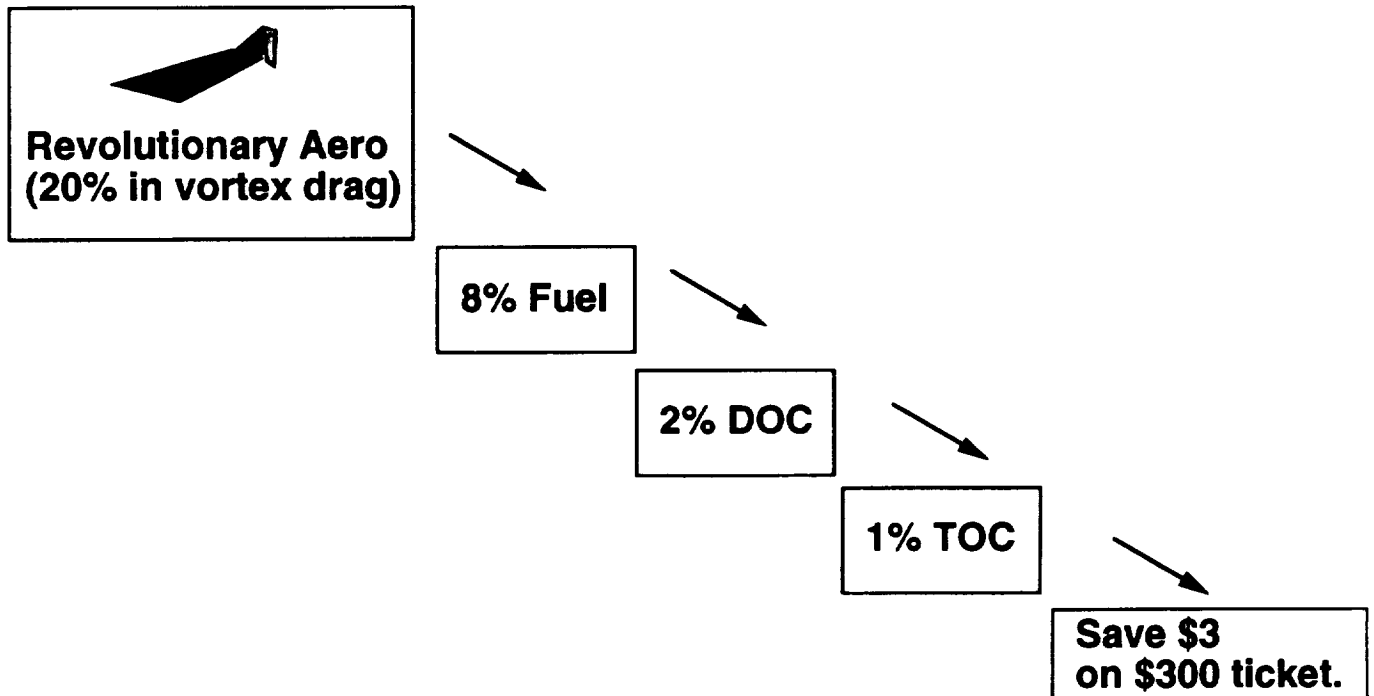

Post Script

The direct insensitivity of ticket price to drag might be exploited as shown below. By re-designing an aircraft with fixed payload capacity, but with twice the floor space for each passenger, the fare would have to be increased by about \$30 on a \$300 ticket*. This is very reasonable, but might still be unacceptable in the highly elastic commercial transportation market. Nonetheless it is my hope that advances in aerodynamics and other disciplines can be employed to do more than just marginally lower the cost of air transportation, but rather improve its safety and comfort.

*This is the result of a numerical optimization study undertaken during my 11 hour trip from San Francisco to this conference.

The Cost of Comfort

Cost of Doubling Passenger Space

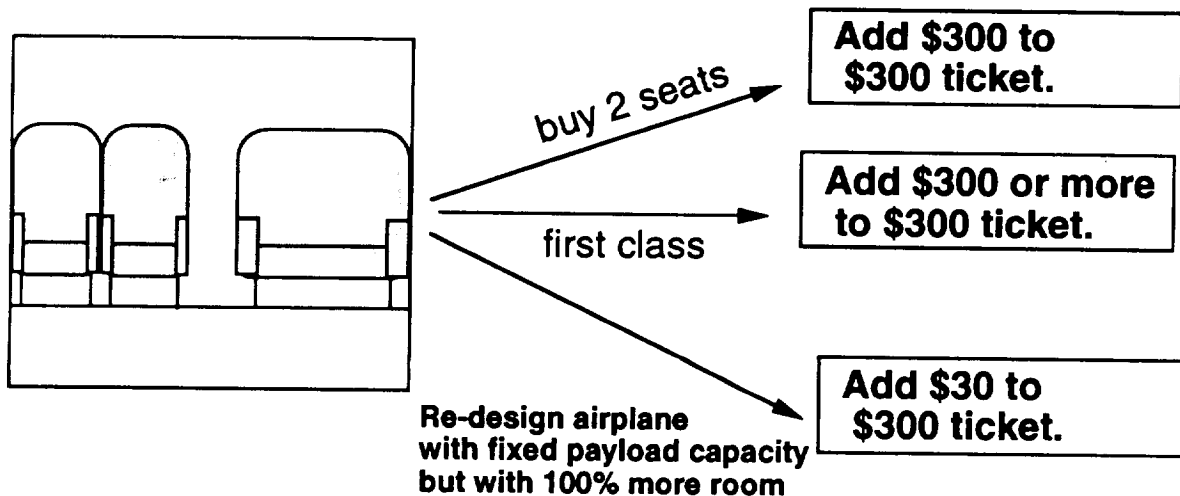

References

- Cone, C. D., "The Theory of Induced Lift and Minimum Induced Drag on Non-Planar Lifting Systems," NASA TR-R-139, 1962.
- De Young, J., "Induced Drag Ideal-Efficiency Factor of Arbitrary Lateral-Vertical Wing Forms," NASA CR-3357, Dec. 1980
- Gage, P., "New Approaches to Optimization in Aerospace Conceptual Design," Ph.D. Thesis, Stanford University, Dec. 1994.
- Gallman, J.W., Kroo, I., Smith, S.C., "Design Synthesis and Optimization of Joined-Wing Transports," AIAA 90-3197, Sept. 1990.
- Heyson, H. H., Roebe, G. D. and Fulton, C. L. "Theoretical Parametric Study of the Relative Advantages of Winglets and Wing-Tip Extensions," NASA TP 1020, 1977.
- Jones, R., Lasinski, T., "Minimum Induced Drag of Wings with Winglets", NASA TM-81230, Sept. 1980.
- Kroo, I., "A General Approach to Multiple Lifting Surface Analysis and Design," AIAA 84-2507, Oct. 1984.
- Lange, R.H., Cahill, J.F., et al., "Feasibility Study of the Transonic Biplane Concept for Transport Aircraft Application," NASA CR 132462, Lockheed-Georgia Company, June 1974.
- Letcher, J.S., "V-Wings and Diamond-Ring Wings of Minimum Induced Drag," J. of Aircraft, Vol. 9, No. 8. 1972.
- Lundry, J. L. and Lissaman, P. B. S. , "Minimum Induced Drag on Non-planar Wings," J. Aircraft, Vol. 5, No. 1, 1968, pp. 17-21.
- McMasters, J.H., Kroo, I.M., "Advanced Configurations for Very Large Subsonic Transport Airplanes," NASA Workshop on Potential Impacts of Advanced Aerodynamic Technology, portions published in NASA TM 109154, Sept. 1994.
- Munk, M. M., "The Minimum Induced Drag of Aerofoils," NACA Report 121, 1921.
- Smith, J. H. B., "Wing Tip Flows and Wing Devices (Symposium): Introductory Remarks," Aeronautical J., Dec. 1987, pp. 443-445.
- Smith, S.C., "A Computational and Experimental Study of Nonlinear Aspects of Induced Drag," Ph.D. Thesis, Stanford University, June 1995.
- van Dam, C.P., "Induced Drag Characteristics of Crescent-Moon-Shaped Wings," J. of Aircraft, Vol. 24, No.2, 1987.
- van Oossanen, P. , Joubert, P. N., "The Development of the Winged Keel for Twelve-Metre Yachts," J. Fluid Mechanics, Vol. 173, 1986, pp. 55-71.
- von Karman, T., Burgers, J.M., "General Aerodynamic Theory—Perfect Fluids," Vol. II of Aerodynamic Theory, W.F. Durand, ed., 1935.
- Wolkovitch, J., "The Joined Wing: An Overview," J. of Aircraft, March 1986.