

10-02
-415-14

NASA Technical Memorandum 4645

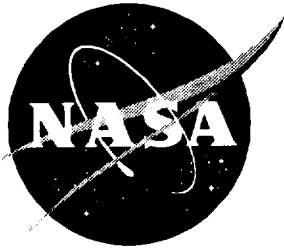

Experimental Surface Pressure Data Obtained on 65° Delta Wing Across Reynolds Number and Mach Number Ranges

Volume 1—Sharp Leading Edge

Julio Chu and James M. Luckring

February 1996

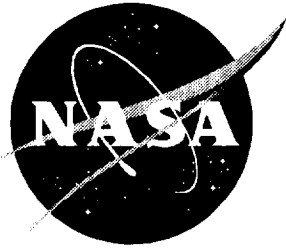

Experimental Surface Pressure Data Obtained on 65° Delta Wing Across Reynolds Number and Mach Number Ranges

Volume 1—Sharp Leading Edge

*Julio Chu and James M. Luckring
Langley Research Center • Hampton, Virginia*

The use of trademarks or names of manufacturers in this report is for accurate reporting and does not constitute an official endorsement, either expressed or implied, of such products or manufacturers by the National Aeronautics and Space Administration.

Available electronically at the following URL address: <http://techreports.larc.nasa.gov/ltrs/ltrs.html>

Printed copies available from the following:

NASA Center for AeroSpace Information
800 Elkrige Landing Road
Linthicum Heights, MD 21090-2934
(301) 621-0390

National Technical Information Service (NTIS)
5285 Port Royal Road
Springfield, VA 22161-2171
(703) 487-4650

Summary

An experimental wind tunnel test of a 65° delta wing model with interchangeable leading edges was conducted in the Langley National Transonic Facility (NTF). The objective was to investigate the effects of Reynolds and Mach numbers on slender-wing leading-edge vortex flow with four values of wing leading-edge bluntness. The data presented in volume 1 of this report are for a sharp leading edge equivalent to 0 percent of the mean aerodynamic chord. The data for the small-, medium-, and large-radius leading edges are presented in volumes 2, 3, and 4, respectively, of this report. Experimentally obtained pressure data for the sharp leading edge are presented without analysis in tabulated and graphical formats across a Reynolds number range of 6×10^6 to 36×10^6 at a Mach number of 0.85 and across a Mach number range of 0.4 to 0.9 at a Reynolds number of 6×10^6 . Normal-force and pitching-moment coefficient plots for these Reynolds number and Mach number ranges are also presented.

Introduction

Wing leading-edge vortex flow on slender wings has been a subject of study at aeronautical research laboratories (refs. 1–6) for many years. The wing upper surface pressure loading induced by the leading-edge vortex has been shown to provide a significant vortex-lift increment at moderate to high angles of attack for slender wings. (See ref. 7.) Application of vortical flow benefits has been primarily directed toward military use for which designs have been investigated that enhance transonic maneuverability for tactical supercruisers using vortex lift (refs. 8 and 9) or that suppress the vortex flow for those conditions where it is undesirable. (See ref. 10.) However, commercial application of vortex flow is evident in the ability of the *Concorde* to achieve high lift during takeoff and landing.

The majority of previous leading-edge vortex flow studies have been conducted on sharp leading-edge wings, where the primary separation line may be assumed to be located at the leading edge. This assumption permits inviscid vortex sheet approximations in analytical modeling and should minimize the dependency of the experimental data on Reynolds number. (See refs. 3–6 and 8.) However, vortical flow investigations on blunt leading-edge wings have been less comprehensive. (See refs. 2, 3, and 11.) The flow around blunt leading edges is inherently dominated by viscous effects and presents a significant challenge for empirical, analytical, or computational analysis. The primary separation line location and the vortex strength for a blunt leading edge are known to be dependent on Reynolds number. This sensitivity to Reynolds number also occurs with flow

reattachments and subsequent development of secondary vortices regardless of leading-edge bluntness. (See refs. 10 and 12.)

Accordingly, the National Aeronautics and Space Administration (NASA) Langley Research Center (LaRC) has attempted to augment the existing database (refs. 11 and 13) for the effects of leading-edge bluntness across a broad Reynolds number range and to facilitate the development of suitable scaling techniques in characterizing the complex leading-edge flows. The approach was to investigate the basic nature of the surface pressure on a slender wing with various values of the leading-edge radius. The experiment was conducted on a planar delta wing with a leading-edge sweep of 65° across broad Reynolds number and Mach number ranges at the Langley National Transonic Facility (NTF). The model was fabricated with removable leading edges to permit testing of four leading-edge sets. The sets were designated as sharp, small, medium, and large, which corresponded to values of leading-edge radii normalized by the mean aerodynamic chord of 0, 0.05, 0.15, and 0.30 percent, respectively.

The experimental data for the sharp leading edge are presented in volume 1 of this report. The data for the small-, medium-, and large-radius leading edges are presented in volumes 2, 3, and 4, respectively, of this report. Wing pressure data are presented along with normal-force and pitching-moment coefficient data. Note that the primary objective of the force measurements was to monitor the safety of the model support system during the experiment; hence, the accuracy of the force measurements was of secondary importance.

Symbols

a, b, c, d	coefficients in first-blending function ϕ (appendix A)
b	wing span, 24 in.
C_m	pitching-moment coefficient about moment reference point, $\frac{\text{Pitching moment}}{q_\infty S \bar{c}}$
C_N	normal-force coefficient, $\frac{\text{Normal force}}{q_\infty S}$
C_p	pressure coefficient, $\frac{p - p_\infty}{q_\infty}$
c_R	root chord, 25.734 in.
\bar{c}	mean aerodynamic chord, 17.156 in.
F_N	normal force, lbf

l, m, n	coefficients in second-blending function ψ (appendix A)
M_Y	pitching moment, in-lbf
M_∞	free-stream Mach number
p	local pressure, psia
p_∞	free-stream static pressure, psia
p_T	free-stream total pressure, psia
q_∞	free-stream dynamic pressure, psf
R	Reynolds number
r	local radius
S	wing area, 2.145 ft ²
t_T	total temperature, °F
U	uncertainty
x	distance from apex, positive downstream, in.
x_0	initial longitudinal coordinate of blending function ϕ , in. (appendix A)
x_1	endpoint longitudinal coordinate of blending function ϕ , in. (appendix A)
y	spanwise distance from apex, positive right, in.
z	distance above X-Y plane, positive upward, in.
α	angle of attack, deg
γ	ratio of specific heats
η	$\frac{2y}{b_t}$
ξ	nondimensional distance parameter
ϕ	first-blending function (appendix A)
ψ	second-blending function (appendix A)

Abbreviations:

ESP	electronically scanned pressure
l	lower
L.E., le	leading edge
mac	mean aerodynamic chord
NTF	National Transonic Facility
starb'd	starboard
u	upper
l	local

Facility

The test was conducted in the Langley National Transonic Facility (NTF). The facility is a fan-driven, closed-circuit, cryogenic transonic pressure wind tunnel.

(See fig. 1.) The test section is 8.2 ft high by 8.2 ft wide by 25 ft long with a slotted ceiling and floor.

The NTF operating capability has a nominal Mach number range of 0.2 to 1.2, total pressure range of 15 to 120 psia, and total temperature range of -260°F to 150°F . The test gas may be dry air or nitrogen. A maximum unit Reynolds number of $146 \times 10^6 \text{ ft}^{-1}$ is achieved at a Mach number of 1.0. Independent control of pressure, temperature, fan speed, and inlet guide vane angle permits Mach number, Reynolds number, and dynamic pressure to be varied independently within the wind tunnel operational envelope.

To reduce turbulence, four antiturbulence screens were installed in the settling chamber, and a 15:1 contraction from settling chamber to nozzle throat was provided. To minimize wall interference, the test section floor and ceiling were set at 0° , model support walls at -1.76° , and reentry flaps at 0° . Acoustic treatment upstream and downstream of the fan was incorporated to reduce fan noise. More details of the wind tunnel physical characteristics and operations can be found in reference 14.

Model Description and Test Apparatus

The basic layout of the delta wing model is shown in figure 2(a). The wing has a leading-edge sweep of 65° , no twist or camber, and four sets of interchangeable leading edges, which attach to the flat plate part of the wing. The four leading-edge streamwise contours are illustrated in figure 2(b). The model root chord is 25.734 in., the wing span is 24 in., and the maximum wing thickness is 0.875 in. The wing was fabricated from VascoMax C-200,¹ which is suitable for cryogenic operation, and had a surface finish specification of 8 microinches. Figure 2(c) is a photograph of three of the leading-edge sets; one set is attached to the flat plate part of the model. With the exception of the seam at the plane of symmetry, where the left and right side leading edges are joined, each interchangeable leading-edge set (which includes part of the outboard trailing edge) was fabricated as one continuous piece of hardware. This eliminated the surface discontinuity typically associated with an upper and lower leading-edge surface parting line.

The wing and sting surfaces are represented by a fully analytical function with continuity through the second derivative and, hence, curvature. However, the wing-sting intersection line exhibits a discontinuity in slope across it. The leading- and trailing-edge cross-sectional shapes are constant spanwise except for a region near the wingtip where the two shapes intersect. A

¹Trademark of Teledyne Vasco.

detailed geometric description of the various regions of the delta wing and sting (fig. 3) is presented in appendix A. Unless otherwise noted, all quantities have been normalized by the wing root chord.

The model was supported (fig. 4(a)) at the aft end by the model sting, 10°-bent sting, and stub sting. The total model support system confined the center of rotation of the model to the center of the test section. The bent sting extended the positive angle-of-attack range up to approximately 30°.

The model had 183 surface static pressure ports with each having an inside diameter of 0.010 in. The orifice size selection was based on prior cryogenic model-testing experience (ref. 15) at the Langley 0.3-Meter Transonic Cryogenic Tunnel (0.3-m TCT). The majority of the ports were located on the upper surface of the right side (i.e., starboard side) of the model. They were located at nondimensional longitudinal stations of $x/c_R = 0.20, 0.40, 0.60, 0.80,$ and 0.95 . (See fig. 2(a).) At each chord station, the orifices were situated at constant fractions of local semispan so that they were aligned along rays emanating from the wing apex. The upper surface orifices were located every 5 percent of the local semispan out to one half of the local semispan, beyond which, they were spaced every 2.5 percent of the local semispan. The lower surface pressure ports were located on the left side (i.e., port side) of the model at the same longitudinal stations as on the starboard side. At each chord station, the lower surface orifices were located at local semispan stations of 0.20, 0.40, 0.60, 0.70, 0.80, 0.85, 0.90, and 0.95. In addition, orifices were located directly on both the port and starboard leading edges (except for the sharp leading-edge set) at every 10-percent root chord as well as at the 0.95-chord station. Pressure port location dimensions are shown in tables 1, 2, 3, and 4. Locations that did not have pressure ports are indicated by dashed-line entries.

Instrumentation

Surface static pressure measurements were obtained with four 48-port, 30-psid electronically scanned pressure (ESP) modules. Because of limited volume within the model and its immediate vicinity, the ESP modules were secured inside the enclosure of the wind tunnel pitch system downstream of the stub sting. These modules were placed in a heated container to ensure operation in a cryogenic environment. All model pressure tubes were routed downstream through the sting system and connected to the ESP modules.

Cryogenically rated strain gages configured for two moment bridges were installed on the model sting. These gages were used to monitor model support system safety during the test. One bridge was located at the wing

trailing-edge longitudinal station and the second 4 in. downstream of the wing trailing edge. In figure 4(b), note gage locations at the two rings around the sting just aft of the wing trailing edge. These gages were configured to Poisson ratio full bridges and were shielded from the free stream by a protective chemical coating. Normal force and pitching moment were calculated from measurements of these gages and reported as nondimensional coefficients.

Model angle of attack was determined from the wind tunnel arc-sector angles measured during the test and from sting bending characteristics that were obtained during pretest loadings. The sting fairing cavity volume was insufficient for installation of a fully heated onboard accelerometer package to measure inertial model angles during cryogenic operation.

Measurement Accuracy

The Beattie-Bridgman gas model (ref. 16) and the quoted specifications for the instrumentation were applied to approximate the accuracies of the test parameters and the aerodynamic coefficients. The technique of Kline and McClintock, as specified by Holman (ref. 17), was used to calculate the coefficient accuracies. The uncertainties U of the measurements of the normal-force coefficient C_N , pitching-moment coefficient C_m , pressure coefficient C_p , and free-stream Mach number M_∞ depend on the uncertainties of their respective primary measurements. Estimates of measurement accuracies are presented in appendix B.

The quoted accuracy of an ESP module is ± 0.1 percent of the instrument maximum pressure. Therefore, the accuracy of the 30-psid ESP modules used in this test is ± 0.03 psid.

Data Reduction and Corrections

Data reduction methods used for the pressure data and wind tunnel parameters were those outlined in reference 16. To obtain force and moment data, the strain gages on the sting were treated as two-component strain gage balances in the data reduction procedure. (See ref. 18.) Because the Reynolds number range was achieved at only two test temperatures for the various total pressures, aeroelastic effects (i.e., model deformation due to pressure) can distort the true Reynolds number effects. However, the aeroelastic effect on the aerodynamic data is small because of the relatively high stiffness resulting from the model thickness and low-aspect-ratio planform as well as the support system structure as illustrated in figure 4(a). Measurements for an inverted model attitude were not taken, and a nominal

flow angularity correction of $+0.13^\circ$ (upflow) was applied to the reported angles of attack.

Test Program

Figure 5 shows the combinations of Reynolds numbers and free-stream Mach numbers used for the test. The test matrix shows that a Mach number of 0.85 was selected for the study of the Reynolds number effects and that a Reynolds number of 6×10^6 was selected for the study of the Mach number effects. All data were obtained with free boundary layer transition.

Data Presentation

Pressure data measured on the delta wing are presented for each data point in tabular and graphical formats in appendixes C and D. Normal-force and pitching-moment data for each angle of attack are presented in figures 6 and 7. The moment reference point was located at two thirds of the root chord aft of the wing apex. The angle of attack ranged nominally from -1° to 27° .

Wing pressure coefficients are tabulated for each data point and accompanied by a surface pressure distribution plot and a leading-edge pressure plot. The degree of similarity between the port and starboard leading-edge pressure plots indicates the extent of flow symmetry. Note that a coefficient value represented by a series of asterisks in tables C1-C3 and D1-D6 is either an

unrecorded or an apparently erroneous pressure port measurement.

The pressure coefficient data test matrix is presented in table 5 for a Reynolds number range of 6×10^6 to 36×10^6 at $M_\infty = 0.85$ in appendix C and for a Mach number range of 0.40 to 0.90 at a Reynolds number of 6×10^6 in appendix D.

Summary Remarks

Pressure data obtained from a 65° delta wing with the sharp leading edge (i.e., 0 percent of mac) are presented in the form of surface pressure plots and leading-edge pressure plots for a Reynolds number range at a Mach number of 0.85 and a Mach number range at a Reynolds number of 6×10^6 . Although upper and lower surface pressures were measured on opposite sides of the model, model symmetry permitted pressure distribution plots to be superimposed on a sketch of the half wing. The plots of leading-edge pressures indicate the extent of flow symmetry by comparing port and starboard leading-edge pressures. Normal-force and pitching-moment coefficient plots for Reynolds number and Mach number ranges are also presented.

NASA Langley Research Center
Hampton, VA 23681-0001
August 11, 1995

Table 1. Wing Upper Surface Pressure Port Locations on Starboard Side

η	x/c_R of—									
	0.20		0.40		0.60		0.80		0.95	
	x, in.	y, in.	x, in.	y, in.	x, in.	y, in.	x, in.	y, in.	x, in.	y, in.
0.050	5.147	0.120	10.294	0.240	15.440	0.360	-----	-----	-----	-----
.100	↓	.240	↓	.480	↓	.720	-----	-----	-----	-----
.150	↓	.360	↓	.720	↓	1.080	-----	-----	-----	-----
.200	↓	.480	↓	.960	↓	1.440	-----	-----	24.447	2.280
.250	-----	-----	↓	1.200	↓	1.800	20.587	2.400	↓	2.850
.300	5.147	.720	↓	1.440	↓	2.160	↓	2.880	↓	3.420
.350	↓	.840	↓	1.680	↓	2.520	↓	3.360	↓	3.990
.400	↓	.960	↓	1.920	↓	2.880	↓	3.840	↓	4.560
.450	↓	1.080	↓	2.160	↓	3.240	↓	4.320	↓	5.130
.500	↓	1.200	↓	2.400	↓	3.600	↓	4.800	↓	5.700
.525	-----	-----	↓	2.520	↓	3.780	↓	5.040	↓	5.985
.550	5.147	1.320	↓	2.640	↓	3.960	↓	5.280	↓	6.270
.575	-----	-----	↓	2.760	↓	4.140	↓	5.520	↓	6.550
.600	5.147	1.440	↓	2.880	↓	4.320	↓	5.760	↓	6.840
.625	-----	-----	-----	-----	↓	4.500	↓	6.000	↓	7.125
.650	5.147	1.560	10.294	3.120	↓	4.680	↓	6.240	↓	7.410
.675	-----	-----	↓	3.240	↓	4.860	↓	6.480	↓	7.695
.700	5.147	1.680	↓	3.360	↓	5.040	↓	6.720	↓	7.980
.725	-----	-----	↓	3.480	↓	5.220	↓	6.960	↓	8.265
.750	5.147	1.800	↓	3.600	-----	-----	↓	7.200	↓	8.550
.775	-----	-----	↓	3.720	15.440	5.580	↓	7.440	↓	8.835
.800	5.147	1.920	↓	3.840	↓	5.760	↓	7.680	↓	9.120
.825	-----	-----	↓	3.960	↓	5.940	↓	7.920	↓	9.405
.850	5.147	2.040	↓	4.080	↓	6.120	↓	8.160	↓	9.690
.875	-----	-----	↓	4.200	↓	6.300	↓	8.400	↓	9.975
.900	5.147	2.160	↓	4.320	↓	6.480	↓	8.640	↓	10.260
.925	-----	-----	↓	4.440	↓	6.660	↓	8.880	↓	10.545
.950	5.147	2.280	↓	4.560	↓	6.840	↓	9.120	↓	10.830
.975	-----	-----	↓	4.680	↓	7.020	↓	9.360	↓	11.115
1.000	-----	-----	-----	-----	-----	-----	-----	-----	-----	-----

Table 2. Wing Upper Surface Pressure Port Locations on Port Side

η	x/c_R of—									
	0.20		0.40		0.60		0.80		0.95	
	x, in.	y, in.	x, in.	y, in.	x, in.	y, in.	x, in.	y, in.	x, in.	y, in.
-0.900	5.147	-2.160	-----	-----	-----	-----	-----	-----	-----	-----
-.950	-----	-----	10.294	-4.560	15.440	-6.840	20.587	-9.120	24.447	-10.830

Table 3. Wing Lower Surface Pressure Port Locations on Port Side

η	x/c_R of—									
	0.20		0.40		0.60		0.80		0.95	
	x, in.	y, in.	x, in.	y, in.	x, in.	y, in.	x, in.	y, in.	x, in.	y, in.
-0.200	5.147	-0.480	10.294	-0.960	15.440	-1.440	-----	-----	24.447	-2.280
-.400	↓	-.960	↓	-1.920	↓	-2.880	20.587	-3.840	↓	-4.560
-.600	↓	-1.440	↓	-2.880	↓	-4.320	↓	-5.760	↓	-6.840
-.700	↓	-1.680	↓	-3.360	↓	-5.040	↓	-6.720	↓	-7.980
-.800	↓	-1.920	↓	-3.840	↓	-5.760	↓	-7.680	↓	-9.120
-.850	↓	-2.040	↓	-4.080	↓	-6.120	↓	-8.160	↓	-9.690
-.900	↓	-2.160	↓	-4.320	↓	-6.480	↓	-8.640	↓	-10.260
-.950	↓	-2.280	↓	-4.560	↓	-6.840	↓	-9.120	↓	-10.830
-.975	-----	-----	↓	-4.680	↓	-7.020	↓	-9.360	↓	-11.115
-1.000	-----	-----	-----	-----	-----	-----	-----	-----	-----	-----

Table 4. Wing Lower Surface Pressure Port Locations on Starboard Side

η	x/c_R of—									
	0.20		0.40		0.60		0.80		0.95	
	x, in.	y, in.	x, in.	y, in.	x, in.	y, in.	x, in.	y, in.	x, in.	y, in.
0.900	5.147	2.160	-----	-----	-----	-----	-----	-----	-----	-----
.950	-----	-----	10.294	4.560	15.440	6.840	20.587	9.120	24.447	10.830

Table 5. Pressure Coefficient Data Test Matrix for Sharp Leading Edge

Appendix table	Run	Mach	R_{mac}	q_∞ , psf	t_p , °F
C1	88	0.85	6×10^6	722	120
C2	83	.85	12	1444	120
C3	93	.85	36	1035	-250
D1	84	.40	6	387	120
D2	85	.60	↓	555	↓
D3	86	.80	↓	692	↓
D4	87	.83	↓	710	↓
D5	89	.87	↓	733	↓
D6	90	.90	↓	750	↓

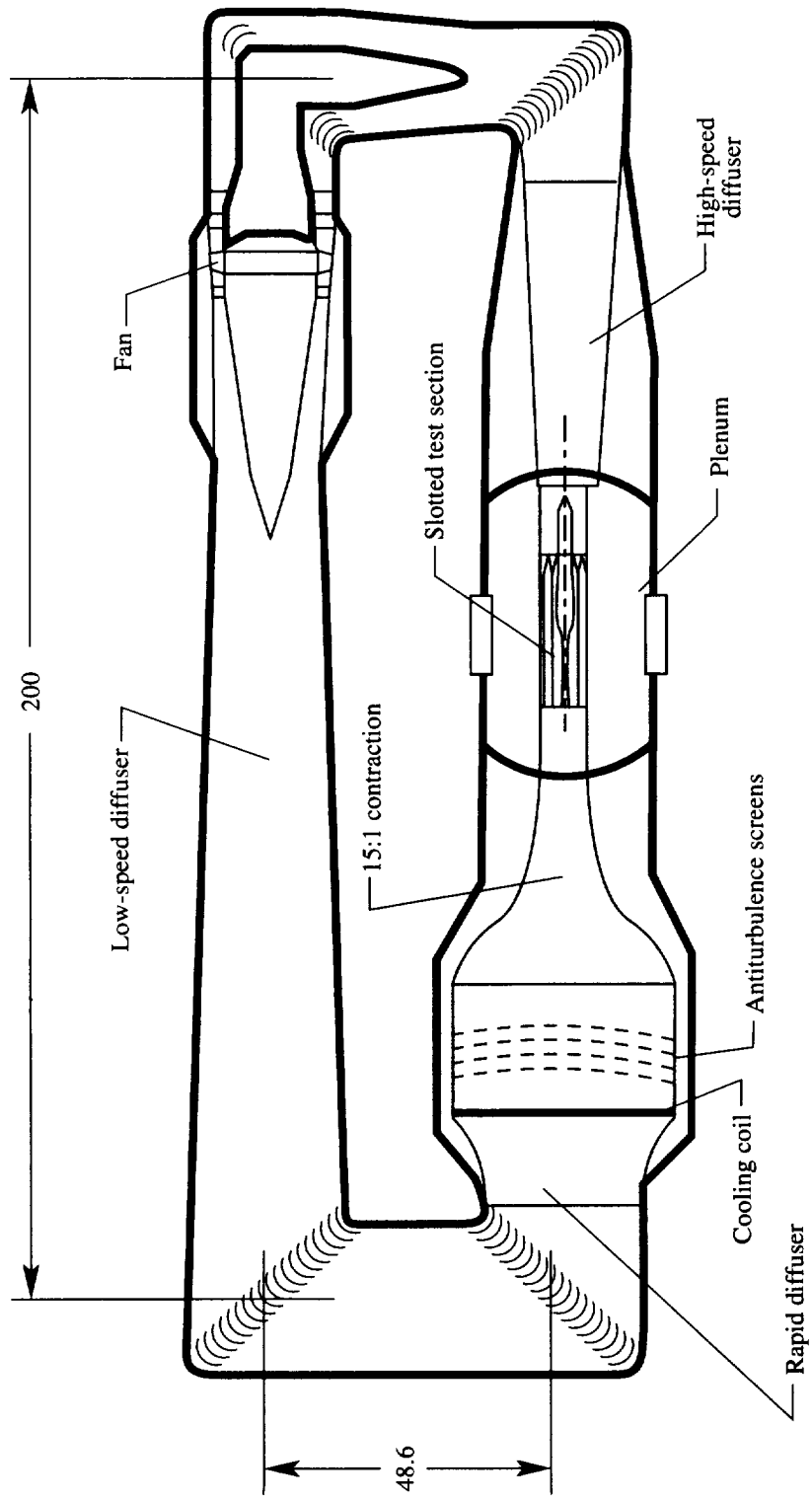
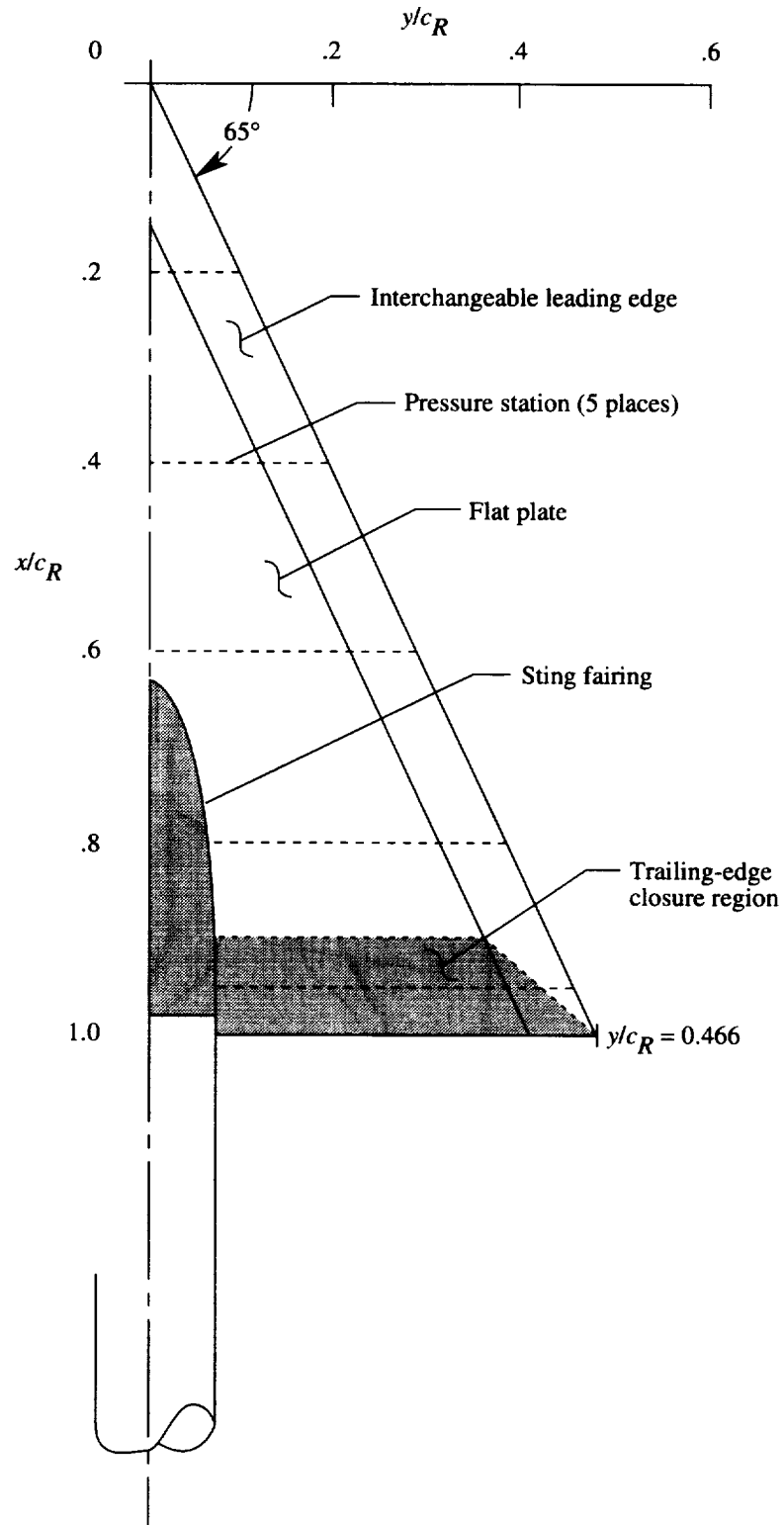
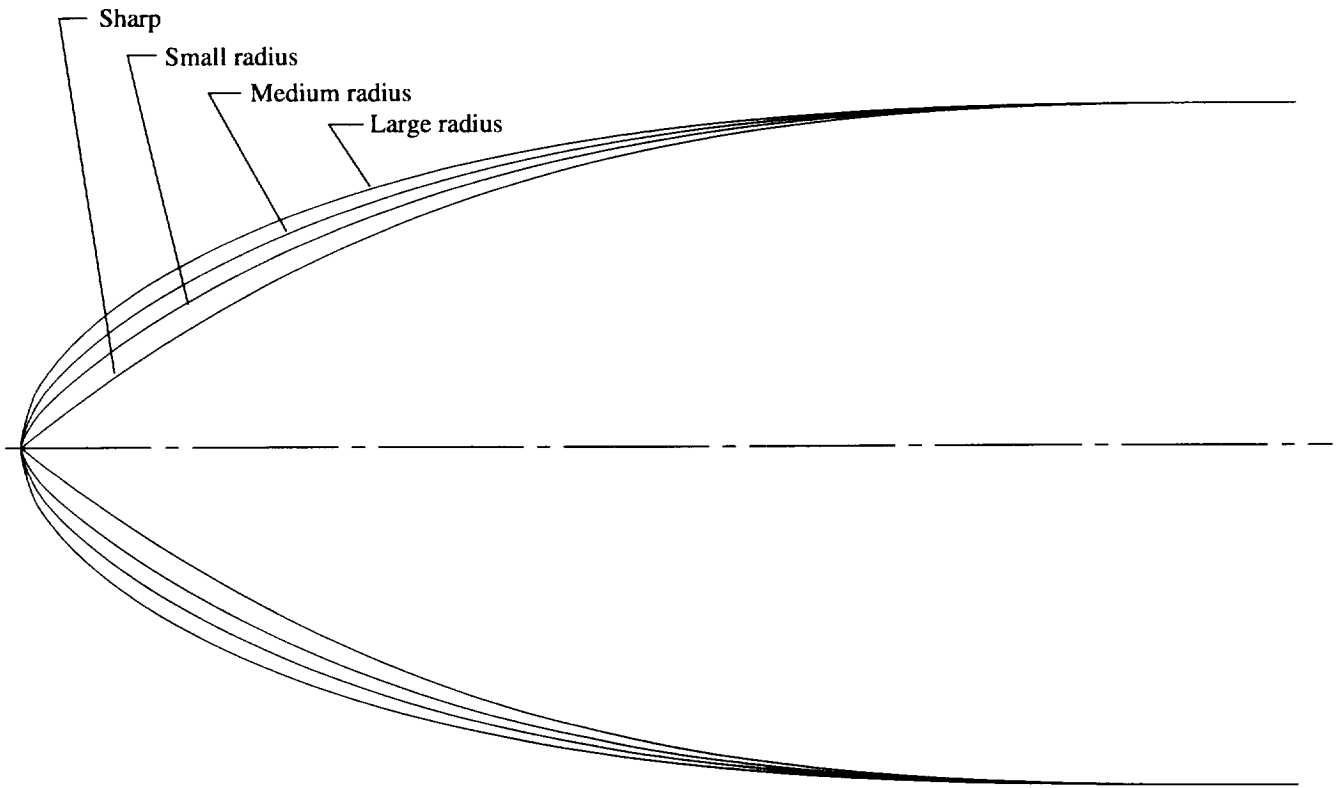

Figure 1. Langley National Transonic Facility circuit. Linear dimensions are in feet.



(a) Model configuration.

Figure 2. Delta wing model.



(b) Streamwise leading-edge contours (not to scale).

Figure 2. Continued.

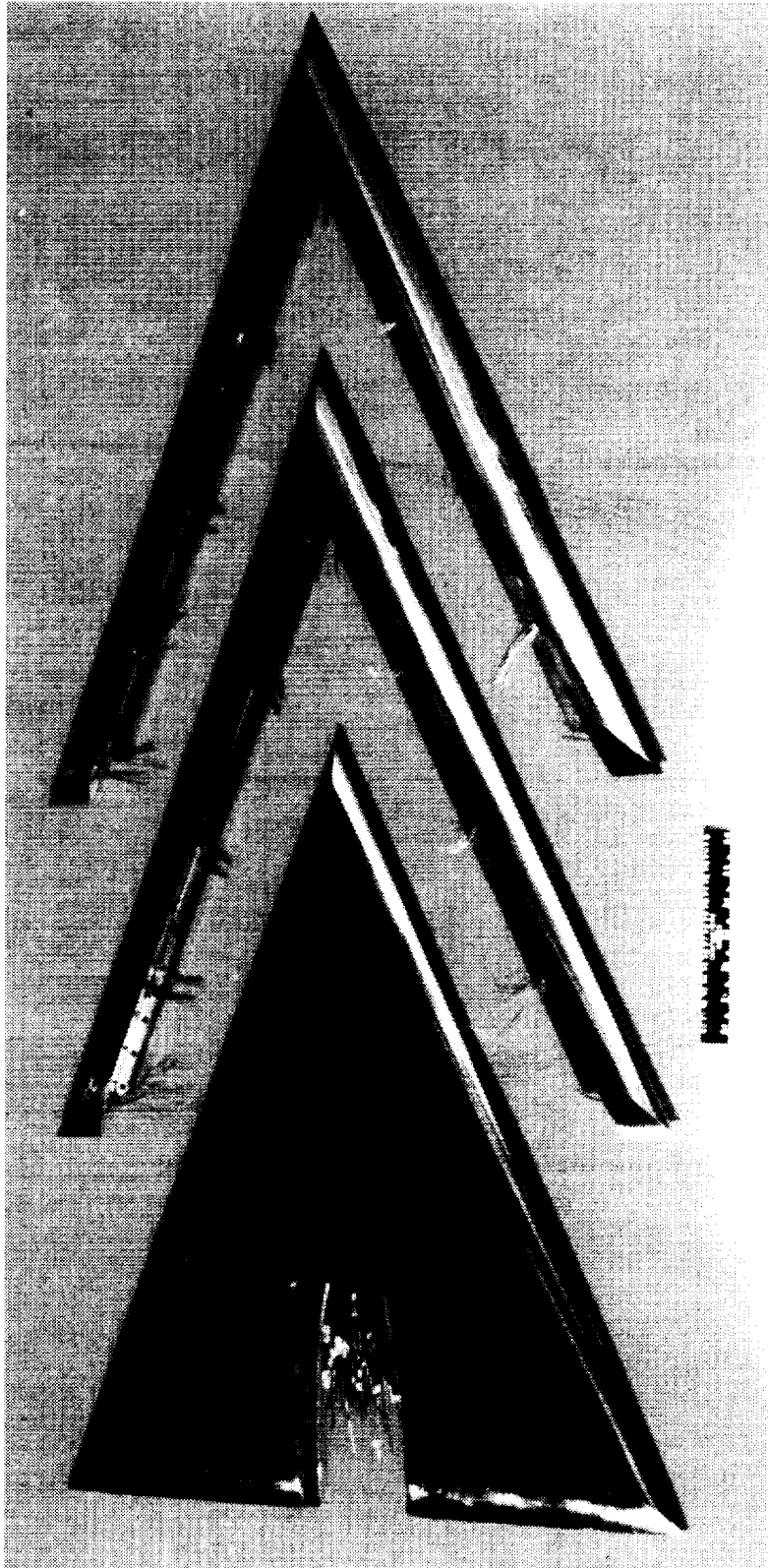

L-88-9911

(c) Model with three leading-edge sets.

Figure 2. Concluded.

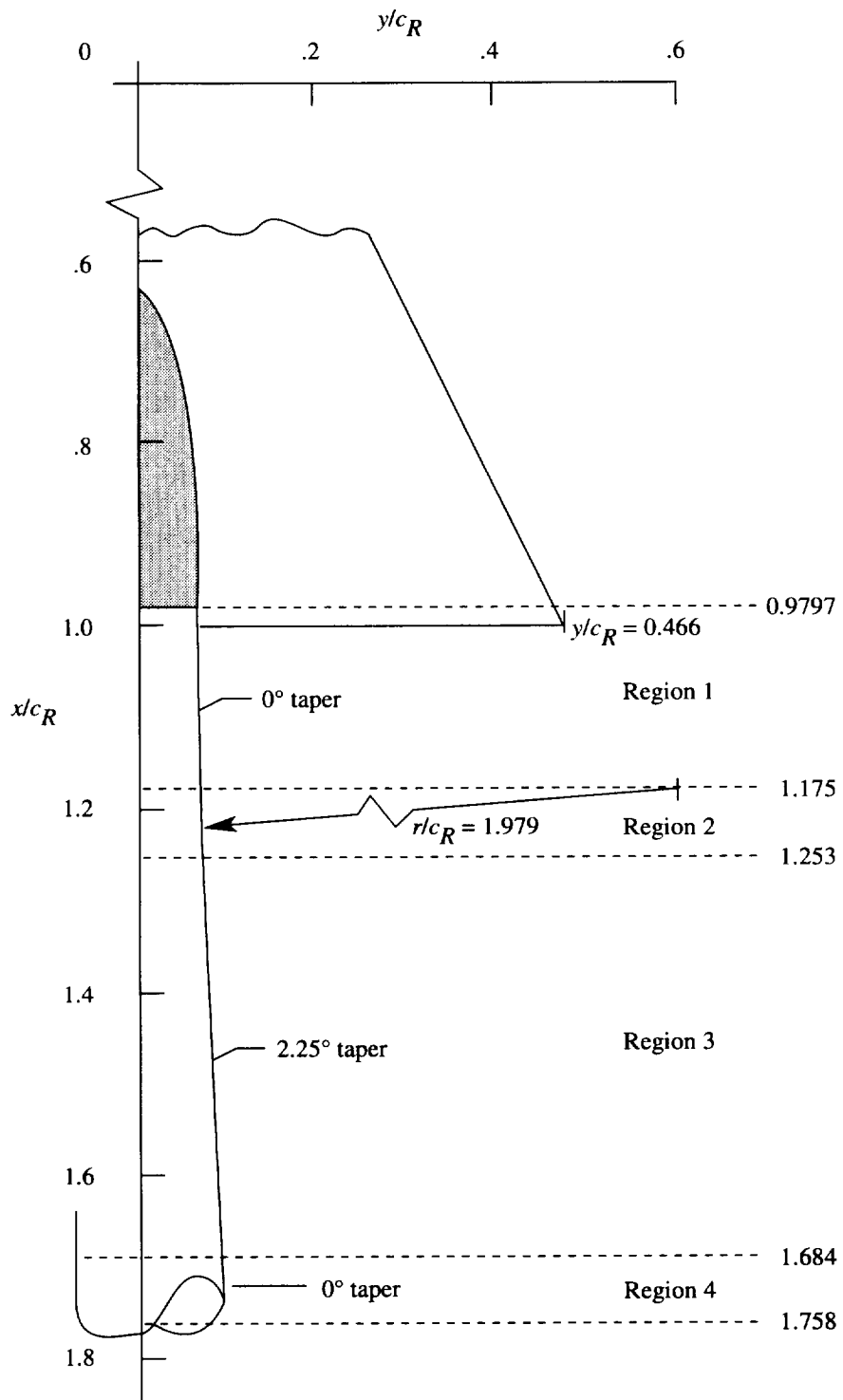
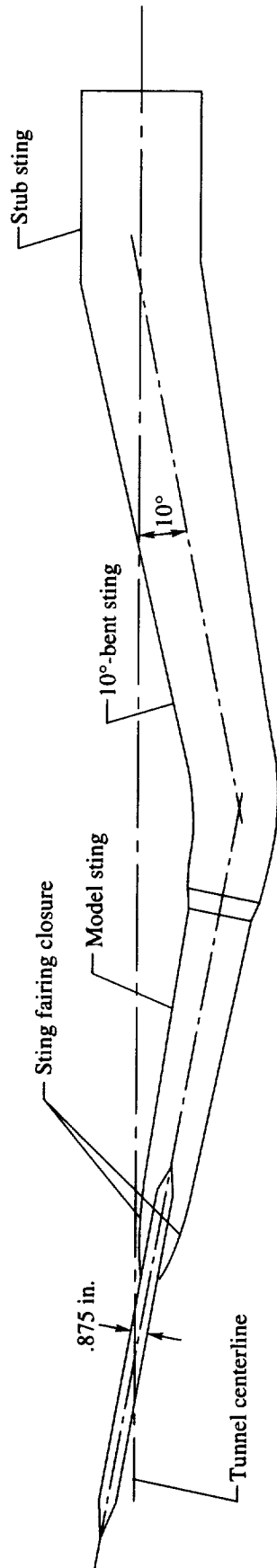
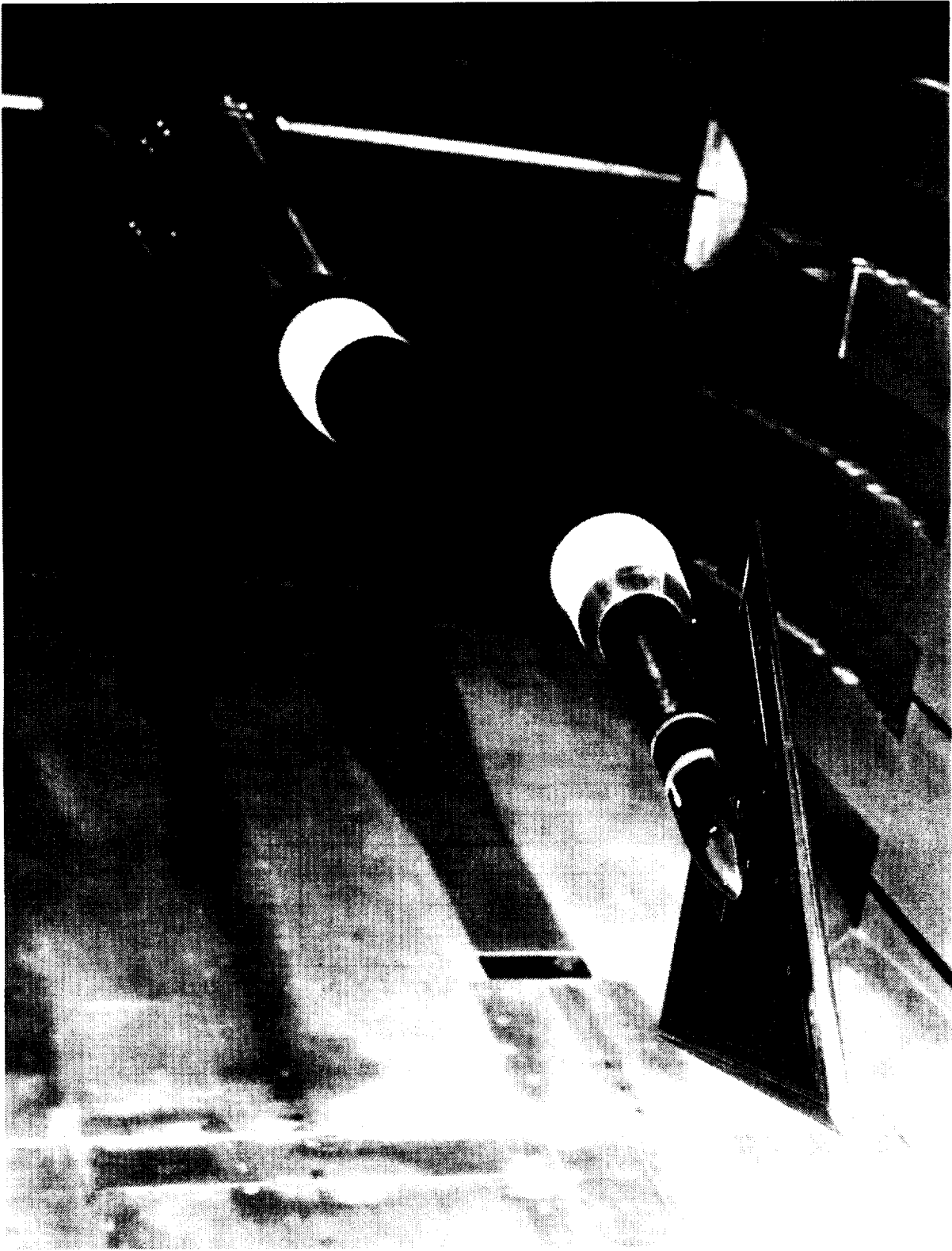

Figure 3. Delta wing model fore-sting detail.



(a) Model and sting system profile.

Figure 4. The 65° delta wing model assembly and support system.



L-91-6963

(b) Installation in Langley National Transonic Facility.

Figure 4. Concluded.

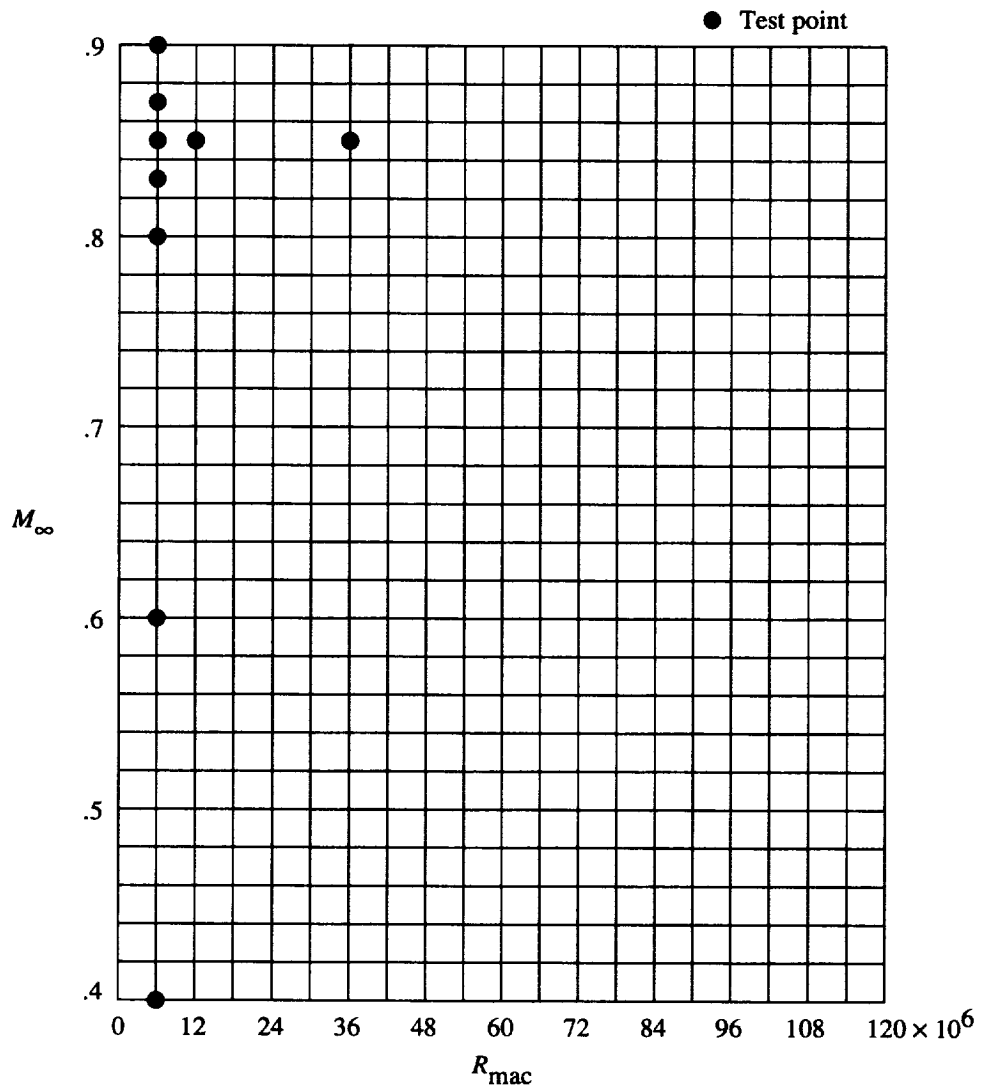
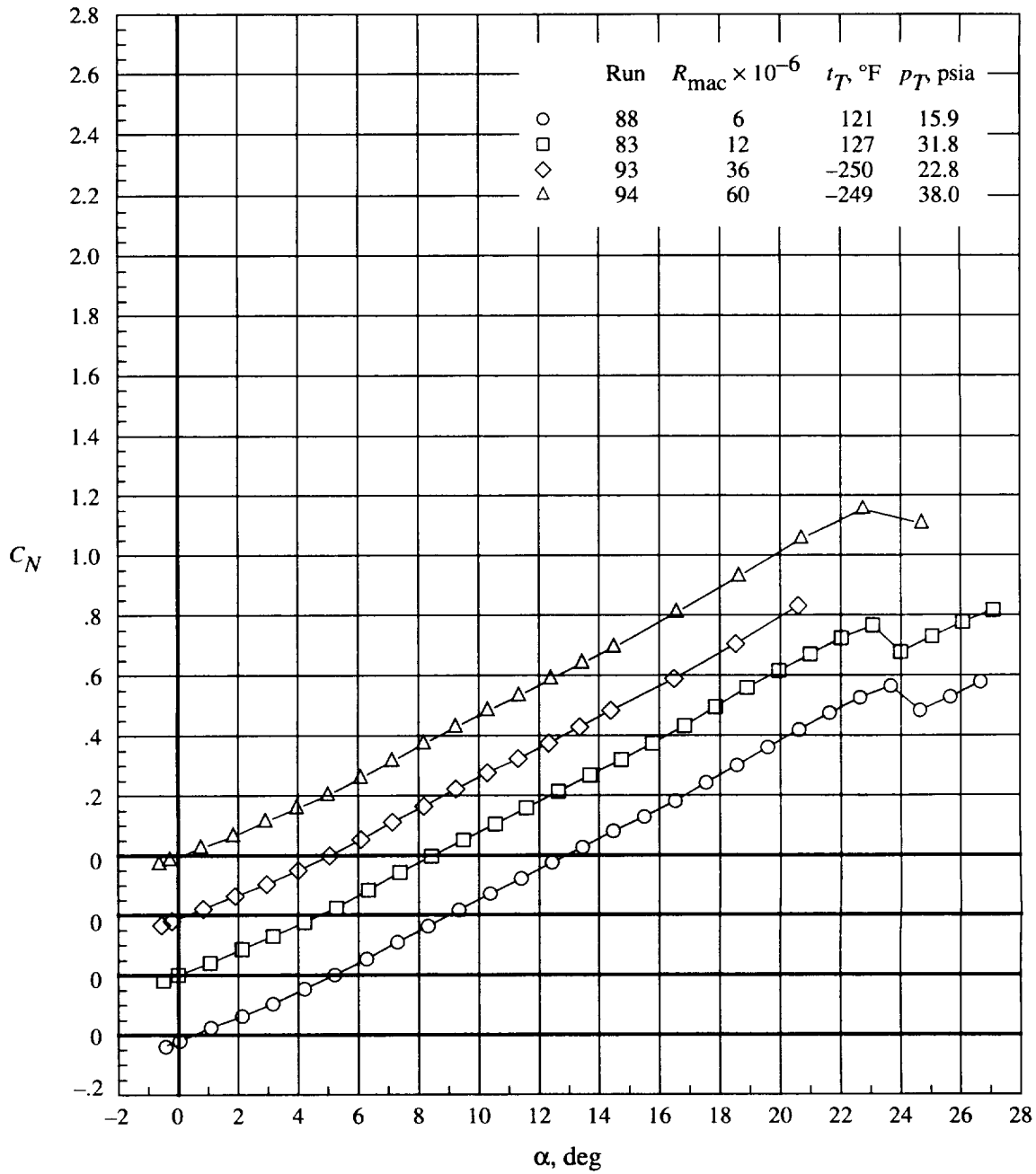
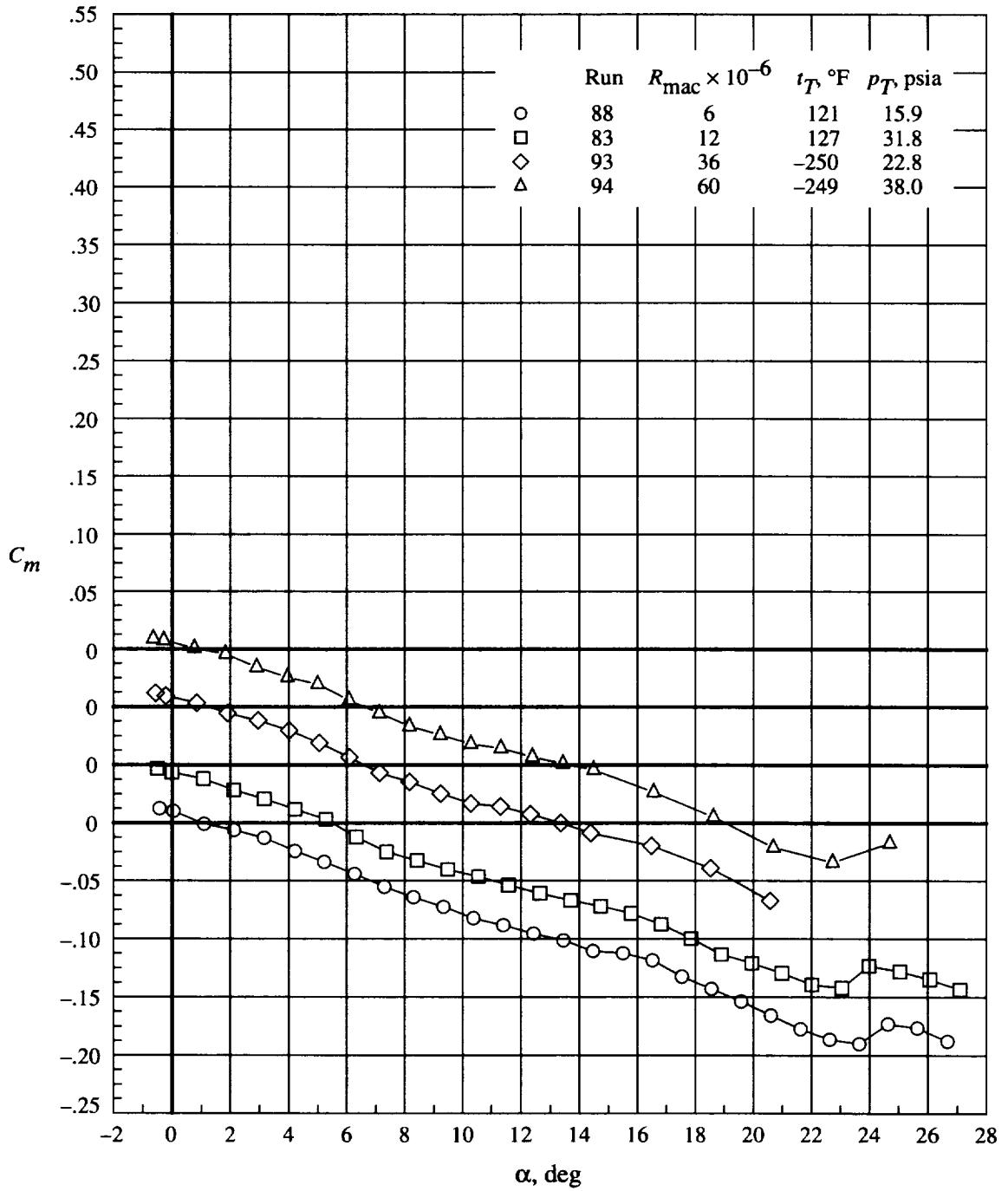

Figure 5. Test matrix for 65° delta wing with sharp leading edge.



(a) C_N versus α .

Figure 6. Normal-force and pitching-moment coefficients at angles of attack for wing with sharp leading edge. $M_\infty \approx 0.85$.



(b) C_m versus α .

Figure 6. Concluded.

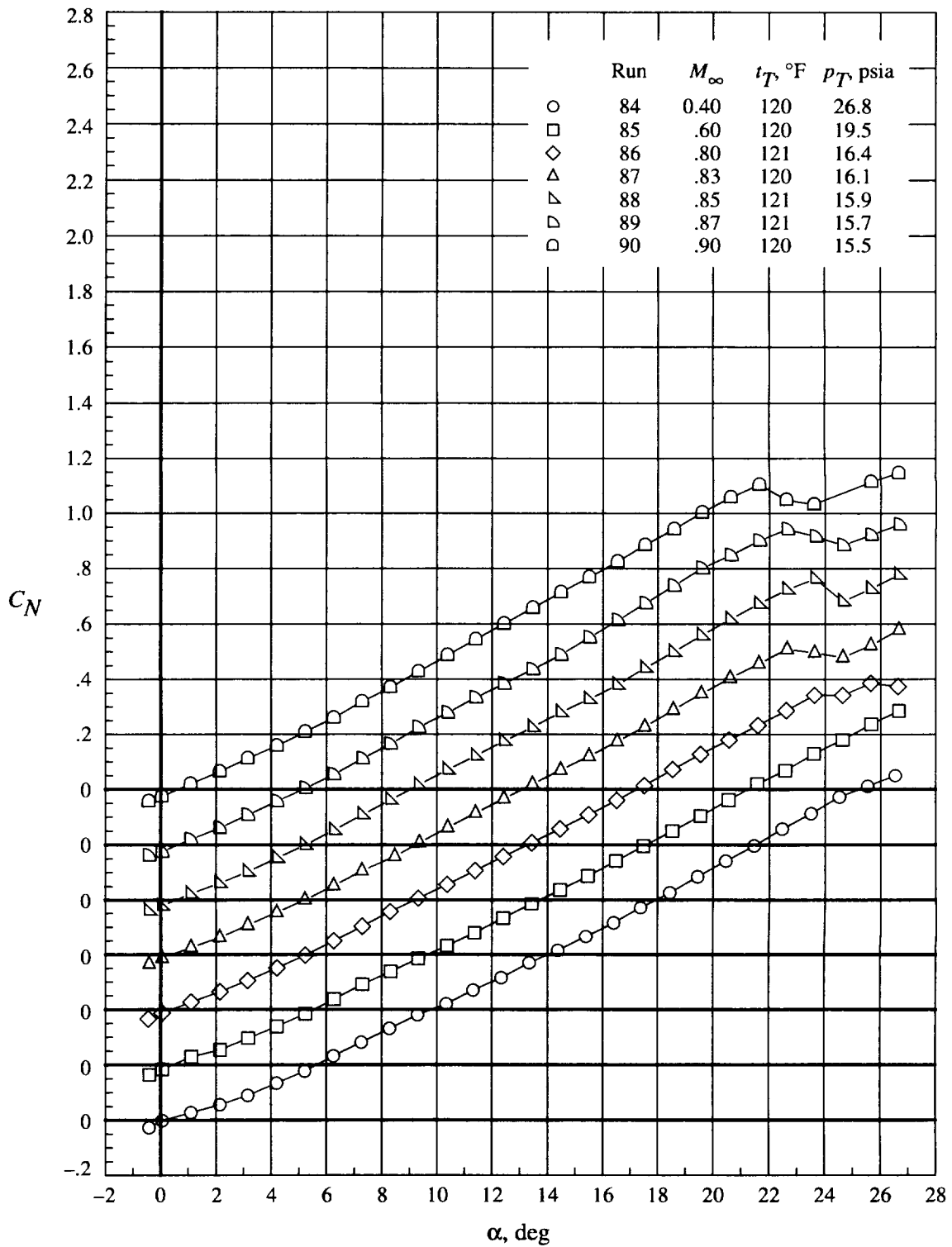

(a) C_N versus α .

Figure 7. Normal-force and pitching-moment coefficients at angles of attack for wing with sharp leading edge.
 $R_{\text{mac}} \approx 6 \times 10^6$.

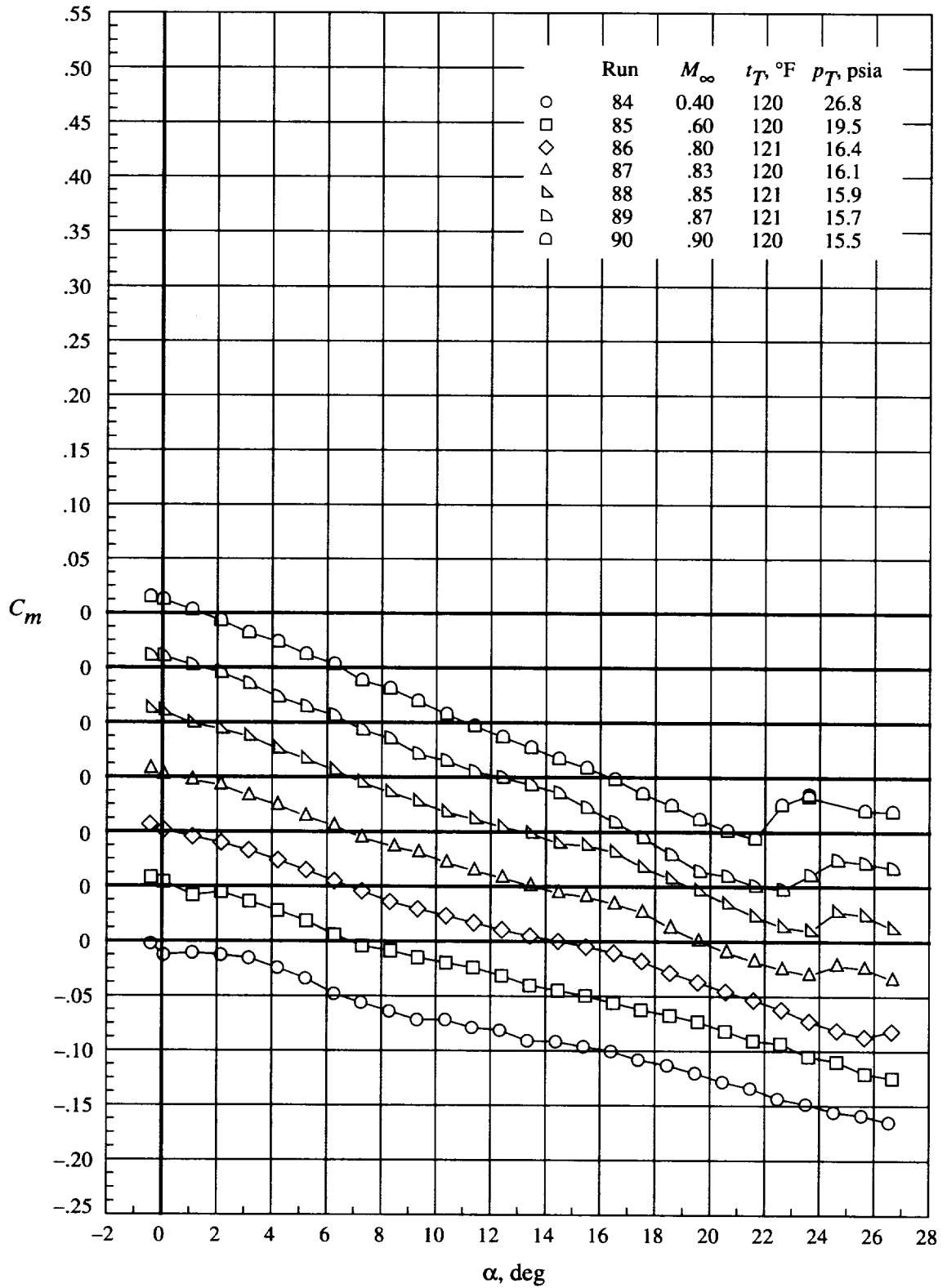

(b) C_m versus α .

Figure 7. Concluded.

Appendix A

Delta Wing and Near-Field Sting Analytical Definition

General equations were used to define the leading-edge semithickness, the flat plate semithickness, the trailing-edge closure semithickness, and the transverse radius of the sting fairing. The equation ϕ defines the particular shape of interest (e.g., the leading-edge contour) and the equation ψ defines the boundary conditions (at $\xi = 1$) for ϕ . Details are as follows:

$$\xi = (x - x_0)/x_1 \quad (\text{A1})$$

$$\phi(\xi) = \pm x_1 \left(a\sqrt{\xi} + b\xi + c\xi^2 + d\xi^3 \right) \quad (0 \leq \xi \leq 1) \quad (\text{A2})$$

$$\psi(\xi) = \pm x_1 \left[\frac{l}{x_1} + m(\xi - 1) + \frac{nx_1}{2}(\xi - 1)^2 \right] \quad (1 \leq \xi) \quad (\text{A3})$$

The second-blending function ψ is defined such that

$$\psi|_{\xi=1} = l \quad \frac{d\psi}{dx}|_{\xi=1} = m \quad \frac{d^2\psi}{dx^2}|_{\xi=1} = n$$

The two functions ϕ and ψ are illustrated in figure A1 for the leading-edge semithickness case where $x_0 = x_{1e}$.

The general analytical expressions for the coefficients in equation (A2) follow:

$$\begin{aligned} a &= \sqrt{\frac{2r}{x_1}} \\ b &= -\frac{15}{8}a + 3\frac{l}{x_1} - 2m + \frac{nx_1}{2} \\ c &= \frac{5}{4}a - 3\frac{l}{x_1} + 3m - nx_1 \\ d &= -\frac{3}{8}a + \frac{l}{x_1} - m + \frac{nx_1}{2} \end{aligned}$$

With these expressions

$$\phi(1) = \psi(1) \quad \phi'(1) = \psi'(1) \quad \phi''(1) = \psi''(1)$$

and the leading-edge radius at $\xi = 0$ is r . Curvature is also continuous at $\xi = 1$.

For the delta wing model of this study, the flat plate part represented by ψ results in both m and n being zero. The reduced coefficients are

$$\begin{aligned} a &= \sqrt{\frac{2r}{x_1}} \\ b &= -\frac{15}{8}a + 3\frac{l}{x_1} \\ c &= \frac{5}{4}a - 3\frac{l}{x_1} \\ d &= -\frac{3}{8}a + \frac{l}{x_1} \end{aligned}$$

For a sharp leading edge, the radius $r = 0$ and the coefficients further reduce to

$$\begin{aligned} a &= 0 \\ b &= 3\frac{l}{x_1} \\ c &= -3\frac{l}{x_1} \\ d &= \frac{l}{x_1} \end{aligned}$$

Specific numerical values follow for the delta wing in subsequent discussions.

Leading Edges

The streamwise leading-edge contours are designed to give leading-edge radii of 0, 0.05, 0.15, and 0.30 percent of the mean aerodynamic chord and to match the flat plate wing at a streamwise distance of 15 percent of the root chord aft of the leading edge with continuity through the second derivative. The longitudinal coordinate of the leading edge is x_{1e} and the leading-edge contour is described by equation (A2), the coefficients in table A1, and the following definitions:

$$\begin{aligned} x_0 &= x_{1e} \\ x_1 &= 0.15 \end{aligned}$$

Flat Plate

The flat plate center part of the wing has a uniform thickness. The equation for the semithickness is as follows:

$$\begin{aligned} x_0 &= x_{1e} + 0.15 \\ x_1 &= 0.9 - x_0 \end{aligned}$$

$$\phi(\xi) = \pm 0.0170008 \quad (0 \leq \xi \leq 1)$$

Trailing-Edge Closure Region

The streamwise trailing-edge closure is designed to produce a sharp trailing edge and to match the flat plate wing at the 90-percent root chord station with continuity through the second derivative. The closure is described by equation (A2), the coefficients in table A2, and the following definitions:

$$x_0 = 1$$

$$x_1 = 0.10$$

Sting Fairing

The sting is a body of revolution and the sting fairing is designed to emerge from the wing slightly aft of the 60-percent root chord station and to match the constant-radius part of the sting slightly ahead of the wing trailing edge. The transverse radius of the sting fairing is

described by equation (A2), the coefficients in table A3, and the following definitions:

$$x_0 = 0.61057051$$

$$x_1 = 0.36916023$$

Fore-Sting

As shown in figure 3, the downstream continuation of the sting in the near field of the wing is referred to as the fore-sting. It can be subdivided into the four regions listed in table A4 for the purpose of defining the sting transverse radius ϕ . In region 2, the sting transverse radius increases by the radius of curvature equal to 1.979 from $x/c_R = 1.175$. (See fig. 3.) Beyond region 4, the actual sting geometry becomes more complex. For computational purposes, the sting could be either extended as is or closed out in a convenient fashion.

Table A1. Leading-Edge Coefficients for Equation (A2)

r/\bar{c} , percent	a	b	c	d
0	0	$3d$	$-b$	0.1133386669
.05	0.06666666666667	0.21501600073802	-0.25668266740469	.08833866691267
.15	.11547005383792	.12350964979191	-.19567843344062	.07003739672345
.30	.16329931618554	.03382978289013	-.13589185550609	.05210142334309

Table A2. Trailing-Edge Coefficients for Equation (A2)

r/\bar{c} , percent	a	b	c	d
0	0	$3d$	$-b$	0.17000800036901

Table A3. Sting Fairing Coefficients for Equation (A2)

r/\bar{c} , percent	a	b	c	d
0.27910261994295	0.10040234847327	0.33279822819157	-0.39554969598736	0.13603332984884

Table A4. Fore-Sting Transverse Radius ϕ

Region	Taper, deg	x/c_R	ϕ
1	0	From 0.9797	0.06412
		To 1.175	0.06412
2		From 1.175	0.06412
		To 1.253	0.06564
3	2.25	From 1.253	0.06564
		To 1.684	0.08258
4	0	From 1.684	0.08258
		To 1.758	0.08258

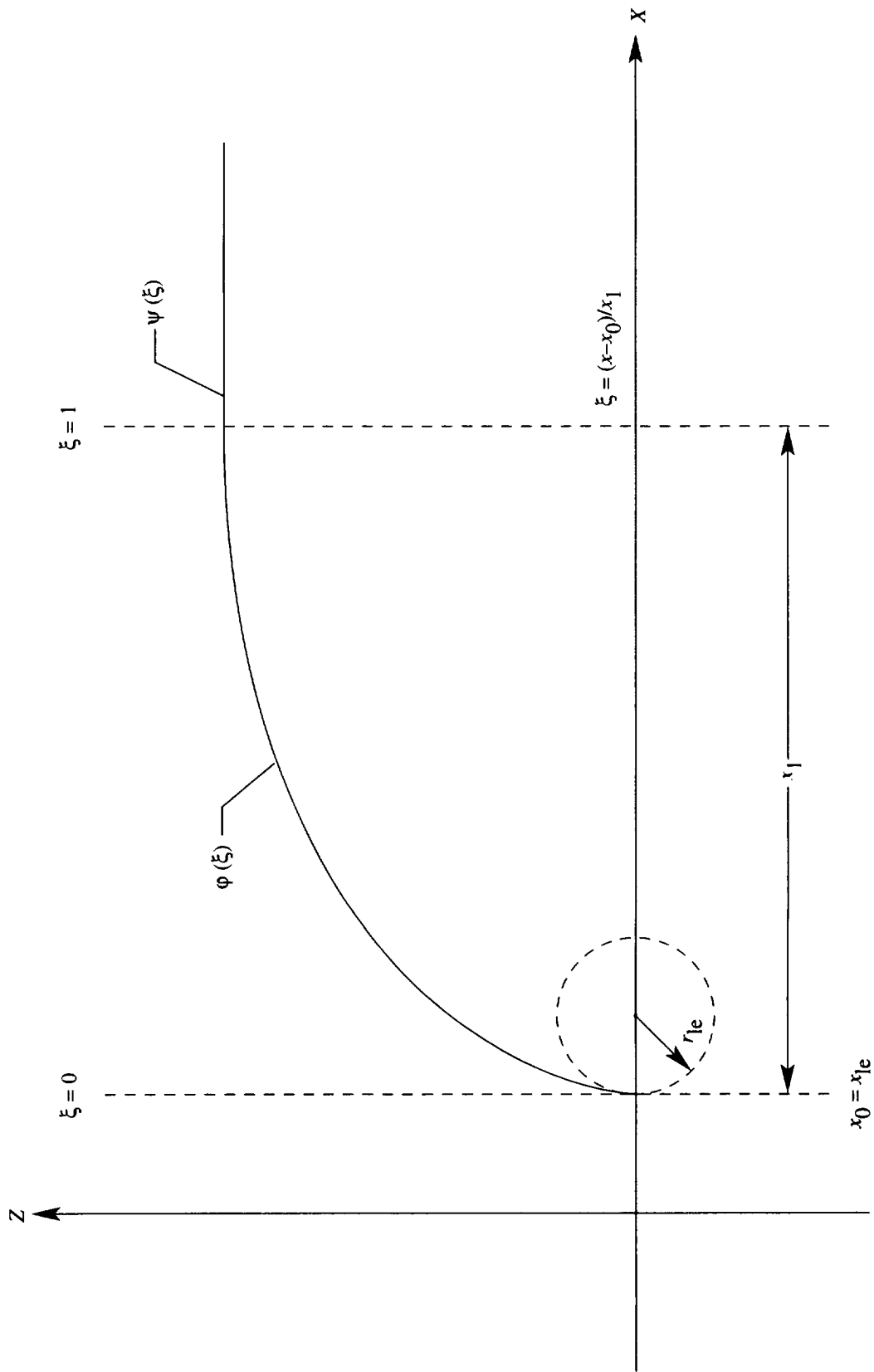

Figure A1. Delta wing semithickness functions.

Appendix B

Data Uncertainty

The uncertainties U of the measurements of the normal-force coefficient C_N , pitching-moment coefficient C_m , pressure coefficient C_p , and free-stream Mach number M_∞ depend on the uncertainties of their respective primary measurements.

The coefficients C_N , C_m , and C_p (Mach number is discussed separately) are derived by

$$C_N = \frac{F_N}{q_\infty S} \quad (B1)$$

$$C_m = \frac{M_Y}{q_\infty S \bar{c}} \quad (B2)$$

$$C_p = \frac{p - p_\infty}{q_\infty} \quad (B3)$$

The primary measurements used to define these coefficients are the normal force F_N , pitching moment M_Y , surface local static pressure p , free-stream static pressure p_∞ , and free-stream total pressure p_T . The free-stream static pressure and the free-stream total pressure are used to compute the free-stream Mach number, which, in turn, is used to compute the free-stream dynamic pressure q_∞ .

The free-stream dynamic pressure that accounts for the compressibility effect in high-speed flow is defined as

$$q_\infty = \frac{1}{2} \gamma p_\infty M_\infty^2 \quad (B4)$$

where γ denotes the ratio of specific heats. Substitutions for the dynamic pressure in the normal-force, pitching-moment, and pressure coefficient equations (B1), (B2), and (B3), respectively, give

$$C_N = \frac{F_N}{\frac{1}{2} \gamma p_\infty M_\infty^2 S} \quad (B5)$$

$$C_m = \frac{M_Y}{\frac{1}{2} \gamma p_\infty M_\infty^2 S \bar{c}} \quad (B6)$$

$$C_p = \frac{p - p_\infty}{\frac{1}{2} \gamma p_\infty M_\infty^2} \quad (B7)$$

The Mach number, which is not a primary measurement, is derived from the free-stream static and total pressures and the ratio of specific heats. Thus,

$$M_\infty = \left\{ \frac{2}{\gamma - 1} \left[\left(\frac{p_\infty}{p_T} \right)^{-(\gamma - 1)/\gamma} - 1 \right] \right\}^{1/2} \quad (B8)$$

The coefficients are then functions of the following measured variables: the normal force, the pitching moment, the local pressure, the free-stream static pressure, and the free-stream Mach number; the Mach number is a function of the free-stream static pressure and the free-stream total pressure (i.e., stagnation pressure). The uncertainties $U(\cdot)$ of these primary measured variables are presented in table B1.

Table B1. Data Uncertainties

Variable	Uncertainty
$U(F_N)$, lbf	<24.0
$U(M_Y)$, in-lbf	<46.8
$U(p)$, lbf/in ²	<0.03
$U(p_T)$, lbf/in ²	<0.01
$U(p_\infty)$, lbf/in ²	<0.02

The probability of the value of each uncertainty being correct is assumed to be the same. From reference 17, the uncertainty for each of the coefficients of equations (B5)–(B8) with the same probability is

$$U(C_N) = \left\{ \left[\frac{\partial C_N}{\partial F_N} U(F_N) \right]^2 + \left[\frac{\partial C_N}{\partial p_\infty} U(p_\infty) \right]^2 + \left[\frac{\partial C_N}{\partial M_\infty} U(M_\infty) \right]^2 \right\}^{1/2} \quad (B9)$$

$$U(C_m) = \left\{ \left[\frac{\partial C_m}{\partial M_Y} U(M_Y) \right]^2 + \left[\frac{\partial C_m}{\partial p_\infty} U(p_\infty) \right]^2 + \left[\frac{\partial C_m}{\partial M_\infty} U(M_\infty) \right]^2 \right\}^{1/2} \quad (B10)$$

$$U(C_p) = \left\{ \left[\frac{\partial C_p}{\partial p} U(p) \right]^2 + \left[\frac{\partial C_p}{\partial p_\infty} U(p_\infty) \right]^2 + \left[\frac{\partial C_p}{\partial M_\infty} U(M_\infty) \right]^2 \right\}^{1/2} \quad (B11)$$

$$U(M_\infty) = \left\{ \left[\frac{\partial M_\infty}{\partial p_\infty} U(p_\infty) \right]^2 + \left[\frac{\partial M_\infty}{\partial p_T} U(p_T) \right]^2 \right\}^{1/2} \quad (B12)$$

Equations (B5)–(B8) are used to obtain the sensitivity of the derived quantity with respect to each of the primary measurements. The uncertainty in Mach number is first determined with the nominal wind tunnel static and total pressures for representative Reynolds and Mach numbers. The sensitivity factors (i.e., quantities in partial derivatives) change as the values of the primary measure-

ments change based on test Reynolds and Mach numbers. The contributions of the static pressure and total pressure measurement to the calculated uncertainty in Mach number, normal-force coefficient, pitching-moment coefficient, and pressure coefficient are listed in tables B2–B5.

Table B2. Contribution of Primary Measurements to Mach Number Uncertainty

M_∞	R_{mac}	p_T , psia	t_T , °F	$\frac{\partial M_\infty}{\partial p_\infty} U(p_\infty)$	$\frac{\partial M_\infty}{\partial p_T} U(p_T)$	$U(M_\infty)$
0.40	6×10^6	66	120	-0.0004	0.0002	0.0005
.60	6	19.5	120	-.0003	.0002	.0003
.85	120	76	-250	-.0002	.0001	.0003
.90	6	15.5	120	-.0003	.0001	.0003

Table B3. Contribution of Primary Measurements to Normal-Force Coefficient Uncertainty

M_∞	R_{mac}	p_T , psia	t_T , °F	α , deg	$\frac{\partial C_N}{\partial F_N} U(F_N)$	$\frac{\partial C_N}{\partial p_\infty} U(p_\infty)$	$\frac{\partial C_N}{\partial M_\infty} U(M_\infty)$	$U(C_N)$
0.40	6×10^6	66.0	120	4.84	0.01187	-0.00003	0.00037	0.0119
				9.95	0.01189	-0.00008	-0.00080	0.0119
				20.17	0.01189	-0.00019	-0.00202	0.0121
0.60	6×10^6	19.5	120	4.99	0.02020	-0.00004	-0.00019	0.0202
				10.14	0.02020	-0.00009	-0.00045	0.0202
				20.26	0.02021	-0.00022	-0.00106	0.0202
0.85	120×10^6	76.0	-250	4.95	0.00323	-0.00005	-0.00012	0.0032
				10.34	0.00322	-0.00012	-0.00030	0.0032
				14.57	0.00323	-0.00017	-0.00044	0.0033
0.90	6×10^6	15.5	120	5.06	0.01501	-0.00007	-0.00015	0.0150
				10.20	0.01500	-0.00016	-0.00034	0.0150
				20.33	0.01503	-0.00034	-0.00074	0.0150

Table B4. Contribution of Primary Measurements to Pitching-Moment Coefficient Uncertainty

M_∞	R_{mac}	p_T , psia	t_T , °F	α , deg	$\frac{\partial C_m}{\partial M_\gamma} U(M_\gamma)$	$\frac{\partial C_m}{\partial p_\infty} U(p_\infty)$	$\frac{\partial C_m}{\partial M_\infty} U(M_\infty)$	$U(C_m)$
0.40	6×10^6	66.0	120	4.84	0.00000	0.00000	0.00005	0.0000
				9.95	0.00000	0.00001	0.00012	0.0001
				20.17	0.00000	0.00003	0.00027	0.0003
0.60	6×10^6	19.5	120	4.99	0.00000	0.00001	0.00003	0.0000
				10.14	0.00000	0.00001	0.00007	0.0001
				20.26	0.00000	0.00003	0.00014	0.0001
0.85	120×10^6	76.0	-250	4.95	0.00000	0.00001	0.00002	0.0000
				10.34	0.00000	0.00002	0.00005	0.0001
				14.57	0.00000	0.00003	0.00006	0.0001
0.90	6×10^6	15.5	120	5.06	0.00000	0.00001	0.00003	0.0000
				10.20	0.00000	0.00003	0.00007	0.0001
				20.33	0.00000	0.00007	0.00015	0.0002

Table B5. Contribution of Primary Measurements to Pressure Coefficient Uncertainty

M_∞	R_{mac}	p_T , psia	t_T , °F	α , deg	$\frac{\partial C_p}{\partial p} U(p)$	$\frac{\partial C_p}{\partial p_\infty} U(p_\infty)$	$\frac{\partial C_p}{\partial M_\infty} U(M_\infty)$	$U(C_p)$
0.40	6×10^6	66.0	120	4.84	0.00458	0.00001	0.01066	0.0116
				9.95	0.00459	0.00002	0.01077	0.0117
				20.17	0.00459	0.00007	0.01101	0.0119
0.60	6×10^6	19.5	120	4.99	0.00780	0.00002	0.00231	0.0081
				10.14	0.00780	0.00005	0.00238	0.0082
				20.26	0.00780	0.00010	0.00249	0.0082
0.85	120×10^6	76.0	-250	4.95	0.00125	0.00000	0.00062	0.0014
				10.34	0.00124	0.00001	0.00062	0.0014
				14.57	0.00125	0.00001	0.00063	0.0014
0.90	6×10^6	15.5	120	5.06	0.00580	0.00002	0.00064	0.0058
				10.20	0.00579	0.00006	0.00068	0.0058
				20.33	0.00580	0.00007	0.00070	0.0058

Appendix C

Experimental Surface Pressure Data for 65° Delta Wing, $M_\infty = 0.85$

The experimental surface pressure data for the 65° delta wing at constant $M_\infty = 0.85$ are summarized in tables C1–C3. Because of the extensive data contained in these tables, they have not been included in the printed copy of the paper but are available electronically from the Langley Technical Report Server (LTRS). Open the files with the following Uniform Resource Locator (URL):

<ftp://techreports.larc.nasa.gov/pub/techreports/larc/96/NASA-96-tm4645vol1appC.ps.Z>

Appendix D

Experimental Surface Pressure Data for 65° Delta Wing, $R_{\text{mac}} = 6 \times 10^6$

The experimental surface pressure data for the 65° delta wing at constant $R_{\text{mac}} = 6 \times 10^6$ are summarized in tables D1–D6. Because of the extensive data contained in these tables, they have not been included in the printed copy of the paper but are available electronically from the Langley Technical Report Server (LTRS). Open the files with the following Uniform Resource Locator (URL):

<ftp://techreports.larc.nasa.gov/pub/techreports/larc/96/NASA-96-tm4645vol1appD.ps.Z>

References

1. Winter, H.: *Flow Phenomena on Plates and Airfoils of Short Span*. NACA TM-798, 1936.
2. Wilson, Herbert A.; and Lovell, J. Calvin: *Full-Scale Investigation of the Maximum Lift and Flow Characteristics of an Airplane Having Approximately Triangular Plan Form*. NACA RM L6K20, 1947.
3. Örnberg, Torsten: *A Note On the Flow Around Delta Wings*. KTH-Aero TN 38, Div. of Aeronautics, R. Inst. of Technology (Stockholm), 1954.
4. Lawford, J. A.: *Low-Speed Wind Tunnel Experiments on a Series of Sharp-Edged Delta Wings—Part II. Surface Flow Patterns and Boundary Layer Transition Measurements*. Tech. Note Aero. 2954, R. Aircr. Establ., Mar. 1964.
5. Hummel, Ing. Dietrich: *On the Vortex Formation Over a Slender Wing at Large Angles of Incidence. High Angle of Attack Aerodynamics*, AGARD-CP-247, Jan. 1979, pp. 15-1-15-17.
6. Vorropoulos, G.; and Wendt, J. F.: *Laser Velocimetry Study of Compressibility Effects on the Flow Field of a Delta Wing. Aerodynamics of Vortical Type Flows in Three Dimensions*, AGARD-CP-342, July 1983, pp. 9-1-9-13. (Available from DTIC as AD A135 157.)
7. Poisson-Quinton, P.: *Slender Wings for Civil and Military Aircraft*. *Israel J. Technol.*, vol. 16, no. 3, 1978, pp. 97-131.
8. Skow, A. M.; and Erickson, G. E.: *Modern Fighter Aircraft Design for High-Angle-of-Attack Maneuvering. High Angle-of-Attack Aerodynamics*, AGARD-LS-121, Dec. 1982, pp. 4-1-4-59.
9. Polhamus, E. C.: *Applying Slender Wing Benefits to Military Aircraft*. *J. Aircr.*, vol. 21, no. 8, Aug. 1984, pp. 545-559.
10. Polhamus, E. C.; and Gloss, B. B.: *Configuration Aerodynamics. High Reynolds Number Research*, NASA CP-2183, 1980, pp. 217-234.
11. Henderson, William P.: *Effects of Wing Leading-Edge Radius and Reynolds Number on Longitudinal Aerodynamic Characteristics of Highly Swept Wing-Body Configurations at Subsonic Speeds*. NASA TN D-8361, 1976.
12. Howe, J. T.: *Some Fluid Mechanical Problems Related to Subsonic and Supersonic Aircraft*. NASA SP-183, 1969.
13. Henderson, William P.: *Studies of Various Factors Affecting Drag Due to Lift at Subsonic Speeds*. NASA TN D-3584, 1966.
14. Fuller, Dennis E.: *Guide for Users of the National Transonic Facility*. NASA TM-83124, 1981.
15. Plentovich, E. B.: *The Application to Airfoils of a Technique for Reducing Orifice-Induced Pressure Error at High Reynolds Numbers*. NASA TP-2537, 1986.
16. Hall, Robert M.; and Adcock, Jerry B.: *Simulation of Ideal-Gas Flow by Nitrogen and Other Selected Gases at Cryogenic Temperatures*. NASA TP-1901, 1981.
17. Holman, Jack Philip: *Experimental Methods for Engineers*. 4th ed., McGraw-Hill Book Co., 1984, pp. 46-99.
18. Foster, Jean M.; and Adcock, Jerry B.: *User's Guide for the National Transonic Facility Data System*. NASA TM-100511, 1987.

REPORT DOCUMENTATION PAGE			Form Approved OMB No. 0704-0188	
Public reporting burden for this collection of information is estimated to average 1 hour per response, including the time for reviewing instructions, searching existing data sources, gathering and maintaining the data needed, and completing and reviewing the collection of information. Send comments regarding this burden estimate or any other aspect of this collection of information, including suggestions for reducing this burden, to Washington Headquarters Services, Directorate for Information Operations and Reports, 1215 Jefferson Davis Highway, Suite 1204, Arlington, VA 22202-4302, and to the Office of Management and Budget, Paperwork Reduction Project (0704-0188), Washington, DC 20503.				
1. AGENCY USE ONLY (Leave blank)	2. REPORT DATE February 1996	3. REPORT TYPE AND DATES COVERED Technical Memorandum		
4. TITLE AND SUBTITLE Experimental Surface Pressure Data Obtained on 65° Delta Wing Across Reynolds Number and Mach Number Ranges <i>Volume 1—Sharp Leading Edge</i>			5. FUNDING NUMBERS WU 505-59-54-01	
6. AUTHOR(S) Julio Chu and James M. Luckring				
7. PERFORMING ORGANIZATION NAME(S) AND ADDRESS(ES) NASA Langley Research Center Hampton, VA 23681-0001			8. PERFORMING ORGANIZATION REPORT NUMBER L-17411A	
9. SPONSORING/MONITORING AGENCY NAME(S) AND ADDRESS(ES) National Aeronautics and Space Administration Washington, DC 20546-0001			10. SPONSORING/MONITORING AGENCY REPORT NUMBER NASA TM-4645, Vol. 1	
11. SUPPLEMENTARY NOTES				
12a. DISTRIBUTION/AVAILABILITY STATEMENT Unclassified—Unlimited Subject Category 02 Availability: NASA CASI (301) 621-0390			12b. DISTRIBUTION CODE	
13. ABSTRACT (Maximum 200 words) An experimental wind tunnel test of a 65° delta wing model with interchangeable leading edges was conducted in the Langley National Transonic Facility (NTF). The objective was to investigate the effects of Reynolds and Mach numbers on slender-wing leading-edge vortex flows with four values of wing leading-edge bluntness. Experimentally obtained pressure data are presented without analysis in tabulated and graphical formats across a Reynolds number range of 6×10^6 to 36×10^6 at a Mach number of 0.85 and across a Mach number range of 0.4 to 0.9 at a Reynolds number of 6×10^6 . Normal-force and pitching-moment coefficient plots for these Reynolds number and Mach number ranges are also presented.				
14. SUBJECT TERMS Aerodynamics; Delta wing; Reynolds number; Leading-edge bluntness; Vortex flow; Cryogenic testing			15. NUMBER OF PAGES 28	
			16. PRICE CODE A03	
17. SECURITY CLASSIFICATION OF REPORT Unclassified	18. SECURITY CLASSIFICATION OF THIS PAGE Unclassified	19. SECURITY CLASSIFICATION OF ABSTRACT Unclassified	20. LIMITATION OF ABSTRACT	

Appendix C

Experimental Surface Pressure Data for 65° Delta Wing, $M_\infty = 0.85$

The experimental surface pressure data for the 65° delta wing at constant $M_\infty = 0.85$ are summarized in tables C1–C3. Because of the extensive data contained in these tables, they have not been included in the printed copy of the paper but are available electronically from the Langley Technical Report Server (LTRS). Open the files with the following Uniform Resource Locator (URL):

<ftp://techreports.larc.nasa.gov/pub/techreports/larc/96/NASA-96-tm4645vol1appC.ps.Z>

Table C1. Tabulations and Plots of Surface Pressure Coefficients.

η	x/c_R .2	$C_{p,u}$	x/c_R .4	$C_{p,u}$	x/c_R .6	$C_{p,u}$	x/c_R .8	$C_{p,u}$	x/c_R .95	$C_{p,u}$
0.050	-0.0033	0.0074	0.1321	0.1321	0.1321	0.1321	0.1321	0.1321	0.1321	0.1321
0.100	-0.0007	0.0069	0.1203	0.1203	0.1203	0.1203	0.1203	0.1203	0.1203	0.1203
0.150	-0.0005	0.0063	0.1072	0.1072	0.1072	0.1072	0.1072	0.1072	0.1072	0.1072
0.200	-0.0078	0.0051	0.0959	0.0959	0.0959	0.0959	0.0959	0.0959	0.0959	0.0959
0.250	*****	0.0044	0.0839	0.0839	0.0839	0.0839	0.0839	0.0839	0.0839	0.0839
0.300	-0.0244	0.0061	0.0712	0.1134	0.1134	0.1134	0.1134	0.1134	0.1134	0.1134
0.350	-0.0349	0.0007	0.0634	0.1047	0.1047	0.1047	0.1047	0.1047	0.1047	0.1047
0.400	-0.0419	0.0035	0.0546	0.0942	0.0942	0.0942	0.0942	0.0942	0.0942	0.0942
0.450	-0.0532	0.0027	0.0518	0.0881	0.0881	0.0881	0.0881	0.0881	0.0881	0.0881
0.500	-0.0579	0.0035	0.0393	0.0852	0.0852	0.0852	0.0852	0.0852	0.0852	0.0852
0.525	*****	-0.0084	0.0307	0.0779	0.0779	0.0779	0.0779	0.0779	0.0779	0.0779
0.550	-0.0557	0.0079	0.0312	0.0770	0.0770	0.0770	0.0770	0.0770	0.0770	0.0770
0.575	*****	-0.0138	0.0283	0.0758	0.0758	0.0758	0.0758	0.0758	0.0758	0.0758
0.600	-0.0417	0.0160	0.0234	0.0746	0.0746	0.0746	0.0746	0.0746	0.0746	0.0746
0.625	*****	0.0197	0.0197	0.0715	0.0715	0.0715	0.0715	0.0715	0.0715	0.0715
0.650	-0.0309	0.0189	0.0163	0.0681	0.0681	0.0681	0.0681	0.0681	0.0681	0.0681
0.675	*****	-0.0269	0.0111	0.0724	0.0724	0.0724	0.0724	0.0724	0.0724	0.0724
0.700	-0.0226	0.0401	0.0087	0.0723	0.0723	0.0723	0.0723	0.0723	0.0723	0.0723
0.725	*****	-0.0501	*****	-0.0741	-0.0741	-0.0741	-0.0741	-0.0741	-0.0741	-0.0741
0.750	-0.0089	0.0560	*****	-0.0706	-0.0706	-0.0706	-0.0706	-0.0706	-0.0706	-0.0706
0.775	*****	-0.0620	-0.0103	0.0763	0.0763	0.0763	0.0763	0.0763	0.0763	0.0763
0.800	0.0103	0.0638	0.0298	0.0807	0.0807	0.0807	0.0807	0.0807	0.0807	0.0807
0.825	*****	-0.0553	-0.0408	0.0812	0.0812	0.0812	0.0812	0.0812	0.0812	0.0812
0.850	0.0377	0.0425	-0.0490	0.1001	0.1001	0.1001	0.1001	0.1001	0.1001	0.1001
0.875	*****	-0.0277	-0.0471	0.1154	0.1154	0.1154	0.1154	0.1154	0.1154	0.1154
0.900	0.0778	0.0034	-0.0296	0.1155	0.1155	0.1155	0.1155	0.1155	0.1155	0.1155
0.925	*****	0.0287	-0.0089	0.0888	0.0888	0.0888	0.0888	0.0888	0.0888	0.0888
0.950	0.1217	0.0704	0.0347	0.0503	0.0503	0.0503	0.0503	0.0503	0.0503	0.0503
0.975	*****	0.1173	0.0965	0.0248	0.0248	0.0248	0.0248	0.0248	0.0248	0.0248

η	$C_{p,l}$	$C_{p,l}$	$C_{p,l}$	$C_{p,l}$	$C_{p,l}$	$C_{p,l}$	$C_{p,l}$	$C_{p,l}$	$C_{p,l}$
-0.200	-0.0492	-0.0077	0.0774	0.0774	0.0774	0.0774	0.0774	0.0774	0.0774
-0.400	-0.0723	-0.0134	0.0375	-0.1066	-0.1066	-0.1066	-0.1066	-0.1066	-0.1066
-0.600	*****	-0.0217	0.0043	-0.0909	-0.0909	-0.0909	-0.0909	-0.0909	-0.0909
-0.700	*****	-0.0747	-0.0105	-0.0932	-0.0932	-0.0932	-0.0932	-0.0932	-0.0932
-0.800	-0.0436	0.1080	-0.0768	-0.0966	-0.0966	-0.0966	-0.0966	-0.0966	-0.0966
-0.850	-0.0111	0.0890	-0.1001	-0.1497	-0.1497	-0.1497	-0.1497	-0.1497	-0.1497
-0.900	0.0264	0.0621	-0.1013	-0.1748	-0.1748	-0.1748	-0.1748	-0.1748	-0.1748
-0.950	*****	*****	-0.0335	-0.1274	-0.1274	-0.1274	-0.1274	-0.1274	-0.1274
-0.975	*****	0.0610	0.0237	-0.0541	-0.0541	-0.0541	-0.0541	-0.0541	-0.0541

Sharp Radius L.E.
 Run No. = 88 , Point No. = 1931
 $C_N = -0.041$, $C_m = 0.0125$
 $\alpha = -0.4^\circ$, $M_\infty = 0.850$
 $R_{mac} = 6.0 \times 10^6$

Surface Pressures Near Leading Edge

● / ◆ upper, starboard/port
 ○ / ◇ lower, starboard/port

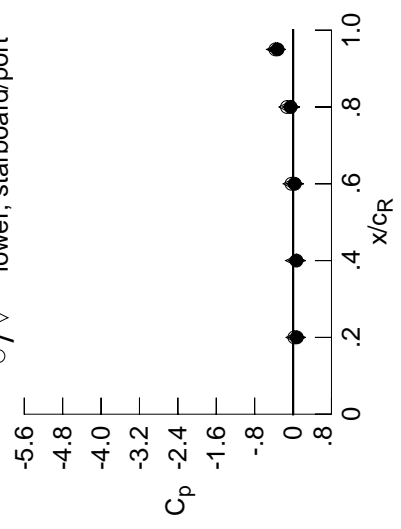

x/c_R	η	starb'd	port	starb'd	port
0.20	0.90	0.0778	0.0797	0.0313	0.0264
0.40	0.95	0.0704	0.0759	0.0227	*****
0.60	0.95	0.0347	0.0374	-0.0288	-0.0335
0.80	0.95	-0.0503	-0.0438	-0.1166	-0.1274
0.95	0.95	-0.3227	-0.3393	-0.3753	-0.3685

Surface Pressures

● upper, starboard
 ○ lower, port

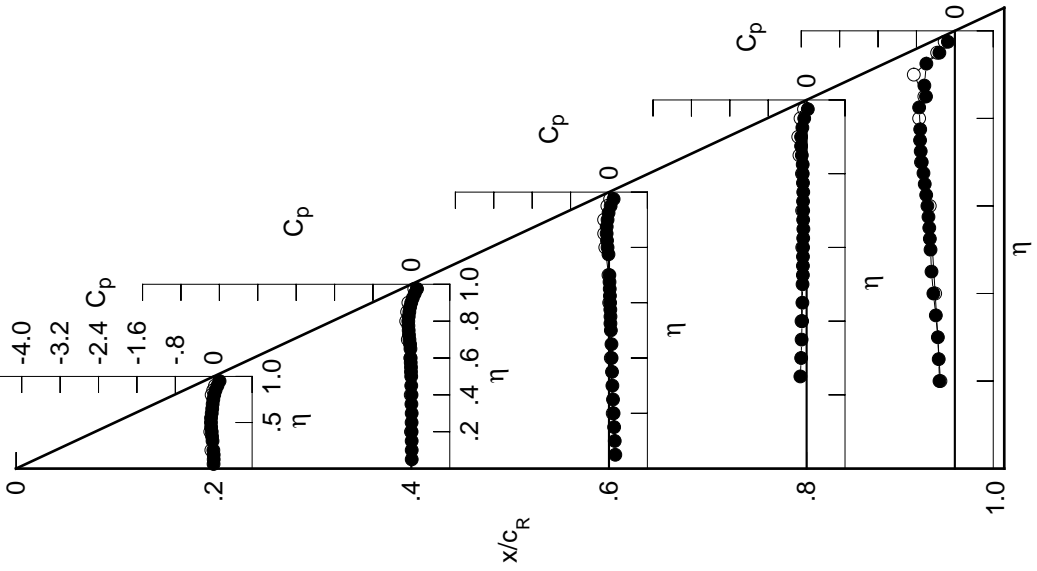

Table C1. Continued.

η	$x/c_R = .2$		$x/c_R = .4$		$x/c_R = .6$		$x/c_R = .8$		$x/c_R = .95$	
	$C_{p,u}$	$C_{p,u}$	$C_{p,u}$	$C_{p,u}$	$C_{p,u}$	$C_{p,u}$	$C_{p,u}$	$C_{p,u}$	$C_{p,u}$	$C_{p,u}$
0.050	-0.0140	-0.0032	0.1272	0.1272	0.1272	0.1272	0.1272	0.1272	0.1272	0.1272
0.100	-0.0096	-0.0028	0.1137	0.1137	0.1137	0.1137	0.1137	0.1137	0.1137	0.1137
0.150	-0.0157	-0.0026	0.1018	0.1018	0.1018	0.1018	0.1018	0.1018	0.1018	0.1018
0.200	-0.0209	-0.0007	0.0893	0.0893	0.0893	0.0893	0.0893	0.0893	0.0893	0.0893
0.250	*****	-0.0035	0.0771	-0.1363	0.0771	-0.1363	0.0771	-0.1363	0.0771	-0.1363
0.300	-0.0408	-0.0027	0.0637	-0.1189	0.0637	-0.1189	0.0637	-0.1189	0.0637	-0.1189
0.350	-0.0504	-0.0059	0.0579	-0.1108	0.0579	-0.1108	0.0579	-0.1108	0.0579	-0.1108
0.400	-0.0579	-0.0073	0.0456	-0.0980	0.0456	-0.0980	0.0456	-0.0980	0.0456	-0.0980
0.450	-0.0678	-0.0099	0.0447	-0.0944	0.0447	-0.0944	0.0447	-0.0944	0.0447	-0.0944
0.500	-0.0708	-0.0147	0.0306	-0.0906	0.0306	-0.0906	0.0306	-0.0906	0.0306	-0.0906
0.525	*****	-0.0165	0.0248	-0.0848	0.0248	-0.0848	0.0248	-0.0848	0.0248	-0.0848
0.550	-0.0733	-0.0170	0.0236	-0.0828	0.0236	-0.0828	0.0236	-0.0828	0.0236	-0.0828
0.575	*****	-0.0225	0.0208	-0.0827	0.0208	-0.0827	0.0208	-0.0827	0.0208	-0.0827
0.600	-0.0573	-0.0240	0.0147	-0.0796	0.0147	-0.0796	0.0147	-0.0796	0.0147	-0.0796
0.625	*****	*****	0.0114	-0.0810	0.0114	-0.0810	0.0114	-0.0810	0.0114	-0.0810
0.650	-0.0480	-0.0280	0.0082	-0.0777	0.0082	-0.0777	0.0082	-0.0777	0.0082	-0.0777
0.675	*****	-0.0369	0.0009	-0.0813	0.0009	-0.0813	0.0009	-0.0813	0.0009	-0.0813
0.700	-0.0387	-0.0594	0.0003	-0.0794	0.0003	-0.0794	0.0003	-0.0794	0.0003	-0.0794
0.725	*****	-0.0728	*****	-0.0810	*****	-0.0810	*****	-0.0810	*****	-0.0810
0.750	-0.0254	-0.0805	*****	-0.0801	*****	-0.0801	*****	-0.0801	*****	-0.0801
0.775	*****	-0.0864	-0.0194	-0.0867	-0.0194	-0.0867	-0.0194	-0.0867	-0.0194	-0.0867
0.800	-0.0067	-0.0825	-0.0472	-0.0920	-0.0472	-0.0920	-0.0472	-0.0920	-0.0472	-0.0920
0.825	*****	-0.0787	-0.0649	-0.0879	-0.0649	-0.0879	-0.0649	-0.0879	-0.0649	-0.0879
0.850	0.0215	-0.0665	-0.0692	-0.1194	-0.0692	-0.1194	-0.0692	-0.1194	-0.0692	-0.1194
0.875	*****	-0.0497	-0.0679	-0.1428	-0.0679	-0.1428	-0.0679	-0.1428	-0.0679	-0.1428
0.900	0.0603	-0.0282	-0.0550	-0.1383	-0.0550	-0.1383	-0.0550	-0.1383	-0.0550	-0.1383
0.925	*****	0.0075	-0.0319	-0.1117	-0.0319	-0.1117	-0.0319	-0.1117	-0.0319	-0.1117
0.950	0.1057	0.0454	0.0096	-0.0751	0.0096	-0.0751	0.0096	-0.0751	0.0096	-0.0751
0.975	*****	0.0961	0.0714	0.0022	-0.1662	0.0714	0.0022	-0.1662	0.0714	0.0022

η	$C_{p,l}$		$C_{p,l}$		$C_{p,l}$		$C_{p,l}$		$C_{p,l}$	
	$C_{p,l}$	$C_{p,l}$	$C_{p,l}$	$C_{p,l}$	$C_{p,l}$	$C_{p,l}$	$C_{p,l}$	$C_{p,l}$	$C_{p,l}$	$C_{p,l}$
-0.200	-0.0408	-0.0026	0.0874	0.0874	0.0874	0.0874	0.0874	0.0874	0.0874	0.0874
-0.400	-0.0554	-0.0036	0.0432	-0.1001	0.0432	-0.1001	0.0432	-0.1001	0.0432	-0.1001
-0.600	*****	-0.0180	0.0113	-0.0859	0.0113	-0.0859	0.0113	-0.0859	0.0113	-0.0859
-0.700	*****	-0.0561	-0.0033	-0.0871	-0.0033	-0.0871	-0.0033	-0.0871	-0.0033	-0.0871
-0.800	-0.0269	-0.0866	-0.0574	-0.0943	-0.0574	-0.0943	-0.0574	-0.0943	-0.0574	-0.0943
-0.850	0.0057	-0.0694	-0.0786	-0.1338	-0.0786	-0.1338	-0.0786	-0.1338	-0.0786	-0.1338
-0.900	0.0438	-0.0385	-0.0768	-0.1549	-0.0768	-0.1549	-0.0768	-0.1549	-0.0768	-0.1549
-0.950	*****	*****	-0.0062	-0.1005	-0.0062	-0.1005	-0.0062	-0.1005	-0.0062	-0.1005
-0.975	*****	0.0849	0.0518	-0.0240	0.0518	-0.0240	0.0518	-0.0240	0.0518	-0.1893

Sharp Radius L.E.
 Run No. = 88 , Point No. = 1932
 $C_N = -0.022$, $C_m = 0.0102$
 $\alpha = 0.0^\circ$, $M_\infty = 0.850$
 $R_{mac} = 6.0 \times 10^6$

Surface Pressures Near Leading Edge

● / ◆ upper, starboard/port
 ○ / ◇ lower, starboard/port

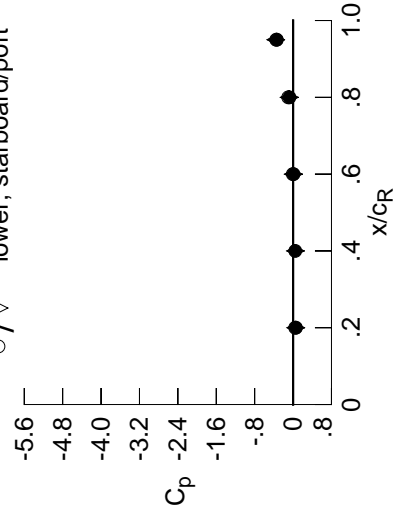

x/c_R	η	starb'd	port	starb'd	port
		$C_{p,u}$		$C_{p,l}$	
0.20	0.90	0.0603	0.0626	0.0491	0.0438
0.40	0.95	0.0454	0.0535	0.0451	*****
0.60	0.95	0.0096	0.0150	-0.0028	-0.0062
0.80	0.95	-0.0751	-0.0697	-0.0890	-0.1005
0.95	0.95	-0.3380	-0.3553	-0.3652	-0.3512

Table C1. Continued.

η	$x/c_R = .2$		$x/c_R = .4$		$x/c_R = .6$		$x/c_R = .8$		$x/c_R = .95$	
	$C_{p,u}$	$C_{p,l}$	$C_{p,u}$	$C_{p,l}$	$C_{p,u}$	$C_{p,l}$	$C_{p,u}$	$C_{p,l}$	$C_{p,u}$	$C_{p,l}$
0.050	-0.0314	-0.0183	0.1117	0.1117	0.1117	0.1117	0.1117	0.1117	0.1117	0.1117
0.100	-0.0318	-0.0213	0.1018	0.1018	0.1018	0.1018	0.1018	0.1018	0.1018	0.1018
0.150	-0.0360	-0.0170	0.0872	0.0872	0.0872	0.0872	0.0872	0.0872	0.0872	0.0872
0.200	-0.0461	-0.0228	0.0758	0.0758	0.0758	0.0758	0.0758	0.0758	0.0758	0.0758
0.250	*****	-0.0214	0.0631	-0.1494	0.0631	-0.1494	0.0631	-0.1494	0.0631	-0.3090
0.300	-0.0660	-0.0222	0.0500	-0.1314	0.0500	-0.1314	0.0500	-0.1314	0.0500	-0.3243
0.350	-0.0747	-0.0242	0.0433	-0.1249	0.0433	-0.1249	0.0433	-0.1249	0.0433	-0.3627
0.400	-0.0806	-0.0271	0.0300	-0.1126	0.0300	-0.1126	0.0300	-0.1126	0.0300	-0.4036
0.450	-0.0898	-0.0304	0.0272	-0.1087	0.0272	-0.1087	0.0272	-0.1087	0.0272	-0.4347
0.500	-0.0967	-0.0366	0.0125	-0.1057	0.0125	-0.1057	0.0125	-0.1057	0.0125	-0.4345
0.525	*****	-0.0387	0.0070	-0.1015	0.0070	-0.1015	0.0070	-0.1015	0.0070	-0.4442
0.550	-0.1008	-0.0415	0.0016	-0.0992	0.0016	-0.0992	0.0016	-0.0992	0.0016	-0.4464
0.575	*****	-0.0479	0.0021	-0.1006	0.0021	-0.1006	0.0021	-0.1006	0.0021	-0.4573
0.600	-0.0896	-0.0522	-0.0064	-0.0999	-0.0064	-0.0999	-0.0064	-0.0999	-0.0064	-0.4676
0.625	*****	*****	-0.0081	-0.0983	-0.0081	-0.0983	-0.0081	-0.0983	-0.0081	-0.4852
0.650	-0.0794	-0.0592	-0.0152	-0.0981	-0.0152	-0.0981	-0.0152	-0.0981	-0.0152	-0.5195
0.675	*****	-0.0700	-0.0229	-0.1011	-0.0229	-0.1011	-0.0229	-0.1011	-0.0229	-0.5634
0.700	-0.0726	-0.0850	-0.0284	-0.1032	-0.0284	-0.1032	-0.0284	-0.1032	-0.0284	-0.6281
0.725	*****	-0.1007	*****	-0.1056	-0.1056	-0.6921	*****	-0.1056	-0.6921	*****
0.750	-0.0618	-0.1077	*****	-0.1061	-0.1061	-0.7285	*****	-0.1061	-0.7285	*****
0.775	*****	-0.1214	-0.0561	-0.1126	-0.1126	-0.7268	*****	-0.1126	-0.7268	*****
0.800	-0.0453	-0.1230	-0.0824	-0.1236	-0.0824	-0.1236	*****	-0.1236	*****	*****
0.825	*****	-0.1199	-0.1010	-0.1250	-0.1250	-0.6855	*****	-0.1250	-0.6855	*****
0.850	-0.0187	-0.1122	-0.1155	-0.1557	-0.1557	-0.5630	*****	-0.1557	-0.5630	*****
0.875	*****	-0.1019	-0.1142	-0.1869	-0.1869	-0.5541	*****	-0.1869	-0.5541	*****
0.900	0.0213	-0.0789	-0.1060	-0.1904	-0.1060	-0.1904	*****	-0.1904	*****	*****
0.925	*****	-0.0470	-0.0879	-0.1678	-0.1678	-0.5426	*****	-0.1678	-0.5426	*****
0.950	0.0631	-0.0068	-0.0477	-0.1406	-0.1406	-0.3693	*****	-0.1406	-0.3693	*****
0.975	*****	0.0397	0.0129	-0.0679	-0.0679	-0.2140	*****	-0.0679	-0.2140	*****
-0.200	-0.0135	0.0148	0.0963	0.0963	0.0963	0.0963	0.0963	0.0963	0.0963	0.0963
-0.400	-0.0268	0.0128	0.0563	-0.0869	-0.0869	-0.4742	*****	-0.0869	-0.4742	*****
-0.600	*****	0.0011	0.0271	-0.0706	-0.0706	-0.5994	*****	-0.0706	-0.5994	*****
-0.700	*****	-0.0292	0.0180	-0.0699	-0.0699	-0.7080	*****	-0.0699	-0.7080	*****
-0.800	0.0111	-0.0469	-0.0212	-0.0719	-0.0719	-0.7200	*****	-0.0719	-0.7200	*****
-0.850	0.0426	-0.0282	-0.0393	-0.0927	-0.0927	-0.7330	*****	-0.0927	-0.7330	*****
-0.900	0.0809	0.0112	-0.0259	-0.1048	-0.1048	-0.8845	*****	-0.1048	-0.8845	*****
-0.950	*****	*****	0.0478	-0.0413	-0.0413	-0.3153	*****	-0.0413	-0.3153	*****
-0.975	*****	0.1308	0.1043	0.0326	0.0326	-0.1465	*****	0.0326	-0.1465	*****

Sharp Radius L.E.
 Run No. = 88 , Point No. = 1933
 $C_N = 0.023$, $C_m = -0.0009$
 $\alpha = 1.1^\circ$, $M_\infty = 0.851$
 $R_{mac} = 6.0 \times 10^6$

Surface Pressures Near Leading Edge

● / ◆ upper, starboard/port
 ○ / ◇ lower, starboard/port

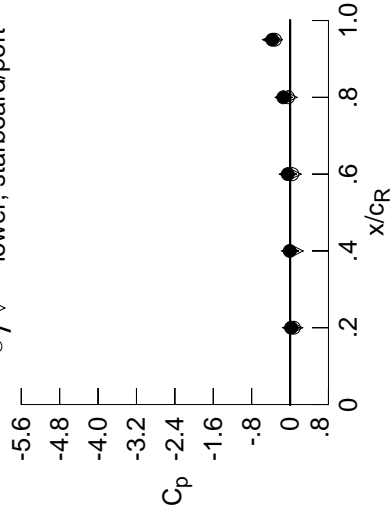

x/c_R	η	starb'd	port	starb'd	port
		$C_{p,u}$	$C_{p,l}$	$C_{p,u}$	$C_{p,l}$
0.20	0.90	0.0213	0.0225	0.0854	0.0809
0.40	0.95	-0.0068	0.0001	0.0926	*****
0.60	0.95	-0.0477	-0.0468	0.0502	0.0478
0.80	0.95	-0.1406	-0.1330	-0.0332	-0.0413
0.95	0.95	-0.3693	-0.3949	-0.3390	-0.3153

Surface Pressures

● upper, starboard
 ○ lower, port

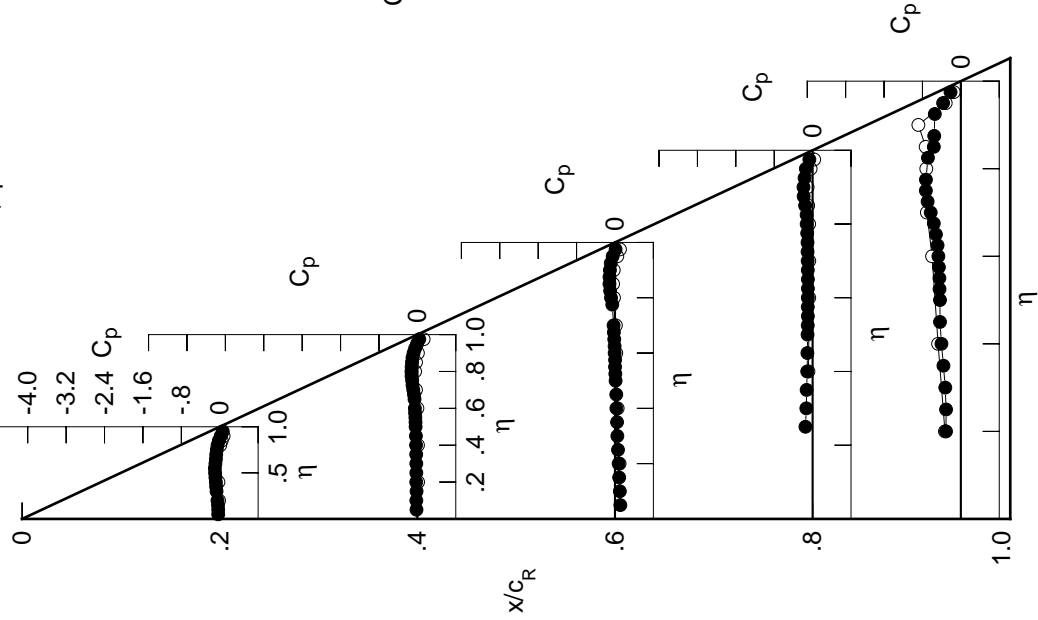

Table C1. Continued.

η	$x/c_R = .2$		$x/c_R = .4$		$x/c_R = .6$		$x/c_R = .8$		$x/c_R = .95$	
	$C_{p,u}$	$C_{p,l}$	$C_{p,u}$	$C_{p,l}$	$C_{p,u}$	$C_{p,l}$	$C_{p,u}$	$C_{p,l}$	$C_{p,u}$	$C_{p,l}$
0.050	-0.0477	-0.0325	0.1008	0.1008	0.1008	0.1008	0.1008	0.1008	0.1008	0.1008
0.100	-0.0456	-0.0364	0.0882	0.0882	0.0882	0.0882	0.0882	0.0882	0.0882	0.0882
0.150	-0.0483	-0.0377	0.0744	0.0744	0.0744	0.0744	0.0744	0.0744	0.0744	0.0744
0.200	-0.0544	-0.0373	0.0633	0.0633	0.0633	0.0633	0.0633	0.0633	0.0633	0.0633
0.250	*****	-0.0419	0.0486	-0.1605	-0.1605	-0.1605	-0.1605	-0.1605	-0.1605	-0.1605
0.300	-0.0712	-0.0415	0.0373	-0.1463	-0.1463	-0.1463	-0.1463	-0.1463	-0.1463	-0.1463
0.350	-0.0826	-0.0457	0.0254	-0.1347	-0.1347	-0.1347	-0.1347	-0.1347	-0.1347	-0.1347
0.400	-0.0920	-0.0456	0.0169	-0.1276	-0.1276	-0.1276	-0.1276	-0.1276	-0.1276	-0.1276
0.450	-0.1081	-0.0532	0.0108	-0.1212	-0.1212	-0.1212	-0.1212	-0.1212	-0.1212	-0.1212
0.500	-0.1149	-0.0587	-0.0009	-0.1214	-0.1214	-0.1214	-0.1214	-0.1214	-0.1214	-0.1214
0.525	*****	-0.0617	-0.0110	-0.1130	-0.1130	-0.1130	-0.1130	-0.1130	-0.1130	-0.1130
0.550	-0.1229	-0.0647	-0.0136	-0.1162	-0.1162	-0.1162	-0.1162	-0.1162	-0.1162	-0.1162
0.575	*****	-0.0725	-0.0195	-0.1161	-0.1161	-0.1161	-0.1161	-0.1161	-0.1161	-0.1161
0.600	-0.1219	-0.0790	-0.0259	-0.1143	-0.1143	-0.1143	-0.1143	-0.1143	-0.1143	-0.1143
0.625	*****	*****	-0.0312	-0.1171	-0.1171	-0.1171	-0.1171	-0.1171	-0.1171	-0.1171
0.650	-0.1142	-0.0879	-0.0369	-0.1146	-0.1146	-0.1146	-0.1146	-0.1146	-0.1146	-0.1146
0.675	*****	-0.0976	-0.0466	-0.1192	-0.1192	-0.1192	-0.1192	-0.1192	-0.1192	-0.1192
0.700	-0.1058	-0.1183	-0.0513	-0.1241	-0.1241	-0.1241	-0.1241	-0.1241	-0.1241	-0.1241
0.725	*****	-0.1354	*****	-0.1276	-0.1276	-0.1276	-0.1276	-0.1276	-0.1276	-0.1276
0.750	-0.0955	-0.1445	*****	-0.1297	-0.1297	-0.1297	-0.1297	-0.1297	-0.1297	-0.1297
0.775	*****	-0.1564	-0.0860	-0.1385	-0.1385	-0.1385	-0.1385	-0.1385	-0.1385	-0.1385
0.800	-0.0804	-0.1618	-0.1157	-0.1513	-0.1513	-0.1513	-0.1513	-0.1513	-0.1513	-0.1513
0.825	*****	-0.1602	-0.1391	-0.1583	-0.1583	-0.1583	-0.1583	-0.1583	-0.1583	-0.1583
0.850	-0.0546	-0.1553	-0.1597	-0.1915	-0.1915	-0.1915	-0.1915	-0.1915	-0.1915	-0.1915
0.875	*****	-0.1490	-0.1610	-0.2238	-0.2238	-0.2238	-0.2238	-0.2238	-0.2238	-0.2238
0.900	-0.0181	-0.1283	-0.1592	-0.2356	-0.2356	-0.2356	-0.2356	-0.2356	-0.2356	-0.2356
0.925	*****	-0.0998	-0.1466	-0.2276	-0.2276	-0.2276	-0.2276	-0.2276	-0.2276	-0.2276
0.950	0.0216	-0.0617	-0.1135	-0.2033	-0.2033	-0.2033	-0.2033	-0.2033	-0.2033	-0.2033
0.975	*****	-0.0156	-0.0550	-0.1372	-0.1372	-0.1372	-0.1372	-0.1372	-0.1372	-0.1372

η	$x/c_R = .2$		$x/c_R = .4$		$x/c_R = .6$		$x/c_R = .8$		$x/c_R = .95$	
	$C_{p,u}$	$C_{p,l}$	$C_{p,u}$	$C_{p,l}$	$C_{p,u}$	$C_{p,l}$	$C_{p,u}$	$C_{p,l}$	$C_{p,u}$	$C_{p,l}$
-0.200	0.0170	0.0338	0.1112	0.1112	0.1112	0.1112	0.1112	0.1112	0.1112	0.1112
-0.400	0.0004	0.0325	0.0718	-0.0735	-0.0735	-0.0735	-0.0735	-0.0735	-0.0735	-0.0735
-0.600	*****	0.0248	0.0474	-0.0548	-0.0548	-0.0548	-0.0548	-0.0548	-0.0548	-0.0548
-0.700	*****	-0.0015	0.0384	-0.0487	-0.0487	-0.0487	-0.0487	-0.0487	-0.0487	-0.0487
-0.800	0.0470	-0.0046	0.0099	-0.0477	-0.0477	-0.0477	-0.0477	-0.0477	-0.0477	-0.0477
-0.850	0.0788	0.0113	0.0041	-0.0611	-0.0611	-0.0611	-0.0611	-0.0611	-0.0611	-0.0611
-0.900	0.1146	0.0546	0.0200	-0.0589	-0.0589	-0.0589	-0.0589	-0.0589	-0.0589	-0.0589
-0.950	*****	*****	0.0924	0.0069	0.0069	0.0069	0.0069	0.0069	0.0069	0.0069
-0.975	*****	0.1655	0.1435	0.0765	0.0765	0.0765	0.0765	0.0765	0.0765	0.0765

Sharp Radius L.E.
 Run No. = 88 , Point No. = 1934
 $C_N = 0.062$, $C_m = -0.0061$
 $\alpha = 2.1^\circ$, $M_\infty = 0.851$
 $R_{mac} = 6.0 \times 10^6$

Surface Pressures Near Leading Edge

● / ◆ upper, starboard/port
 ○ / ◇ lower, starboard/port

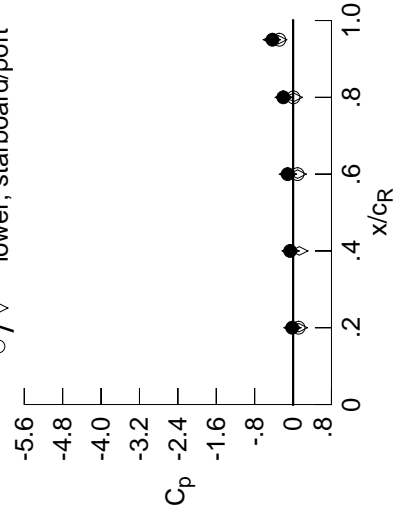

x/c_R	η	starb'd	port	starb'd	port
		$C_{p,u}$	$C_{p,l}$	$C_{p,u}$	$C_{p,l}$
0.20	0.90	-0.0181	-0.0138	0.1194	0.1146
0.40	0.95	-0.0617	-0.0520	0.1307	0.0924
0.60	0.95	-0.1135	-0.1074	0.0956	0.0924
0.80	0.95	-0.2033	-0.1943	0.0153	0.0069
0.95	0.95	-0.4293	-0.4428	-0.3099	-0.2867

Table C1. Continued.

η	$x/c_R = .2$		$x/c_R = .4$		$x/c_R = .6$		$x/c_R = .8$		$x/c_R = .95$	
	$C_{p,u}$	$C_{p,l}$	$C_{p,u}$	$C_{p,l}$	$C_{p,u}$	$C_{p,l}$	$C_{p,u}$	$C_{p,l}$	$C_{p,u}$	$C_{p,l}$
0.050	-0.0674	-0.0517	0.0868	0.0868	0.0868	0.0868	0.0868	0.0868	0.0868	0.0868
0.100	-0.0737	-0.0566	0.0774	0.0774	0.0774	0.0774	0.0774	0.0774	0.0774	0.0774
0.150	-0.0793	-0.0527	0.0621	0.0621	0.0621	0.0621	0.0621	0.0621	0.0621	0.0621
0.200	-0.0892	-0.0577	0.0506	0.0506	0.0506	0.0506	0.0506	0.0506	0.0506	0.0506
0.250	0.0000	-0.0558	0.0351	-0.1729	0.0351	-0.1729	0.0351	-0.1729	0.0351	-0.1729
0.300	-0.0977	-0.0621	0.0227	-0.1566	0.0227	-0.1566	0.0227	-0.1566	0.0227	-0.1566
0.350	-0.1083	-0.0603	0.0123	-0.1461	0.0123	-0.1461	0.0123	-0.1461	0.0123	-0.1461
0.400	-0.1179	-0.0690	0.0001	-0.1395	0.0001	-0.1395	0.0001	-0.1395	0.0001	-0.1395
0.450	-0.1337	-0.0721	-0.0030	-0.1346	-0.0030	-0.1346	-0.0030	-0.1346	-0.0030	-0.1346
0.500	-0.1420	-0.0830	-0.0223	-0.1366	-0.0223	-0.1366	-0.0223	-0.1366	-0.0223	-0.1366
0.525	0.0000	-0.0849	-0.0249	-0.1291	-0.0249	-0.1291	-0.0249	-0.1291	-0.0249	-0.1291
0.550	-0.1519	-0.0880	-0.0363	-0.1329	-0.0363	-0.1329	-0.0363	-0.1329	-0.0363	-0.1329
0.575	0.0000	-0.0984	-0.0345	-0.1271	-0.0345	-0.1271	-0.0345	-0.1271	-0.0345	-0.1271
0.600	-0.1531	-0.1027	-0.0490	-0.1351	-0.0490	-0.1351	-0.0490	-0.1351	-0.0490	-0.1351
0.625	0.0000	0.0000	-0.0507	-0.1362	-0.0507	-0.1362	-0.0507	-0.1362	-0.0507	-0.1362
0.650	-0.1505	-0.1151	-0.0611	-0.1353	-0.0611	-0.1353	-0.0611	-0.1353	-0.0611	-0.1353
0.675	0.0000	-0.1277	-0.0688	-0.1375	-0.0688	-0.1375	-0.0688	-0.1375	-0.0688	-0.1375
0.700	-0.1419	-0.1479	-0.0781	-0.1473	-0.0781	-0.1473	-0.0781	-0.1473	-0.0781	-0.1473
0.725	0.0000	-0.1670	0.0000	-0.1479	0.0000	-0.1479	0.0000	-0.1479	0.0000	-0.1479
0.750	-0.1336	-0.1793	0.0000	-0.1581	0.0000	-0.1581	0.0000	-0.1581	0.0000	-0.1581
0.775	0.0000	-0.1970	-0.1197	-0.1658	-0.1197	-0.1658	-0.1197	-0.1658	-0.1197	-0.1658
0.800	-0.1208	-0.2047	-0.1515	-0.1836	-0.1515	-0.1836	-0.1515	-0.1836	-0.1515	-0.1836
0.825	0.0000	-0.2085	-0.1780	-0.1893	-0.1780	-0.1893	-0.1780	-0.1893	-0.1780	-0.1893
0.850	-0.0978	-0.2070	-0.2013	-0.2252	-0.2013	-0.2252	-0.2013	-0.2252	-0.2013	-0.2252
0.875	0.0000	-0.2013	-0.2107	-0.2642	-0.2107	-0.2642	-0.2107	-0.2642	-0.2107	-0.2642
0.900	-0.0614	-0.1831	-0.2114	-0.2855	-0.2114	-0.2855	-0.2114	-0.2855	-0.2114	-0.2855
0.925	0.0000	-0.1507	-0.2031	-0.2825	-0.2031	-0.2825	-0.2031	-0.2825	-0.2031	-0.2825
0.950	-0.0288	-0.1084	-0.1578	-0.2688	-0.1578	-0.2688	-0.1578	-0.2688	-0.1578	-0.2688
0.975	0.0000	-0.1744	-0.2016	-0.2109	-0.2016	-0.2109	-0.2016	-0.2109	-0.2016	-0.2109

η	$x/c_R = .2$		$x/c_R = .4$		$x/c_R = .6$		$x/c_R = .8$		$x/c_R = .95$	
	$C_{p,u}$	$C_{p,l}$	$C_{p,u}$	$C_{p,l}$	$C_{p,u}$	$C_{p,l}$	$C_{p,u}$	$C_{p,l}$	$C_{p,u}$	$C_{p,l}$
-0.200	0.0396	0.0506	0.1262	0.1262	0.1262	0.1262	0.1262	0.1262	0.1262	0.1262
-0.400	0.0225	0.0525	0.0870	-0.0615	0.0870	-0.0615	0.0870	-0.0615	0.0870	-0.0615
-0.600	0.0000	0.0447	0.0682	-0.0380	0.0682	-0.0380	0.0682	-0.0380	0.0682	-0.0380
-0.700	0.0000	0.0268	0.0613	-0.0316	0.0613	-0.0316	0.0613	-0.0316	0.0613	-0.0316
-0.800	0.0799	0.0311	0.0391	-0.0228	0.0391	-0.0228	0.0391	-0.0228	0.0391	-0.0228
-0.850	0.1085	0.0466	0.0388	-0.0345	0.0388	-0.0345	0.0388	-0.0345	0.0388	-0.0345
-0.900	0.1445	0.0915	0.0597	-0.0207	0.0597	-0.0207	0.0597	-0.0207	0.0597	-0.0207
-0.950	0.0000	0.0000	0.1277	0.0471	0.1277	0.0471	0.1277	0.0471	0.1277	0.0471
-0.975	0.0000	0.1872	0.1706	0.1066	0.1706	0.1066	0.1706	0.1066	0.1706	0.1066

Sharp Radius L.E.
 Run No. = 88 , Point No. = 1935
 $C_N = 0.103$, $C_m = -0.0129$
 $\alpha = 3.2^\circ$, $M_\infty = 0.851$
 $R_{mac} = 6.0 \times 10^6$

Surface Pressures Near Leading Edge

● / ◆ upper, starboard/port
 ○ / ◇ lower, starboard/port

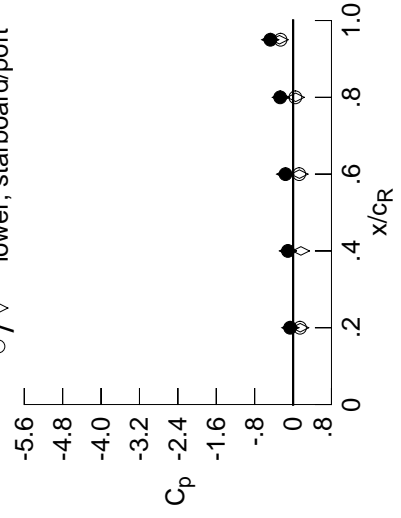

x/c_R	η	starb'd	port	starb'd	port
		$C_{p,u}$		$C_{p,l}$	
0.20	0.90	-0.0614	-0.0568	0.1484	0.1445
0.40	0.95	-0.1084	-0.1068	0.1630	0.1630
0.60	0.95	-0.1578	-0.1647	0.1323	0.1277
0.80	0.95	-0.2688	-0.2543	0.0555	0.0471
0.95	0.95	-0.4732	-0.4759	-0.2829	-0.2606

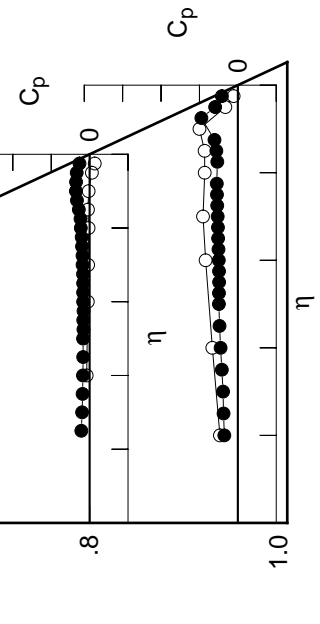

Table C1. Continued.

η	$x/c_R = .2$		$x/c_R = .4$		$x/c_R = .6$		$x/c_R = .8$		$x/c_R = .95$	
	$C_{p,u}$	$C_{p,l}$	$C_{p,u}$	$C_{p,l}$	$C_{p,u}$	$C_{p,l}$	$C_{p,u}$	$C_{p,l}$	$C_{p,u}$	$C_{p,l}$
0.050	-0.0948	-0.0666	0.0759	0.0759	0.0759	0.0759	0.0759	0.0759	0.0759	0.0759
0.100	-0.0999	-0.0728	0.0643	0.0643	0.0643	0.0643	0.0643	0.0643	0.0643	0.0643
0.150	-0.1009	-0.0698	0.0514	0.0514	0.0514	0.0514	0.0514	0.0514	0.0514	0.0514
0.200	-0.1104	-0.0761	0.0358	0.0358	0.0358	0.0358	0.0358	0.0358	0.0358	0.0358
0.250	*****	-0.0788	0.0242	-0.1849	-0.2876	0.0242	-0.1849	-0.2876	0.0242	-0.1849
0.300	-0.1182	-0.0774	0.0067	-0.1721	-0.2833	0.0067	-0.1721	-0.2833	0.0067	-0.1721
0.350	-0.1317	-0.0821	0.0014	-0.1604	-0.3135	0.0014	-0.1604	-0.3135	0.0014	-0.1604
0.400	-0.1415	-0.0865	-0.0147	-0.1531	-0.3507	-0.0147	-0.1531	-0.3507	-0.0147	-0.1531
0.450	-0.1592	-0.0960	-0.0184	-0.1500	-0.3699	-0.0184	-0.1500	-0.3699	-0.0184	-0.1500
0.500	-0.1703	-0.1049	-0.0418	-0.1520	-0.3906	-0.0418	-0.1520	-0.3906	-0.0418	-0.1520
0.525	*****	-0.1088	-0.0438	-0.1466	-0.3980	-0.0438	-0.1466	-0.3980	-0.0438	-0.1466
0.550	-0.1811	-0.1132	-0.0547	-0.1448	-0.3963	-0.0547	-0.1448	-0.3963	-0.0547	-0.1448
0.575	*****	-0.1222	-0.0556	-0.1493	-0.3970	-0.0556	-0.1493	-0.3970	-0.0556	-0.1493
0.600	-0.1845	-0.1289	-0.0696	-0.1499	-0.3933	-0.0696	-0.1499	-0.3933	-0.0696	-0.1499
0.625	*****	*****	-0.0760	-0.1574	-0.4060	-0.0760	-0.1574	-0.4060	-0.0760	-0.1574
0.650	-0.1818	-0.1440	-0.0832	-0.1569	-0.4238	-0.0832	-0.1569	-0.4238	-0.0832	-0.1569
0.675	*****	-0.1599	-0.0952	-0.1631	-0.4398	-0.0952	-0.1631	-0.4398	-0.0952	-0.1631
0.700	-0.1778	-0.1799	-0.1010	-0.1701	-0.4536	-0.1010	-0.1701	-0.4536	-0.1010	-0.1701
0.725	*****	-0.2029	*****	-0.1748	-0.4776	-0.2029	-0.1748	-0.4776	-0.2029	-0.1748
0.750	-0.1734	-0.2162	*****	-0.1830	-0.4976	-0.2162	-0.1830	-0.4976	-0.2162	-0.1830
0.775	*****	-0.2345	-0.1474	-0.1933	-0.5205	-0.2345	-0.1933	-0.5205	-0.2345	-0.1933
0.800	-0.1623	-0.2488	-0.1846	-0.2110	*****	-0.2488	-0.1846	-0.2110	*****	-0.1846
0.825	*****	-0.2551	-0.2139	-0.2209	-0.5255	-0.2551	-0.2139	-0.2209	-0.5255	-0.2139
0.850	-0.1393	-0.2515	-0.2411	-0.2653	-0.4407	-0.2515	-0.2411	-0.2653	-0.4407	-0.2411
0.875	*****	-0.2457	-0.2472	-0.3012	-0.4727	-0.2457	-0.2472	-0.3012	-0.4727	-0.2472
0.900	-0.1017	-0.2174	-0.2506	-0.3256	*****	-0.2174	-0.2506	-0.3256	*****	-0.2506
0.925	*****	-0.1912	-0.2329	-0.3254	-0.7471	-0.1912	-0.2329	-0.3254	-0.7471	-0.2329
0.950	-0.0825	-0.2754	-0.3114	-0.3325	-0.5062	-0.2754	-0.3114	-0.3325	-0.5062	-0.3114
0.975	*****	-0.3999	-0.4625	-0.4990	-0.4864	-0.3999	-0.4625	-0.4990	-0.4864	-0.4625

η	$x/c_R = .2$		$x/c_R = .4$		$x/c_R = .6$		$x/c_R = .8$		$x/c_R = .95$	
	$C_{p,u}$	$C_{p,l}$	$C_{p,u}$	$C_{p,l}$	$C_{p,u}$	$C_{p,l}$	$C_{p,u}$	$C_{p,l}$	$C_{p,u}$	$C_{p,l}$
-0.200	0.0605	0.0709	0.1399	0.1399	0.1399	0.1399	0.1399	0.1399	0.1399	0.1399
-0.400	0.0480	0.0721	0.1048	0.1048	0.1048	0.1048	0.1048	0.1048	0.1048	0.1048
-0.600	*****	0.0716	0.0830	-0.0216	-0.6861	0.0716	0.0830	-0.0216	-0.6861	0.0716
-0.700	*****	0.0547	0.0845	-0.0169	-0.7201	0.0547	0.0845	-0.0169	-0.7201	0.0547
-0.800	0.1114	0.0650	0.0668	-0.0001	-0.6713	0.1114	0.0650	0.0668	-0.0001	-0.6713
-0.850	0.1389	0.0793	0.0717	-0.0067	-0.6701	0.1389	0.0793	0.0717	-0.0067	-0.6701
-0.900	0.1707	0.1265	0.0957	0.0117	-0.7459	0.1707	0.1265	0.0957	0.0117	-0.7459
-0.950	*****	*****	0.1584	0.0794	-0.2384	0.1584	0.0794	-0.2384	0.1584	0.0794
-0.975	*****	0.2008	0.1874	0.1278	-0.0692	0.2008	0.1874	0.1278	-0.0692	0.1874

Sharp Radius L.E.
 Run No. = 88 , Point No. = 1936
 $C_N = 0.153$, $C_m = -0.0243$
 $\alpha = 4.2^\circ$, $M_\infty = 0.851$
 $R_{mac} = 6.0 \times 10^6$

Surface Pressures Near Leading Edge

● / ◆ upper, starboard/port
 ○ / ◇ lower, starboard/port

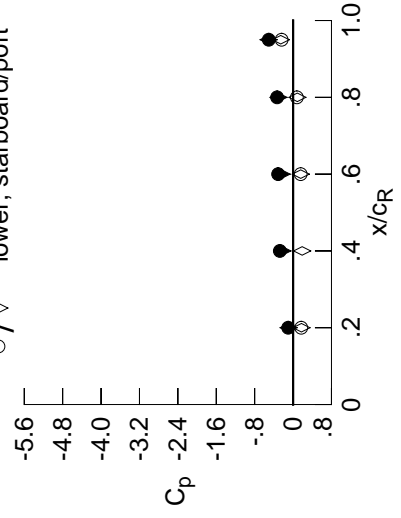

x/c_R	η	starb'd	port	starb'd	port
x/c_R	η	$C_{p,u}$	$C_{p,l}$	$C_{p,u}$	$C_{p,l}$
0.20	0.90	-0.1017	-0.0947	0.1744	0.1707
0.40	0.95	-0.2754	-0.2221	0.1893	*****
0.60	0.95	-0.3114	-0.2390	0.1600	0.1584
0.80	0.95	-0.3325	-0.3046	0.0888	0.0794
0.95	0.95	-0.5062	-0.5111	-0.2571	-0.2384

Table C1. Continued.

η	$x/c_R = .2$		$x/c_R = .4$		$x/c_R = .6$		$x/c_R = .8$		$x/c_R = .95$	
	$C_{p,u}$	$C_{p,l}$	$C_{p,u}$	$C_{p,l}$	$C_{p,u}$	$C_{p,l}$	$C_{p,u}$	$C_{p,l}$	$C_{p,u}$	$C_{p,l}$
0.050	-0.1118	-0.0867	0.0631	*****	*****	*****	*****	*****	*****	*****
0.100	-0.1144	-0.0835	0.0503	*****	*****	*****	*****	*****	*****	*****
0.150	-0.1237	-0.0920	0.0429	*****	*****	*****	*****	*****	*****	*****
0.200	-0.1279	-0.0888	0.0247	*****	*****	*****	*****	*****	*****	*****
0.250	*****	-0.0985	0.0116	-0.2008	-0.2803	*****	*****	*****	*****	*****
0.300	-0.1398	-0.0952	-0.0088	-0.1823	-0.2922	*****	*****	*****	*****	*****
0.350	-0.1531	-0.1027	-0.0183	-0.1758	-0.3179	*****	*****	*****	*****	*****
0.400	-0.1657	-0.1087	-0.0279	-0.1651	-0.3369	*****	*****	*****	*****	*****
0.450	-0.1821	-0.1178	-0.0387	-0.1651	-0.3456	*****	*****	*****	*****	*****
0.500	-0.1946	-0.1273	-0.0545	-0.1658	-0.3472	*****	*****	*****	*****	*****
0.525	*****	-0.1313	-0.0666	-0.1623	-0.3627	*****	*****	*****	*****	*****
0.550	-0.2085	-0.1375	-0.0691	-0.1597	-0.3610	*****	*****	*****	*****	*****
0.575	*****	-0.1426	-0.0774	-0.1650	-0.3732	*****	*****	*****	*****	*****
0.600	-0.2140	-0.1561	-0.0877	-0.1658	-0.3834	*****	*****	*****	*****	*****
0.625	*****	*****	-0.0980	-0.1685	-0.4203	*****	*****	*****	*****	*****
0.650	-0.2154	-0.1703	-0.1021	-0.1707	-0.4822	*****	*****	*****	*****	*****
0.675	*****	-0.1883	-0.1169	-0.1805	-0.5370	*****	*****	*****	*****	*****
0.700	-0.2142	-0.2120	-0.1239	-0.1826	-0.5886	*****	*****	*****	*****	*****
0.725	*****	-0.2362	*****	-0.1916	-0.6589	*****	*****	*****	*****	*****
0.750	-0.2069	-0.2539	*****	-0.1973	-0.6976	*****	*****	*****	*****	*****
0.775	*****	-0.2711	-0.1749	-0.2250	-0.7268	*****	*****	*****	*****	*****
0.800	-0.1959	-0.2834	-0.2107	-0.2435	*****	*****	*****	*****	*****	*****
0.825	*****	-0.2840	-0.2384	-0.2510	-0.7619	*****	*****	*****	*****	*****
0.850	-0.1660	-0.2786	-0.2595	-0.2969	-0.5580	*****	*****	*****	*****	*****
0.875	*****	-0.2591	-0.2588	-0.3373	-0.7953	*****	*****	*****	*****	*****
0.900	-0.1591	-0.2733	-0.3238	-0.3658	*****	*****	*****	*****	*****	*****
0.925	*****	-0.3975	-0.4518	-0.4761	-0.8521	*****	*****	*****	*****	*****
0.950	-0.1373	-0.5205	-0.5775	-0.5840	-0.5698	*****	*****	*****	*****	*****
0.975	*****	-0.5082	-0.5651	-0.6172	-0.4549	*****	*****	*****	*****	*****

η	$x/c_R = .2$		$x/c_R = .4$		$x/c_R = .6$		$x/c_R = .8$		$x/c_R = .95$	
	$C_{p,u}$	$C_{p,l}$	$C_{p,u}$	$C_{p,l}$	$C_{p,u}$	$C_{p,l}$	$C_{p,u}$	$C_{p,l}$	$C_{p,u}$	$C_{p,l}$
-0.200	0.0820	0.0956	0.1557	*****	*****	*****	*****	*****	*****	*****
-0.400	0.0740	0.0921	0.1204	-0.0308	-0.6122	*****	*****	*****	*****	*****
-0.600	*****	0.0959	0.1057	-0.0083	-0.6874	*****	*****	*****	*****	*****
-0.700	*****	0.0810	0.1021	0.0062	-0.7056	*****	*****	*****	*****	*****
-0.800	0.1385	0.0953	0.0914	0.0185	-0.6529	*****	*****	*****	*****	*****
-0.850	0.1644	0.1098	0.0995	0.0200	-0.6493	*****	*****	*****	*****	*****
-0.900	0.1922	0.1553	0.1255	0.0410	-0.7042	*****	*****	*****	*****	*****
-0.950	*****	*****	0.1802	0.1051	-0.2128	*****	*****	*****	*****	*****
-0.975	*****	0.2066	0.1976	0.1425	-0.0455	*****	*****	*****	*****	*****

Sharp Radius L.E.
 Run No. = 88 , Point No. = 1937
 $C_N = 0.199$, $C_m = -0.0335$
 $\alpha = 5.2^\circ$, $M_\infty = 0.851$
 $R_{mac} = 6.0 \times 10^6$

Surface Pressures Near Leading Edge

● / ◆ upper, starboard/port
 ○ / ◇ lower, starboard/port

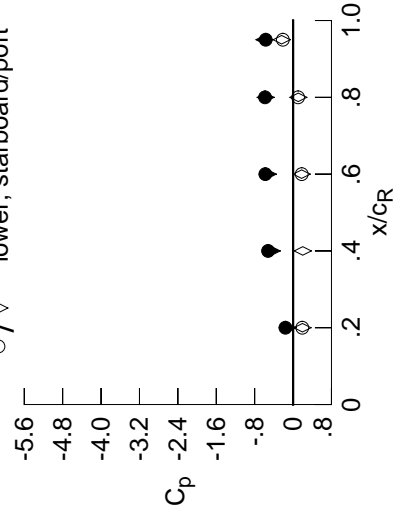

x/c_R	η	starb'd	port	starb'd	port
		$C_{p,u}$	$C_{p,l}$	$C_{p,u}$	$C_{p,l}$
0.20	0.90	-0.1591	-0.1118	0.1959	0.1922
0.40	0.95	-0.5205	-0.4447	0.2019	*****
0.60	0.95	-0.5775	-0.5271	0.1786	0.1802
0.80	0.95	-0.5840	-0.5719	0.1089	0.1051
0.95	0.95	-0.5698	-0.5979	-0.2373	-0.2128

Table C1. Continued.

η	$x/c_R = .2$		$x/c_R = .4$		$x/c_R = .6$		$x/c_R = .8$		$x/c_R = .95$	
	$C_{p,u}$	$C_{p,l}$	$C_{p,u}$	$C_{p,l}$	$C_{p,u}$	$C_{p,l}$	$C_{p,u}$	$C_{p,l}$	$C_{p,u}$	$C_{p,l}$
0.050	-0.1292	-0.1064	0.0536	*****	*****	*****	*****	*****	*****	*****
0.100	-0.1334	-0.1051	0.0360	*****	*****	*****	*****	*****	*****	*****
0.150	-0.1439	-0.1102	0.0269	*****	*****	*****	*****	*****	*****	*****
0.200	-0.1488	-0.1081	0.0078	*****	*****	*****	*****	*****	*****	*****
0.250	*****	-0.1162	-0.0030	-0.2178	-0.2929	*****	*****	*****	*****	*****
0.300	-0.1608	-0.1172	-0.0250	-0.1988	-0.2850	*****	*****	*****	*****	*****
0.350	-0.1758	-0.1205	-0.0355	-0.1958	-0.2915	*****	*****	*****	*****	*****
0.400	-0.1874	-0.1349	-0.0464	-0.1815	-0.2905	*****	*****	*****	*****	*****
0.450	-0.2066	-0.1446	-0.0552	-0.1854	-0.2824	*****	*****	*****	*****	*****
0.500	-0.2206	-0.1530	-0.0714	-0.1849	-0.2832	*****	*****	*****	*****	*****
0.525	*****	-0.1548	-0.0852	-0.1808	-0.3109	*****	*****	*****	*****	*****
0.550	-0.2352	-0.1643	-0.0904	-0.1778	-0.3333	*****	*****	*****	*****	*****
0.575	*****	-0.1716	-0.0945	-0.1789	-0.3882	*****	*****	*****	*****	*****
0.600	-0.2414	-0.1803	-0.1043	-0.1820	-0.4663	*****	*****	*****	*****	*****
0.625	*****	-0.1154	-0.1801	-0.6114	*****	*****	*****	*****	*****	*****
0.650	-0.2455	-0.1998	-0.1215	-0.1778	-0.7438	*****	*****	*****	*****	*****
0.675	*****	-0.2160	-0.1293	-0.1836	-0.7744	*****	*****	*****	*****	*****
0.700	-0.2427	-0.2401	-0.1403	-0.1803	-0.7752	*****	*****	*****	*****	*****
0.725	*****	-0.2640	*****	-0.1779	-0.7529	*****	*****	*****	*****	*****
0.750	-0.2327	-0.2831	*****	-0.1636	-0.7629	*****	*****	*****	*****	*****
0.775	*****	-0.2988	-0.1839	-0.2279	-0.8230	*****	*****	*****	*****	*****
0.800	-0.2107	-0.3012	-0.2155	-0.3671	*****	*****	*****	*****	*****	*****
0.825	*****	-0.2988	-0.2629	-0.4694	-0.8840	*****	*****	*****	*****	*****
0.850	-0.1912	-0.3145	-0.3837	-0.5614	-0.7120	*****	*****	*****	*****	*****
0.875	*****	-0.3873	-0.5264	-0.6006	-0.7437	*****	*****	*****	*****	*****
0.900	-0.3757	-0.5488	-0.6257	-0.6072	*****	*****	*****	*****	*****	*****
0.925	*****	-0.6292	-0.6556	-0.6025	-0.5933	*****	*****	*****	*****	*****
0.950	-0.2536	-0.6402	-0.6412	-0.5869	-0.4642	*****	*****	*****	*****	*****
0.975	*****	-0.6170	-0.6176	-0.5832	-0.4009	*****	*****	*****	*****	*****

η	$x/c_R = .2$		$x/c_R = .4$		$x/c_R = .6$		$x/c_R = .8$		$x/c_R = .95$	
	$C_{p,u}$	$C_{p,l}$	$C_{p,u}$	$C_{p,l}$	$C_{p,u}$	$C_{p,l}$	$C_{p,u}$	$C_{p,l}$	$C_{p,u}$	$C_{p,l}$
-0.200	0.1050	0.1136	0.1757	*****	-0.4323	*****	*****	*****	*****	*****
-0.400	0.0981	0.1150	0.1378	-0.0132	-0.6304	*****	*****	*****	*****	*****
-0.600	*****	0.1214	0.1262	0.0097	-0.6774	*****	*****	*****	*****	*****
-0.700	*****	0.1094	0.1235	0.0256	-0.6838	*****	*****	*****	*****	*****
-0.800	0.1674	0.1250	0.1190	0.0418	-0.6327	*****	*****	*****	*****	*****
-0.850	0.1898	0.1390	0.1289	0.0449	-0.6287	*****	*****	*****	*****	*****
-0.900	0.2130	0.1831	0.1537	0.0698	-0.6652	*****	*****	*****	*****	*****
-0.950	*****	*****	0.1972	0.1277	-0.1960	*****	*****	*****	*****	*****
-0.975	*****	0.2077	0.2010	0.1522	-0.0356	*****	*****	*****	*****	*****

Sharp Radius L.E.
 Run No. = 88 , Point No. = 1938
 $C_N = 0.253$, $C_m = -0.0440$
 $\alpha = 6.3^\circ$, $M_\infty = 0.850$
 $R_{mac} = 6.0 \times 10^6$

Surface Pressures Near Leading Edge

● / ◆ upper, starboard/port
 ○ / ◇ lower, starboard/port

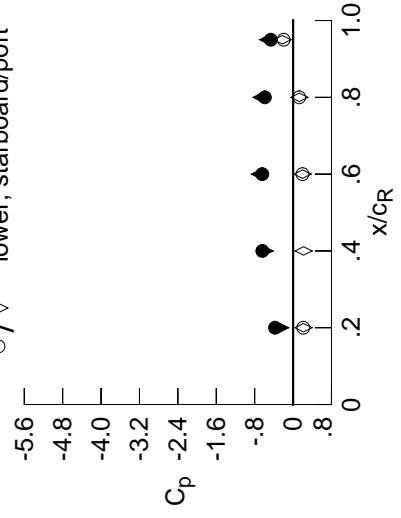

x/c_R	η	starb'd	port	starb'd	port
		$C_{p,u}$	$C_{p,l}$	$C_{p,u}$	$C_{p,l}$
0.20	0.90	-0.3757	-0.2670	0.2169	0.2130
0.40	0.95	-0.6402	-0.5920	0.2191	*****
0.60	0.95	-0.6412	-0.6923	0.1977	0.1972
0.80	0.95	-0.5869	-0.6566	0.1302	0.1277
0.95	0.95	-0.4642	-0.5212	-0.2223	-0.1960

Table C1. Continued.

η	$x/c_R = .2$		$x/c_R = .4$		$x/c_R = .6$		$x/c_R = .8$		$x/c_R = .95$	
	$C_{p,u}$	$C_{p,u}$	$C_{p,u}$	$C_{p,u}$	$C_{p,u}$	$C_{p,u}$	$C_{p,u}$	$C_{p,u}$	$C_{p,u}$	$C_{p,u}$
0.050	-0.1464	-0.1257	0.0348	0.0348	0.0348	0.0348	0.0348	0.0348	0.0348	0.0348
0.100	-0.1522	-0.1249	0.0215	0.0215	0.0215	0.0215	0.0215	0.0215	0.0215	0.0215
0.150	-0.1640	-0.1304	0.0123	0.0123	0.0123	0.0123	0.0123	0.0123	0.0123	0.0123
0.200	-0.1702	-0.1303	-0.0085	-0.0085	-0.0085	-0.0085	-0.0085	-0.0085	-0.0085	-0.0085
0.250	*****	-0.1364	-0.0213	-0.2407	-0.3079	-0.3079	-0.3079	-0.3079	-0.3079	-0.3079
0.300	-0.1816	-0.1405	-0.0464	-0.2235	-0.2774	-0.2774	-0.2774	-0.2774	-0.2774	-0.2774
0.350	-0.1972	-0.1440	-0.0543	-0.2154	-0.2563	-0.2563	-0.2563	-0.2563	-0.2563	-0.2563
0.400	-0.2113	-0.1575	-0.0651	-0.2035	-0.2410	-0.2410	-0.2410	-0.2410	-0.2410	-0.2410
0.450	-0.2306	-0.1688	-0.0741	-0.2007	-0.2482	-0.2482	-0.2482	-0.2482	-0.2482	-0.2482
0.500	-0.2465	-0.1773	-0.0908	-0.1981	-0.2816	-0.2816	-0.2816	-0.2816	-0.2816	-0.2816
0.525	*****	-0.1772	-0.1001	-0.1922	-0.3229	-0.3229	-0.3229	-0.3229	-0.3229	-0.3229
0.550	-0.2618	-0.1850	-0.1056	-0.1911	-0.3728	-0.3728	-0.3728	-0.3728	-0.3728	-0.3728
0.575	*****	-0.1954	-0.1084	-0.1906	-0.4667	-0.4667	-0.4667	-0.4667	-0.4667	-0.4667
0.600	-0.2657	-0.2049	-0.1175	-0.1917	-0.5870	-0.5870	-0.5870	-0.5870	-0.5870	-0.5870
0.625	*****	*****	-0.1261	-0.1858	-0.6947	-0.6947	-0.6947	-0.6947	-0.6947	-0.6947
0.650	-0.2702	-0.2203	-0.1345	-0.1776	-0.7441	-0.7441	-0.7441	-0.7441	-0.7441	-0.7441
0.675	*****	-0.2390	-0.1388	-0.1731	-0.7323	-0.7323	-0.7323	-0.7323	-0.7323	-0.7323
0.700	-0.2640	-0.2629	-0.1339	-0.1508	-0.7163	-0.7163	-0.7163	-0.7163	-0.7163	-0.7163
0.725	*****	-0.2811	*****	-0.1350	-0.7685	-0.7685	-0.7685	-0.7685	-0.7685	-0.7685
0.750	-0.2392	-0.2914	*****	-0.2555	-0.9561	-0.9561	-0.9561	-0.9561	-0.9561	-0.9561
0.775	*****	-0.2959	-0.2248	-0.5757	-1.0366	-1.0366	-1.0366	-1.0366	-1.0366	-1.0366
0.800	-0.2265	-0.3138	-0.4915	-0.7274	*****	*****	*****	*****	*****	*****
0.825	*****	-0.4204	-0.6498	-0.7593	-0.8722	-0.8722	-0.8722	-0.8722	-0.8722	-0.8722
0.850	-0.3703	-0.5572	-0.7165	-0.7329	-0.7641	-0.7641	-0.7641	-0.7641	-0.7641	-0.7641
0.875	*****	-0.6745	-0.7018	-0.6795	-0.6938	-0.6938	-0.6938	-0.6938	-0.6938	-0.6938
0.900	-0.5134	-0.7380	-0.7031	-0.6214	*****	*****	*****	*****	*****	*****
0.925	*****	-0.7385	-0.6801	-0.5952	-0.6480	-0.6480	-0.6480	-0.6480	-0.6480	-0.6480
0.950	-0.4150	-0.7193	-0.6567	-0.5838	-0.5651	-0.5651	-0.5651	-0.5651	-0.5651	-0.5651
0.975	*****	-0.7111	-0.6449	-0.5815	-0.4769	-0.4769	-0.4769	-0.4769	-0.4769	-0.4769
-0.200	$C_{p,l}$	0.1294	0.1358	0.1906	0.1906	0.1906	0.1906	0.1906	0.1906	0.1906
-0.400	$C_{p,l}$	0.1200	0.1363	0.1552	0.1552	0.1552	0.1552	0.1552	0.1552	0.1552
-0.600	$C_{p,l}$	*****	0.1443	0.1451	0.0261	0.0261	0.0261	0.0261	0.0261	0.0261
-0.700	$C_{p,l}$	*****	0.1360	0.1445	0.0419	0.0419	0.0419	0.0419	0.0419	0.0419
-0.800	$C_{p,l}$	0.1934	0.1517	0.1433	0.0615	0.0615	0.0615	0.0615	0.0615	0.0615
-0.850	$C_{p,l}$	0.2123	0.1662	0.1540	0.0656	0.0656	0.0656	0.0656	0.0656	0.0656
-0.900	$C_{p,l}$	0.2295	0.2065	0.1799	0.0939	0.0939	0.0939	0.0939	0.0939	0.0939
-0.950	$C_{p,l}$	*****	*****	0.2117	0.1438	0.1438	0.1438	0.1438	0.1438	0.1438
-0.975	$C_{p,l}$	*****	0.2068	0.2041	0.1561	0.1561	0.1561	0.1561	0.1561	0.1561

Sharp Radius L.E.

Run No. = 88 , Point No. = 1939

$C_N = 0.308$, $C_m = -0.0551$

$\alpha = 7.3^\circ$, $M_\infty = 0.851$

$R_{mac} = 6.0 \times 10^6$

Surface Pressures Near Leading Edge

● / ◆ upper, starboard/port
○ / ◇ lower, starboard/port

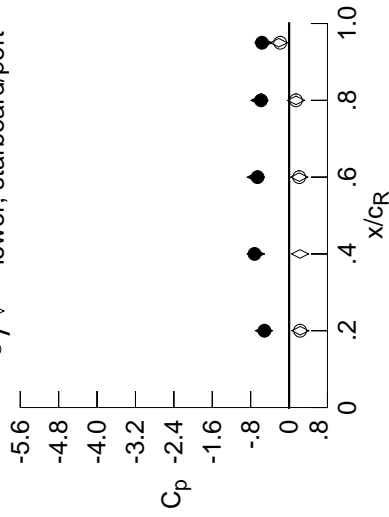

x/c_R	η	starb'd	port	starb'd	port
		$C_{p,u}$	$C_{p,l}$	$C_{p,u}$	$C_{p,l}$
0.20	0.90	-0.5134	-0.5245	0.2334	0.2295
0.40	0.95	-0.7193	-0.6940	0.2282	*****
0.60	0.95	-0.6567	-0.6933	0.2114	0.2117
0.80	0.95	-0.5838	-0.6178	0.1457	0.1438
0.95	0.95	-0.5651	-0.5369	-0.2146	-0.1847

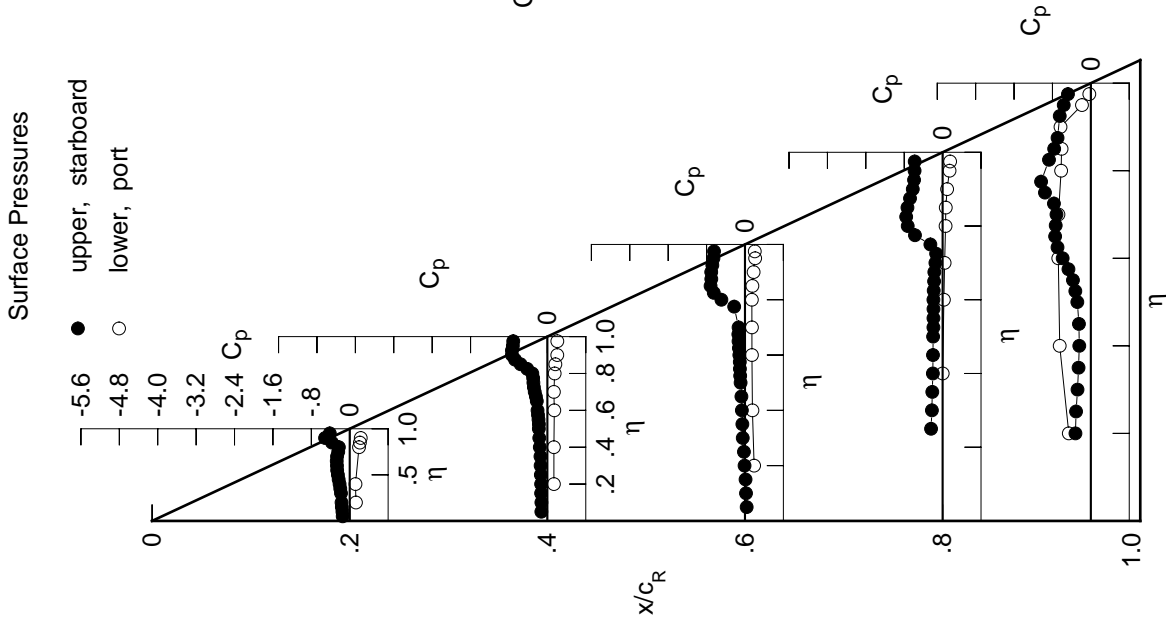

Table C1. Continued.

η	$x/c_R = .2$		$x/c_R = .4$		$x/c_R = .6$		$x/c_R = .8$		$x/c_R = .95$	
	$C_{p,u}$	$C_{p,l}$	$C_{p,u}$	$C_{p,l}$	$C_{p,u}$	$C_{p,l}$	$C_{p,u}$	$C_{p,l}$	$C_{p,u}$	$C_{p,l}$
0.050	-0.1678	-0.1476	0.0142	0.0142	0.0142	0.0142	0.0142	0.0142	0.0142	0.0142
0.100	-0.1743	-0.1492	0.0039	0.0039	0.0039	0.0039	0.0039	0.0039	0.0039	0.0039
0.150	-0.1839	-0.1524	-0.0107	-0.0107	-0.0107	-0.0107	-0.0107	-0.0107	-0.0107	-0.0107
0.200	-0.1911	-0.1539	-0.0251	-0.0251	-0.0251	-0.0251	-0.0251	-0.0251	-0.0251	-0.0251
0.250	*****	-0.1612	-0.0431	-0.2585	-0.2585	-0.2585	-0.2585	-0.2585	-0.2585	-0.2585
0.300	-0.2022	-0.1639	-0.0705	-0.2497	-0.2317	-0.2317	-0.2317	-0.2317	-0.2317	-0.2317
0.350	-0.2186	-0.1688	-0.0764	-0.2307	-0.1948	-0.1948	-0.1948	-0.1948	-0.1948	-0.1948
0.400	-0.2330	-0.1830	-0.0842	-0.2223	-0.1981	-0.1981	-0.1981	-0.1981	-0.1981	-0.1981
0.450	-0.2549	-0.2010	-0.0896	-0.2146	-0.2598	-0.2598	-0.2598	-0.2598	-0.2598	-0.2598
0.500	-0.2686	-0.2051	-0.1070	-0.2120	-0.3528	-0.3528	-0.3528	-0.3528	-0.3528	-0.3528
0.525	*****	-0.2040	-0.1152	-0.2062	-0.4438	-0.4438	-0.4438	-0.4438	-0.4438	-0.4438
0.550	-0.2836	-0.2041	-0.1199	-0.2043	-0.5758	-0.5758	-0.5758	-0.5758	-0.5758	-0.5758
0.575	*****	-0.2152	-0.1217	-0.2008	-0.7013	-0.7013	-0.7013	-0.7013	-0.7013	-0.7013
0.600	-0.2875	-0.2244	-0.1257	-0.1958	-0.7493	-0.7493	-0.7493	-0.7493	-0.7493	-0.7493
0.625	*****	*****	-0.1275	-0.1825	-0.7469	-0.7469	-0.7469	-0.7469	-0.7469	-0.7469
0.650	-0.2842	-0.2399	-0.1281	-0.1658	-0.7263	-0.7263	-0.7263	-0.7263	-0.7263	-0.7263
0.675	*****	-0.2563	-0.1277	-0.1554	-0.7088	-0.7088	-0.7088	-0.7088	-0.7088	-0.7088
0.700	-0.2653	-0.2709	-0.1026	-0.1701	-0.7829	-0.7829	-0.7829	-0.7829	-0.7829	-0.7829
0.725	*****	-0.2739	*****	-0.3370	-0.9349	-0.9349	-0.9349	-0.9349	-0.9349	-0.9349
0.750	-0.2441	-0.2728	*****	-0.6455	-1.0400	-1.0400	-1.0400	-1.0400	-1.0400	-1.0400
0.775	*****	-0.3693	-0.7081	-0.8347	-1.0255	-1.0255	-1.0255	-1.0255	-1.0255	-1.0255
0.800	-0.3860	-0.5527	-0.8382	-0.8782	*****	*****	*****	*****	*****	*****
0.825	*****	-0.7107	-0.8449	-0.8773	-0.7100	-0.7100	-0.7100	-0.7100	-0.7100	-0.7100
0.850	-0.5881	-0.7858	-0.8202	-0.8023	-0.7012	-0.7012	-0.7012	-0.7012	-0.7012	-0.7012
0.875	*****	-0.8280	-0.7437	-0.6904	-0.6094	-0.6094	-0.6094	-0.6094	-0.6094	-0.6094
0.900	-0.5834	-0.8309	-0.7161	-0.6466	*****	*****	*****	*****	*****	*****
0.925	*****	-0.8090	-0.6926	-0.6118	-0.6070	-0.6070	-0.6070	-0.6070	-0.6070	-0.6070
0.950	-0.5692	-0.7898	-0.6727	-0.5971	-0.5529	-0.5529	-0.5529	-0.5529	-0.5529	-0.5529
0.975	*****	-0.7854	-0.6628	-0.5944	-0.4856	-0.4856	-0.4856	-0.4856	-0.4856	-0.4856

η	$x/c_R = .2$		$x/c_R = .4$		$x/c_R = .6$		$x/c_R = .8$		$x/c_R = .95$	
	$C_{p,u}$	$C_{p,l}$	$C_{p,u}$	$C_{p,l}$	$C_{p,u}$	$C_{p,l}$	$C_{p,u}$	$C_{p,l}$	$C_{p,u}$	$C_{p,l}$
-0.200	0.1524	0.1558	0.2042	0.2042	0.2042	0.2042	0.2042	0.2042	0.2042	0.2042
-0.400	0.1390	0.1582	0.1727	0.1727	0.1727	0.1727	0.1727	0.1727	0.1727	0.1727
-0.600	*****	0.1676	0.1618	0.0419	0.6685	0.6685	0.6685	0.6685	0.6685	0.6685
-0.700	*****	0.1612	0.1673	0.0550	-0.6723	-0.6723	-0.6723	-0.6723	-0.6723	-0.6723
-0.800	0.2185	0.1796	0.1647	0.0780	-0.6073	-0.6073	-0.6073	-0.6073	-0.6073	-0.6073
-0.850	0.2344	0.1893	0.1784	0.0840	-0.5967	-0.5967	-0.5967	-0.5967	-0.5967	-0.5967
-0.900	0.2458	0.2274	0.2019	0.1118	-0.6012	-0.6012	-0.6012	-0.6012	-0.6012	-0.6012
-0.950	*****	*****	0.2244	0.1556	-0.1757	-0.1757	-0.1757	-0.1757	-0.1757	-0.1757
-0.975	*****	0.2034	0.2051	0.1563	-0.0286	-0.0286	-0.0286	-0.0286	-0.0286	-0.0286

Sharp Radius L.E.
 Run No. = 88 , Point No. = 1940
 $C_N = 0.361$, $C_m = -0.0640$
 $\alpha = 8.3^\circ$, $M_\infty = 0.851$
 $R_{mac} = 6.0 \times 10^6$

Surface Pressures Near Leading Edge

● / ◆ upper, starboard/port
 ○ / ◇ lower, starboard/port

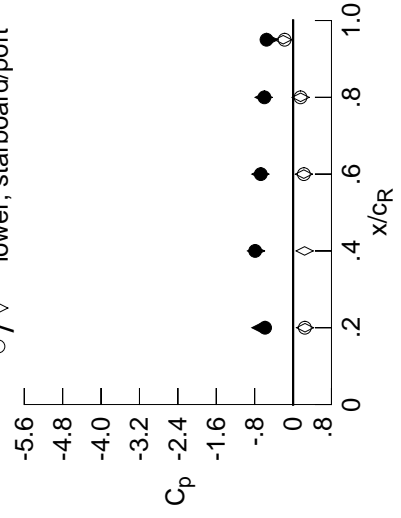

x/c_R	η	starb'd	port	starb'd	port
		$C_{p,u}$	$C_{p,l}$	$C_{p,u}$	$C_{p,l}$
0.20	0.90	-0.5834	-0.6818	0.2488	0.2458
0.40	0.95	-0.7898	-0.7717	0.2403	*****
0.60	0.95	-0.6727	-0.6824	0.2243	0.2244
0.80	0.95	-0.5971	-0.6147	0.1567	0.1556
0.95	0.95	-0.5529	-0.4969	-0.2060	-0.1757

Table C1. Continued.

η	x/c_R .2	x/c_R .4	x/c_R .6	x/c_R .8	x/c_R .95
	$C_{p,u}$	$C_{p,u}$	$C_{p,u}$	$C_{p,u}$	$C_{p,u}$
0.050	-0.1879	-0.1700	-0.0037	*****	*****
0.100	-0.1951	-0.1709	-0.0163	*****	*****
0.150	-0.2004	-0.1762	-0.0286	*****	*****
0.200	-0.2094	-0.1772	-0.0456	*****	-0.3665
0.250	*****	-0.1840	-0.0599	-0.2791	-0.2989
0.300	-0.2232	-0.1872	-0.0876	-0.2695	-0.2073
0.350	-0.2383	-0.1923	-0.1003	-0.2506	-0.1939
0.400	-0.2532	-0.2005	-0.1034	-0.2348	-0.2153
0.450	-0.2756	-0.2399	-0.1061	-0.2284	-0.2914
0.500	-0.2908	-0.2335	-0.1246	-0.2234	-0.4423
0.525	*****	-0.2326	-0.1299	-0.2155	-0.5881
0.550	-0.3046	-0.2304	-0.1330	-0.2087	-0.6832
0.575	*****	-0.2354	-0.1293	-0.2025	-0.7204
0.600	-0.3010	-0.2374	-0.1298	-0.1917	-0.7091
0.625	*****	*****	-0.1225	-0.1800	-0.6979
0.650	-0.2844	-0.2386	-0.1108	-0.1763	-0.7019
0.675	*****	-0.2458	-0.1055	-0.2261	-0.7738
0.700	-0.2557	-0.2529	-0.1639	-0.4084	-0.9218
0.725	*****	-0.2989	*****	-0.6962	-1.0511
0.750	-0.3872	-0.5003	*****	-0.9003	-1.0883
0.775	*****	-0.7361	-0.9543	-0.9878	-0.7407
0.800	-0.6229	-0.8470	-0.9795	-0.9696	*****
0.825	*****	-0.8929	-0.9395	-0.8377	-0.5851
0.850	-0.7164	-0.9023	-0.8796	-0.7318	-0.6252
0.875	*****	-0.8981	-0.7701	-0.7132	-0.5779
0.900	-0.6524	-0.8791	-0.7346	-0.6772	*****
0.925	*****	-0.8577	-0.7108	-0.6349	-0.5602
0.950	-0.7016	-0.8456	-0.6869	-0.6333	-0.4963
0.975	*****	-0.8439	-0.6742	-0.6278	-0.4277
	$C_{p,l}$	$C_{p,l}$	$C_{p,l}$	$C_{p,l}$	$C_{p,l}$
-0.200	0.1789	0.1805	0.2212	*****	-0.5045
-0.400	0.1679	0.1827	0.1923	0.0300	-0.6748
-0.600	*****	0.1927	0.1836	0.0574	-0.6746
-0.700	*****	0.1882	0.1864	0.0732	-0.6597
-0.800	0.2441	0.2117	0.1872	0.0962	-0.5944
-0.850	0.2559	0.2148	0.2015	0.1033	-0.5817
-0.900	0.2623	0.2512	0.2245	0.1296	-0.5767
-0.950	*****	*****	0.2349	0.1691	-0.1675
-0.975	*****	0.2001	0.2037	0.1597	-0.0274

Sharp Radius L.E.
 Run No. = 88 , Point No. = 1941
 $C_N = 0.415$, $C_m = -0.0725$
 $\alpha = 9.3^\circ$, $M_\infty = 0.851$
 $R_{mac} = 6.0 \times 10^6$

Surface Pressures Near Leading Edge

● / ◆ upper, starboard/port
 ○ / ◇ lower, starboard/port

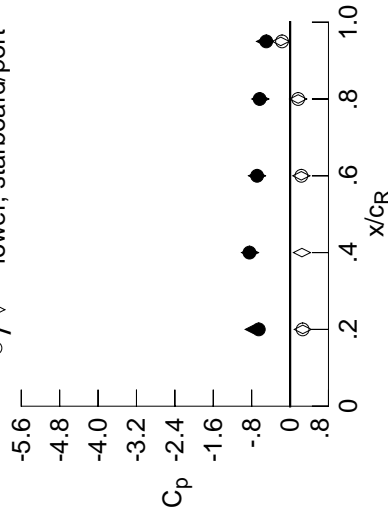

x/c_R	η	starb'd	port	starb'd	port
0.20	0.90	-0.6524	-0.7572	0.2647	0.2623
0.40	0.95	-0.8456	-0.8333	0.2475	*****
0.60	0.95	-0.6869	-0.6886	0.2337	0.2349
0.80	0.95	-0.6333	-0.6212	0.1689	0.1691
0.95	0.95	-0.4963	-0.5213	-0.1939	-0.1675

Surface Pressures

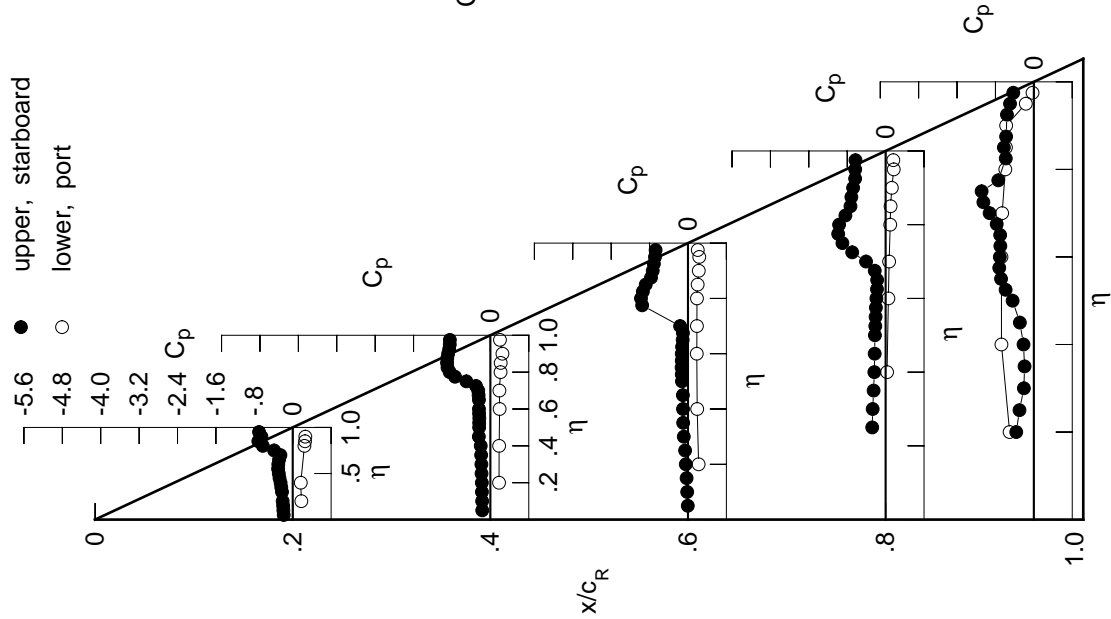

Table C1. Continued.

η	$x/c_R = .2$		$x/c_R = .4$		$x/c_R = .6$		$x/c_R = .8$		$x/c_R = .95$	
	$C_{p,u}$	$C_{p,l}$	$C_{p,u}$	$C_{p,l}$	$C_{p,u}$	$C_{p,l}$	$C_{p,u}$	$C_{p,l}$	$C_{p,u}$	$C_{p,l}$
0.050	-0.2107	-0.1970	-0.0253	*****	*****	*****	*****	*****	*****	*****
0.100	-0.2155	-0.1985	-0.0375	*****	*****	*****	*****	*****	*****	*****
0.150	-0.2221	-0.2023	-0.0513	*****	*****	*****	*****	*****	*****	*****
0.200	-0.2310	-0.2026	-0.0631	*****	*****	*****	*****	*****	*****	*****
0.250	*****	-0.2099	-0.0759	-0.2962	-0.2481	*****	*****	*****	*****	*****
0.300	-0.2435	-0.2100	-0.0951	-0.2821	-0.2378	*****	*****	*****	*****	*****
0.350	-0.2610	-0.2144	-0.1236	-0.2631	-0.2368	*****	*****	*****	*****	*****
0.400	-0.2760	-0.2138	-0.1227	-0.2499	-0.2803	*****	*****	*****	*****	*****
0.450	-0.2970	-0.2525	-0.1233	-0.2418	-0.3928	*****	*****	*****	*****	*****
0.500	-0.3088	-0.2696	-0.1374	-0.2348	-0.5924	*****	*****	*****	*****	*****
0.525	*****	-0.2626	-0.1415	-0.2228	-0.6701	*****	*****	*****	*****	*****
0.550	-0.3168	-0.2610	-0.1401	-0.2176	-0.6883	*****	*****	*****	*****	*****
0.575	*****	-0.2565	-0.1289	-0.2095	-0.6992	*****	*****	*****	*****	*****
0.600	-0.2991	-0.2473	-0.1324	-0.2100	-0.6971	*****	*****	*****	*****	*****
0.625	*****	*****	-0.1169	-0.2247	-0.7380	*****	*****	*****	*****	*****
0.650	-0.2634	-0.2135	-0.1415	-0.2908	-0.8230	*****	*****	*****	*****	*****
0.675	*****	-0.2194	-0.2630	-0.4679	-0.9467	*****	*****	*****	*****	*****
0.700	-0.3736	-0.4135	-0.5723	-0.7237	-1.0614	*****	*****	*****	*****	*****
0.725	*****	-0.7486	*****	-0.9428	-1.0796	*****	*****	*****	*****	*****
0.750	-0.6626	-0.9230	*****	-1.0641	-0.6939	*****	*****	*****	*****	*****
0.775	*****	-0.9879	-1.0687	-1.0160	-0.5882	*****	*****	*****	*****	*****
0.800	-0.7921	-0.9948	-1.0696	-0.8027	*****	*****	*****	*****	*****	*****
0.825	*****	-0.9820	-1.0040	-0.7191	-0.5487	*****	*****	*****	*****	*****
0.850	-0.8031	-0.9628	-0.8903	-0.7272	-0.5744	*****	*****	*****	*****	*****
0.875	*****	-0.9353	-0.7788	-0.7332	-0.5340	*****	*****	*****	*****	*****
0.900	-0.7276	-0.9112	-0.7631	-0.6859	*****	*****	*****	*****	*****	*****
0.925	*****	-0.8887	-0.7276	-0.6822	-0.4920	*****	*****	*****	*****	*****
0.950	-0.8064	-0.8776	-0.7005	-0.6886	-0.4256	*****	*****	*****	*****	*****
0.975	*****	-0.8745	-0.6843	-0.6791	-0.3778	*****	*****	*****	*****	*****

η	$x/c_R = .2$		$x/c_R = .4$		$x/c_R = .6$		$x/c_R = .8$		$x/c_R = .95$	
	$C_{p,u}$	$C_{p,l}$	$C_{p,u}$	$C_{p,l}$	$C_{p,u}$	$C_{p,l}$	$C_{p,u}$	$C_{p,l}$	$C_{p,u}$	$C_{p,l}$
-0.200	0.2042	0.2020	0.2397	*****	*****	*****	*****	*****	*****	*****
-0.400	0.1960	0.2048	0.2082	0.0454	-0.6811	*****	*****	*****	*****	*****
-0.600	*****	0.2170	0.2007	0.0721	-0.6734	*****	*****	*****	*****	*****
-0.700	*****	0.2142	0.2034	0.0868	-0.6533	*****	*****	*****	*****	*****
-0.800	0.2690	0.2374	0.2082	0.1096	-0.5846	*****	*****	*****	*****	*****
-0.850	0.2767	0.2386	0.2221	0.1184	-0.5671	*****	*****	*****	*****	*****
-0.900	0.2763	0.2649	0.2427	0.1449	-0.5526	*****	*****	*****	*****	*****
-0.950	*****	*****	0.2413	0.1741	-0.1572	*****	*****	*****	*****	*****
-0.975	*****	0.1944	0.1989	0.1548	-0.0238	*****	*****	*****	*****	*****

Sharp Radius L.E.
 Run No. = 88 , Point No. = 1942
 $C_N = 0.471$, $C_m = -0.0822$
 $\alpha = 10.4^\circ$, $M_\infty = 0.851$
 $R_{mac} = 6.0 \times 10^6$

Surface Pressures Near Leading Edge

● / ◆ upper, starboard/port
 ○ / ◇ lower, starboard/port

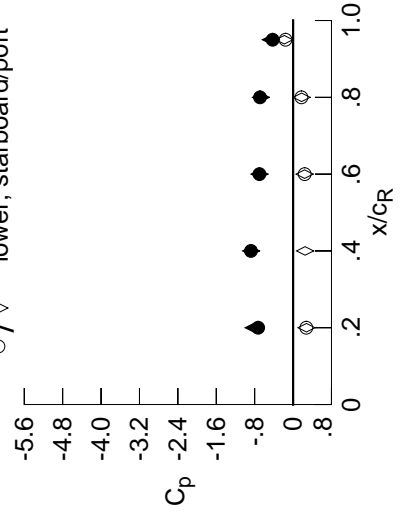

x/c_R	η	starb'd	port	starb'd	port
		$C_{p,u}$	$C_{p,l}$	$C_{p,u}$	$C_{p,l}$
0.20	0.90	-0.7276	-0.8220	0.2792	0.2763
0.40	0.95	-0.8776	-0.8744	0.2505	*****
0.60	0.95	-0.7005	-0.7004	0.2397	0.2413
0.80	0.95	-0.6886	-0.6691	0.1775	0.1741
0.95	0.95	-0.4256	-0.4646	-0.1832	-0.1572

Table C1. Continued.

η	$x/c_R = .2$		$x/c_R = .4$		$x/c_R = .6$		$x/c_R = .8$		$x/c_R = .95$	
	$C_{p,u}$	$C_{p,l}$	$C_{p,u}$	$C_{p,l}$	$C_{p,u}$	$C_{p,l}$	$C_{p,u}$	$C_{p,l}$	$C_{p,u}$	$C_{p,l}$
0.050	-0.2330	-0.2258	-0.0434	*****	*****	*****	*****	*****	*****	*****
0.100	-0.2364	-0.2273	-0.0579	*****	*****	*****	*****	*****	*****	*****
0.150	-0.2473	-0.2294	-0.0652	*****	*****	*****	*****	*****	*****	*****
0.200	-0.2534	-0.2314	-0.0805	*****	*****	*****	*****	*****	*****	*****
0.250	*****	-0.2353	-0.0917	-0.3171	-0.1913	*****	*****	*****	*****	*****
0.300	-0.2670	-0.2368	-0.1102	-0.2963	-0.2733	*****	*****	*****	*****	*****
0.350	-0.2819	-0.2361	-0.1312	-0.2867	-0.3401	*****	*****	*****	*****	*****
0.400	-0.2940	-0.2361	-0.1422	-0.2713	-0.4460	*****	*****	*****	*****	*****
0.450	-0.3135	-0.2597	-0.1369	-0.2615	-0.6268	*****	*****	*****	*****	*****
0.500	-0.3193	-0.2829	-0.1478	-0.2527	-0.6960	*****	*****	*****	*****	*****
0.525	*****	-0.2802	-0.1492	-0.2443	-0.7013	*****	*****	*****	*****	*****
0.550	-0.3145	-0.2742	-0.1456	-0.2460	-0.7026	*****	*****	*****	*****	*****
0.575	*****	-0.2657	-0.1376	-0.2550	-0.7288	*****	*****	*****	*****	*****
0.600	-0.2709	-0.2499	-0.1539	-0.2893	-0.7761	*****	*****	*****	*****	*****
0.625	*****	*****	-0.1940	-0.3746	-0.8759	*****	*****	*****	*****	*****
0.650	-0.2797	-0.3316	-0.3532	-0.5306	-0.9920	*****	*****	*****	*****	*****
0.675	*****	-0.6235	-0.6456	-0.7530	-1.0942	*****	*****	*****	*****	*****
0.700	-0.6592	-0.9240	-0.9399	-0.9688	-1.0668	*****	*****	*****	*****	*****
0.725	*****	-1.0628	*****	-1.1250	-0.6781	*****	*****	*****	*****	*****
0.750	-0.8750	-1.0929	*****	-0.9560	-0.5828	*****	*****	*****	*****	*****
0.775	*****	-1.0785	-1.1597	-0.7755	-0.5401	*****	*****	*****	*****	*****
0.800	-0.8997	-1.0565	-1.0958	-0.7387	*****	*****	*****	*****	*****	*****
0.825	*****	-1.0257	-0.9257	-0.7403	-0.5225	*****	*****	*****	*****	*****
0.850	-0.8781	-0.9935	-0.8569	-0.7517	-0.5261	*****	*****	*****	*****	*****
0.875	*****	-0.9546	-0.8076	-0.7367	-0.4925	*****	*****	*****	*****	*****
0.900	-0.8021	-0.9262	-0.8049	-0.7283	*****	*****	*****	*****	*****	*****
0.925	*****	-0.9071	-0.7542	-0.7427	-0.4398	*****	*****	*****	*****	*****
0.950	-0.8890	-0.8944	-0.7267	-0.7348	-0.3830	*****	*****	*****	*****	*****
0.975	*****	-0.8949	-0.7119	-0.7224	-0.3513	*****	*****	*****	*****	*****
-0.200	$C_{p,l}$	0.2348	0.2239	0.2567	*****	*****	*****	*****	*****	*****
-0.400	$C_{p,l}$	0.2257	0.2308	0.2266	0.0596	-0.6837	*****	*****	*****	*****
-0.600	$C_{p,l}$	*****	0.2413	0.2197	0.0855	-0.6626	*****	*****	*****	*****
-0.700	$C_{p,l}$	*****	0.2402	0.2253	0.1033	-0.6447	*****	*****	*****	*****
-0.800	$C_{p,l}$	0.2910	0.2576	0.2273	0.1264	-0.5716	*****	*****	*****	*****
-0.850	$C_{p,l}$	0.2965	0.2586	0.2408	0.1354	-0.5546	*****	*****	*****	*****
-0.900	$C_{p,l}$	0.2906	0.2823	0.2575	0.1600	-0.5327	*****	*****	*****	*****
-0.950	$C_{p,l}$	*****	*****	0.2460	0.1807	-0.1500	*****	*****	*****	*****
-0.975	$C_{p,l}$	*****	0.1890	0.1928	0.1494	-0.0235	*****	*****	*****	*****

Sharp Radius L.E.

Run No. = 88 , Point No. = 1943

$C_N = 0.522$, $C_m = -0.0883$

$\alpha = 11.4^\circ$, $M_\infty = 0.851$

$R_{mac} = 6.0 \times 10^6$

Surface Pressures Near Leading Edge

● / ◆ upper, starboard/port
○ / ◇ lower, starboard/port

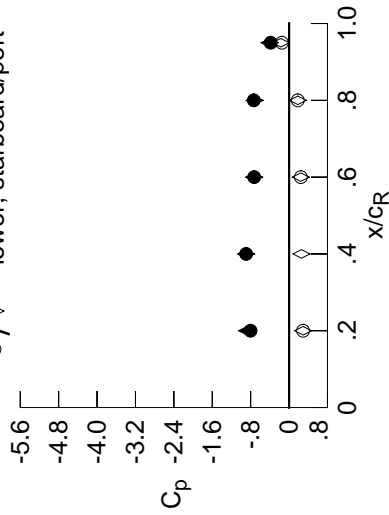

x/c_R	η	starb'd	port	starb'd	port
		$C_{p,u}$	$C_{p,l}$	$C_{p,u}$	$C_{p,l}$
0.20	0.90	-0.8021	-0.8742	0.2926	0.2906
0.40	0.95	-0.8944	-0.8947	0.2576	*****
0.60	0.95	-0.7267	-0.7278	0.2437	0.2460
0.80	0.95	-0.7348	-0.7182	0.1831	0.1807
0.95	0.95	-0.3830	-0.4067	-0.1734	-0.1500

Table C1. Continued.

η	$x/c_R = .2$		$x/c_R = .4$		$x/c_R = .6$		$x/c_R = .8$		$x/c_R = .95$	
	$C_{p,u}$	$C_{p,l}$	$C_{p,u}$	$C_{p,l}$	$C_{p,u}$	$C_{p,l}$	$C_{p,u}$	$C_{p,l}$	$C_{p,u}$	$C_{p,l}$
0.050	-0.2547	-0.2539	-0.0615	*****	*****	*****	*****	*****	*****	*****
0.100	-0.2590	-0.2583	-0.0744	*****	*****	*****	*****	*****	*****	*****
0.150	-0.2667	-0.2601	-0.0826	*****	*****	*****	*****	*****	*****	*****
0.200	-0.2747	-0.2632	-0.0980	*****	*****	*****	*****	*****	*****	*****
0.250	*****	-0.2645	-0.1097	-0.3380	-0.1806	*****	*****	*****	*****	*****
0.300	-0.2872	-0.2669	-0.1273	-0.3152	-0.2698	*****	*****	*****	*****	*****
0.350	-0.3012	-0.2660	-0.1383	-0.3044	-0.3649	*****	*****	*****	*****	*****
0.400	-0.3112	-0.2615	-0.1533	-0.2910	-0.5029	*****	*****	*****	*****	*****
0.450	-0.3262	-0.2637	-0.1471	-0.2798	-0.6521	*****	*****	*****	*****	*****
0.500	-0.3291	-0.2778	-0.1572	-0.2778	-0.6866	*****	*****	*****	*****	*****
0.525	*****	-0.2844	-0.1580	-0.2774	-0.6972	*****	*****	*****	*****	*****
0.550	-0.3174	-0.2792	-0.1634	-0.2938	-0.7252	*****	*****	*****	*****	*****
0.575	*****	-0.2856	-0.1781	-0.3376	-0.7830	*****	*****	*****	*****	*****
0.600	-0.2465	-0.3202	-0.2615	-0.4179	-0.8694	*****	*****	*****	*****	*****
0.625	*****	*****	-0.4140	-0.5593	-0.9944	*****	*****	*****	*****	*****
0.650	-0.4733	-0.7710	-0.7069	-0.7487	-1.1214	*****	*****	*****	*****	*****
0.675	*****	-1.0159	-0.9947	-0.9605	-1.0989	*****	*****	*****	*****	*****
0.700	-0.9098	-1.1439	-1.1913	-1.1368	-0.6957	*****	*****	*****	*****	*****
0.725	*****	-1.1755	*****	-1.0203	-0.5981	*****	*****	*****	*****	*****
0.750	-1.0066	-1.1582	*****	-0.8113	-0.5446	*****	*****	*****	*****	*****
0.775	*****	-1.1234	-1.1341	-0.7795	-0.5221	*****	*****	*****	*****	*****
0.800	-0.9903	-1.0838	-0.9760	-0.7833	*****	*****	*****	*****	*****	*****
0.825	*****	-1.0447	-0.8890	-0.7954	-0.5020	*****	*****	*****	*****	*****
0.850	-0.9470	-1.0034	-0.8666	-0.8015	-0.4959	*****	*****	*****	*****	*****
0.875	*****	-0.9672	-0.8422	-0.7707	-0.4654	*****	*****	*****	*****	*****
0.900	-0.8712	-0.9423	-0.8432	-0.7601	*****	*****	*****	*****	*****	*****
0.925	*****	-0.9257	-0.7759	-0.7735	-0.4116	*****	*****	*****	*****	*****
0.950	-0.9577	-0.9174	-0.7546	-0.7669	-0.3614	*****	*****	*****	*****	*****
0.975	*****	-0.9185	-0.7421	-0.7550	-0.3353	*****	*****	*****	*****	*****

η	$x/c_R = .2$		$x/c_R = .4$		$x/c_R = .6$		$x/c_R = .8$		$x/c_R = .95$	
	$C_{p,u}$	$C_{p,l}$	$C_{p,u}$	$C_{p,l}$	$C_{p,u}$	$C_{p,l}$	$C_{p,u}$	$C_{p,l}$	$C_{p,u}$	$C_{p,l}$
-0.200	0.2630	0.2499	0.2738	*****	-0.5984	*****	*****	*****	*****	*****
-0.400	0.2549	0.2524	0.2464	0.0727	-0.6804	*****	*****	*****	*****	*****
-0.600	*****	0.2657	0.2369	0.1034	-0.6565	*****	*****	*****	*****	*****
-0.700	*****	0.2652	0.2442	0.1178	-0.6341	*****	*****	*****	*****	*****
-0.800	0.3151	0.2820	0.2455	0.1432	-0.5586	*****	*****	*****	*****	*****
-0.850	0.3155	0.2793	0.2584	0.1503	-0.5411	*****	*****	*****	*****	*****
-0.900	0.3033	0.2971	0.2701	0.1736	-0.5128	*****	*****	*****	*****	*****
-0.950	*****	*****	0.2504	0.1856	-0.1422	*****	*****	*****	*****	*****
-0.975	*****	0.1832	0.1839	0.1427	-0.0230	*****	*****	*****	*****	*****

Sharp Radius L.E.
 Run No. = 88 , Point No. = 1944
 $C_N = 0.575$, $C_m = -0.0956$
 $\alpha = 12.4^\circ$, $M_\infty = 0.851$
 $R_{mac} = 6.0 \times 10^6$

Surface Pressures Near Leading Edge

● / ◆ upper, starboard/port
 ○ / ◇ lower, starboard/port

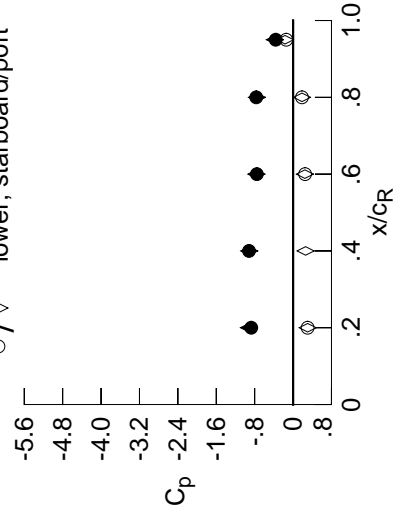

x/c_R	η	starb'd	port	$C_{p,u}$	starb'd	port	$C_{p,l}$
0.20	0.90	-0.8712	-0.9195	0.3044	0.3033	*****	*****
0.40	0.95	-0.9174	-0.9133	0.2613	*****	*****	*****
0.60	0.95	-0.7546	-0.7655	0.2467	0.2504	*****	*****
0.80	0.95	-0.7669	-0.7524	0.1864	0.1856	*****	*****
0.95	0.95	-0.3614	-0.3799	-0.1672	-0.1422	*****	*****

Table C1. Continued.

η	$x/c_R = .2$		$x/c_R = .4$		$x/c_R = .6$		$x/c_R = .8$		$x/c_R = .95$	
	$C_{p,u}$	$C_{p,l}$	$C_{p,u}$	$C_{p,l}$	$C_{p,u}$	$C_{p,l}$	$C_{p,u}$	$C_{p,l}$	$C_{p,u}$	$C_{p,l}$
0.050	-0.2806	-0.2891	-0.0824	*****	*****	*****	*****	*****	*****	*****
0.100	-0.2867	-0.2914	-0.0951	*****	*****	*****	*****	*****	*****	*****
0.150	-0.2966	-0.2948	-0.1037	*****	*****	*****	*****	*****	*****	*****
0.200	-0.3046	-0.2966	-0.1201	*****	*****	*****	*****	*****	*****	*****
0.250	*****	-0.2978	-0.1313	-0.3671	-0.1986	*****	*****	*****	*****	*****
0.300	-0.3271	-0.2991	-0.1493	-0.3433	-0.2708	*****	*****	*****	*****	*****
0.350	-0.3534	-0.3002	-0.1562	-0.3331	-0.3749	*****	*****	*****	*****	*****
0.400	-0.3762	-0.2974	-0.1658	-0.3168	-0.5177	*****	*****	*****	*****	*****
0.450	-0.3991	-0.2943	-0.1624	-0.3112	-0.6497	*****	*****	*****	*****	*****
0.500	-0.3896	-0.2860	-0.1778	-0.3191	-0.6934	*****	*****	*****	*****	*****
0.525	*****	-0.2885	-0.1905	-0.3345	-0.7224	*****	*****	*****	*****	*****
0.550	-0.3306	-0.3008	-0.2216	-0.3737	-0.7711	*****	*****	*****	*****	*****
0.575	*****	-0.3629	-0.2916	-0.4504	-0.8554	*****	*****	*****	*****	*****
0.600	-0.2440	-0.5174	-0.4733	-0.5718	-0.9618	*****	*****	*****	*****	*****
0.625	*****	*****	-0.7082	-0.7405	-1.0971	*****	*****	*****	*****	*****
0.650	-0.7383	-1.0478	-0.9926	-0.9305	-1.1292	*****	*****	*****	*****	*****
0.675	*****	-1.2006	-1.2027	-1.1213	-0.7063	*****	*****	*****	*****	*****
0.700	-1.0960	-1.2607	-1.3231	-1.1379	-0.6249	*****	*****	*****	*****	*****
0.725	*****	-1.2635	*****	-0.8543	-0.5538	*****	*****	*****	*****	*****
0.750	-1.1332	-1.2285	*****	-0.8135	-0.5230	*****	*****	*****	*****	*****
0.775	*****	-1.1888	-1.0441	-0.8126	-0.5098	*****	*****	*****	*****	*****
0.800	-1.0642	-1.1421	-0.9537	-0.8267	*****	*****	*****	*****	*****	*****
0.825	*****	-1.0930	-0.9189	-0.8330	-0.4829	*****	*****	*****	*****	*****
0.850	-1.0109	-1.0418	-0.9158	-0.8347	-0.4719	*****	*****	*****	*****	*****
0.875	*****	-1.0053	-0.9088	-0.8098	-0.4422	*****	*****	*****	*****	*****
0.900	-0.9354	-0.9812	-0.8805	-0.7997	*****	*****	*****	*****	*****	*****
0.925	*****	-0.9613	-0.8092	-0.8134	-0.3854	*****	*****	*****	*****	*****
0.950	-1.0142	-0.9495	-0.7935	-0.8120	-0.3490	*****	*****	*****	*****	*****
0.975	*****	-0.9464	-0.7830	-0.8008	-0.3271	*****	*****	*****	*****	*****
-0.200	$C_{p,l}$	0.2894	0.2712	0.2902	*****	*****	*****	*****	*****	*****
-0.400	$C_{p,l}$	0.2819	0.2749	0.2622	0.0867	-0.6770	*****	*****	*****	*****
-0.600	*****	0.2870	0.2531	0.1159	-0.6503	*****	*****	*****	*****	*****
-0.700	*****	0.2878	0.2620	0.1316	-0.6268	*****	*****	*****	*****	*****
-0.800	$C_{p,l}$	0.3359	0.3018	0.2647	0.1541	-0.5495	*****	*****	*****	*****
-0.850	$C_{p,l}$	0.3310	0.2971	0.2733	0.1637	-0.5294	*****	*****	*****	*****
-0.900	$C_{p,l}$	0.3142	0.3092	0.2816	0.1844	-0.4943	*****	*****	*****	*****
-0.950	*****	*****	0.2498	0.2498	0.1855	-0.1370	*****	*****	*****	*****
-0.975	*****	0.1751	0.1735	0.1332	-0.0261	*****	*****	*****	*****	*****

Sharp Radius L.E.
 Run No. = 88 , Point No. = 1945
 $C_N = 0.626$, $C_m = -0.1014$
 $\alpha = 13.5^\circ$, $M_\infty = 0.851$
 $R_{mac} = 6.0 \times 10^6$

Surface Pressures Near Leading Edge

● / ◆ upper, starboard/port
 ○ / ◇ lower, starboard/port

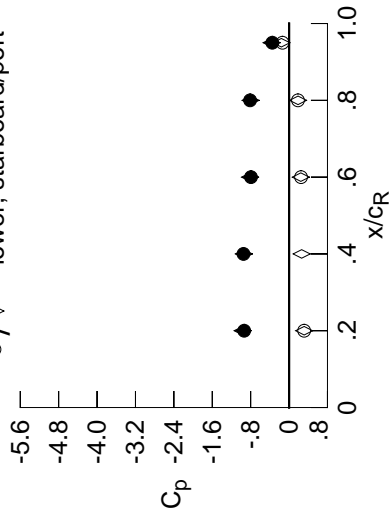

x/c_R	η	starb'd	port	starb'd	port
		$C_{p,u}$	$C_{p,l}$	$C_{p,u}$	$C_{p,l}$
0.20	0.90	-0.9354	-0.9673	0.3142	0.3142
0.40	0.95	-0.9495	-0.9415	0.2622	*****
0.60	0.95	-0.7935	-0.8132	0.2452	0.2498
0.80	0.95	-0.8120	-0.8013	0.1872	0.1855
0.95	0.95	-0.3490	-0.3642	-0.1611	-0.1370

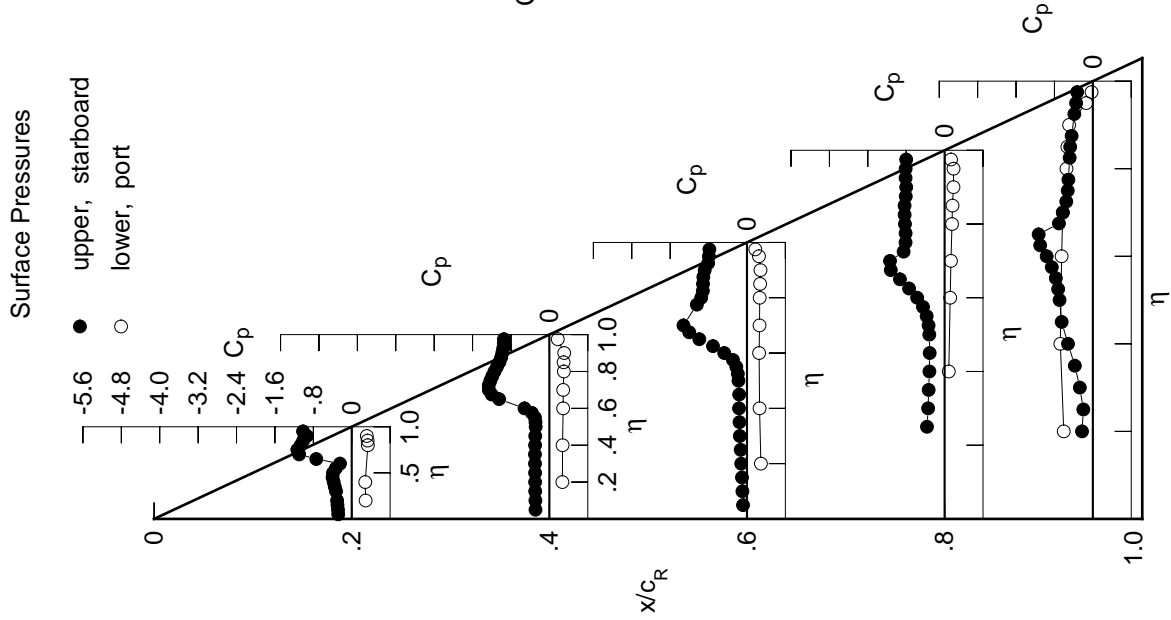

Table C1. Continued.

η	$x/c_R = .2$		$x/c_R = .4$		$x/c_R = .6$		$x/c_R = .8$		$x/c_R = .95$	
	$C_{p,u}$	$C_{p,u}$	$C_{p,u}$	$C_{p,u}$	$C_{p,u}$	$C_{p,u}$	$C_{p,u}$	$C_{p,u}$	$C_{p,u}$	$C_{p,u}$
0.050	-0.3087	-0.3274	-0.0996	*****	*****	*****	*****	*****	*****	*****
0.100	-0.3112	-0.3286	-0.1113	*****	*****	*****	*****	*****	*****	*****
0.150	-0.3220	-0.3326	-0.1233	*****	*****	*****	*****	*****	*****	*****
0.200	-0.3344	-0.3331	-0.1355	*****	*****	*****	*****	*****	*****	*****
0.250	*****	-0.3382	-0.1497	-0.3912	-0.2161	*****	*****	*****	*****	*****
0.300	-0.3623	-0.3353	-0.1646	-0.3694	-0.2917	*****	*****	*****	*****	*****
0.350	-0.3894	-0.3375	-0.1784	-0.3578	-0.3977	*****	*****	*****	*****	*****
0.400	-0.4121	-0.3335	-0.1841	-0.3464	-0.5428	*****	*****	*****	*****	*****
0.450	-0.4330	-0.3318	-0.1841	-0.3465	-0.6575	*****	*****	*****	*****	*****
0.500	-0.4184	-0.3311	-0.2193	-0.3764	-0.7190	*****	*****	*****	*****	*****
0.525	*****	-0.3476	-0.2622	-0.4093	-0.7635	*****	*****	*****	*****	*****
0.550	-0.3563	-0.3956	-0.3440	-0.4778	-0.8335	*****	*****	*****	*****	*****
0.575	*****	-0.5224	-0.4776	-0.5897	-0.9408	*****	*****	*****	*****	*****
0.600	-0.4939	-0.7398	-0.7155	-0.7349	-1.0518	*****	*****	*****	*****	*****
0.625	*****	*****	-0.9374	-0.9085	-1.1619	*****	*****	*****	*****	*****
0.650	-1.0777	-1.2201	-1.1627	-1.0829	-0.7104	*****	*****	*****	*****	*****
0.675	*****	-1.3282	-1.3091	-1.2247	-0.6521	*****	*****	*****	*****	*****
0.700	-1.0866	-1.3625	-1.3981	-0.9303	-0.5815	*****	*****	*****	*****	*****
0.725	*****	-1.3456	*****	-0.8531	-0.5311	*****	*****	*****	*****	*****
0.750	-1.1809	-1.3206	*****	-0.8406	-0.5137	*****	*****	*****	*****	*****
0.775	*****	-1.2767	-1.0282	-0.8489	-0.4999	*****	*****	*****	*****	*****
0.800	-1.1813	-1.2180	-1.0038	-0.8593	*****	*****	*****	*****	*****	*****
0.825	*****	-1.1477	-0.9871	-0.8624	-0.4649	*****	*****	*****	*****	*****
0.850	-1.0766	-1.0846	-0.9919	-0.8623	-0.4555	*****	*****	*****	*****	*****
0.875	*****	-1.0481	-0.9612	-0.8374	-0.4215	*****	*****	*****	*****	*****
0.900	-0.9921	-1.0220	-0.9050	-0.8326	*****	*****	*****	*****	*****	*****
0.925	*****	-0.9936	-0.8477	-0.8499	-0.3696	*****	*****	*****	*****	*****
0.950	-1.0586	-0.9746	-0.8397	-0.8504	-0.3392	*****	*****	*****	*****	*****
0.975	*****	-0.9692	-0.8289	-0.8423	-0.3222	*****	*****	*****	*****	*****

η	$x/c_R = .2$		$x/c_R = .4$		$x/c_R = .6$		$x/c_R = .8$		$x/c_R = .95$	
	$C_{p,l}$	$C_{p,l}$	$C_{p,l}$	$C_{p,l}$	$C_{p,l}$	$C_{p,l}$	$C_{p,l}$	$C_{p,l}$	$C_{p,l}$	$C_{p,l}$
-0.200	0.3159	0.2977	0.3086	*****	-0.6002	*****	*****	*****	*****	*****
-0.400	0.3117	0.3016	0.2817	0.1029	-0.6664	*****	*****	*****	*****	*****
-0.600	*****	0.3138	0.2732	0.1337	-0.6411	*****	*****	*****	*****	*****
-0.700	*****	0.3132	0.2803	0.1485	-0.6151	*****	*****	*****	*****	*****
-0.800	0.3597	0.3249	0.2816	0.1714	-0.5384	*****	*****	*****	*****	*****
-0.850	0.3505	0.3186	0.2905	0.1790	-0.5143	*****	*****	*****	*****	*****
-0.900	0.3258	0.3218	0.2936	0.1978	-0.4763	*****	*****	*****	*****	*****
-0.950	*****	*****	0.2505	0.1896	-0.1301	*****	*****	*****	*****	*****
-0.975	*****	0.1688	0.1623	0.1246	-0.0274	*****	*****	*****	*****	*****

Sharp Radius L.E.
 Run No. = 88, Point No. = 1946
 $C_N = 0.680$, $C_m = -0.1105$
 $\alpha = 14.5^\circ$, $M_\infty = 0.850$
 $R_{mac} = 6.0 \times 10^6$

Surface Pressures Near Leading Edge

● / ◆ upper, starboard/port
 ○ / ◇ lower, starboard/port

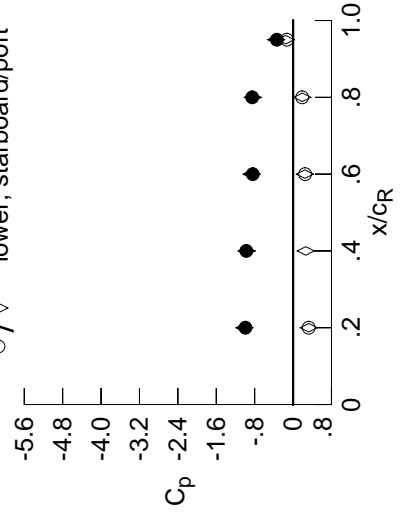

x/c_R	η	starb'd	port	starb'd	port
x/c_R	η	$C_{p,u}$	$C_{p,l}$	$C_{p,u}$	$C_{p,l}$
0.20	0.90	-0.9921	-1.0152	0.3257	0.3258
0.40	0.95	-0.9746	-0.9677	0.2636	*****
0.60	0.95	-0.8397	-0.8656	0.2449	0.2505
0.80	0.95	-0.8504	-0.8417	0.1928	0.1896
0.95	0.95	-0.3392	-0.3534	-0.1541	-0.1301

Table C1. Continued.

η	$x/c_R = .2$		$x/c_R = .4$		$x/c_R = .6$		$x/c_R = .8$		$x/c_R = .95$	
	$C_{p,u}$	$C_{p,u}$	$C_{p,u}$	$C_{p,u}$	$C_{p,u}$	$C_{p,u}$	$C_{p,u}$	$C_{p,u}$	$C_{p,u}$	$C_{p,u}$
0.050	-0.3296	-0.3687	-0.1194	*****	*****	*****	*****	*****	*****	*****
0.100	-0.3323	-0.3685	-0.1294	*****	*****	*****	*****	*****	*****	*****
0.150	-0.3466	-0.3724	-0.1427	*****	*****	*****	*****	*****	*****	*****
0.200	-0.3498	-0.3726	-0.1526	*****	*****	*****	*****	*****	*****	*****
0.250	*****	-0.3737	-0.1713	-0.4233	-0.2526	*****	*****	*****	*****	*****
0.300	-0.3695	-0.3764	-0.1837	-0.4053	-0.3238	*****	*****	*****	*****	*****
0.350	-0.3879	-0.3728	-0.1961	-0.3919	-0.4386	*****	*****	*****	*****	*****
0.400	-0.4017	-0.3747	-0.2110	-0.3878	-0.5900	*****	*****	*****	*****	*****
0.450	-0.4141	-0.3693	-0.2204	-0.4013	-0.6997	*****	*****	*****	*****	*****
0.500	-0.3974	-0.3915	-0.3010	-0.4585	-0.7731	*****	*****	*****	*****	*****
0.525	*****	-0.4365	-0.3844	-0.5169	-0.8336	*****	*****	*****	*****	*****
0.550	-0.3897	-0.5310	-0.5164	-0.6099	-0.9207	*****	*****	*****	*****	*****
0.575	*****	-0.7143	-0.6892	-0.7437	-1.0350	*****	*****	*****	*****	*****
0.600	-0.8439	-0.9412	-0.9186	-0.8945	-1.1471	*****	*****	*****	*****	*****
0.625	*****	*****	-1.1043	-1.0575	-0.7279	*****	*****	*****	*****	*****
0.650	-1.2891	-1.3407	-1.2774	-1.2055	-0.6631	*****	*****	*****	*****	*****
0.675	*****	-1.4327	-1.3951	-1.1305	-0.6187	*****	*****	*****	*****	*****
0.700	-1.3237	-1.4662	-1.3886	-0.9112	-0.5754	*****	*****	*****	*****	*****
0.725	*****	-1.4185	*****	-0.8958	-0.5349	*****	*****	*****	*****	*****
0.750	-1.2243	-1.3794	*****	-0.8835	-0.5238	*****	*****	*****	*****	*****
0.775	*****	-1.3453	-1.0677	-0.8948	-0.5005	*****	*****	*****	*****	*****
0.800	-1.1722	-1.2458	-1.0676	-0.9091	*****	*****	*****	*****	*****	*****
0.825	*****	-1.1614	-1.0796	-0.9124	-0.4506	*****	*****	*****	*****	*****
0.850	-1.1293	-1.1225	-1.1041	-0.9025	-0.4315	*****	*****	*****	*****	*****
0.875	*****	-1.0930	-1.0115	-0.8683	-0.4080	*****	*****	*****	*****	*****
0.900	-1.0431	-1.0620	-0.9401	-0.8544	*****	*****	*****	*****	*****	*****
0.925	*****	-1.0228	-0.8906	-0.8712	-0.3711	*****	*****	*****	*****	*****
0.950	-1.0930	-0.9985	-0.8814	-0.8729	-0.3435	*****	*****	*****	*****	*****
0.975	*****	-0.9854	-0.8723	-0.8640	-0.3253	*****	*****	*****	*****	*****
-0.200	$C_{p,l}$	0.3479	0.3165	0.3292	*****	*****	*****	*****	*****	*****
-0.400	$C_{p,l}$	0.3408	0.3231	0.2984	0.1165	-0.6554	*****	*****	*****	*****
-0.600	$C_{p,l}$	*****	0.3352	0.2915	0.1519	-0.6333	*****	*****	*****	*****
-0.700	$C_{p,l}$	*****	0.3330	0.2991	0.1583	-0.6044	*****	*****	*****	*****
-0.800	$C_{p,l}$	0.3797	0.3463	0.2986	0.1881	-0.5254	*****	*****	*****	*****
-0.850	$C_{p,l}$	0.3673	0.3323	0.3056	0.1947	-0.5020	*****	*****	*****	*****
-0.900	$C_{p,l}$	0.3371	0.3343	0.3033	0.2082	-0.4588	*****	*****	*****	*****
-0.950	$C_{p,l}$	*****	*****	0.2503	0.1896	-0.1250	*****	*****	*****	*****
-0.975	$C_{p,l}$	*****	0.1603	0.1531	0.1160	-0.0320	*****	*****	*****	*****

Sharp Radius L.E.

Run No. = 88 , Point No. = 1947

$C_N = 0.728$, $C_m = -0.1124$

$\alpha = 15.5^\circ$, $M_\infty = 0.851$

$R_{mac} = 6.0 \times 10^6$

Surface Pressures Near Leading Edge

● / ◆ upper, starboard/port
○ / ◇ lower, starboard/port

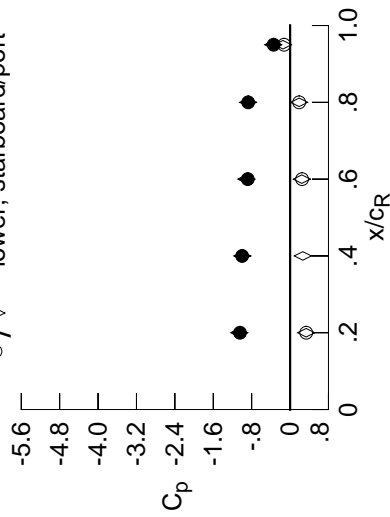

x/c_R	η	starb'd	port	starb'd	port
		$C_{p,u}$	$C_{p,l}$	$C_{p,u}$	$C_{p,l}$
0.20	0.90	-1.0431	-1.0585	0.3354	0.3371
0.40	0.95	-0.9985	-0.9949	0.2660	*****
0.60	0.95	-0.8814	-0.9115	0.2436	0.2503
0.80	0.95	-0.8729	-0.8743	0.1896	0.1896
0.95	0.95	-0.3435	-0.3520	-0.1477	-0.1250

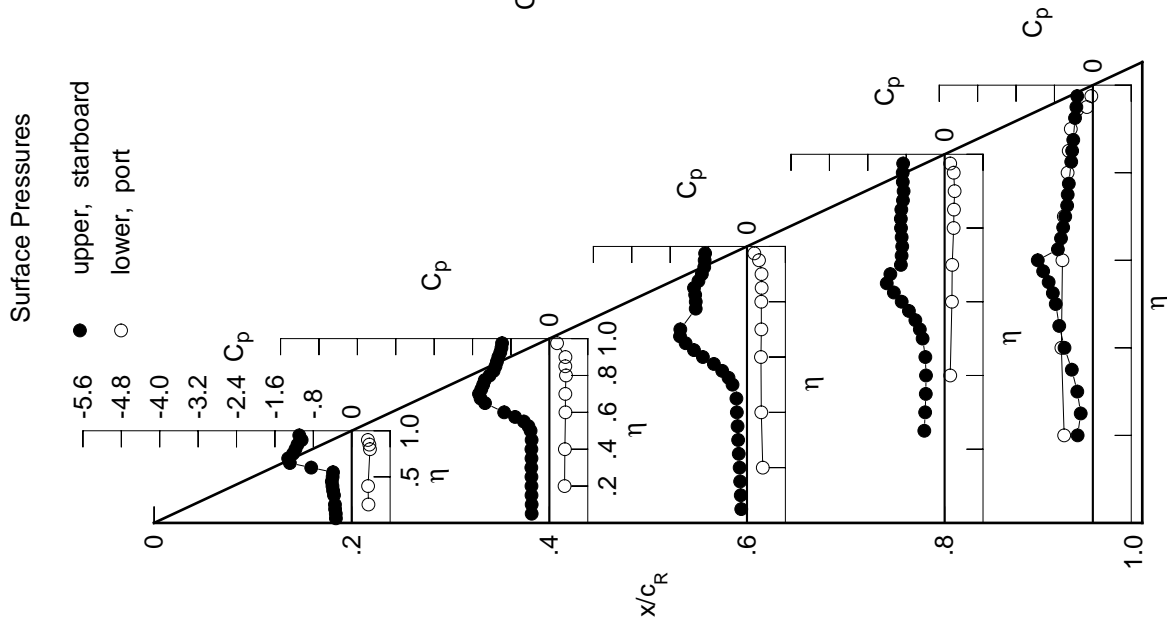

Table C1. Continued.

η	$x/c_R = .2$		$x/c_R = .4$		$x/c_R = .6$		$x/c_R = .8$		$x/c_R = .95$	
	$C_{p,u}$	$C_{p,l}$	$C_{p,u}$	$C_{p,l}$	$C_{p,u}$	$C_{p,l}$	$C_{p,u}$	$C_{p,l}$	$C_{p,u}$	$C_{p,l}$
0.050	-0.3555	-0.3984	-0.1380	*****	*****	*****	*****	*****	*****	*****
0.100	-0.3570	-0.3969	-0.1496	*****	*****	*****	*****	*****	*****	*****
0.150	-0.3676	-0.3990	-0.1627	*****	*****	*****	*****	*****	*****	*****
0.200	-0.3755	-0.3993	-0.1774	*****	*****	*****	*****	*****	*****	*****
0.250	*****	-0.4048	-0.1933	-0.4641	-0.3260	*****	*****	*****	*****	*****
0.300	-0.3808	-0.4043	-0.2105	-0.4454	-0.3920	*****	*****	*****	*****	*****
0.350	-0.3930	-0.4050	-0.2255	-0.4363	-0.5123	*****	*****	*****	*****	*****
0.400	-0.3959	-0.4041	-0.2484	-0.4376	-0.6546	*****	*****	*****	*****	*****
0.450	-0.3912	-0.4146	-0.2869	-0.4663	-0.7436	*****	*****	*****	*****	*****
0.500	-0.3690	-0.4715	-0.4189	-0.5608	-0.8383	*****	*****	*****	*****	*****
0.525	*****	-0.5553	-0.5393	-0.6382	-0.9101	*****	*****	*****	*****	*****
0.550	-0.5044	-0.6951	-0.6963	-0.7545	-1.0091	*****	*****	*****	*****	*****
0.575	*****	-0.9030	-0.8742	-0.8938	-1.1291	*****	*****	*****	*****	*****
0.600	-1.1141	-1.1121	-1.0769	-1.0402	-0.8958	*****	*****	*****	*****	*****
0.625	*****	*****	-1.2315	-1.1880	-0.6680	*****	*****	*****	*****	*****
0.650	-1.3761	-1.4462	-1.3733	-1.3096	-0.6482	*****	*****	*****	*****	*****
0.675	*****	-1.5269	-1.4071	-1.0206	-0.6301	*****	*****	*****	*****	*****
0.700	-1.4480	-1.5660	-1.1491	-0.9643	-0.5947	*****	*****	*****	*****	*****
0.725	*****	-1.4981	*****	-0.9563	-0.5629	*****	*****	*****	*****	*****
0.750	-1.3211	-1.3920	*****	-0.9511	-0.5433	*****	*****	*****	*****	*****
0.775	*****	-1.3185	-1.0932	-0.9600	-0.5081	*****	*****	*****	*****	*****
0.800	-1.2397	-1.2335	-1.1097	-0.9854	*****	*****	*****	*****	*****	*****
0.825	*****	-1.1806	-1.1489	-0.9899	-0.4388	*****	*****	*****	*****	*****
0.850	-1.1523	-1.1536	-1.1615	-0.9691	-0.4218	*****	*****	*****	*****	*****
0.875	*****	-1.1314	-1.0228	-0.9086	-0.4110	*****	*****	*****	*****	*****
0.900	-1.0846	-1.1028	-0.9701	-0.8707	*****	*****	*****	*****	*****	*****
0.925	*****	-1.0567	-0.9467	-0.8839	-0.3886	*****	*****	*****	*****	*****
0.950	-1.1245	-1.0246	-0.9384	-0.8918	-0.3607	*****	*****	*****	*****	*****
0.975	*****	-1.0128	-0.9272	-0.8847	-0.3437	*****	*****	*****	*****	*****

η	$x/c_R = .2$		$x/c_R = .4$		$x/c_R = .6$		$x/c_R = .8$		$x/c_R = .95$	
	$C_{p,u}$	$C_{p,l}$	$C_{p,u}$	$C_{p,l}$	$C_{p,u}$	$C_{p,l}$	$C_{p,u}$	$C_{p,l}$	$C_{p,u}$	$C_{p,l}$
-0.200	0.3745	0.3389	0.3448	*****	*****	*****	*****	*****	*****	*****
-0.400	0.3687	0.3399	0.3148	0.1324	-0.6467	*****	*****	*****	*****	*****
-0.600	*****	0.3593	0.3107	0.1615	-0.6228	*****	*****	*****	*****	*****
-0.700	*****	0.3531	0.3131	0.1745	-0.5947	*****	*****	*****	*****	*****
-0.800	0.3974	0.3631	0.3137	0.1988	-0.5152	*****	*****	*****	*****	*****
-0.850	0.3805	0.3450	0.3193	0.2061	-0.4914	*****	*****	*****	*****	*****
-0.900	0.3452	0.3421	0.3097	0.2160	-0.4460	*****	*****	*****	*****	*****
-0.950	*****	*****	0.2461	0.1889	-0.1251	*****	*****	*****	*****	*****
-0.975	*****	0.1517	0.1390	0.1052	-0.0410	*****	*****	*****	*****	*****

Sharp Radius L.E.
 Run No. = 88 , Point No. = 1948
 $C_N = 0.780$, $C_m = -0.1185$
 $\alpha = 16.5^\circ$, $M_\infty = 0.851$
 $R_{mac} = 6.0 \times 10^6$

Surface Pressures Near Leading Edge

● / ◆ upper, starboard/port
 ○ / ◇ lower, starboard/port

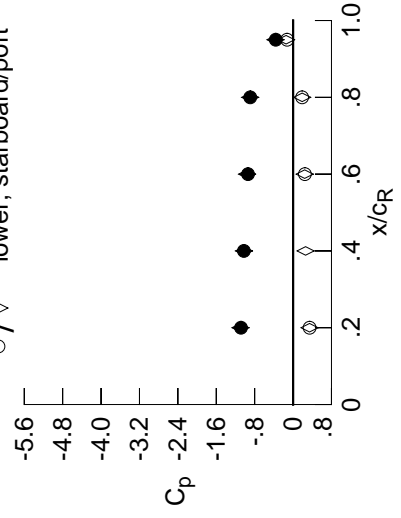

x/c_R	η	starb'd	port	starb'd	port
		$C_{p,u}$	$C_{p,l}$	$C_{p,u}$	$C_{p,l}$
0.20	0.90	-1.0846	-1.0960	0.3432	0.3452
0.40	0.95	-1.0246	-1.0230	0.2606	*****
0.60	0.95	-0.9384	-0.9585	0.2413	0.2461
0.80	0.95	-0.8918	-0.8939	0.1899	0.1889
0.95	0.95	-0.3607	-0.3672	-0.1458	-0.1251

Table C1. Continued.

η	$x/c_R = .2$		$x/c_R = .4$		$x/c_R = .6$		$x/c_R = .8$		$x/c_R = .95$	
	$C_{p,u}$	$C_{p,u}$	$C_{p,u}$	$C_{p,u}$	$C_{p,u}$	$C_{p,u}$	$C_{p,u}$	$C_{p,u}$	$C_{p,u}$	$C_{p,u}$
0.050	-0.3844	-0.4266	-0.1554	*****	*****	*****	*****	*****	*****	*****
0.100	-0.3859	-0.4236	-0.1670	*****	*****	*****	*****	*****	*****	*****
0.150	-0.3966	-0.4273	-0.1792	*****	*****	*****	*****	*****	*****	*****
0.200	-0.4025	-0.4290	-0.1939	*****	*****	*****	*****	*****	*****	*****
0.250	*****	-0.4304	-0.2141	-0.4907	-0.4817	*****	*****	*****	*****	*****
0.300	-0.4099	-0.4293	-0.2333	-0.4755	-0.5462	*****	*****	*****	*****	*****
0.350	-0.4186	-0.4304	-0.2562	-0.4727	-0.6387	*****	*****	*****	*****	*****
0.400	-0.4114	-0.4362	-0.2979	-0.4856	-0.7091	*****	*****	*****	*****	*****
0.450	-0.3952	-0.4653	-0.3671	-0.5377	-0.7715	*****	*****	*****	*****	*****
0.500	-0.4082	-0.5755	-0.5521	-0.6758	-0.8771	*****	*****	*****	*****	*****
0.525	*****	-0.6971	-0.6946	-0.7761	-0.9629	*****	*****	*****	*****	*****
0.550	-0.7649	-0.8644	-0.8637	-0.9044	-1.0676	*****	*****	*****	*****	*****
0.575	*****	-1.0718	-1.0339	-1.0455	-1.1827	*****	*****	*****	*****	*****
0.600	-1.3027	-1.2526	-1.2085	-1.1769	-0.7544	*****	*****	*****	*****	*****
0.625	*****	*****	-1.3387	-1.3053	-0.6752	*****	*****	*****	*****	*****
0.650	-1.4396	-1.5414	-1.4338	-1.3081	-0.6600	*****	*****	*****	*****	*****
0.675	*****	-1.6057	-1.1611	-1.0448	-0.6478	*****	*****	*****	*****	*****
0.700	-1.4847	-1.5989	-1.1108	-1.0231	-0.6268	*****	*****	*****	*****	*****
0.725	*****	-1.4423	*****	-1.0182	-0.5969	*****	*****	*****	*****	*****
0.750	-1.3797	-1.3710	*****	-1.0181	-0.5701	*****	*****	*****	*****	*****
0.775	*****	-1.3191	-1.1152	-1.0333	-0.5211	*****	*****	*****	*****	*****
0.800	-1.2962	-1.2713	-1.1435	-1.0517	*****	*****	*****	*****	*****	*****
0.825	*****	-1.2309	-1.1910	-1.0520	-0.4494	*****	*****	*****	*****	*****
0.850	-1.1794	-1.2006	-1.1485	-1.0387	-0.4232	*****	*****	*****	*****	*****
0.875	*****	-1.1727	-1.0188	-0.9614	-0.4338	*****	*****	*****	*****	*****
0.900	-1.1231	-1.1320	-1.0159	-0.8993	*****	*****	*****	*****	*****	*****
0.925	*****	-1.0859	-1.0141	-0.9056	-0.4173	*****	*****	*****	*****	*****
0.950	-1.1587	-1.0598	-1.0054	-0.9145	-0.3809	*****	*****	*****	*****	*****
0.975	*****	-1.0480	-0.9830	-0.9112	-0.3632	*****	*****	*****	*****	*****
-0.200	0.4045	0.3650	0.3638	*****	-0.5757	*****	*****	*****	*****	*****
-0.400	0.3986	0.3645	0.3363	0.1493	-0.6385	*****	*****	*****	*****	*****
-0.600	*****	0.3805	0.3292	0.1777	-0.6119	*****	*****	*****	*****	*****
-0.700	*****	0.3764	0.3324	0.1905	-0.5826	*****	*****	*****	*****	*****
-0.800	0.4172	0.3831	0.3310	0.2140	-0.5022	*****	*****	*****	*****	*****
-0.850	0.3954	0.3593	0.3329	0.2194	-0.4785	*****	*****	*****	*****	*****
-0.900	0.3552	0.3501	0.3188	0.2257	-0.4305	*****	*****	*****	*****	*****
-0.950	*****	*****	0.2431	0.1884	-0.1223	*****	*****	*****	*****	*****
-0.975	*****	0.1428	0.1265	0.0965	-0.0471	*****	*****	*****	*****	*****

Sharp Radius L.E.
 Run No. = 88 , Point No. = 1949
 $C_N = 0.841$, $C_m = -0.1324$
 $\alpha = 17.5^\circ$, $M_\infty = 0.850$
 $R_{mac} = 6.0 \times 10^6$

Surface Pressures Near Leading Edge

● / ◆ upper, starboard/port
 ○ / ◇ lower, starboard/port

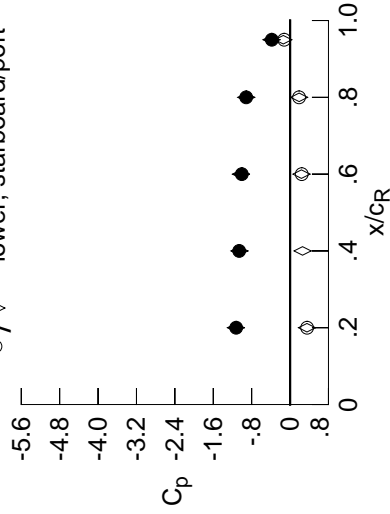

x/c_R	η	starb'd	port	starb'd	port
		$C_{p,u}$	$C_{p,u}$	$C_{p,l}$	$C_{p,l}$
0.20	0.90	-1.1231	-1.1287	0.3516	0.3552
0.40	0.95	-1.0598	-1.0555	0.2600	*****
0.60	0.95	-1.0054	-1.0244	0.2368	0.2431
0.80	0.95	-0.9145	-0.9132	0.1890	0.1884
0.95	0.95	-0.3809	-0.3879	-0.1416	-0.1223

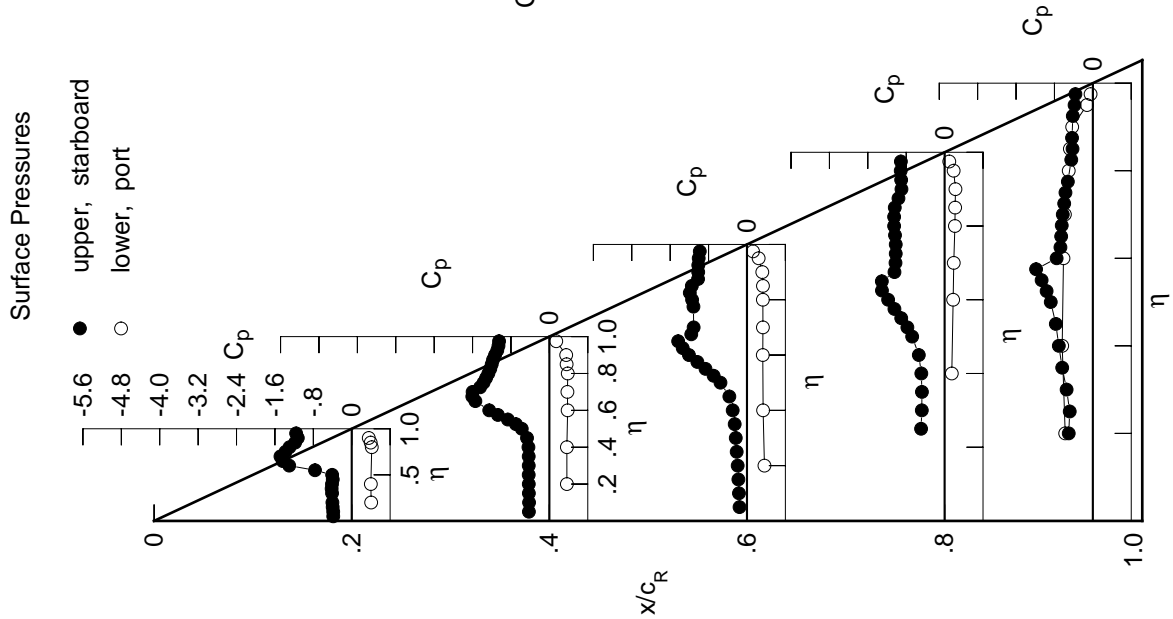

Table C1. Continued.

η	$x/c_R = .2$		$x/c_R = .4$		$x/c_R = .6$		$x/c_R = .8$		$x/c_R = .95$	
	$C_{p,u}$	$C_{p,l}$	$C_{p,u}$	$C_{p,l}$	$C_{p,u}$	$C_{p,l}$	$C_{p,u}$	$C_{p,l}$	$C_{p,u}$	$C_{p,l}$
0.050	-0.4118	-0.4479	-0.1943	*****	*****	*****	*****	*****	*****	*****
0.100	-0.4153	-0.4488	-0.2083	*****	*****	*****	*****	*****	*****	*****
0.150	-0.4233	-0.4498	-0.2246	*****	*****	*****	*****	*****	*****	*****
0.200	-0.4292	-0.4521	-0.2463	*****	*****	*****	*****	*****	*****	*****
0.250	*****	-0.4549	-0.2682	-0.5153	-0.5286	*****	*****	*****	*****	*****
0.300	-0.4358	-0.4562	-0.2994	-0.5004	-0.5864	*****	*****	*****	*****	*****
0.350	-0.4414	-0.4600	-0.3351	-0.5050	-0.6498	*****	*****	*****	*****	*****
0.400	-0.4346	-0.4823	-0.3993	-0.5324	-0.6969	*****	*****	*****	*****	*****
0.450	-0.4387	-0.5441	-0.5023	-0.6194	-0.7684	*****	*****	*****	*****	*****
0.500	-0.5727	-0.7139	-0.7313	-0.7872	-0.9001	*****	*****	*****	*****	*****
0.525	*****	-0.8685	-0.8844	-0.9002	-0.9950	*****	*****	*****	*****	*****
0.550	-1.0559	-1.0428	-1.0447	-1.0274	-1.1120	*****	*****	*****	*****	*****
0.575	*****	-1.2293	-1.1955	-1.1612	-1.2183	*****	*****	*****	*****	*****
0.600	-1.4361	-1.3767	-1.3432	-1.2766	-0.7919	*****	*****	*****	*****	*****
0.625	*****	*****	-1.4488	-1.3870	-0.7138	*****	*****	*****	*****	*****
0.650	-1.5023	-1.6142	-1.2693	-1.1713	-0.6795	*****	*****	*****	*****	*****
0.675	*****	-1.6093	-1.1706	-1.0817	-0.6639	*****	*****	*****	*****	*****
0.700	-1.4806	-1.4453	-1.1601	-1.0755	-0.6596	*****	*****	*****	*****	*****
0.725	*****	-1.3860	*****	-1.0893	-0.6372	*****	*****	*****	*****	*****
0.750	-1.3815	-1.3795	*****	-1.1004	-0.6072	*****	*****	*****	*****	*****
0.775	*****	-1.3776	-1.1766	-1.1163	-0.5555	*****	*****	*****	*****	*****
0.800	-1.2851	-1.3656	-1.2149	-1.1259	*****	*****	*****	*****	*****	*****
0.825	*****	-1.3133	-1.2431	-1.1051	-0.4839	*****	*****	*****	*****	*****
0.850	-1.2073	-1.2509	-1.1719	-1.0878	-0.4396	*****	*****	*****	*****	*****
0.875	*****	-1.2074	-1.0497	-1.0158	-0.4680	*****	*****	*****	*****	*****
0.900	-1.1572	-1.1652	-1.0659	-0.9455	*****	*****	*****	*****	*****	*****
0.925	*****	-1.1222	-1.0722	-0.9431	-0.4564	*****	*****	*****	*****	*****
0.950	-1.1947	-1.1037	-1.0709	-0.9490	-0.4076	*****	*****	*****	*****	*****
0.975	*****	-1.0933	-1.0550	-0.9469	-0.3864	*****	*****	*****	*****	*****

η	$x/c_R = .2$		$x/c_R = .4$		$x/c_R = .6$		$x/c_R = .8$		$x/c_R = .95$	
	$C_{p,u}$	$C_{p,l}$	$C_{p,u}$	$C_{p,l}$	$C_{p,u}$	$C_{p,l}$	$C_{p,u}$	$C_{p,l}$	$C_{p,u}$	$C_{p,l}$
-0.200	0.4328	0.3827	0.3823	*****	*****	*****	*****	*****	*****	*****
-0.400	0.4278	0.3857	0.3543	0.1646	-0.6268	*****	*****	*****	*****	*****
-0.600	*****	0.3971	0.3461	0.1934	-0.5988	*****	*****	*****	*****	*****
-0.700	*****	0.3969	0.3509	0.2039	-0.5715	*****	*****	*****	*****	*****
-0.800	0.4356	0.4015	0.3468	0.2269	-0.4878	*****	*****	*****	*****	*****
-0.850	0.4098	0.3743	0.3452	0.2311	-0.4648	*****	*****	*****	*****	*****
-0.900	0.3624	0.3582	0.3258	0.2342	-0.4158	*****	*****	*****	*****	*****
-0.950	*****	*****	0.2370	0.1857	-0.1202	*****	*****	*****	*****	*****
-0.975	*****	0.1337	0.1131	0.0857	-0.0541	*****	*****	*****	*****	*****

Sharp Radius L.E.
 Run No. = 88 , Point No. = 1950
 $C_N = 0.899$, $C_m = -0.1429$
 $\alpha = 18.6^\circ$, $M_\infty = 0.851$
 $R_{mac} = 6.0 \times 10^6$

Surface Pressures Near Leading Edge

● / ◆ upper, starboard/port
 ○ / ◇ lower, starboard/port

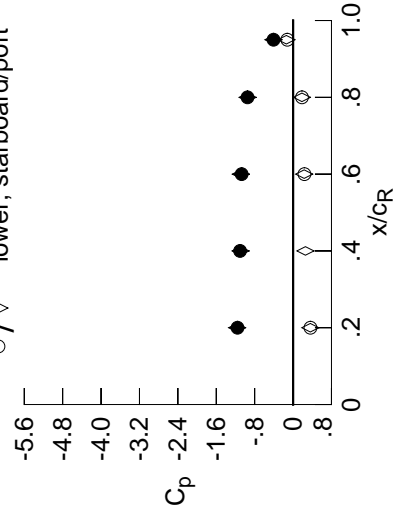

x/c_R	η	starb'd	port	starb'd	port
		$C_{p,u}$	$C_{p,l}$	$C_{p,u}$	$C_{p,l}$
0.20	0.90	-1.1572	-1.1653	0.3594	0.3624
0.40	0.95	-1.1037	-1.0935	0.2579	*****
0.60	0.95	-1.0709	-1.0897	0.2311	0.2370
0.80	0.95	-0.9490	-0.9479	0.1846	0.1857
0.95	0.95	-0.4076	-0.4099	-0.1404	-0.1202

Table C1. Continued.

η	x/c_R	x/c_R	x/c_R	x/c_R	x/c_R	x/c_R	x/c_R
	$C_{p,u}$	$C_{p,u}$	$C_{p,u}$	$C_{p,u}$	$C_{p,u}$	$C_{p,u}$	$C_{p,u}$
0.050	-0.4444	-0.4889	-0.2961	*****	*****	*****	*****
0.100	-0.4454	-0.4892	-0.3143	*****	*****	*****	*****
0.150	-0.4527	-0.4914	-0.3359	*****	*****	*****	*****
0.200	-0.4580	-0.4943	-0.3664	*****	*****	-0.3662	*****
0.250	*****	-0.4984	-0.4004	-0.5570	-0.4871	*****	*****
0.300	-0.4650	-0.5030	-0.4386	-0.5431	-0.5499	*****	*****
0.350	-0.4702	-0.5175	-0.4836	-0.5535	-0.6032	*****	*****
0.400	-0.4723	-0.5577	-0.5629	-0.5974	-0.6621	*****	*****
0.450	-0.5290	-0.6655	-0.6927	-0.7026	-0.7564	*****	*****
0.500	-0.8070	-0.8882	-0.9362	-0.8897	-0.9210	*****	*****
0.525	*****	-1.0522	-1.0828	-0.9993	-1.0259	*****	*****
0.550	-1.2635	-1.2135	-1.2241	-1.1217	-1.1506	*****	*****
0.575	*****	-1.3661	-1.3470	-1.2413	-1.2524	*****	*****
0.600	-1.5261	-1.4807	-1.4611	-1.3480	-0.8153	*****	*****
0.625	*****	*****	-1.5248	-1.4431	-0.7179	*****	*****
0.650	-1.5316	-1.6307	-1.2787	-1.1697	-0.6741	*****	*****
0.675	*****	-1.4199	-1.2506	-1.1154	-0.6774	*****	*****
0.700	-1.4660	-1.3691	-1.2442	-1.1123	-0.6709	*****	*****
0.725	*****	-1.3637	*****	-1.1205	-0.6419	*****	*****
0.750	-1.3446	-1.3780	*****	-1.1281	-0.6122	*****	*****
0.775	*****	-1.4029	-1.2615	-1.1409	-0.5674	*****	*****
0.800	-1.2909	-1.4150	-1.3038	-1.1388	*****	*****	*****
0.825	*****	-1.3761	-1.3277	-1.1153	-0.5143	*****	*****
0.850	-1.2422	-1.3157	-1.2675	-1.0996	-0.4599	*****	*****
0.875	*****	-1.2563	-1.1405	-1.0348	-0.4851	*****	*****
0.900	-1.1989	-1.2072	-1.1594	-0.9642	*****	*****	*****
0.925	*****	-1.1777	-1.1627	-0.9654	-0.4630	*****	*****
0.950	-1.2464	-1.1671	-1.1593	-0.9725	-0.4125	*****	*****
0.975	*****	-1.1590	-1.1484	-0.9719	-0.3900	*****	*****
-0.200	$C_{p,l}$	$C_{p,l}$	$C_{p,l}$	$C_{p,l}$	$C_{p,l}$	$C_{p,l}$	$C_{p,l}$
-0.400	0.4630	0.4087	0.4002	*****	-0.5599	*****	*****
-0.600	0.4567	0.4107	0.3739	0.1851	-0.6159	*****	*****
-0.700	*****	0.4251	0.3674	0.2098	-0.5850	*****	*****
-0.800	0.4560	0.4206	0.3716	0.2230	-0.5557	*****	*****
-0.850	0.4263	0.3913	0.3623	0.2419	-0.4732	*****	*****
-0.900	0.3727	0.3663	0.3359	0.2442	-0.3984	*****	*****
-0.950	*****	*****	0.2364	0.1860	-0.1146	*****	*****
-0.975	*****	0.1273	0.1041	0.0771	-0.0572	*****	*****

Sharp Radius L.E.
 Run No. = 88, Point No. = 1951
 $C_N = 0.959$, $C_m = -0.1538$
 $\alpha = 19.6^\circ$, $M_\infty = 0.850$
 $R_{mac} = 6.0 \times 10^6$

Surface Pressures Near Leading Edge

● / ◆ upper, starboard/port
 ○ / ◇ lower, starboard/port

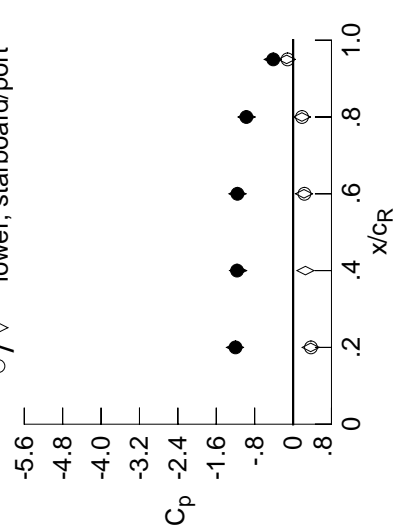

x/c_R	η	starb'd	port	starb'd	port
		$C_{p,u}$	$C_{p,u}$	$C_{p,l}$	$C_{p,l}$
0.20	0.90	-1.1989	-1.2099	0.3674	0.3727
0.40	0.95	-1.1671	-1.1444	0.2573	*****
0.60	0.95	-1.1593	-1.1590	0.2275	0.2364
0.80	0.95	-0.9725	-0.9696	0.1841	0.1860
0.95	0.95	-0.4125	-0.4234	-0.1333	-0.1146

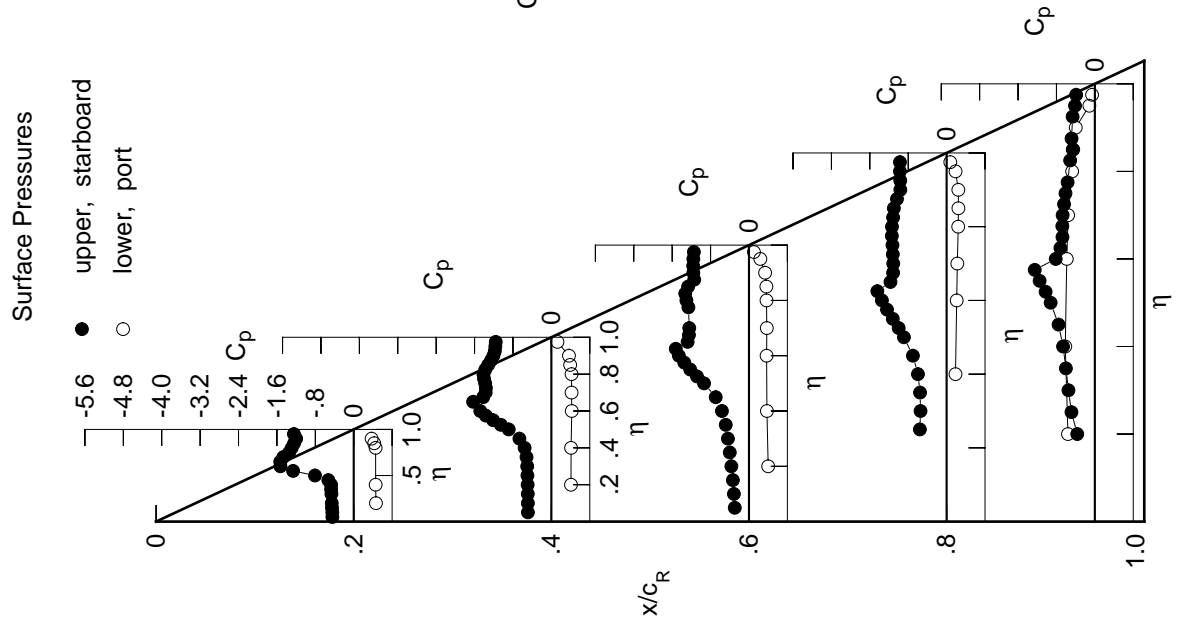

Table C1. Continued.

η	$x/c_R = .2$		$x/c_R = .4$		$x/c_R = .6$		$x/c_R = .8$		$x/c_R = .95$	
	$C_{p,u}$	$C_{p,l}$	$C_{p,u}$	$C_{p,l}$	$C_{p,u}$	$C_{p,l}$	$C_{p,u}$	$C_{p,l}$	$C_{p,u}$	$C_{p,l}$
0.050	-0.4796	-0.5279	-0.4405	*****	*****	*****	*****	*****	*****	*****
0.100	-0.4802	-0.5269	-0.4547	*****	*****	*****	*****	*****	*****	*****
0.150	-0.4911	-0.5325	-0.4740	*****	*****	*****	*****	*****	*****	*****
0.200	-0.4927	-0.5358	-0.4951	*****	*****	*****	*****	*****	*****	*****
0.250	*****	-0.5414	-0.5189	-0.5947	-0.4475	*****	*****	*****	*****	*****
0.300	-0.5013	-0.5518	-0.5499	-0.5979	-0.5235	*****	*****	*****	*****	*****
0.350	-0.5124	-0.5773	-0.5929	-0.6239	-0.5783	*****	*****	*****	*****	*****
0.400	-0.5385	-0.6485	-0.6880	-0.6810	-0.6511	*****	*****	*****	*****	*****
0.450	-0.6712	-0.8024	-0.8521	-0.7986	-0.7634	*****	*****	*****	*****	*****
0.500	-1.0242	-1.0683	-1.1041	-0.9901	-0.9468	*****	*****	*****	*****	*****
0.525	*****	-1.2216	-1.2339	-1.0944	-1.0567	*****	*****	*****	*****	*****
0.550	-1.3957	-1.3542	-1.3558	-1.2081	-1.1789	*****	*****	*****	*****	*****
0.575	*****	-1.4725	-1.4560	-1.3165	-1.2072	*****	*****	*****	*****	*****
0.600	-1.5027	-1.5530	-1.5464	-1.4092	-0.7924	*****	*****	*****	*****	*****
0.625	*****	*****	-1.5115	-1.4957	-0.7035	*****	*****	*****	*****	*****
0.650	-1.4872	-1.4497	-1.3277	-1.2099	-0.6865	*****	*****	*****	*****	*****
0.675	*****	-1.3531	-1.3177	-1.1532	-0.6802	*****	*****	*****	*****	*****
0.700	-1.4055	-1.3472	-1.3129	-1.1393	-0.6529	*****	*****	*****	*****	*****
0.725	*****	-1.3442	*****	-1.1357	-0.6027	*****	*****	*****	*****	*****
0.750	-1.3755	-1.3570	*****	-1.1368	-0.5657	*****	*****	*****	*****	*****
0.775	*****	-1.3789	-1.3321	-1.1460	-0.5309	*****	*****	*****	*****	*****
0.800	-1.3382	-1.3967	-1.3678	-1.1438	*****	*****	*****	*****	*****	*****
0.825	*****	-1.3765	-1.3805	-1.1191	-0.5180	*****	*****	*****	*****	*****
0.850	-1.2782	-1.3241	-1.3260	-1.1143	-0.4773	*****	*****	*****	*****	*****
0.875	*****	-1.2747	-1.1937	-1.0396	-0.5008	*****	*****	*****	*****	*****
0.900	-1.2404	-1.2536	-1.2136	-0.9504	*****	*****	*****	*****	*****	*****
0.925	*****	-1.2463	-1.2185	-0.9505	-0.4750	*****	*****	*****	*****	*****
0.950	-1.2934	-1.2440	-1.2178	-0.9641	-0.4234	*****	*****	*****	*****	*****
0.975	*****	-1.2396	-1.2086	-0.9688	-0.3957	*****	*****	*****	*****	*****

η	$x/c_R = .95$		$x/c_R = .8$		$x/c_R = .6$		$x/c_R = .4$		$x/c_R = .2$	
	$C_{p,u}$	$C_{p,l}$	$C_{p,u}$	$C_{p,l}$	$C_{p,u}$	$C_{p,l}$	$C_{p,u}$	$C_{p,l}$	$C_{p,u}$	$C_{p,l}$
-0.200	0.4902	0.4318	0.4173	*****	*****	*****	*****	*****	*****	*****
-0.400	0.4854	0.4354	0.3937	0.1988	-0.6020	*****	*****	*****	*****	*****
-0.600	*****	0.4467	0.3866	0.2268	-0.5777	*****	*****	*****	*****	*****
-0.700	*****	0.4428	0.3872	0.2348	-0.5446	*****	*****	*****	*****	*****
-0.800	0.4719	0.4384	0.3790	0.2571	-0.4617	*****	*****	*****	*****	*****
-0.850	0.4381	0.4012	0.3710	0.2574	-0.4374	*****	*****	*****	*****	*****
-0.900	0.3806	0.3750	0.3390	0.2517	-0.3839	*****	*****	*****	*****	*****
-0.950	*****	*****	0.2324	0.1837	-0.1110	*****	*****	*****	*****	*****
-0.975	*****	0.1164	0.0934	0.0684	-0.0605	*****	*****	*****	*****	*****

Sharp Radius L.E.
 Run No. = 88 , Point No. = 1952
 $C_N = 1.017$, $C_m = -0.1656$
 $\alpha = 20.6^\circ$, $M_\infty = 0.850$
 $R_{mac} = 6.0 \times 10^6$

Surface Pressures Near Leading Edge

● / ◆ upper, starboard/port
 ○ / ◇ lower, starboard/port

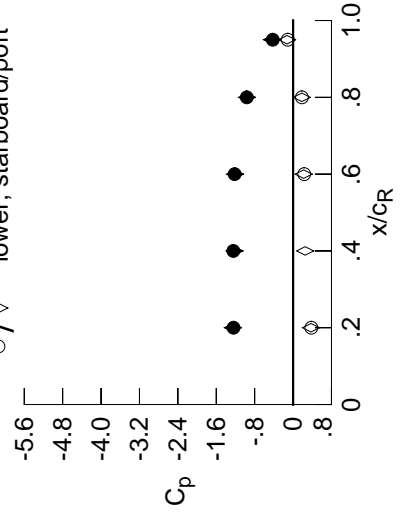

x/c_R	η	starb'd	port	$C_{p,u}$	starb'd	port	$C_{p,l}$
0.20	0.90	-1.2404	-1.2562	0.3733	0.3806	*****	*****
0.40	0.95	-1.2440	-1.2201	0.2519	*****	*****	*****
0.60	0.95	-1.2178	-1.2092	0.2209	0.2324	*****	*****
0.80	0.95	-0.9641	-0.9598	0.1825	0.1837	*****	*****
0.95	0.95	-0.4234	-0.4407	-0.1259	-0.1110	*****	*****

Table C1. Continued.

η	$x/c_R = .2$		$x/c_R = .4$		$x/c_R = .6$		$x/c_R = .8$		$x/c_R = .95$	
	$C_{p,u}$	$C_{p,u}$	$C_{p,u}$	$C_{p,u}$	$C_{p,u}$	$C_{p,u}$	$C_{p,u}$	$C_{p,u}$	$C_{p,u}$	$C_{p,u}$
0.050	-0.5175	-0.5638	-0.5450	*****	*****	*****	*****	*****	*****	*****
0.100	-0.5185	-0.5639	-0.5517	*****	*****	*****	*****	*****	*****	*****
0.150	-0.5263	-0.5693	-0.5579	*****	*****	*****	*****	*****	*****	*****
0.200	-0.5321	-0.5712	-0.5664	*****	*****	*****	*****	*****	*****	*****
0.250	*****	-0.5819	-0.5823	-0.5595	-0.4302	*****	*****	*****	*****	*****
0.300	-0.5459	-0.5982	-0.6112	-0.5845	-0.5190	*****	*****	*****	*****	*****
0.350	-0.5709	-0.6400	-0.6678	-0.6381	-0.5829	*****	*****	*****	*****	*****
0.400	-0.6369	-0.7433	-0.7856	-0.7315	-0.6763	*****	*****	*****	*****	*****
0.450	-0.8337	-0.9486	-0.9696	-0.8751	-0.8079	*****	*****	*****	*****	*****
0.500	-1.1853	-1.2106	-1.2091	-1.0725	-0.9957	*****	*****	*****	*****	*****
0.525	*****	-1.3414	-1.3272	-1.1697	-1.0961	*****	*****	*****	*****	*****
0.550	-1.4775	-1.4476	-1.4304	-1.2746	-1.1838	*****	*****	*****	*****	*****
0.575	*****	-1.5367	-1.5159	-1.3724	-0.8249	*****	*****	*****	*****	*****
0.600	-1.4506	-1.6008	-1.5917	-1.4553	-0.7050	*****	*****	*****	*****	*****
0.625	*****	*****	-1.4922	-1.5326	-0.6725	*****	*****	*****	*****	*****
0.650	-1.4554	-1.4393	-1.3731	-1.2609	-0.6527	*****	*****	*****	*****	*****
0.675	*****	-1.3845	-1.3635	-1.2014	-0.6379	*****	*****	*****	*****	*****
0.700	-1.4303	-1.3739	-1.3590	-1.1896	-0.6047	*****	*****	*****	*****	*****
0.725	*****	-1.3684	*****	-1.1771	-0.5556	*****	*****	*****	*****	*****
0.750	-1.4413	-1.3777	*****	-1.1662	-0.5370	*****	*****	*****	*****	*****
0.775	*****	-1.4026	-1.3648	-1.1554	-0.5344	*****	*****	*****	*****	*****
0.800	-1.4033	-1.4268	-1.4119	-1.1443	*****	*****	*****	*****	*****	*****
0.825	*****	-1.4025	-1.4309	-1.1320	-0.5692	*****	*****	*****	*****	*****
0.850	-1.3188	-1.3471	-1.3682	-1.1502	-0.5073	*****	*****	*****	*****	*****
0.875	*****	-1.3027	-1.2157	-1.0822	-0.5463	*****	*****	*****	*****	*****
0.900	-1.2844	-1.2913	-1.2418	-0.9602	*****	*****	*****	*****	*****	*****
0.925	*****	-1.2911	-1.2509	-0.9341	-0.5128	*****	*****	*****	*****	*****
0.950	-1.3385	-1.2908	-1.2539	-0.9526	-0.4610	*****	*****	*****	*****	*****
0.975	*****	-1.2886	-1.2450	-0.9646	-0.4279	*****	*****	*****	*****	*****
-0.200	$C_{p,l}$	0.4565	0.4349	*****	-0.5404	$C_{p,l}$	$C_{p,l}$	$C_{p,l}$	$C_{p,l}$	$C_{p,l}$
-0.400	0.5134	0.4585	0.4108	0.2159	-0.5932	0.4585	0.4108	0.2159	-0.5932	0.4585
-0.600	*****	0.4687	0.4029	0.2388	-0.5647	0.4687	0.4029	0.2388	-0.5647	0.4687
-0.700	*****	0.4636	0.4037	0.2519	-0.5353	0.4636	0.4037	0.2519	-0.5353	0.4636
-0.800	0.4884	0.4550	0.3929	0.2674	-0.4505	0.4884	0.4550	0.3929	0.2674	-0.4505
-0.850	0.4489	0.4103	0.3818	0.2700	-0.4254	0.4489	0.4103	0.3818	0.2700	-0.4254
-0.900	0.3869	0.3793	0.3439	0.2587	-0.3723	0.3869	0.3793	0.3439	0.2587	-0.3723
-0.950	*****	*****	0.2241	0.1820	-0.1119	*****	*****	0.2241	0.1820	-0.1119
-0.975	*****	0.1113	0.0819	0.0594	-0.0730	*****	0.1113	0.0819	0.0594	-0.0730

Sharp Radius L.E.
 Run No. = 88 , Point No. = 1953
 $C_N = 1.073$, $C_m = -0.1773$
 $\alpha = 21.6^\circ$, $M_\infty = 0.850$
 $R_{mac} = 6.0 \times 10^6$

Surface Pressures Near Leading Edge

● / ◆ upper, starboard/port
 ○ / ◇ lower, starboard/port

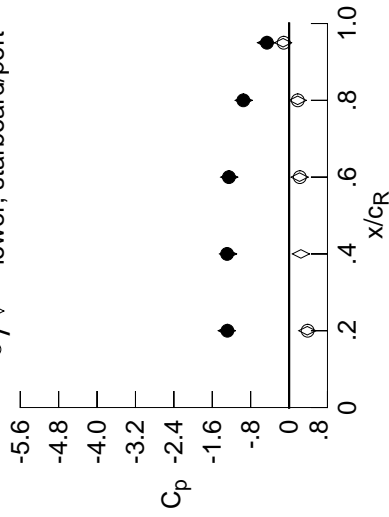

x/c_R	η	starb'd	port	starb'd	port
		$C_{p,u}$	$C_{p,u}$	$C_{p,l}$	$C_{p,l}$
0.20	0.90	-1.2844	-1.2986	0.3791	0.3869
0.40	0.95	-1.2908	-1.2715	0.2461	*****
0.60	0.95	-1.2539	-1.2476	0.2187	0.2241
0.80	0.95	-0.9526	-0.9453	0.1790	0.1820
0.95	0.95	-0.4610	-0.4811	-0.1245	-0.1119

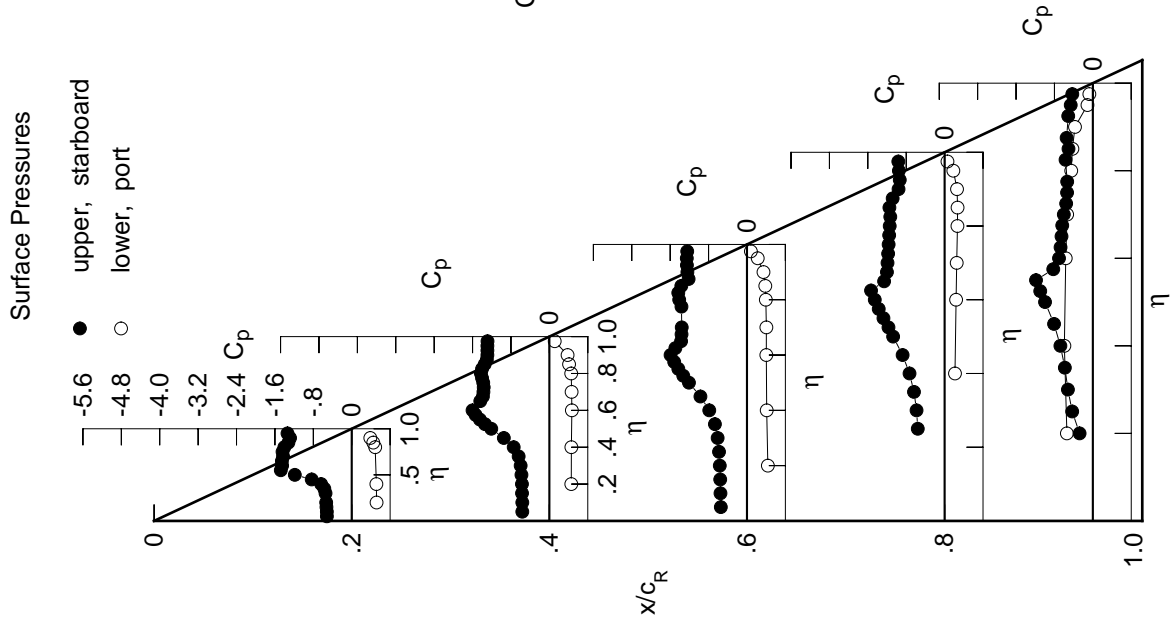

Table C1. Continued.

η	$x/c_R = .2$		$x/c_R = .4$		$x/c_R = .6$		$x/c_R = .8$		$x/c_R = .95$	
	$C_{p,u}$	$C_{p,u}$	$C_{p,u}$	$C_{p,u}$	$C_{p,u}$	$C_{p,u}$	$C_{p,u}$	$C_{p,u}$	$C_{p,u}$	$C_{p,u}$
0.050	-0.5531	-0.5985	-0.5946	*****	*****	*****	*****	*****	*****	*****
0.100	-0.5574	-0.5973	-0.5976	*****	*****	*****	*****	*****	*****	*****
0.150	-0.5697	-0.6018	-0.6035	*****	*****	*****	*****	*****	*****	*****
0.200	-0.5717	-0.6060	-0.6132	*****	*****	*****	*****	*****	*****	*****
0.250	*****	-0.6194	-0.6319	-0.5191	-0.4268	*****	*****	*****	*****	*****
0.300	-0.5963	-0.6487	-0.6725	-0.5462	-0.5249	*****	*****	*****	*****	*****
0.350	-0.6437	-0.7102	-0.7427	-0.6116	-0.6018	*****	*****	*****	*****	*****
0.400	-0.7469	-0.8452	-0.8766	-0.7201	-0.7087	*****	*****	*****	*****	*****
0.450	-0.9801	-1.0624	-1.0618	-0.8888	-0.8611	*****	*****	*****	*****	*****
0.500	-1.3000	-1.3033	-1.2864	-1.0979	-1.0524	*****	*****	*****	*****	*****
0.525	*****	-1.4146	-1.3896	-1.1977	-1.1459	*****	*****	*****	*****	*****
0.550	-1.4941	-1.5039	-1.4806	-1.3017	-0.9184	*****	*****	*****	*****	*****
0.575	*****	-1.5816	-1.5574	-1.3982	-0.7091	*****	*****	*****	*****	*****
0.600	-1.4569	-1.6306	-1.6238	-1.4770	-0.6854	*****	*****	*****	*****	*****
0.625	*****	*****	-1.4944	-1.5332	-0.6746	*****	*****	*****	*****	*****
0.650	-1.4617	-1.4445	-1.4099	-1.2390	-0.6663	*****	*****	*****	*****	*****
0.675	*****	-1.4254	-1.4029	-1.1976	-0.6473	*****	*****	*****	*****	*****
0.700	-1.4637	-1.4059	-1.3914	-1.1913	-0.6019	*****	*****	*****	*****	*****
0.725	*****	-1.4008	*****	-1.1876	-0.5645	*****	*****	*****	*****	*****
0.750	-1.5035	-1.4082	*****	-1.1633	-0.5703	*****	*****	*****	*****	*****
0.775	*****	-1.4408	-1.3951	-1.1446	-0.5889	*****	*****	*****	*****	*****
0.800	-1.4502	-1.4709	-1.4507	-1.1363	*****	*****	*****	*****	*****	*****
0.825	*****	-1.4403	-1.4726	-1.1293	-0.6439	*****	*****	*****	*****	*****
0.850	-1.3555	-1.3799	-1.4047	-1.1675	-0.5596	*****	*****	*****	*****	*****
0.875	*****	-1.3343	-1.2442	-1.1168	-0.6313	*****	*****	*****	*****	*****
0.900	-1.3246	-1.3218	-1.2701	-0.9749	*****	*****	*****	*****	*****	*****
0.925	*****	-1.3240	-1.2853	-0.9133	-0.6109	*****	*****	*****	*****	*****
0.950	-1.3758	-1.3246	-1.2882	-0.9139	-0.5300	*****	*****	*****	*****	*****
0.975	*****	-1.3263	-1.2794	-0.9195	-0.5034	*****	*****	*****	*****	*****

η	$x/c_R = .2$		$x/c_R = .4$		$x/c_R = .6$		$x/c_R = .8$		$x/c_R = .95$	
	$C_{p,l}$	$C_{p,l}$	$C_{p,l}$	$C_{p,l}$	$C_{p,l}$	$C_{p,l}$	$C_{p,l}$	$C_{p,l}$	$C_{p,l}$	$C_{p,l}$
-0.200	0.5421	0.4778	0.4514	*****	*****	*****	*****	*****	*****	*****
-0.400	0.5409	0.4817	0.4264	0.2276	-0.5812	*****	*****	*****	*****	*****
-0.600	*****	0.4872	0.4178	0.2532	-0.5533	*****	*****	*****	*****	*****
-0.700	*****	0.4841	0.4201	0.2637	-0.5231	*****	*****	*****	*****	*****
-0.800	0.5041	0.4694	0.4081	0.2787	-0.4408	*****	*****	*****	*****	*****
-0.850	0.4611	0.4216	0.3938	0.2805	-0.4152	*****	*****	*****	*****	*****
-0.900	0.3923	0.3844	0.3498	0.2669	-0.3631	*****	*****	*****	*****	*****
-0.950	*****	*****	0.2212	0.1830	-0.1180	*****	*****	*****	*****	*****
-0.975	*****	0.0999	0.0709	0.0552	-0.0913	*****	*****	*****	*****	*****

Sharp Radius L.E.
 Run No. = 88 , Point No. = 1954
 $C_N = 1.125$, $C_m = -0.1864$
 $\alpha = 22.6^\circ$, $M_\infty = 0.850$
 $R_{mac} = 6.0 \times 10^6$

Surface Pressures Near Leading Edge

● / ◆ upper, starboard/port
 ○ / ◇ lower, starboard/port

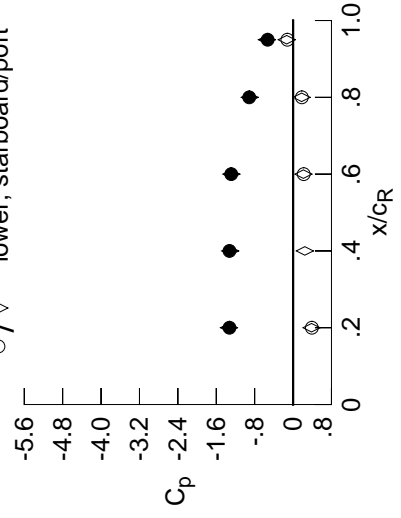

x/c_R	η	starb'd	port	starb'd	port
		$C_{p,u}$	$C_{p,l}$	$C_{p,u}$	$C_{p,l}$
0.20	0.90	-1.3246	-1.3364	0.3851	0.3923
0.40	0.95	-1.3246	-1.3104	0.2446	*****
0.60	0.95	-1.2882	-1.2859	0.2150	0.2212
0.80	0.95	-0.9139	-0.9042	0.1781	0.1830
0.95	0.95	-0.5300	-0.5462	-0.1324	-0.1180

Table C1. Continued.

η	$x/c_R = .2$		$x/c_R = .4$		$x/c_R = .6$		$x/c_R = .8$		$x/c_R = .95$	
	$C_{p,u}$	$C_{p,u}$	$C_{p,u}$	$C_{p,u}$	$C_{p,u}$	$C_{p,u}$	$C_{p,u}$	$C_{p,u}$	$C_{p,u}$	$C_{p,u}$
0.050	-0.5898	-0.6280	-0.6287	*****	*****	*****	*****	*****	*****	*****
0.100	-0.5940	-0.6313	-0.6329	*****	*****	*****	*****	*****	*****	*****
0.150	-0.6064	-0.6357	-0.6380	*****	*****	*****	*****	*****	*****	*****
0.200	-0.6152	-0.6446	-0.6528	*****	*****	*****	*****	*****	*****	*****
0.250	*****	-0.6652	-0.6762	-0.4920	-0.4121	*****	*****	*****	*****	*****
0.300	-0.6511	-0.7058	-0.7267	-0.5286	-0.4989	*****	*****	*****	*****	*****
0.350	-0.7197	-0.7845	-0.8105	-0.6002	-0.5721	*****	*****	*****	*****	*****
0.400	-0.8550	-0.9375	-0.9565	-0.7160	-0.6854	*****	*****	*****	*****	*****
0.450	-1.1005	-1.1524	-1.1416	-0.8889	-0.8407	*****	*****	*****	*****	*****
0.500	-1.3853	-1.3677	-1.3457	-1.1053	-1.0265	*****	*****	*****	*****	*****
0.525	*****	-1.4670	-1.4415	-1.2046	-0.9739	*****	*****	*****	*****	*****
0.550	-1.4986	-1.5458	-1.5250	-1.3059	-0.6326	*****	*****	*****	*****	*****
0.575	*****	-1.6134	-1.5888	-1.4006	-0.5846	*****	*****	*****	*****	*****
0.600	-1.4781	-1.6467	-1.6506	-1.4683	-0.5613	*****	*****	*****	*****	*****
0.625	*****	*****	-1.5001	-1.1947	-0.5562	*****	*****	*****	*****	*****
0.650	-1.4816	-1.4688	-1.4442	-1.1143	-0.5418	*****	*****	*****	*****	*****
0.675	*****	-1.4571	-1.4355	-1.0889	-0.5371	*****	*****	*****	*****	*****
0.700	-1.4876	-1.4368	-1.4276	-1.0875	-0.5426	*****	*****	*****	*****	*****
0.725	*****	-1.4358	*****	-1.0977	-0.5562	*****	*****	*****	*****	*****
0.750	-1.5538	-1.4450	*****	-1.0936	-0.5824	*****	*****	*****	*****	*****
0.775	*****	-1.4744	-1.4314	-1.0851	-0.5967	*****	*****	*****	*****	*****
0.800	-1.4658	-1.5009	-1.4839	-1.0775	*****	*****	*****	*****	*****	*****
0.825	*****	-1.4694	-1.5099	-1.0681	-0.6226	*****	*****	*****	*****	*****
0.850	-1.3843	-1.4072	-1.4440	-1.1120	-0.5773	*****	*****	*****	*****	*****
0.875	*****	-1.3623	-1.2773	-1.0666	-0.6047	*****	*****	*****	*****	*****
0.900	-1.3607	-1.3535	-1.3061	-0.9057	*****	*****	*****	*****	*****	*****
0.925	*****	-1.3565	-1.3167	-0.8033	-0.6151	*****	*****	*****	*****	*****
0.950	-1.4048	-1.3588	-1.3206	-0.7718	-0.5457	*****	*****	*****	*****	*****
0.975	*****	-1.3591	-1.3132	-0.7560	-0.5252	*****	*****	*****	*****	*****
-0.200	$C_{p,l}$	0.4970	0.4664	*****	*****	*****	*****	*****	*****	*****
-0.400	0.5675	0.4988	0.4419	0.2417	-0.5697	*****	*****	*****	*****	*****
-0.600	*****	0.5070	0.4318	0.2645	-0.5410	*****	*****	*****	*****	*****
-0.700	*****	0.5039	0.4327	0.2753	-0.5136	*****	*****	*****	*****	*****
-0.800	0.5186	0.4848	0.4246	0.2894	-0.4324	*****	*****	*****	*****	*****
-0.850	0.4714	0.4303	0.4035	0.2945	-0.4056	*****	*****	*****	*****	*****
-0.900	0.3978	0.3893	0.3538	0.2768	-0.3545	*****	*****	*****	*****	*****
-0.950	*****	*****	0.2156	0.1854	-0.1212	*****	*****	*****	*****	*****
-0.975	*****	0.0888	0.0624	0.0577	-0.1036	*****	*****	*****	*****	*****

Sharp Radius L.E.
 Run No. = 88 , Point No. = 1955
 $C_N = 1.163$, $C_m = -0.1901$
 $\alpha = 23.6^\circ$, $M_\infty = 0.851$
 $R_{mac} = 6.0 \times 10^6$

Surface Pressures Near Leading Edge

● / ◆ upper, starboard/port
 ○ / ◇ lower, starboard/port

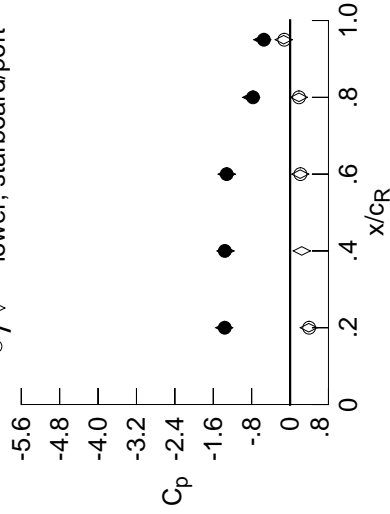

x/c_R	η	starb'd	port	starb'd	port
		$C_{p,u}$	$C_{p,u}$	$C_{p,l}$	$C_{p,l}$
0.20	0.90	-1.3607	-1.3731	0.3899	0.3978
0.40	0.95	-1.3588	-1.3466	0.2429	*****
0.60	0.95	-1.3206	-1.3206	0.2115	0.2156
0.80	0.95	-0.7718	-0.8102	0.1848	0.1854
0.95	0.95	-0.5457	-0.5798	-0.1331	-0.1212

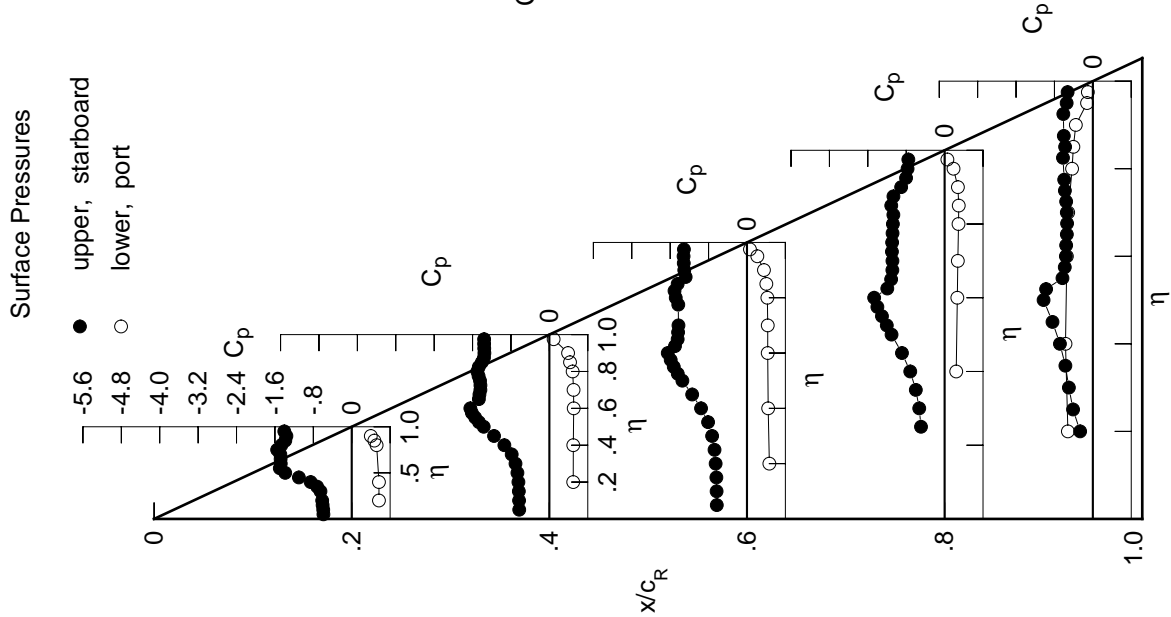

Table C1. Continued.

η	$x/c_R = .2$		$x/c_R = .4$		$x/c_R = .6$		$x/c_R = .8$		$x/c_R = .95$	
	$C_{p,u}$	$C_{p,l}$	$C_{p,u}$	$C_{p,l}$	$C_{p,u}$	$C_{p,l}$	$C_{p,u}$	$C_{p,l}$	$C_{p,u}$	$C_{p,l}$
0.050	-0.6224	-0.6502	-0.0059	*****	*****	*****	*****	*****	*****	*****
0.100	-0.6273	-0.6539	-0.0229	*****	*****	*****	*****	*****	*****	*****
0.150	-0.6380	-0.6609	-0.0343	*****	*****	*****	*****	*****	*****	*****
0.200	-0.6526	-0.6726	-0.0668	*****	*****	*****	*****	*****	*****	*****
0.250	*****	-0.7022	-0.1090	-0.6708	-0.6839	-0.6442	-0.6442	-0.6442	-0.6442	-0.6442
0.300	-0.7022	-0.7516	-0.1860	-0.6835	-0.7250	-0.7250	-0.7250	-0.7250	-0.7250	-0.7250
0.350	-0.7904	-0.8437	-0.3072	-0.7438	-0.7602	-0.7602	-0.7602	-0.7602	-0.7602	-0.7602
0.400	-0.9436	-0.9986	-0.5001	-0.7727	-0.7948	-0.7948	-0.7948	-0.7948	-0.7948	-0.7948
0.450	-1.1863	-1.2034	-0.7361	-0.8215	-0.8065	-0.8065	-0.8065	-0.8065	-0.8065	-0.8065
0.500	-1.4426	-1.4032	-1.0126	-0.8645	-0.7845	-0.7845	-0.7845	-0.7845	-0.7845	-0.7845
0.525	*****	-1.4953	-1.1435	-0.8717	-0.7883	-0.7883	-0.7883	-0.7883	-0.7883	-0.7883
0.550	-1.6081	-1.5670	-1.2472	-0.8757	-0.7724	-0.7724	-0.7724	-0.7724	-0.7724	-0.7724
0.575	*****	-1.6315	-1.3242	-0.8842	-0.7825	-0.7825	-0.7825	-0.7825	-0.7825	-0.7825
0.600	-1.5201	-1.6483	-1.2909	-0.8940	-0.7730	-0.7730	-0.7730	-0.7730	-0.7730	-0.7730
0.625	*****	*****	-1.1215	-0.9023	-0.7765	-0.7765	-0.7765	-0.7765	-0.7765	-0.7765
0.650	-1.4915	-1.4873	-1.0328	-0.8918	-0.7704	-0.7704	-0.7704	-0.7704	-0.7704	-0.7704
0.675	*****	-1.4747	-0.9941	-0.8844	-0.7538	-0.7538	-0.7538	-0.7538	-0.7538	-0.7538
0.700	-1.4736	-1.4524	-0.9734	-0.8741	-0.7435	-0.7435	-0.7435	-0.7435	-0.7435	-0.7435
0.725	*****	-1.4510	*****	-0.8607	-0.7299	-0.7299	-0.7299	-0.7299	-0.7299	-0.7299
0.750	-1.5100	-1.4583	*****	-0.8343	-0.7184	-0.7184	-0.7184	-0.7184	-0.7184	-0.7184
0.775	*****	-1.4882	-0.8848	-0.8225	-0.6996	-0.6996	-0.6996	-0.6996	-0.6996	-0.6996
0.800	-1.4634	-1.5244	-0.8633	-0.8072	*****	*****	*****	*****	*****	*****
0.825	*****	-1.4933	-0.8443	-0.7898	-0.6698	-0.6698	-0.6698	-0.6698	-0.6698	-0.6698
0.850	-1.4046	-1.4250	-0.8403	-0.7860	-0.6154	-0.6154	-0.6154	-0.6154	-0.6154	-0.6154
0.875	*****	-1.3777	-0.7694	-0.7759	-0.6368	-0.6368	-0.6368	-0.6368	-0.6368	-0.6368
0.900	-1.3843	-1.3715	-0.7447	-0.7533	*****	*****	*****	*****	*****	*****
0.925	*****	-1.3776	-0.7184	-0.7467	-0.6048	-0.6048	-0.6048	-0.6048	-0.6048	-0.6048
0.950	-1.4213	-1.3761	-0.7028	-0.7358	-0.5637	-0.5637	-0.5637	-0.5637	-0.5637	-0.5637
0.975	*****	-1.3788	-0.6930	-0.7151	-0.5256	-0.5256	-0.5256	-0.5256	-0.5256	-0.5256

η	$x/c_R = .2$		$x/c_R = .4$		$x/c_R = .6$		$x/c_R = .8$		$x/c_R = .95$	
	$C_{p,u}$	$C_{p,l}$	$C_{p,u}$	$C_{p,l}$	$C_{p,u}$	$C_{p,l}$	$C_{p,u}$	$C_{p,l}$	$C_{p,u}$	$C_{p,l}$
-0.200	0.5942	0.5214	0.4827	*****	*****	*****	*****	*****	*****	*****
-0.400	0.5945	0.5219	0.4620	0.2481	-0.5879	-0.5879	-0.5879	-0.5879	-0.5879	-0.5879
-0.600	*****	0.5297	0.4528	0.2706	-0.5596	-0.5596	-0.5596	-0.5596	-0.5596	-0.5596
-0.700	*****	0.5232	0.4535	0.2793	-0.5281	-0.5281	-0.5281	-0.5281	-0.5281	-0.5281
-0.800	0.5325	0.5024	0.4473	0.2925	-0.4499	-0.4499	-0.4499	-0.4499	-0.4499	-0.4499
-0.850	0.4840	0.4438	0.4299	0.2976	-0.4216	-0.4216	-0.4216	-0.4216	-0.4216	-0.4216
-0.900	0.4061	0.3981	0.3831	0.2803	-0.3709	-0.3709	-0.3709	-0.3709	-0.3709	-0.3709
-0.950	*****	*****	0.2576	0.1962	-0.1341	-0.1341	-0.1341	-0.1341	-0.1341	-0.1341
-0.975	*****	0.0976	0.1181	0.0729	-0.1116	-0.1116	-0.1116	-0.1116	-0.1116	-0.1116

Sharp Radius L.E.
 Run No. = 88 , Point No. = 1956
 $C_N = 1.082$, $C_m = -0.1729$
 $\alpha = 24.6^\circ$, $M_\infty = 0.851$
 $R_{mac} = 6.0 \times 10^6$

Surface Pressures Near Leading Edge

● / ◆ upper, starboard/port
 ○ / ◇ lower, starboard/port

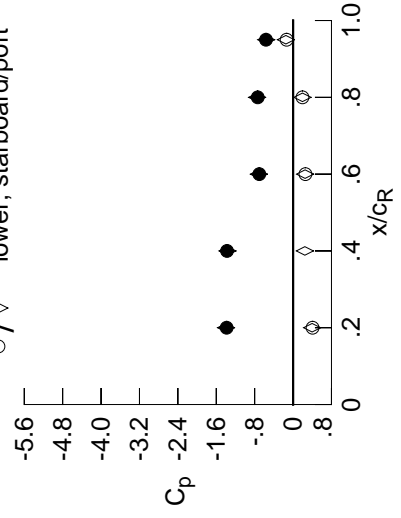

x/c_R	η	starb'd	port	starb'd	port
0.20	0.90	-1.3843	-1.3968	0.3970	0.4061
0.40	0.95	-1.3761	-1.3675	0.2457	*****
0.60	0.95	-0.7028	-0.7128	0.2504	0.2576
0.80	0.95	-0.7358	-0.7500	0.1960	0.1962
0.95	0.95	-0.5637	-0.5598	-0.1497	-0.1341

Table C1. Continued.

η	x/c_R .2	$C_{p,u}$	x/c_R .4	$C_{p,u}$	x/c_R .6	$C_{p,u}$	x/c_R .8	$C_{p,u}$	x/c_R .95	$C_{p,u}$
0.050		-0.6657	-0.6822	-0.0447	*****	*****	*****	*****	*****	*****
0.100		-0.6714	-0.6844	-0.0599	*****	*****	*****	*****	*****	*****
0.150		-0.6846	-0.6948	-0.0762	*****	*****	*****	*****	*****	*****
0.200		-0.6981	-0.7110	-0.1085	*****	*****	*****	*****	*****	*****
0.250		*****	-0.7509	-0.1567	-0.8031	-0.7643	*****	*****	*****	-0.7061
0.300		-0.7695	-0.8118	-0.2421	-0.7946	-0.8079	*****	*****	*****	*****
0.350		-0.8755	-0.9178	-0.3721	-0.8233	-0.8179	*****	*****	*****	*****
0.400		-1.0407	-1.0808	-0.5678	-0.8197	-0.8145	*****	*****	*****	*****
0.450		-1.2729	-1.2785	-0.7925	-0.8344	-0.7976	*****	*****	*****	*****
0.500		-1.5004	-1.4576	-1.0515	-0.8597	-0.7722	*****	*****	*****	*****
0.525		*****	-1.5350	-1.1681	-0.8678	-0.7836	*****	*****	*****	*****
0.550		-1.6221	-1.6016	-1.2503	-0.8821	-0.7775	*****	*****	*****	*****
0.575		*****	-1.6568	-1.2964	-0.8928	-0.7911	*****	*****	*****	*****
0.600		-1.5197	-1.6695	-1.2398	-0.9050	-0.7846	*****	*****	*****	*****
0.625		*****	*****	-1.1011	-0.9111	-0.7921	*****	*****	*****	*****
0.650		-1.5138	-1.5187	-1.0272	-0.9092	-0.7867	*****	*****	*****	*****
0.675		*****	-1.5058	-0.9981	-0.9092	-0.7706	*****	*****	*****	*****
0.700		-1.5250	-1.4813	-0.9822	-0.9031	-0.7630	*****	*****	*****	*****
0.725		*****	-1.4818	*****	-0.8912	-0.7520	*****	*****	*****	*****
0.750		-1.5805	-1.4918	*****	-0.8662	-0.7431	*****	*****	*****	*****
0.775		*****	-1.5248	-0.9215	-0.8578	-0.7208	*****	*****	*****	*****
0.800		-1.4978	-1.5601	-0.9033	-0.8413	*****	*****	*****	*****	*****
0.825		*****	-1.5314	-0.8885	-0.8209	-0.6861	*****	*****	*****	*****
0.850		-1.4287	-1.4595	-0.8758	-0.8209	-0.6468	*****	*****	*****	*****
0.875		*****	-1.4108	-0.8201	-0.8098	-0.6494	*****	*****	*****	*****
0.900		-1.4077	-1.4023	-0.8115	-0.7849	*****	*****	*****	*****	*****
0.925		*****	-1.4062	-0.7924	-0.7779	-0.6111	*****	*****	*****	*****
0.950		-1.4481	-1.4075	-0.7770	-0.7655	-0.5723	*****	*****	*****	*****
0.975		*****	-1.4064	-0.7686	-0.7398	-0.5359	*****	*****	*****	*****
-0.200		$C_{p,l}$	0.5432	0.5004	*****	*****	*****	*****	*****	-0.5281
-0.400		0.6203	0.5428	0.4785	0.2642	-0.5718	*****	*****	*****	*****
-0.600		*****	0.5485	0.4680	0.2857	-0.5462	*****	*****	*****	*****
-0.700		*****	0.5427	0.4691	0.2922	-0.5146	*****	*****	*****	*****
-0.800		0.5458	0.5156	0.4600	0.3054	-0.4364	*****	*****	*****	*****
-0.850		0.4944	0.4526	0.4394	0.3074	-0.4090	*****	*****	*****	*****
-0.900		0.4107	0.4018	0.3850	0.2846	-0.3563	*****	*****	*****	*****
-0.950		*****	*****	0.2483	0.1912	-0.1306	*****	*****	*****	*****
-0.975		*****	0.0798	0.1005	0.0632	-0.1184	*****	*****	*****	*****

Sharp Radius L.E.
 Run No. = 88 , Point No. = 1957
 $C_N = 1.127$, $C_m = -0.1764$
 $\alpha = 25.6^\circ$, $M_\infty = 0.851$
 $R_{mac} = 6.0 \times 10^6$

Surface Pressures Near Leading Edge

● / ◆ upper, starboard/port
 ○ / ◇ lower, starboard/port

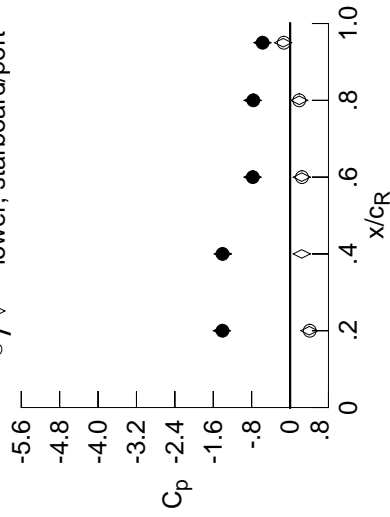

x/c_R	η	starb'd	port	starb'd	port
0.20	0.90	-1.4077	-1.4215	0.4002	0.4107
0.40	0.95	-1.4075	-1.4028	0.2432	*****
0.60	0.95	-0.7770	-0.7840	0.2432	0.2483
0.80	0.95	-0.7655	-0.7806	0.1912	0.1912
0.95	0.95	-0.5723	-0.5772	-0.1440	-0.1306

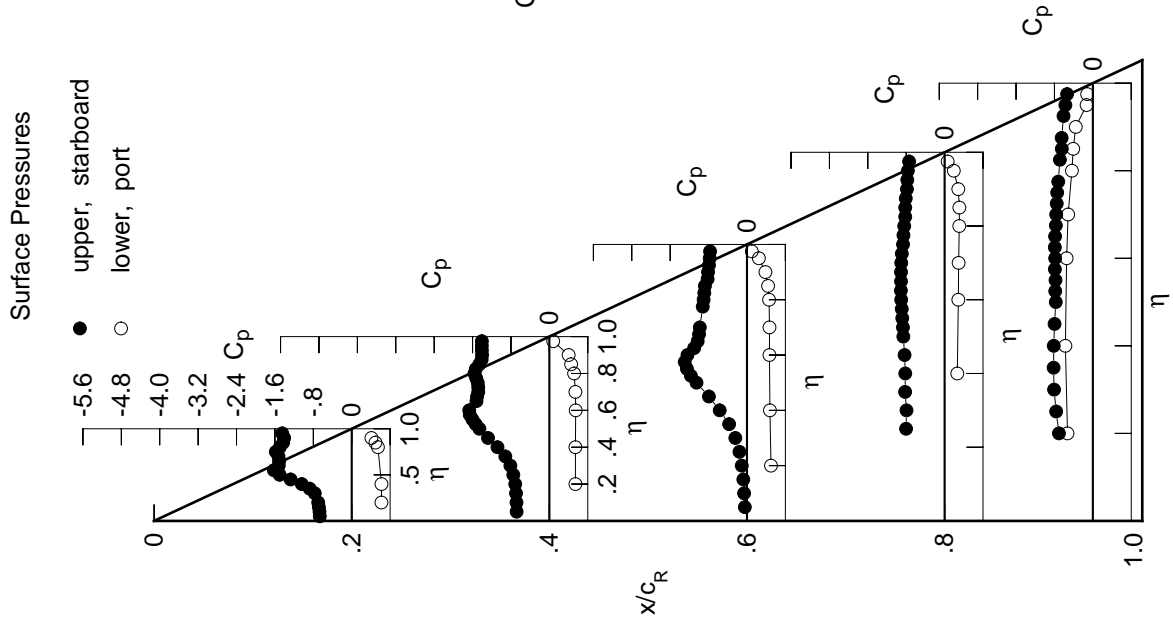

Table C1. Continued.

η	$x/c_R = .2$		$x/c_R = .4$		$x/c_R = .6$		$x/c_R = .8$		$x/c_R = .95$	
	$C_{p,u}$	$C_{p,l}$	$C_{p,u}$	$C_{p,l}$	$C_{p,u}$	$C_{p,l}$	$C_{p,u}$	$C_{p,l}$	$C_{p,u}$	$C_{p,l}$
0.050	-0.7088	-0.7161	-0.1272	*****	*****	*****	*****	*****	*****	*****
0.100	-0.7144	-0.7205	-0.1352	*****	*****	*****	*****	*****	*****	*****
0.150	-0.7308	-0.7348	-0.1465	*****	*****	*****	*****	*****	*****	*****
0.200	-0.7464	-0.7555	-0.1754	*****	*****	*****	*****	*****	*****	*****
0.250	*****	-0.8028	-0.2189	-0.9514	-0.8494	*****	*****	*****	*****	*****
0.300	-0.8379	-0.8739	-0.3040	-0.9134	-0.8954	*****	*****	*****	*****	*****
0.350	-0.9590	-0.9887	-0.4325	-0.8978	-0.8713	*****	*****	*****	*****	*****
0.400	-1.1304	-1.1504	-0.6227	-0.8530	-0.8247	*****	*****	*****	*****	*****
0.450	-1.3464	-1.3363	-0.8244	-0.8403	-0.7855	*****	*****	*****	*****	*****
0.500	-1.5488	-1.4991	-1.0614	-0.8629	-0.7708	*****	*****	*****	*****	*****
0.525	*****	-1.5701	-1.1602	-0.8770	-0.7852	*****	*****	*****	*****	*****
0.550	-1.6339	-1.6286	-1.2267	-0.9005	-0.7836	*****	*****	*****	*****	*****
0.575	*****	-1.6794	-1.2619	-0.9238	-0.8000	*****	*****	*****	*****	*****
0.600	-1.5453	-1.6864	-1.2071	-0.9385	-0.7995	*****	*****	*****	*****	*****
0.625	*****	*****	-1.0655	-0.9428	-0.8060	*****	*****	*****	*****	*****
0.650	-1.5408	-1.5462	-0.9878	-0.9374	-0.8014	*****	*****	*****	*****	*****
0.675	*****	-1.5318	-0.9628	-0.9414	-0.7863	*****	*****	*****	*****	*****
0.700	-1.5527	-1.5037	-0.9586	-0.9371	-0.7797	*****	*****	*****	*****	*****
0.725	*****	-1.5076	*****	-0.9313	-0.7665	*****	*****	*****	*****	*****
0.750	-1.6207	-1.5163	*****	-0.9070	-0.7574	*****	*****	*****	*****	*****
0.775	*****	-1.5494	-0.9195	-0.9029	-0.7345	*****	*****	*****	*****	*****
0.800	-1.5171	-1.5892	-0.9030	-0.8904	*****	*****	*****	*****	*****	*****
0.825	*****	-1.5567	-0.8867	-0.8719	-0.7013	*****	*****	*****	*****	*****
0.850	-1.4453	-1.4831	-0.8782	-0.8698	-0.6661	*****	*****	*****	*****	*****
0.875	*****	-1.4340	-0.8347	-0.8574	-0.6577	*****	*****	*****	*****	*****
0.900	-1.4305	-1.4296	-0.8443	-0.8304	*****	*****	*****	*****	*****	*****
0.925	*****	-1.4376	-0.8341	-0.8205	-0.6213	*****	*****	*****	*****	*****
0.950	-1.4702	-1.4368	-0.8225	-0.8067	-0.5842	*****	*****	*****	*****	*****
0.975	*****	-1.4329	-0.8172	-0.7792	-0.5470	*****	*****	*****	*****	*****

Sharp Radius L.E.
 Run No. = 88 , Point No. = 1958
 $C_N = 1.177$, $C_m = -0.1878$
 $\alpha = 26.7^\circ$, $M_\infty = 0.851$
 $R_{mac} = 6.0 \times 10^6$

Surface Pressures Near Leading Edge

● / ◆ upper, starboard/port
 ○ / ◇ lower, starboard/port

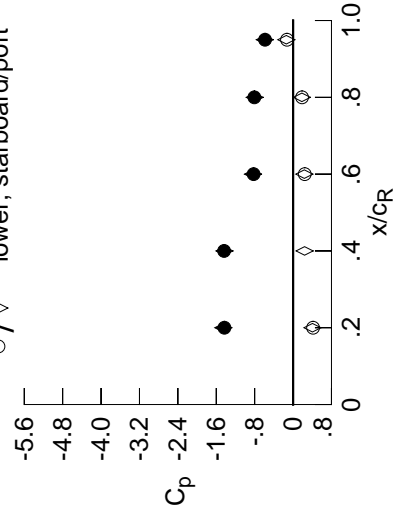

x/c_R	η	starb'd	port	$C_{p,u}$	starb'd	port	$C_{p,l}$
0.20	0.90	-1.4305	-1.4537	0.4043	0.4169	*****	*****
0.40	0.95	-1.4368	-1.4293	0.2401	*****	*****	*****
0.60	0.95	-0.8225	-0.8350	0.2348	0.2435	*****	*****
0.80	0.95	-0.8067	-0.7991	0.1836	0.1868	*****	*****
0.95	0.95	-0.5842	-0.5893	-0.1410	-0.1266	*****	*****

Surface Pressures

● upper, starboard
 ○ lower, port

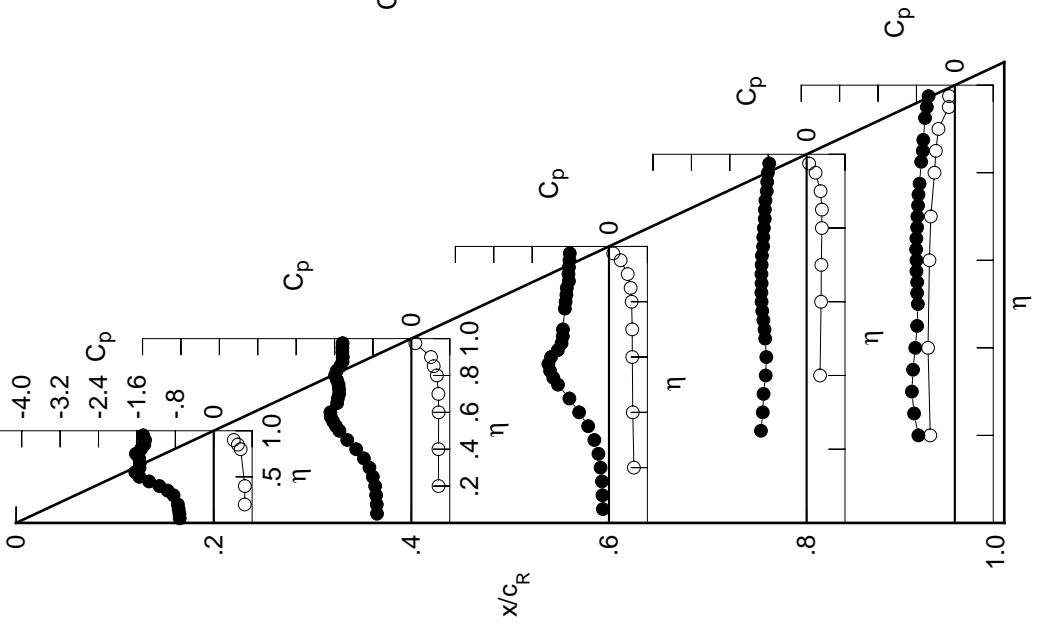

η	$C_{p,l}$	$C_{p,l}$	$C_{p,l}$	$C_{p,l}$	$C_{p,l}$	$C_{p,l}$	$C_{p,l}$	$C_{p,l}$	$C_{p,l}$
-0.200	0.6456	0.5666	0.5193	*****	-0.5123	*****	*****	*****	*****
-0.400	0.6477	0.5651	0.4962	0.2797	-0.5584	*****	*****	*****	*****
-0.600	*****	0.5681	0.4859	0.3011	-0.5297	*****	*****	*****	*****
-0.700	*****	0.5631	0.4842	0.3071	-0.5008	*****	*****	*****	*****
-0.800	0.5604	0.5312	0.4717	0.3173	-0.4237	*****	*****	*****	*****
-0.850	0.5031	0.4646	0.4511	0.3174	-0.3952	*****	*****	*****	*****
-0.900	0.4169	0.4085	0.3907	0.2903	-0.3416	*****	*****	*****	*****
-0.950	*****	*****	0.2435	0.1868	-0.1266	*****	*****	*****	*****
-0.975	*****	0.0831	0.0896	0.0512	-0.1210	*****	*****	*****	*****

Table C1. Concluded.

η	$x/c_R = .2$		$x/c_R = .4$		$x/c_R = .6$		$x/c_R = .8$		$x/c_R = .95$	
	$C_{p,u}$	$C_{p,l}$	$C_{p,u}$	$C_{p,l}$	$C_{p,u}$	$C_{p,l}$	$C_{p,u}$	$C_{p,l}$	$C_{p,u}$	$C_{p,l}$
0.050	-0.0144	-0.0005	0.1301	0.1301	0.1301	0.1301	0.1301	0.1301	0.1301	0.1301
0.100	-0.0091	-0.0025	0.1168	0.1168	0.1168	0.1168	0.1168	0.1168	0.1168	0.1168
0.150	-0.0106	-0.0002	0.1038	0.1038	0.1038	0.1038	0.1038	0.1038	0.1038	0.1038
0.200	-0.0214	0.0002	0.0881	0.0881	0.0881	0.0881	0.0881	0.0881	0.0881	0.0881
0.250	*****	-0.0033	0.0783	-0.1350	0.0783	-0.1350	0.0783	-0.1350	0.0783	-0.1350
0.300	-0.0389	-0.0001	0.0675	-0.1177	0.0675	-0.1177	0.0675	-0.1177	0.0675	-0.1177
0.350	-0.0480	-0.0043	0.0595	-0.1086	0.0595	-0.1086	0.0595	-0.1086	0.0595	-0.1086
0.400	-0.0572	-0.0064	0.0503	-0.0969	0.0503	-0.0969	0.0503	-0.0969	0.0503	-0.0969
0.450	-0.0649	-0.0082	0.0466	-0.0910	0.0466	-0.0910	0.0466	-0.0910	0.0466	-0.0910
0.500	-0.0708	-0.0111	0.0343	-0.0867	0.0343	-0.0867	0.0343	-0.0867	0.0343	-0.0867
0.525	*****	-0.0136	0.0261	-0.0862	0.0261	-0.0862	0.0261	-0.0862	0.0261	-0.0862
0.550	-0.0726	-0.0187	0.0263	-0.0849	0.0263	-0.0849	0.0263	-0.0849	0.0263	-0.0849
0.575	*****	-0.0219	0.0247	-0.0821	0.0247	-0.0821	0.0247	-0.0821	0.0247	-0.0821
0.600	-0.0561	-0.0233	0.0159	-0.0784	0.0159	-0.0784	0.0159	-0.0784	0.0159	-0.0784
0.625	*****	*****	0.0167	-0.0797	0.0167	-0.0797	0.0167	-0.0797	0.0167	-0.0797
0.650	-0.0458	-0.0281	0.0103	-0.0811	0.0103	-0.0811	0.0103	-0.0811	0.0103	-0.0811
0.675	*****	-0.0418	0.0059	-0.0783	0.0059	-0.0783	0.0059	-0.0783	0.0059	-0.0783
0.700	-0.0405	-0.0617	-0.0006	-0.0816	-0.0006	-0.0816	-0.0006	-0.0816	-0.0006	-0.0816
0.725	*****	-0.0734	*****	-0.0779	*****	-0.0779	*****	-0.0779	*****	-0.0779
0.750	-0.0230	-0.0812	*****	-0.0823	*****	-0.0823	*****	-0.0823	*****	-0.0823
0.775	*****	-0.0875	-0.0181	-0.0844	-0.0181	-0.0844	-0.0181	-0.0844	-0.0181	-0.0844
0.800	-0.0047	-0.0842	-0.0484	-0.0911	-0.0484	-0.0911	-0.0484	-0.0911	-0.0484	-0.0911
0.825	*****	-0.0733	-0.0636	-0.0901	-0.0636	-0.0901	-0.0636	-0.0901	-0.0636	-0.0901
0.850	0.0206	-0.0650	-0.0670	-0.1198	-0.0670	-0.1198	-0.0670	-0.1198	-0.0670	-0.1198
0.875	*****	-0.0511	-0.0637	-0.1390	-0.0637	-0.1390	-0.0637	-0.1390	-0.0637	-0.1390
0.900	0.0598	-0.0284	-0.0538	-0.1369	-0.0538	-0.1369	-0.0538	-0.1369	-0.0538	-0.1369
0.925	*****	0.0078	-0.0282	-0.1097	-0.0282	-0.1097	-0.0282	-0.1097	-0.0282	-0.1097
0.950	0.1072	0.0462	0.0108	-0.0776	0.0108	-0.0776	0.0108	-0.0776	0.0108	-0.0776
0.975	*****	0.0933	0.0699	0.0011	-0.1646	0.0011	-0.1646	0.0011	-0.1646	0.0011
-0.200	-0.0404	-0.0014	0.0861	0.0861	0.0861	0.0861	0.0861	0.0861	0.0861	0.0861
-0.400	-0.0547	-0.0016	0.0421	-0.1029	0.0421	-0.1029	0.0421	-0.1029	0.0421	-0.1029
-0.600	*****	-0.0189	0.0129	-0.0882	0.0129	-0.0882	0.0129	-0.0882	0.0129	-0.0882
-0.700	*****	-0.0548	-0.0044	-0.0859	-0.07020	-0.0859	-0.07020	-0.0859	-0.07020	-0.0859
-0.800	-0.0249	-0.0869	-0.0555	-0.0930	-0.0555	-0.0930	-0.0555	-0.0930	-0.0555	-0.0930
-0.850	0.0082	-0.0666	-0.0758	-0.1319	-0.0758	-0.1319	-0.0758	-0.1319	-0.0758	-0.1319
-0.900	0.0473	-0.0365	-0.0750	-0.1538	-0.0750	-0.1538	-0.0750	-0.1538	-0.0750	-0.1538
-0.950	*****	*****	-0.0039	-0.1005	-0.0039	-0.1005	-0.0039	-0.1005	-0.0039	-0.1005
-0.975	*****	0.0873	0.0527	-0.0239	-0.1880	-0.0239	-0.1880	-0.0239	-0.1880	-0.0239

Sharp Radius L.E.

Run No. = 88 , Point No. = 1959

$C_N = -0.020$, $C_m = 0.0069$

$\alpha = 0.0^\circ$, $M_\infty = 0.851$

$R_{mac} = 6.0 \times 10^6$

Surface Pressures Near Leading Edge

● / ◆ upper, starboard/port
○ / ◇ lower, starboard/port

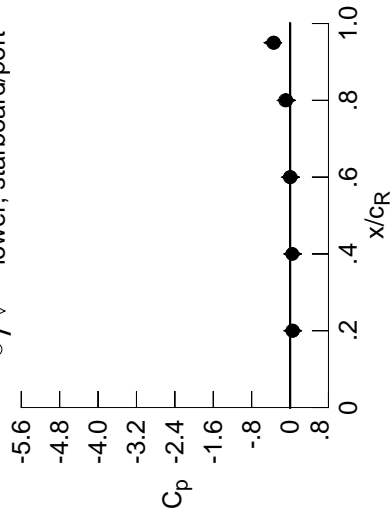

x/c_R	η	starb'd	port	starb'd	port
		$C_{p,u}$	$C_{p,l}$	$C_{p,u}$	$C_{p,l}$
0.20	0.90	0.0598	0.0613	0.0498	0.0473
0.40	0.95	0.0462	0.0563	0.0475	*****
0.60	0.95	0.0108	0.0147	-0.0002	-0.0039
0.80	0.95	-0.0776	-0.0681	-0.0876	-0.1005
0.95	0.95	-0.3351	-0.3542	-0.3631	-0.3495

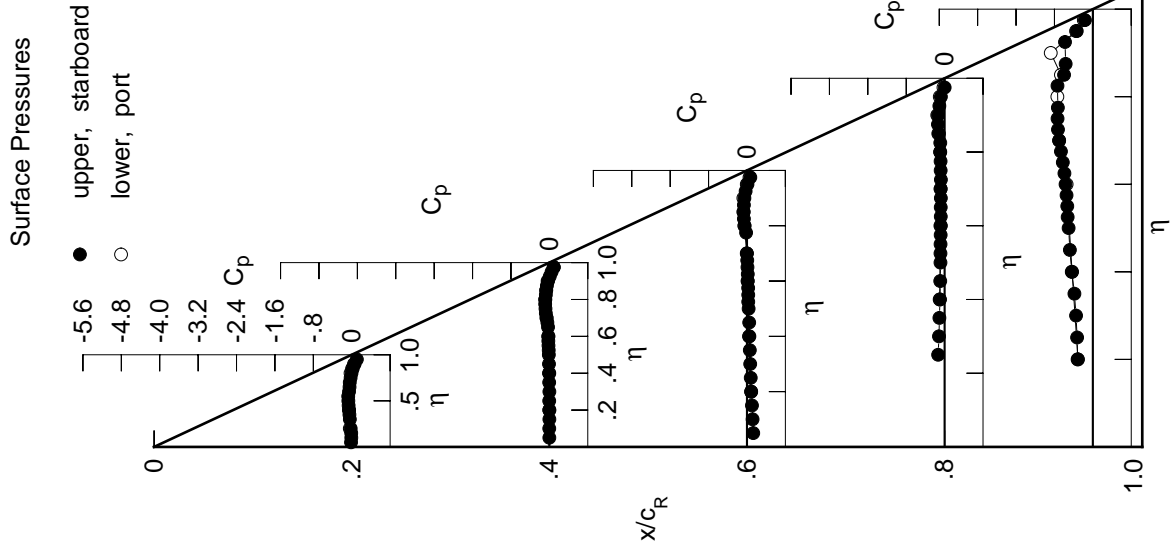

Table C2. Tabulations and Plots of Surface Pressure Coefficients.

η	$x/c_R = .2$		$x/c_R = .4$		$x/c_R = .6$		$x/c_R = .8$		$x/c_R = .95$	
	$C_{p,u}$	$C_{p,l}$	$C_{p,u}$	$C_{p,l}$	$C_{p,u}$	$C_{p,l}$	$C_{p,u}$	$C_{p,l}$	$C_{p,u}$	$C_{p,l}$
0.050	-0.0055	0.0073	0.1313	*****	*****	*****	*****	*****	*****	*****
0.100	-0.0032	0.0076	0.1228	*****	*****	*****	*****	*****	*****	*****
0.150	-0.0119	0.0075	0.1092	*****	*****	*****	*****	*****	*****	*****
0.200	-0.0147	0.0095	0.0955	*****	*****	*****	*****	*****	*****	*****
0.250	*****	0.0068	0.0830	-0.1307	-0.3622	*****	*****	*****	*****	*****
0.300	-0.0232	0.0067	0.0720	-0.1154	-0.3941	*****	*****	*****	*****	*****
0.350	-0.0294	0.0045	0.0617	-0.1037	-0.4428	*****	*****	*****	*****	*****
0.400	-0.0353	0.0031	0.0535	-0.0941	-0.4923	*****	*****	*****	*****	*****
0.450	-0.0444	-0.0002	0.0530	-0.0882	-0.5191	*****	*****	*****	*****	*****
0.500	-0.0488	-0.0028	0.0368	-0.0814	-0.5193	*****	*****	*****	*****	*****
0.525	*****	-0.0055	0.0338	-0.0793	-0.5351	*****	*****	*****	*****	*****
0.550	-0.0534	-0.0069	0.0316	-0.0748	-0.5354	*****	*****	*****	*****	*****
0.575	*****	-0.0104	0.0318	-0.0758	-0.5536	*****	*****	*****	*****	*****
0.600	-0.0462	-0.0157	0.0228	-0.0749	-0.5677	*****	*****	*****	*****	*****
0.625	*****	*****	0.0224	-0.0726	-0.5864	*****	*****	*****	*****	*****
0.650	-0.0410	-0.0187	0.0174	-0.0711	-0.6153	*****	*****	*****	*****	*****
0.675	*****	-0.0265	0.0114	-0.0721	-0.6402	*****	*****	*****	*****	*****
0.700	-0.0295	-0.0402	0.0080	-0.0724	-0.6740	*****	*****	*****	*****	*****
0.725	*****	-0.0496	*****	-0.0710	-0.7035	*****	*****	*****	*****	*****
0.750	-0.0073	-0.0514	*****	-0.0741	-0.7182	*****	*****	*****	*****	*****
0.775	*****	-0.0569	-0.0103	-0.0765	-0.7174	*****	*****	*****	*****	*****
0.800	0.0165	-0.0529	-0.0288	-0.0820	*****	*****	*****	*****	*****	*****
0.825	*****	-0.0442	-0.0404	-0.0826	-0.7226	*****	*****	*****	*****	*****
0.850	0.0376	-0.0336	-0.0454	-0.1018	-0.6805	*****	*****	*****	*****	*****
0.875	*****	-0.0144	-0.0427	-0.1142	-0.7706	*****	*****	*****	*****	*****
0.900	0.0778	0.0109	-0.0244	-0.1102	*****	*****	*****	*****	*****	*****
0.925	*****	0.0336	0.0017	-0.0867	-0.7228	*****	*****	*****	*****	*****
0.950	0.1236	0.0721	0.0376	-0.0410	-0.3197	*****	*****	*****	*****	*****
0.975	*****	0.1209	0.0967	0.0270	-0.1545	*****	*****	*****	*****	*****

η	$x/c_R = .2$		$x/c_R = .4$		$x/c_R = .6$		$x/c_R = .8$		$x/c_R = .95$	
	$C_{p,u}$	$C_{p,l}$	$C_{p,u}$	$C_{p,l}$	$C_{p,u}$	$C_{p,l}$	$C_{p,u}$	$C_{p,l}$	$C_{p,u}$	$C_{p,l}$
-0.200	-0.0337	-0.0127	0.0773	*****	-0.3474	*****	*****	*****	*****	*****
-0.400	-0.0630	-0.0152	0.0334	-0.1089	-0.4409	*****	*****	*****	*****	*****
-0.600	*****	-0.0393	0.0024	-0.0928	-0.5300	*****	*****	*****	*****	*****
-0.700	*****	-0.0757	-0.0198	-0.0946	-0.6394	*****	*****	*****	*****	*****
-0.800	-0.0472	-0.1067	-0.0717	-0.1125	-0.3846	*****	*****	*****	*****	*****
-0.850	-0.0140	-0.0842	-0.1004	-0.1452	-0.4403	*****	*****	*****	*****	*****
-0.900	0.0213	-0.0696	-0.1013	-0.1753	-1.0254	*****	*****	*****	*****	*****
-0.950	*****	*****	-0.0350	-0.1315	-0.3709	*****	*****	*****	*****	*****
-0.975	*****	0.0521	0.0166	-0.0551	-0.2165	*****	*****	*****	*****	*****

Sharp Radius L.E.
 Run No. = 83 , Point No. = 1786
 $C_N = -0.020$, $C_m = -0.0031$
 $\alpha = -0.5^\circ$, $M_\infty = 0.849$
 $R_{mac} = 11.9 \times 10^6$

Surface Pressures Near Leading Edge

● / ◆ upper, starboard/port
 ○ / ◇ lower, starboard/port

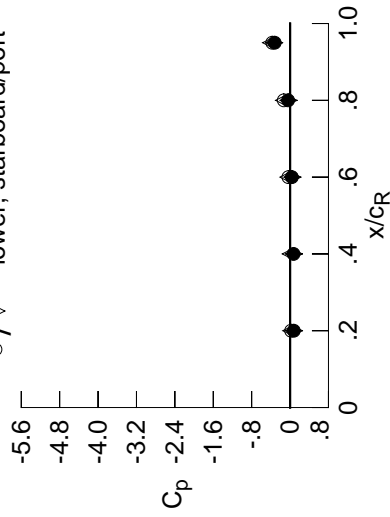

x/c_R	η	starb'd	port	starb'd	port
		$C_{p,u}$	$C_{p,l}$	$C_{p,u}$	$C_{p,l}$
0.20	0.90	0.0778	0.0805	0.0250	0.0213
0.40	0.95	0.0721	0.0788	0.0147	*****
0.60	0.95	0.0376	0.0473	-0.0337	-0.0350
0.80	0.95	-0.0410	-0.0327	-0.1247	-0.1315
0.95	0.95	-0.3197	-0.3331	-0.3953	-0.3709

Surface Pressures

● upper, starboard
 ○ lower, port

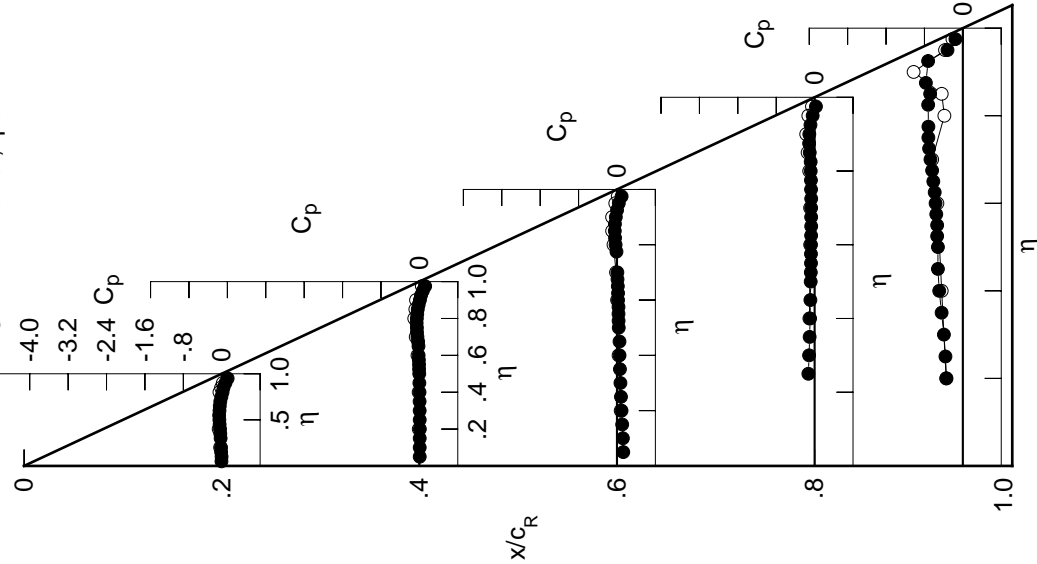

Table C2. Continued.

η	$x/c_R = .2$		$x/c_R = .4$		$x/c_R = .6$		$x/c_R = .8$		$x/c_R = .95$	
	$C_{p,u}$	$C_{p,u}$	$C_{p,u}$	$C_{p,u}$	$C_{p,u}$	$C_{p,u}$	$C_{p,u}$	$C_{p,u}$	$C_{p,u}$	$C_{p,u}$
0.050	-0.0171	-0.0023	0.1235	0.1235	0.1235	0.1235	0.1235	0.1235	0.1235	0.1235
0.100	-0.0155	-0.0036	0.1152	0.1152	0.1152	0.1152	0.1152	0.1152	0.1152	0.1152
0.150	-0.0224	-0.0010	0.1015	0.1015	0.1015	0.1015	0.1015	0.1015	0.1015	0.1015
0.200	-0.0280	-0.0009	0.0883	0.0883	0.0883	0.0883	0.0883	0.0883	0.0883	0.0883
0.250	*****	-0.0036	0.0748	-0.1387	0.0748	-0.1387	0.0748	-0.1387	0.0748	-0.1387
0.300	-0.0349	-0.0041	0.0644	-0.1227	0.0644	-0.1227	0.0644	-0.1227	0.0644	-0.1227
0.350	-0.0416	-0.0073	0.0530	-0.1121	0.0530	-0.1121	0.0530	-0.1121	0.0530	-0.1121
0.400	-0.0481	-0.0079	0.0451	-0.1021	0.0451	-0.1021	0.0451	-0.1021	0.0451	-0.1021
0.450	-0.0584	-0.0123	0.0435	-0.0961	0.0435	-0.0961	0.0435	-0.0961	0.0435	-0.0961
0.500	-0.0629	-0.0140	0.0284	-0.0904	0.0284	-0.0904	0.0284	-0.0904	0.0284	-0.0904
0.525	*****	-0.0180	0.0237	-0.0877	0.0237	-0.0877	0.0237	-0.0877	0.0237	-0.0877
0.550	-0.0684	-0.0190	0.0218	-0.0852	0.0218	-0.0852	0.0218	-0.0852	0.0218	-0.0852
0.575	*****	-0.0237	0.0221	-0.0830	0.0221	-0.0830	0.0221	-0.0830	0.0221	-0.0830
0.600	-0.0629	-0.0292	0.0111	-0.0846	0.0111	-0.0846	0.0111	-0.0846	0.0111	-0.0846
0.625	*****	0.0112	-0.0812	0.0112	-0.0812	0.0112	-0.0812	0.0112	-0.0812	0.0112
0.650	-0.0574	-0.0327	0.0065	-0.0815	0.0065	-0.0815	0.0065	-0.0815	0.0065	-0.0815
0.675	*****	-0.0422	0.0001	-0.0825	0.0001	-0.0825	0.0001	-0.0825	0.0001	-0.0825
0.700	-0.0467	-0.0551	-0.0047	-0.0841	-0.0047	-0.0841	-0.0047	-0.0841	-0.0047	-0.0841
0.725	*****	-0.0660	*****	-0.0818	*****	-0.0818	*****	-0.0818	*****	-0.0818
0.750	-0.0240	-0.0692	*****	-0.0867	*****	-0.0867	*****	-0.0867	*****	-0.0867
0.775	*****	-0.0759	-0.0258	-0.0888	-0.0258	-0.0888	-0.0258	-0.0888	-0.0258	-0.0888
0.800	-0.0110	-0.0743	-0.0460	-0.0976	-0.0460	-0.0976	-0.0460	-0.0976	-0.0460	-0.0976
0.825	*****	-0.0651	-0.0594	-0.0970	-0.0594	-0.0970	-0.0594	-0.0970	-0.0594	-0.0970
0.850	0.0174	-0.0563	-0.0665	-0.1201	-0.0665	-0.1201	-0.0665	-0.1201	-0.0665	-0.1201
0.875	*****	-0.0376	-0.0647	-0.1351	-0.0647	-0.1351	-0.0647	-0.1351	-0.0647	-0.1351
0.900	0.0593	-0.0185	-0.0487	-0.1345	-0.0487	-0.1345	-0.0487	-0.1345	-0.0487	-0.1345
0.925	*****	0.0086	-0.0242	-0.1132	-0.0242	-0.1132	-0.0242	-0.1132	-0.0242	-0.1132
0.950	0.1051	0.0481	0.0104	-0.0769	0.0104	-0.0769	0.0104	-0.0769	0.0104	-0.0769
0.975	*****	0.0968	0.0712	-0.0025	0.0712	-0.0025	0.0712	-0.0025	0.0712	-0.0025
-0.200	-0.0275	-0.0054	0.0811	*****	0.0811	*****	0.0811	*****	0.0811	*****
-0.400	-0.0531	-0.0084	0.0389	-0.1045	0.0389	-0.1045	0.0389	-0.1045	0.0389	-0.1045
-0.600	*****	-0.0296	0.0093	-0.0881	0.0093	-0.0881	0.0093	-0.0881	0.0093	-0.0881
-0.700	*****	-0.0633	-0.0109	-0.0876	-0.0109	-0.0876	-0.0109	-0.0876	-0.0109	-0.0876
-0.800	-0.0248	-0.0899	-0.0577	-0.1006	-0.0577	-0.1006	-0.0577	-0.1006	-0.0577	-0.1006
-0.850	0.0009	-0.0600	-0.0819	-0.1298	-0.0819	-0.1298	-0.0819	-0.1298	-0.0819	-0.1298
-0.900	0.0389	-0.0459	-0.0771	-0.1522	-0.0771	-0.1522	-0.0771	-0.1522	-0.0771	-0.1522
-0.950	*****	*****	-0.0140	-0.0994	-0.0140	-0.0994	-0.0140	-0.0994	-0.0140	-0.0994
-0.975	*****	0.0778	0.0425	-0.0306	0.0425	-0.0306	0.0425	-0.0306	0.0425	-0.0306

Sharp Radius L.E.
 Run No. = 83, Point No. = 1787
 $C_N = -0.001$, $C_m = -0.0064$
 $\alpha = 0.0^\circ$, $M_\infty = 0.849$
 $R_{mac} = 12.0 \times 10^6$

Surface Pressures Near Leading Edge

● / ◆ upper, starboard/port
 ○ / ◇ lower, starboard/port

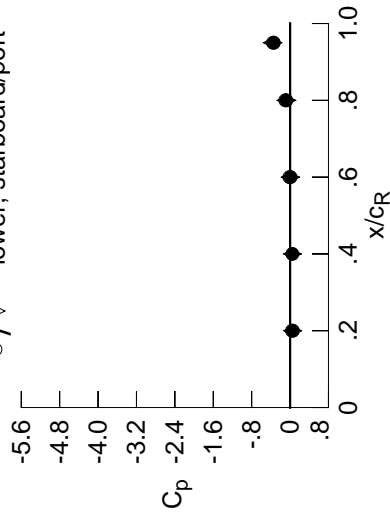

x/c_R	η	starb'd	port	starb'd	port
		$C_{p,u}$	$C_{p,l}$	$C_{p,u}$	$C_{p,l}$
0.20	0.90	0.0593	0.0624	0.0429	0.0389
0.40	0.95	0.0481	0.0551	0.0401	*****
0.60	0.95	0.0104	0.0190	-0.0060	-0.0140
0.80	0.95	-0.0769	-0.0602	-0.0947	-0.0994
0.95	0.95	-0.3387	-0.3509	-0.3796	-0.3554

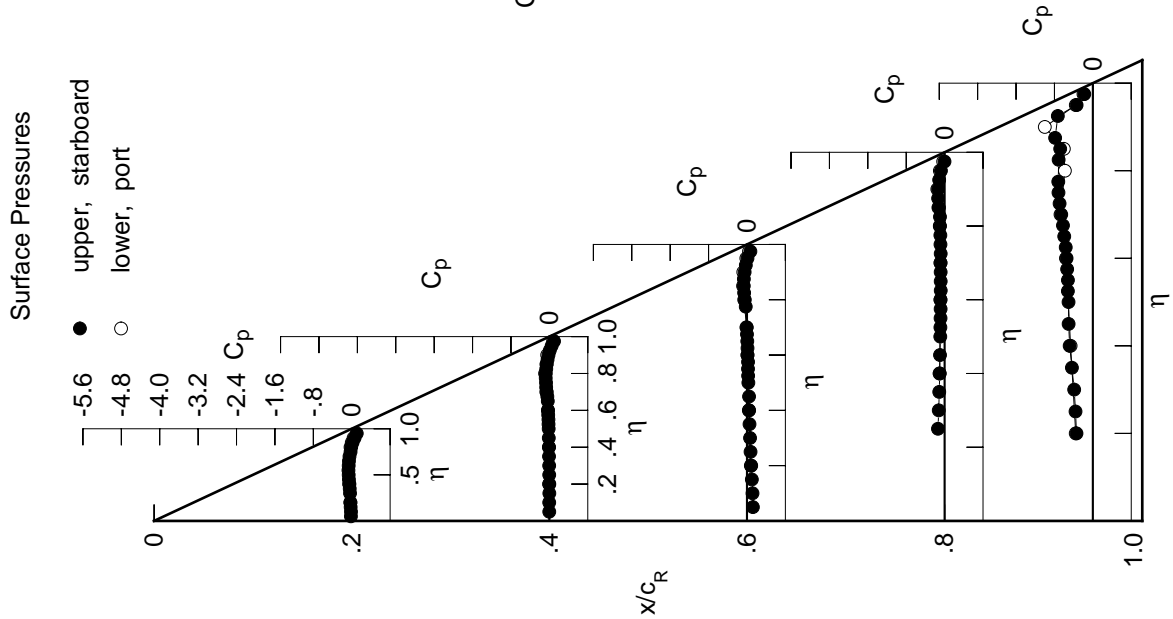

Table C2. Continued.

η	$x/c_R = .2$		$x/c_R = .4$		$x/c_R = .6$		$x/c_R = .8$		$x/c_R = .95$	
	$C_{p,u}$	$C_{p,l}$	$C_{p,u}$	$C_{p,l}$	$C_{p,u}$	$C_{p,l}$	$C_{p,u}$	$C_{p,l}$	$C_{p,u}$	$C_{p,l}$
0.050	-0.0359	-0.0187	0.1116	*****	*****	*****	*****	*****	*****	*****
0.100	-0.0350	-0.0197	0.1024	*****	*****	*****	*****	*****	*****	*****
0.150	-0.0435	-0.0195	0.0882	*****	*****	*****	*****	*****	*****	*****
0.200	-0.0479	-0.0171	0.0761	*****	*****	*****	*****	*****	*****	*****
0.250	*****	-0.0216	0.0619	-0.1502	-0.3383	*****	*****	*****	*****	*****
0.300	-0.0555	-0.0230	0.0507	-0.1346	-0.3585	*****	*****	*****	*****	*****
0.350	-0.0631	-0.0260	0.0385	-0.1234	-0.3952	*****	*****	*****	*****	*****
0.400	-0.0707	-0.0274	0.0300	-0.1143	-0.4360	*****	*****	*****	*****	*****
0.450	-0.0828	-0.0312	0.0282	-0.1087	-0.4589	*****	*****	*****	*****	*****
0.500	-0.0896	-0.0364	0.0114	-0.1040	-0.4584	*****	*****	*****	*****	*****
0.525	*****	-0.0393	0.0076	-0.1013	-0.4699	*****	*****	*****	*****	*****
0.550	-0.0965	-0.0437	0.0039	-0.0986	-0.4670	*****	*****	*****	*****	*****
0.575	*****	-0.0479	0.0039	-0.0989	-0.4769	*****	*****	*****	*****	*****
0.600	-0.0923	-0.0541	-0.0074	-0.1002	-0.4850	*****	*****	*****	*****	*****
0.625	*****	*****	-0.0079	-0.0990	-0.4952	*****	*****	*****	*****	*****
0.650	-0.0871	-0.0589	-0.0169	-0.0991	-0.5199	*****	*****	*****	*****	*****
0.675	*****	-0.0706	-0.0216	-0.1009	-0.5405	*****	*****	*****	*****	*****
0.700	-0.0804	-0.0863	-0.0286	-0.1023	-0.5739	*****	*****	*****	*****	*****
0.725	*****	-0.1002	*****	-0.1030	-0.6198	*****	*****	*****	*****	*****
0.750	-0.0728	-0.1055	*****	-0.1082	-0.6598	*****	*****	*****	*****	*****
0.775	*****	-0.1152	-0.0560	-0.1138	-0.6558	*****	*****	*****	*****	*****
0.800	-0.0523	-0.1176	-0.0798	-0.1237	*****	*****	*****	*****	*****	*****
0.825	*****	-0.1112	-0.0978	-0.1266	-0.5942	*****	*****	*****	*****	*****
0.850	-0.0223	-0.1054	-0.1122	-0.1557	-0.6609	*****	*****	*****	*****	*****
0.875	*****	-0.0909	-0.1111	-0.1786	-0.8150	*****	*****	*****	*****	*****
0.900	0.0198	-0.0698	-0.1053	-0.1853	*****	*****	*****	*****	*****	*****
0.925	*****	-0.0371	-0.0864	-0.1716	-0.7411	*****	*****	*****	*****	*****
0.950	0.0725	0.0002	-0.0432	-0.1388	-0.3887	*****	*****	*****	*****	*****
0.975	*****	0.0499	0.0153	-0.0589	-0.2283	*****	*****	*****	*****	*****
-0.200	-0.0057	0.0137	0.0953	*****	-0.3691	*****	*****	*****	*****	*****
-0.400	-0.0286	0.0137	0.0547	-0.0908	-0.4934	*****	*****	*****	*****	*****
-0.600	*****	-0.0043	0.0296	-0.0703	-0.5894	*****	*****	*****	*****	*****
-0.700	*****	-0.0320	0.0135	-0.0681	-0.6925	*****	*****	*****	*****	*****
-0.800	0.0188	-0.0483	-0.0243	-0.0740	-0.6762	*****	*****	*****	*****	*****
-0.850	0.0406	-0.0236	-0.0381	-0.0953	-0.6898	*****	*****	*****	*****	*****
-0.900	0.0778	0.0127	-0.0247	-0.1052	-0.9074	*****	*****	*****	*****	*****
-0.950	*****	*****	0.0494	-0.0422	-0.3158	*****	*****	*****	*****	*****
-0.975	*****	0.1268	0.1014	0.0323	-0.1493	*****	*****	*****	*****	*****

Sharp Radius L.E.
 Run No. = 83 , Point No. = 1788
 $C_N = 0.039$, $C_m = -0.0119$
 $\alpha = 1.1^\circ$, $M_\infty = 0.849$
 $R_{mac} = 12.0 \times 10^6$

Surface Pressures Near Leading Edge

● / ◆ upper, starboard/port
 ○ / ◇ lower, starboard/port

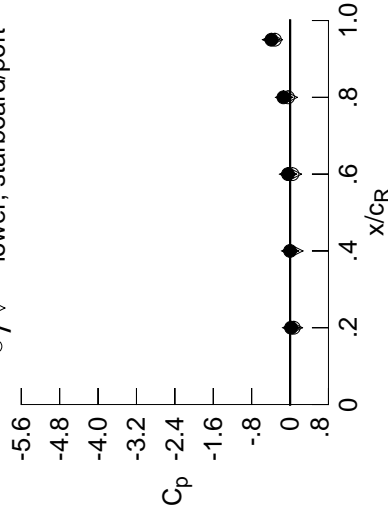

x/c_R	η	starb'd	port	starb'd	port
		$C_{p,u}$	$C_{p,l}$	$C_{p,u}$	$C_{p,l}$
0.20	0.90	0.0198	0.0232	0.0820	0.0778
0.40	0.95	0.0002	0.0023	0.0896	*****
0.60	0.95	-0.0432	-0.0419	0.0590	0.0494
0.80	0.95	-0.1388	-0.1241	-0.0271	-0.0422
0.95	0.95	-0.3887	-0.3968	-0.3379	-0.3158

Surface Pressures

● upper, starboard
 ○ lower, port

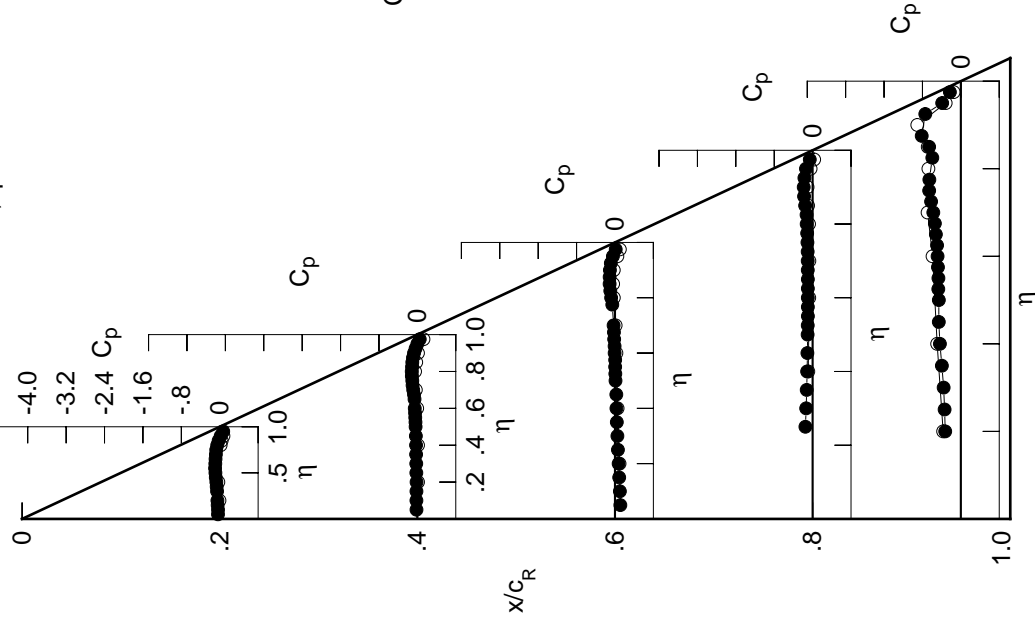

Table C2. Continued.

η	$x/c_R = .2$		$x/c_R = .4$		$x/c_R = .6$		$x/c_R = .8$		$x/c_R = .95$	
	$C_{p,u}$	$C_{p,l}$	$C_{p,u}$	$C_{p,l}$	$C_{p,u}$	$C_{p,l}$	$C_{p,u}$	$C_{p,l}$	$C_{p,u}$	$C_{p,l}$
0.050	-0.0549	-0.0371	0.0987	0.0987	0.0987	0.0987	0.0987	0.0987	0.0987	0.0987
0.100	-0.0539	-0.0384	0.0907	0.0907	0.0907	0.0907	0.0907	0.0907	0.0907	0.0907
0.150	-0.0628	-0.0371	0.0759	0.0759	0.0759	0.0759	0.0759	0.0759	0.0759	0.0759
0.200	-0.0700	-0.0368	0.0626	0.0626	0.0626	0.0626	0.0626	0.0626	0.0626	0.0626
0.250	*****	-0.0401	0.0496	-0.1622	-0.3288	0.0496	-0.1622	-0.3288	0.0496	-0.3288
0.300	-0.0778	-0.0421	0.0372	-0.1465	-0.3483	0.0372	-0.1465	-0.3483	0.0372	-0.3483
0.350	-0.0864	-0.0449	0.0238	-0.1355	-0.3819	0.0238	-0.1355	-0.3819	0.0238	-0.3819
0.400	-0.0948	-0.0468	0.0152	-0.1270	-0.4220	0.0152	-0.1270	-0.4220	0.0152	-0.4220
0.450	-0.1090	-0.0537	0.0123	-0.1224	-0.4484	0.0123	-0.1224	-0.4484	0.0123	-0.4484
0.500	-0.1177	-0.0575	0.0058	-0.1172	-0.4456	0.0058	-0.1172	-0.4456	0.0058	-0.4456
0.525	*****	-0.0636	-0.0102	-0.1168	-0.4536	-0.0636	-0.0102	-0.1168	-0.4536	-0.4536
0.550	-0.1273	-0.0659	-0.0151	-0.1135	-0.4474	-0.1273	-0.0659	-0.0151	-0.1135	-0.4474
0.575	*****	-0.0732	-0.0157	-0.1148	-0.4543	-0.0732	-0.0157	-0.1148	-0.4543	-0.4543
0.600	-0.1269	-0.0798	-0.0266	-0.1173	-0.4584	-0.1269	-0.0798	-0.0266	-0.1173	-0.4584
0.625	*****	*****	-0.0293	-0.1160	-0.4602	*****	*****	-0.0293	-0.1160	-0.4602
0.650	-0.1261	-0.0859	-0.0384	-0.1159	-0.4686	-0.1261	-0.0859	-0.0384	-0.1159	-0.4686
0.675	*****	-0.1002	-0.0453	-0.1209	-0.4736	*****	-0.1002	-0.0453	-0.1209	-0.4736
0.700	-0.1184	-0.1179	-0.0528	-0.1225	-0.4841	-0.1184	-0.1179	-0.0528	-0.1225	-0.4841
0.725	*****	-0.1355	*****	-0.1248	-0.5001	*****	-0.1355	*****	-0.1248	-0.5001
0.750	-0.1046	-0.1443	*****	-0.1315	-0.5137	-0.1046	-0.1443	*****	-0.1315	-0.5137
0.775	*****	-0.1575	-0.0875	-0.1400	-0.4957	*****	-0.1575	-0.0875	-0.1400	-0.4957
0.800	-0.0866	-0.1623	-0.1156	-0.1512	*****	-0.0866	-0.1623	-0.1156	-0.1512	*****
0.825	*****	-0.1591	-0.1387	-0.1578	-0.4683	*****	-0.1591	-0.1387	-0.1578	-0.4683
0.850	-0.0580	-0.1561	-0.1576	-0.1930	-0.5627	-0.0580	-0.1561	-0.1576	-0.1930	-0.5627
0.875	*****	-0.1461	-0.1587	-0.2239	-0.5596	*****	-0.1461	-0.1587	-0.2239	-0.5596
0.900	-0.0204	-0.1259	-0.1617	-0.2395	*****	-0.0204	-0.1259	-0.1617	-0.2395	*****
0.925	*****	-0.0959	-0.1486	-0.2351	-0.7735	*****	-0.0959	-0.1486	-0.2351	-0.7735
0.950	0.0240	-0.0585	-0.1091	-0.2085	-0.4281	0.0240	-0.0585	-0.1091	-0.2085	-0.4281
0.975	*****	-0.0105	-0.0511	-0.1358	-0.2790	*****	-0.0105	-0.0511	-0.1358	-0.2790
-0.200	0.0162	0.0330	0.1094	*****	-0.3822	0.0162	0.0330	0.1094	*****	-0.3822
-0.400	-0.0048	0.0323	0.0706	-0.0780	-0.5260	-0.0048	0.0323	0.0706	-0.0780	-0.5260
-0.600	*****	0.0214	0.0482	-0.0541	-0.6504	*****	0.0214	0.0482	-0.0541	-0.6504
-0.700	*****	-0.0026	0.0370	-0.0493	-0.7236	*****	-0.0026	0.0370	-0.0493	-0.7236
-0.800	0.0521	-0.0094	0.0070	-0.0481	-0.7002	0.0521	-0.0094	0.0070	-0.0481	-0.7002
-0.850	0.0814	0.0127	0.0006	-0.0630	-0.7058	0.0814	0.0127	0.0006	-0.0630	-0.7058
-0.900	0.1122	0.0553	0.0221	-0.0614	-0.8266	0.1122	0.0553	0.0221	-0.0614	-0.8266
-0.950	*****	*****	0.0994	0.0084	-0.2831	*****	*****	0.0994	0.0084	-0.2831
-0.975	*****	0.1611	0.1399	0.0740	-0.1169	*****	0.1611	0.1399	0.0740	-0.1169

Sharp Radius L.E.
 Run No. = 83 , Point No. = 1789
 $C_N = 0.085$, $C_m = -0.0217$
 $\alpha = 2.1^\circ$, $M_\infty = 0.849$
 $R_{mac} = 12.0 \times 10^6$

Surface Pressures Near Leading Edge

● / ◆ upper, starboard/port
 ○ / ◇ lower, starboard/port

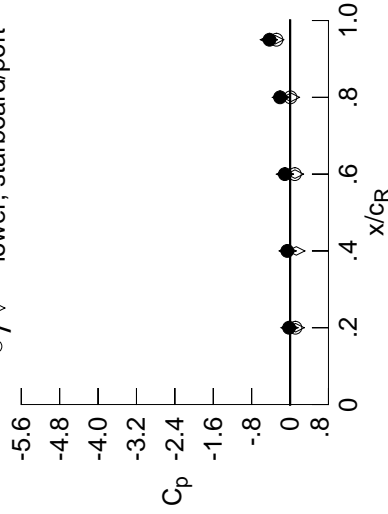

x/c_R	η	starb'd	port	starb'd	port
		$C_{p,u}$	$C_{p,l}$	$C_{p,u}$	$C_{p,l}$
0.20	0.90	-0.0204	-0.0127	0.1165	0.1122
0.40	0.95	-0.0585	-0.0509	0.1298	*****
0.60	0.95	-0.1091	-0.1072	0.1024	0.0994
0.80	0.95	-0.2085	-0.1916	0.0191	0.0084
0.95	0.95	-0.4281	-0.4414	-0.3093	-0.2831

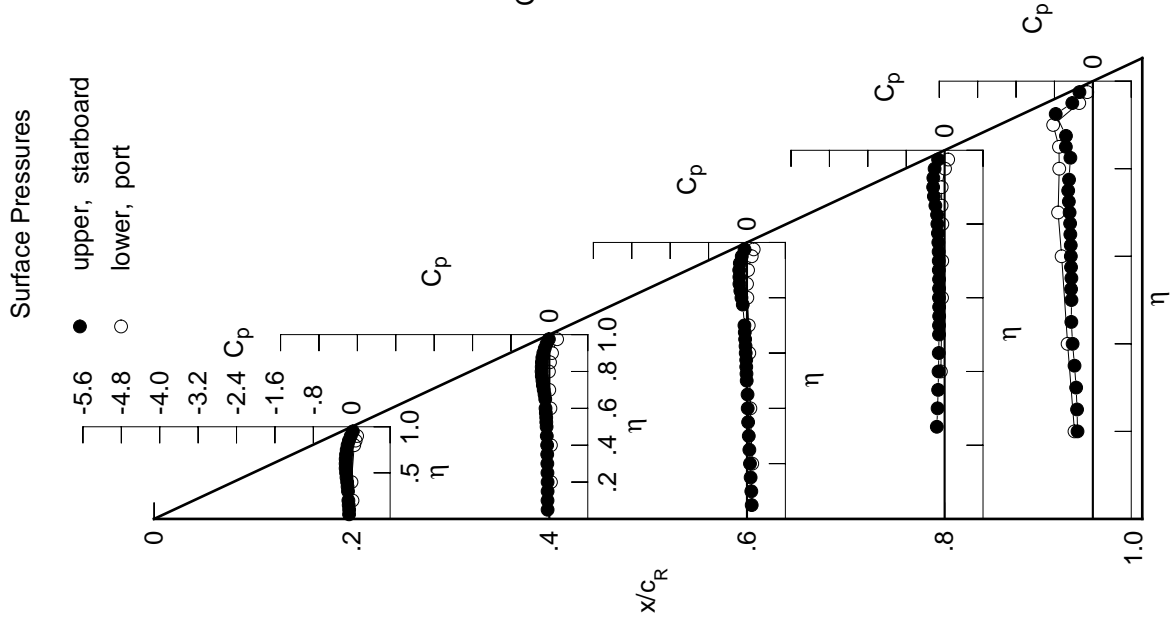

Table C2. Continued.

η	$x/c_R = .2$		$x/c_R = .4$		$x/c_R = .6$		$x/c_R = .8$		$x/c_R = .95$	
	$C_{p,u}$	$C_{p,l}$	$C_{p,u}$	$C_{p,l}$	$C_{p,u}$	$C_{p,l}$	$C_{p,u}$	$C_{p,l}$	$C_{p,u}$	$C_{p,l}$
0.050	-0.0752	-0.0553	0.0864	0.0864	0.0864	0.0864	0.0864	0.0864	0.0864	0.0864
0.100	-0.0758	-0.0556	0.0777	0.0777	0.0777	0.0777	0.0777	0.0777	0.0777	0.0777
0.150	-0.0858	-0.0553	0.0629	0.0629	0.0629	0.0629	0.0629	0.0629	0.0629	0.0629
0.200	-0.0906	-0.0548	0.0493	0.0493	0.0493	0.0493	0.0493	0.0493	0.0493	0.0493
0.250	*****	-0.0597	0.0351	-0.1754	0.0351	-0.1754	0.0351	-0.1754	0.0351	-0.3205
0.300	-0.0995	-0.0611	0.0222	-0.1601	0.0222	-0.1601	0.0222	-0.1601	0.0222	-0.3360
0.350	-0.1096	-0.0651	0.0089	-0.1491	0.0089	-0.1491	0.0089	-0.1491	0.0089	-0.3723
0.400	-0.1195	-0.0689	0.0004	-0.1404	0.0004	-0.1404	0.0004	-0.1404	0.0004	-0.4122
0.450	-0.1349	-0.0758	-0.0046	-0.1364	-0.0046	-0.1364	-0.0046	-0.1364	-0.0046	-0.4413
0.500	-0.1456	-0.0809	-0.0227	-0.1330	-0.0227	-0.1330	-0.0227	-0.1330	-0.0227	-0.4393
0.525	*****	-0.0879	-0.0294	-0.1318	-0.0294	-0.1318	-0.0294	-0.1318	-0.0294	-0.4401
0.550	-0.1580	-0.0914	-0.0333	-0.1304	-0.0333	-0.1304	-0.0333	-0.1304	-0.0333	-0.4282
0.575	*****	-0.0987	-0.0366	-0.1322	-0.0366	-0.1322	-0.0366	-0.1322	-0.0366	-0.4284
0.600	-0.1601	-0.1077	-0.0481	-0.1344	-0.0481	-0.1344	-0.0481	-0.1344	-0.0481	-0.4300
0.625	*****	*****	-0.0519	-0.1349	-0.0519	-0.1349	-0.0519	-0.1349	-0.0519	-0.4387
0.650	-0.1626	-0.1153	-0.0611	-0.1368	-0.0611	-0.1368	-0.0611	-0.1368	-0.0611	-0.4536
0.675	*****	-0.1293	-0.0702	-0.1419	-0.0702	-0.1419	-0.0702	-0.1419	-0.0702	-0.4613
0.700	-0.1568	-0.1502	-0.0785	-0.1450	-0.0785	-0.1450	-0.0785	-0.1450	-0.0785	-0.4743
0.725	*****	-0.1700	*****	-0.1492	-0.1492	-0.4882	*****	-0.1492	-0.4882	*****
0.750	-0.1441	-0.1822	*****	-0.1575	-0.1575	-0.4957	*****	-0.1575	-0.4957	*****
0.775	*****	-0.1994	-0.1200	-0.1676	-0.1676	-0.4798	*****	-0.1676	-0.4798	*****
0.800	-0.1295	-0.2055	-0.1495	-0.1820	-0.1495	-0.1820	*****	-0.1820	*****	*****
0.825	*****	-0.2071	-0.1768	-0.1906	-0.1906	-0.4494	*****	-0.1906	-0.4494	*****
0.850	-0.1021	-0.2077	-0.2019	-0.2294	-0.2019	-0.2294	-0.4815	-0.2019	-0.2294	-0.4815
0.875	*****	-0.1991	-0.2043	-0.2670	-0.2670	-0.5261	*****	-0.2670	-0.5261	*****
0.900	-0.0663	-0.1816	-0.2170	-0.2907	-0.2170	-0.2907	*****	-0.2907	*****	*****
0.925	*****	-0.1479	-0.2054	-0.2939	-0.2939	-0.8013	*****	-0.2939	-0.8013	*****
0.950	-0.0294	-0.1025	-0.1555	-0.2705	-0.1555	-0.2705	-0.4698	-0.1555	-0.2705	-0.4698
0.975	*****	-0.2050	-0.2276	-0.2158	-0.2158	-0.3274	*****	-0.2158	-0.3274	*****
-0.200	0.0382	0.0496	0.1228	0.1228	0.1228	0.1228	0.1228	0.1228	0.1228	0.1228
-0.400	0.0191	0.0520	0.0859	0.0859	0.0859	0.0859	0.0859	0.0859	0.0859	0.0859
-0.600	*****	0.0452	0.0658	-0.0395	0.0658	-0.0395	0.0658	-0.0395	0.0658	-0.0395
-0.700	*****	0.0262	0.0583	-0.0323	0.0583	-0.0323	0.0583	-0.0323	0.0583	-0.0323
-0.800	0.0843	0.0260	0.0356	-0.0252	0.0356	-0.0252	0.0356	-0.0252	0.0356	-0.0252
-0.850	0.1140	0.0465	0.0356	-0.0346	0.0356	-0.0346	0.0356	-0.0346	0.0356	-0.0346
-0.900	0.1411	0.0945	0.0621	-0.0240	0.0621	-0.0240	0.0621	-0.0240	0.0621	-0.0240
-0.950	*****	*****	0.1334	0.0472	0.1334	0.0472	-0.2599	0.1334	0.0472	-0.2599
-0.975	*****	0.1824	0.1662	0.1115	0.1662	0.1115	-0.0873	0.1662	0.1115	-0.0873

Sharp Radius L.E.
 Run No. = 83, Point No. = 1790
 $C_N = 0.128$, $C_m = -0.0292$
 $\alpha = 3.2^\circ$, $M_\infty = 0.849$
 $R_{mac} = 12.0 \times 10^6$

Surface Pressures Near Leading Edge

● / ◆ upper, starboard/port
 ○ / ◇ lower, starboard/port

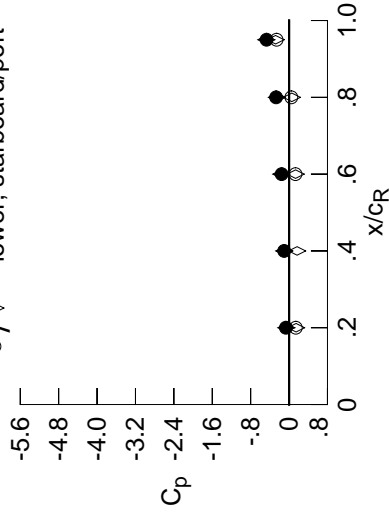

x/c_R	η	starb'd	port	starb'd	port
		$C_{p,u}$	$C_{p,l}$	$C_{p,u}$	$C_{p,l}$
0.20	0.90	-0.0663	-0.0574	0.1462	0.1411
0.40	0.95	-0.1025	-0.1007	0.1674	*****
0.60	0.95	-0.1555	-0.1625	0.1362	0.1334
0.80	0.95	-0.2705	-0.2541	0.0577	0.0472
0.95	0.95	-0.4698	-0.4746	-0.2809	-0.2599

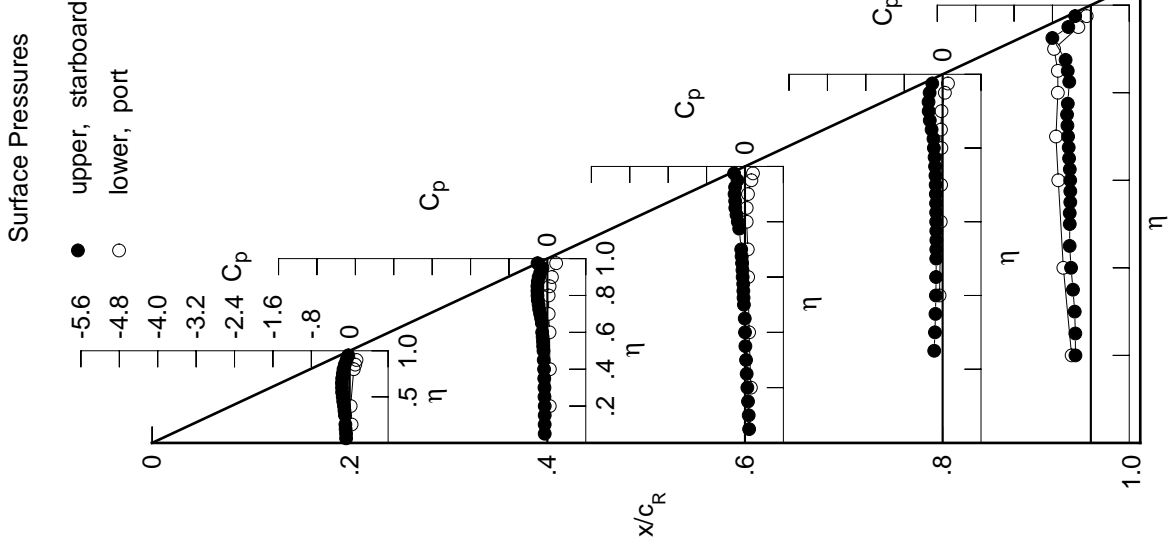

Table C2. Continued.

η	$x/c_R = .2$		$x/c_R = .4$		$x/c_R = .6$		$x/c_R = .8$		$x/c_R = .95$			
	$C_{p,u}$	$C_{p,l}$	$C_{p,u}$	$C_{p,l}$	$C_{p,u}$	$C_{p,l}$	$C_{p,u}$	$C_{p,l}$	$C_{p,u}$	$C_{p,l}$		
0.050	-0.0944	-0.0718	0.0735	*****	0.0735	*****	0.0735	*****	0.0735	*****		
0.100	-0.0959	-0.0730	0.0648	*****	0.0648	*****	0.0648	*****	0.0648	*****		
0.150	-0.1050	-0.0725	0.0503	*****	0.0503	*****	0.0503	*****	0.0503	*****		
0.200	-0.1106	-0.0718	0.0359	*****	0.0359	*****	0.0359	*****	0.0359	*****		
0.250	*****	-0.0775	0.0218	-0.1886	-0.1886	-0.3130	-0.1886	-0.3130	-0.1886	-0.3130		
0.300	-0.1210	-0.0801	0.0083	-0.1727	-0.1727	-0.3088	-0.1727	-0.3088	-0.1727	-0.3088		
0.350	-0.1322	-0.0845	-0.0053	-0.1628	-0.1628	-0.3470	-0.1628	-0.3470	-0.1628	-0.3470		
0.400	-0.1436	-0.0899	-0.0151	-0.1539	-0.1539	-0.3901	-0.1539	-0.3901	-0.1539	-0.3901		
0.450	-0.1600	-0.0976	-0.0200	-0.1508	-0.1508	-0.4193	-0.1508	-0.4193	-0.1508	-0.4193		
0.500	-0.1731	-0.1055	-0.0424	-0.1490	-0.1490	-0.4302	-0.1490	-0.4302	-0.1490	-0.4302		
0.525	*****	-0.1120	-0.0480	-0.1497	-0.1497	-0.4367	-0.1497	-0.4367	-0.1497	-0.4367		
0.550	-0.1875	-0.1159	-0.0542	-0.1468	-0.1468	-0.4252	-0.1468	-0.4252	-0.1468	-0.4252		
0.575	*****	-0.1242	-0.0568	-0.1500	-0.1500	-0.4281	-0.1500	-0.4281	-0.1500	-0.4281		
0.600	-0.1922	-0.1335	-0.0705	-0.1528	-0.1528	-0.4314	-0.1528	-0.4314	-0.1528	-0.4314		
0.625	*****	*****	-0.0741	-0.1542	-0.1542	-0.4447	-0.1542	-0.4447	-0.1542	-0.4447		
0.650	-0.1970	-0.1426	-0.0843	-0.1572	-0.1572	-0.4678	-0.1572	-0.4678	-0.1572	-0.4678		
0.675	*****	-0.1614	-0.0947	-0.1636	-0.1636	-0.4816	-0.1636	-0.4816	-0.1636	-0.4816		
0.700	-0.1933	-0.1818	-0.1043	-0.1670	-0.1670	-0.5032	-0.1670	-0.5032	-0.1670	-0.5032		
0.725	*****	-0.2046	*****	-0.1726	-0.1726	-0.5315	-0.1726	-0.5315	-0.1726	-0.5315		
0.750	-0.1832	-0.2191	*****	-0.1833	-0.1833	-0.5626	-0.1833	-0.5626	-0.1833	-0.5626		
0.775	*****	-0.2385	-0.1498	-0.1974	-0.1974	-0.5854	-0.1974	-0.5854	-0.1974	-0.5854		
0.800	-0.1706	-0.2495	-0.1831	-0.2119	-0.2119	*****	-0.2119	*****	-0.2119	*****		
0.825	*****	-0.2524	-0.2132	-0.2219	-0.2219	-0.5859	-0.2219	-0.5859	-0.2219	-0.5859		
0.850	-0.1428	-0.2537	-0.2411	-0.2637	-0.2637	-0.5113	-0.2637	-0.5113	-0.2637	-0.5113		
0.875	*****	-0.2442	-0.2406	-0.3034	-0.3034	-0.5186	-0.3034	-0.5186	-0.3034	-0.5186		
0.900	-0.1001	-0.2175	-0.2543	-0.3277	-0.3277	*****	-0.3277	*****	-0.3277	*****		
0.925	*****	-0.1832	-0.2343	-0.3320	-0.3320	-0.8236	-0.3320	-0.8236	-0.3320	-0.8236		
0.950	-0.0895	-0.2905	-0.3114	-0.3277	-0.3277	-0.5002	-0.3277	-0.5002	-0.3277	-0.5002		
0.975	*****	-0.4091	-0.4728	-0.5136	-0.5136	-0.5082	-0.5136	-0.5082	-0.5136	-0.5082		
-0.200	$C_{p,l}$	0.0611	0.0696	0.1373	*****	-0.4184	$C_{p,l}$	0.0611	0.0696	0.1373	*****	
-0.400	$C_{p,l}$	0.0442	0.0722	0.1020	-0.0505	-0.6003	$C_{p,l}$	0.0442	0.0722	0.1020	-0.0505	-0.6003
-0.600	$C_{p,l}$	*****	0.0698	0.0851	-0.0229	-0.6914	$C_{p,l}$	*****	0.0698	0.0851	-0.0229	-0.6914
-0.700	$C_{p,l}$	*****	0.0542	0.0801	-0.0143	-0.7168	$C_{p,l}$	*****	0.0542	0.0801	-0.0143	-0.7168
-0.800	$C_{p,l}$	0.1156	0.0603	0.0633	-0.0017	-0.6687	$C_{p,l}$	0.1156	0.0603	0.0633	-0.0017	-0.6687
-0.850	$C_{p,l}$	0.1431	0.0788	0.0688	-0.0065	-0.6675	$C_{p,l}$	0.1431	0.0788	0.0688	-0.0065	-0.6675
-0.900	$C_{p,l}$	0.1672	0.1281	0.0978	0.0097	-0.7188	$C_{p,l}$	0.1672	0.1281	0.0978	0.0097	-0.7188
-0.950	$C_{p,l}$	*****	*****	0.1622	0.0805	-0.2365	$C_{p,l}$	*****	*****	0.1622	0.0805	-0.2365
-0.975	$C_{p,l}$	*****	0.1967	0.1866	0.1325	-0.0683	$C_{p,l}$	*****	0.1967	0.1866	0.1325	-0.0683

Sharp Radius L.E.

Run No. = 83, Point No. = 1791

$C_N = 0.175$, $C_m = -0.0382$

$\alpha = 4.2^\circ$, $M_\infty = 0.849$

$R_{mac} = 11.9 \times 10^6$

Surface Pressures Near Leading Edge

● / ◆ upper, starboard/port
○ / ◇ lower, starboard/port

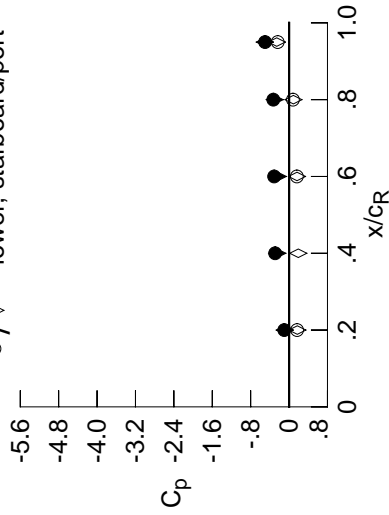

x/cR	η	$C_{p,u}$ starb'd	$C_{p,u}$ port	$C_{p,l}$ starb'd	$C_{p,l}$ port
0.20	0.90	-0.1001	-0.0910	0.1717	0.1672
0.40	0.95	-0.2905	-0.2447	0.1924	*****
0.60	0.95	-0.3114	-0.2347	0.1656	0.1622
0.80	0.95	-0.3277	-0.2995	0.0894	0.0805
0.95	0.95	-0.5002	-0.5061	-0.2571	-0.2365

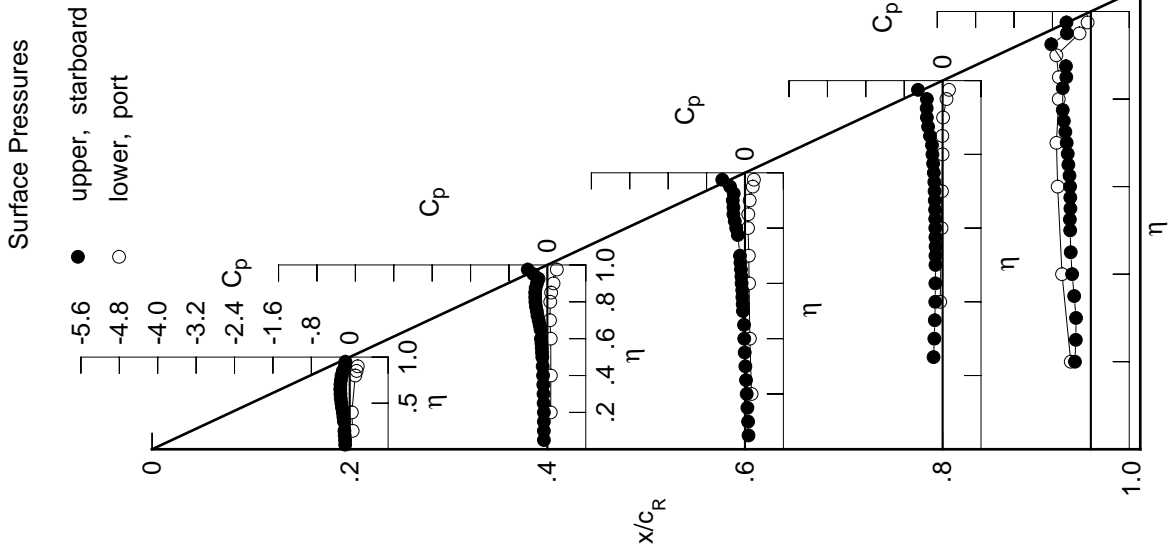

Table C2. Continued.

η	$x/c_R = .2$		$x/c_R = .4$		$x/c_R = .6$		$x/c_R = .8$		$x/c_R = .95$	
	$C_{p,u}$	$C_{p,l}$	$C_{p,u}$	$C_{p,l}$	$C_{p,u}$	$C_{p,l}$	$C_{p,u}$	$C_{p,l}$	$C_{p,u}$	$C_{p,l}$
0.050	-0.1141	-0.0895	0.0618	*****	*****	*****	*****	*****	*****	*****
0.100	-0.1159	-0.0910	0.0518	*****	*****	*****	*****	*****	*****	*****
0.150	-0.1244	-0.0906	0.0377	*****	*****	*****	*****	*****	*****	*****
0.200	-0.1329	-0.0913	0.0223	*****	*****	*****	*****	*****	*****	*****
0.250	*****	-0.0967	0.0084	-0.2027	-0.3296	*****	*****	*****	*****	*****
0.300	-0.1423	-0.0998	-0.0072	-0.1867	-0.3082	*****	*****	*****	*****	*****
0.350	-0.1545	-0.1053	-0.0219	-0.1770	-0.3259	*****	*****	*****	*****	*****
0.400	-0.1665	-0.1109	-0.0312	-0.1689	-0.3615	*****	*****	*****	*****	*****
0.450	-0.1858	-0.1224	-0.0361	-0.1660	-0.3846	*****	*****	*****	*****	*****
0.500	-0.2004	-0.1286	-0.0591	-0.1656	-0.3982	*****	*****	*****	*****	*****
0.525	*****	-0.1364	-0.0665	-0.1646	-0.4131	*****	*****	*****	*****	*****
0.550	-0.2172	-0.1399	-0.0728	-0.1655	-0.4133	*****	*****	*****	*****	*****
0.575	*****	-0.1482	-0.0763	-0.1669	-0.4269	*****	*****	*****	*****	*****
0.600	-0.2241	-0.1588	-0.0916	-0.1722	-0.4467	*****	*****	*****	*****	*****
0.625	*****	*****	-0.0955	-0.1728	-0.4864	*****	*****	*****	*****	*****
0.650	-0.2301	-0.1712	-0.1061	-0.1759	-0.5545	*****	*****	*****	*****	*****
0.675	*****	-0.1919	-0.1182	-0.1825	-0.6038	*****	*****	*****	*****	*****
0.700	-0.2287	-0.2145	-0.1287	-0.1881	-0.6467	*****	*****	*****	*****	*****
0.725	*****	-0.2384	*****	-0.1927	-0.7046	*****	*****	*****	*****	*****
0.750	-0.2195	-0.2550	*****	-0.2055	-0.7321	*****	*****	*****	*****	*****
0.775	*****	-0.2746	-0.1786	-0.2255	-0.7542	*****	*****	*****	*****	*****
0.800	-0.2025	-0.2857	-0.2106	-0.2475	*****	*****	*****	*****	*****	*****
0.825	*****	-0.2857	-0.2396	-0.2545	-0.7706	*****	*****	*****	*****	*****
0.850	-0.1608	-0.2838	-0.2607	-0.3007	-0.6317	*****	*****	*****	*****	*****
0.875	*****	-0.2641	-0.2553	-0.3352	-0.8242	*****	*****	*****	*****	*****
0.900	-0.1896	-0.2761	-0.3227	-0.3730	*****	*****	*****	*****	*****	*****
0.925	*****	-0.4127	-0.4673	-0.4845	-0.8691	*****	*****	*****	*****	*****
0.950	-0.1549	-0.5397	-0.5900	-0.6017	-0.5672	*****	*****	*****	*****	*****
0.975	*****	-0.5261	-0.5787	-0.6304	-0.4501	*****	*****	*****	*****	*****
-0.200	0.0855	0.0909	0.1536	*****	-0.4400	*****	*****	*****	*****	*****
-0.400	0.0708	0.0941	0.1182	-0.0342	-0.6266	*****	*****	*****	*****	*****
-0.600	*****	0.0951	0.1053	-0.0067	-0.6985	*****	*****	*****	*****	*****
-0.700	*****	0.0828	0.1025	0.0057	-0.7033	*****	*****	*****	*****	*****
-0.800	0.1470	0.0937	0.0907	0.0220	-0.6500	*****	*****	*****	*****	*****
-0.850	0.1648	0.1098	0.1005	0.0202	-0.6450	*****	*****	*****	*****	*****
-0.900	0.1913	0.1588	0.1310	0.0413	-0.6761	*****	*****	*****	*****	*****
-0.950	*****	*****	0.1860	0.1075	-0.2098	*****	*****	*****	*****	*****
-0.975	*****	0.2107	0.1966	0.1461	-0.0433	*****	*****	*****	*****	*****

Sharp Radius L.E.
 Run No. = 83, Point No. = 1792
 $C_N = 0.223$, $C_m = -0.0468$
 $\alpha = 5.3^\circ$, $M_\infty = 0.849$
 $R_{mac} = 11.9 \times 10^6$

Surface Pressures Near Leading Edge

● / ◆ upper, starboard/port
 ○ / ◇ lower, starboard/port

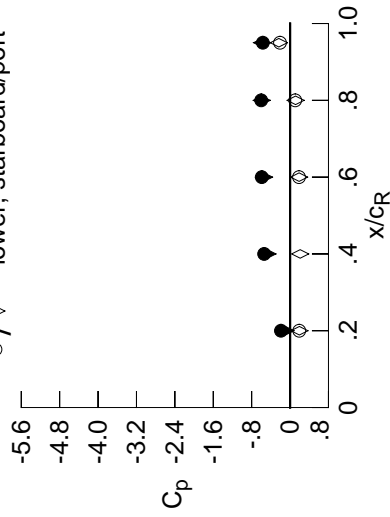

x/c_R	η	starb'd	port	starb'd	port
		$C_{p,u}$	$C_{p,l}$	$C_{p,u}$	$C_{p,l}$
0.20	0.90	-0.1896	-0.0959	0.1942	0.1913
0.40	0.95	-0.5397	-0.4722	0.2108	*****
0.60	0.95	-0.5900	-0.5420	0.1878	0.1860
0.80	0.95	-0.6017	-0.5904	0.1149	0.1075
0.95	0.95	-0.5672	-0.5837	-0.2340	-0.2098

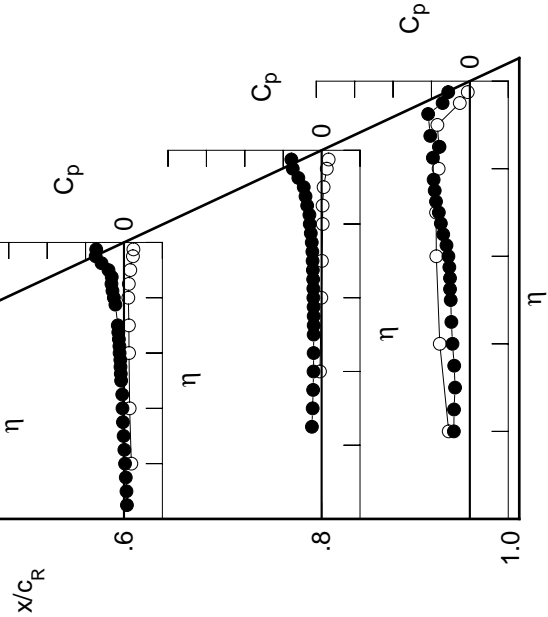

Table C2. Continued.

η	$x/c_R = .2$		$x/c_R = .4$		$x/c_R = .6$		$x/c_R = .8$		$x/c_R = .95$	
	$C_{p,u}$	$C_{p,l}$	$C_{p,u}$	$C_{p,l}$	$C_{p,u}$	$C_{p,l}$	$C_{p,u}$	$C_{p,l}$	$C_{p,u}$	$C_{p,l}$
0.050	-0.1333	-0.1083	0.0488	*****	*****	*****	*****	*****	*****	*****
0.100	-0.1358	-0.1091	0.0393	*****	*****	*****	*****	*****	*****	*****
0.150	-0.1454	-0.1119	0.0246	*****	*****	*****	*****	*****	*****	*****
0.200	-0.1531	-0.1088	0.0088	*****	*****	*****	*****	*****	*****	*****
0.250	*****	-0.1175	-0.0068	-0.2200	-0.3323	*****	*****	*****	*****	*****
0.300	-0.1634	-0.1208	-0.0264	-0.2076	-0.3001	*****	*****	*****	*****	*****
0.350	-0.1769	-0.1264	-0.0402	-0.1954	-0.2916	*****	*****	*****	*****	*****
0.400	-0.1902	-0.1368	-0.0486	-0.1882	-0.3138	*****	*****	*****	*****	*****
0.450	-0.2109	-0.1486	-0.0529	-0.1849	-0.3248	*****	*****	*****	*****	*****
0.500	-0.2273	-0.1525	-0.0773	-0.1846	-0.3413	*****	*****	*****	*****	*****
0.525	*****	-0.1586	-0.0842	-0.1820	-0.3714	*****	*****	*****	*****	*****
0.550	-0.2466	-0.1650	-0.0925	-0.1808	-0.3987	*****	*****	*****	*****	*****
0.575	*****	-0.1747	-0.0934	-0.1829	-0.4678	*****	*****	*****	*****	*****
0.600	-0.2538	-0.1841	-0.1105	-0.1845	-0.5634	*****	*****	*****	*****	*****
0.625	*****	*****	-0.1130	-0.1849	-0.6870	*****	*****	*****	*****	*****
0.650	-0.2608	-0.1949	-0.1249	-0.1834	-0.7708	*****	*****	*****	*****	*****
0.675	*****	-0.2193	-0.1330	-0.1850	-0.7807	*****	*****	*****	*****	*****
0.700	-0.2584	-0.2428	-0.1450	-0.1823	-0.7766	*****	*****	*****	*****	*****
0.725	*****	-0.2663	*****	-0.1749	-0.7557	*****	*****	*****	*****	*****
0.750	-0.2432	-0.2834	*****	-0.1722	-0.7816	*****	*****	*****	*****	*****
0.775	*****	-0.3014	-0.1893	-0.2390	-0.8636	*****	*****	*****	*****	*****
0.800	-0.2098	-0.3034	-0.2250	-0.3850	*****	*****	*****	*****	*****	*****
0.825	*****	-0.3018	-0.2801	-0.4984	-0.9096	*****	*****	*****	*****	*****
0.850	-0.1972	-0.3247	-0.3899	-0.5743	-0.7826	*****	*****	*****	*****	*****
0.875	*****	-0.4034	-0.4992	-0.5989	-0.7795	*****	*****	*****	*****	*****
0.900	-0.4249	-0.5621	-0.6315	-0.6078	*****	*****	*****	*****	*****	*****
0.925	*****	-0.6519	-0.6691	-0.6148	-0.6409	*****	*****	*****	*****	*****
0.950	-0.2492	-0.6559	-0.6499	-0.5957	-0.4847	*****	*****	*****	*****	*****
0.975	*****	-0.6358	-0.6321	-0.5881	-0.4124	*****	*****	*****	*****	*****
-0.200	0.1115	0.1130	0.1715	*****	-0.4607	*****	*****	*****	*****	*****
-0.400	0.0976	0.1171	0.1364	-0.0181	-0.6464	*****	*****	*****	*****	*****
-0.600	*****	0.1201	0.1256	0.0120	-0.6906	*****	*****	*****	*****	*****
-0.700	*****	0.1118	0.1246	0.0238	-0.6850	*****	*****	*****	*****	*****
-0.800	0.1772	0.1267	0.1170	0.0441	-0.6305	*****	*****	*****	*****	*****
-0.850	0.1902	0.1403	0.1292	0.0459	-0.6232	*****	*****	*****	*****	*****
-0.900	0.2133	0.1877	0.1593	0.0703	-0.6394	*****	*****	*****	*****	*****
-0.950	*****	*****	0.2036	0.1313	-0.1921	*****	*****	*****	*****	*****
-0.975	*****	0.2122	0.2002	0.1563	-0.0330	*****	*****	*****	*****	*****

Sharp Radius L.E.
 Run No. = 83, Point No. = 1793
 $C_N = 0.283$, $C_m = -0.0621$
 $\alpha = 6.3^\circ$, $M_\infty = 0.848$
 $R_{mac} = 11.9 \times 10^6$

Surface Pressures Near Leading Edge

● / ◆ upper, starboard/port
 ○ / ◇ lower, starboard/port

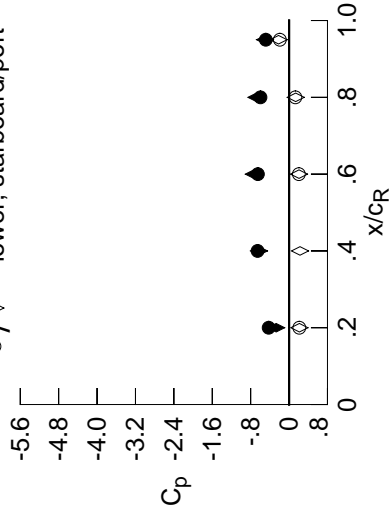

x/c_R	η	starb'd	port	starb'd	port
		$C_{p,u}$	$C_{p,l}$	$C_{p,u}$	$C_{p,l}$
0.20	0.90	-0.4249	-0.2691	0.2150	0.2133
0.40	0.95	-0.6559	-0.6264	0.2279	*****
0.60	0.95	-0.6499	-0.7341	0.2071	0.2036
0.80	0.95	-0.5957	-0.6802	0.1388	0.1313
0.95	0.95	-0.4847	-0.5011	-0.2190	-0.1921

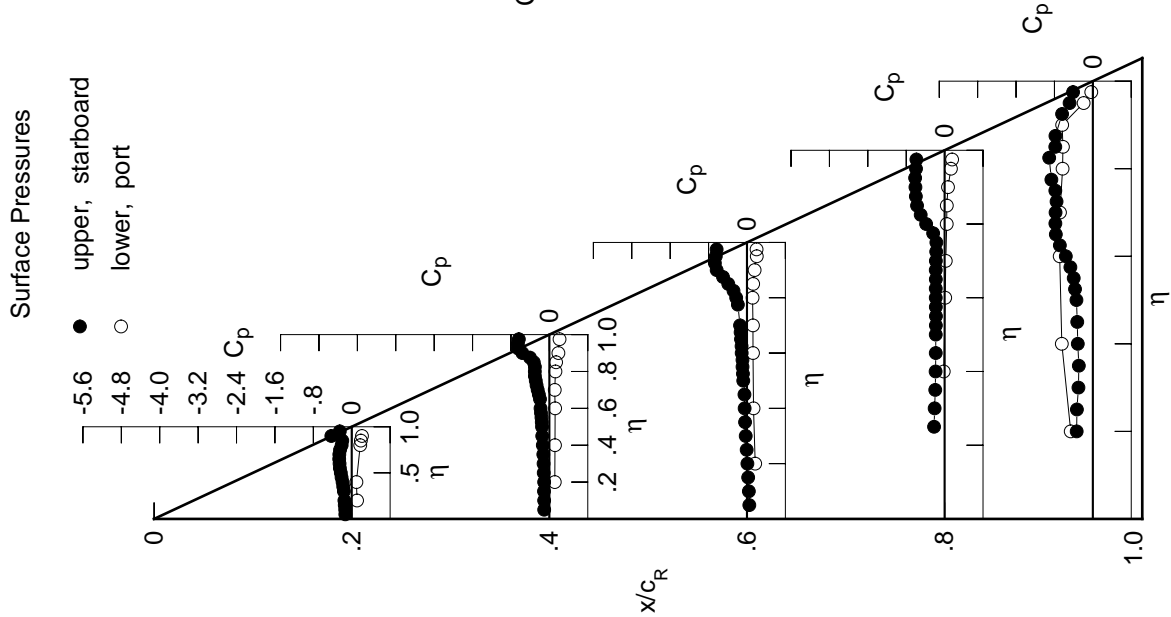

Table C2. Continued.

η	$x/c_R = .2$		$x/c_R = .4$		$x/c_R = .6$		$x/c_R = .8$		$x/c_R = .95$	
	$C_{p,u}$	$C_{p,l}$	$C_{p,u}$	$C_{p,l}$	$C_{p,u}$	$C_{p,l}$	$C_{p,u}$	$C_{p,l}$	$C_{p,u}$	$C_{p,l}$
0.050	-0.1517	-0.1271	0.0313	0.0313	0.0313	0.0313	0.0313	0.0313	0.0313	0.0313
0.100	-0.1558	-0.1303	0.0213	0.0213	0.0213	0.0213	0.0213	0.0213	0.0213	0.0213
0.150	-0.1652	-0.1317	0.0089	0.0089	0.0089	0.0089	0.0089	0.0089	0.0089	0.0089
0.200	-0.1723	-0.1305	-0.0082	-0.0082	-0.0082	-0.0082	-0.0082	-0.0082	-0.0082	-0.0082
0.250	*****	-0.1379	-0.0244	-0.2415	-0.2415	-0.2415	-0.2415	-0.2415	-0.2415	-0.2415
0.300	-0.1843	-0.1432	-0.0487	-0.2300	-0.2300	-0.2300	-0.2300	-0.2300	-0.2300	-0.2300
0.350	-0.1980	-0.1491	-0.0586	-0.2162	-0.2162	-0.2162	-0.2162	-0.2162	-0.2162	-0.2162
0.400	-0.2123	-0.1627	-0.0681	-0.2071	-0.2071	-0.2071	-0.2071	-0.2071	-0.2071	-0.2071
0.450	-0.2343	-0.1753	-0.0705	-0.2018	-0.2018	-0.2018	-0.2018	-0.2018	-0.2018	-0.2018
0.500	-0.2519	-0.1777	-0.0941	-0.1971	-0.1971	-0.1971	-0.1971	-0.1971	-0.1971	-0.1971
0.525	*****	-0.1826	-0.1003	-0.1940	-0.1940	-0.1940	-0.1940	-0.1940	-0.1940	-0.1940
0.550	-0.2727	-0.1884	-0.1065	-0.1910	-0.1910	-0.1910	-0.1910	-0.1910	-0.1910	-0.1910
0.575	*****	-0.1992	-0.1060	-0.1912	-0.1912	-0.1912	-0.1912	-0.1912	-0.1912	-0.1912
0.600	-0.2802	-0.2097	-0.1211	-0.1898	-0.1898	-0.1898	-0.1898	-0.1898	-0.1898	-0.1898
0.625	*****	*****	-0.1208	-0.1847	-0.1847	-0.1847	-0.1847	-0.1847	-0.1847	-0.1847
0.650	-0.2861	-0.2184	-0.1320	-0.1771	-0.1771	-0.1771	-0.1771	-0.1771	-0.1771	-0.1771
0.675	*****	-0.2422	-0.1329	-0.1644	-0.1644	-0.1644	-0.1644	-0.1644	-0.1644	-0.1644
0.700	-0.2784	-0.2656	-0.1285	-0.1409	-0.1409	-0.1409	-0.1409	-0.1409	-0.1409	-0.1409
0.725	*****	-0.2821	*****	-0.1287	-0.1287	-0.1287	-0.1287	-0.1287	-0.1287	-0.1287
0.750	-0.2466	-0.2903	*****	-0.3038	-0.3038	-0.3038	-0.3038	-0.3038	-0.3038	-0.3038
0.775	*****	-0.2995	-0.2960	-0.6268	-1.0353	-1.0353	-1.0353	-1.0353	-1.0353	-1.0353
0.800	-0.2290	-0.3290	-0.5296	-0.7610	*****	*****	*****	*****	*****	*****
0.825	*****	-0.4404	-0.6593	-0.7777	-0.8702	-0.8702	-0.8702	-0.8702	-0.8702	-0.8702
0.850	-0.4185	-0.5742	-0.7169	-0.7448	-0.8020	-0.8020	-0.8020	-0.8020	-0.8020	-0.8020
0.875	*****	-0.6878	-0.6793	-0.6814	-0.6863	-0.6863	-0.6863	-0.6863	-0.6863	-0.6863
0.900	-0.5339	-0.7546	-0.7107	-0.6215	*****	*****	*****	*****	*****	*****
0.925	*****	-0.7556	-0.6842	-0.5983	-0.6461	-0.6461	-0.6461	-0.6461	-0.6461	-0.6461
0.950	-0.4093	-0.7346	-0.6589	-0.5808	-0.5741	-0.5741	-0.5741	-0.5741	-0.5741	-0.5741
0.975	*****	-0.7259	-0.6489	-0.5788	-0.4883	-0.4883	-0.4883	-0.4883	-0.4883	-0.4883
-0.200	0.1361	0.1348	0.1879	*****	*****	*****	*****	*****	*****	*****
-0.400	0.1240	0.1407	0.1540	-0.0024	-0.6658	-0.6658	-0.6658	-0.6658	-0.6658	-0.6658
-0.600	*****	0.1450	0.1464	0.0278	-0.6845	-0.6845	-0.6845	-0.6845	-0.6845	-0.6845
-0.700	*****	0.1395	0.1459	0.0431	-0.6723	-0.6723	-0.6723	-0.6723	-0.6723	-0.6723
-0.800	0.2017	0.1570	0.1421	0.0635	-0.6141	-0.6141	-0.6141	-0.6141	-0.6141	-0.6141
-0.850	0.2144	0.1673	0.1566	0.0676	-0.6045	-0.6045	-0.6045	-0.6045	-0.6045	-0.6045
-0.900	0.2314	0.2124	0.1853	0.0930	-0.6098	-0.6098	-0.6098	-0.6098	-0.6098	-0.6098
-0.950	*****	*****	0.2187	0.1468	-0.1797	-0.1797	-0.1797	-0.1797	-0.1797	-0.1797
-0.975	*****	0.2108	0.2028	0.1603	-0.0280	-0.0280	-0.0280	-0.0280	-0.0280	-0.0280

Sharp Radius L.E.
 Run No. = 83, Point No. = 1794
 $C_N = 0.342$, $C_m = -0.0750$
 $\alpha = 7.4^\circ$, $M_\infty = 0.849$
 $R_{mac} = 11.9 \times 10^6$

Surface Pressures Near Leading Edge

● / ◆ upper, starboard/port
 ○ / ◇ lower, starboard/port

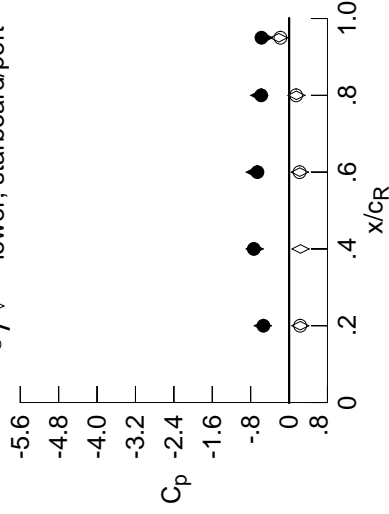

x/c_R	η	starb'd	port	starb'd	port
		$C_{p,u}$	$C_{p,l}$	$C_{p,u}$	$C_{p,l}$
0.20	0.90	-0.5339	-0.5481	0.2332	0.2314
0.40	0.95	-0.7346	-0.7183	0.2382	*****
0.60	0.95	-0.6589	-0.7155	0.2225	0.2187
0.80	0.95	-0.5808	-0.6227	0.1528	0.1468
0.95	0.95	-0.5741	-0.5228	-0.2116	-0.1797

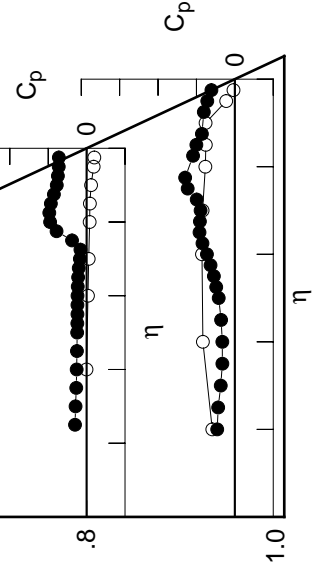

Table C2. Continued.

η	$x/c_R = .2$		$x/c_R = .4$		$x/c_R = .6$		$x/c_R = .8$		$x/c_R = .95$	
	$C_{p,u}$	$C_{p,l}$	$C_{p,u}$	$C_{p,l}$	$C_{p,u}$	$C_{p,l}$	$C_{p,u}$	$C_{p,l}$	$C_{p,u}$	$C_{p,l}$
0.050	-0.1723	-0.1520	0.0126	*****	*****	*****	*****	*****	*****	*****
0.100	-0.1769	-0.1537	0.0034	*****	*****	*****	*****	*****	*****	*****
0.150	-0.1869	-0.1564	-0.0122	*****	*****	*****	*****	*****	*****	*****
0.200	-0.1935	-0.1555	-0.0278	*****	*****	*****	*****	*****	*****	*****
0.250	*****	-0.1637	-0.0445	-0.2620	-0.3495	*****	*****	*****	*****	*****
0.300	-0.2053	-0.1674	-0.0727	-0.2547	-0.2518	*****	*****	*****	*****	*****
0.350	-0.2204	-0.1738	-0.0829	-0.2334	-0.2238	*****	*****	*****	*****	*****
0.400	-0.2358	-0.1901	-0.0873	-0.2234	-0.2355	*****	*****	*****	*****	*****
0.450	-0.2589	-0.2085	-0.0891	-0.2151	-0.2851	*****	*****	*****	*****	*****
0.500	-0.2775	-0.2089	-0.1107	-0.2112	-0.3806	*****	*****	*****	*****	*****
0.525	*****	-0.2107	-0.1159	-0.2072	-0.4890	*****	*****	*****	*****	*****
0.550	-0.2989	-0.2117	-0.1220	-0.2014	-0.6028	*****	*****	*****	*****	*****
0.575	*****	-0.2192	-0.1201	-0.1986	-0.7098	*****	*****	*****	*****	*****
0.600	-0.3039	-0.2326	-0.1309	-0.1928	-0.7495	*****	*****	*****	*****	*****
0.625	*****	*****	-0.1243	-0.1804	-0.7464	*****	*****	*****	*****	*****
0.650	-0.3043	-0.2377	-0.1233	-0.1643	-0.7261	*****	*****	*****	*****	*****
0.675	*****	-0.2528	-0.1096	-0.1524	-0.7109	*****	*****	*****	*****	*****
0.700	-0.2775	-0.2697	-0.0818	-0.1818	-0.7936	*****	*****	*****	*****	*****
0.725	*****	-0.2778	*****	-0.3780	-0.9387	*****	*****	*****	*****	*****
0.750	-0.2540	-0.3005	*****	-0.6938	-1.0289	*****	*****	*****	*****	*****
0.775	*****	-0.4149	-0.7639	-0.8708	-1.0088	*****	*****	*****	*****	*****
0.800	-0.4351	-0.5826	-0.8704	-0.9060	*****	*****	*****	*****	*****	*****
0.825	*****	-0.7247	-0.8719	-0.9045	-0.6856	*****	*****	*****	*****	*****
0.850	-0.6286	-0.8053	-0.8377	-0.8106	-0.6717	*****	*****	*****	*****	*****
0.875	*****	-0.8505	-0.7316	-0.6908	-0.6070	*****	*****	*****	*****	*****
0.900	-0.6040	-0.8525	-0.7288	-0.6518	*****	*****	*****	*****	*****	*****
0.925	*****	-0.8276	-0.6955	-0.6141	-0.6110	*****	*****	*****	*****	*****
0.950	-0.5809	-0.8096	-0.6753	-0.5974	-0.5616	*****	*****	*****	*****	*****
0.975	*****	-0.8039	-0.6659	-0.5919	-0.5013	*****	*****	*****	*****	*****
-0.200	0.1629	0.1569	0.2062	*****	-0.4760	*****	*****	*****	*****	*****
-0.400	0.1530	0.1643	0.1734	0.0100	-0.6902	*****	*****	*****	*****	*****
-0.600	*****	0.1699	0.1649	0.0444	-0.6850	*****	*****	*****	*****	*****
-0.700	*****	0.1672	0.1671	0.0565	-0.6695	*****	*****	*****	*****	*****
-0.800	0.2229	0.1858	0.1660	0.0818	-0.6041	*****	*****	*****	*****	*****
-0.850	0.2369	0.1940	0.1818	0.0863	-0.5942	*****	*****	*****	*****	*****
-0.900	0.2475	0.2343	0.2085	0.1123	-0.5903	*****	*****	*****	*****	*****
-0.950	*****	*****	0.2313	0.1589	-0.1713	*****	*****	*****	*****	*****
-0.975	*****	0.2063	0.2047	0.1615	-0.0257	*****	*****	*****	*****	*****

Sharp Radius L.E.
 Run No. = 83, Point No. = 1795
 $C_N = 0.396$, $C_m = -0.0824$
 $\alpha = 8.4^\circ$, $M_\infty = 0.849$
 $R_{mac} = 11.9 \times 10^6$

Surface Pressures Near Leading Edge

● / ◆ upper, starboard/port
 ○ / ◇ lower, starboard/port

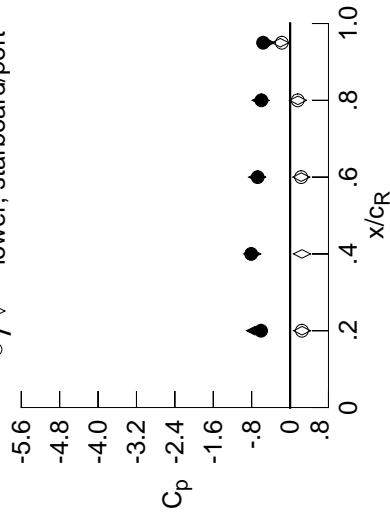

x/c_R	η	starb'd	port	starb'd	port
		$C_{p,u}$	$C_{p,l}$	$C_{p,u}$	$C_{p,l}$
0.20	0.90	-0.6040	-0.7308	0.2507	0.2475
0.40	0.95	-0.8096	-0.7890	0.2482	*****
0.60	0.95	-0.6753	-0.6866	0.2327	0.2313
0.80	0.95	-0.5974	-0.6134	0.1639	0.1589
0.95	0.95	-0.5616	-0.5034	-0.2032	-0.1713

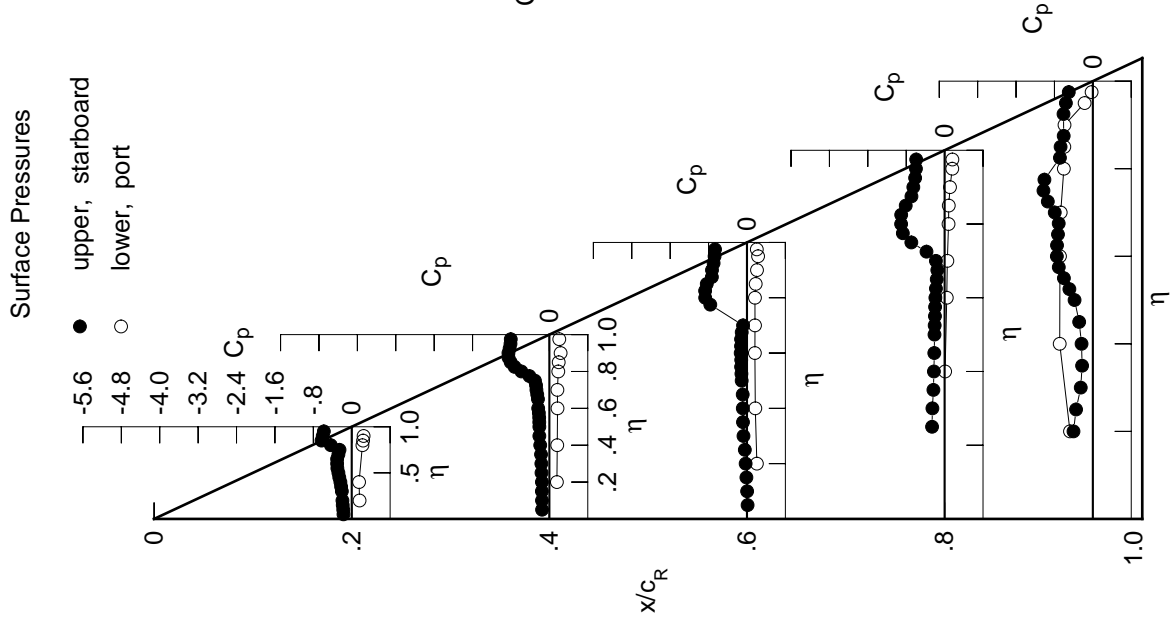

Table C2. Continued.

η	$x/c_R = .2$		$x/c_R = .4$		$x/c_R = .6$		$x/c_R = .8$		$x/c_R = .95$	
	$C_{p,u}$	$C_{p,l}$	$C_{p,u}$	$C_{p,l}$	$C_{p,u}$	$C_{p,l}$	$C_{p,u}$	$C_{p,l}$	$C_{p,u}$	$C_{p,l}$
0.050	-0.1925	-0.1774	-0.0090	*****	*****	*****	*****	*****	*****	*****
0.100	-0.1975	-0.1790	-0.0171	*****	*****	*****	*****	*****	*****	*****
0.150	-0.2082	-0.1824	-0.0320	*****	*****	*****	*****	*****	*****	*****
0.200	-0.2140	-0.1819	-0.0481	*****	*****	*****	*****	*****	*****	*****
0.250	*****	-0.1895	-0.0633	-0.2801	-0.3209	*****	*****	*****	*****	*****
0.300	-0.2275	-0.1933	-0.0908	-0.2711	-0.2258	*****	*****	*****	*****	*****
0.350	-0.2433	-0.1980	-0.1047	-0.2482	-0.2289	*****	*****	*****	*****	*****
0.400	-0.2589	-0.2082	-0.1067	-0.2356	-0.2619	*****	*****	*****	*****	*****
0.450	-0.2825	-0.2498	-0.1042	-0.2271	-0.3547	*****	*****	*****	*****	*****
0.500	-0.3018	-0.2356	-0.1279	-0.2201	-0.5638	*****	*****	*****	*****	*****
0.525	*****	-0.2379	-0.1315	-0.2142	-0.6920	*****	*****	*****	*****	*****
0.550	-0.3204	-0.2366	-0.1329	-0.2062	-0.7251	*****	*****	*****	*****	*****
0.575	*****	-0.2398	-0.1259	-0.1988	-0.7305	*****	*****	*****	*****	*****
0.600	-0.3174	-0.2425	-0.1304	-0.1907	-0.7133	*****	*****	*****	*****	*****
0.625	*****	*****	-0.1159	-0.1798	-0.6998	*****	*****	*****	*****	*****
0.650	-0.3000	-0.2330	-0.1031	-0.1855	-0.7223	*****	*****	*****	*****	*****
0.675	*****	-0.2378	-0.1035	-0.2564	-0.7993	*****	*****	*****	*****	*****
0.700	-0.2677	-0.2753	-0.2094	-0.4566	-0.9398	*****	*****	*****	*****	*****
0.725	*****	-0.3827	*****	-0.7372	-1.0438	*****	*****	*****	*****	*****
0.750	-0.4439	-0.5812	*****	-0.9327	-0.9866	*****	*****	*****	*****	*****
0.775	*****	-0.7741	-0.9903	-1.0157	-0.6828	*****	*****	*****	*****	*****
0.800	-0.6777	-0.8660	-1.0153	-0.9534	*****	*****	*****	*****	*****	*****
0.825	*****	-0.9077	-0.9697	-0.7901	-0.5790	*****	*****	*****	*****	*****
0.850	-0.7573	-0.9213	-0.9027	-0.7246	-0.5920	*****	*****	*****	*****	*****
0.875	*****	-0.9178	-0.7583	-0.7183	-0.5650	*****	*****	*****	*****	*****
0.900	-0.6813	-0.8978	-0.7403	-0.6705	*****	*****	*****	*****	*****	*****
0.925	*****	-0.8755	-0.7136	-0.6407	-0.5500	*****	*****	*****	*****	*****
0.950	-0.7300	-0.8610	-0.6849	-0.6484	-0.4864	*****	*****	*****	*****	*****
0.975	*****	-0.8571	-0.6715	-0.6412	-0.4195	*****	*****	*****	*****	*****

η	$x/c_R = .2$		$x/c_R = .4$		$x/c_R = .6$		$x/c_R = .8$		$x/c_R = .95$	
	$C_{p,u}$	$C_{p,l}$	$C_{p,u}$	$C_{p,l}$	$C_{p,u}$	$C_{p,l}$	$C_{p,u}$	$C_{p,l}$	$C_{p,u}$	$C_{p,l}$
-0.200	0.1910	0.1808	0.2225	*****	*****	*****	*****	*****	*****	*****
-0.400	0.1817	0.1871	0.1919	0.0260	-0.6916	*****	*****	*****	*****	*****
-0.600	*****	0.1959	0.1845	0.0596	-0.6823	*****	*****	*****	*****	*****
-0.700	*****	0.1941	0.1884	0.0736	-0.6598	*****	*****	*****	*****	*****
-0.800	0.2491	0.2134	0.1886	0.0986	-0.5921	*****	*****	*****	*****	*****
-0.850	0.2588	0.2186	0.2045	0.1046	-0.5798	*****	*****	*****	*****	*****
-0.900	0.2642	0.2546	0.2287	0.1302	-0.5679	*****	*****	*****	*****	*****
-0.950	*****	*****	0.2410	0.1690	-0.1640	*****	*****	*****	*****	*****
-0.975	*****	0.2012	0.2026	0.1593	-0.0269	*****	*****	*****	*****	*****

Sharp Radius L.E.
 Run No. = 83, Point No. = 1796
 $C_N = 0.451$, $C_m = -0.0901$
 $\alpha = 9.5^\circ$, $M_\infty = 0.848$
 $R_{mac} = 11.9 \times 10^6$

Surface Pressures Near Leading Edge

● / ◆ upper, starboard/port
 ○ / ◇ lower, starboard/port

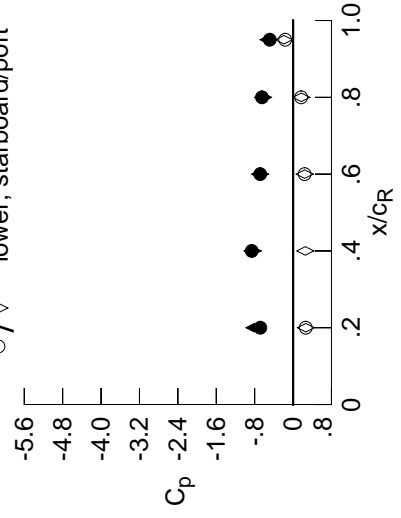

x/c_R	η	starb'd	port	starb'd	port
x/c_R	η	$C_{p,u}$	$C_{p,l}$	$C_{p,u}$	$C_{p,l}$
0.20	0.90	-0.6813	-0.8055	0.2670	0.2642
0.40	0.95	-0.8610	-0.8433	0.2555	*****
0.60	0.95	-0.6849	-0.6859	0.2424	0.2410
0.80	0.95	-0.6484	-0.6260	0.1724	0.1690
0.95	0.95	-0.4864	-0.5115	-0.1908	-0.1640

Table C2. Continued.

η	$x/c_R = .2$		$x/c_R = .4$		$x/c_R = .6$		$x/c_R = .8$		$x/c_R = .95$	
	$C_{p,u}$	$C_{p,l}$	$C_{p,u}$	$C_{p,l}$	$C_{p,u}$	$C_{p,l}$	$C_{p,u}$	$C_{p,l}$	$C_{p,u}$	$C_{p,l}$
0.050	-0.2154	-0.2044	-0.0288	*****	*****	*****	*****	*****	*****	*****
0.100	-0.2201	-0.2079	-0.0374	*****	*****	*****	*****	*****	*****	*****
0.150	-0.2305	-0.2111	-0.0514	*****	*****	*****	*****	*****	*****	*****
0.200	-0.2372	-0.2095	-0.0674	*****	*****	*****	*****	*****	*****	*****
0.250	*****	-0.2165	-0.0801	-0.2962	-0.2891	*****	*****	*****	*****	*****
0.300	-0.2503	-0.2175	-0.0990	-0.2836	-0.2866	*****	*****	*****	*****	*****
0.350	-0.2666	-0.2216	-0.1255	-0.2658	-0.2896	*****	*****	*****	*****	*****
0.400	-0.2824	-0.2227	-0.1266	-0.2522	-0.3422	*****	*****	*****	*****	*****
0.450	-0.3058	-0.2633	-0.1222	-0.2428	-0.5062	*****	*****	*****	*****	*****
0.500	-0.3213	-0.2731	-0.1407	-0.2313	-0.6905	*****	*****	*****	*****	*****
0.525	*****	-0.2729	-0.1398	-0.2245	-0.7186	*****	*****	*****	*****	*****
0.550	-0.3328	-0.2676	-0.1373	-0.2150	-0.7112	*****	*****	*****	*****	*****
0.575	*****	-0.2603	-0.1241	-0.2124	-0.7137	*****	*****	*****	*****	*****
0.600	-0.3075	-0.2490	-0.1271	-0.2168	-0.7218	*****	*****	*****	*****	*****
0.625	*****	*****	-0.1197	-0.2434	-0.7705	*****	*****	*****	*****	*****
0.650	-0.2698	-0.2114	-0.1677	-0.3333	-0.8670	*****	*****	*****	*****	*****
0.675	*****	-0.2705	-0.3495	-0.5274	-0.9737	*****	*****	*****	*****	*****
0.700	-0.4258	-0.5540	-0.6857	-0.7772	-1.0617	*****	*****	*****	*****	*****
0.725	*****	-0.8355	*****	-0.9888	-0.9263	*****	*****	*****	*****	*****
0.750	-0.7315	-0.9643	*****	-1.1016	-0.6424	*****	*****	*****	*****	*****
0.775	*****	-1.0144	-1.0956	-0.9383	-0.5726	*****	*****	*****	*****	*****
0.800	-0.8359	-1.0207	-1.0924	-0.7482	*****	*****	*****	*****	*****	*****
0.825	*****	-0.9988	-1.0225	-0.7057	-0.5424	*****	*****	*****	*****	*****
0.850	-0.8428	-0.9871	-0.8921	-0.7159	-0.5389	*****	*****	*****	*****	*****
0.875	*****	-0.9572	-0.7699	-0.7154	-0.5229	*****	*****	*****	*****	*****
0.900	-0.7597	-0.9283	-0.7783	-0.6837	*****	*****	*****	*****	*****	*****
0.925	*****	-0.9041	-0.7401	-0.7028	-0.4776	*****	*****	*****	*****	*****
0.950	-0.8390	-0.8934	-0.7010	-0.7104	-0.4110	*****	*****	*****	*****	*****
0.975	*****	-0.8856	-0.6848	-0.6972	-0.3630	*****	*****	*****	*****	*****
-0.200	0.2201	0.2054	0.2407	*****	-0.5429	*****	*****	*****	*****	*****
-0.400	0.2125	0.2127	0.2101	0.0407	-0.6892	*****	*****	*****	*****	*****
-0.600	*****	0.2213	0.2046	0.0744	-0.6754	*****	*****	*****	*****	*****
-0.700	*****	0.2223	0.2083	0.0897	-0.6507	*****	*****	*****	*****	*****
-0.800	0.2746	0.2412	0.2104	0.1142	-0.5806	*****	*****	*****	*****	*****
-0.850	0.2809	0.2426	0.2261	0.1222	-0.5664	*****	*****	*****	*****	*****
-0.900	0.2806	0.2735	0.2463	0.1464	-0.5456	*****	*****	*****	*****	*****
-0.950	*****	*****	0.2475	0.1756	-0.1530	*****	*****	*****	*****	*****
-0.975	*****	0.1961	0.1976	0.1541	-0.0226	*****	*****	*****	*****	*****

Sharp Radius L.E.
 Run No. = 83, Point No. = 1797
 $C_N = 0.504$, $C_m = -0.0963$
 $\alpha = 10.5^\circ$, $M_\infty = 0.848$
 $R_{mac} = 11.8 \times 10^6$

Surface Pressures Near Leading Edge

● / ◆ upper, starboard/port
 ○ / ◇ lower, starboard/port

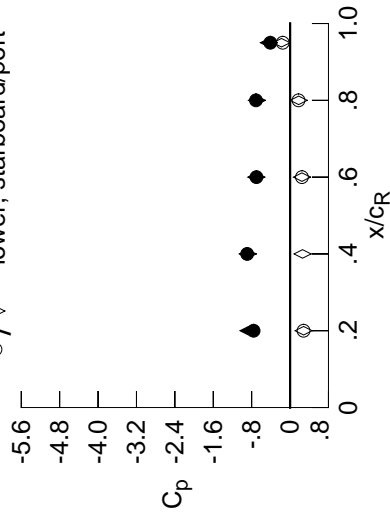

x/c_R	η	starb'd	port	starb'd	port
		$C_{p,u}$	$C_{p,l}$	$C_{p,u}$	$C_{p,l}$
0.20	0.90	-0.7597	-0.8666	0.2821	0.2806
0.40	0.95	-0.8934	-0.8819	0.2601	*****
0.60	0.95	-0.7010	-0.7038	0.2481	0.2475
0.80	0.95	-0.7104	-0.6905	0.1795	0.1756
0.95	0.95	-0.4110	-0.4419	-0.1785	-0.1530

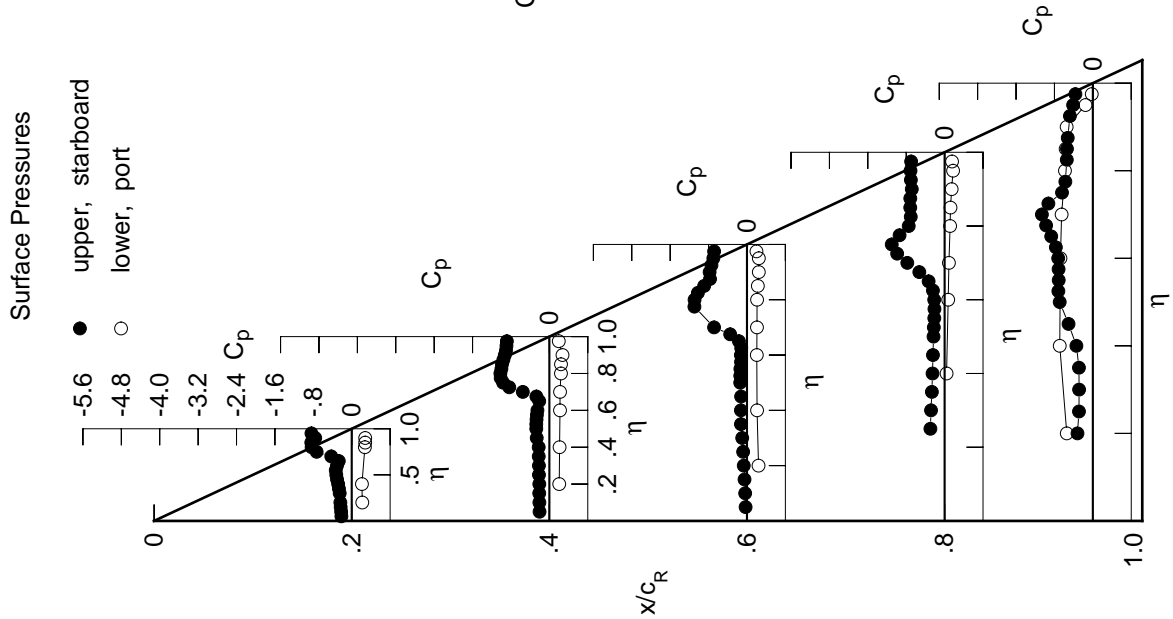

Table C2. Continued.

η	$x/c_R = .2$		$x/c_R = .4$		$x/c_R = .6$		$x/c_R = .8$		$x/c_R = .95$	
	$C_{p,u}$	$C_{p,l}$	$C_{p,u}$	$C_{p,l}$	$C_{p,u}$	$C_{p,l}$	$C_{p,u}$	$C_{p,l}$	$C_{p,u}$	$C_{p,l}$
0.050	-0.2384	-0.2347	-0.0481	*****	*****	*****	*****	*****	*****	*****
0.100	-0.2433	-0.2384	-0.0569	*****	*****	*****	*****	*****	*****	*****
0.150	-0.2534	-0.2414	-0.0710	*****	*****	*****	*****	*****	*****	*****
0.200	-0.2610	-0.2403	-0.0846	*****	*****	*****	*****	*****	*****	*****
0.250	*****	-0.2461	-0.0968	-0.3185	-0.2224	*****	*****	*****	*****	*****
0.300	-0.2723	-0.2461	-0.1101	-0.3004	-0.3204	*****	*****	*****	*****	*****
0.350	-0.2893	-0.2479	-0.1338	-0.2877	-0.3980	*****	*****	*****	*****	*****
0.400	-0.3048	-0.2434	-0.1442	-0.2730	-0.5579	*****	*****	*****	*****	*****
0.450	-0.3253	-0.2625	-0.1357	-0.2642	-0.7196	*****	*****	*****	*****	*****
0.500	-0.3347	-0.2897	-0.1495	-0.2517	-0.7196	*****	*****	*****	*****	*****
0.525	*****	-0.2913	-0.1460	-0.2495	-0.7199	*****	*****	*****	*****	*****
0.550	-0.3335	-0.2847	-0.1441	-0.2501	-0.7224	*****	*****	*****	*****	*****
0.575	*****	-0.2767	-0.1365	-0.2689	-0.7554	*****	*****	*****	*****	*****
0.600	-0.2766	-0.2661	-0.1734	-0.3164	-0.8137	*****	*****	*****	*****	*****
0.625	*****	*****	-0.2408	-0.4135	-0.9148	*****	*****	*****	*****	*****
0.650	-0.3057	-0.4429	-0.4549	-0.5851	-1.0316	*****	*****	*****	*****	*****
0.675	*****	-0.7507	-0.7619	-0.8066	-1.1120	*****	*****	*****	*****	*****
0.700	-0.7243	-0.9872	-1.0216	-1.0120	-0.9189	*****	*****	*****	*****	*****
0.725	*****	-1.0892	*****	-1.1310	-0.6421	*****	*****	*****	*****	*****
0.750	-0.9193	-1.1107	*****	-0.8630	-0.5671	*****	*****	*****	*****	*****
0.775	*****	-1.1012	-1.1758	-0.7559	-0.5304	*****	*****	*****	*****	*****
0.800	-0.9370	-1.0752	-1.0920	-0.7461	*****	*****	*****	*****	*****	*****
0.825	*****	-1.0406	-0.9207	-0.7481	-0.5129	*****	*****	*****	*****	*****
0.850	-0.9159	-1.0077	-0.8612	-0.7587	-0.5036	*****	*****	*****	*****	*****
0.875	*****	-0.9666	-0.7982	-0.7376	-0.4838	*****	*****	*****	*****	*****
0.900	-0.8335	-0.9375	-0.8234	-0.7358	*****	*****	*****	*****	*****	*****
0.925	*****	-0.9171	-0.7629	-0.7564	-0.4305	*****	*****	*****	*****	*****
0.950	-0.9207	-0.9063	-0.7257	-0.7522	-0.3728	*****	*****	*****	*****	*****
0.975	*****	-0.9020	-0.7117	-0.7351	-0.3395	*****	*****	*****	*****	*****
-0.200	$C_{p,l}$	0.2499	0.2291	0.2574	*****	-0.5844	*****	*****	*****	*****
-0.400	*****	0.2422	0.2362	0.2276	0.0555	-0.6841	*****	*****	*****	*****
-0.600	*****	*****	0.2451	0.2228	0.0888	-0.6669	*****	*****	*****	*****
-0.700	*****	*****	0.2470	0.2269	0.1055	-0.6416	*****	*****	*****	*****
-0.800	0.2996	0.2657	0.2294	0.1299	-0.5689	*****	*****	*****	*****	*****
-0.850	0.3013	0.2631	0.2441	0.1388	-0.5527	*****	*****	*****	*****	*****
-0.900	0.2942	0.2892	0.2605	0.1619	-0.5252	*****	*****	*****	*****	*****
-0.950	*****	*****	0.2502	0.1817	-0.1454	*****	*****	*****	*****	*****
-0.975	*****	0.1907	0.1894	0.1496	-0.0233	*****	*****	*****	*****	*****

Sharp Radius L.E.
 Run No. = 83, Point No. = 1798
 $C_N = 0.557$, $C_m = -0.1038$
 $\alpha = 11.6^\circ$, $M_\infty = 0.848$
 $R_{mac} = 11.8 \times 10^6$

Surface Pressures Near Leading Edge

● / ◆ upper, starboard/port
 ○ / ◇ lower, starboard/port

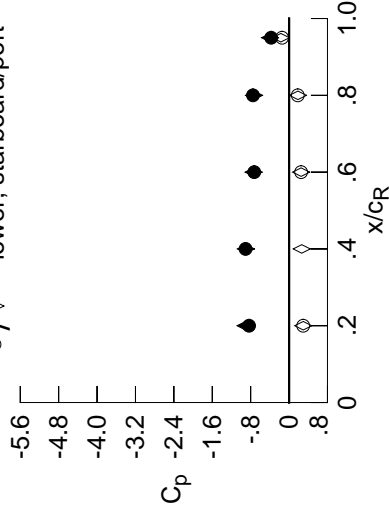

x/c_R	η	starb'd	port	starb'd	port
		$C_{p,u}$	$C_{p,l}$	$C_{p,u}$	$C_{p,l}$
0.20	0.90	-0.8335	-0.9066	0.2950	0.2942
0.40	0.95	-0.9063	-0.8992	0.2638	*****
0.60	0.95	-0.7257	-0.7401	0.2510	0.2502
0.80	0.95	-0.7522	-0.7298	0.1851	0.1817
0.95	0.95	-0.3728	-0.3970	-0.1700	-0.1454

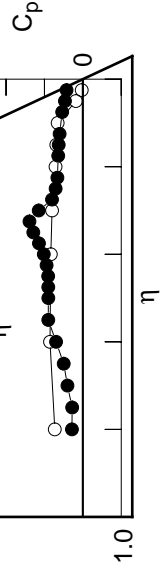

Table C2. Continued.

η	$x/c_R = .2$		$x/c_R = .4$		$x/c_R = .6$		$x/c_R = .8$		$x/c_R = .95$	
	$C_{p,u}$	$C_{p,l}$	$C_{p,u}$	$C_{p,l}$	$C_{p,u}$	$C_{p,l}$	$C_{p,u}$	$C_{p,l}$	$C_{p,u}$	$C_{p,l}$
0.050	-0.2632	-0.2707	-0.0688	*****	*****	*****	*****	*****	*****	*****
0.100	-0.2679	-0.2739	-0.0785	*****	*****	*****	*****	*****	*****	*****
0.150	-0.2777	-0.2774	-0.0902	*****	*****	*****	*****	*****	*****	*****
0.200	-0.2856	-0.2751	-0.1026	*****	*****	*****	*****	*****	*****	*****
0.250	*****	-0.2801	-0.1171	-0.3440	-0.2264	*****	*****	*****	*****	*****
0.300	-0.2960	-0.2803	-0.1302	-0.3240	-0.3110	*****	*****	*****	*****	*****
0.350	-0.3122	-0.2825	-0.1454	-0.3092	-0.4152	*****	*****	*****	*****	*****
0.400	-0.3257	-0.2767	-0.1527	-0.2965	-0.6000	*****	*****	*****	*****	*****
0.450	-0.3432	-0.2749	-0.1474	-0.2857	-0.7158	*****	*****	*****	*****	*****
0.500	-0.3434	-0.2780	-0.1614	-0.2840	-0.7163	*****	*****	*****	*****	*****
0.525	*****	-0.2881	-0.1639	-0.2893	-0.7300	*****	*****	*****	*****	*****
0.550	-0.3226	-0.2929	-0.1775	-0.3121	-0.7575	*****	*****	*****	*****	*****
0.575	*****	-0.3135	-0.2072	-0.3623	-0.8261	*****	*****	*****	*****	*****
0.600	-0.2504	-0.3887	-0.3340	-0.4576	-0.9149	*****	*****	*****	*****	*****
0.625	*****	*****	-0.5246	-0.6086	-1.0378	*****	*****	*****	*****	*****
0.650	-0.5797	-0.8820	-0.8276	-0.8030	-1.1559	*****	*****	*****	*****	*****
0.675	*****	-1.0867	-1.0819	-1.0093	-0.8776	*****	*****	*****	*****	*****
0.700	-0.9690	-1.1857	-1.2432	-1.1582	-0.6709	*****	*****	*****	*****	*****
0.725	*****	-1.2093	*****	-0.8768	-0.5708	*****	*****	*****	*****	*****
0.750	-1.0514	-1.1880	*****	-0.7885	-0.5300	*****	*****	*****	*****	*****
0.775	*****	-1.1538	-1.1397	-0.7835	-0.5091	*****	*****	*****	*****	*****
0.800	-1.0313	-1.1136	-0.9782	-0.7966	*****	*****	*****	*****	*****	*****
0.825	*****	-1.0687	-0.9059	-0.8041	-0.4971	*****	*****	*****	*****	*****
0.850	-0.9838	-1.0250	-0.8857	-0.8096	-0.4794	*****	*****	*****	*****	*****
0.875	*****	-0.9842	-0.8452	-0.7770	-0.4590	*****	*****	*****	*****	*****
0.900	-0.9044	-0.9599	-0.8675	-0.7768	*****	*****	*****	*****	*****	*****
0.925	*****	-0.9407	-0.7841	-0.7962	-0.3990	*****	*****	*****	*****	*****
0.950	-0.9886	-0.9321	-0.7523	-0.7900	-0.3518	*****	*****	*****	*****	*****
0.975	*****	-0.9263	-0.7438	-0.7749	-0.3254	*****	*****	*****	*****	*****
-0.200	$C_{p,l}$	0.2738	0.2533	0.2742	*****	*****	*****	*****	*****	*****
-0.400		0.2725	0.2595	0.2451	0.0695	-0.6778	*****	*****	*****	*****
-0.600	*****	0.2689	0.2404	0.1039	0.6598	*****	*****	*****	*****	*****
-0.700	*****	0.2723	0.2454	0.1192	-0.6308	*****	*****	*****	*****	*****
-0.800	0.3221	0.2892	0.2478	0.1457	-0.5574	*****	*****	*****	*****	*****
-0.850	0.3198	0.2827	0.2610	0.1535	-0.5379	*****	*****	*****	*****	*****
-0.900	0.3065	0.3039	0.2724	0.1744	-0.5053	*****	*****	*****	*****	*****
-0.950	*****	*****	0.2505	0.1845	-0.1379	*****	*****	*****	*****	*****
-0.975	*****	0.1823	0.1784	0.1399	-0.0245	*****	*****	*****	*****	*****

Sharp Radius L.E.

Run No. = 83, Point No. = 1799

$C_N = 0.613$, $C_m = -0.1107$

$\alpha = 12.6^\circ$, $M_\infty = 0.849$

$R_{mac} = 11.8 \times 10^6$

Surface Pressures Near Leading Edge

● / ◆ upper, starboard/port
○ / ◇ lower, starboard/port

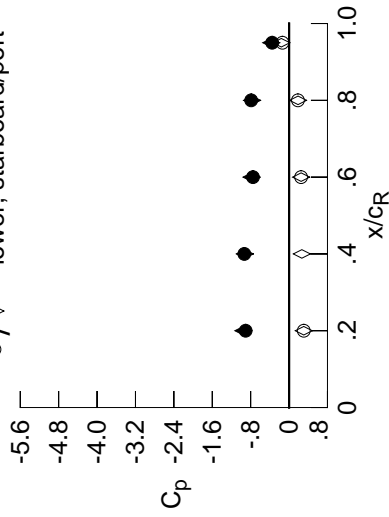

x/c_R	η	starb'd	port	$C_{p,u}$	starb'd	port	$C_{p,l}$
0.20	0.90	-0.9044	-0.9524	0.3067	0.3065	0.2660	*****
0.40	0.95	-0.9321	-0.9210	0.2508	0.2505	0.1872	0.1845
0.60	0.95	-0.7523	-0.7820	0.1614	-0.1379	0.1399	-0.0245
0.80	0.95	-0.7900	-0.7708	0.1845	0.1845	0.1379	-0.1379
0.95	0.95	-0.3518	-0.3715	-0.1614	-0.1379	0.1399	-0.0245

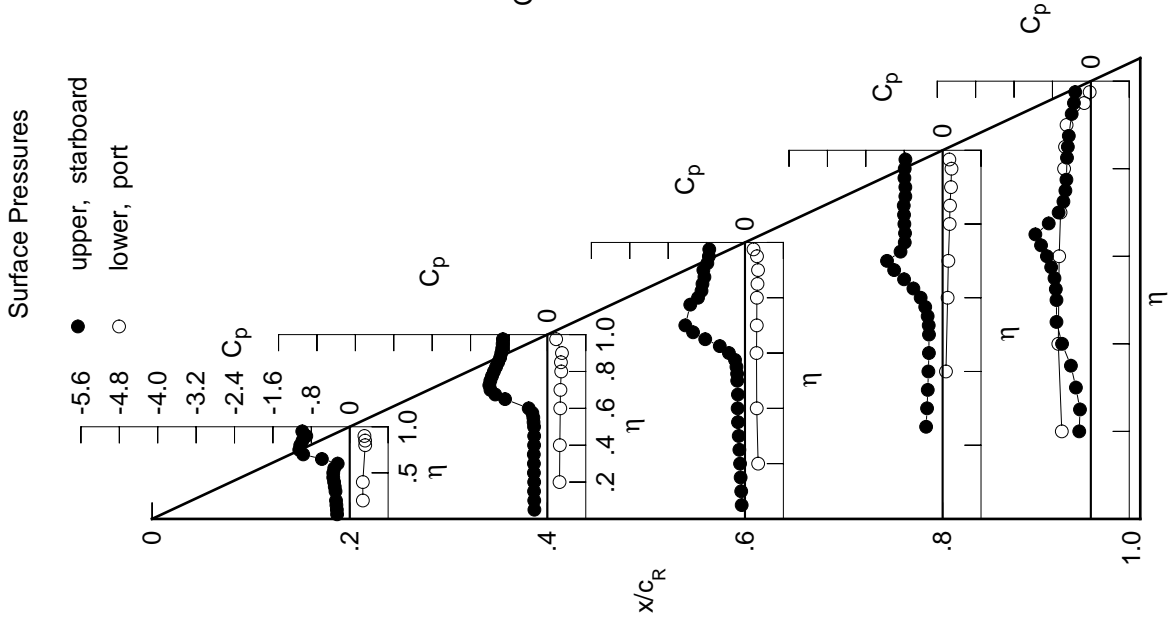

Table C2. Continued.

η	$x/c_R = .2$		$x/c_R = .4$		$x/c_R = .6$		$x/c_R = .8$		$x/c_R = .95$	
	$C_{p,u}$	$C_{p,l}$	$C_{p,u}$	$C_{p,l}$	$C_{p,u}$	$C_{p,l}$	$C_{p,u}$	$C_{p,l}$	$C_{p,u}$	$C_{p,l}$
0.050	-0.2886	-0.3080	-0.0889	*****	*****	*****	*****	*****	*****	*****
0.100	-0.2936	-0.3106	-0.0977	*****	*****	*****	*****	*****	*****	*****
0.150	-0.3045	-0.3123	-0.1093	*****	*****	*****	*****	*****	*****	*****
0.200	-0.3119	-0.3103	-0.1230	*****	*****	*****	*****	*****	*****	*****
0.250	*****	-0.3157	-0.1371	-0.3704	-0.2491	*****	*****	*****	*****	*****
0.300	-0.3228	-0.3167	-0.1515	-0.3503	-0.3204	*****	*****	*****	*****	*****
0.350	-0.3388	-0.3171	-0.1636	-0.3357	-0.4322	*****	*****	*****	*****	*****
0.400	-0.3507	-0.3146	-0.1704	-0.3224	-0.6154	*****	*****	*****	*****	*****
0.450	-0.3633	-0.3110	-0.1627	-0.3173	-0.7155	*****	*****	*****	*****	*****
0.500	-0.3507	-0.3035	-0.1914	-0.3304	-0.7341	*****	*****	*****	*****	*****
0.525	*****	-0.3118	-0.2121	-0.3555	-0.7652	*****	*****	*****	*****	*****
0.550	-0.3042	-0.3339	-0.2634	-0.4026	-0.8155	*****	*****	*****	*****	*****
0.575	*****	-0.4192	-0.3543	-0.4922	-0.9080	*****	*****	*****	*****	*****
0.600	-0.3269	-0.6115	-0.5702	-0.6247	-1.0135	*****	*****	*****	*****	*****
0.625	*****	*****	-0.8046	-0.7983	-1.1402	*****	*****	*****	*****	*****
0.650	-0.8474	-1.1295	-1.0668	-0.9866	-0.9298	*****	*****	*****	*****	*****
0.675	*****	-1.2638	-1.2483	-1.1620	-0.7055	*****	*****	*****	*****	*****
0.700	-1.1522	-1.3063	-1.3546	-0.9635	-0.5965	*****	*****	*****	*****	*****
0.725	*****	-1.2947	*****	-0.8224	-0.5314	*****	*****	*****	*****	*****
0.750	-1.1840	-1.2727	*****	-0.8065	-0.5091	*****	*****	*****	*****	*****
0.775	*****	-1.2300	-1.0491	-0.8126	-0.4968	*****	*****	*****	*****	*****
0.800	-1.1196	-1.1799	-0.9785	-0.8304	*****	*****	*****	*****	*****	*****
0.825	*****	-1.1283	-0.9476	-0.8315	-0.4795	*****	*****	*****	*****	*****
0.850	-1.0415	-1.0698	-0.9424	-0.8348	-0.4612	*****	*****	*****	*****	*****
0.875	*****	-1.0280	-0.9025	-0.8150	-0.4337	*****	*****	*****	*****	*****
0.900	-0.9668	-1.0020	-0.8941	-0.8152	*****	*****	*****	*****	*****	*****
0.925	*****	-0.9756	-0.8171	-0.8361	-0.3741	*****	*****	*****	*****	*****
0.950	-1.0425	-0.9615	-0.7972	-0.8350	-0.3385	*****	*****	*****	*****	*****
0.975	*****	-0.9544	-0.7915	-0.8193	-0.3144	*****	*****	*****	*****	*****

η	$x/c_R = .2$		$x/c_R = .4$		$x/c_R = .6$		$x/c_R = .8$		$x/c_R = .95$	
	$C_{p,u}$	$C_{p,l}$	$C_{p,u}$	$C_{p,l}$	$C_{p,u}$	$C_{p,l}$	$C_{p,u}$	$C_{p,l}$	$C_{p,u}$	$C_{p,l}$
-0.200	0.3007	0.2778	0.2926	*****	*****	*****	*****	*****	*****	*****
-0.400	0.3035	0.2841	0.2636	0.0851	-0.6721	*****	*****	*****	*****	*****
-0.600	*****	0.2937	0.2599	0.1182	-0.6507	*****	*****	*****	*****	*****
-0.700	*****	0.2971	0.2647	0.1347	-0.6228	*****	*****	*****	*****	*****
-0.800	0.3455	0.3115	0.2661	0.1600	-0.5445	*****	*****	*****	*****	*****
-0.850	0.3382	0.3015	0.2781	0.1684	-0.5238	*****	*****	*****	*****	*****
-0.900	0.3182	0.3166	0.2842	0.1861	-0.4860	*****	*****	*****	*****	*****
-0.950	*****	*****	0.2506	0.1859	-0.1302	*****	*****	*****	*****	*****
-0.975	*****	0.1737	0.1674	0.1297	-0.0248	*****	*****	*****	*****	*****

Sharp Radius L.E.
 Run No. = 83, Point No. = 1800
 $C_N = 0.667$, $C_m = -0.1168$
 $\alpha = 13.7^\circ$, $M_\infty = 0.848$
 $R_{mac} = 11.8 \times 10^6$

Surface Pressures Near Leading Edge

● / ◆ upper, starboard/port
 ○ / ◇ lower, starboard/port

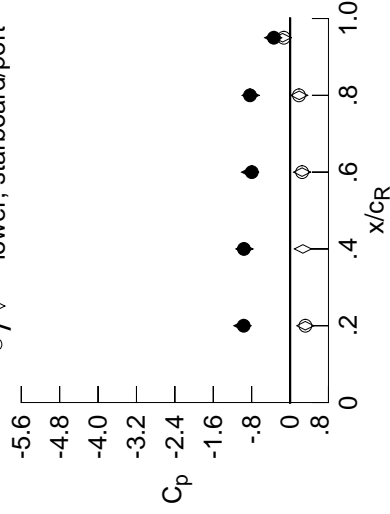

x/c_R	η	starb'd	port	starb'd	port
		$C_{p,u}$	$C_{p,l}$	$C_{p,u}$	$C_{p,l}$
0.20	0.90	-0.9668	-0.9938	0.3179	0.3182
0.40	0.95	-0.9615	-0.9517	0.2671	*****
0.60	0.95	-0.7972	-0.8326	0.2508	0.2506
0.80	0.95	-0.8350	-0.8228	0.1892	0.1859
0.95	0.95	-0.3385	-0.3523	-0.1549	-0.1302

Table C2. Continued.

η	$x/c_R = .2$		$x/c_R = .4$		$x/c_R = .6$		$x/c_R = .8$		$x/c_R = .95$	
	$C_{p,u}$	$C_{p,l}$	$C_{p,u}$	$C_{p,l}$	$C_{p,u}$	$C_{p,l}$	$C_{p,u}$	$C_{p,l}$	$C_{p,u}$	$C_{p,l}$
0.050	-0.3225	-0.3544	-0.1087	*****	*****	*****	*****	*****	*****	*****
0.100	-0.3268	-0.3572	-0.1177	*****	*****	*****	*****	*****	*****	*****
0.150	-0.3387	-0.3570	-0.1293	*****	*****	*****	*****	*****	*****	*****
0.200	-0.3485	-0.3570	-0.1438	*****	*****	*****	*****	*****	*****	*****
0.250	*****	-0.3607	-0.1564	-0.4060	-0.2853	*****	*****	*****	*****	*****
0.300	-0.3725	-0.3611	-0.1721	-0.3847	-0.3569	*****	*****	*****	*****	*****
0.350	-0.3968	-0.3606	-0.1834	-0.3717	-0.4866	*****	*****	*****	*****	*****
0.400	-0.4166	-0.3575	-0.1925	-0.3615	-0.6633	*****	*****	*****	*****	*****
0.450	-0.4332	-0.3565	-0.1926	-0.3665	-0.7384	*****	*****	*****	*****	*****
0.500	-0.4125	-0.3600	-0.2525	-0.4045	-0.7761	*****	*****	*****	*****	*****
0.525	*****	-0.3889	-0.3087	-0.4507	-0.8260	*****	*****	*****	*****	*****
0.550	-0.3654	-0.4538	-0.4132	-0.5289	-0.8945	*****	*****	*****	*****	*****
0.575	*****	-0.6059	-0.5664	-0.6486	-1.0019	*****	*****	*****	*****	*****
0.600	-0.6639	-0.8377	-0.8100	-0.7988	-1.1137	*****	*****	*****	*****	*****
0.625	*****	*****	-1.0199	-0.9701	-1.0242	*****	*****	*****	*****	*****
0.650	-1.1988	-1.2846	-1.2208	-1.1359	-0.7204	*****	*****	*****	*****	*****
0.675	*****	-1.3911	-1.3528	-1.1586	-0.6444	*****	*****	*****	*****	*****
0.700	-1.0964	-1.4231	-1.4281	-0.8800	-0.5603	*****	*****	*****	*****	*****
0.725	*****	-1.3757	*****	-0.8518	-0.5202	*****	*****	*****	*****	*****
0.750	-1.1737	-1.3572	*****	-0.8487	-0.5076	*****	*****	*****	*****	*****
0.775	*****	-1.3354	-1.0609	-0.8579	-0.4956	*****	*****	*****	*****	*****
0.800	-1.1818	-1.2522	-1.0448	-0.8798	*****	*****	*****	*****	*****	*****
0.825	*****	-1.1665	-1.0389	-0.8732	-0.4678	*****	*****	*****	*****	*****
0.850	-1.1299	-1.1056	-1.0479	-0.8686	-0.4414	*****	*****	*****	*****	*****
0.875	*****	-1.0703	-0.9595	-0.8486	-0.4176	*****	*****	*****	*****	*****
0.900	-1.0240	-1.0448	-0.9186	-0.8462	*****	*****	*****	*****	*****	*****
0.925	*****	-1.0099	-0.8549	-0.8679	-0.3653	*****	*****	*****	*****	*****
0.950	-1.0814	-0.9865	-0.8437	-0.8689	-0.3363	*****	*****	*****	*****	*****
0.975	*****	-0.9737	-0.8360	-0.8555	-0.3156	*****	*****	*****	*****	*****
-0.200	$C_{p,l}$	0.3309	0.3003	0.3107	*****	*****	*****	*****	*****	*****
-0.400	0.3356	0.3081	0.2811	0.0988	-0.6623	*****	*****	*****	*****	*****
-0.600	*****	0.3180	0.2779	0.1328	-0.6420	*****	*****	*****	*****	*****
-0.700	*****	0.3203	0.2823	0.1488	-0.6119	*****	*****	*****	*****	*****
-0.800	0.3668	0.3323	0.2833	0.1731	-0.5322	*****	*****	*****	*****	*****
-0.850	0.3549	0.3187	0.2928	0.1822	-0.5107	*****	*****	*****	*****	*****
-0.900	0.3288	0.3279	0.2947	0.1969	-0.4689	*****	*****	*****	*****	*****
-0.950	*****	*****	0.2485	0.1870	-0.1259	*****	*****	*****	*****	*****
-0.975	*****	0.1654	0.1545	0.1199	-0.0291	*****	*****	*****	*****	*****

Sharp Radius L.E.
 Run No. = 83, Point No. = 1801
 $C_N = 0.719$, $C_m = -0.1218$
 $\alpha = 14.7^\circ$, $M_\infty = 0.848$
 $R_{mac} = 11.8 \times 10^6$

Surface Pressures Near Leading Edge

● / ◆ upper, starboard/port
 ○ / ◇ lower, starboard/port

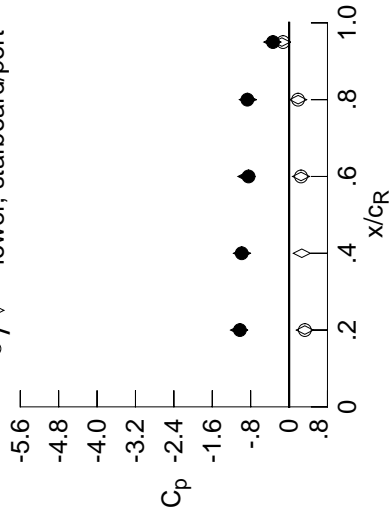

x/cR	η	$C_{p,u}$ starb'd	$C_{p,u}$ port	$C_{p,l}$ starb'd	$C_{p,l}$ port
0.20	0.90	-1.0240	-1.0416	0.3280	0.3288
0.40	0.95	-0.9865	-0.9804	0.2660	*****
0.60	0.95	-0.8437	-0.8887	0.2498	0.2485
0.80	0.95	-0.8689	-0.8584	0.1888	0.1870
0.95	0.95	-0.3363	-0.3485	-0.1504	-0.1259

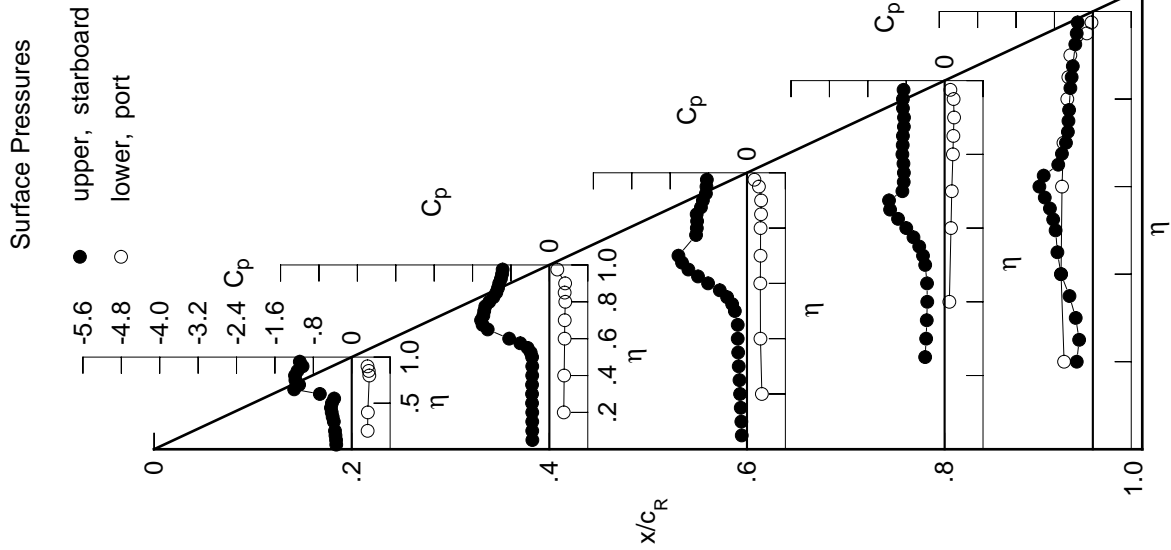

Table C2. Continued.

η	$x/c_R = .2$		$x/c_R = .4$		$x/c_R = .6$		$x/c_R = .8$		$x/c_R = .95$	
	$C_{p,u}$	$C_{p,l}$	$C_{p,u}$	$C_{p,l}$	$C_{p,u}$	$C_{p,l}$	$C_{p,u}$	$C_{p,l}$	$C_{p,u}$	$C_{p,l}$
0.050	-0.3454	-0.3892	-0.1286	*****	*****	*****	*****	*****	*****	*****
0.100	-0.3472	-0.3902	-0.1366	*****	*****	*****	*****	*****	*****	*****
0.150	-0.3590	-0.3920	-0.1490	*****	*****	*****	*****	*****	*****	*****
0.200	-0.3650	-0.3902	-0.1639	*****	*****	*****	*****	*****	*****	-0.4074
0.250	*****	-0.3950	-0.1788	-0.4358	-0.3394	*****	*****	*****	*****	*****
0.300	-0.3769	-0.3945	-0.1932	-0.4173	-0.4148	*****	*****	*****	*****	*****
0.350	-0.3910	-0.3936	-0.2081	-0.4067	-0.5551	*****	*****	*****	*****	*****
0.400	-0.3999	-0.3913	-0.2212	-0.4028	-0.7033	*****	*****	*****	*****	*****
0.450	-0.4049	-0.3952	-0.2416	-0.4220	-0.7643	*****	*****	*****	*****	*****
0.500	-0.3859	-0.4248	-0.3497	-0.4930	-0.8315	*****	*****	*****	*****	*****
0.525	*****	-0.4902	-0.4484	-0.5618	-0.8975	*****	*****	*****	*****	*****
0.550	-0.4565	-0.6053	-0.5952	-0.6633	-0.9851	*****	*****	*****	*****	*****
0.575	*****	-0.8036	-0.7738	-0.8005	-1.1000	*****	*****	*****	*****	*****
0.600	-0.9945	-1.0346	-1.0016	-0.9527	-1.1153	*****	*****	*****	*****	*****
0.625	*****	*****	-1.1758	-1.1129	-0.7098	*****	*****	*****	*****	*****
0.650	-1.3292	-1.4059	-1.3357	-1.2544	-0.6806	*****	*****	*****	*****	*****
0.675	*****	-1.4978	-1.4405	-0.9802	-0.6129	*****	*****	*****	*****	*****
0.700	-1.4122	-1.5379	-1.2232	-0.9109	-0.5572	*****	*****	*****	*****	*****
0.725	*****	-1.4777	*****	-0.9032	-0.5278	*****	*****	*****	*****	*****
0.750	-1.2611	-1.3869	*****	-0.9045	-0.5153	*****	*****	*****	*****	*****
0.775	*****	-1.3603	-1.1019	-0.9174	-0.4957	*****	*****	*****	*****	*****
0.800	-1.1925	-1.2528	-1.1153	-0.9469	*****	*****	*****	*****	*****	*****
0.825	*****	-1.1742	-1.1391	-0.9372	-0.4504	*****	*****	*****	*****	*****
0.850	-1.1448	-1.1375	-1.1534	-0.9146	-0.4265	*****	*****	*****	*****	*****
0.875	*****	-1.1113	-0.9938	-0.8747	-0.4063	*****	*****	*****	*****	*****
0.900	-1.0709	-1.0861	-0.9491	-0.8611	*****	*****	*****	*****	*****	*****
0.925	*****	-1.0420	-0.9030	-0.8802	-0.3687	*****	*****	*****	*****	*****
0.950	-1.1170	-1.0107	-0.8917	-0.8814	-0.3404	*****	*****	*****	*****	*****
0.975	*****	-0.9967	-0.8848	-0.8690	-0.3230	*****	*****	*****	*****	*****
-0.200	$C_{p,l}$	0.3608	0.3281	0.3311	*****	*****	*****	*****	*****	-0.5897
-0.400	*****	0.3587	0.3345	0.3023	0.1165	-0.6523	*****	*****	*****	*****
-0.600	*****	*****	0.3428	0.2980	0.1513	-0.6310	*****	*****	*****	*****
-0.700	*****	*****	0.3456	0.3023	0.1660	-0.6013	*****	*****	*****	*****
-0.800	0.3894	0.3545	0.3022	0.1905	-0.5193	*****	*****	*****	*****	*****
-0.850	0.3728	0.3368	0.3095	0.1976	-0.4981	*****	*****	*****	*****	*****
-0.900	0.3403	0.3396	0.3057	0.2091	-0.4523	*****	*****	*****	*****	*****
-0.950	*****	*****	0.2470	0.1890	-0.1213	*****	*****	*****	*****	*****
-0.975	*****	0.1577	0.1442	0.1128	-0.0327	*****	*****	*****	*****	*****

Sharp Radius L.E.
 Run No. = 83, Point No. = 1802
 $C_N = 0.773$, $C_m = -0.1280$
 $\alpha = 15.8^\circ$, $M_\infty = 0.847$
 $R_{mac} = 11.8 \times 10^6$

Surface Pressures Near Leading Edge

● / ◆ upper, starboard/port
 ○ / ◇ lower, starboard/port

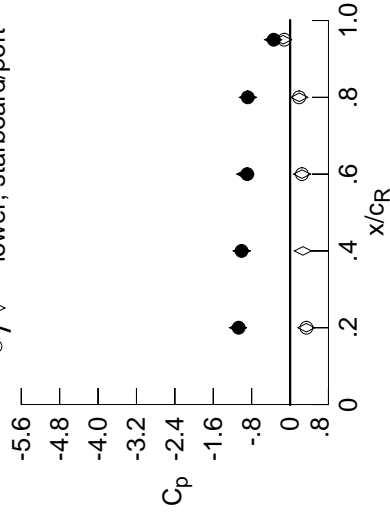

x/c_R	η	starb'd	port	starb'd	port
		$C_{p,u}$	$C_{p,l}$	$C_{p,u}$	$C_{p,l}$
0.20	0.90	-1.0709	-1.0851	0.3387	0.3403
0.40	0.95	-1.0107	-1.0087	0.2674	*****
0.60	0.95	-0.8917	-0.9342	0.2491	0.2470
0.80	0.95	-0.8814	-0.8780	0.1922	0.1890
0.95	0.95	-0.3404	-0.3526	-0.1450	-0.1213

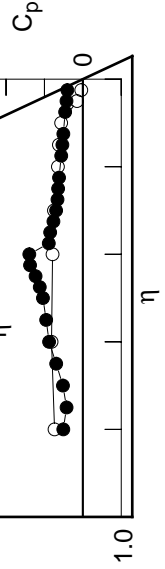

Table C2. Continued.

η	$x/c_R = .2$		$x/c_R = .4$		$x/c_R = .6$		$x/c_R = .8$		$x/c_R = .95$	
	$C_{p,u}$	$C_{p,l}$	$C_{p,u}$	$C_{p,l}$	$C_{p,u}$	$C_{p,l}$	$C_{p,u}$	$C_{p,l}$	$C_{p,u}$	$C_{p,l}$
0.050	-0.3717	-0.4134	-0.1430	*****	*****	*****	*****	*****	*****	*****
0.100	-0.3723	-0.4146	-0.1518	*****	*****	*****	*****	*****	*****	*****
0.150	-0.3819	-0.4148	-0.1653	*****	*****	*****	*****	*****	*****	*****
0.200	-0.3892	-0.4132	-0.1794	*****	*****	*****	*****	*****	*****	*****
0.250	*****	-0.4185	-0.1967	-0.4722	-0.4969	*****	*****	*****	*****	*****
0.300	-0.3897	-0.4185	-0.2118	-0.4550	-0.5709	*****	*****	*****	*****	*****
0.350	-0.3949	-0.4181	-0.2328	-0.4471	-0.6700	*****	*****	*****	*****	*****
0.400	-0.3902	-0.4212	-0.2588	-0.4534	-0.7251	*****	*****	*****	*****	*****
0.450	-0.3824	-0.4415	-0.3100	-0.4941	-0.7726	*****	*****	*****	*****	*****
0.500	-0.3760	-0.5190	-0.4755	-0.6058	-0.8650	*****	*****	*****	*****	*****
0.525	*****	-0.6280	-0.6107	-0.6984	-0.9445	*****	*****	*****	*****	*****
0.550	-0.6241	-0.7868	-0.7791	-0.8201	-1.0424	*****	*****	*****	*****	*****
0.575	*****	-0.9977	-0.9569	-0.9648	-1.1636	*****	*****	*****	*****	*****
0.600	-1.1999	-1.1977	-1.1530	-1.1080	-0.7697	*****	*****	*****	*****	*****
0.625	*****	*****	-1.2938	-1.2470	-0.6868	*****	*****	*****	*****	*****
0.650	-1.3977	-1.5041	-1.4228	-1.3027	-0.6557	*****	*****	*****	*****	*****
0.675	*****	-1.5757	-1.2160	-1.0051	-0.6105	*****	*****	*****	*****	*****
0.700	-1.5188	-1.6126	-1.1200	-0.9848	-0.5811	*****	*****	*****	*****	*****
0.725	*****	-1.4859	*****	-0.9794	-0.5567	*****	*****	*****	*****	*****
0.750	-1.3779	-1.3758	*****	-0.9814	-0.5402	*****	*****	*****	*****	*****
0.775	*****	-1.3040	-1.1122	-0.9953	-0.5059	*****	*****	*****	*****	*****
0.800	-1.2889	-1.2368	-1.1400	-1.0263	*****	*****	*****	*****	*****	*****
0.825	*****	-1.1940	-1.1884	-1.0218	-0.4511	*****	*****	*****	*****	*****
0.850	-1.1713	-1.1729	-1.1622	-0.9981	-0.4231	*****	*****	*****	*****	*****
0.875	*****	-1.1560	-0.9824	-0.9256	-0.4214	*****	*****	*****	*****	*****
0.900	-1.1149	-1.1215	-0.9881	-0.8838	*****	*****	*****	*****	*****	*****
0.925	*****	-1.0712	-0.9784	-0.9013	-0.3937	*****	*****	*****	*****	*****
0.950	-1.1449	-1.0444	-0.9619	-0.9106	-0.3601	*****	*****	*****	*****	*****
0.975	*****	-1.0317	-0.9476	-0.9017	-0.3413	*****	*****	*****	*****	*****
-0.200	0.3868	0.3494	0.3481	*****	-0.5812	*****	*****	*****	*****	*****
-0.400	0.3835	0.3569	0.3184	0.1308	-0.6404	*****	*****	*****	*****	*****
-0.600	*****	0.3641	0.3145	0.1652	-0.6208	*****	*****	*****	*****	*****
-0.700	*****	0.3671	0.3189	0.1784	-0.5885	*****	*****	*****	*****	*****
-0.800	0.4077	0.3728	0.3169	0.2036	-0.5070	*****	*****	*****	*****	*****
-0.850	0.3870	0.3512	0.3217	0.2098	-0.4848	*****	*****	*****	*****	*****
-0.900	0.3488	0.3475	0.3122	0.2173	-0.4358	*****	*****	*****	*****	*****
-0.950	*****	*****	0.2432	0.1873	-0.1181	*****	*****	*****	*****	*****
-0.975	*****	0.1472	0.1302	0.1007	-0.0401	*****	*****	*****	*****	*****

Sharp Radius L.E.
 Run No. = 83, Point No. = 1803
 $C_N = 0.831$, $C_m = -0.1375$
 $\alpha = 16.8^\circ$, $M_\infty = 0.849$
 $R_{mac} = 11.8 \times 10^6$

Surface Pressures Near Leading Edge

● / ◆ upper, starboard/port
 ○ / ◇ lower, starboard/port

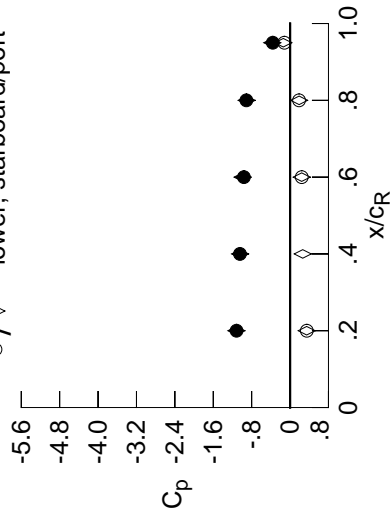

x/c_R	η	starb'd	port	starb'd	port
		$C_{p,u}$	$C_{p,l}$	$C_{p,u}$	$C_{p,l}$
0.20	0.90	-1.1149	-1.1186	0.3463	0.3488
0.40	0.95	-1.0444	-1.0410	0.2642	*****
0.60	0.95	-0.9619	-0.9899	0.2427	0.2432
0.80	0.95	-0.9106	-0.9050	0.1891	0.1873
0.95	0.95	-0.3601	-0.3712	-0.1416	-0.1181

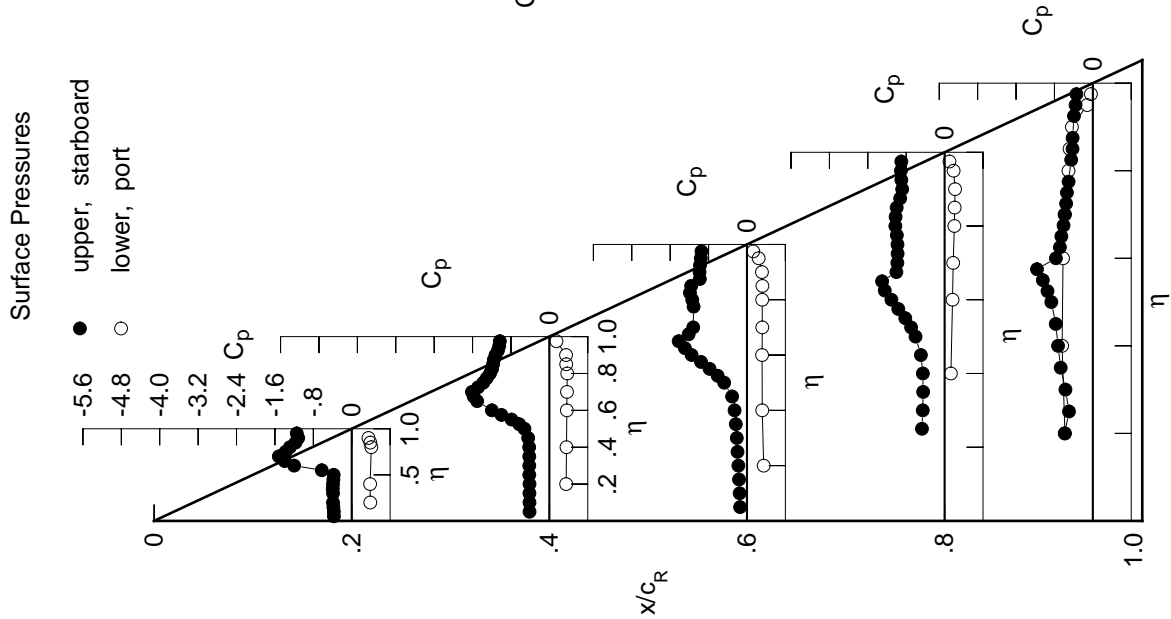

Table C2. Continued.

η	$x/c_R = .2$		$x/c_R = .4$		$x/c_R = .6$		$x/c_R = .8$		$x/c_R = .95$	
	$C_{p,u}$	$C_{p,l}$	$C_{p,u}$	$C_{p,l}$	$C_{p,u}$	$C_{p,l}$	$C_{p,u}$	$C_{p,l}$	$C_{p,u}$	$C_{p,l}$
0.050	-0.4017	-0.4405	-0.1667	*****	*****	*****	*****	*****	*****	*****
0.100	-0.4026	-0.4408	-0.1755	*****	*****	*****	*****	*****	*****	*****
0.150	-0.4136	-0.4414	-0.1907	*****	*****	*****	*****	*****	*****	*****
0.200	-0.4193	-0.4388	-0.2083	*****	*****	*****	*****	*****	*****	*****
0.250	*****	-0.4446	-0.2286	-0.4950	-0.5879	*****	*****	*****	*****	*****
0.300	-0.4220	-0.4431	-0.2533	-0.4839	-0.6438	*****	*****	*****	*****	*****
0.350	-0.4275	-0.4477	-0.2851	-0.4834	-0.6815	*****	*****	*****	*****	*****
0.400	-0.4168	-0.4604	-0.3383	-0.5058	-0.7113	*****	*****	*****	*****	*****
0.450	-0.4038	-0.5101	-0.4312	-0.5781	-0.7709	*****	*****	*****	*****	*****
0.500	-0.4559	-0.6507	-0.6559	-0.7349	-0.8884	*****	*****	*****	*****	*****
0.525	*****	-0.7957	-0.8094	-0.8485	-0.9818	*****	*****	*****	*****	*****
0.550	-0.8806	-0.9733	-0.9786	-0.9772	-1.0898	*****	*****	*****	*****	*****
0.575	*****	-1.1675	-1.1374	-1.1173	-1.2071	*****	*****	*****	*****	*****
0.600	-1.3626	-1.3342	-1.3000	-1.2417	-0.7845	*****	*****	*****	*****	*****
0.625	*****	*****	-1.4103	-1.3595	-0.7159	*****	*****	*****	*****	*****
0.650	-1.4959	-1.5957	-1.2963	-1.1936	-0.6830	*****	*****	*****	*****	*****
0.675	*****	-1.6264	-1.1445	-1.0746	-0.6516	*****	*****	*****	*****	*****
0.700	-1.5037	-1.4816	-1.1326	-1.0679	-0.6415	*****	*****	*****	*****	*****
0.725	*****	-1.3929	*****	-1.0704	-0.6234	*****	*****	*****	*****	*****
0.750	-1.4162	-1.3693	*****	-1.0855	-0.6025	*****	*****	*****	*****	*****
0.775	*****	-1.3434	-1.1508	-1.1072	-0.5484	*****	*****	*****	*****	*****
0.800	-1.3282	-1.3180	-1.1890	-1.1215	*****	*****	*****	*****	*****	*****
0.825	*****	-1.2733	-1.2145	-1.0984	-0.4724	*****	*****	*****	*****	*****
0.850	-1.2069	-1.2277	-1.1426	-1.0810	-0.4345	*****	*****	*****	*****	*****
0.875	*****	-1.1903	-0.9957	-0.9997	-0.4521	*****	*****	*****	*****	*****
0.900	-1.1585	-1.1523	-1.0356	-0.9272	*****	*****	*****	*****	*****	*****
0.925	*****	-1.1111	-1.0473	-0.9293	-0.4345	*****	*****	*****	*****	*****
0.950	-1.1758	-1.0930	-1.0391	-0.9376	-0.3865	*****	*****	*****	*****	*****
0.975	*****	-1.0824	-1.0185	-0.9340	-0.3651	*****	*****	*****	*****	*****
-0.200	0.4186	0.3748	0.3675	*****	*****	*****	*****	*****	*****	*****
-0.400	0.4146	0.3829	0.3395	0.1481	-0.6297	*****	*****	*****	*****	*****
-0.600	*****	0.3882	0.3343	0.1825	-0.6102	*****	*****	*****	*****	*****
-0.700	*****	0.3909	0.3388	0.1963	-0.5768	*****	*****	*****	*****	*****
-0.800	0.4284	0.3929	0.3355	0.2186	-0.4937	*****	*****	*****	*****	*****
-0.850	0.4035	0.3668	0.3368	0.2238	-0.4719	*****	*****	*****	*****	*****
-0.900	0.3596	0.3569	0.3209	0.2268	-0.4204	*****	*****	*****	*****	*****
-0.950	*****	*****	0.2397	0.1871	-0.1158	*****	*****	*****	*****	*****
-0.975	*****	0.1380	0.1176	0.0913	-0.0466	*****	*****	*****	*****	*****

Sharp Radius L.E.
 Run No. = 83, Point No. = 1804
 $C_N = 0.894$, $C_m = -0.1498$
 $\alpha = 17.9^\circ$, $M_\infty = 0.848$
 $R_{mac} = 11.8 \times 10^6$

Surface Pressures Near Leading Edge

● / ◆ upper, starboard/port
 ○ / ◇ lower, starboard/port

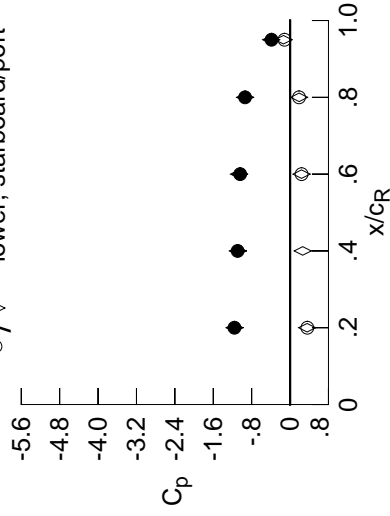

x/c_R	η	starb'd	port	starb'd	port
		$C_{p,u}$	$C_{p,l}$	$C_{p,u}$	$C_{p,l}$
0.20	0.90	-1.1585	-1.1562	0.3555	0.3596
0.40	0.95	-1.0930	-1.0872	0.2634	*****
0.60	0.95	-1.0391	-1.0624	0.2386	0.2397
0.80	0.95	-0.9376	-0.9370	0.1886	0.1871
0.95	0.95	-0.3865	-0.3939	-0.1376	-0.1158

Surface Pressures

● upper, starboard
 ○ lower, port

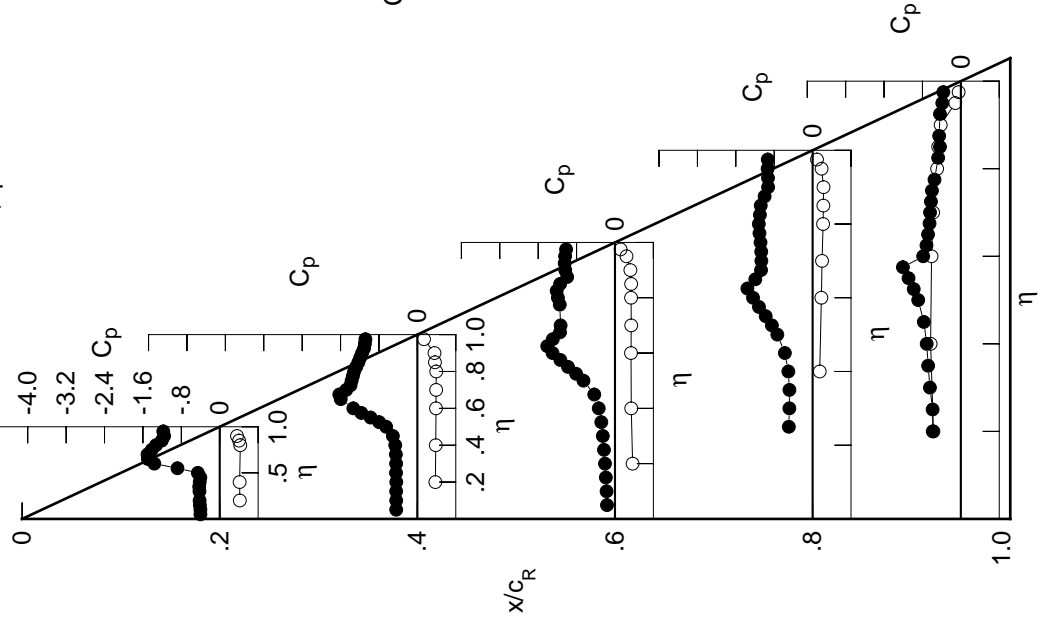

Table C2. Continued.

η	x/c_R .2	$C_{p,u}$	x/c_R .4	$C_{p,u}$	x/c_R .6	$C_{p,u}$	x/c_R .8	$C_{p,u}$	x/c_R .95	$C_{p,u}$
0.050		-0.4350	-0.4722	-0.2457	*****	*****	*****	*****	*****	*****
0.100		-0.4361	-0.4733	-0.2611	*****	*****	*****	*****	*****	*****
0.150		-0.4456	-0.4745	-0.2815	*****	*****	*****	*****	*****	*****
0.200		-0.4519	-0.4746	-0.3081	*****	*****	*****	*****	*****	*****
0.250		*****	-0.4824	-0.3392	-0.5261	-0.5584	*****	*****	*****	*****
0.300		-0.4511	-0.4870	-0.3797	-0.5151	-0.6120	*****	*****	*****	*****
0.350		-0.4554	-0.4990	-0.4274	-0.5236	-0.6419	*****	*****	*****	*****
0.400		-0.4506	-0.5300	-0.5028	-0.5622	-0.6806	*****	*****	*****	*****
0.450		-0.4685	-0.6181	-0.6260	-0.6610	-0.7584	*****	*****	*****	*****
0.500		-0.6502	-0.8162	-0.8717	-0.8439	-0.9051	*****	*****	*****	*****
0.525		*****	-0.9789	-1.0186	-0.9605	-1.0091	*****	*****	*****	*****
0.550		-1.1376	-1.1478	-1.1655	-1.0859	-1.1297	*****	*****	*****	*****
0.575		*****	-1.3112	-1.2972	-1.2119	-1.2437	*****	*****	*****	*****
0.600		-1.4960	-1.4442	-1.4240	-1.3238	-0.8222	*****	*****	*****	*****
0.625		*****	*****	-1.5086	-1.4251	-0.7272	*****	*****	*****	*****
0.650		-1.5984	-1.6479	-1.2514	-1.1459	-0.6746	*****	*****	*****	*****
0.675		*****	-1.4476	-1.2210	-1.1082	-0.6601	*****	*****	*****	*****
0.700		-1.5024	-1.3881	-1.2186	-1.1122	-0.6599	*****	*****	*****	*****
0.725		*****	-1.3726	*****	-1.1228	-0.6481	*****	*****	*****	*****
0.750		-1.4329	-1.3785	*****	-1.1429	-0.6313	*****	*****	*****	*****
0.775		*****	-1.4041	-1.2322	-1.1563	-0.5845	*****	*****	*****	*****
0.800		-1.3050	-1.4184	-1.2759	-1.1560	*****	*****	*****	*****	*****
0.825		*****	-1.3690	-1.2924	-1.1183	-0.5100	*****	*****	*****	*****
0.850		-1.2387	-1.3065	-1.2213	-1.1023	-0.4648	*****	*****	*****	*****
0.875		*****	-1.2460	-1.0735	-1.0323	-0.4782	*****	*****	*****	*****
0.900		-1.1958	-1.1952	-1.1209	-0.9620	*****	*****	*****	*****	*****
0.925		*****	-1.1616	-1.1246	-0.9607	-0.4573	*****	*****	*****	*****
0.950		-1.2060	-1.1494	-1.1161	-0.9687	-0.4034	*****	*****	*****	*****
0.975		*****	-1.1411	-1.1073	-0.9638	-0.3800	*****	*****	*****	*****
-0.200		$C_{p,l}$	$C_{p,l}$	$C_{p,l}$	$C_{p,l}$	$C_{p,l}$	$C_{p,l}$	$C_{p,l}$	$C_{p,l}$	$C_{p,l}$
-0.400		0.4461	0.3991	0.3862	*****	-0.5612	*****	*****	*****	*****
-0.600		0.4431	0.4055	0.3570	0.1646	-0.6174	*****	*****	*****	*****
-0.700		*****	0.4110	0.3519	0.1964	-0.5966	*****	*****	*****	*****
-0.800		*****	0.4115	0.3558	0.2101	-0.5627	*****	*****	*****	*****
-0.850		0.4458	0.4094	0.3496	0.2310	-0.4805	*****	*****	*****	*****
-0.900		0.4163	0.3791	0.3489	0.2358	-0.4576	*****	*****	*****	*****
-0.950		0.3668	0.3632	0.3265	0.2347	-0.4040	*****	*****	*****	*****
-0.975		*****	*****	0.2343	0.1843	-0.1123	*****	*****	*****	*****
		*****	0.1269	0.1038	0.0793	-0.0526	*****	*****	*****	*****

Sharp Radius L.E.
 Run No. = 83, Point No. = 1805
 $C_N = 0.958$, $C_m = -0.1634$
 $\alpha = 18.9^\circ$, $M_\infty = 0.849$
 $R_{mac} = 11.8 \times 10^6$

Surface Pressures Near Leading Edge

● / ◆ upper, starboard/port
 ○ / ◇ lower, starboard/port

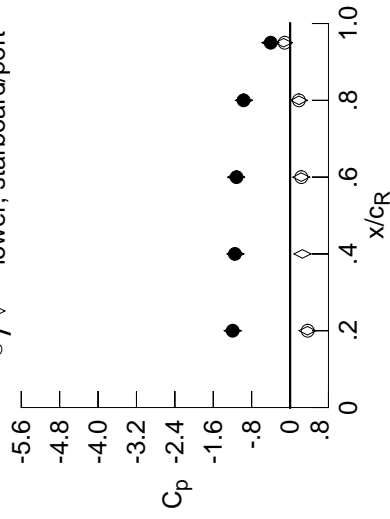

x/c_R	η	starb'd	port	starb'd	port
0.20	0.90	-1.1958	-1.1963	0.3625	0.3668
0.40	0.95	-1.1494	-1.1402	0.2577	*****
0.60	0.95	-1.1161	-1.1251	0.2317	0.2343
0.80	0.95	-0.9687	-0.9609	0.1850	0.1843
0.95	0.95	-0.4034	-0.4112	-0.1340	-0.1123

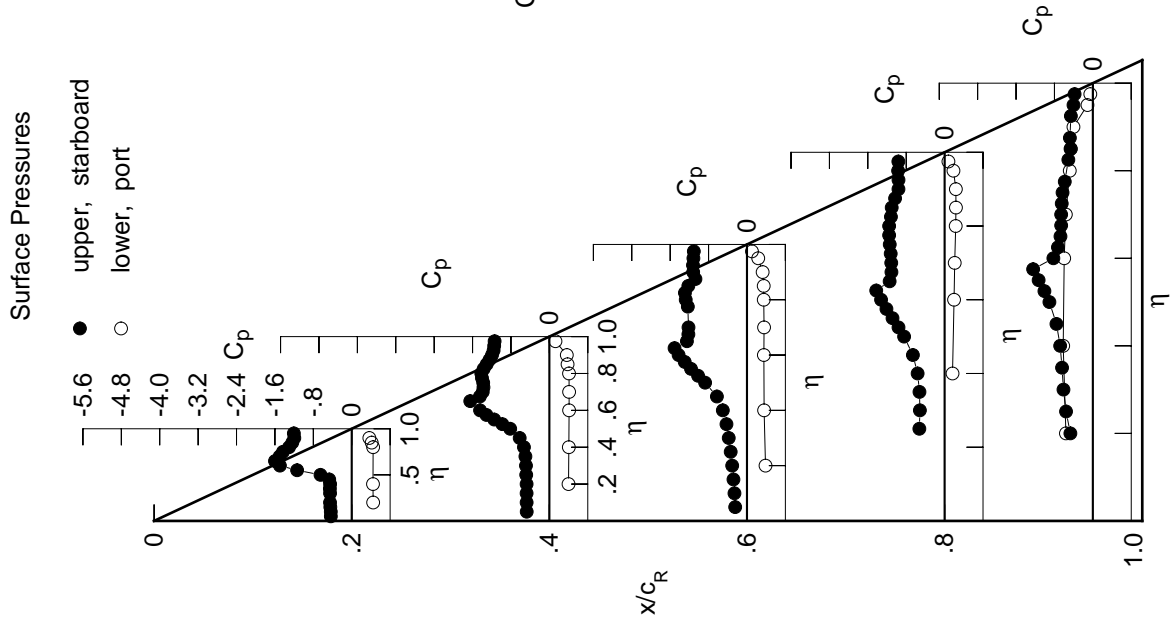

Table C2. Continued.

η	$x/c_R = .2$		$x/c_R = .4$		$x/c_R = .6$		$x/c_R = .8$		$x/c_R = .95$	
	$C_{p,u}$	$C_{p,l}$	$C_{p,u}$	$C_{p,l}$	$C_{p,u}$	$C_{p,l}$	$C_{p,u}$	$C_{p,l}$	$C_{p,u}$	$C_{p,l}$
0.050	-0.4706	-0.5163	-0.4144	*****	*****	*****	*****	*****	*****	*****
0.100	-0.4707	-0.5171	-0.4275	*****	*****	*****	*****	*****	*****	*****
0.150	-0.4806	-0.5204	-0.4484	*****	*****	*****	*****	*****	*****	*****
0.200	-0.4832	-0.5211	-0.4750	*****	*****	*****	*****	*****	*****	*****
0.250	*****	-0.5316	-0.4997	-0.5808	-0.4893	*****	*****	*****	*****	*****
0.300	-0.4807	-0.5398	-0.5304	-0.5738	-0.5517	*****	*****	*****	*****	*****
0.350	-0.4876	-0.5613	-0.5755	-0.5881	-0.5915	*****	*****	*****	*****	*****
0.400	-0.4980	-0.6163	-0.6572	-0.6391	-0.6495	*****	*****	*****	*****	*****
0.450	-0.5810	-0.7451	-0.8090	-0.7546	-0.7565	*****	*****	*****	*****	*****
0.500	-0.8914	-0.9772	-1.0543	-0.9452	-0.9322	*****	*****	*****	*****	*****
0.525	*****	-1.1341	-1.1870	-1.0594	-1.0457	*****	*****	*****	*****	*****
0.550	-1.3307	-1.2829	-1.3110	-1.1754	-1.1673	*****	*****	*****	*****	*****
0.575	*****	-1.4151	-1.4167	-1.2912	-1.2617	*****	*****	*****	*****	*****
0.600	-1.5934	-1.5240	-1.5175	-1.3896	-0.8336	*****	*****	*****	*****	*****
0.625	*****	*****	-1.5424	-1.4814	-0.7139	*****	*****	*****	*****	*****
0.650	-1.6689	-1.4937	-1.3195	-1.2015	-0.6905	*****	*****	*****	*****	*****
0.675	*****	-1.3670	-1.3027	-1.1636	-0.6957	*****	*****	*****	*****	*****
0.700	-1.5152	-1.3697	-1.2982	-1.1545	-0.6826	*****	*****	*****	*****	*****
0.725	*****	-1.3693	*****	-1.1520	-0.6502	*****	*****	*****	*****	*****
0.750	-1.4055	-1.3832	*****	-1.1625	-0.6175	*****	*****	*****	*****	*****
0.775	*****	-1.4121	-1.3045	-1.1712	-0.5734	*****	*****	*****	*****	*****
0.800	-1.3103	-1.4486	-1.3474	-1.1636	*****	*****	*****	*****	*****	*****
0.825	*****	-1.4312	-1.3606	-1.1258	-0.5300	*****	*****	*****	*****	*****
0.850	-1.2728	-1.3569	-1.2958	-1.1171	-0.4829	*****	*****	*****	*****	*****
0.875	*****	-1.2732	-1.1388	-1.0444	-0.4963	*****	*****	*****	*****	*****
0.900	-1.2276	-1.2363	-1.1944	-0.9619	*****	*****	*****	*****	*****	*****
0.925	*****	-1.2228	-1.1987	-0.9622	-0.4703	*****	*****	*****	*****	*****
0.950	-1.2425	-1.2174	-1.1924	-0.9780	-0.4156	*****	*****	*****	*****	*****
0.975	*****	-1.2121	-1.1869	-0.9752	-0.3880	*****	*****	*****	*****	*****
-0.200	0.4768	0.4233	0.4061	*****	*****	*****	*****	*****	*****	*****
-0.400	0.4735	0.4304	0.3779	0.1821	-0.6056	*****	*****	*****	*****	*****
-0.600	*****	0.4338	0.3716	0.2144	-0.5849	*****	*****	*****	*****	*****
-0.700	*****	0.4349	0.3752	0.2259	-0.5501	*****	*****	*****	*****	*****
-0.800	0.4645	0.4280	0.3662	0.2452	-0.4661	*****	*****	*****	*****	*****
-0.850	0.4301	0.3932	0.3622	0.2486	-0.4434	*****	*****	*****	*****	*****
-0.900	0.3754	0.3708	0.3337	0.2430	-0.3891	*****	*****	*****	*****	*****
-0.950	*****	*****	0.2302	0.1829	-0.1081	*****	*****	*****	*****	*****
-0.975	*****	0.1174	0.0919	0.0700	-0.0570	*****	*****	*****	*****	*****

Sharp Radius L.E.
 Run No. = 83, Point No. = 1806
 $C_N = 1.014$, $C_m = -0.1710$
 $\alpha = 19.9^\circ$, $M_\infty = 0.848$
 $R_{mac} = 11.8 \times 10^6$

Surface Pressures Near Leading Edge

● / ◆ upper, starboard/port
 ○ / ◇ lower, starboard/port

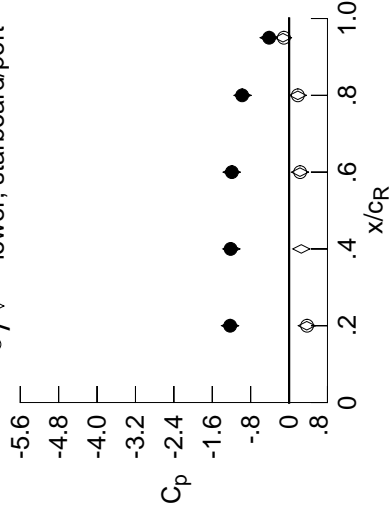

x/c_R	η	starb'd	port	starb'd	port
		$C_{p,u}$	$C_{p,l}$	$C_{p,u}$	$C_{p,l}$
0.20	0.90	-1.2276	-1.2291	0.3695	0.3754
0.40	0.95	-1.2174	-1.2032	0.2547	*****
0.60	0.95	-1.1924	-1.1966	0.2274	0.2302
0.80	0.95	-0.9780	-0.9703	0.1825	0.1829
0.95	0.95	-0.4156	-0.4256	-0.1272	-0.1081

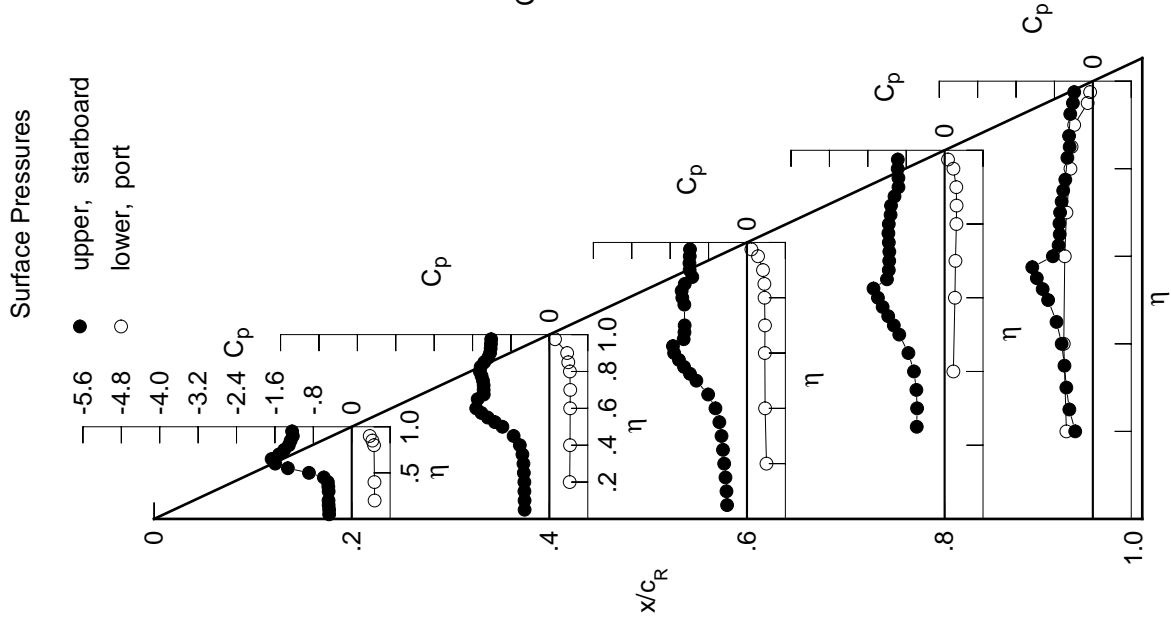

Table C2. Continued.

η	x/c_R .2	x/c_R .4	x/c_R .6	x/c_R .8	x/c_R .95
	$C_{p,u}$	$C_{p,u}$	$C_{p,u}$	$C_{p,u}$	$C_{p,u}$
0.050	-0.5057	-0.5554	-0.5334	*****	*****
0.100	-0.5050	-0.5568	-0.5362	*****	*****
0.150	-0.5156	-0.5596	-0.5445	*****	*****
0.200	-0.5177	-0.5629	-0.5550	*****	-0.3161
0.250	*****	-0.5769	-0.5697	-0.5816	-0.4565
0.300	-0.5190	-0.5918	-0.5984	-0.5973	-0.5347
0.350	-0.5384	-0.6278	-0.6557	-0.6402	-0.5862
0.400	-0.5817	-0.7123	-0.7641	-0.7185	-0.6643
0.450	-0.7497	-0.8812	-0.9443	-0.8529	-0.7881
0.500	-1.1122	-1.1296	-1.1860	-1.0468	-0.9702
0.525	*****	-1.2714	-1.3050	-1.1522	-1.0803
0.550	-1.4582	-1.3935	-1.4098	-1.2587	-1.1954
0.575	*****	-1.4981	-1.4976	-1.3600	-1.0560
0.600	-1.6539	-1.5813	-1.5805	-1.4484	-0.7661
0.625	*****	*****	-1.4818	-1.5261	-0.7024
0.650	-1.6477	-1.4112	-1.3682	-1.2489	-0.6901
0.675	*****	-1.3540	-1.3575	-1.2064	-0.6686
0.700	-1.4703	-1.3641	-1.3569	-1.1906	-0.6284
0.725	*****	-1.3699	*****	-1.1831	-0.5776
0.750	-1.3854	-1.3794	*****	-1.1884	-0.5452
0.775	*****	-1.4051	-1.3643	-1.1855	-0.5217
0.800	-1.3456	-1.4317	-1.3930	-1.1725	*****
0.825	*****	-1.4041	-1.4010	-1.1357	-0.5498
0.850	-1.3109	-1.3527	-1.3514	-1.1415	-0.5173
0.875	*****	-1.3064	-1.1873	-1.0671	-0.5308
0.900	-1.2597	-1.2951	-1.2387	-0.9586	*****
0.925	*****	-1.2905	-1.2397	-0.9463	-0.4993
0.950	-1.2849	-1.2857	-1.2354	-0.9709	-0.4437
0.975	*****	-1.2797	-1.2301	-0.9741	-0.4097
	$C_{p,l}$	$C_{p,l}$	$C_{p,l}$	$C_{p,l}$	$C_{p,l}$
-0.200	0.5064	0.4486	0.4264	*****	-0.5411
-0.400	0.5027	0.4547	0.3970	0.1992	-0.5932
-0.600	*****	0.4578	0.3914	0.2307	-0.5714
-0.700	*****	0.4563	0.3933	0.2411	-0.5358
-0.800	0.4827	0.4457	0.3817	0.2601	-0.4535
-0.850	0.4438	0.4060	0.3744	0.2610	-0.4310
-0.900	0.3835	0.3771	0.3402	0.2510	-0.3753
-0.950	*****	*****	0.2267	0.1811	-0.1067
-0.975	*****	0.1080	0.0814	0.0615	-0.0653

Sharp Radius L.E.
 Run No. = 83 , Point No. = 1807
 $C_N = 1.069$, $C_m = -0.1795$
 $\alpha = 21.0^\circ$, $M_\infty = 0.848$
 $R_{mac} = 11.8 \times 10^6$

Surface Pressures Near Leading Edge

● / ◆ upper, starboard/port
 ○ / ◇ lower, starboard/port

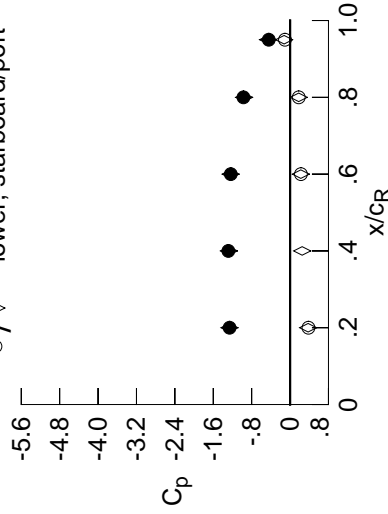

x/c_R	η	starb'd	port	starb'd	port
0.20	0.90	-1.2597	-1.2636	0.3760	0.3835
0.40	0.95	-1.2857	-1.2743	0.2518	*****
0.60	0.95	-1.2354	-1.2390	0.2238	0.2267
0.80	0.95	-0.9709	-0.9573	0.1799	0.1811
0.95	0.95	-0.4437	-0.4588	-0.1243	-0.1067

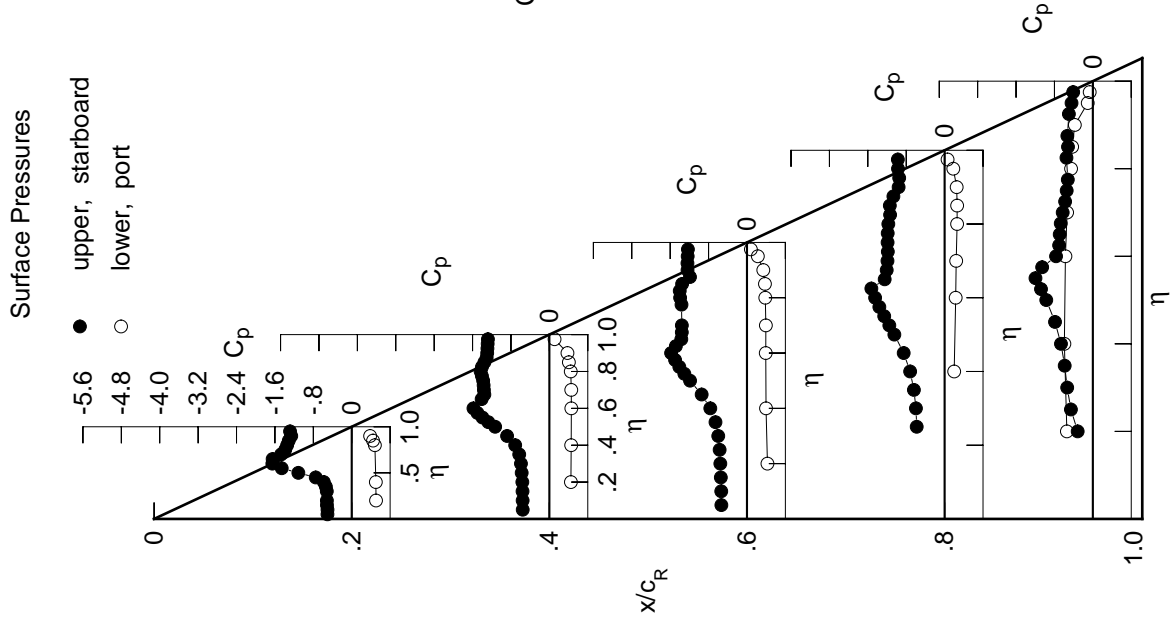

Table C2. Continued.

η	$x/c_R = .2$		$x/c_R = .4$		$x/c_R = .6$		$x/c_R = .8$		$x/c_R = .95$	
	$C_{p,u}$	$C_{p,l}$	$C_{p,u}$	$C_{p,l}$	$C_{p,u}$	$C_{p,l}$	$C_{p,u}$	$C_{p,l}$	$C_{p,u}$	$C_{p,l}$
0.050	-0.5399	-0.5951	-0.5868	*****	*****	*****	*****	*****	*****	*****
0.100	-0.5402	-0.5960	-0.5878	*****	*****	*****	*****	*****	*****	*****
0.150	-0.5537	-0.5979	-0.5922	*****	*****	*****	*****	*****	*****	*****
0.200	-0.5562	-0.6012	-0.6015	*****	*****	*****	*****	*****	*****	*****
0.250	*****	-0.6206	-0.6176	-0.5213	-0.4552	*****	*****	*****	*****	*****
0.300	-0.5682	-0.6446	-0.6539	-0.5523	-0.5466	*****	*****	*****	*****	*****
0.350	-0.6087	-0.7009	-0.7250	-0.6177	-0.6095	*****	*****	*****	*****	*****
0.400	-0.7010	-0.8192	-0.8524	-0.7280	-0.7084	*****	*****	*****	*****	*****
0.450	-0.9278	-1.0202	-1.0435	-0.8911	-0.8532	*****	*****	*****	*****	*****
0.500	-1.2624	-1.2585	-1.2735	-1.0969	-1.0429	*****	*****	*****	*****	*****
0.525	*****	-1.3766	-1.3791	-1.2003	-1.1466	*****	*****	*****	*****	*****
0.550	-1.5346	-1.4758	-1.4721	-1.3006	-1.0371	*****	*****	*****	*****	*****
0.575	*****	-1.5582	-1.5488	-1.3970	-0.7492	*****	*****	*****	*****	*****
0.600	-1.6609	-1.6229	-1.6192	-1.4781	-0.7100	*****	*****	*****	*****	*****
0.625	*****	*****	-1.4567	-1.5300	-0.6888	*****	*****	*****	*****	*****
0.650	-1.4927	-1.4040	-1.4032	-1.2323	-0.6599	*****	*****	*****	*****	*****
0.675	*****	-1.3930	-1.3961	-1.2055	-0.6090	*****	*****	*****	*****	*****
0.700	-1.4420	-1.3846	-1.3907	-1.1969	-0.5603	*****	*****	*****	*****	*****
0.725	*****	-1.3899	*****	-1.1892	-0.5209	*****	*****	*****	*****	*****
0.750	-1.4206	-1.4015	*****	-1.1788	-0.5224	*****	*****	*****	*****	*****
0.775	*****	-1.4318	-1.3987	-1.1677	-0.5400	*****	*****	*****	*****	*****
0.800	-1.4034	-1.4656	-1.4409	-1.1622	*****	*****	*****	*****	*****	*****
0.825	*****	-1.4299	-1.4508	-1.1490	-0.6140	*****	*****	*****	*****	*****
0.850	-1.3483	-1.3737	-1.3946	-1.1927	-0.5860	*****	*****	*****	*****	*****
0.875	*****	-1.3299	-1.2090	-1.1262	-0.5943	*****	*****	*****	*****	*****
0.900	-1.3057	-1.3248	-1.2627	-0.9813	*****	*****	*****	*****	*****	*****
0.925	*****	-1.3256	-1.2695	-0.9357	-0.5653	*****	*****	*****	*****	*****
0.950	-1.3438	-1.3242	-1.2654	-0.9479	-0.4939	*****	*****	*****	*****	*****
0.975	*****	-1.3198	-1.2599	-0.9535	-0.4626	*****	*****	*****	*****	*****

Sharp Radius L.E.
 Run No. = 83 , Point No. = 1808
 $C_N = 1.123$, $C_m = -0.1894$
 $\alpha = 22.0^\circ$, $M_\infty = 0.849$
 $R_{mac} = 11.7 \times 10^6$

Surface Pressures Near Leading Edge

● / ◆ upper, starboard/port
 ○ / ◇ lower, starboard/port

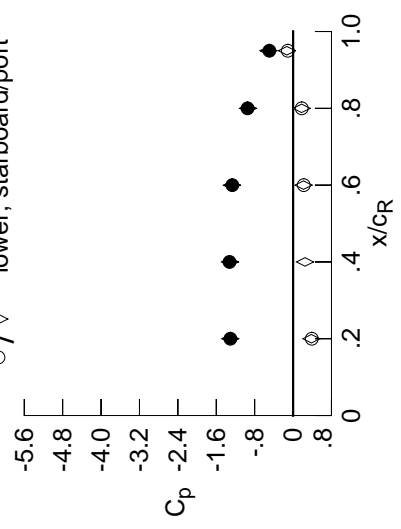

x/c_R	η	starb'd	port	starb'd	port
		$C_{p,u}$	$C_{p,l}$	$C_{p,u}$	$C_{p,l}$
0.20	0.90	-1.3057	-1.3091	0.3814	0.3903
0.40	0.95	-1.3242	-1.3135	0.2487	*****
0.60	0.95	-1.2654	-1.2747	0.2180	0.2225
0.80	0.95	-0.9479	-0.9389	0.1779	0.1810
0.95	0.95	-0.4939	-0.5142	-0.1279	-0.1096

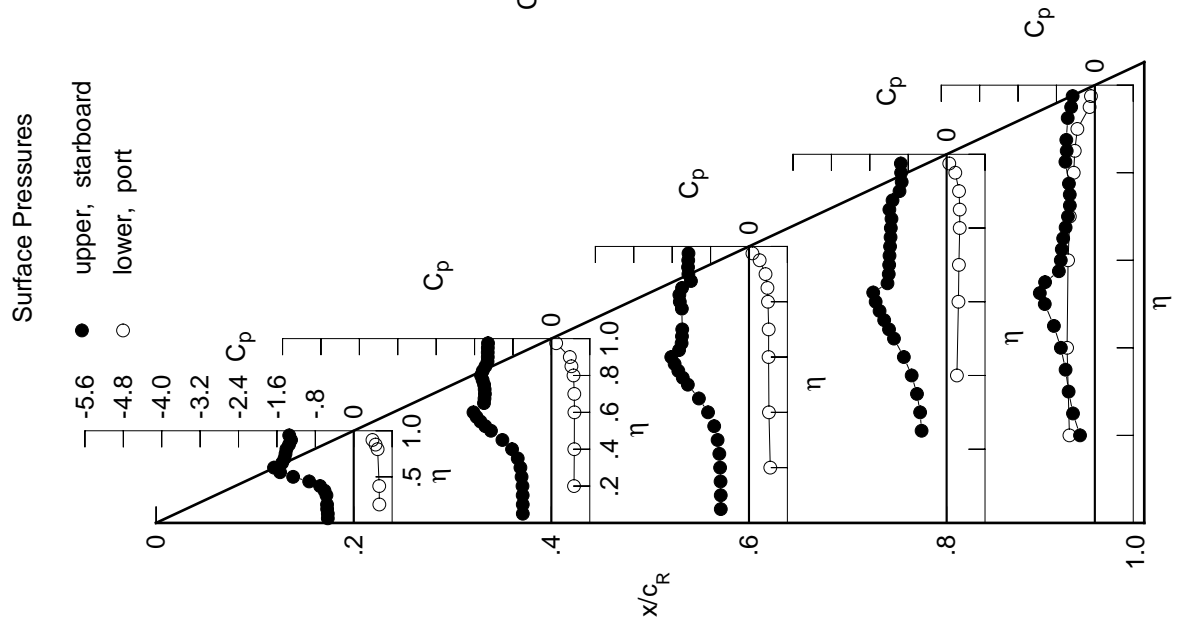

η	$C_{p,l}$	$C_{p,u}$	$C_{p,l}$	$C_{p,u}$	$C_{p,l}$	$C_{p,u}$
-0.200	0.5337	0.4720	0.4437	*****	-0.5297	*****
-0.400	0.5310	0.4776	0.4159	0.2144	-0.5787	*****
-0.600	*****	0.4798	0.4084	0.2462	-0.5578	*****
-0.700	*****	0.4775	0.4103	0.2557	-0.5217	*****
-0.800	0.4978	0.4619	0.3959	0.2727	-0.4397	*****
-0.850	0.4553	0.4179	0.3852	0.2731	-0.4184	*****
-0.900	0.3903	0.3838	0.3449	0.2583	-0.3643	*****
-0.950	*****	*****	0.2225	0.1810	-0.1096	*****
-0.975	*****	0.1001	0.0716	0.0550	-0.0810	*****

Table C2. Continued.

η	x/c_R .2	$C_{p,u}$	x/c_R .4	$C_{p,u}$	x/c_R .6	$C_{p,u}$	x/c_R .8	$C_{p,u}$	x/c_R .95	$C_{p,u}$
0.050		-0.5802		-0.6255		-0.6240		*****		*****
0.100		-0.5830		-0.6280		-0.6249		*****		*****
0.150		-0.5989		-0.6304		-0.6293		*****		*****
0.200		-0.6029		-0.6380		-0.6434		*****		-0.3102
0.250		*****		-0.6622		-0.6648		-0.4959		-0.4562
0.300		-0.6309		-0.6994		-0.7131		-0.5316		-0.5500
0.350		-0.6939		-0.7777		-0.7984		-0.6034		-0.6208
0.400		-0.8223		-0.9230		-0.9393		-0.7222		-0.7318
0.450		-1.0725		-1.1335		-1.1298		-0.8986		-0.8905
0.500		-1.3690		-1.3506		-1.3412		-1.1130		-1.0833
0.525		*****		-1.4530		-1.4367		-1.2176		-1.1648
0.550		-1.5951		-1.5355		-1.5196		-1.3182		-0.7751
0.575		*****		-1.6044		-1.5888		-1.4114		-0.6995
0.600		-1.5338		-1.6594		-1.6511		-1.4906		-0.6863
0.625		*****		*****		-1.4752		-1.4784		-0.6699
0.650		-1.4906		-1.4481		-1.4424		-1.1947		-0.6337
0.675		*****		-1.4396		-1.4335		-1.1807		-0.5842
0.700		-1.4783		-1.4249		-1.4274		-1.1827		-0.5521
0.725		*****		-1.4297		*****		-1.1781		-0.5408
0.750		-1.4892		-1.4393		*****		-1.1587		-0.5640
0.775		*****		-1.4681		-1.4393		-1.1482		-0.5929
0.800		-1.4808		-1.5106		-1.4930		-1.1496		*****
0.825		*****		-1.4742		-1.5102		-1.1409		-0.6601
0.850		-1.3996		-1.4087		-1.4442		-1.2062		-0.6221
0.875		*****		-1.3540		-1.2331		-1.1532		-0.6513
0.900		-1.3493		-1.3473		-1.2891		-0.9877		*****
0.925		*****		-1.3529		-1.3010		-0.9072		-0.6536
0.950		-1.3864		-1.3543		-1.3012		-0.8921		-0.5563
0.975		*****		-1.3539		-1.2957		-0.8824		-0.5352
-0.200		$C_{p,l}$		0.4968		0.4636		*****		-0.5170
-0.400		0.5601		0.5022		0.4366		0.2319		-0.5643
-0.600		*****		0.5035		0.4280		0.2639		-0.5438
-0.700		*****		0.5001		0.4288		0.2722		-0.5081
-0.800		0.5148		0.4789		0.4112		0.2883		-0.4279
-0.850		0.4671		0.4303		0.3972		0.2875		-0.4080
-0.900		0.3972		0.3889		0.3512		0.2691		-0.3553
-0.950		*****		*****		0.2189		0.1846		-0.1141
-0.975		*****		0.0932		0.0626		0.0554		-0.0966

Sharp Radius L.E.
 Run No. = 83 , Point No. = 1809
 $C_N = 1.165$, $C_m = -0.1920$
 $\alpha = 23.1^\circ$, $M_\infty = 0.849$
 $R_{mac} = 11.8 \times 10^6$

Surface Pressures Near Leading Edge

● / ◆ upper, starboard/port
 ○ / ◇ lower, starboard/port

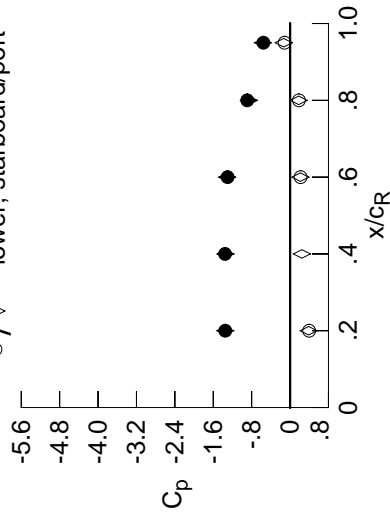

x/c_R	η	starb'd	port	starb'd	port
0.20	0.90	-1.3493	-1.3503	0.3868	0.3972
0.40	0.95	-1.3543	-1.3475	0.2466	*****
0.60	0.95	-1.3012	-1.3125	0.2144	0.2189
0.80	0.95	-0.8921	-0.8569	0.1804	0.1846
0.95	0.95	-0.5563	-0.5662	-0.1330	-0.1141

Surface Pressures

● upper, starboard
 ○ lower, port

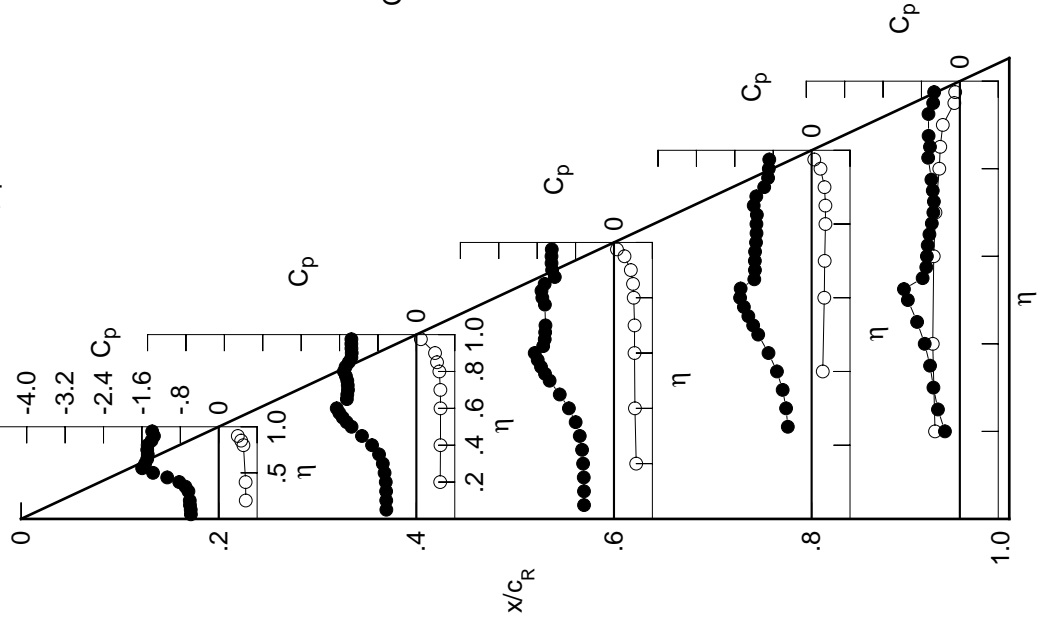

Table C2. Continued.

η	$x/c_R = .2$		$x/c_R = .4$		$x/c_R = .6$		$x/c_R = .8$		$x/c_R = .95$	
	$C_{p,u}$	$C_{p,u}$	$C_{p,u}$	$C_{p,u}$	$C_{p,u}$	$C_{p,u}$	$C_{p,u}$	$C_{p,u}$	$C_{p,u}$	$C_{p,u}$
0.050	-0.6119	-0.6390	0.0043	0.0043	0.0043	0.0043	0.0043	0.0043	0.0043	0.0043
0.100	-0.6166	-0.6411	-0.0086	-0.0086	-0.0086	-0.0086	-0.0086	-0.0086	-0.0086	-0.0086
0.150	-0.6335	-0.6479	-0.0222	-0.0222	-0.0222	-0.0222	-0.0222	-0.0222	-0.0222	-0.0222
0.200	-0.6413	-0.6564	-0.0514	-0.0514	-0.0514	-0.0514	-0.0514	-0.0514	-0.0514	-0.0514
0.250	*****	-0.6894	-0.0914	-0.6224	-0.6224	-0.6865	-0.6865	-0.6865	-0.6865	-0.6865
0.300	-0.6836	-0.7372	-0.1670	-0.6387	-0.7174	-0.7174	-0.7174	-0.7174	-0.7174	-0.7174
0.350	-0.7623	-0.8300	-0.2881	-0.7070	-0.7477	-0.7477	-0.7477	-0.7477	-0.7477	-0.7477
0.400	-0.9091	-0.9872	-0.4743	-0.7405	-0.7721	-0.7721	-0.7721	-0.7721	-0.7721	-0.7721
0.450	-1.1616	-1.1955	-0.7118	-0.7964	-0.7852	-0.7852	-0.7852	-0.7852	-0.7852	-0.7852
0.500	-1.4359	-1.3966	-0.9985	-0.8425	-0.7590	-0.7590	-0.7590	-0.7590	-0.7590	-0.7590
0.525	*****	-1.4900	-1.1291	-0.8552	-0.7734	-0.7734	-0.7734	-0.7734	-0.7734	-0.7734
0.550	-1.6379	-1.5652	-1.2374	-0.8627	-0.7551	-0.7551	-0.7551	-0.7551	-0.7551	-0.7551
0.575	*****	-1.6272	-1.3234	-0.8680	-0.7686	-0.7686	-0.7686	-0.7686	-0.7686	-0.7686
0.600	-1.5028	-1.6753	-1.3265	-0.8792	-0.7615	-0.7615	-0.7615	-0.7615	-0.7615	-0.7615
0.625	*****	*****	-1.1560	-0.8729	-0.7639	-0.7639	-0.7639	-0.7639	-0.7639	-0.7639
0.650	-1.4961	-1.4705	-1.0603	-0.8696	-0.7605	-0.7605	-0.7605	-0.7605	-0.7605	-0.7605
0.675	*****	-1.4606	-1.0145	-0.8643	-0.7410	-0.7410	-0.7410	-0.7410	-0.7410	-0.7410
0.700	-1.5023	-1.4407	-0.9932	-0.8517	-0.7353	-0.7353	-0.7353	-0.7353	-0.7353	-0.7353
0.725	*****	-1.4482	*****	-0.8344	-0.7217	-0.7217	-0.7217	-0.7217	-0.7217	-0.7217
0.750	-1.5530	-1.4598	*****	-0.8056	-0.7139	-0.7139	-0.7139	-0.7139	-0.7139	-0.7139
0.775	*****	-1.4904	-0.8805	-0.7960	-0.6909	-0.6909	-0.6909	-0.6909	-0.6909	-0.6909
0.800	-1.5285	-1.5319	-0.8530	-0.7846	*****	*****	*****	*****	*****	*****
0.825	*****	-1.4981	-0.8340	-0.7733	-0.6643	-0.6643	-0.6643	-0.6643	-0.6643	-0.6643
0.850	-1.4125	-1.4309	-0.8281	-0.7745	-0.6424	-0.6424	-0.6424	-0.6424	-0.6424	-0.6424
0.875	*****	-1.3717	-0.7365	-0.7614	-0.6338	-0.6338	-0.6338	-0.6338	-0.6338	-0.6338
0.900	-1.3730	-1.3622	-0.7180	-0.7394	*****	*****	*****	*****	*****	*****
0.925	*****	-1.3675	-0.6911	-0.7354	-0.6000	-0.6000	-0.6000	-0.6000	-0.6000	-0.6000
0.950	-1.4091	-1.3692	-0.6702	-0.7280	-0.5562	-0.5562	-0.5562	-0.5562	-0.5562	-0.5562
0.975	*****	-1.3686	-0.6614	-0.7091	-0.5187	-0.5187	-0.5187	-0.5187	-0.5187	-0.5187

η	$C_{p,i}$		$C_{p,i}$		$C_{p,i}$		$C_{p,i}$		$C_{p,i}$	
	$C_{p,i}$	$C_{p,i}$	$C_{p,i}$	$C_{p,i}$	$C_{p,i}$	$C_{p,i}$	$C_{p,i}$	$C_{p,i}$	$C_{p,i}$	$C_{p,i}$
-0.200	0.5893	0.5196	0.4801	0.4801	0.4801	0.4801	0.4801	0.4801	0.4801	0.4801
-0.400	0.5863	0.5249	0.4532	0.2355	0.2355	0.5856	0.5856	0.5856	0.5856	0.5856
-0.600	*****	0.5244	0.4480	0.2673	0.2673	0.5649	0.5649	0.5649	0.5649	0.5649
-0.700	*****	0.5209	0.4509	0.2743	0.5292	0.5292	0.5292	0.5292	0.5292	0.5292
-0.800	0.5299	0.4957	0.4355	0.2918	0.4511	0.4511	0.4511	0.4511	0.4511	0.4511
-0.850	0.4791	0.4438	0.4237	0.2890	0.4317	0.4317	0.4317	0.4317	0.4317	0.4317
-0.900	0.4049	0.3986	0.3819	0.2723	0.3779	0.3779	0.3779	0.3779	0.3779	0.3779
-0.950	*****	*****	0.2622	0.1969	0.1325	0.1325	0.1325	0.1325	0.1325	0.1325
-0.975	*****	0.0921	0.1218	0.0776	0.1104	0.1104	0.1104	0.1104	0.1104	0.1104

Sharp Radius L.E.
 Run No. = 83, Point No. = 1810
 $C_N = 1.076$, $C_m = -0.1733$
 $\alpha = 24.0^\circ$, $M_\infty = 0.849$
 $R_{mac} = 11.7 \times 10^6$

Surface Pressures Near Leading Edge

● / ◆ upper, starboard/port
 ○ / ◇ lower, starboard/port

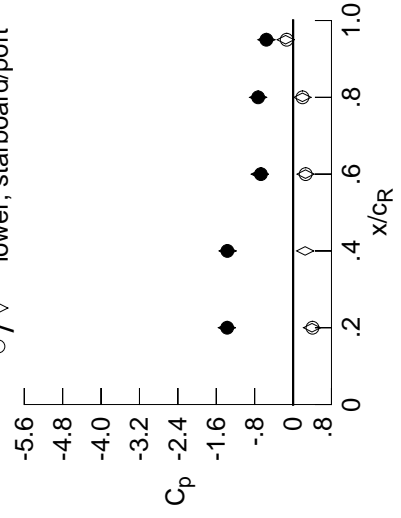

x/c_R	η	starb'd	port	starb'd	port
		$C_{p,u}$	$C_{p,i}$	$C_{p,u}$	$C_{p,i}$
0.20	0.90	-1.3730	-1.3795	0.3942	0.4049
0.40	0.95	-1.3692	-1.3649	0.2512	*****
0.60	0.95	-0.6702	-0.6951	0.2593	0.2622
0.80	0.95	-0.7280	-0.7278	0.1955	0.1969
0.95	0.95	-0.5562	-0.5560	-0.1550	-0.1325

Table C2. Continued.

η	$x/c_R = .2$		$x/c_R = .4$		$x/c_R = .6$		$x/c_R = .8$		$x/c_R = .95$	
	$C_{p,u}$	$C_{p,i}$	$C_{p,u}$	$C_{p,i}$	$C_{p,u}$	$C_{p,i}$	$C_{p,u}$	$C_{p,i}$	$C_{p,u}$	$C_{p,i}$
0.050	-0.6568	-0.6742	-0.0214	*****	*****	*****	*****	*****	*****	*****
0.100	-0.6616	-0.6790	-0.0325	*****	*****	*****	*****	*****	*****	*****
0.150	-0.6792	-0.6892	-0.0470	*****	*****	*****	*****	*****	*****	*****
0.200	-0.6896	-0.7012	-0.0788	*****	*****	*****	*****	*****	*****	*****
0.250	*****	-0.7443	-0.1234	-0.7886	-0.7491	*****	*****	*****	*****	*****
0.300	-0.7565	-0.8021	-0.2062	-0.7898	-0.7928	*****	*****	*****	*****	*****
0.350	-0.8587	-0.9081	-0.3365	-0.8265	-0.8022	*****	*****	*****	*****	*****
0.400	-1.0237	-1.0709	-0.5305	-0.8243	-0.7929	*****	*****	*****	*****	*****
0.450	-1.2618	-1.2717	-0.7617	-0.8426	-0.7787	*****	*****	*****	*****	*****
0.500	-1.4974	-1.4526	-1.0311	-0.8656	-0.7503	*****	*****	*****	*****	*****
0.525	*****	-1.5359	-1.1480	-0.8753	-0.7678	*****	*****	*****	*****	*****
0.550	-1.6682	-1.6014	-1.2368	-0.8820	-0.7554	*****	*****	*****	*****	*****
0.575	*****	-1.6574	-1.3031	-0.8940	-0.7721	*****	*****	*****	*****	*****
0.600	-1.5187	-1.6961	-1.2879	-0.9088	-0.7697	*****	*****	*****	*****	*****
0.625	*****	*****	-1.1272	-0.9061	-0.7732	*****	*****	*****	*****	*****
0.650	-1.5183	-1.5009	-1.0447	-0.8999	-0.7718	*****	*****	*****	*****	*****
0.675	*****	-1.4953	-1.0020	-0.8998	-0.7521	*****	*****	*****	*****	*****
0.700	-1.5270	-1.4696	-0.9791	-0.8908	-0.7453	*****	*****	*****	*****	*****
0.725	*****	-1.4788	*****	-0.8766	-0.7352	*****	*****	*****	*****	*****
0.750	-1.6032	-1.4922	*****	-0.8524	-0.7285	*****	*****	*****	*****	*****
0.775	*****	-1.5296	-0.8928	-0.8442	-0.7075	*****	*****	*****	*****	*****
0.800	-1.5336	-1.5799	-0.8716	-0.8305	*****	*****	*****	*****	*****	*****
0.825	*****	-1.5435	-0.8488	-0.8215	-0.6790	*****	*****	*****	*****	*****
0.850	-1.4292	-1.4659	-0.8425	-0.8210	-0.6558	*****	*****	*****	*****	*****
0.875	*****	-1.4013	-0.7669	-0.8060	-0.6426	*****	*****	*****	*****	*****
0.900	-1.4030	-1.3946	-0.7670	-0.7799	*****	*****	*****	*****	*****	*****
0.925	*****	-1.4010	-0.7505	-0.7737	-0.6047	*****	*****	*****	*****	*****
0.950	-1.4386	-1.4010	-0.7307	-0.7620	-0.5612	*****	*****	*****	*****	*****
0.975	*****	-1.3989	-0.7241	-0.7376	-0.5224	*****	*****	*****	*****	*****
-0.200	$C_{p,i}$	0.6192	0.5443	0.5007	*****	*****	*****	*****	*****	*****
-0.400	0.6143	0.5488	0.4737	0.2540	-0.5692	*****	*****	*****	*****	*****
-0.600	*****	0.5467	0.4667	0.2854	-0.5472	*****	*****	*****	*****	*****
-0.700	*****	0.5410	0.4676	0.2906	-0.5124	*****	*****	*****	*****	*****
-0.800	0.5447	0.5112	0.4484	0.3048	-0.4335	*****	*****	*****	*****	*****
-0.850	0.4896	0.4543	0.4327	0.3012	-0.4143	*****	*****	*****	*****	*****
-0.900	0.4109	0.4036	0.3839	0.2786	-0.3609	*****	*****	*****	*****	*****
-0.950	*****	*****	0.2531	0.1926	-0.1262	*****	*****	*****	*****	*****
-0.975	*****	0.0854	0.1062	0.0652	-0.1120	*****	*****	*****	*****	*****

Sharp Radius L.E.

Run No. = 83, Point No. = 1811

$C_N = 1.128$, $C_m = -0.1781$

$\alpha = 25.1^\circ$, $M_\infty = 0.849$

$R_{mac} = 11.7 \times 10^6$

Surface Pressures Near Leading Edge

● / ◆ upper, starboard/port
○ / ◇ lower, starboard/port

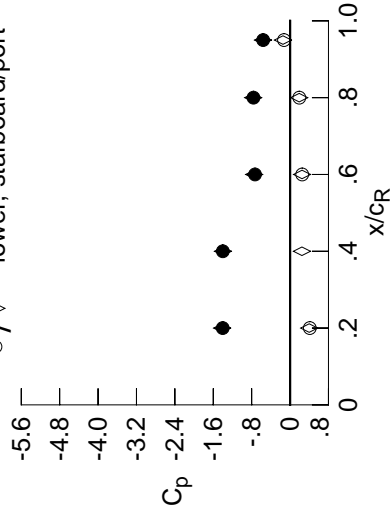

x/cR	η	$C_{p,u}$ starb'd	$C_{p,u}$ port	$C_{p,i}$ starb'd	$C_{p,i}$ port
0.20	0.90	-1.4030	-1.4157	0.3988	0.4109
0.40	0.95	-1.4010	-1.3985	0.2473	*****
0.60	0.95	-0.7307	-0.7481	0.2499	0.2531
0.80	0.95	-0.7620	-0.7691	0.1903	0.1926
0.95	0.95	-0.5612	-0.5637	-0.1484	-0.1262

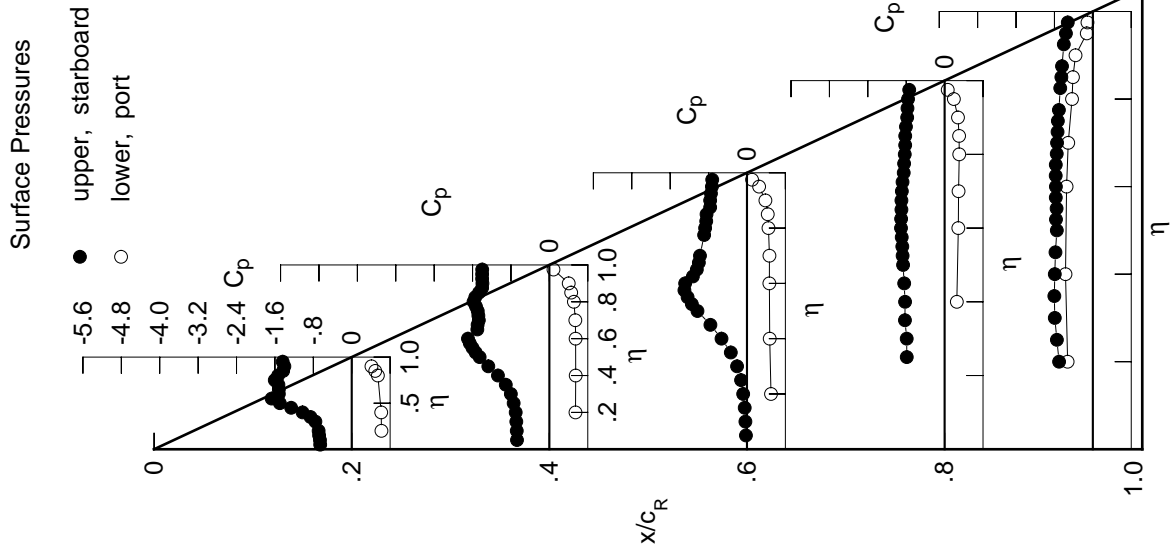

Table C2. Continued.

η	$x/c_R = .2$		$x/c_R = .4$		$x/c_R = .6$		$x/c_R = .8$		$x/c_R = .95$	
	$C_{p,u}$	$C_{p,l}$	$C_{p,u}$	$C_{p,l}$	$C_{p,u}$	$C_{p,l}$	$C_{p,u}$	$C_{p,l}$	$C_{p,u}$	$C_{p,l}$
0.050	-0.7017	-0.7122	-0.0691	*****	*****	*****	*****	*****	*****	*****
0.100	-0.7058	-0.7181	-0.0815	*****	*****	*****	*****	*****	*****	*****
0.150	-0.7264	-0.7305	-0.0962	*****	*****	*****	*****	*****	*****	*****
0.200	-0.7386	-0.7488	-0.1257	*****	*****	*****	*****	*****	*****	*****
0.250	*****	-0.7972	-0.1738	-0.9578	-0.8328	*****	*****	*****	*****	*****
0.300	-0.8260	-0.8672	-0.2602	-0.9270	-0.8817	*****	*****	*****	*****	*****
0.350	-0.9455	-0.9812	-0.3926	-0.9091	-0.8540	*****	*****	*****	*****	*****
0.400	-1.1182	-1.1456	-0.5838	-0.8661	-0.7961	*****	*****	*****	*****	*****
0.450	-1.3412	-1.3328	-0.8017	-0.8479	-0.7656	*****	*****	*****	*****	*****
0.500	-1.5481	-1.4960	-1.0479	-0.8596	-0.7482	*****	*****	*****	*****	*****
0.525	*****	-1.5696	-1.1496	-0.8760	-0.7732	*****	*****	*****	*****	*****
0.550	-1.6924	-1.6303	-1.2263	-0.8971	-0.7656	*****	*****	*****	*****	*****
0.575	*****	-1.6781	-1.2751	-0.9200	-0.7848	*****	*****	*****	*****	*****
0.600	-1.5443	-1.7141	-1.2533	-0.9373	-0.7833	*****	*****	*****	*****	*****
0.625	*****	*****	-1.0905	-0.9351	-0.7893	*****	*****	*****	*****	*****
0.650	-1.5449	-1.5327	-1.0032	-0.9331	-0.7891	*****	*****	*****	*****	*****
0.675	*****	-1.5224	-0.9644	-0.9359	-0.7706	*****	*****	*****	*****	*****
0.700	-1.5561	-1.4894	-0.9483	-0.9280	-0.7683	*****	*****	*****	*****	*****
0.725	*****	-1.4999	*****	-0.9186	-0.7572	*****	*****	*****	*****	*****
0.750	-1.6468	-1.5168	*****	-0.8987	-0.7525	*****	*****	*****	*****	*****
0.775	*****	-1.5582	-0.8978	-0.8932	-0.7279	*****	*****	*****	*****	*****
0.800	-1.5429	-1.6037	-0.8766	-0.8800	*****	*****	*****	*****	*****	*****
0.825	*****	-1.5671	-0.8542	-0.8709	-0.6973	*****	*****	*****	*****	*****
0.850	-1.4391	-1.4904	-0.8478	-0.8697	-0.6711	*****	*****	*****	*****	*****
0.875	*****	-1.4284	-0.7918	-0.8533	-0.6567	*****	*****	*****	*****	*****
0.900	-1.4221	-1.4229	-0.8158	-0.8258	*****	*****	*****	*****	*****	*****
0.925	*****	-1.4315	-0.8091	-0.8193	-0.6168	*****	*****	*****	*****	*****
0.950	-1.4611	-1.4332	-0.7924	-0.8035	-0.5762	*****	*****	*****	*****	*****
0.975	*****	-1.4305	-0.7881	-0.7745	-0.5378	*****	*****	*****	*****	*****

η	$x/c_R = .2$		$x/c_R = .4$		$x/c_R = .6$		$x/c_R = .8$		$x/c_R = .95$	
	$C_{p,u}$	$C_{p,l}$	$C_{p,u}$	$C_{p,l}$	$C_{p,u}$	$C_{p,l}$	$C_{p,u}$	$C_{p,l}$	$C_{p,u}$	$C_{p,l}$
-0.200	0.6472	0.5683	0.5199	*****	*****	*****	*****	*****	*****	*****
-0.400	0.6419	0.5729	0.4929	0.2709	-0.5530	*****	*****	*****	*****	*****
-0.600	*****	0.5682	0.4842	0.3020	-0.5320	*****	*****	*****	*****	*****
-0.700	*****	0.5613	0.4848	0.3046	-0.4971	*****	*****	*****	*****	*****
-0.800	0.5593	0.5266	0.4615	0.3187	-0.4180	*****	*****	*****	*****	*****
-0.850	0.5002	0.4651	0.4417	0.3108	-0.4001	*****	*****	*****	*****	*****
-0.900	0.4170	0.4092	0.3879	0.2829	-0.3461	*****	*****	*****	*****	*****
-0.950	*****	*****	0.2479	0.1868	-0.1227	*****	*****	*****	*****	*****
-0.975	*****	0.0800	0.0939	0.0514	-0.1177	*****	*****	*****	*****	*****

Sharp Radius L.E.
 Run No. = 83, Point No. = 1812
 $C_N = 1.175$, $C_m = -0.1847$
 $\alpha = 26.1^\circ$, $M_\infty = 0.849$
 $R_{mac} = 11.7 \times 10^6$

Surface Pressures Near Leading Edge

● / ◆ upper, starboard/port
 ○ / ◇ lower, starboard/port

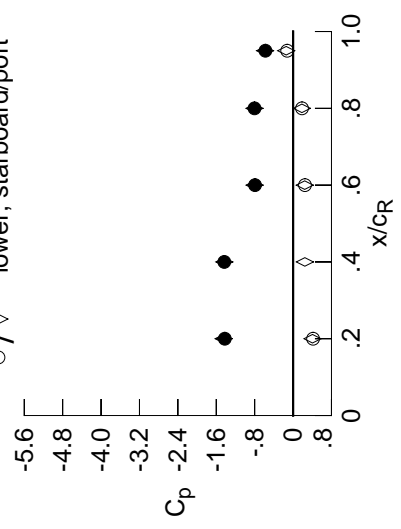

x/c_R	η	starb'd	port	starb'd	port
		$C_{p,u}$	$C_{p,l}$	$C_{p,u}$	$C_{p,l}$
0.20	0.90	-1.4221	-1.4471	0.4044	0.4170
0.40	0.95	-1.4332	-1.4324	0.2457	*****
0.60	0.95	-0.7924	-0.8021	0.2425	0.2479
0.80	0.95	-0.8035	-0.8037	0.1844	0.1868
0.95	0.95	-0.5762	-0.5832	-0.1434	-0.1227

Table C2. Continued.

η	x/c_R .2	$C_{p,u}$	x/c_R .4	$C_{p,u}$	x/c_R .6	$C_{p,u}$	x/c_R .8	$C_{p,u}$	x/c_R .95	$C_{p,u}$
0.050		-0.7427	-0.7451	-0.2946	*****	*****	*****	*****	*****	*****
0.100		-0.7490	-0.7553	-0.2888	*****	*****	*****	*****	*****	*****
0.150		-0.7747	-0.7702	-0.2852	*****	*****	*****	*****	*****	*****
0.200		-0.7912	-0.7947	-0.3018	*****	*****	*****	*****	*****	*****
0.250		*****	-0.8473	-0.3350	-0.9733	-0.8496	*****	*****	*****	*****
0.300		-0.8961	-0.9284	-0.4097	-0.9403	-0.8970	*****	*****	*****	*****
0.350		-1.0256	-1.0481	-0.5262	-0.9308	-0.8720	*****	*****	*****	*****
0.400		-1.2003	-1.2116	-0.6972	-0.8921	-0.8107	*****	*****	*****	*****
0.450		-1.4071	-1.3869	-0.8804	-0.8782	-0.7708	*****	*****	*****	*****
0.500		-1.5901	-1.5340	-1.0960	-0.8887	-0.7524	*****	*****	*****	*****
0.525		*****	-1.6013	-1.1809	-0.9049	-0.7776	*****	*****	*****	*****
0.550		-1.7085	-1.6538	-1.2353	-0.9273	-0.7771	*****	*****	*****	*****
0.575		*****	-1.6968	-1.2558	-0.9526	-0.7957	*****	*****	*****	*****
0.600		-1.5694	-1.7254	-1.2121	-0.9759	-0.7966	*****	*****	*****	*****
0.625		*****	*****	-1.0789	-0.9779	-0.8035	*****	*****	*****	*****
0.650		-1.5705	-1.5622	-1.0145	-0.9805	-0.8024	*****	*****	*****	*****
0.675		*****	-1.5493	-0.9998	-0.9847	-0.7843	*****	*****	*****	*****
0.700		-1.5848	-1.5180	-1.0016	-0.9761	-0.7808	*****	*****	*****	*****
0.725		*****	-1.5250	*****	-0.9640	-0.7698	*****	*****	*****	*****
0.750		-1.6697	-1.5377	*****	-0.9428	-0.7617	*****	*****	*****	*****
0.775		*****	-1.5713	-0.9561	-0.9394	-0.7395	*****	*****	*****	*****
0.800		-1.5647	-1.6206	-0.9391	-0.9300	*****	*****	*****	*****	*****
0.825		*****	-1.5902	-0.9138	-0.9237	-0.7063	*****	*****	*****	*****
0.850		-1.4554	-1.5180	-0.9045	-0.9221	-0.6787	*****	*****	*****	*****
0.875		*****	-1.4568	-0.8434	-0.9045	-0.6677	*****	*****	*****	*****
0.900		-1.4464	-1.4496	-0.8749	-0.8730	*****	*****	*****	*****	*****
0.925		*****	-1.4589	-0.8675	-0.8631	-0.6294	*****	*****	*****	*****
0.950		-1.4881	-1.4629	-0.8485	-0.8485	-0.5939	*****	*****	*****	*****
0.975		*****	-1.4621	-0.8441	-0.8178	-0.5565	*****	*****	*****	*****
-0.200		$C_{p,l}$	$C_{p,l}$	$C_{p,l}$	$C_{p,l}$	$C_{p,l}$	$C_{p,l}$	$C_{p,l}$	$C_{p,l}$	$C_{p,l}$
-0.400		0.6754	0.5937	0.5395	*****	-0.4979	*****	*****	*****	*****
-0.600		0.6697	0.5984	0.5134	0.2887	-0.5390	*****	*****	*****	*****
-0.700		*****	0.5916	0.5029	0.3186	-0.5164	*****	*****	*****	*****
-0.800		*****	0.5820	0.5015	0.3221	-0.4827	*****	*****	*****	*****
-0.850		0.5760	0.5428	0.4756	0.3320	-0.4046	*****	*****	*****	*****
-0.900		0.5114	0.4788	0.4522	0.3241	-0.3879	*****	*****	*****	*****
-0.950		0.4241	0.4164	0.3917	0.2918	-0.3335	*****	*****	*****	*****
-0.975		*****	*****	0.2426	0.1886	-0.1201	*****	*****	*****	*****
		*****	0.0790	0.0821	0.0495	-0.1223	*****	*****	*****	*****

Sharp Radius L.E.
 Run No. = 83 , Point No. = 1813
 $C_N = 1.215$, $C_m = -0.1936$
 $\alpha = 27.1^\circ$, $M_\infty = 0.848$
 $R_{mac} = 11.7 \times 10^6$

Surface Pressures Near Leading Edge

● / ◆ upper, starboard/port
 ○ / ◇ lower, starboard/port

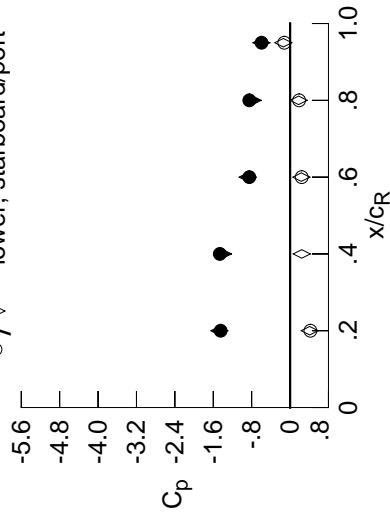

x/c_R	η	starb'd	port	starb'd	port
0.20	0.90	-1.4464	-1.4740	0.4087	0.4241
0.40	0.95	-1.4629	-1.3977	0.2433	*****
0.60	0.95	-0.8485	-0.8859	0.2342	0.2426
0.80	0.95	-0.8485	-0.7790	0.1779	0.1886
0.95	0.95	-0.5939	-0.5984	-0.1406	-0.1201

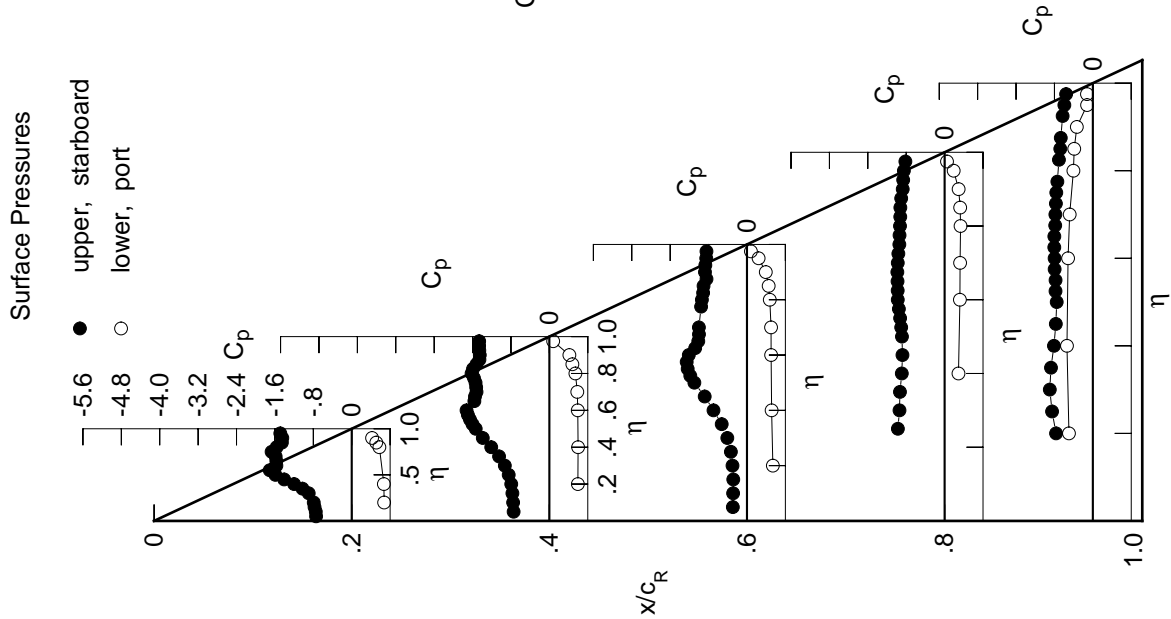

Table C2. Concluded.

η	$x/c_R = .2$		$x/c_R = .4$		$x/c_R = .6$		$x/c_R = .8$		$x/c_R = .95$	
	$C_{p,u}$	$C_{p,l}$	$C_{p,u}$	$C_{p,l}$	$C_{p,u}$	$C_{p,l}$	$C_{p,u}$	$C_{p,l}$	$C_{p,u}$	$C_{p,l}$
0.050	-0.0194	-0.0026	0.1259	0.1259	0.1259	0.1259	0.1259	0.1259	0.1259	0.1259
0.100	-0.0155	-0.0034	0.1164	0.1164	0.1164	0.1164	0.1164	0.1164	0.1164	0.1164
0.150	-0.0207	-0.0044	0.1019	0.1019	0.1019	0.1019	0.1019	0.1019	0.1019	0.1019
0.200	-0.0256	-0.0024	0.0907	0.0907	0.0907	0.0907	0.0907	0.0907	0.0907	0.0907
0.250	*****	-0.0034	0.0772	-0.1358	0.0772	-0.1358	0.0772	-0.1358	0.0772	-0.1358
0.300	-0.0335	-0.0022	0.0672	-0.1216	0.0672	-0.1216	0.0672	-0.1216	0.0672	-0.1216
0.350	-0.0408	-0.0058	0.0544	-0.1090	0.0544	-0.1090	0.0544	-0.1090	0.0544	-0.1090
0.400	-0.0496	-0.0065	0.0462	-0.0994	0.0462	-0.0994	0.0462	-0.0994	0.0462	-0.0994
0.450	-0.0585	-0.0092	0.0455	-0.0940	0.0455	-0.0940	0.0455	-0.0940	0.0455	-0.0940
0.500	-0.0636	-0.0158	0.0314	-0.0863	0.0314	-0.0863	0.0314	-0.0863	0.0314	-0.0863
0.525	*****	-0.0163	0.0244	-0.0858	0.0244	-0.0858	0.0244	-0.0858	0.0244	-0.0858
0.550	-0.0662	-0.0196	0.0241	-0.0840	0.0241	-0.0840	0.0241	-0.0840	0.0241	-0.0840
0.575	*****	-0.0290	0.0252	-0.0829	0.0252	-0.0829	0.0252	-0.0829	0.0252	-0.0829
0.600	-0.0573	-0.0305	0.0142	-0.0816	0.0142	-0.0816	0.0142	-0.0816	0.0142	-0.0816
0.625	*****	0.0121	-0.0807	-0.0807	0.0121	-0.0807	-0.0807	0.0121	-0.0807	-0.0807
0.650	-0.0439	-0.0323	0.0122	-0.0796	0.0122	-0.0796	0.0122	-0.0796	0.0122	-0.0796
0.675	*****	-0.0395	0.0007	-0.0802	0.0007	-0.0802	0.0007	-0.0802	0.0007	-0.0802
0.700	-0.0346	-0.0552	-0.0050	-0.0801	-0.0050	-0.0801	-0.0050	-0.0801	-0.0050	-0.0801
0.725	*****	-0.0676	*****	-0.0827	*****	-0.0827	*****	-0.0827	*****	-0.0827
0.750	-0.0122	-0.0690	*****	-0.0890	*****	-0.0890	*****	-0.0890	*****	-0.0890
0.775	*****	-0.0772	-0.0231	-0.0873	-0.0231	-0.0873	-0.0231	-0.0873	-0.0231	-0.0873
0.800	-0.0059	-0.0705	-0.0409	-0.0907	-0.0409	-0.0907	-0.0409	-0.0907	-0.0409	-0.0907
0.825	*****	-0.0661	-0.0604	-0.0966	-0.0604	-0.0966	-0.0604	-0.0966	-0.0604	-0.0966
0.850	0.0182	-0.0539	-0.0644	-0.1162	-0.0644	-0.1162	-0.0644	-0.1162	-0.0644	-0.1162
0.875	*****	-0.0375	-0.0584	-0.1338	-0.0375	-0.1338	-0.0375	-0.1338	-0.0375	-0.1338
0.900	0.0559	-0.0243	-0.0483	-0.1346	-0.0483	-0.1346	-0.0483	-0.1346	-0.0483	-0.1346
0.925	*****	0.0049	-0.0234	-0.1117	-0.0234	-0.1117	-0.0234	-0.1117	-0.0234	-0.1117
0.950	0.1035	0.0448	0.0077	-0.0780	0.0077	-0.0780	0.0077	-0.0780	0.0077	-0.0780
0.975	*****	0.0977	0.0684	-0.0036	0.0684	-0.0036	0.0684	-0.0036	0.0684	-0.0036
-0.200	-0.0253	-0.0016	0.0818	0.0818	0.0818	0.0818	0.0818	0.0818	0.0818	0.0818
-0.400	-0.0504	-0.0056	0.0418	-0.0993	0.0418	-0.0993	0.0418	-0.0993	0.0418	-0.0993
-0.600	*****	-0.0242	0.0125	-0.0897	0.0125	-0.0897	0.0125	-0.0897	0.0125	-0.0897
-0.700	*****	-0.0596	-0.0111	-0.0831	-0.0111	-0.0831	-0.0111	-0.0831	-0.0111	-0.0831
-0.800	-0.0295	-0.0835	-0.0512	-0.0991	-0.0512	-0.0991	-0.0512	-0.0991	-0.0512	-0.0991
-0.850	0.0074	-0.0567	-0.0751	-0.1267	-0.0751	-0.1267	-0.0751	-0.1267	-0.0751	-0.1267
-0.900	0.0422	-0.0399	-0.0742	-0.1456	-0.0742	-0.1456	-0.0742	-0.1456	-0.0742	-0.1456
-0.950	*****	*****	-0.0096	-0.1015	-0.0096	-0.1015	-0.0096	-0.1015	-0.0096	-0.1015
-0.975	*****	0.0858	0.0458	-0.0263	0.0458	-0.0263	0.0458	-0.0263	0.0458	-0.0263

Sharp Radius L.E.
 Run No. = 83 , Point No. = 1814
 $C_N = -0.002$, $C_m = -0.0055$
 $\alpha = 0.0^\circ$, $M_\infty = 0.849$
 $R_{mac} = 11.7 \times 10^6$

Surface Pressures Near Leading Edge

● / ◆ upper, starboard/port
 ○ / ◇ lower, starboard/port

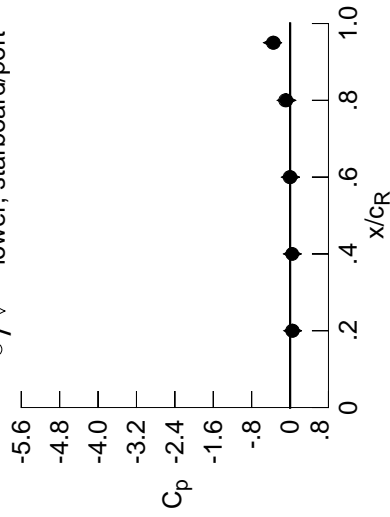

x/c_R	η	starb'd	port	$C_{p,u}$	starb'd	port	$C_{p,l}$
0.20	0.90	0.0559	0.0588	0.0476	0.0422	0.0476	0.0422
0.40	0.95	0.0448	0.0522	0.0415	0.0415	0.0415	0.0415
0.60	0.95	0.0077	0.0155	-0.0017	-0.0096	-0.0017	-0.0096
0.80	0.95	-0.0780	-0.0598	-0.0904	-0.1015	-0.0904	-0.1015
0.95	0.95	-0.3389	-0.3549	-0.3740	-0.3574	-0.3740	-0.3574

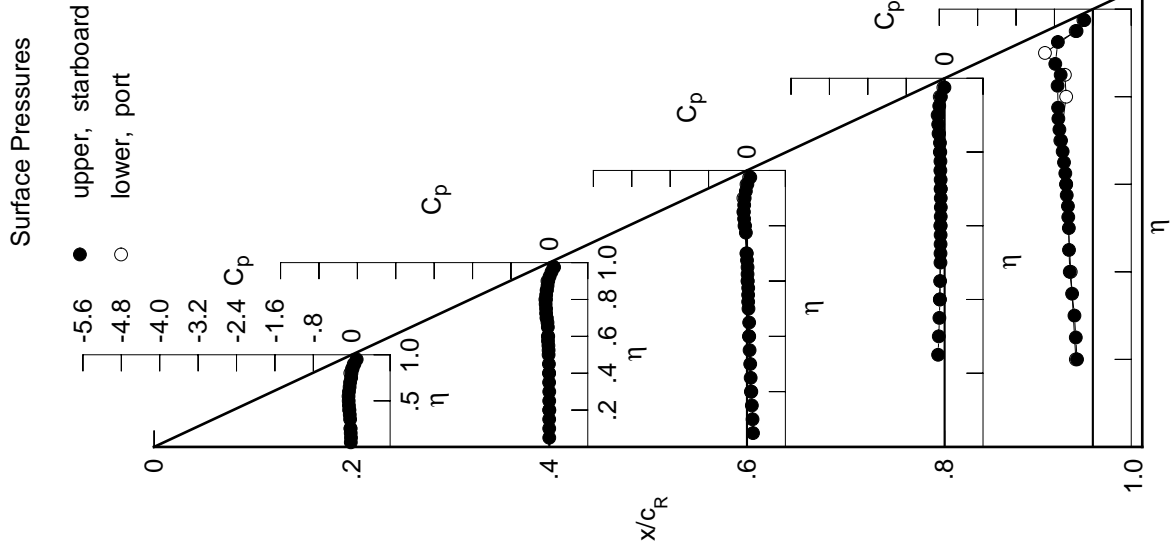

Table C3. Tabulations and Plots of Surface Pressure Coefficients.

η	$x/c_R = .2$		$x/c_R = .4$		$x/c_R = .6$		$x/c_R = .8$		$x/c_R = .95$	
	$C_{p,u}$	$C_{p,l}$	$C_{p,u}$	$C_{p,l}$	$C_{p,u}$	$C_{p,l}$	$C_{p,u}$	$C_{p,l}$	$C_{p,u}$	$C_{p,l}$
0.050	-0.0036	0.0122	0.1365	0.1365	0.1365	0.1365	0.1365	0.1365	0.1365	0.1365
0.100	0.0029	0.0133	0.1282	0.1282	0.1282	0.1282	0.1282	0.1282	0.1282	0.1282
0.150	-0.0035	0.0143	0.1160	0.1160	0.1160	0.1160	0.1160	0.1160	0.1160	0.1160
0.200	-0.0060	0.0189	0.1045	0.1045	0.1045	0.1045	0.1045	0.1045	0.1045	0.1045
0.250	*****	0.0138	0.0913	-0.1197	-0.3971	0.0913	-0.1197	-0.3971	0.0913	-0.3971
0.300	-0.0148	0.0153	0.0809	-0.1041	-0.5144	0.0809	-0.1041	-0.5144	0.0809	-0.5144
0.350	-0.0221	0.0133	0.0710	-0.0959	-0.6223	0.0710	-0.0959	-0.6223	0.0710	-0.6223
0.400	-0.0279	0.0107	0.0621	-0.0839	-0.6624	0.0621	-0.0839	-0.6624	0.0621	-0.6624
0.450	-0.0373	0.0062	0.0679	-0.0771	-0.6603	0.0679	-0.0771	-0.6603	0.0679	-0.6603
0.500	-0.0421	0.0065	0.0434	-0.0716	-0.6407	0.0434	-0.0716	-0.6407	0.0434	-0.6407
0.525	*****	0.0027	0.0440	-0.0691	-0.6521	0.0440	-0.0691	-0.6521	0.0440	-0.6521
0.550	-0.0463	-0.0008	0.0388	-0.0665	-0.6489	0.0388	-0.0665	-0.6489	0.0388	-0.6489
0.575	*****	-0.0063	0.0430	-0.0658	-0.6602	0.0430	-0.0658	-0.6602	0.0430	-0.6602
0.600	-0.0401	-0.0099	0.0320	-0.0651	-0.6634	0.0320	-0.0651	-0.6634	0.0320	-0.6634
0.625	*****	0.0333	-0.0620	-0.6773	0.0333	-0.0620	-0.6773	0.0333	-0.0620	-0.6773
0.650	-0.0266	-0.0133	0.0246	-0.0613	-0.6986	0.0246	-0.0613	-0.6986	0.0246	-0.6986
0.675	*****	-0.0200	0.0179	-0.0633	-0.7102	0.0179	-0.0633	-0.7102	0.0179	-0.7102
0.700	-0.0174	-0.0331	0.0173	-0.0601	-0.7282	0.0173	-0.0601	-0.7282	0.0173	-0.7282
0.725	*****	-0.0430	*****	-0.0603	-0.7318	*****	-0.0603	-0.7318	*****	-0.7318
0.750	0.0040	-0.0439	*****	-0.0608	-0.7279	*****	-0.0608	-0.7279	*****	-0.7279
0.775	*****	-0.0484	-0.0027	-0.0670	-0.7149	-0.0027	-0.0670	-0.7149	*****	-0.7149
0.800	0.0208	-0.0452	-0.0208	-0.0725	*****	-0.0208	-0.0725	*****	0.0208	-0.0452
0.825	*****	-0.0371	-0.0330	-0.0734	-0.7475	-0.0330	-0.0734	-0.7475	*****	-0.7475
0.850	0.0515	-0.0265	-0.0388	-0.0922	-0.5514	-0.0388	-0.0922	-0.5514	0.0515	-0.0265
0.875	*****	-0.0106	-0.0353	-0.1069	-0.7461	-0.0106	-0.0353	-0.1069	*****	-0.7461
0.900	0.0915	0.0132	-0.0156	-0.0983	*****	-0.0156	-0.0983	*****	0.0915	0.0132
0.925	*****	0.0474	0.0083	-0.0720	-0.7014	0.0083	-0.0720	-0.7014	*****	-0.7014
0.950	0.1378	0.0851	0.0529	-0.0330	-0.3135	0.0529	-0.0330	-0.3135	0.1378	0.0851
0.975	*****	0.1384	0.1130	0.0450	-0.1381	0.1130	0.0450	-0.1381	*****	-0.1381
-0.200	-0.0253	-0.0018	0.0838	*****	-0.4079	0.0838	*****	-0.4079	-0.0253	-0.0018
-0.400	-0.0544	-0.0042	0.0415	-0.1023	-0.5595	0.0415	-0.1023	-0.5595	-0.0544	-0.0042
-0.600	*****	-0.0301	0.0114	-0.0851	-0.6635	0.0114	-0.0851	-0.6635	*****	-0.6635
-0.700	*****	-0.0675	-0.0157	-0.0879	-0.7309	-0.0157	-0.0879	-0.7309	*****	-0.7309
-0.800	-0.0306	-0.0981	-0.0639	-0.1057	-0.4112	-0.0639	-0.1057	-0.4112	-0.0306	-0.0981
-0.850	0.0033	-0.0827	-0.0924	-0.1365	-0.5103	-0.0924	-0.1365	-0.5103	0.0033	-0.0827
-0.900	0.0404	-0.0527	-0.0949	-0.1661	-0.9472	-0.0949	-0.1661	-0.9472	0.0404	-0.0527
-0.950	*****	*****	-0.0224	-0.1230	-0.3586	*****	-0.1230	-0.3586	*****	*****
-0.975	*****	0.0746	0.0294	-0.0424	-0.2060	0.0294	-0.0424	-0.2060	*****	0.0746

Sharp Radius L.E.
 Run No. = 93 , Point No. = 2055
 $C_N = -0.035$, $C_m = 0.0118$
 $\alpha = -0.6^\circ$, $M_\infty = 0.850$
 $R_{mac} = 36.2 \times 10^6$

Surface Pressures Near Leading Edge

● / ◆ upper, starboard/port
 ○ / ◇ lower, starboard/port

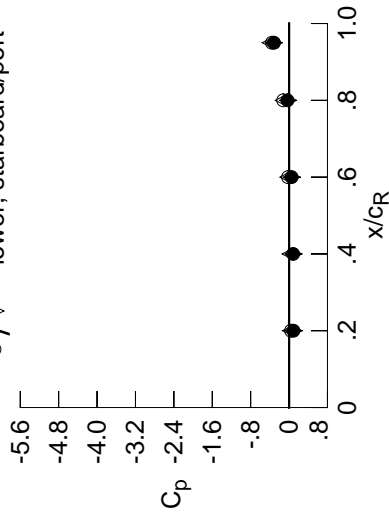

x/c_R	η	starb'd	port	starb'd	port
0.20	0.90	0.0915	0.0960	0.0406	0.0404
0.40	0.95	0.0851	0.0909	0.0306	*****
0.60	0.95	0.0529	0.0553	-0.0153	-0.0224
0.80	0.95	-0.0330	-0.0226	-0.1102	-0.1230
0.95	0.95	-0.3135	-0.3174	-0.3838	-0.3586

Surface Pressures

● upper, starboard
 ○ lower, port

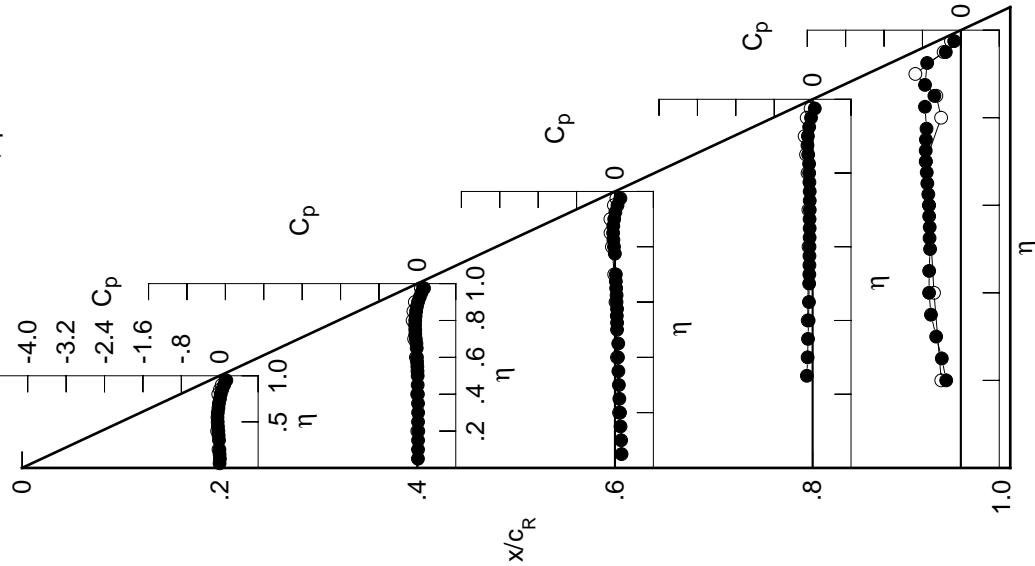

Table C3. Continued.

η	$x/c_R = .2$		$x/c_R = .4$		$x/c_R = .6$		$x/c_R = .8$		$x/c_R = .95$	
	$C_{p,u}$	$C_{p,l}$	$C_{p,u}$	$C_{p,l}$	$C_{p,u}$	$C_{p,l}$	$C_{p,u}$	$C_{p,l}$	$C_{p,u}$	$C_{p,l}$
0.050	-0.0098	0.0061	0.1311	*****	*****	*****	*****	*****	*****	*****
0.100	-0.0038	0.0070	0.1237	*****	*****	*****	*****	*****	*****	*****
0.150	-0.0108	0.0078	0.1102	*****	*****	*****	*****	*****	*****	*****
0.200	-0.0137	0.0117	0.1003	*****	*****	*****	*****	*****	*****	*****
0.250	*****	0.0070	0.0869	-0.1250	-0.3941	*****	*****	*****	*****	*****
0.300	-0.0224	0.0087	0.0758	-0.1079	-0.5096	*****	*****	*****	*****	*****
0.350	-0.0302	0.0067	0.0668	-0.0994	-0.6190	*****	*****	*****	*****	*****
0.400	-0.0356	0.0034	0.0561	-0.0880	-0.6609	*****	*****	*****	*****	*****
0.450	-0.0458	-0.0005	0.0624	-0.0828	-0.6588	*****	*****	*****	*****	*****
0.500	-0.0514	-0.0008	0.0364	-0.0766	-0.6319	*****	*****	*****	*****	*****
0.525	*****	-0.0053	0.0379	-0.0743	-0.6434	*****	*****	*****	*****	*****
0.550	-0.0572	-0.0089	0.0317	-0.0721	-0.6377	*****	*****	*****	*****	*****
0.575	*****	-0.0150	0.0360	-0.0710	-0.6505	*****	*****	*****	*****	*****
0.600	-0.0496	-0.0191	0.0244	-0.0713	-0.6515	*****	*****	*****	*****	*****
0.625	*****	*****	0.0254	-0.0677	-0.6619	*****	*****	*****	*****	*****
0.650	-0.0369	-0.0214	0.0176	-0.0671	-0.6850	*****	*****	*****	*****	*****
0.675	*****	-0.0298	0.0099	-0.0688	-0.6964	*****	*****	*****	*****	*****
0.700	-0.0290	-0.0439	0.0091	-0.0678	-0.7188	*****	*****	*****	*****	*****
0.725	*****	-0.0554	*****	-0.0678	-0.7273	*****	*****	*****	*****	*****
0.750	-0.0077	-0.0555	*****	-0.0687	-0.7299	*****	*****	*****	*****	*****
0.775	*****	-0.0627	-0.0115	-0.0753	-0.7185	*****	*****	*****	*****	*****
0.800	0.0091	-0.0591	-0.0311	-0.0813	*****	*****	*****	*****	*****	*****
0.825	*****	-0.0510	-0.0447	-0.0825	-0.7512	*****	*****	*****	*****	*****
0.850	0.0388	-0.0412	-0.0525	-0.1041	-0.5530	*****	*****	*****	*****	*****
0.875	*****	-0.0275	-0.0508	-0.1214	-0.7479	*****	*****	*****	*****	*****
0.900	0.0792	-0.0035	-0.0344	-0.1138	*****	*****	*****	*****	*****	*****
0.925	*****	0.0314	-0.0099	-0.0900	-0.7083	*****	*****	*****	*****	*****
0.950	0.1260	0.0690	0.0337	-0.0524	-0.3265	*****	*****	*****	*****	*****
0.975	*****	0.1219	0.0985	0.0252	-0.1529	*****	*****	*****	*****	*****

η	$x/c_R = .2$		$x/c_R = .4$		$x/c_R = .6$		$x/c_R = .8$		$x/c_R = .95$	
	$C_{p,u}$	$C_{p,l}$	$C_{p,u}$	$C_{p,l}$	$C_{p,u}$	$C_{p,l}$	$C_{p,u}$	$C_{p,l}$	$C_{p,u}$	$C_{p,l}$
-0.200	-0.0182	0.0061	0.0897	*****	*****	*****	*****	*****	*****	*****
-0.400	-0.0472	0.0030	0.0467	-0.0981	-0.5714	*****	*****	*****	*****	*****
-0.600	*****	-0.0216	0.0187	-0.0798	-0.6584	*****	*****	*****	*****	*****
-0.700	*****	-0.0567	-0.0080	-0.0815	-0.7175	*****	*****	*****	*****	*****
-0.800	-0.0173	-0.0837	-0.0524	-0.0959	-0.5126	*****	*****	*****	*****	*****
-0.850	0.0167	-0.0669	-0.0764	-0.1246	-0.5997	*****	*****	*****	*****	*****
-0.900	0.0525	-0.0344	-0.0765	-0.1486	-0.9381	*****	*****	*****	*****	*****
-0.950	*****	*****	-0.0018	-0.1003	-0.3455	*****	*****	*****	*****	*****
-0.975	*****	0.0938	0.0522	-0.0186	-0.1889	*****	*****	*****	*****	*****

Sharp Radius L.E.
 Run No. = 93 , Point No. = 2056
 $C_N = -0.022$, $C_m = 0.0094$
 $\alpha = -0.2^\circ$, $M_\infty = 0.849$
 $R_{mac} = 36.3 \times 10^6$

Surface Pressures Near Leading Edge

● / ◆ upper, starboard/port
 ○ / ◇ lower, starboard/port

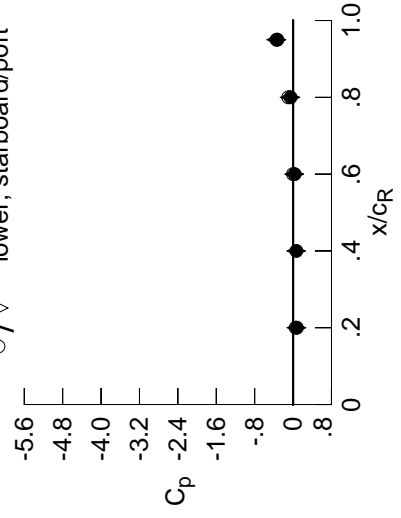

x/c_R	η	starb'd	port	starb'd	port
		$C_{p,u}$	$C_{p,l}$	$C_{p,u}$	$C_{p,l}$
0.20	0.90	0.0792	0.0839	0.0540	0.0525
0.40	0.95	0.0690	0.0755	0.0507	*****
0.60	0.95	0.0337	0.0382	0.0058	-0.0018
0.80	0.95	-0.0524	-0.0410	-0.0865	-0.1003
0.95	0.95	-0.3265	-0.3311	-0.3683	-0.3455

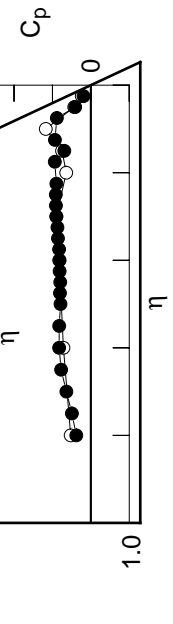

Table C3. Continued.

η	$x/c_R = .2$		$x/c_R = .4$		$x/c_R = .6$		$x/c_R = .8$		$x/c_R = .95$	
	$C_{p,u}$	$C_{p,l}$	$C_{p,u}$	$C_{p,l}$	$C_{p,u}$	$C_{p,l}$	$C_{p,u}$	$C_{p,l}$	$C_{p,u}$	$C_{p,l}$
0.050	-0.0291	-0.0123	0.1181	*****	*****	*****	*****	*****	*****	*****
0.100	-0.0242	-0.0107	0.1103	*****	*****	*****	*****	*****	*****	*****
0.150	-0.0315	-0.0109	0.0958	*****	*****	*****	*****	*****	*****	*****
0.200	-0.0351	-0.0074	0.0861	*****	*****	*****	*****	*****	*****	*****
0.250	*****	-0.0116	0.0721	-0.1367	-0.3734	*****	*****	*****	*****	*****
0.300	-0.0442	-0.0111	0.0614	-0.1209	-0.4639	*****	*****	*****	*****	*****
0.350	-0.0529	-0.0139	0.0506	-0.1126	-0.5436	*****	*****	*****	*****	*****
0.400	-0.0600	-0.0168	0.0427	-0.1023	-0.5747	*****	*****	*****	*****	*****
0.450	-0.0718	-0.0223	0.0453	-0.0959	-0.5681	*****	*****	*****	*****	*****
0.500	-0.0789	-0.0236	0.0187	-0.0914	-0.5325	*****	*****	*****	*****	*****
0.525	*****	-0.0284	0.0200	-0.0894	-0.5440	*****	*****	*****	*****	*****
0.550	-0.0855	-0.0338	0.0138	-0.0874	-0.5385	*****	*****	*****	*****	*****
0.575	*****	-0.0386	0.0171	-0.0870	-0.5526	*****	*****	*****	*****	*****
0.600	-0.0809	-0.0448	0.0041	-0.0885	-0.5551	*****	*****	*****	*****	*****
0.625	*****	*****	0.0053	-0.0853	-0.5748	*****	*****	*****	*****	*****
0.650	-0.0706	-0.0479	-0.0056	-0.0839	-0.6123	*****	*****	*****	*****	*****
0.675	*****	-0.0586	-0.0130	-0.0885	-0.6347	*****	*****	*****	*****	*****
0.700	-0.0628	-0.0744	-0.0152	-0.0870	-0.6713	*****	*****	*****	*****	*****
0.725	*****	-0.0884	*****	-0.0888	-0.6996	*****	*****	*****	*****	*****
0.750	-0.0441	-0.0929	*****	-0.0908	-0.7210	*****	*****	*****	*****	*****
0.775	*****	-0.1012	-0.0426	-0.1005	-0.7144	*****	*****	*****	*****	*****
0.800	-0.0291	-0.1017	-0.0668	-0.1114	*****	*****	*****	*****	*****	*****
0.825	*****	-0.0965	-0.0851	-0.1116	-0.7369	*****	*****	*****	*****	*****
0.850	-0.0001	-0.0899	-0.0973	-0.1398	-0.5441	*****	*****	*****	*****	*****
0.875	*****	-0.0778	-0.1007	-0.1639	-0.6424	*****	*****	*****	*****	*****
0.900	0.0404	-0.0549	-0.0887	-0.1654	*****	*****	*****	*****	*****	*****
0.925	*****	-0.0215	-0.0696	-0.1466	-0.7283	*****	*****	*****	*****	*****
0.950	0.0853	0.0172	-0.0256	-0.1153	-0.3657	*****	*****	*****	*****	*****
0.975	*****	0.0668	0.0351	-0.0394	-0.2029	*****	*****	*****	*****	*****
-0.200	$C_{p,l}$	0.0001	0.0207	0.1015	*****	-0.4248	*****	*****	*****	*****
-0.400	$C_{p,l}$	-0.0239	0.0205	0.0616	-0.0842	-0.5690	*****	*****	*****	*****
-0.600	$C_{p,l}$	*****	0.0022	0.0368	-0.0648	-0.6290	*****	*****	*****	*****
-0.700	$C_{p,l}$	*****	-0.0278	0.0158	-0.0628	-0.6919	*****	*****	*****	*****
-0.800	$C_{p,l}$	0.0188	-0.0434	-0.0211	-0.0696	-0.6610	*****	*****	*****	*****
-0.850	$C_{p,l}$	0.0529	-0.0237	-0.0355	-0.0910	-0.6960	*****	*****	*****	*****
-0.900	$C_{p,l}$	0.0889	0.0139	-0.0253	-0.1019	-0.8789	*****	*****	*****	*****
-0.950	$C_{p,l}$	*****	*****	0.0534	-0.0415	-0.3096	*****	*****	*****	*****
-0.975	$C_{p,l}$	*****	0.1405	0.1066	0.0394	-0.1442	*****	*****	*****	*****

Sharp Radius L.E.
 Run No. = 93, Point No. = 2057
 $C_N = 0.019$, $C_m = 0.0034$
 $\alpha = 0.8^\circ$, $M_\infty = 0.849$
 $R_{mac} = 36.3 \times 10^6$

Surface Pressures Near Leading Edge

● / ◆ upper, starboard/port
 ○ / ◇ lower, starboard/port

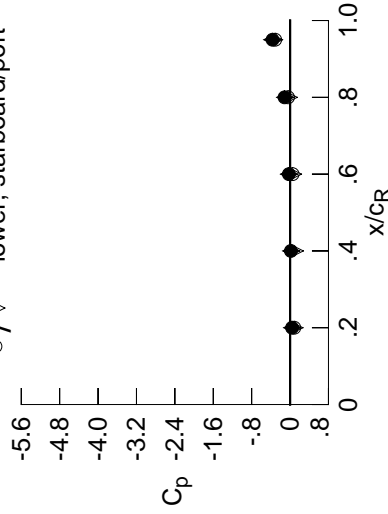

x/c_R	η	starb'd	port	starb'd	port
		$C_{p,u}$	$C_{p,l}$	$C_{p,u}$	$C_{p,l}$
0.20	0.90	0.0404	0.0440	0.0906	0.0889
0.40	0.95	0.0172	0.0237	0.0988	*****
0.60	0.95	-0.0256	-0.0213	0.0598	0.0534
0.80	0.95	-0.1153	-0.1016	-0.0283	-0.0415
0.95	0.95	-0.3657	-0.3716	-0.3328	-0.3096

Surface Pressures

● upper, starboard
 ○ lower, port

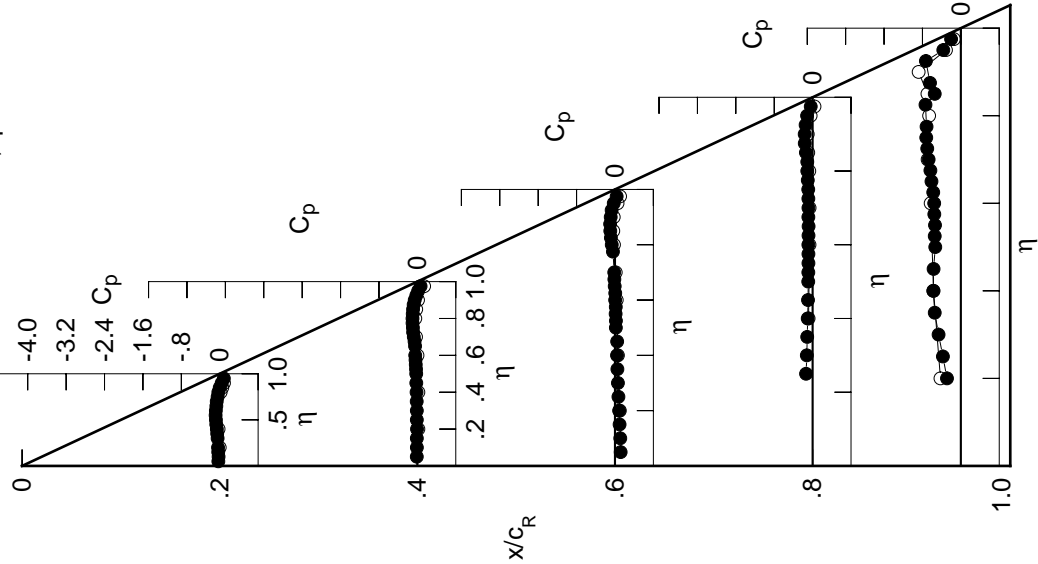

Table C3. Continued.

η	$x/c_R = .2$		$x/c_R = .4$		$x/c_R = .6$		$x/c_R = .8$		$x/c_R = .95$	
	$C_{p,u}$	$C_{p,l}$	$C_{p,u}$	$C_{p,l}$	$C_{p,u}$	$C_{p,l}$	$C_{p,u}$	$C_{p,l}$	$C_{p,u}$	$C_{p,l}$
0.050	-0.0483	-0.0281	0.1056	*****	*****	*****	*****	*****	*****	*****
0.100	-0.0439	-0.0265	0.0978	*****	*****	*****	*****	*****	*****	*****
0.150	-0.0517	-0.0290	0.0853	*****	*****	*****	*****	*****	*****	*****
0.200	-0.0560	-0.0232	0.0731	*****	*****	*****	*****	*****	*****	*****
0.250	*****	-0.0292	0.0597	-0.1487	-0.3581	*****	*****	*****	*****	*****
0.300	-0.0649	-0.0290	0.0477	-0.1318	-0.4508	*****	*****	*****	*****	*****
0.350	-0.0747	-0.0327	0.0368	-0.1244	-0.5576	*****	*****	*****	*****	*****
0.400	-0.0829	-0.0357	0.0265	-0.1141	-0.6289	*****	*****	*****	*****	*****
0.450	-0.0962	-0.0417	0.0300	-0.1096	-0.6387	*****	*****	*****	*****	*****
0.500	-0.1054	-0.0444	0.0035	-0.1055	-0.6037	*****	*****	*****	*****	*****
0.525	*****	-0.0497	0.0025	-0.1040	-0.6057	*****	*****	*****	*****	*****
0.550	-0.1137	-0.0560	-0.0030	-0.1027	-0.6024	*****	*****	*****	*****	*****
0.575	*****	-0.0637	-0.0023	-0.1019	-0.6137	*****	*****	*****	*****	*****
0.600	-0.1121	-0.0706	-0.0160	-0.1038	-0.6136	*****	*****	*****	*****	*****
0.625	*****	*****	-0.0151	-0.1017	-0.6189	*****	*****	*****	*****	*****
0.650	-0.1030	-0.0732	-0.0256	-0.1031	-0.6324	*****	*****	*****	*****	*****
0.675	*****	-0.0868	-0.0352	-0.1070	-0.6429	*****	*****	*****	*****	*****
0.700	-0.0977	-0.1050	-0.0408	-0.1074	-0.6636	*****	*****	*****	*****	*****
0.725	*****	-0.1225	*****	-0.1099	-0.6839	*****	*****	*****	*****	*****
0.750	-0.0815	-0.1283	*****	-0.1143	-0.7058	*****	*****	*****	*****	*****
0.775	*****	-0.1420	-0.0724	-0.1259	-0.7023	*****	*****	*****	*****	*****
0.800	-0.0697	-0.1441	-0.1000	-0.1374	*****	*****	*****	*****	*****	*****
0.825	*****	-0.1424	-0.1237	-0.1419	-0.6868	*****	*****	*****	*****	*****
0.850	-0.0418	-0.1377	-0.1420	-0.1760	-0.4536	*****	*****	*****	*****	*****
0.875	*****	-0.1294	-0.1520	-0.2090	-0.4640	*****	*****	*****	*****	*****
0.900	-0.0039	-0.1103	-0.1441	-0.2157	*****	*****	*****	*****	*****	*****
0.925	*****	-0.0792	-0.1291	-0.2064	-0.7476	*****	*****	*****	*****	*****
0.950	0.0380	-0.0414	-0.0894	-0.1833	-0.4089	*****	*****	*****	*****	*****
0.975	*****	0.0110	-0.0288	-0.1132	-0.2580	*****	*****	*****	*****	*****

η	$x/c_R = .2$		$x/c_R = .4$		$x/c_R = .6$		$x/c_R = .8$		$x/c_R = .95$	
	$C_{p,u}$	$C_{p,l}$	$C_{p,u}$	$C_{p,l}$	$C_{p,u}$	$C_{p,l}$	$C_{p,u}$	$C_{p,l}$	$C_{p,u}$	$C_{p,l}$
-0.200	0.0233	0.0412	0.1167	*****	-0.4597	*****	*****	*****	*****	*****
-0.400	0.0006	0.0414	0.0774	-0.0700	-0.6456	*****	*****	*****	*****	*****
-0.600	*****	0.0288	0.0567	-0.0483	-0.7192	*****	*****	*****	*****	*****
-0.700	*****	0.0023	0.0393	-0.0424	-0.7294	*****	*****	*****	*****	*****
-0.800	0.0553	-0.0030	0.0116	-0.0434	-0.6911	*****	*****	*****	*****	*****
-0.850	0.0882	0.0191	0.0056	-0.0578	-0.6995	*****	*****	*****	*****	*****
-0.900	0.1238	0.0601	0.0226	-0.0569	-0.8123	*****	*****	*****	*****	*****
-0.950	*****	*****	0.1016	0.0099	-0.2783	*****	*****	*****	*****	*****
-0.975	*****	0.1773	0.1500	0.0867	-0.1087	*****	*****	*****	*****	*****

Sharp Radius L.E.
 Run No. = 93, Point No. = 2058
 $C_N = 0.063$, $C_m = -0.0056$
 $\alpha = 1.9^\circ$, $M_\infty = 0.850$
 $R_{mac} = 36.2 \times 10^6$

Surface Pressures Near Leading Edge

● / ◆ upper, starboard/port
 ○ / ◇ lower, starboard/port

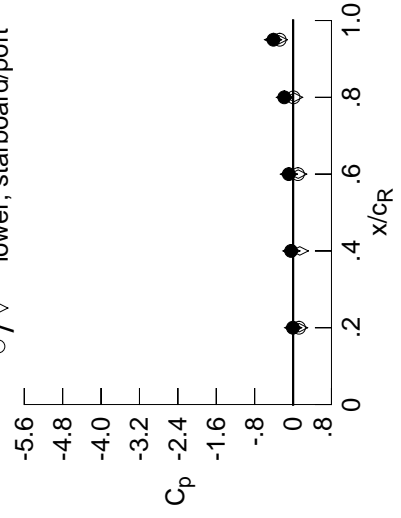

x/c_R	η	starb'd	port	$C_{p,u}$	starb'd	port	$C_{p,l}$
0.20	0.90	-0.0039	0.0026	0.1257	0.1238	0.1257	0.1238
0.40	0.95	-0.0414	-0.0349	0.1401	*****	0.1401	*****
0.60	0.95	-0.0894	-0.0863	0.1065	0.1016	0.1065	0.1016
0.80	0.95	-0.1833	-0.1698	0.0220	0.0099	0.0220	0.0099
0.95	0.95	-0.4089	-0.4158	-0.2975	-0.2783	-0.2975	-0.2783

Table C3. Continued.

η	$x/c_R = .2$		$x/c_R = .4$		$x/c_R = .6$		$x/c_R = .8$		$x/c_R = .95$	
	$C_{p,u}$	$C_{p,l}$	$C_{p,u}$	$C_{p,l}$	$C_{p,u}$	$C_{p,l}$	$C_{p,u}$	$C_{p,l}$	$C_{p,u}$	$C_{p,l}$
0.050	-0.0668	-0.0440	0.0943	0.0853	0.0943	0.0853	0.0943	0.0853	0.0943	0.0853
0.100	-0.0632	-0.0448	0.0853	0.0720	0.0853	0.0720	0.0853	0.0720	0.0853	0.0720
0.150	-0.0713	-0.0444	0.0720	0.0607	0.0720	0.0607	0.0720	0.0607	0.0720	0.0607
0.200	-0.0758	-0.0422	0.0607	0.0471	0.0607	0.0471	0.0607	0.0471	0.0607	0.0471
0.250	*****	-0.0471	0.0467	0.0338	0.0467	0.0338	0.0467	0.0338	0.0467	0.0338
0.300	-0.0823	-0.0477	0.0338	0.0218	0.0338	0.0218	0.0338	0.0218	0.0338	0.0218
0.350	-0.0947	-0.0515	0.0218	0.0122	0.0218	0.0122	0.0218	0.0122	0.0218	0.0122
0.400	-0.1037	-0.0555	0.0122	0.0148	0.0122	0.0148	0.0122	0.0148	0.0122	0.0148
0.450	-0.1194	-0.0632	0.0148	-0.0135	0.0148	-0.0135	0.0148	-0.0135	0.0148	-0.0135
0.500	-0.1294	-0.0646	-0.0135	-0.0733	-0.0135	-0.0733	-0.0135	-0.0733	-0.0135	-0.0733
0.525	*****	-0.0733	-0.0163	-0.1400	-0.0163	-0.1400	-0.0163	-0.1400	-0.0163	-0.1400
0.550	-0.1400	-0.0794	-0.0218	-0.0884	-0.0218	-0.0884	-0.0218	-0.0884	-0.0218	-0.0884
0.575	*****	-0.0884	-0.0210	-0.1402	-0.0210	-0.1402	-0.0210	-0.1402	-0.0210	-0.1402
0.600	-0.1402	-0.0954	-0.0356	*****	-0.0356	*****	-0.0356	*****	-0.0356	*****
0.625	*****	*****	-0.0371	-0.1364	-0.0371	-0.1364	-0.0371	-0.1364	-0.0371	-0.1364
0.650	-0.1364	-0.0999	-0.0483	-0.1557	-0.0483	-0.1557	-0.0483	-0.1557	-0.0483	-0.1557
0.675	*****	-0.1156	-0.0588	-0.1180	-0.0588	-0.1180	-0.0588	-0.1180	-0.0588	-0.1180
0.700	-0.1332	-0.1364	-0.0649	-0.1825	-0.0649	-0.1825	-0.0649	-0.1825	-0.0649	-0.1825
0.725	*****	-0.1557	*****	-0.1876	*****	-0.1876	*****	-0.1876	*****	-0.1876
0.750	-0.1180	-0.1648	*****	-0.1881	*****	-0.1881	*****	-0.1881	*****	-0.1881
0.775	*****	-0.1825	-0.1029	-0.1867	-0.1029	-0.1867	-0.1029	-0.1867	-0.1029	-0.1867
0.800	-0.1078	-0.1876	-0.1333	-0.1822	-0.1333	-0.1822	-0.1333	-0.1822	-0.1333	-0.1822
0.825	*****	-0.1881	-0.1617	-0.1632	-0.1617	-0.1632	-0.1617	-0.1632	-0.1617	-0.1632
0.850	-0.0814	-0.1867	-0.1855	-0.1320	-0.1855	-0.1320	-0.1855	-0.1320	-0.1855	-0.1320
0.875	*****	-0.1822	-0.2006	-0.0858	-0.2006	-0.0858	-0.2006	-0.0858	-0.2006	-0.0858
0.900	-0.0447	-0.1632	-0.1985	-0.0117	-0.1985	-0.0117	-0.1985	-0.0117	-0.1985	-0.0117
0.925	*****	-0.1320	-0.1865	-0.0117	-0.1865	-0.0117	-0.1865	-0.0117	-0.1865	-0.0117
0.950	-0.0117	-0.0858	-0.1404	-0.0117	-0.1404	-0.0117	-0.1404	-0.0117	-0.1404	-0.0117
0.975	*****	-0.1315	-0.1598	-0.0117	-0.1598	-0.0117	-0.1598	-0.0117	-0.1598	-0.0117
-0.200	0.0446	0.0584	0.1297	0.0446	0.1297	0.0446	0.1297	0.0446	0.1297	0.0446
-0.400	0.0261	0.0608	0.0922	0.0261	0.0922	0.0261	0.0922	0.0261	0.0922	0.0261
-0.600	*****	0.0528	0.0750	0.0528	0.0750	0.0528	0.0750	0.0528	0.0750	0.0528
-0.700	*****	0.0320	0.0606	0.0320	0.0606	0.0320	0.0606	0.0320	0.0606	0.0320
-0.800	0.0896	0.0344	0.0423	0.0896	0.0344	0.0423	0.0896	0.0344	0.0423	0.0896
-0.850	0.1216	0.0576	0.0415	0.1216	0.0576	0.0415	0.1216	0.0576	0.0415	0.1216
-0.900	0.1555	0.0998	0.0651	0.1555	0.0998	0.0651	0.1555	0.0998	0.0651	0.1555
-0.950	*****	0.1406	0.0528	0.1406	0.0528	0.1406	0.0528	0.1406	0.0528	0.1406
-0.975	*****	0.2020	0.1791	0.2020	0.1791	0.2020	0.1791	0.2020	0.1791	0.2020

Sharp Radius L.E.
 Run No. = 93 , Point No. = 2059
 $C_N = 0.103$, $C_m = -0.0119$
 $\alpha = 3.0^\circ$, $M_\infty = 0.850$
 $R_{mac} = 36.3 \times 10^6$

Surface Pressures Near Leading Edge

● / ◆ upper, starboard/port
 ○ / ◇ lower, starboard/port

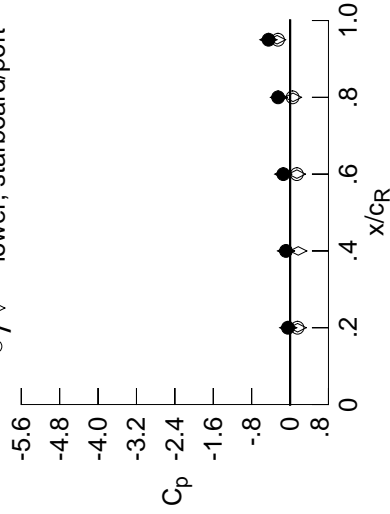

x/c_R	η	starb'd	port	starb'd	port
0.20	0.90	-0.0447	-0.0384	0.1576	0.1555
0.40	0.95	-0.0858	-0.0840	0.1706	*****
0.60	0.95	-0.1404	-0.1423	0.1426	0.1406
0.80	0.95	-0.2494	-0.2319	0.0618	0.0528
0.95	0.95	-0.4492	-0.4521	-0.2696	-0.2510

Surface Pressures

● upper, starboard
 ○ lower, port

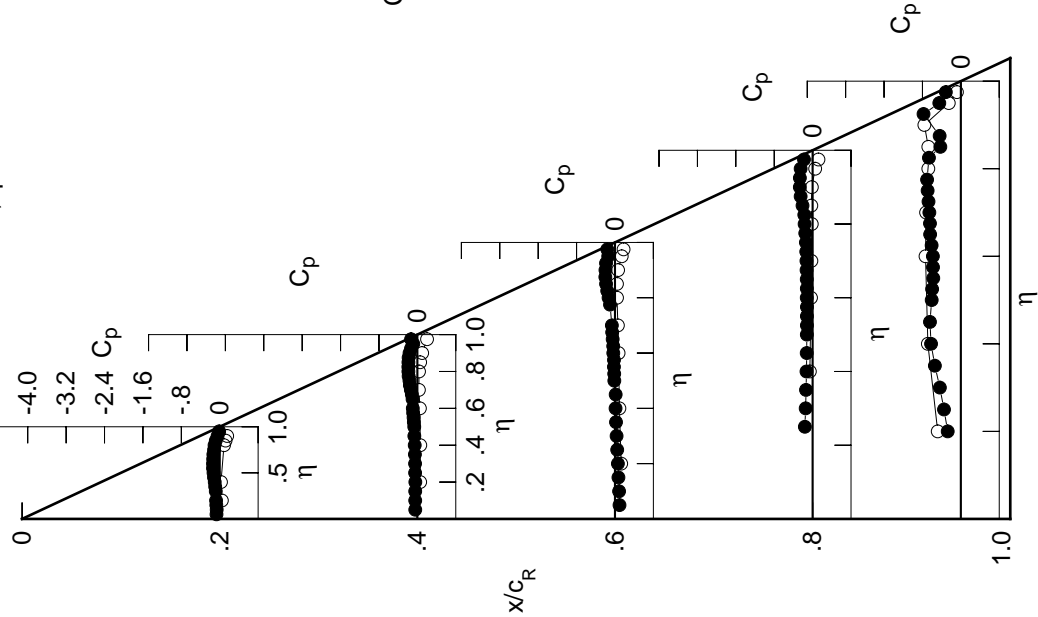

Table C3. Continued.

η	$x/c_R = .2$		$x/c_R = .4$		$x/c_R = .6$		$x/c_R = .8$		$x/c_R = .95$	
	$C_{p,u}$	$C_{p,l}$	$C_{p,u}$	$C_{p,l}$	$C_{p,u}$	$C_{p,l}$	$C_{p,u}$	$C_{p,l}$	$C_{p,u}$	$C_{p,l}$
0.050	-0.0843	-0.0610	0.0826	0.0826	0.0826	0.0826	0.0826	0.0826	0.0826	0.0826
0.100	-0.0817	-0.0603	0.0747	0.0747	0.0747	0.0747	0.0747	0.0747	0.0747	0.0747
0.150	-0.0895	-0.0606	0.0607	0.0607	0.0607	0.0607	0.0607	0.0607	0.0607	0.0607
0.200	-0.0947	-0.0566	0.0497	0.0497	0.0497	0.0497	0.0497	0.0497	0.0497	0.0497
0.250	*****	-0.0638	0.0354	-0.1734	-0.3401	0.0354	-0.1734	-0.3401	0.0354	-0.1734
0.300	-0.1018	-0.0627	0.0214	-0.1571	-0.4023	0.0214	-0.1571	-0.4023	0.0214	-0.1571
0.350	-0.1152	-0.0688	0.0097	-0.1489	-0.4861	0.0097	-0.1489	-0.4861	0.0097	-0.1489
0.400	-0.1250	-0.0740	-0.0017	-0.1390	-0.5687	-0.0017	-0.1390	-0.5687	-0.0017	-0.1390
0.450	-0.1427	-0.0848	-0.0006	-0.1361	-0.5959	-0.0006	-0.1361	-0.5959	-0.0006	-0.1361
0.500	-0.1547	-0.0854	-0.0301	-0.1352	-0.5873	-0.0301	-0.1352	-0.5873	-0.0301	-0.1352
0.525	*****	-0.0961	-0.0333	-0.1342	-0.5880	-0.0333	-0.1342	-0.5880	-0.0333	-0.1342
0.550	-0.1670	-0.1004	-0.0407	-0.1340	-0.5659	-0.0407	-0.1340	-0.5659	-0.0407	-0.1340
0.575	*****	-0.1107	-0.0405	-0.1353	-0.5710	-0.0405	-0.1353	-0.5710	-0.0405	-0.1353
0.600	-0.1687	-0.1198	-0.0557	-0.1395	-0.5732	-0.0557	-0.1395	-0.5732	-0.0557	-0.1395
0.625	*****	*****	-0.0588	-0.1360	-0.6011	-0.0588	-0.1360	-0.6011	-0.0588	-0.1360
0.650	-0.1697	-0.1256	-0.0697	-0.1399	-0.6391	-0.0697	-0.1399	-0.6391	-0.0697	-0.1399
0.675	*****	-0.1433	-0.0822	-0.1468	-0.6437	-0.0822	-0.1468	-0.6437	-0.0822	-0.1468
0.700	-0.1679	-0.1666	-0.0892	-0.1497	-0.6724	-0.0892	-0.1497	-0.6724	-0.0892	-0.1497
0.725	*****	-0.1881	*****	-0.1557	-0.7167	-0.1881	*****	-0.1557	-0.7167	*****
0.750	-0.1545	-0.2011	*****	-0.1637	-0.7416	-0.1545	-0.2011	*****	-0.1637	-0.7416
0.775	*****	-0.2213	-0.1320	-0.1811	-0.7385	-0.2213	-0.1320	-0.1811	-0.7385	*****
0.800	-0.1468	-0.2281	-0.1648	-0.1969	*****	-0.1468	-0.2281	-0.1648	-0.1969	*****
0.825	*****	-0.2317	-0.1972	-0.2029	-0.6972	-0.2317	-0.1972	-0.2029	-0.6972	*****
0.850	-0.1214	-0.2326	-0.2235	-0.2442	-0.4601	-0.1214	-0.2326	-0.2235	-0.2442	-0.4601
0.875	*****	-0.2270	-0.2413	-0.2887	-0.4550	-0.2270	-0.2413	-0.2887	-0.4550	*****
0.900	-0.0803	-0.2034	-0.2397	-0.3078	*****	-0.0803	-0.2034	-0.2397	-0.3078	*****
0.925	*****	-0.1645	-0.2173	-0.3141	-0.8091	-0.1645	-0.2173	-0.3141	-0.8091	*****
0.950	-0.0651	-0.2065	-0.2423	-0.2936	-0.4863	-0.0651	-0.2065	-0.2423	-0.2936	-0.4863
0.975	*****	-0.3741	-0.4451	-0.3975	-0.4222	-0.3741	-0.4451	-0.3975	-0.4222	*****
-0.200	0.0697	0.0792	0.1470	*****	-0.4823	0.0697	0.0792	0.1470	*****	-0.4823
-0.400	0.0532	0.0836	0.1107	-0.0412	-0.7161	0.0532	0.0836	0.1107	-0.0412	-0.7161
-0.600	*****	0.0792	0.0957	-0.0150	-0.7262	0.0792	0.0957	-0.0150	-0.7262	*****
-0.700	*****	0.0628	0.0841	-0.0050	-0.7128	0.0628	0.0841	-0.0050	-0.7128	*****
-0.800	0.1238	0.0717	0.0734	0.0071	-0.6601	0.1238	0.0717	0.0734	0.0071	-0.6601
-0.850	0.1536	0.0944	0.0779	0.0039	-0.6573	0.1536	0.0944	0.0779	0.0039	-0.6573
-0.900	0.1848	0.1379	0.1044	0.0216	-0.7122	0.1848	0.1379	0.1044	0.0216	-0.7122
-0.950	*****	*****	0.1733	0.0894	-0.2274	0.1733	0.0894	0.1733	0.0894	-0.2274
-0.975	*****	0.2182	0.2004	0.1466	-0.0605	0.2182	0.2004	0.1466	-0.0605	*****

Sharp Radius L.E.
 Run No. = 93 , Point No. = 2060
 $C_N = 0.149$, $C_m = -0.0204$
 $\alpha = 4.0^\circ$, $M_\infty = 0.847$
 $R_{mac} = 36.2 \times 10^6$

Surface Pressures Near Leading Edge

● / ◆ upper, starboard/port
 ○ / ◇ lower, starboard/port

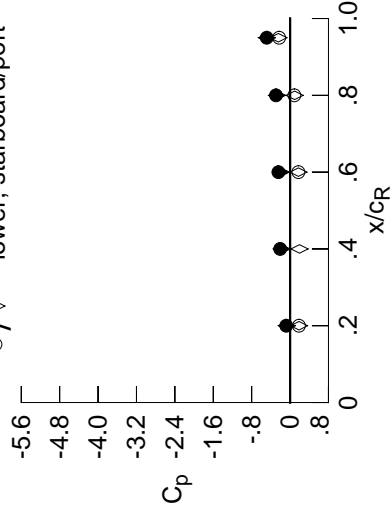

x/c_R	η	starb'd	port	starb'd	port
		$C_{p,u}$	$C_{p,l}$	$C_{p,u}$	$C_{p,l}$
0.20	0.90	-0.0803	-0.0707	0.1861	0.1848
0.40	0.95	-0.2065	-0.1755	0.1968	*****
0.60	0.95	-0.2423	-0.1919	0.1736	0.1733
0.80	0.95	-0.2936	-0.2717	0.0952	0.0894
0.95	0.95	-0.4863	-0.4850	-0.2438	-0.2274

Table C3. Continued.

η	$x/c_R = .2$		$x/c_R = .4$		$x/c_R = .6$		$x/c_R = .8$		$x/c_R = .95$	
	$C_{p,u}$	$C_{p,i}$	$C_{p,u}$	$C_{p,i}$	$C_{p,u}$	$C_{p,i}$	$C_{p,u}$	$C_{p,i}$	$C_{p,u}$	$C_{p,i}$
0.050	-0.1050	-0.0785	0.0703	0.0703	0.0703	0.0703	0.0703	0.0703	0.0703	0.0703
0.100	-0.1027	-0.0783	0.0604	0.0604	0.0604	0.0604	0.0604	0.0604	0.0604	0.0604
0.150	-0.1104	-0.0812	0.0472	0.0472	0.0472	0.0472	0.0472	0.0472	0.0472	0.0472
0.200	-0.1174	-0.0749	0.0331	0.0331	0.0331	0.0331	0.0331	0.0331	0.0331	0.0331
0.250	*****	-0.0845	0.0211	-0.1883	-0.1883	-0.1883	-0.1883	-0.1883	-0.1883	-0.1883
0.300	-0.1240	-0.0816	0.0054	-0.1741	-0.1741	-0.1741	-0.1741	-0.1741	-0.1741	-0.1741
0.350	-0.1372	-0.0911	-0.0072	-0.1657	-0.1657	-0.1657	-0.1657	-0.1657	-0.1657	-0.1657
0.400	-0.1496	-0.0951	-0.0179	-0.1562	-0.1562	-0.1562	-0.1562	-0.1562	-0.1562	-0.1562
0.450	-0.1678	-0.1088	-0.0176	-0.1536	-0.1536	-0.1536	-0.1536	-0.1536	-0.1536	-0.1536
0.500	-0.1822	-0.1121	-0.0482	-0.1531	-0.1531	-0.1531	-0.1531	-0.1531	-0.1531	-0.1531
0.525	*****	-0.1198	-0.0528	-0.1540	-0.1540	-0.1540	-0.1540	-0.1540	-0.1540	-0.1540
0.550	-0.1966	-0.1272	-0.0621	-0.1522	-0.1522	-0.1522	-0.1522	-0.1522	-0.1522	-0.1522
0.575	*****	-0.1345	-0.0601	-0.1558	-0.1558	-0.1558	-0.1558	-0.1558	-0.1558	-0.1558
0.600	-0.1987	-0.1461	-0.0798	-0.1602	-0.1602	-0.1602	-0.1602	-0.1602	-0.1602	-0.1602
0.625	*****	*****	-0.0817	-0.1599	-0.1599	-0.1599	-0.1599	-0.1599	-0.1599	-0.1599
0.650	-0.2011	-0.1557	-0.0940	-0.1618	-0.1618	-0.1618	-0.1618	-0.1618	-0.1618	-0.1618
0.675	*****	-0.1738	-0.1068	-0.1694	-0.1694	-0.1694	-0.1694	-0.1694	-0.1694	-0.1694
0.700	-0.2031	-0.1987	-0.1146	-0.1719	-0.1719	-0.1719	-0.1719	-0.1719	-0.1719	-0.1719
0.725	*****	-0.2229	*****	-0.1811	-0.17674	-0.17674	-0.17674	-0.17674	-0.17674	-0.17674
0.750	-0.1900	-0.2372	*****	-0.1903	-0.1903	-0.1903	-0.1903	-0.1903	-0.1903	-0.1903
0.775	*****	-0.2583	-0.1615	-0.2170	-0.2170	-0.2170	-0.2170	-0.2170	-0.2170	-0.2170
0.800	-0.1826	-0.2670	-0.1952	-0.2342	-0.2342	-0.2342	-0.2342	-0.2342	-0.2342	-0.2342
0.825	*****	-0.2691	-0.2274	-0.2356	-0.2356	-0.2356	-0.2356	-0.2356	-0.2356	-0.2356
0.850	-0.1505	-0.2700	-0.2511	-0.2810	-0.2810	-0.2810	-0.2810	-0.2810	-0.2810	-0.2810
0.875	*****	-0.2540	-0.2606	-0.3160	-0.3160	-0.3160	-0.3160	-0.3160	-0.3160	-0.3160
0.900	-0.1313	-0.2352	-0.2745	-0.3294	-0.3294	-0.3294	-0.3294	-0.3294	-0.3294	-0.3294
0.925	*****	-0.3170	-0.3720	-0.3942	-0.3942	-0.3942	-0.3942	-0.3942	-0.3942	-0.3942
0.950	-0.1328	-0.4879	-0.5402	-0.5295	-0.5295	-0.5295	-0.5295	-0.5295	-0.5295	-0.5295
0.975	*****	-0.4923	-0.5627	-0.6281	-0.6281	-0.6281	-0.6281	-0.6281	-0.6281	-0.6281
-0.200	0.0913	0.0978	0.1595	0.1595	0.1595	0.1595	0.1595	0.1595	0.1595	0.1595
-0.400	0.0768	0.1030	0.1262	-0.0269	-0.0269	-0.0269	-0.0269	-0.0269	-0.0269	-0.0269
-0.600	*****	0.1018	0.1125	0.0006	0.0006	0.0006	0.0006	0.0006	0.0006	0.0006
-0.700	*****	0.0894	0.1060	0.0119	0.0119	0.0119	0.0119	0.0119	0.0119	0.0119
-0.800	0.1511	0.1025	0.0985	0.0276	0.0276	0.0276	0.0276	0.0276	0.0276	0.0276
-0.850	0.1794	0.1248	0.1075	0.0284	0.0284	0.0284	0.0284	0.0284	0.0284	0.0284
-0.900	0.2059	0.1657	0.1348	0.0511	0.0511	0.0511	0.0511	0.0511	0.0511	0.0511
-0.950	*****	*****	0.1950	0.1162	0.1162	0.1162	0.1162	0.1162	0.1162	0.1162
-0.975	*****	0.2226	0.2077	0.1595	0.1595	0.1595	0.1595	0.1595	0.1595	0.1595

Sharp Radius L.E.

Run No. = 93, Point No. = 2061

$C_N = 0.198$, $C_m = -0.0310$

$\alpha = 5.1^\circ$, $M_\infty = 0.850$

$R_{mac} = 36.0 \times 10^6$

Surface Pressures Near Leading Edge

● / ◆ upper, starboard/port
○ / ◇ lower, starboard/port

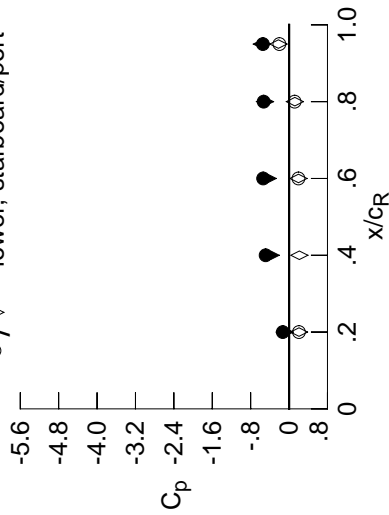

x/c_R	η	starb'd	port	starb'd	port
0.20	0.90	-0.1313	-0.0905	0.2068	0.2059
0.40	0.95	-0.4879	-0.3823	0.2143	*****
0.60	0.95	-0.5402	-0.4449	0.1958	0.1950
0.80	0.95	-0.5295	-0.5010	0.1206	0.1162
0.95	0.95	-0.5455	-0.5680	-0.2218	-0.2013

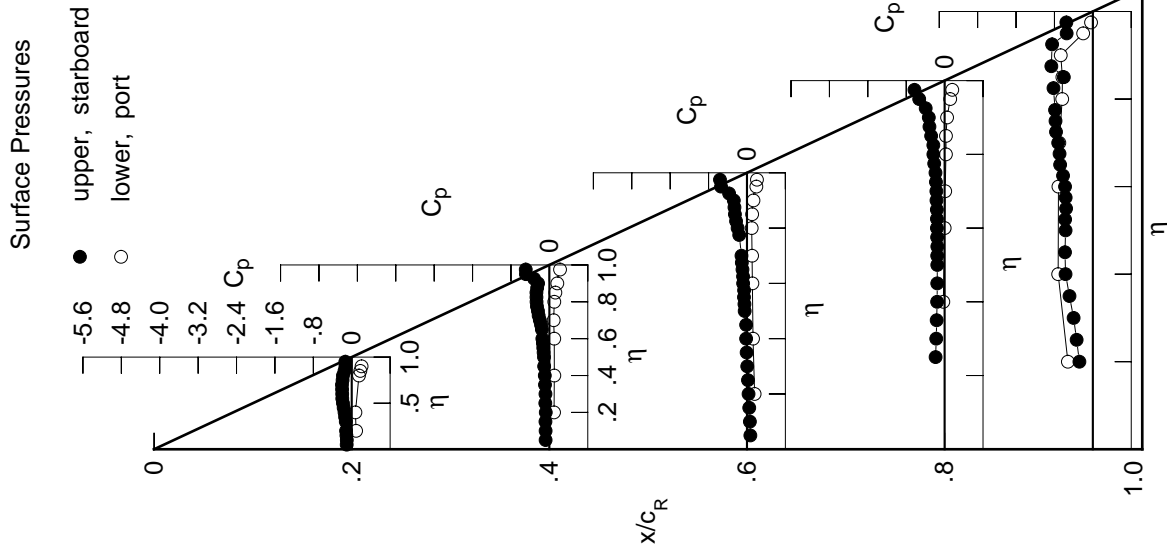

Table C3. Continued.

η	$x/c_R = .2$		$x/c_R = .4$		$x/c_R = .6$		$x/c_R = .8$		$x/c_R = .95$	
	$C_{p,u}$	$C_{p,l}$	$C_{p,u}$	$C_{p,l}$	$C_{p,u}$	$C_{p,l}$	$C_{p,u}$	$C_{p,l}$	$C_{p,u}$	$C_{p,l}$
0.050	-0.1242	-0.0972	0.0558	0.0558	0.0558	0.0558	0.0558	0.0558	0.0558	0.0558
0.100	-0.1228	-0.0972	0.0455	0.0455	0.0455	0.0455	0.0455	0.0455	0.0455	0.0455
0.150	-0.1308	-0.0992	0.0323	0.0323	0.0323	0.0323	0.0323	0.0323	0.0323	0.0323
0.200	-0.1376	-0.0946	0.0169	0.0169	0.0169	0.0169	0.0169	0.0169	0.0169	0.0169
0.250	*****	-0.1032	0.0060	-0.2074	-0.3454	0.0060	-0.2074	-0.3454	0.0060	-0.2074
0.300	-0.1452	-0.1057	-0.0139	-0.1923	-0.3746	-0.1452	-0.1057	-0.1923	-0.3746	-0.1452
0.350	-0.1601	-0.1121	-0.0264	-0.1836	-0.4049	-0.1601	-0.1121	-0.1836	-0.4049	-0.1601
0.400	-0.1727	-0.1208	-0.0377	-0.1743	-0.4499	-0.1727	-0.1208	-0.1743	-0.4499	-0.1727
0.450	-0.1921	-0.1327	-0.0336	-0.1730	-0.4614	-0.1921	-0.1327	-0.1730	-0.4614	-0.1921
0.500	-0.2082	-0.1357	-0.0678	-0.1738	-0.4554	-0.2082	-0.1357	-0.1738	-0.4554	-0.2082
0.525	*****	-0.1440	-0.0725	-0.1734	-0.4682	*****	-0.1440	-0.0725	-0.1734	-0.4682
0.550	-0.2237	-0.1509	-0.0819	-0.1721	-0.4733	-0.2237	-0.1509	-0.1721	-0.4733	-0.2237
0.575	*****	-0.1618	-0.0802	-0.1742	-0.5265	*****	-0.1618	-0.0802	-0.1742	-0.5265
0.600	-0.2271	-0.1707	-0.1013	-0.1775	-0.5923	-0.2271	-0.1707	-0.1775	-0.5923	-0.2271
0.625	*****	*****	-0.1057	-0.1747	-0.6964	*****	*****	-0.1057	-0.1747	-0.6964
0.650	-0.2325	-0.1821	-0.1157	-0.1752	-0.7817	-0.2325	-0.1821	-0.1752	-0.7817	-0.2325
0.675	*****	-0.2049	-0.1274	-0.1791	-0.7906	*****	-0.2049	-0.1274	-0.1791	-0.7906
0.700	-0.2341	-0.2275	-0.1372	-0.1801	-0.7904	-0.2341	-0.2275	-0.1372	-0.1801	-0.7904
0.725	*****	-0.2529	*****	-0.1791	-0.7788	*****	-0.2529	*****	-0.1791	-0.7788
0.750	-0.2191	-0.2669	*****	-0.1807	-0.7688	-0.2191	-0.2669	*****	-0.1807	-0.7688
0.775	*****	-0.2880	-0.1805	-0.2192	-0.7907	*****	-0.2880	-0.1805	-0.2192	-0.7907
0.800	-0.2019	-0.2905	-0.2103	-0.2970	*****	-0.2019	-0.2905	-0.2103	-0.2970	*****
0.825	*****	-0.2895	-0.2398	-0.3558	-0.8845	*****	-0.2895	-0.2398	-0.3558	-0.8845
0.850	-0.1635	-0.2950	-0.2893	-0.4590	-0.7723	-0.1635	-0.2950	-0.2893	-0.4590	-0.7723
0.875	*****	-0.3180	-0.4121	-0.5371	-0.8438	*****	-0.3180	-0.4121	-0.5371	-0.8438
0.900	-0.3384	-0.4511	-0.5515	-0.5779	*****	-0.3384	-0.4511	-0.5515	-0.5779	*****
0.925	*****	-0.5860	-0.6398	-0.6079	-0.7250	*****	-0.5860	-0.6398	-0.6079	-0.7250
0.950	-0.2051	-0.6314	-0.6541	-0.6105	-0.5603	-0.2051	-0.6314	-0.6541	-0.6105	-0.5603
0.975	*****	-0.6058	-0.6294	-0.6001	-0.4351	*****	-0.6058	-0.6294	-0.6001	-0.4351

η	$x/c_R = .2$		$x/c_R = .4$		$x/c_R = .6$		$x/c_R = .8$		$x/c_R = .95$	
	$C_{p,u}$	$C_{p,l}$	$C_{p,u}$	$C_{p,l}$	$C_{p,u}$	$C_{p,l}$	$C_{p,u}$	$C_{p,l}$	$C_{p,u}$	$C_{p,l}$
-0.200	0.1134	0.1171	0.1745	0.1745	0.1745	0.1745	0.1745	0.1745	0.1745	0.1745
-0.400	0.1013	0.1224	0.1413	-0.0135	-0.7129	0.1013	0.1224	0.1413	-0.0135	-0.7129
-0.600	*****	0.1250	0.1314	0.0159	-0.7024	*****	0.1250	0.1314	0.0159	-0.7024
-0.700	*****	0.1157	0.1254	0.0289	-0.6831	*****	0.1157	0.1254	0.0289	-0.6831
-0.800	0.1786	0.1321	0.1228	0.0481	-0.6225	0.1786	0.1321	0.1228	0.0481	-0.6225
-0.850	0.2036	0.1529	0.1350	0.0527	-0.6124	0.2036	0.1529	0.1350	0.0527	-0.6124
-0.900	0.2254	0.1923	0.1616	0.0776	-0.6331	0.2254	0.1923	0.1616	0.0776	-0.6331
-0.950	*****	*****	0.2129	0.1376	-0.1833	*****	*****	0.2129	0.1376	-0.1833
-0.975	*****	0.2239	0.2107	0.1671	-0.0267	*****	0.2239	0.2107	0.1671	-0.0267

Sharp Radius L.E.
 Run No. = 93, Point No. = 2062
 $C_N = 0.252$, $C_m = -0.0434$
 $\alpha = 6.1^\circ$, $M_\infty = 0.849$
 $R_{mac} = 36.2 \times 10^6$

Surface Pressures Near Leading Edge

● / ◆ upper, starboard/port
 ○ / ◇ lower, starboard/port

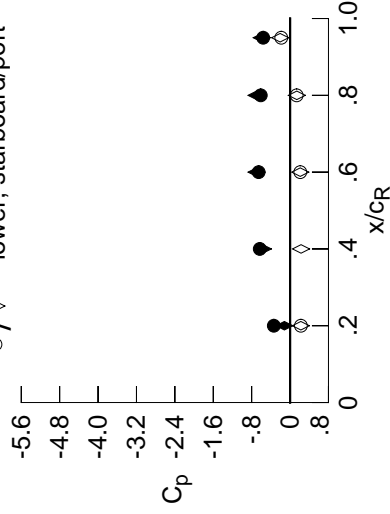

x/c_R	η	starb'd	port	starb'd	port
x/c_R	η	$C_{p,u}$	$C_{p,l}$	$C_{p,u}$	$C_{p,l}$
0.20	0.90	-0.3384	-0.1183	0.2251	0.2254
0.40	0.95	-0.6314	-0.5667	0.2287	*****
0.60	0.95	-0.6541	-0.6990	0.2122	0.2129
0.80	0.95	-0.6105	-0.6995	0.1411	0.1376
0.95	0.95	-0.5603	-0.5911	-0.2071	-0.1833

Table C3. Continued.

η	$x/c_R = .2$		$x/c_R = .4$		$x/c_R = .6$		$x/c_R = .8$		$x/c_R = .95$	
	$C_{p,u}$	$C_{p,l}$	$C_{p,u}$	$C_{p,l}$	$C_{p,u}$	$C_{p,l}$	$C_{p,u}$	$C_{p,l}$	$C_{p,u}$	$C_{p,l}$
0.050	-0.1438	-0.1174	0.0394	0.0394	0.0394	0.0394	0.0394	0.0394	0.0394	0.0394
0.100	-0.1437	-0.1176	0.0302	0.0302	0.0302	0.0302	0.0302	0.0302	0.0302	0.0302
0.150	-0.1516	-0.1206	0.0177	0.0177	0.0177	0.0177	0.0177	0.0177	0.0177	0.0177
0.200	-0.1570	-0.1160	0.0019	0.0019	0.0019	0.0019	0.0019	0.0019	0.0019	0.0019
0.250	*****	-0.1245	-0.0118	-0.2274	-0.3662	-0.3662	-0.3662	-0.3662	-0.3662	-0.3662
0.300	-0.1663	-0.1286	-0.0353	-0.2160	-0.3633	-0.3633	-0.3633	-0.3633	-0.3633	-0.3633
0.350	-0.1819	-0.1353	-0.0459	-0.2054	-0.3561	-0.3561	-0.3561	-0.3561	-0.3561	-0.3561
0.400	-0.1950	-0.1474	-0.0559	-0.1957	-0.3735	-0.3735	-0.3735	-0.3735	-0.3735	-0.3735
0.450	-0.2161	-0.1600	-0.0531	-0.1920	-0.3930	-0.3930	-0.3930	-0.3930	-0.3930	-0.3930
0.500	-0.2325	-0.1612	-0.0859	-0.1920	-0.4667	-0.4667	-0.4667	-0.4667	-0.4667	-0.4667
0.525	*****	-0.1676	-0.0906	-0.1891	-0.5370	-0.5370	-0.5370	-0.5370	-0.5370	-0.5370
0.550	-0.2502	-0.1733	-0.0983	-0.1843	-0.5728	-0.5728	-0.5728	-0.5728	-0.5728	-0.5728
0.575	*****	-0.1872	-0.0966	-0.1839	-0.6089	-0.6089	-0.6089	-0.6089	-0.6089	-0.6089
0.600	-0.2529	-0.1968	-0.1142	-0.1857	-0.6184	-0.6184	-0.6184	-0.6184	-0.6184	-0.6184
0.625	*****	*****	-0.1217	-0.1800	-0.6483	-0.6483	-0.6483	-0.6483	-0.6483	-0.6483
0.650	-0.2562	-0.2044	-0.1337	-0.1756	-0.7052	-0.7052	-0.7052	-0.7052	-0.7052	-0.7052
0.675	*****	-0.2286	-0.1379	-0.1707	-0.7258	-0.7258	-0.7258	-0.7258	-0.7258	-0.7258
0.700	-0.2557	-0.2529	-0.1351	-0.1513	-0.7174	-0.7174	-0.7174	-0.7174	-0.7174	-0.7174
0.725	*****	-0.2743	*****	-0.1253	-0.7239	-0.7239	-0.7239	-0.7239	-0.7239	-0.7239
0.750	-0.2315	-0.2823	*****	-0.1529	-0.8853	-0.8853	-0.8853	-0.8853	-0.8853	-0.8853
0.775	*****	-0.2967	-0.1876	-0.4473	-1.0294	-1.0294	-1.0294	-1.0294	-1.0294	-1.0294
0.800	-0.2052	-0.3019	-0.3309	-0.6617	*****	*****	*****	*****	*****	*****
0.825	*****	-0.3579	-0.5069	-0.7318	-0.9425	-0.9425	-0.9425	-0.9425	-0.9425	-0.9425
0.850	-0.3032	-0.4610	-0.6377	-0.7192	-0.8330	-0.8330	-0.8330	-0.8330	-0.8330	-0.8330
0.875	*****	-0.5888	-0.7003	-0.6789	-0.7678	-0.7678	-0.7678	-0.7678	-0.7678	-0.7678
0.900	-0.5001	-0.7003	-0.7132	-0.6315	*****	*****	*****	*****	*****	*****
0.925	*****	-0.7347	-0.7001	-0.6019	-0.7093	-0.7093	-0.7093	-0.7093	-0.7093	-0.7093
0.950	-0.3116	-0.7157	-0.6691	-0.5850	-0.6250	-0.6250	-0.6250	-0.6250	-0.6250	-0.6250
0.975	*****	-0.7019	-0.6543	-0.5807	-0.5545	-0.5545	-0.5545	-0.5545	-0.5545	-0.5545
-0.200	0.1383	0.1392	0.1915	0.1915	0.1915	0.1915	0.1915	0.1915	0.1915	0.1915
-0.400	0.1270	0.1440	0.1599	0.0033	-0.7106	-0.7106	-0.7106	-0.7106	-0.7106	-0.7106
-0.600	*****	0.1495	0.1505	0.0339	-0.6910	-0.6910	-0.6910	-0.6910	-0.6910	-0.6910
-0.700	*****	0.1430	0.1449	0.0465	-0.6670	-0.6670	-0.6670	-0.6670	-0.6670	-0.6670
-0.800	0.2052	0.1617	0.1479	0.0683	-0.6035	-0.6035	-0.6035	-0.6035	-0.6035	-0.6035
-0.850	0.2263	0.1805	0.1615	0.0746	-0.5940	-0.5940	-0.5940	-0.5940	-0.5940	-0.5940
-0.900	0.2436	0.2162	0.1878	0.1015	-0.6022	-0.6022	-0.6022	-0.6022	-0.6022	-0.6022
-0.950	*****	*****	0.2254	0.1546	-0.1720	-0.1720	-0.1720	-0.1720	-0.1720	-0.1720
-0.975	*****	0.2221	0.2110	0.1724	-0.0236	-0.0236	-0.0236	-0.0236	-0.0236	-0.0236

Sharp Radius L.E.
 Run No. = 93, Point No. = 2063
 $C_N = 0.311$, $C_m = -0.0568$
 $\alpha = 7.1^\circ$, $M_\infty = 0.851$
 $R_{mac} = 36.0 \times 10^6$

Surface Pressures Near Leading Edge

● / ◆ upper, starboard/port
 ○ / ◇ lower, starboard/port

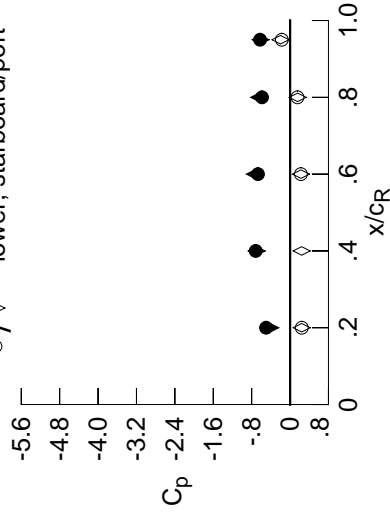

x/c_R	η	starb'd	port	starb'd	port
		$C_{p,u}$	$C_{p,l}$	$C_{p,u}$	$C_{p,l}$
0.20	0.90	-0.5001	-0.4128	0.2419	0.2436
0.40	0.95	-0.7157	-0.6968	0.2410	*****
0.60	0.95	-0.6691	-0.7333	0.2270	0.2254
0.80	0.95	-0.5850	-0.6441	0.1580	0.1546
0.95	0.95	-0.6250	-0.6149	-0.1991	-0.1720

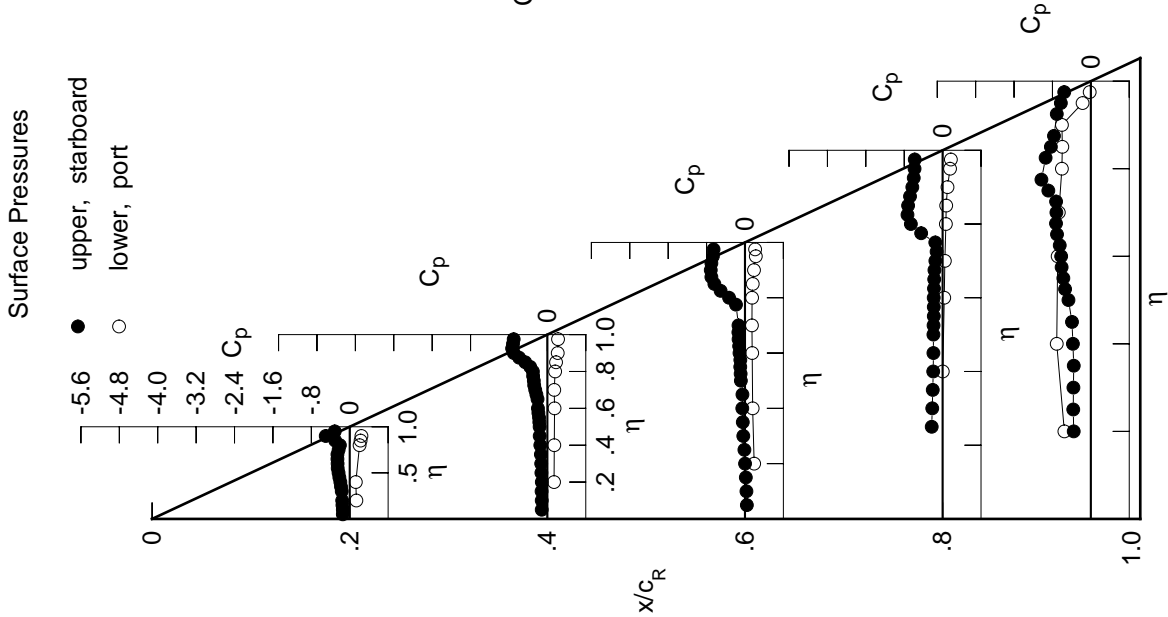

Table C3. Continued.

η	$x/c_R = .2$		$x/c_R = .4$		$x/c_R = .6$		$x/c_R = .8$		$x/c_R = .95$	
	$C_{p,u}$	$C_{p,l}$	$C_{p,u}$	$C_{p,l}$	$C_{p,u}$	$C_{p,l}$	$C_{p,u}$	$C_{p,l}$	$C_{p,u}$	$C_{p,l}$
0.050	-0.1615	-0.1407	0.0203	0.0203	0.0203	0.0203	0.0203	0.0203	0.0203	0.0203
0.100	-0.1630	-0.1409	0.0120	0.0120	0.0120	0.0120	0.0120	0.0120	0.0120	0.0120
0.150	-0.1722	-0.1441	-0.0030	-0.0030	-0.0030	-0.0030	-0.0030	-0.0030	-0.0030	-0.0030
0.200	-0.1772	-0.1381	-0.0161	-0.0161	-0.0161	-0.0161	-0.0161	-0.0161	-0.0161	-0.0161
0.250	*****	-0.1481	-0.0336	-0.0336	-0.0336	-0.0336	-0.0336	-0.0336	-0.0336	-0.0336
0.300	-0.1869	-0.1523	-0.0592	-0.0592	-0.0592	-0.0592	-0.0592	-0.0592	-0.0592	-0.0592
0.350	-0.2036	-0.1610	-0.0682	-0.0682	-0.0682	-0.0682	-0.0682	-0.0682	-0.0682	-0.0682
0.400	-0.2178	-0.1750	-0.0779	-0.0779	-0.0779	-0.0779	-0.0779	-0.0779	-0.0779	-0.0779
0.450	-0.2393	-0.1913	-0.0719	-0.0719	-0.0719	-0.0719	-0.0719	-0.0719	-0.0719	-0.0719
0.500	-0.2567	-0.1894	-0.1020	-0.1020	-0.1020	-0.1020	-0.1020	-0.1020	-0.1020	-0.1020
0.525	*****	-0.1923	-0.1037	-0.1037	-0.1037	-0.1037	-0.1037	-0.1037	-0.1037	-0.1037
0.550	-0.2732	-0.1962	-0.1094	-0.1094	-0.1094	-0.1094	-0.1094	-0.1094	-0.1094	-0.1094
0.575	*****	-0.2105	-0.1062	-0.1062	-0.1062	-0.1062	-0.1062	-0.1062	-0.1062	-0.1062
0.600	-0.2746	-0.2214	-0.1175	-0.1175	-0.1175	-0.1175	-0.1175	-0.1175	-0.1175	-0.1175
0.625	*****	*****	-0.1152	-0.1152	-0.1152	-0.1152	-0.1152	-0.1152	-0.1152	-0.1152
0.650	-0.2740	-0.2234	-0.1283	-0.1283	-0.1283	-0.1283	-0.1283	-0.1283	-0.1283	-0.1283
0.675	*****	-0.2427	-0.1326	-0.1326	-0.1326	-0.1326	-0.1326	-0.1326	-0.1326	-0.1326
0.700	-0.2665	-0.2632	-0.1108	-0.1108	-0.1108	-0.1108	-0.1108	-0.1108	-0.1108	-0.1108
0.725	*****	-0.2745	*****	-0.2337	-0.2337	-0.2337	-0.2337	-0.2337	-0.2337	-0.2337
0.750	-0.2309	-0.2785	*****	-0.5458	-0.5458	-0.5458	-0.5458	-0.5458	-0.5458	-0.5458
0.775	*****	-0.3348	-0.5810	-0.7989	-0.7989	-0.7989	-0.7989	-0.7989	-0.7989	-0.7989
0.800	-0.3083	-0.4622	-0.7635	-0.8566	-0.8566	-0.8566	-0.8566	-0.8566	-0.8566	-0.8566
0.825	*****	-0.6204	-0.8051	-0.8798	-0.8798	-0.8798	-0.8798	-0.8798	-0.8798	-0.8798
0.850	-0.5393	-0.7266	-0.8005	-0.8311	-0.8311	-0.8311	-0.8311	-0.8311	-0.8311	-0.8311
0.875	*****	-0.7977	-0.7681	-0.7247	-0.6453	-0.6453	-0.6453	-0.6453	-0.6453	-0.6453
0.900	-0.5765	-0.8232	-0.7327	-0.6424	*****	*****	*****	*****	*****	*****
0.925	*****	-0.8100	-0.7009	-0.6068	-0.6192	-0.6192	-0.6192	-0.6192	-0.6192	-0.6192
0.950	-0.4635	-0.7858	-0.6769	-0.5851	-0.5684	-0.5684	-0.5684	-0.5684	-0.5684	-0.5684
0.975	*****	-0.7812	-0.6672	-0.5804	-0.5366	-0.5366	-0.5366	-0.5366	-0.5366	-0.5366

Sharp Radius L.E.
 Run No. = 93, Point No. = 2064
 $C_N = 0.363$, $C_m = -0.0646$
 $\alpha = 8.2^\circ$, $M_\infty = 0.849$
 $R_{mac} = 36.0 \times 10^6$

Surface Pressures Near Leading Edge

● / ◆ upper, starboard/port
 ○ / ◇ lower, starboard/port

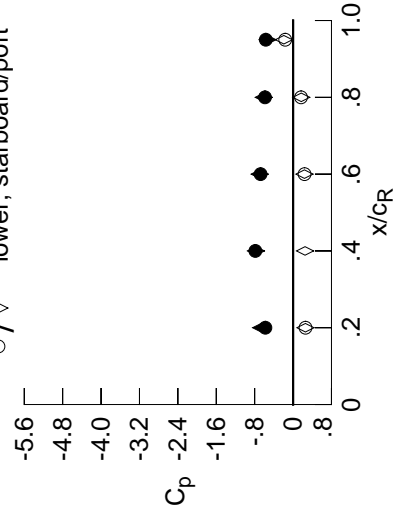

x/c_R	η	starb'd	port	starb'd	port
		$C_{p,u}$	$C_{p,l}$	$C_{p,u}$	$C_{p,l}$
0.20	0.90	-0.5765	-0.6658	0.2579	0.2592
0.40	0.95	-0.7858	-0.7726	0.2493	*****
0.60	0.95	-0.6769	-0.6970	0.2372	0.2389
0.80	0.95	-0.5851	-0.6112	0.1705	0.1664
0.95	0.95	-0.5684	-0.5309	-0.1920	-0.1630

Surface Pressures

● upper, starboard
 ○ lower, port

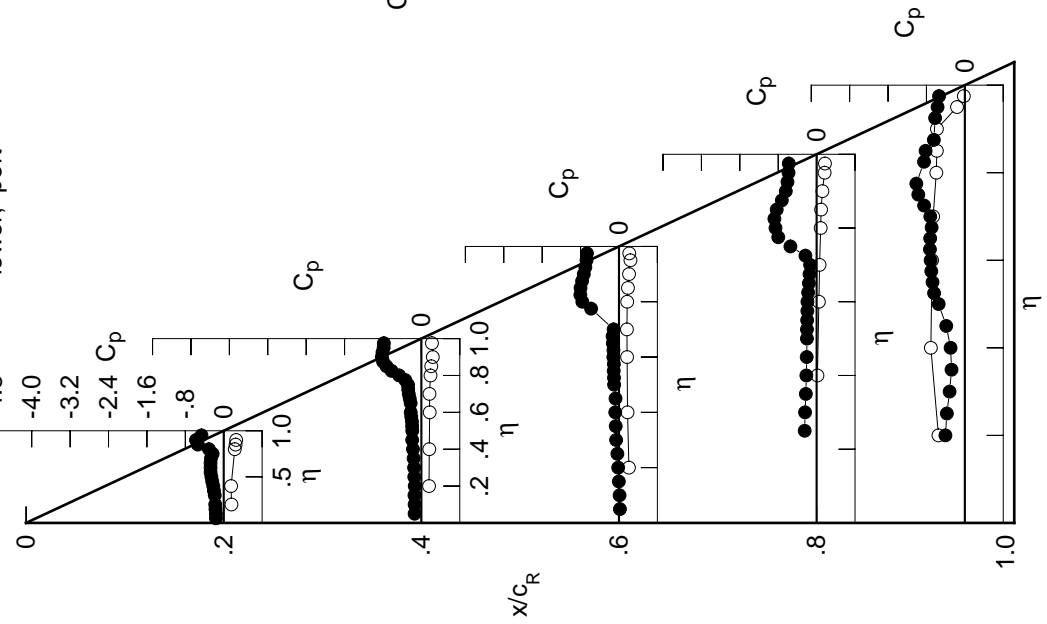

η	$C_{p,l}$	$C_{p,l}$	$C_{p,l}$	$C_{p,l}$	$C_{p,l}$
-0.200	0.1611	0.1596	0.2076	*****	-0.5499
-0.400	0.1539	0.1651	0.1786	0.0168	-0.7080
-0.600	*****	0.1737	0.1690	0.0470	-0.6828
-0.700	*****	0.1688	0.1658	0.0618	-0.6599
-0.800	0.2299	0.1905	0.1710	0.0845	-0.5947
-0.850	0.2482	0.2066	0.1864	0.0930	-0.5831
-0.900	0.2592	0.2383	0.2100	0.1209	-0.5820
-0.950	*****	*****	0.2389	0.1664	-0.1630
-0.975	*****	0.2203	0.2141	0.1734	-0.0208

Table C3. Continued.

η	$x/c_R = .2$		$x/c_R = .4$		$x/c_R = .6$		$x/c_R = .8$		$x/c_R = .95$	
	$C_{p,u}$	$C_{p,l}$	$C_{p,u}$	$C_{p,l}$	$C_{p,u}$	$C_{p,l}$	$C_{p,u}$	$C_{p,l}$	$C_{p,u}$	$C_{p,l}$
0.050	-0.1815	-0.1624	0.0024	0.0024	0.0024	0.0024	0.0024	0.0024	0.0024	0.0024
0.100	-0.1833	-0.1644	-0.0072	-0.0072	-0.0072	-0.0072	-0.0072	-0.0072	-0.0072	-0.0072
0.150	-0.1908	-0.1680	-0.0209	-0.0209	-0.0209	-0.0209	-0.0209	-0.0209	-0.0209	-0.0209
0.200	-0.1981	-0.1631	-0.0351	-0.0351	-0.0351	-0.0351	-0.0351	-0.0351	-0.0351	-0.0351
0.250	*****	-0.1724	-0.0520	-0.0520	-0.0520	-0.0520	-0.0520	-0.0520	-0.0520	-0.0520
0.300	-0.2061	-0.1760	-0.0797	-0.0797	-0.0797	-0.0797	-0.0797	-0.0797	-0.0797	-0.0797
0.350	-0.2248	-0.1845	-0.0927	-0.0927	-0.0927	-0.0927	-0.0927	-0.0927	-0.0927	-0.0927
0.400	-0.2382	-0.1963	-0.0952	-0.0952	-0.0952	-0.0952	-0.0952	-0.0952	-0.0952	-0.0952
0.450	-0.2599	-0.2277	-0.0868	-0.0868	-0.0868	-0.0868	-0.0868	-0.0868	-0.0868	-0.0868
0.500	-0.2776	-0.2179	-0.1197	-0.1197	-0.1197	-0.1197	-0.1197	-0.1197	-0.1197	-0.1197
0.525	*****	-0.2177	-0.1196	-0.1196	-0.1196	-0.1196	-0.1196	-0.1196	-0.1196	-0.1196
0.550	-0.2938	-0.2205	-0.1237	-0.1237	-0.1237	-0.1237	-0.1237	-0.1237	-0.1237	-0.1237
0.575	*****	-0.2253	-0.1145	-0.1145	-0.1145	-0.1145	-0.1145	-0.1145	-0.1145	-0.1145
0.600	-0.2898	-0.2344	-0.1254	-0.1254	-0.1254	-0.1254	-0.1254	-0.1254	-0.1254	-0.1254
0.625	*****	*****	-0.1095	-0.1095	-0.1095	-0.1095	-0.1095	-0.1095	-0.1095	-0.1095
0.650	-0.2728	-0.2321	-0.1029	-0.1029	-0.1029	-0.1029	-0.1029	-0.1029	-0.1029	-0.1029
0.675	*****	-0.2412	-0.0922	-0.0922	-0.0922	-0.0922	-0.0922	-0.0922	-0.0922	-0.0922
0.700	-0.2638	-0.2544	-0.1125	-0.1125	-0.1125	-0.1125	-0.1125	-0.1125	-0.1125	-0.1125
0.725	*****	-0.2799	*****	-0.6186	-1.0063	*****	-0.6186	-1.0063	*****	-0.6186
0.750	-0.3131	-0.4017	*****	-0.8582	-1.0815	*****	-0.8582	-1.0815	*****	-0.8582
0.775	*****	-0.6293	-0.9161	-0.9697	-0.9878	*****	-0.9697	-0.9878	*****	-0.9697
0.800	-0.5555	-0.7728	-0.9594	-0.9724	*****	*****	-0.9724	*****	*****	-0.9724
0.825	*****	-0.8489	-0.9233	-0.9417	-0.6472	*****	-0.9417	-0.6472	*****	-0.9417
0.850	-0.7103	-0.8814	-0.8764	-0.7885	-0.6649	*****	-0.7885	-0.6649	*****	-0.7885
0.875	*****	-0.8979	-0.8026	-0.7015	-0.5794	*****	-0.7015	-0.5794	*****	-0.7015
0.900	-0.6432	-0.8886	-0.7432	-0.6706	*****	*****	-0.6706	*****	*****	-0.6706
0.925	*****	-0.8641	-0.7081	-0.6230	-0.5820	*****	-0.6230	-0.5820	*****	-0.6230
0.950	-0.6262	-0.8439	-0.6855	-0.6092	-0.5400	*****	-0.6092	-0.5400	*****	-0.6092
0.975	*****	-0.8413	-0.6718	-0.6034	-0.4887	*****	-0.6034	-0.4887	*****	-0.6034
-0.200	0.1917	0.1827	0.2258	0.2258	0.2258	0.2258	0.2258	0.2258	0.2258	0.2258
-0.400	0.1824	0.1921	0.1966	0.1966	0.1966	0.1966	0.1966	0.1966	0.1966	0.1966
-0.600	*****	0.1987	0.1901	0.0640	-0.6742	*****	0.0640	-0.6742	*****	0.0640
-0.700	*****	0.1969	0.1894	0.0796	-0.6496	*****	0.0796	-0.6496	*****	0.0796
-0.800	0.2561	0.2188	0.1951	0.1042	-0.5805	*****	0.1042	-0.5805	*****	0.1042
-0.850	0.2702	0.2314	0.2104	0.1128	-0.5683	*****	0.1128	-0.5683	*****	0.1128
-0.900	0.2750	0.2587	0.2308	0.1401	-0.5586	*****	0.1401	-0.5586	*****	0.1401
-0.950	*****	*****	0.2492	0.1766	-0.1568	*****	0.1766	-0.1568	*****	0.1766
-0.975	*****	0.2160	0.2136	0.1736	-0.0234	*****	0.1736	-0.0234	*****	0.1736

Sharp Radius L.E.
 Run No. = 93 , Point No. = 2065
 $C_N = 0.421$, $C_m = -0.0747$
 $\alpha = 9.2^\circ$, $M_\infty = 0.850$
 $R_{mac} = 36.0 \times 10^6$

Surface Pressures Near Leading Edge

● / ◆ upper, starboard/port
 ○ / ◇ lower, starboard/port

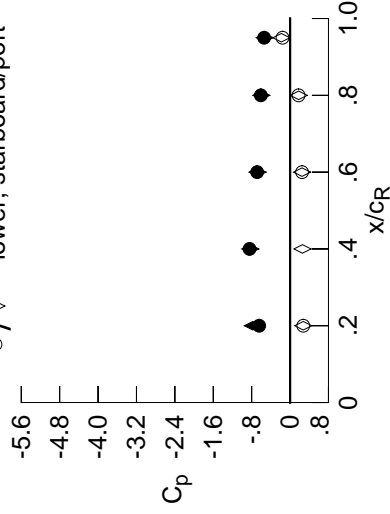

x/c_R	η	starb'd	port	$C_{p,u}$	starb'd	port	$C_{p,l}$
0.20	0.90	-0.6432	-0.7750	0.2747	0.2750	0.2747	0.2750
0.40	0.95	-0.8439	-0.8294	0.2585	0.2585	0.2585	0.2585
0.60	0.95	-0.6855	-0.6792	0.2495	0.2492	0.2495	0.2492
0.80	0.95	-0.6092	-0.5992	0.1793	0.1766	0.1793	0.1766
0.95	0.95	-0.5400	-0.5285	-0.1813	-0.1568	-0.1813	-0.1568

Surface Pressures

● upper, starboard
 ○ lower, port

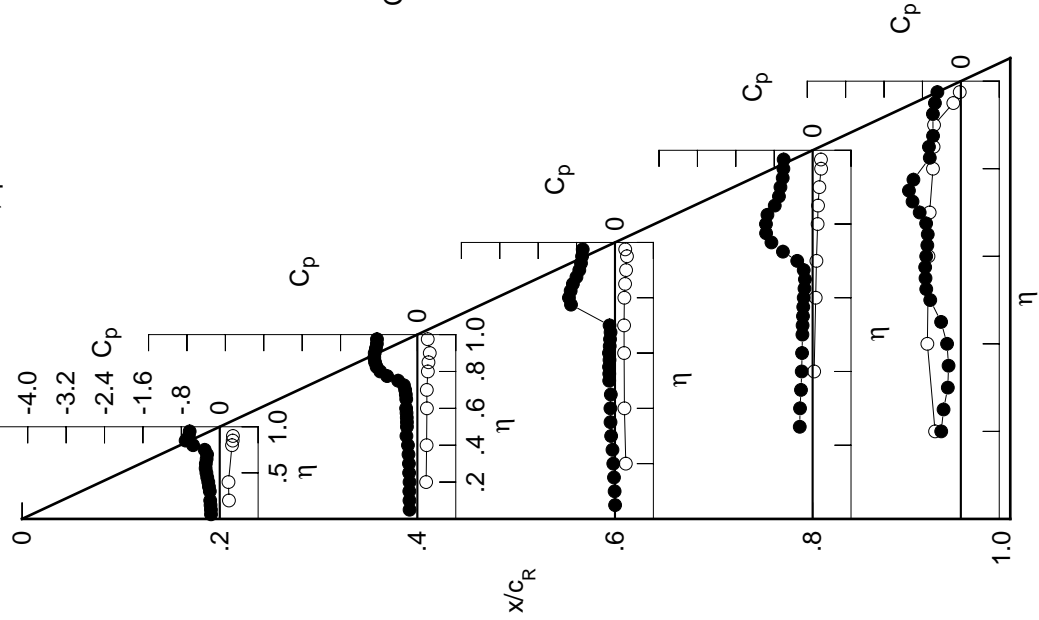

Table C3. Continued.

η	$x/c_R = .2$		$x/c_R = .4$		$x/c_R = .6$		$x/c_R = .8$		$x/c_R = .95$	
	$C_{p,u}$	$C_{p,l}$	$C_{p,u}$	$C_{p,l}$	$C_{p,u}$	$C_{p,l}$	$C_{p,u}$	$C_{p,l}$	$C_{p,u}$	$C_{p,l}$
0.050	-0.2006	-0.1871	-0.0174	*****	*****	*****	*****	*****	*****	*****
0.100	-0.2034	-0.1920	-0.0281	*****	*****	*****	*****	*****	*****	*****
0.150	-0.2125	-0.1921	-0.0403	*****	*****	*****	*****	*****	*****	*****
0.200	-0.2186	-0.1898	-0.0551	*****	*****	*****	*****	*****	*****	*****
0.250	*****	-0.1952	-0.0692	-0.2830	-0.3243	*****	*****	*****	*****	*****
0.300	-0.2270	-0.1986	-0.0859	-0.2727	-0.3116	*****	*****	*****	*****	*****
0.350	-0.2452	-0.2044	-0.1157	-0.2567	-0.3116	*****	*****	*****	*****	*****
0.400	-0.2590	-0.2055	-0.1164	-0.2407	-0.3757	*****	*****	*****	*****	*****
0.450	-0.2811	-0.2452	-0.1037	-0.2310	-0.5822	*****	*****	*****	*****	*****
0.500	-0.2965	-0.2591	-0.1326	-0.2209	-0.7224	*****	*****	*****	*****	*****
0.525	*****	-0.2542	-0.1318	-0.2128	-0.7280	*****	*****	*****	*****	*****
0.550	-0.3077	-0.2534	-0.1306	-0.2042	-0.7112	*****	*****	*****	*****	*****
0.575	*****	-0.2509	-0.1147	-0.1956	-0.7066	*****	*****	*****	*****	*****
0.600	-0.2891	-0.2450	-0.1205	-0.1931	-0.6896	*****	*****	*****	*****	*****
0.625	*****	*****	-0.1006	-0.1950	-0.7056	*****	*****	*****	*****	*****
0.650	-0.2691	-0.2079	-0.1124	-0.2441	-0.7716	*****	*****	*****	*****	*****
0.675	*****	-0.2135	-0.2045	-0.3913	-0.8839	*****	*****	*****	*****	*****
0.700	-0.3377	-0.3692	-0.4817	-0.6456	-1.0195	*****	*****	*****	*****	*****
0.725	*****	-0.6398	*****	-0.8902	-1.1081	*****	*****	*****	*****	*****
0.750	-0.5664	-0.8214	*****	-1.0286	-0.8952	*****	*****	*****	*****	*****
0.775	*****	-0.9254	-1.0553	-1.0780	-0.6676	*****	*****	*****	*****	*****
0.800	-0.7599	-0.9637	-1.0570	-0.9279	*****	*****	*****	*****	*****	*****
0.825	*****	-0.9637	-1.0087	-0.7723	-0.5659	*****	*****	*****	*****	*****
0.850	-0.8125	-0.9566	-0.9273	-0.7241	-0.5508	*****	*****	*****	*****	*****
0.875	*****	-0.9414	-0.8197	-0.7258	-0.5361	*****	*****	*****	*****	*****
0.900	-0.7151	-0.9191	-0.7592	-0.6833	*****	*****	*****	*****	*****	*****
0.925	*****	-0.8919	-0.7219	-0.6513	-0.5194	*****	*****	*****	*****	*****
0.950	-0.7606	-0.8763	-0.6896	-0.6625	-0.4626	*****	*****	*****	*****	*****
0.975	*****	-0.8715	-0.6721	-0.6538	-0.3996	*****	*****	*****	*****	*****

η	$x/c_R = .2$		$x/c_R = .4$		$x/c_R = .6$		$x/c_R = .8$		$x/c_R = .95$	
	$C_{p,u}$	$C_{p,l}$	$C_{p,u}$	$C_{p,l}$	$C_{p,u}$	$C_{p,l}$	$C_{p,u}$	$C_{p,l}$	$C_{p,u}$	$C_{p,l}$
-0.200	0.2178	0.2079	0.2436	*****	*****	*****	*****	*****	*****	*****
-0.400	0.2116	0.2148	0.2153	0.0472	-0.6896	*****	*****	*****	*****	*****
-0.600	*****	0.2235	0.2105	0.0803	-0.6678	*****	*****	*****	*****	*****
-0.700	*****	0.2244	0.2088	0.0945	-0.6410	*****	*****	*****	*****	*****
-0.800	0.2820	0.2458	0.2171	0.1208	-0.5688	*****	*****	*****	*****	*****
-0.850	0.2924	0.2562	0.2329	0.1307	-0.5549	*****	*****	*****	*****	*****
-0.900	0.2916	0.2782	0.2500	0.1576	-0.5370	*****	*****	*****	*****	*****
-0.950	*****	*****	0.2574	0.1847	-0.1452	*****	*****	*****	*****	*****
-0.975	*****	0.2116	0.2103	0.1695	-0.0184	*****	*****	*****	*****	*****

Sharp Radius L.E.
 Run No. = 93, Point No. = 2066
 $C_N = 0.476$, $C_m = -0.0832$
 $\alpha = 10.3^\circ$, $M_\infty = 0.849$
 $R_{mac} = 35.9 \times 10^6$

Surface Pressures Near Leading Edge

● / ◆ upper, starboard/port
 ○ / ◇ lower, starboard/port

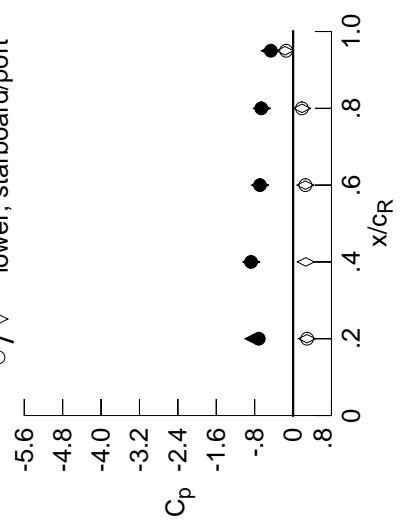

x/c_R	η	starb'd	port	starb'd	port
x/c_R	η	$C_{p,u}$	$C_{p,l}$	$C_{p,u}$	$C_{p,l}$
0.20	0.90	-0.7151	-0.8271	0.2897	0.2916
0.40	0.95	-0.8763	-0.8715	0.2652	*****
0.60	0.95	-0.6896	-0.6878	0.2563	0.2574
0.80	0.95	-0.6625	-0.6487	0.1869	0.1847
0.95	0.95	-0.4626	-0.4855	-0.1688	-0.1452

Table C3. Continued.

η	$x/c_R = .2$		$x/c_R = .4$		$x/c_R = .6$		$x/c_R = .8$		$x/c_R = .95$	
	$C_{p,u}$	$C_{p,l}$	$C_{p,u}$	$C_{p,l}$	$C_{p,u}$	$C_{p,l}$	$C_{p,u}$	$C_{p,l}$	$C_{p,u}$	$C_{p,l}$
0.050	-0.2242	-0.2169	-0.0369	*****	*****	*****	*****	*****	*****	*****
0.100	-0.2273	-0.2191	-0.0485	*****	*****	*****	*****	*****	*****	*****
0.150	-0.2363	-0.2221	-0.0621	*****	*****	*****	*****	*****	*****	*****
0.200	-0.2406	-0.2183	-0.0727	*****	*****	*****	*****	*****	*****	*****
0.250	*****	-0.2249	-0.0883	-0.3012	-0.2518	*****	*****	*****	*****	*****
0.300	-0.2495	-0.2230	-0.0972	-0.2845	-0.3409	*****	*****	*****	*****	*****
0.350	-0.2675	-0.2304	-0.1241	-0.2751	-0.4295	*****	*****	*****	*****	*****
0.400	-0.2813	-0.2251	-0.1362	-0.2595	-0.6272	*****	*****	*****	*****	*****
0.450	-0.3021	-0.2481	-0.1207	-0.2482	-0.7380	*****	*****	*****	*****	*****
0.500	-0.3113	-0.2777	-0.1447	-0.2362	-0.7222	*****	*****	*****	*****	*****
0.525	*****	-0.2749	-0.1391	-0.2302	-0.7127	*****	*****	*****	*****	*****
0.550	-0.3086	-0.2737	-0.1357	-0.2249	-0.7056	*****	*****	*****	*****	*****
0.575	*****	-0.2687	-0.1187	-0.2294	-0.7188	*****	*****	*****	*****	*****
0.600	-0.2609	-0.2533	-0.1385	-0.2528	-0.7486	*****	*****	*****	*****	*****
0.625	*****	*****	-0.1582	-0.3121	-0.8242	*****	*****	*****	*****	*****
0.650	-0.3004	-0.2991	-0.2901	-0.4481	-0.9391	*****	*****	*****	*****	*****
0.675	*****	-0.5425	-0.5754	-0.6697	-1.0433	*****	*****	*****	*****	*****
0.700	-0.5737	-0.8351	-0.8811	-0.9011	-1.1013	*****	*****	*****	*****	*****
0.725	*****	-0.9965	*****	-1.0863	-0.8337	*****	*****	*****	*****	*****
0.750	-0.7973	-1.0442	*****	-1.1036	-0.6284	*****	*****	*****	*****	*****
0.775	*****	-1.0568	-1.1564	-0.8400	-0.5663	*****	*****	*****	*****	*****
0.800	-0.8927	-1.0482	-1.1357	-0.7471	*****	*****	*****	*****	*****	*****
0.825	*****	-1.0182	-1.0217	-0.7254	-0.5298	*****	*****	*****	*****	*****
0.850	-0.8875	-0.9976	-0.8862	-0.7309	-0.5051	*****	*****	*****	*****	*****
0.875	*****	-0.9655	-0.8251	-0.7212	-0.4995	*****	*****	*****	*****	*****
0.900	-0.7865	-0.9305	-0.7895	-0.7036	*****	*****	*****	*****	*****	*****
0.925	*****	-0.9062	-0.7475	-0.7215	-0.4604	*****	*****	*****	*****	*****
0.950	-0.8633	-0.8922	-0.7045	-0.7302	-0.3975	*****	*****	*****	*****	*****
0.975	*****	-0.8897	-0.6853	-0.7146	-0.3516	*****	*****	*****	*****	*****
-0.200	$C_{p,l}$	0.2440	0.2284	0.2585	*****	*****	*****	*****	*****	*****
-0.400	$C_{p,l}$	0.2387	0.2361	0.2305	0.0610	-0.6863	*****	*****	*****	*****
-0.600	$C_{p,l}$	*****	0.2454	0.2253	0.0910	-0.6618	*****	*****	*****	*****
-0.700	$C_{p,l}$	*****	0.2476	0.2251	0.1078	-0.6342	*****	*****	*****	*****
-0.800	$C_{p,l}$	0.3033	0.2686	0.2341	0.1340	-0.5600	*****	*****	*****	*****
-0.850	$C_{p,l}$	0.3100	0.2753	0.2495	0.1443	-0.5435	*****	*****	*****	*****
-0.900	$C_{p,l}$	0.3029	0.2918	0.2625	0.1694	-0.5177	*****	*****	*****	*****
-0.950	$C_{p,l}$	*****	*****	0.2593	0.1887	-0.1381	*****	*****	*****	*****
-0.975	$C_{p,l}$	*****	0.2041	0.2027	0.1619	-0.0171	*****	*****	*****	*****

Sharp Radius L.E.
 Run No. = 93 , Point No. = 2067
 $C_N = 0.522$, $C_m = -0.0858$
 $\alpha = 11.3^\circ$, $M_\infty = 0.849$
 $R_{mac} = 36.0 \times 10^6$

Surface Pressures Near Leading Edge

● / ◆ upper, starboard/port
 ○ / ◇ lower, starboard/port

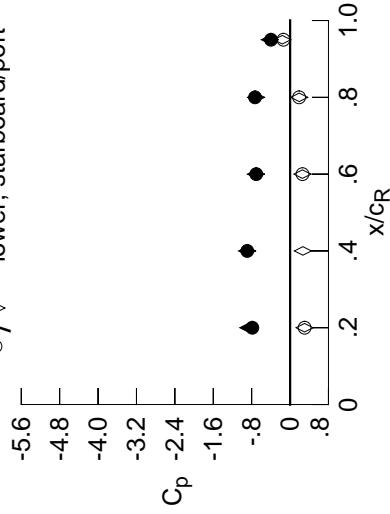

x/c_R	η	starb'd	port	starb'd	port
		$C_{p,u}$	$C_{p,l}$	$C_{p,u}$	$C_{p,l}$
0.20	0.90	-0.7865	-0.8701	0.3013	0.3029
0.40	0.95	-0.8922	-0.8948	0.2669	*****
0.60	0.95	-0.7045	-0.7109	0.2575	0.2593
0.80	0.95	-0.7302	-0.7085	0.1901	0.1887
0.95	0.95	-0.3975	-0.4213	-0.1619	-0.1381

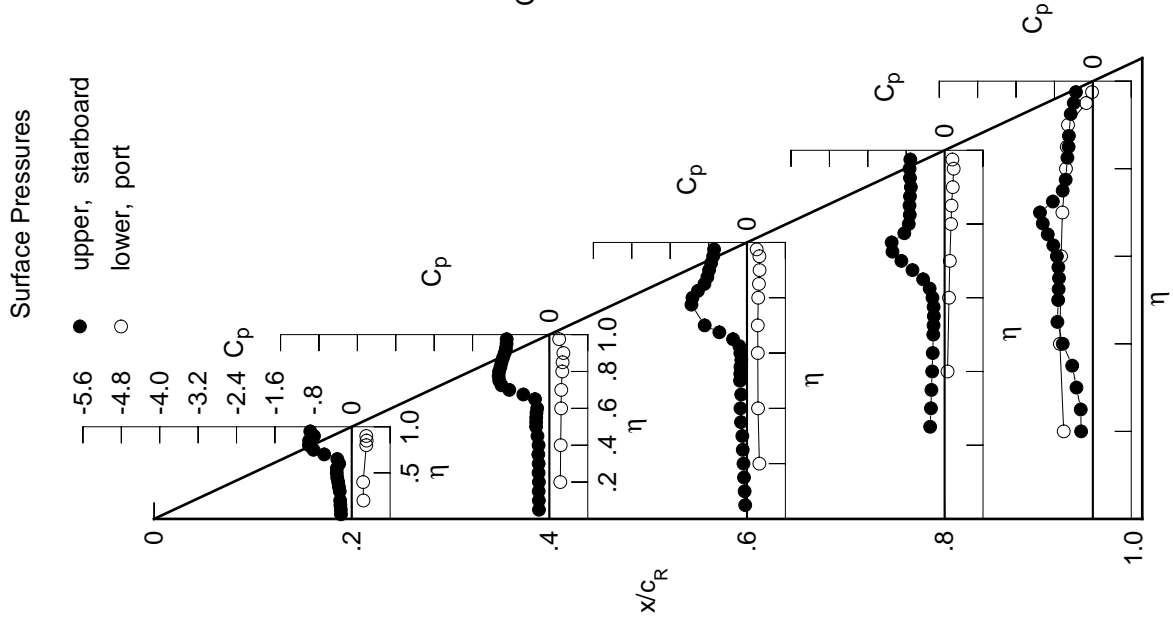

Table C3. Continued.

η	$x/c_R = .2$		$x/c_R = .4$		$x/c_R = .6$		$x/c_R = .8$		$x/c_R = .95$	
	$C_{p,u}$	$C_{p,l}$	$C_{p,u}$	$C_{p,l}$	$C_{p,u}$	$C_{p,l}$	$C_{p,u}$	$C_{p,l}$	$C_{p,u}$	$C_{p,l}$
0.050	-0.2443	-0.2460	-0.0532	*****	*****	*****	*****	*****	*****	*****
0.100	-0.2468	-0.2498	-0.0651	*****	*****	*****	*****	*****	*****	*****
0.150	-0.2568	-0.2539	-0.0773	*****	*****	*****	*****	*****	*****	*****
0.200	-0.2603	-0.2473	-0.0874	*****	*****	*****	*****	*****	*****	*****
0.250	*****	-0.2533	-0.1026	-0.3190	-0.2185	*****	*****	*****	*****	*****
0.300	-0.2688	-0.2519	-0.1124	-0.2984	-0.3299	*****	*****	*****	*****	*****
0.350	-0.2861	-0.2565	-0.1277	-0.2896	-0.4545	*****	*****	*****	*****	*****
0.400	-0.2967	-0.2483	-0.1422	-0.2746	-0.6630	*****	*****	*****	*****	*****
0.450	-0.3122	-0.2494	-0.1279	-0.2621	-0.7228	*****	*****	*****	*****	*****
0.500	-0.3140	-0.2651	-0.1487	-0.2530	-0.7083	*****	*****	*****	*****	*****
0.525	*****	-0.2785	-0.1434	-0.2538	-0.7122	*****	*****	*****	*****	*****
0.550	-0.2963	-0.2791	-0.1442	-0.2628	-0.7240	*****	*****	*****	*****	*****
0.575	*****	-0.2842	-0.1456	-0.2913	-0.7719	*****	*****	*****	*****	*****
0.600	-0.2296	-0.3108	-0.2272	-0.3578	-0.8394	*****	*****	*****	*****	*****
0.625	*****	*****	-0.3568	-0.4797	-0.9512	*****	*****	*****	*****	*****
0.650	-0.4676	-0.7186	-0.6427	-0.6663	-1.0798	*****	*****	*****	*****	*****
0.675	*****	-0.9635	-0.9579	-0.8907	-1.1678	*****	*****	*****	*****	*****
0.700	-0.8105	-1.0965	-1.1608	-1.0859	-0.8562	*****	*****	*****	*****	*****
0.725	*****	-1.1460	*****	-1.1064	-0.6478	*****	*****	*****	*****	*****
0.750	-0.9555	-1.1372	*****	-0.8316	-0.5553	*****	*****	*****	*****	*****
0.775	*****	-1.1137	-1.1915	-0.7883	-0.5236	*****	*****	*****	*****	*****
0.800	-0.9917	-1.0777	-1.1046	-0.7881	*****	*****	*****	*****	*****	*****
0.825	*****	-1.0333	-0.9331	-0.7953	-0.5059	*****	*****	*****	*****	*****
0.850	-0.9562	-1.0008	-0.8643	-0.7950	-0.4818	*****	*****	*****	*****	*****
0.875	*****	-0.9654	-0.8403	-0.7507	-0.4770	*****	*****	*****	*****	*****
0.900	-0.8531	-0.9375	-0.8359	-0.7438	*****	*****	*****	*****	*****	*****
0.925	*****	-0.9172	-0.7704	-0.7659	-0.4287	*****	*****	*****	*****	*****
0.950	-0.9372	-0.9067	-0.7196	-0.7655	-0.3669	*****	*****	*****	*****	*****
0.975	*****	-0.9053	-0.7064	-0.7479	-0.3281	*****	*****	*****	*****	*****
-0.200	0.2717	0.2535	0.2768	*****	-0.6097	*****	*****	*****	*****	*****
-0.400	0.2673	0.2603	0.2494	0.0744	-0.6777	*****	*****	*****	*****	*****
-0.600	*****	0.2714	0.2442	0.1081	-0.6519	*****	*****	*****	*****	*****
-0.700	*****	0.2737	0.2462	0.1239	-0.6236	*****	*****	*****	*****	*****
-0.800	0.3283	0.2936	0.2545	0.1501	-0.5466	*****	*****	*****	*****	*****
-0.850	0.3296	0.2978	0.2681	0.1614	-0.5284	*****	*****	*****	*****	*****
-0.900	0.3170	0.3091	0.2773	0.1849	-0.4980	*****	*****	*****	*****	*****
-0.950	*****	*****	0.2630	0.1951	-0.1290	*****	*****	*****	*****	*****
-0.975	*****	0.2001	0.1962	0.1581	-0.0160	*****	*****	*****	*****	*****

Sharp Radius L.E.
 Run No. = 93, Point No. = 2068
 $C_N = 0.574$, $C_m = -0.0924$
 $\alpha = 12.3^\circ$, $M_\infty = 0.849$
 $R_{mac} = 36.0 \times 10^6$

Surface Pressures Near Leading Edge

● / ◆ upper, starboard/port
 ○ / ◇ lower, starboard/port

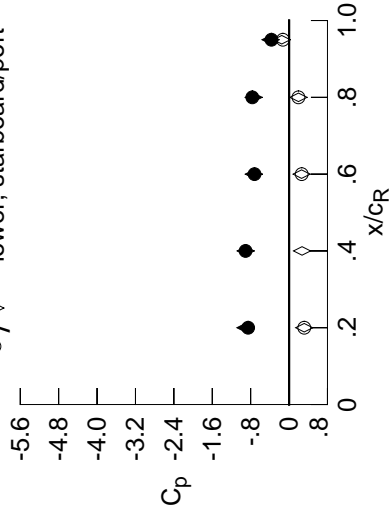

x/c_R	η	starb'd	port	starb'd	port
		$C_{p,u}$	$C_{p,l}$	$C_{p,u}$	$C_{p,l}$
0.20	0.90	-0.8531	-0.9097	0.3151	0.3170
0.40	0.95	-0.9067	-0.9052	0.2702	*****
0.60	0.95	-0.7196	-0.7356	0.2606	0.2630
0.80	0.95	-0.7655	-0.7380	0.1960	0.1951
0.95	0.95	-0.3669	-0.3872	-0.1522	-0.1290

Surface Pressures

● upper, starboard
 ○ lower, port

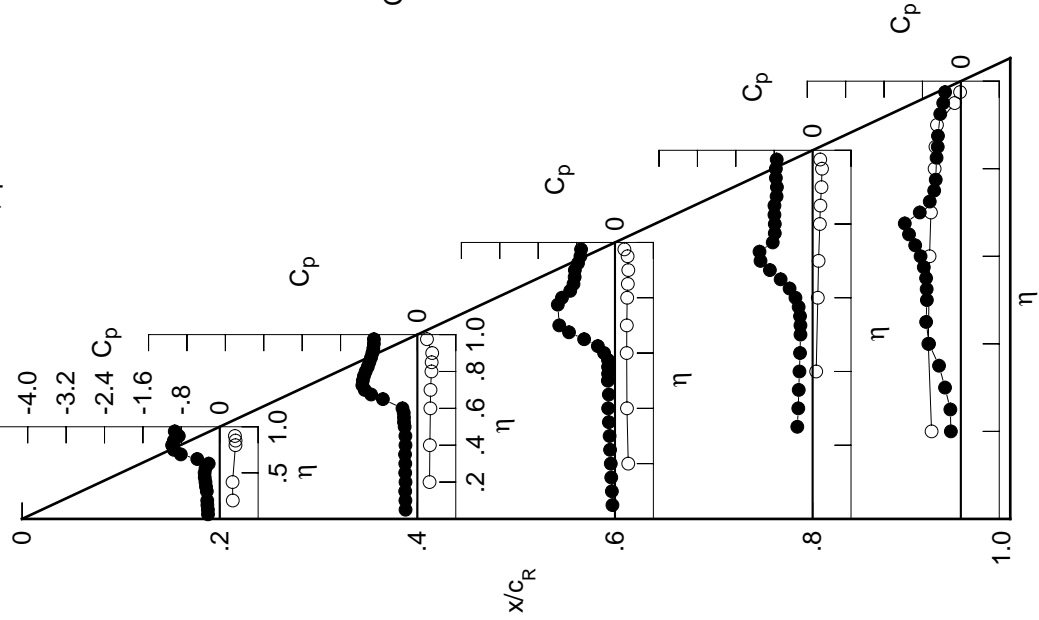

Table C3. Continued.

η	$x/c_R = .2$		$x/c_R = .4$		$x/c_R = .6$		$x/c_R = .8$		$x/c_R = .95$	
	$C_{p,u}$	$C_{p,l}$	$C_{p,u}$	$C_{p,l}$	$C_{p,u}$	$C_{p,l}$	$C_{p,u}$	$C_{p,l}$	$C_{p,u}$	$C_{p,l}$
0.050	-0.2727	-0.2801	-0.0755	*****	*****	*****	*****	*****	*****	*****
0.100	-0.2734	-0.2851	-0.0862	*****	*****	*****	*****	*****	*****	*****
0.150	-0.2844	-0.2865	-0.0978	*****	*****	*****	*****	*****	*****	*****
0.200	-0.2908	-0.2822	-0.1086	*****	*****	*****	*****	*****	*****	*****
0.250	*****	-0.2866	-0.1234	-0.3477	-0.2417	*****	*****	*****	*****	*****
0.300	-0.2993	-0.2860	-0.1351	-0.3273	-0.3343	*****	*****	*****	*****	*****
0.350	-0.3195	-0.2907	-0.1469	-0.3155	-0.4812	*****	*****	*****	*****	*****
0.400	-0.3303	-0.2855	-0.1545	-0.2988	-0.6759	*****	*****	*****	*****	*****
0.450	-0.3445	-0.2810	-0.1366	-0.2902	-0.7155	*****	*****	*****	*****	*****
0.500	-0.3374	-0.2675	-0.1661	-0.2904	-0.7126	*****	*****	*****	*****	*****
0.525	*****	-0.2700	-0.1714	-0.3041	-0.7306	*****	*****	*****	*****	*****
0.550	-0.2916	-0.2830	-0.1988	-0.3339	-0.7648	*****	*****	*****	*****	*****
0.575	*****	-0.3423	-0.2512	-0.3986	-0.8429	*****	*****	*****	*****	*****
0.600	-0.2551	-0.4955	-0.4340	-0.5090	-0.9356	*****	*****	*****	*****	*****
0.625	*****	*****	-0.6590	-0.6690	-1.0628	*****	*****	*****	*****	*****
0.650	-0.7557	-1.0254	-0.9423	-0.8743	-1.1882	*****	*****	*****	*****	*****
0.675	*****	-1.1796	-1.1825	-1.0677	-0.8413	*****	*****	*****	*****	*****
0.700	-1.0168	-1.2379	-1.3079	-1.1696	-0.6905	*****	*****	*****	*****	*****
0.725	*****	-1.2456	*****	-0.8657	-0.5651	*****	*****	*****	*****	*****
0.750	-1.0707	-1.2123	*****	-0.8194	-0.5151	*****	*****	*****	*****	*****
0.775	*****	-1.1761	-1.1507	-0.8200	-0.5016	*****	*****	*****	*****	*****
0.800	-1.0689	-1.1336	-1.0054	-0.8364	*****	*****	*****	*****	*****	*****
0.825	*****	-1.0925	-0.9257	-0.8477	-0.4914	*****	*****	*****	*****	*****
0.850	-1.0276	-1.0465	-0.9031	-0.8489	-0.4601	*****	*****	*****	*****	*****
0.875	*****	-1.0040	-0.9046	-0.8018	-0.4513	*****	*****	*****	*****	*****
0.900	-0.9156	-0.9742	-0.8931	-0.7827	*****	*****	*****	*****	*****	*****
0.925	*****	-0.9497	-0.7993	-0.7986	-0.3921	*****	*****	*****	*****	*****
0.950	-0.9987	-0.9372	-0.7564	-0.8013	-0.3436	*****	*****	*****	*****	*****
0.975	*****	-0.9333	-0.7471	-0.7879	-0.3124	*****	*****	*****	*****	*****
-0.200	$C_{p,l}$	0.3014	0.2753	0.2929	*****	*****	*****	*****	*****	*****
-0.400	$C_{p,l}$	0.2958	0.2828	0.2669	0.0891	-0.6711	*****	*****	*****	*****
-0.600	$C_{p,l}$	*****	0.2935	0.2623	0.1216	-0.6457	*****	*****	*****	*****
-0.700	$C_{p,l}$	*****	0.2974	0.2622	0.1385	-0.6142	*****	*****	*****	*****
-0.800	$C_{p,l}$	0.3491	0.3148	0.2725	0.1637	-0.5344	*****	*****	*****	*****
-0.850	$C_{p,l}$	0.3470	0.3151	0.2851	0.1752	-0.5155	*****	*****	*****	*****
-0.900	$C_{p,l}$	0.3280	0.3214	0.2885	0.1965	-0.4789	*****	*****	*****	*****
-0.950	$C_{p,l}$	*****	*****	0.2634	0.1956	-0.1224	*****	*****	*****	*****
-0.975	$C_{p,l}$	*****	0.1923	0.1858	0.1479	-0.0163	*****	*****	*****	*****

Sharp Radius L.E.

Run No. = 93, Point No. = 2069

$C_N = 0.628$, $C_m = -0.1001$

$\alpha = 13.4^\circ$, $M_\infty = 0.849$

$R_{mac} = 35.9 \times 10^6$

Surface Pressures Near Leading Edge

● / ◆ upper, starboard/port
○ / ◇ lower, starboard/port

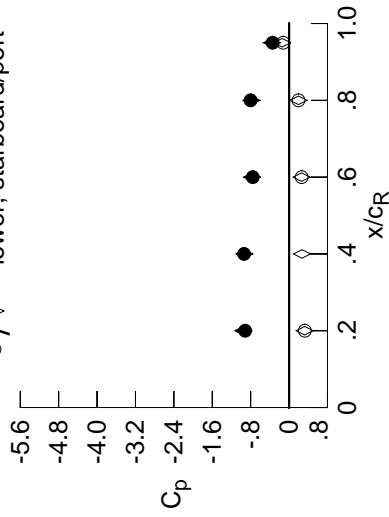

x/c_R	η	starb'd	port	starb'd	port
		$C_{p,u}$	$C_{p,l}$	$C_{p,u}$	$C_{p,l}$
0.20	0.90	-0.9156	-0.9532	0.3255	0.3280
0.40	0.95	-0.9372	-0.9327	0.2699	*****
0.60	0.95	-0.7564	-0.7734	0.2610	0.2634
0.80	0.95	-0.8013	-0.7847	0.1960	0.1956
0.95	0.95	-0.3436	-0.3595	-0.1445	-0.1224

Table C3. Continued.

η	$x/c_R = .2$		$x/c_R = .4$		$x/c_R = .6$		$x/c_R = .8$		$x/c_R = .95$	
	$C_{p,u}$	$C_{p,u}$	$C_{p,u}$	$C_{p,u}$	$C_{p,u}$	$C_{p,u}$	$C_{p,u}$	$C_{p,u}$	$C_{p,u}$	$C_{p,u}$
0.050	-0.3031	-0.3197	-0.0973	*****	*****	*****	*****	*****	*****	*****
0.100	-0.3024	-0.3242	-0.1081	*****	*****	*****	*****	*****	*****	*****
0.150	-0.3135	-0.3252	-0.1185	*****	*****	*****	*****	*****	*****	*****
0.200	-0.3204	-0.3214	-0.1301	*****	*****	*****	*****	*****	*****	*****
0.250	*****	-0.3265	-0.1444	-0.3809	-0.2762	*****	*****	*****	*****	*****
0.300	-0.3404	-0.3261	-0.1561	-0.3609	-0.3651	*****	*****	*****	*****	*****
0.350	-0.3682	-0.3286	-0.1669	-0.3481	-0.5195	*****	*****	*****	*****	*****
0.400	-0.3856	-0.3252	-0.1771	-0.3343	-0.6903	*****	*****	*****	*****	*****
0.450	-0.3977	-0.3209	-0.1614	-0.3292	-0.7220	*****	*****	*****	*****	*****
0.500	-0.3685	-0.3144	-0.2099	-0.3494	-0.7398	*****	*****	*****	*****	*****
0.525	*****	-0.3256	-0.2402	-0.3803	-0.7739	*****	*****	*****	*****	*****
0.550	-0.3118	-0.3676	-0.3116	-0.4381	-0.8269	*****	*****	*****	*****	*****
0.575	*****	-0.4880	-0.4246	-0.5355	-0.9229	*****	*****	*****	*****	*****
0.600	-0.5072	-0.7054	-0.6694	-0.6759	-1.0247	*****	*****	*****	*****	*****
0.625	*****	*****	-0.8976	-0.8465	-1.1486	*****	*****	*****	*****	*****
0.650	-0.9991	-1.1993	-1.1185	-1.0300	-0.9262	*****	*****	*****	*****	*****
0.675	*****	-1.3221	-1.2989	-1.1915	-0.7287	*****	*****	*****	*****	*****
0.700	-1.0403	-1.3567	-1.3893	-0.9242	-0.5892	*****	*****	*****	*****	*****
0.725	*****	-1.3345	*****	-0.8487	-0.5198	*****	*****	*****	*****	*****
0.750	-1.1925	-1.3146	*****	-0.8353	-0.4965	*****	*****	*****	*****	*****
0.775	*****	-1.2752	-1.0867	-0.8424	-0.4906	*****	*****	*****	*****	*****
0.800	-1.1961	-1.2139	-1.0059	-0.8625	*****	*****	*****	*****	*****	*****
0.825	*****	-1.1557	-0.9721	-0.8670	-0.4738	*****	*****	*****	*****	*****
0.850	-1.0661	-1.0946	-0.9584	-0.8714	-0.4399	*****	*****	*****	*****	*****
0.875	*****	-1.0421	-0.9766	-0.8388	-0.4284	*****	*****	*****	*****	*****
0.900	-0.9667	-1.0107	-0.9270	-0.8246	*****	*****	*****	*****	*****	*****
0.925	*****	-0.9796	-0.8271	-0.8432	-0.3681	*****	*****	*****	*****	*****
0.950	-1.0425	-0.9591	-0.8003	-0.8471	-0.3303	*****	*****	*****	*****	*****
0.975	*****	-0.9499	-0.7939	-0.8383	-0.3043	*****	*****	*****	*****	*****

η	$x/c_R = .2$		$x/c_R = .4$		$x/c_R = .6$		$x/c_R = .8$		$x/c_R = .95$	
	$C_{p,l}$	$C_{p,l}$	$C_{p,l}$	$C_{p,l}$	$C_{p,l}$	$C_{p,l}$	$C_{p,l}$	$C_{p,l}$	$C_{p,l}$	$C_{p,l}$
-0.200	0.3259	0.2964	0.3092	*****	*****	*****	*****	*****	*****	*****
-0.400	0.3232	0.3044	0.2821	0.1040	0.6640	*****	*****	*****	*****	*****
-0.600	*****	0.3131	0.2784	0.1324	0.6367	*****	*****	*****	*****	*****
-0.700	*****	0.3177	0.2777	0.1509	0.6053	*****	*****	*****	*****	*****
-0.800	0.3673	0.3336	0.2871	0.1747	0.5226	*****	*****	*****	*****	*****
-0.850	0.3612	0.3302	0.2981	0.1870	0.5015	*****	*****	*****	*****	*****
-0.900	0.3353	0.3303	0.2972	0.2045	0.4608	*****	*****	*****	*****	*****
-0.950	*****	*****	0.2598	0.1941	0.1168	*****	*****	*****	*****	*****
-0.975	*****	0.1828	0.1713	0.1348	0.0189	*****	*****	*****	*****	*****

Sharp Radius L.E.
 Run No. = 93, Point No. = 2070
 $C_N = 0.683$, $C_m = -0.1087$
 $\alpha = 14.4^\circ$, $M_\infty = 0.850$
 $R_{mac} = 35.9 \times 10^6$

Surface Pressures Near Leading Edge

● / ◆ upper, starboard/port
 ○ / ◇ lower, starboard/port

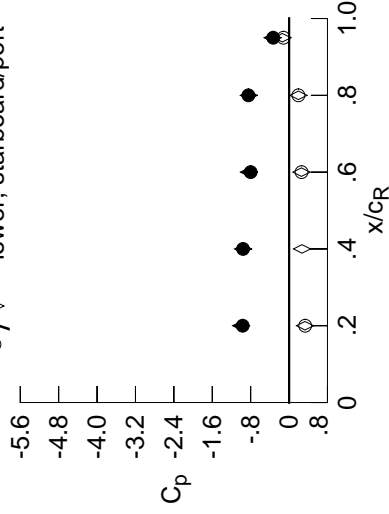

x/c_R	η	starb'd	port	starb'd	port
		$C_{p,u}$	$C_{p,l}$	$C_{p,u}$	$C_{p,l}$
0.20	0.90	-0.9667	-0.9992	0.3323	0.3353
0.40	0.95	-0.9591	-0.9575	0.2698	*****
0.60	0.95	-0.8003	-0.8359	0.2578	0.2598
0.80	0.95	-0.8471	-0.8395	0.1953	0.1941
0.95	0.95	-0.3303	-0.3440	-0.1398	-0.1168

Table C3. Continued.

η	$x/c_R = .2$		$x/c_R = .4$		$x/c_R = .6$		$x/c_R = .8$		$x/c_R = .95$	
	$C_{p,u}$	$C_{p,l}$	$C_{p,u}$	$C_{p,l}$	$C_{p,u}$	$C_{p,l}$	$C_{p,u}$	$C_{p,l}$	$C_{p,u}$	$C_{p,l}$
0.050	-0.3366	-0.3907	-0.1327	*****	*****	*****	*****	*****	*****	*****
0.100	-0.3341	-0.3970	-0.1445	*****	*****	*****	*****	*****	*****	*****
0.150	-0.3442	-0.3965	-0.1558	*****	*****	*****	*****	*****	*****	*****
0.200	-0.3495	-0.3927	-0.1682	*****	*****	*****	*****	*****	*****	*****
0.250	*****	-0.3959	-0.1836	-0.4524	-0.4014	*****	*****	*****	*****	*****
0.300	-0.3620	-0.3933	-0.1962	-0.4363	-0.4914	*****	*****	*****	*****	*****
0.350	-0.3793	-0.3957	-0.2115	-0.4267	-0.6454	*****	*****	*****	*****	*****
0.400	-0.3828	-0.3921	-0.2319	-0.4235	-0.7334	*****	*****	*****	*****	*****
0.450	-0.3795	-0.4017	-0.2502	-0.4461	-0.7694	*****	*****	*****	*****	*****
0.500	-0.3606	-0.4433	-0.3833	-0.5237	-0.8489	*****	*****	*****	*****	*****
0.525	*****	-0.5213	-0.4928	-0.5985	-0.9146	*****	*****	*****	*****	*****
0.550	-0.5210	-0.6663	-0.6490	-0.7052	-1.0030	*****	*****	*****	*****	*****
0.575	*****	-0.8855	-0.8264	-0.8409	-1.1165	*****	*****	*****	*****	*****
0.600	-1.0717	-1.1093	-1.0569	-0.9921	-1.1871	*****	*****	*****	*****	*****
0.625	*****	*****	-1.2222	-1.1443	-0.7867	*****	*****	*****	*****	*****
0.650	-1.3089	-1.4519	-1.3522	-1.2694	-0.7165	*****	*****	*****	*****	*****
0.675	*****	-1.5322	-1.4695	-0.9533	-0.5901	*****	*****	*****	*****	*****
0.700	-1.3944	-1.5714	-1.2383	-0.9176	-0.5249	*****	*****	*****	*****	*****
0.725	*****	-1.5257	*****	-0.9169	-0.5074	*****	*****	*****	*****	*****
0.750	-1.2398	-1.3942	*****	-0.9199	-0.4988	*****	*****	*****	*****	*****
0.775	*****	-1.3769	-1.1555	-0.9392	-0.4876	*****	*****	*****	*****	*****
0.800	-1.2093	-1.2734	-1.1561	-0.9724	*****	*****	*****	*****	*****	*****
0.825	*****	-1.1866	-1.1517	-0.9518	-0.4533	*****	*****	*****	*****	*****
0.850	-1.1661	-1.1368	-1.1456	-0.9309	-0.4169	*****	*****	*****	*****	*****
0.875	*****	-1.1010	-1.0778	-0.8972	-0.4024	*****	*****	*****	*****	*****
0.900	-1.0774	-1.0814	-0.9751	-0.8876	*****	*****	*****	*****	*****	*****
0.925	*****	-1.0426	-0.9152	-0.9068	-0.3609	*****	*****	*****	*****	*****
0.950	-1.1223	-1.0102	-0.8984	-0.9112	-0.3305	*****	*****	*****	*****	*****
0.975	*****	-0.9920	-0.8869	-0.9031	-0.3122	*****	*****	*****	*****	*****
-0.200	$C_{p,l}$	0.3843	0.3447	0.3463	*****	-0.5791	$C_{p,l}$	0.3843	0.3447	0.3463
-0.400	0.3830	0.3526	0.3198	0.1363	0.1363	0.6438	0.3830	0.3526	0.3198	0.1363
-0.600	*****	0.3610	0.3176	0.1648	0.16173	0.3610	0.3176	0.1648	0.16173	0.3610
-0.700	*****	0.3663	0.3148	0.1826	0.5835	0.3663	0.3148	0.1826	0.5835	0.3663
-0.800	0.4089	0.3755	0.3227	0.2057	0.4990	0.4089	0.3755	0.3227	0.2057	0.4990
-0.850	0.3948	0.3648	0.3299	0.2159	0.4754	0.3948	0.3648	0.3299	0.2159	0.4754
-0.900	0.3582	0.3528	0.3173	0.2274	0.4269	0.3582	0.3528	0.3173	0.2274	0.4269
-0.950	*****	*****	0.2564	0.1966	-0.1100	*****	*****	0.2564	0.1966	-0.1100
-0.975	*****	0.1678	0.1482	0.1165	-0.0281	*****	0.1678	0.1482	0.1165	-0.0281

Sharp Radius L.E.

Run No. = 93, Point No. = 2071

$C_N = 0.787$, $C_m = -0.1198$

$\alpha = 16.5^\circ$, $M_\infty = 0.849$

$R_{mac} = 36.0 \times 10^6$

Surface Pressures Near Leading Edge

● / ◆ upper, starboard/port
○ / ◇ lower, starboard/port

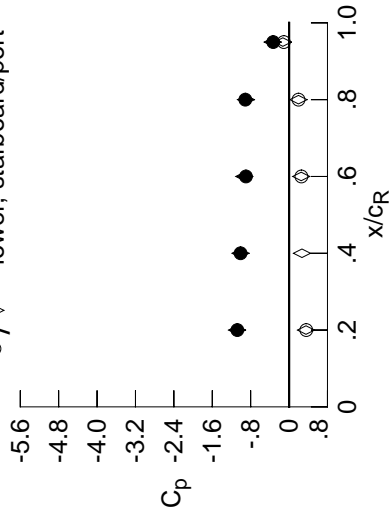

x/c_R	η	starb'd	port	starb'd	port
0.20	0.90	-1.0774	-1.0839	0.3527	0.3582
0.40	0.95	-1.0102	-1.0122	0.2686	*****
0.60	0.95	-0.8984	-0.9339	0.2530	0.2564
0.80	0.95	-0.9112	-0.8980	0.1960	0.1966
0.95	0.95	-0.3305	-0.3414	-0.1299	-0.1100

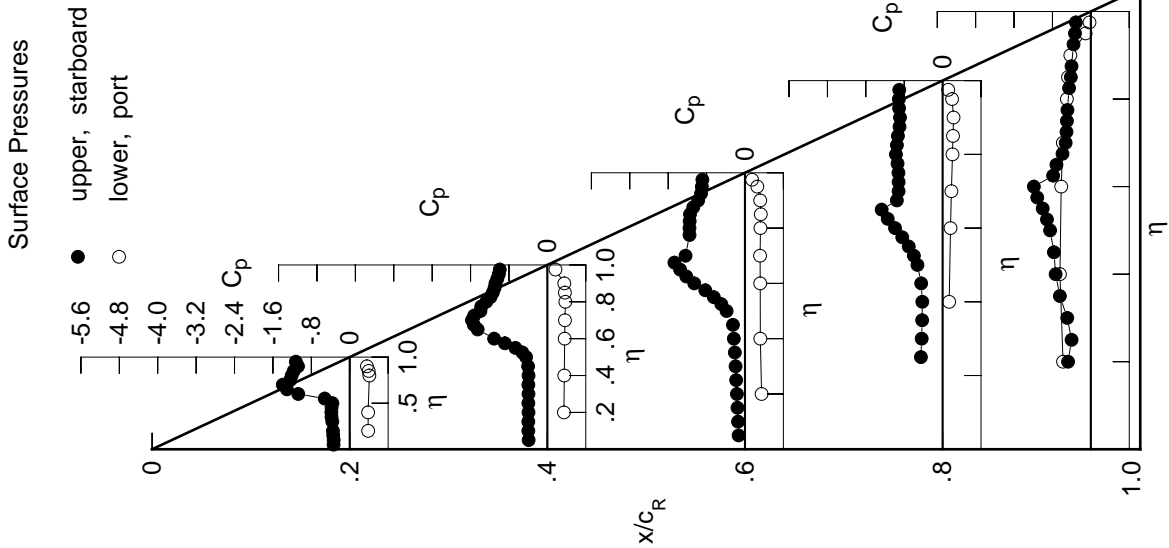

Table C3. Continued.

η	$x/c_R = .2$		$x/c_R = .4$		$x/c_R = .6$		$x/c_R = .8$		$x/c_R = .95$	
	$C_{p,u}$	$C_{p,l}$	$C_{p,u}$	$C_{p,l}$	$C_{p,u}$	$C_{p,l}$	$C_{p,u}$	$C_{p,l}$	$C_{p,u}$	$C_{p,l}$
0.050	-0.3532	-0.4399	-0.1736	*****	*****	*****	*****	*****	*****	*****
0.100	-0.3524	-0.4466	-0.1866	*****	*****	*****	*****	*****	*****	*****
0.150	-0.3564	-0.4436	-0.2020	*****	*****	*****	*****	*****	*****	*****
0.200	-0.3577	-0.4396	-0.2160	*****	*****	*****	*****	*****	*****	*****
0.250	*****	-0.4418	-0.2375	-0.5103	-0.6388	*****	*****	*****	*****	*****
0.300	-0.3509	-0.4414	-0.2596	-0.4991	-0.6696	*****	*****	*****	*****	*****
0.350	-0.3537	-0.4461	-0.2963	-0.5034	-0.6796	*****	*****	*****	*****	*****
0.400	-0.3436	-0.4620	-0.3546	-0.5278	-0.7112	*****	*****	*****	*****	*****
0.450	-0.3579	-0.5246	-0.4448	-0.6041	-0.7725	*****	*****	*****	*****	*****
0.500	-0.5117	-0.6813	-0.6827	-0.7548	-0.9079	*****	*****	*****	*****	*****
0.525	*****	-0.8262	-0.8405	-0.8653	-1.0029	*****	*****	*****	*****	*****
0.550	-1.0016	-1.0273	-1.0099	-0.9908	-1.1159	*****	*****	*****	*****	*****
0.575	*****	-1.2294	-1.1696	-1.1238	-1.2114	*****	*****	*****	*****	*****
0.600	-1.3716	-1.3859	-1.3339	-1.2508	-0.7960	*****	*****	*****	*****	*****
0.625	*****	*****	-1.4431	-1.3632	-0.7180	*****	*****	*****	*****	*****
0.650	-1.4117	-1.6405	-1.2613	-1.1660	-0.6554	*****	*****	*****	*****	*****
0.675	*****	-1.6743	-1.1826	-1.0808	-0.6132	*****	*****	*****	*****	*****
0.700	-1.4711	-1.6234	-1.1752	-1.0730	-0.6012	*****	*****	*****	*****	*****
0.725	*****	-1.4668	*****	-1.0818	-0.5936	*****	*****	*****	*****	*****
0.750	-1.3745	-1.4092	*****	-1.0853	-0.5755	*****	*****	*****	*****	*****
0.775	*****	-1.3462	-1.1924	-1.0972	-0.5387	*****	*****	*****	*****	*****
0.800	-1.3031	-1.2770	-1.2428	-1.1116	*****	*****	*****	*****	*****	*****
0.825	*****	-1.2225	-1.2816	-1.0882	-0.4672	*****	*****	*****	*****	*****
0.850	-1.2331	-1.1878	-1.2080	-1.0755	-0.4266	*****	*****	*****	*****	*****
0.875	*****	-1.1724	-1.0891	-1.0062	-0.4300	*****	*****	*****	*****	*****
0.900	-1.1901	-1.1554	-1.0432	-0.9458	*****	*****	*****	*****	*****	*****
0.925	*****	-1.1169	-1.0468	-0.9460	-0.4074	*****	*****	*****	*****	*****
0.950	-1.2295	-1.0943	-1.0520	-0.9585	-0.3671	*****	*****	*****	*****	*****
0.975	*****	-1.0836	-1.0446	-0.9617	-0.3478	*****	*****	*****	*****	*****
-0.200	0.4429	0.3947	0.3838	*****	-0.5543	*****	*****	*****	*****	*****
-0.400	0.4409	0.4000	0.3583	0.1685	-0.6211	*****	*****	*****	*****	*****
-0.600	*****	0.4075	0.3532	0.1988	-0.5949	*****	*****	*****	*****	*****
-0.700	*****	0.4110	0.3524	0.2133	-0.5586	*****	*****	*****	*****	*****
-0.800	0.4468	0.4136	0.3559	0.2353	-0.4730	*****	*****	*****	*****	*****
-0.850	0.4237	0.3950	0.3566	0.2434	-0.4484	*****	*****	*****	*****	*****
-0.900	0.3762	0.3701	0.3329	0.2467	-0.3959	*****	*****	*****	*****	*****
-0.950	*****	*****	0.2496	0.1949	-0.1027	*****	*****	*****	*****	*****
-0.975	*****	0.1494	0.1215	0.0978	-0.0394	*****	*****	*****	*****	*****

Sharp Radius L.E.
 Run No. = 93, Point No. = 2072
 $C_N = 0.903$, $C_m = -0.1390$
 $\alpha = 18.5^\circ$, $M_\infty = 0.849$
 $R_{mac} = 35.9 \times 10^6$

Surface Pressures Near Leading Edge

● / ◆ upper, starboard/port
 ○ / ◇ lower, starboard/port

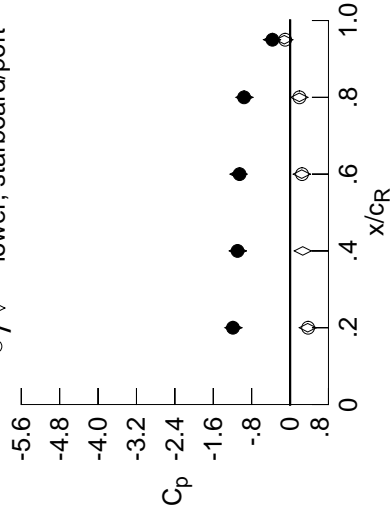

x/c_R	η	starb'd	port	starb'd	port
		$C_{p,u}$	$C_{p,l}$	$C_{p,u}$	$C_{p,l}$
0.20	0.90	-1.1901	-1.1817	0.3678	0.3762
0.40	0.95	-1.0943	-1.0900	0.2642	*****
0.60	0.95	-1.0520	-1.0750	0.2431	0.2496
0.80	0.95	-0.9585	-0.9519	0.1932	0.1949
0.95	0.95	-0.3671	-0.3754	-0.1212	-0.1027

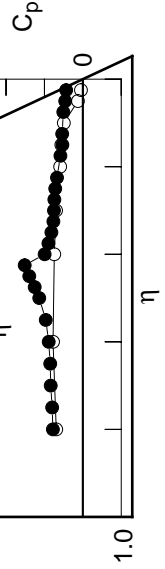

Table C3. Concluded.

η	x/c_R .2	$C_{p,u}$	x/c_R .4	$C_{p,u}$	x/c_R .6	$C_{p,u}$	x/c_R .8	$C_{p,u}$	x/c_R .95	$C_{p,u}$
0.050		-0.4451		-0.5257		-0.4803		*****		*****
0.100		-0.4484		-0.5335		-0.4807		*****		*****
0.150		-0.4542		-0.5330		-0.4931		*****		*****
0.200		-0.4603		-0.5324		-0.5047		*****		-0.3483
0.250		*****		-0.5419		-0.5226		-0.5978		-0.4622
0.300		-0.4778		-0.5514		-0.5395		-0.6036		-0.5222
0.350		-0.5055		-0.5778		-0.5793		-0.6238		-0.5571
0.400		-0.5317		-0.6322		-0.6629		-0.6791		-0.6211
0.450		-0.6468		-0.7745		-0.8033		-0.7934		-0.7209
0.500		-0.9917		-1.0000		-1.0624		-0.9785		-0.9030
0.525		*****		-1.1403		-1.1968		-1.0901		-1.0134
0.550		-1.3891		-1.3176		-1.3239		-1.2031		-1.1394
0.575		*****		-1.4590		-1.4309		-1.3152		-1.2424
0.600		-1.5987		-1.5584		-1.5344		-1.4125		-0.8268
0.625		*****		*****		-1.5238		-1.4971		-0.6879
0.650		-1.5908		-1.5924		-1.3291		-1.2398		-0.6610
0.675		*****		-1.4434		-1.3271		-1.2008		-0.6547
0.700		-1.4590		-1.4276		-1.3236		-1.1850		-0.6390
0.725		*****		-1.4330		*****		-1.1809		-0.6199
0.750		-1.3701		-1.4311		*****		-1.1785		-0.5922
0.775		*****		-1.4273		-1.3335		-1.1709		-0.5576
0.800		-1.3572		-1.4230		-1.3809		-1.1639		*****
0.825		*****		-1.4075		-1.3866		-1.1345		-0.5228
0.850		-1.3507		-1.3545		-1.3174		-1.1342		-0.4605
0.875		*****		-1.2864		-1.2282		-1.0678		-0.4765
0.900		-1.2883		-1.2426		-1.2067		-0.9938		*****
0.925		*****		-1.2222		-1.2065		-0.9946		-0.4420
0.950		-1.3293		-1.2143		-1.2047		-1.0119		-0.3939
0.975		*****		-1.2111		-1.1979		-1.0153		-0.3659
-0.200		$C_{p,l}$		0.4417		0.4232		*****		-0.5303
-0.400		0.4993		0.4488		0.3973		0.2041		-0.5963
-0.600		*****		0.4530		0.3916		0.2314		-0.5691
-0.700		*****		0.4563		0.3899		0.2447		-0.5319
-0.800		0.4827		0.4494		0.3890		0.2634		-0.4437
-0.850		0.4514		0.4204		0.3835		0.2679		-0.4184
-0.900		0.3924		0.3846		0.3471		0.2626		-0.3629
-0.950		*****		*****		0.2427		0.1906		-0.0912
-0.975		*****		0.1308		0.0994		0.0771		-0.0452

Sharp Radius L.E.
 Run No. = 93 , Point No. = 2073
 $C_N = 1.029$, $C_m = -0.1672$
 $\alpha = 20.6^\circ$, $M_\infty = 0.848$
 $R_{mac} = 35.9 \times 10^6$

Surface Pressures Near Leading Edge

● / ◆ upper, starboard/port
 ○ / ◇ lower, starboard/port

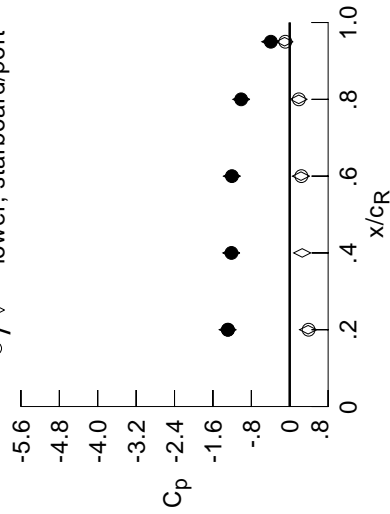

x/c_R	η	starb'd	port	starb'd	port
0.20	0.90	-1.2883	-1.2912	0.3822	0.3924
0.40	0.95	-1.2143	-1.2158	0.2588	*****
0.60	0.95	-1.2047	-1.2036	0.2346	0.2427
0.80	0.95	-1.0119	-1.0080	0.1882	0.1906
0.95	0.95	-0.3939	-0.4052	-0.1075	-0.0912

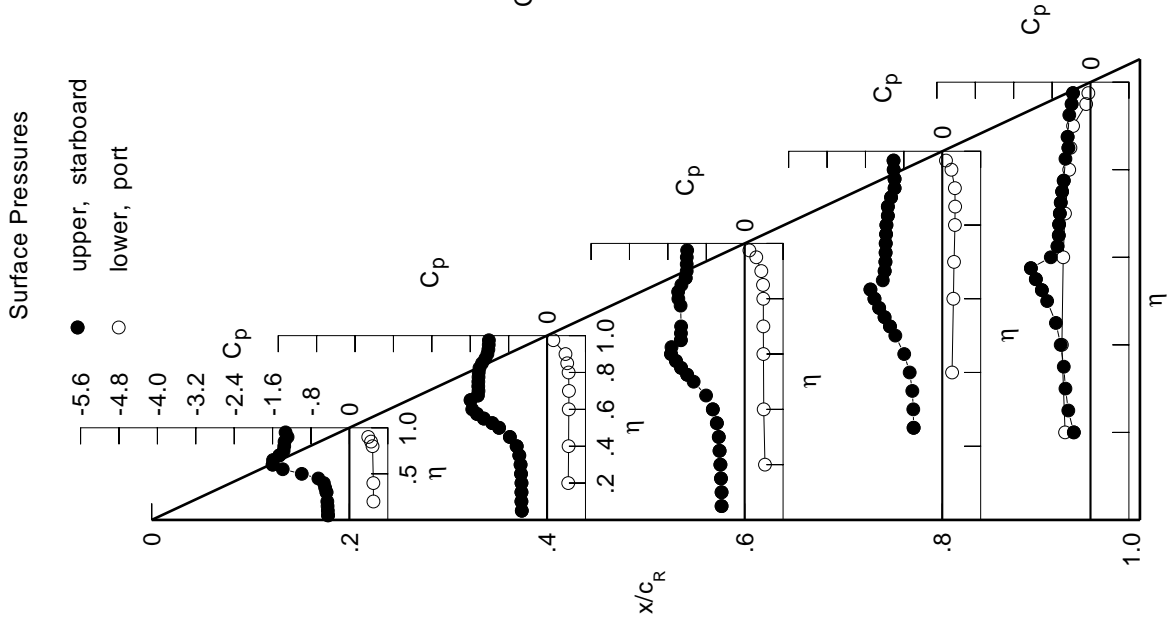

Appendix D

Experimental Surface Pressure Data for 65° Delta Wing, $R_{\text{mac}} = 6 \times 10^6$

The experimental surface pressure data for the 65° delta wing at constant $R_{\text{mac}} = 6 \times 10^6$ are summarized in tables D1–D6. Because of the extensive data contained in these tables, they have not been included in the printed copy of the paper but are available electronically from the Langley Technical Report Server (LTRS). Open the files with the following Uniform Resource Locator (URL):

<ftp://techreports.larc.nasa.gov/pub/techreports/larc/95/NASA-95-tm4645vol1appD.ps.Z>

Table D1. Tabulations and Plots of Surface Pressure Coefficients

η	x/c_R .2	$C_{p,u}$	x/c_R .4	$C_{p,u}$	x/c_R .6	$C_{p,u}$	x/c_R .8	$C_{p,u}$	x/c_R .95	$C_{p,u}$
0.050		-0.0129	-0.0009	0.0956	0.0956	0.0956	0.0956	0.0956	0.0956	0.0956
0.100		-0.0104	0.0003	0.0901	0.0901	0.0901	0.0901	0.0901	0.0901	0.0901
0.150		-0.0181	-0.0049	0.0704	0.0704	0.0704	0.0704	0.0704	0.0704	0.0704
0.200		-0.0189	-0.0020	0.0602	0.0602	0.0602	0.0602	0.0602	0.0602	0.0602
0.250		*****	-0.0096	0.0478	-0.0938	-0.2699	-0.2699	-0.2699	-0.2699	-0.2699
0.300		-0.0378	-0.0013	0.0313	-0.0818	-0.2872	-0.2872	-0.2872	-0.2872	-0.2872
0.350		-0.0432	-0.0057	0.0198	-0.0710	-0.2913	-0.2913	-0.2913	-0.2913	-0.2913
0.400		-0.0506	-0.0090	0.0231	-0.0665	-0.3021	-0.3021	-0.3021	-0.3021	-0.3021
0.450		-0.0603	-0.0080	0.0106	-0.0641	-0.2998	-0.2998	-0.2998	-0.2998	-0.2998
0.500		-0.0648	-0.0120	0.0030	-0.0608	-0.3087	-0.3087	-0.3087	-0.3087	-0.3087
0.525		*****	-0.0142	-0.0027	-0.0589	-0.3164	-0.3164	-0.3164	-0.3164	-0.3164
0.550		-0.0662	-0.0178	-0.0035	-0.0610	-0.3153	-0.3153	-0.3153	-0.3153	-0.3153
0.575		*****	-0.0223	0.0015	-0.0565	-0.3131	-0.3131	-0.3131	-0.3131	-0.3131
0.600		-0.0480	-0.0172	-0.0039	-0.0597	-0.3105	-0.3105	-0.3105	-0.3105	-0.3105
0.625		*****	*****	-0.0082	-0.0619	-0.3201	-0.3201	-0.3201	-0.3201	-0.3201
0.650		-0.0513	-0.0254	-0.0103	-0.0602	-0.3174	-0.3174	-0.3174	-0.3174	-0.3174
0.675		*****	-0.0304	-0.0129	-0.0680	-0.3053	-0.3053	-0.3053	-0.3053	-0.3053
0.700		-0.0451	-0.0417	-0.0194	-0.0632	-0.3207	-0.3207	-0.3207	-0.3207	-0.3207
0.725		*****	-0.0637	*****	-0.0665	-0.3142	-0.3142	-0.3142	-0.3142	-0.3142
0.750		-0.0235	-0.0652	*****	-0.0662	-0.3269	-0.3269	-0.3269	-0.3269	-0.3269
0.775		*****	-0.0715	-0.0336	-0.0684	-0.3183	-0.3183	-0.3183	-0.3183	-0.3183
0.800		-0.0043	-0.0688	-0.0484	-0.0695	*****	*****	*****	*****	*****
0.825		*****	-0.0618	-0.0649	-0.0796	-0.3675	-0.3675	-0.3675	-0.3675	-0.3675
0.850		0.0257	-0.0571	-0.0736	-0.0999	-0.3188	-0.3188	-0.3188	-0.3188	-0.3188
0.875		*****	-0.0348	-0.0754	-0.1197	-0.4494	-0.4494	-0.4494	-0.4494	-0.4494
0.900		0.0652	-0.0144	-0.0529	-0.1210	*****	*****	*****	*****	*****
0.925		*****	0.0157	-0.0375	-0.1018	-0.8588	-0.8588	-0.8588	-0.8588	-0.8588
0.950		0.1084	0.0612	0.0120	-0.0634	-0.3979	-0.3979	-0.3979	-0.3979	-0.3979
0.975		*****	0.1063	0.0726	0.0201	-0.1690	-0.1690	-0.1690	-0.1690	-0.1690

η	$C_{p,l}$	$C_{p,l}$	$C_{p,l}$	$C_{p,l}$	$C_{p,l}$	$C_{p,l}$
-0.200	-0.0619	-0.0147	0.0434	*****	-0.2695	-0.2695
-0.400	-0.0796	-0.0182	0.0075	-0.0797	-0.2915	-0.2915
-0.600	*****	-0.0331	-0.0208	-0.0753	-0.3247	-0.3247
-0.700	*****	-0.0775	-0.0322	-0.0825	-0.3497	-0.3497
-0.800	-0.0520	-0.1140	-0.0938	-0.0871	-0.3987	-0.3987
-0.850	-0.0198	-0.0963	-0.1167	-0.1462	-0.4685	-0.4685
-0.900	0.0120	-0.0707	-0.1189	-0.1760	-0.7066	-0.7066
-0.950	*****	*****	-0.0558	-0.1328	-0.4308	-0.4308
-0.975	*****	0.0460	-0.0004	-0.0618	-0.2102	-0.2102

Sharp Radius L.E.
 Run No. = 84 , Point No. = 1815
 $C_N = -0.027$, $C_m = -0.0022$
 $\alpha = -0.4^\circ$, $M_\infty = 0.401$
 $R_{mac} = 6.0 \times 10^6$

Surface Pressures Near Leading Edge

● / ◆ upper, starboard/port
 ○ / ◇ lower, starboard/port

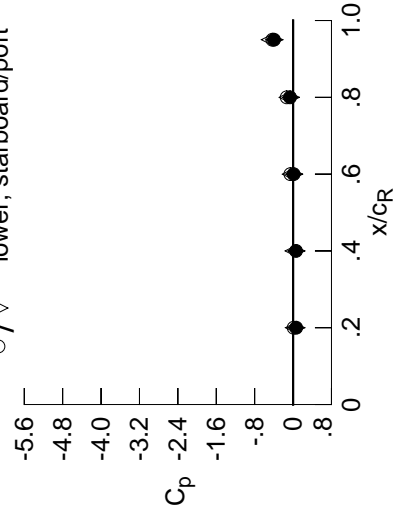

x/c_R	η	starb'd	port	starb'd	port
0.20	0.90	0.0652	0.0669	0.0182	0.0120
0.40	0.95	0.0612	0.0671	0.0108	*****
0.60	0.95	0.0120	0.0214	-0.0447	-0.0558
0.80	0.95	-0.0634	-0.0463	-0.1116	-0.1328
0.95	0.95	-0.3979	-0.3906	-0.4827	-0.4308

Surface Pressures

● upper, starboard
 ○ lower, port

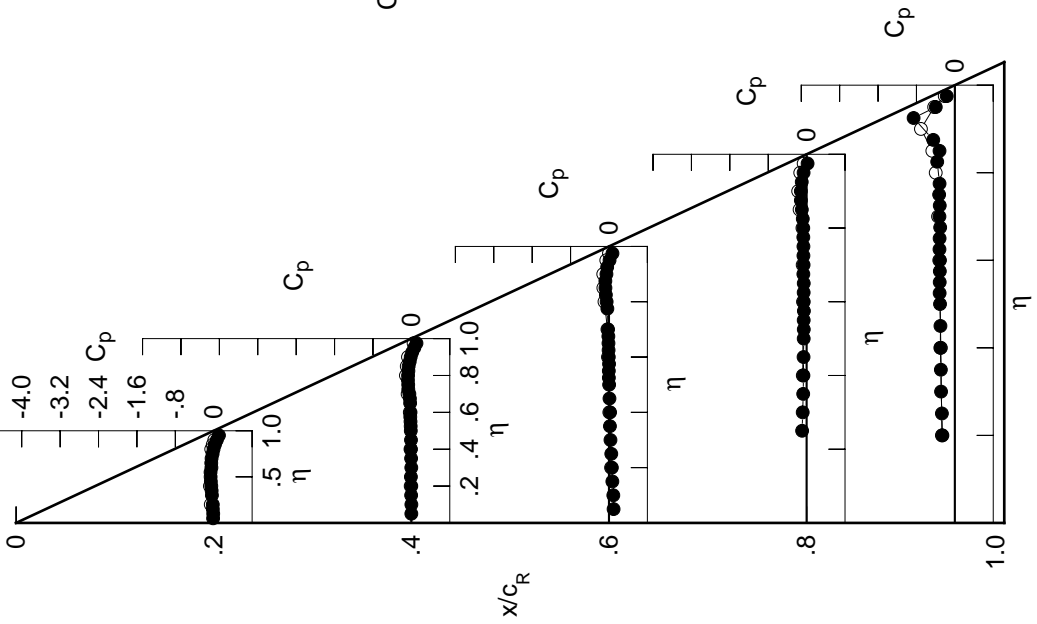

Table D1. Continued.

η	$x/c_R = .2$		$x/c_R = .4$		$x/c_R = .6$		$x/c_R = .8$		$x/c_R = .95$	
	$C_{p,u}$	$C_{p,l}$	$C_{p,u}$	$C_{p,l}$	$C_{p,u}$	$C_{p,l}$	$C_{p,u}$	$C_{p,l}$	$C_{p,u}$	$C_{p,l}$
0.050	-0.0173	-0.0064	0.0936	0.0936	0.0936	0.0936	0.0936	0.0936	0.0936	0.0936
0.100	-0.0145	-0.0070	0.0855	0.0855	0.0855	0.0855	0.0855	0.0855	0.0855	0.0855
0.150	-0.0243	-0.0093	0.0658	0.0658	0.0658	0.0658	0.0658	0.0658	0.0658	0.0658
0.200	-0.0314	-0.0094	0.0528	0.0528	0.0528	0.0528	0.0528	0.0528	0.0528	0.0528
0.250	*****	-0.0113	0.0433	-0.0977	0.0433	-0.0977	0.0433	-0.0977	0.0433	-0.2542
0.300	-0.0459	-0.0107	0.0203	-0.0845	0.0203	-0.0845	0.0203	-0.0845	0.0203	-0.2833
0.350	-0.0535	-0.0101	0.0167	-0.0751	0.0167	-0.0751	0.0167	-0.0751	0.0167	-0.2915
0.400	-0.0591	-0.0135	0.0130	-0.0698	0.0130	-0.0698	0.0130	-0.0698	0.0130	-0.2989
0.450	-0.0701	-0.0159	0.0090	-0.0687	0.0090	-0.0687	0.0090	-0.0687	0.0090	-0.3026
0.500	-0.0756	-0.0232	-0.0037	-0.0643	-0.0037	-0.0643	-0.0037	-0.0643	-0.0037	-0.3081
0.525	*****	-0.0213	-0.0074	-0.0619	-0.0074	-0.0619	-0.0074	-0.0619	-0.0074	-0.3188
0.550	-0.0773	-0.0270	-0.0084	-0.0642	-0.0084	-0.0642	-0.0084	-0.0642	-0.0084	-0.3123
0.575	*****	-0.0294	-0.0048	-0.0629	-0.0048	-0.0629	-0.0048	-0.0629	-0.0048	-0.3106
0.600	-0.0635	-0.0260	-0.0090	-0.0612	-0.0090	-0.0612	-0.0090	-0.0612	-0.0090	-0.3108
0.625	*****	*****	-0.0147	-0.0702	-0.0147	-0.0702	-0.0147	-0.0702	-0.0147	-0.3239
0.650	-0.0673	-0.0356	-0.0166	-0.0656	-0.0166	-0.0656	-0.0166	-0.0656	-0.0166	-0.3216
0.675	*****	-0.0540	-0.0235	-0.0741	-0.0235	-0.0741	-0.0235	-0.0741	-0.0235	-0.3165
0.700	-0.0594	-0.0602	-0.0279	-0.0693	-0.0279	-0.0693	-0.0279	-0.0693	-0.0279	-0.3290
0.725	*****	-0.0795	*****	-0.0739	-0.0739	-0.0739	-0.0739	-0.0739	-0.0739	-0.3337
0.750	-0.0393	-0.0808	*****	-0.0760	-0.0760	-0.0760	-0.0760	-0.0760	-0.0760	-0.3513
0.775	*****	-0.0869	-0.0600	-0.0745	-0.0600	-0.0745	-0.0600	-0.0745	-0.0600	-0.3515
0.800	-0.0218	-0.0857	-0.0688	-0.0775	-0.0688	-0.0775	-0.0688	-0.0775	-0.0688	-0.3515
0.825	*****	-0.0836	-0.0816	-0.0964	-0.0816	-0.0964	-0.0816	-0.0964	-0.0816	-0.4021
0.850	0.0085	-0.0715	-0.0895	-0.1238	-0.0895	-0.1238	-0.0895	-0.1238	-0.0895	-0.3920
0.875	*****	-0.0598	-0.0944	-0.1376	-0.0944	-0.1376	-0.0944	-0.1376	-0.0944	-0.4781
0.900	0.0490	-0.0370	-0.0764	-0.1425	-0.0764	-0.1425	-0.0764	-0.1425	-0.0764	-0.4781
0.925	*****	-0.0044	-0.0585	-0.1247	-0.0585	-0.1247	-0.0585	-0.1247	-0.0585	-0.9000
0.950	0.0933	0.0343	-0.0134	-0.0840	-0.0134	-0.0840	-0.0134	-0.0840	-0.0134	-0.4285
0.975	*****	0.0831	0.0458	-0.0072	0.0458	-0.0072	0.0458	-0.0072	0.0458	-0.1926

η	$x/c_R = .2$		$x/c_R = .4$		$x/c_R = .6$		$x/c_R = .8$		$x/c_R = .95$	
	$C_{p,u}$	$C_{p,l}$	$C_{p,u}$	$C_{p,l}$	$C_{p,u}$	$C_{p,l}$	$C_{p,u}$	$C_{p,l}$	$C_{p,u}$	$C_{p,l}$
-0.200	-0.0491	-0.0101	0.0508	0.0508	0.0508	0.0508	0.0508	0.0508	0.0508	0.0508
-0.400	-0.0598	-0.0067	0.0125	-0.0752	0.0125	-0.0752	0.0125	-0.0752	0.0125	-0.2946
-0.600	*****	-0.0243	-0.0106	-0.0705	-0.0106	-0.0705	-0.0106	-0.0705	-0.0106	-0.3230
-0.700	*****	-0.0627	-0.0246	-0.0733	-0.0246	-0.0733	-0.0246	-0.0733	-0.0246	-0.3465
-0.800	-0.0343	-0.0979	-0.0782	-0.0841	-0.0782	-0.0841	-0.0782	-0.0841	-0.0782	-0.3898
-0.850	-0.0012	-0.0775	-0.0959	-0.1306	-0.0959	-0.1306	-0.0959	-0.1306	-0.0959	-0.4550
-0.900	0.0318	-0.0475	-0.0968	-0.1563	-0.0968	-0.1563	-0.0968	-0.1563	-0.0968	-0.6905
-0.950	*****	*****	-0.0283	-0.1045	-0.0283	-0.1045	-0.0283	-0.1045	-0.0283	-0.4394
-0.975	*****	0.0683	0.0283	-0.0322	0.0283	-0.0322	0.0283	-0.0322	0.0283	-0.2101

Sharp Radius L.E.
 Run No. = 84 , Point No. = 1816
 $C_N = -0.001$, $C_m = -0.0125$
 $\alpha = 0.1^\circ$, $M_\infty = 0.400$
 $R_{mac} = 6.0 \times 10^6$

Surface Pressures Near Leading Edge

● / ◆ upper, starboard/port
 ○ / ◇ lower, starboard/port

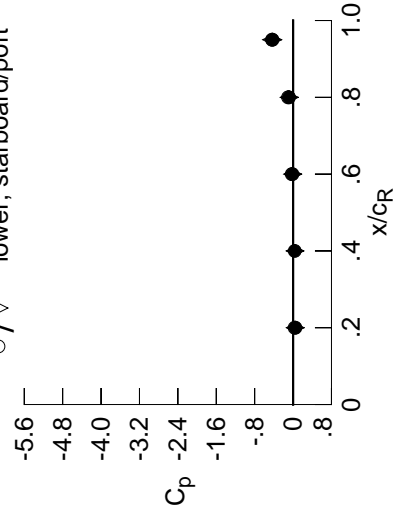

x/c_R	η	starb'd	port	starb'd	port
		$C_{p,u}$	$C_{p,l}$	$C_{p,u}$	$C_{p,l}$
0.20	0.90	0.0490	0.0512	0.0372	0.0318
0.40	0.95	0.0343	0.0459	0.0359	*****
0.60	0.95	-0.0134	0.0010	-0.0165	-0.0283
0.80	0.95	-0.0840	-0.0701	-0.0903	-0.1045
0.95	0.95	-0.4285	-0.4141	-0.4558	-0.4394

Table D1. Continued.

η	$x/c_R = .2$		$x/c_R = .4$		$x/c_R = .6$		$x/c_R = .8$		$x/c_R = .95$	
	$C_{p,u}$	$C_{p,l}$	$C_{p,u}$	$C_{p,l}$	$C_{p,u}$	$C_{p,l}$	$C_{p,u}$	$C_{p,l}$	$C_{p,u}$	$C_{p,l}$
0.050	-0.0320	-0.0221	0.0811	*****	*****	*****	*****	*****	*****	*****
0.100	-0.0348	-0.0208	0.0736	*****	*****	*****	*****	*****	*****	*****
0.150	-0.0422	-0.0219	0.0549	*****	*****	*****	*****	*****	*****	*****
0.200	-0.0479	-0.0260	0.0427	*****	*****	*****	*****	*****	*****	*****
0.250	*****	-0.0292	0.0318	-0.1033	-0.2654	*****	*****	*****	*****	*****
0.300	-0.0657	-0.0280	0.0155	-0.0882	-0.2738	*****	*****	*****	*****	*****
0.350	-0.0755	-0.0284	0.0049	-0.0843	-0.2786	*****	*****	*****	*****	*****
0.400	-0.0839	-0.0320	-0.0006	-0.0769	-0.2806	*****	*****	*****	*****	*****
0.450	-0.0932	-0.0366	-0.0074	-0.0735	-0.2820	*****	*****	*****	*****	*****
0.500	-0.1005	-0.0415	-0.0156	-0.0761	-0.2859	*****	*****	*****	*****	*****
0.525	*****	-0.0445	-0.0268	-0.0750	-0.2948	*****	*****	*****	*****	*****
0.550	-0.1062	-0.0460	-0.0219	-0.0760	-0.2911	*****	*****	*****	*****	*****
0.575	*****	-0.0525	-0.0251	-0.0757	-0.2862	*****	*****	*****	*****	*****
0.600	-0.0959	-0.0525	-0.0309	-0.0704	-0.2901	*****	*****	*****	*****	*****
0.625	*****	*****	-0.0392	-0.0827	-0.2977	*****	*****	*****	*****	*****
0.650	-0.0999	-0.0600	-0.0386	-0.0768	-0.3003	*****	*****	*****	*****	*****
0.675	*****	-0.0713	-0.0484	-0.0888	-0.2937	*****	*****	*****	*****	*****
0.700	-0.0946	-0.0862	-0.0518	-0.0837	-0.3128	*****	*****	*****	*****	*****
0.725	*****	-0.1046	*****	-0.0911	-0.3239	*****	*****	*****	*****	*****
0.750	-0.0767	-0.1088	*****	-0.0925	-0.3452	*****	*****	*****	*****	*****
0.775	*****	-0.1204	-0.0747	-0.0983	-0.3536	*****	*****	*****	*****	*****
0.800	-0.0631	-0.1188	-0.0981	-0.1030	*****	*****	*****	*****	*****	*****
0.825	*****	-0.1175	-0.1138	-0.1235	-0.4158	*****	*****	*****	*****	*****
0.850	-0.0318	-0.1137	-0.1276	-0.1463	-0.4276	*****	*****	*****	*****	*****
0.875	*****	-0.1019	-0.1331	-0.1749	-0.5227	*****	*****	*****	*****	*****
0.900	0.0069	-0.0831	-0.1188	-0.1840	*****	*****	*****	*****	*****	*****
0.925	*****	-0.0564	-0.1090	-0.1735	-0.8866	*****	*****	*****	*****	*****
0.950	0.0482	-0.0168	-0.0665	-0.1444	-0.4201	*****	*****	*****	*****	*****
0.975	*****	0.0304	-0.0075	-0.0660	-0.2061	*****	*****	*****	*****	*****
-0.200	-0.0236	0.0077	0.0602	*****	-0.2765	*****	*****	*****	*****	*****
-0.400	-0.0417	0.0075	0.0269	-0.0660	-0.3029	*****	*****	*****	*****	*****
-0.600	*****	-0.0063	0.0035	-0.0605	-0.3219	*****	*****	*****	*****	*****
-0.700	*****	-0.0317	-0.0038	-0.0619	-0.3305	*****	*****	*****	*****	*****
-0.800	0.0026	-0.0579	-0.0407	-0.0686	-0.3412	*****	*****	*****	*****	*****
-0.850	0.0369	-0.0356	-0.0622	-0.0903	-0.3903	*****	*****	*****	*****	*****
-0.900	0.0704	0.0006	-0.0479	-0.1112	-0.6143	*****	*****	*****	*****	*****
-0.950	*****	*****	0.0247	-0.0484	-0.3831	*****	*****	*****	*****	*****
-0.975	*****	0.1156	0.0830	0.0264	-0.1583	*****	*****	*****	*****	*****

Sharp Radius L.E.
 Run No. = 84 , Point No. = 1817
 $C_N = 0.028$, $C_m = -0.0106$
 $\alpha = 1.1^\circ$, $M_\infty = 0.400$
 $R_{mac} = 6.0 \times 10^6$

Surface Pressures Near Leading Edge

● / ◆ upper, starboard/port
 ○ / ◇ lower, starboard/port

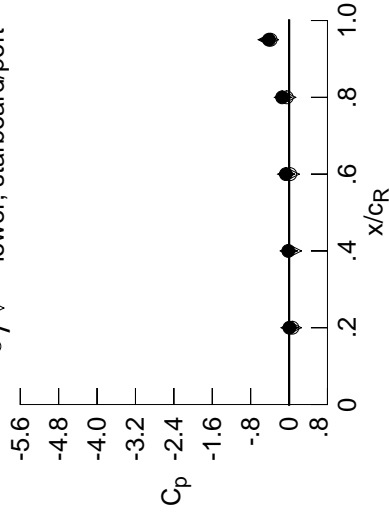

x/c_R	η	starb'd	port	starb'd	port
		$C_{p,u}$	$C_{p,l}$	$C_{p,u}$	$C_{p,l}$
0.20	0.90	0.0069	0.0092	0.0779	0.0704
0.40	0.95	-0.0168	-0.0067	0.0793	*****
0.60	0.95	-0.0665	-0.0597	0.0336	0.0247
0.80	0.95	-0.1444	-0.1272	-0.0395	-0.0484
0.95	0.95	-0.4201	-0.4654	-0.4019	-0.3831

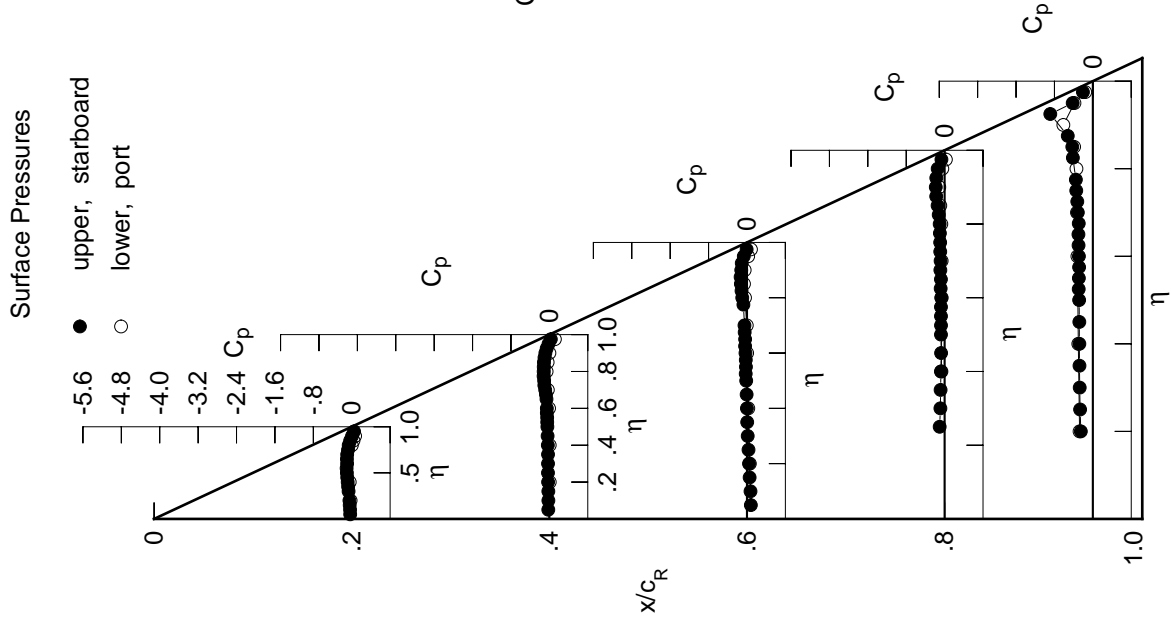

Table D1. Continued.

η	$x/c_R = .2$		$x/c_R = .4$		$x/c_R = .6$		$x/c_R = .8$		$x/c_R = .95$	
	$C_{p,u}$	$C_{p,l}$	$C_{p,u}$	$C_{p,l}$	$C_{p,u}$	$C_{p,l}$	$C_{p,u}$	$C_{p,l}$	$C_{p,u}$	$C_{p,l}$
0.050	-0.0510	-0.0356	0.0663	0.0663	0.0663	0.0663	0.0663	0.0663	0.0663	0.0663
0.100	-0.0506	-0.0346	0.0666	0.0666	0.0666	0.0666	0.0666	0.0666	0.0666	0.0666
0.150	-0.0682	-0.0340	0.0460	0.0460	0.0460	0.0460	0.0460	0.0460	0.0460	0.0460
0.200	-0.0730	-0.0416	0.0356	0.0356	0.0356	0.0356	0.0356	0.0356	0.0356	0.0356
0.250	*****	-0.0447	0.0218	-0.1050	-0.2561	0.0218	-0.1050	-0.2561	0.0218	-0.1050
0.300	-0.0747	-0.0411	0.0024	-0.0944	-0.2691	0.0024	-0.0944	-0.2691	0.0024	-0.0944
0.350	-0.0874	-0.0459	-0.0044	-0.0864	-0.2718	-0.0044	-0.0864	-0.2718	-0.0044	-0.0864
0.400	-0.0954	-0.0478	-0.0090	-0.0851	-0.2730	-0.0090	-0.0851	-0.2730	-0.0090	-0.0851
0.450	-0.1110	-0.0530	-0.0183	-0.0767	-0.2760	-0.0183	-0.0767	-0.2760	-0.0183	-0.0767
0.500	-0.1212	-0.0604	-0.0305	-0.0822	-0.2780	-0.0305	-0.0822	-0.2780	-0.0305	-0.0822
0.525	*****	-0.0630	-0.0393	-0.0781	-0.2852	-0.0393	-0.0781	-0.2852	-0.0393	-0.0781
0.550	-0.1287	-0.0691	-0.0408	-0.0805	-0.2792	-0.0408	-0.0805	-0.2792	-0.0408	-0.0805
0.575	*****	-0.0771	-0.0429	-0.0780	-0.2766	-0.0429	-0.0780	-0.2766	-0.0429	-0.0780
0.600	-0.1292	-0.0731	-0.0487	-0.0821	-0.2752	-0.0487	-0.0821	-0.2752	-0.0487	-0.0821
0.625	*****	*****	-0.0526	-0.0883	-0.2831	-0.0526	-0.0883	-0.2831	-0.0526	-0.0883
0.650	-0.1390	-0.0865	-0.0560	-0.0876	-0.2769	-0.0560	-0.0876	-0.2769	-0.0560	-0.0876
0.675	*****	-0.0960	-0.0651	-0.0990	-0.2650	-0.0651	-0.0990	-0.2650	-0.0651	-0.0990
0.700	-0.1309	-0.1130	-0.0681	-0.0940	-0.2775	-0.0681	-0.0940	-0.2775	-0.0681	-0.0940
0.725	*****	-0.1339	*****	-0.1007	-0.2703	-0.1007	-0.2703	-0.1007	-0.2703	-0.1007
0.750	-0.1100	-0.1372	*****	-0.1060	-0.2824	-0.1060	-0.2824	-0.1060	-0.2824	-0.1060
0.775	*****	-0.1517	-0.1054	-0.1169	-0.2672	-0.1169	-0.2672	-0.1169	-0.2672	-0.1169
0.800	-0.0958	-0.1618	-0.1240	-0.1201	*****	-0.1240	-0.1201	*****	-0.1240	-0.1201
0.825	*****	-0.1626	-0.1476	-0.1399	-0.3104	-0.1476	-0.1399	-0.3104	-0.1476	-0.1399
0.850	-0.0703	-0.1582	-0.1674	-0.1711	-0.3017	-0.1674	-0.1711	-0.3017	-0.1674	-0.1711
0.875	*****	-0.1491	-0.1764	-0.2001	-0.4025	-0.1764	-0.2001	-0.4025	-0.1764	-0.2001
0.900	-0.0360	-0.1350	-0.1715	-0.2141	*****	-0.1715	-0.2141	*****	-0.1715	-0.2141
0.925	*****	-0.1057	-0.1653	-0.2174	-0.9161	-0.1653	-0.2174	-0.9161	-0.1653	-0.2174
0.950	0.0023	-0.0716	-0.1254	-0.1913	-0.4808	-0.1254	-0.1913	-0.4808	-0.1254	-0.1913
0.975	*****	-0.0292	-0.0692	-0.1250	-0.2767	-0.0692	-0.1250	-0.2767	-0.0692	-0.1250

η	$C_{p,l}$		$C_{p,l}$		$C_{p,l}$		$C_{p,l}$		$C_{p,l}$	
	$C_{p,l}$	$C_{p,l}$	$C_{p,l}$	$C_{p,l}$	$C_{p,l}$	$C_{p,l}$	$C_{p,l}$	$C_{p,l}$	$C_{p,l}$	$C_{p,l}$
-0.200	0.0046	0.0244	0.0731	0.0731	0.0731	0.0731	0.0731	0.0731	0.0731	0.0731
-0.400	-0.0058	0.0225	0.0390	-0.0597	-0.3071	0.0390	-0.0597	-0.3071	0.0390	-0.0597
-0.600	*****	0.0160	0.0199	-0.0473	-0.3407	0.0199	-0.0473	-0.3407	0.0199	-0.0473
-0.700	*****	-0.0063	0.0168	-0.0470	-0.3634	0.0168	-0.0470	-0.3634	0.0168	-0.0470
-0.800	0.0395	-0.0170	-0.0152	-0.0494	-0.3982	-0.0152	-0.0494	-0.3982	-0.0152	-0.0494
-0.850	0.0715	0.0005	-0.0197	-0.0692	-0.4412	-0.0197	-0.0692	-0.4412	-0.0197	-0.0692
-0.900	0.1074	0.0444	-0.0035	-0.0698	-0.6084	-0.0035	-0.0698	-0.6084	-0.0035	-0.0698
-0.950	*****	*****	0.0685	-0.0040	-0.3570	0.0685	-0.0040	-0.3570	0.0685	-0.0040
-0.975	*****	0.1501	0.1223	0.0669	-0.1235	0.1223	0.0669	-0.1235	0.1223	0.0669

Sharp Radius L.E.
 Run No. = 84 , Point No. = 1818
 $C_N = 0.056$, $C_m = -0.0125$
 $\alpha = 2.1^\circ$, $M_\infty = 0.400$
 $R_{mac} = 6.0 \times 10^6$

Surface Pressures Near Leading Edge

● / ◆ upper, starboard/port
 ○ / ◇ lower, starboard/port

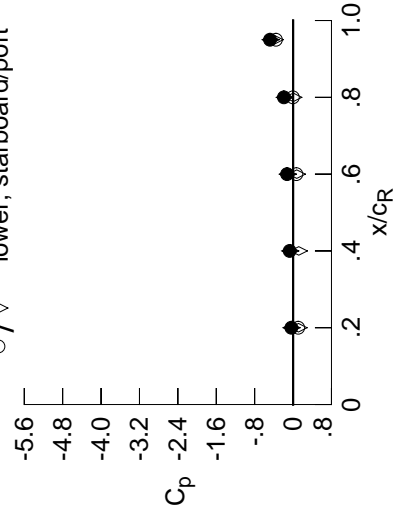

x/c_R	η	starb'd	port	starb'd	port
x/c_R	η	$C_{p,u}$	$C_{p,u}$	$C_{p,l}$	$C_{p,l}$
0.20	0.90	-0.0360	-0.0326	0.1138	0.1074
0.40	0.95	-0.0716	-0.0590	0.1192	0.0685
0.60	0.95	-0.1254	-0.1107	0.0775	0.0685
0.80	0.95	-0.1913	-0.1724	0.0040	-0.0040
0.95	0.95	-0.4808	-0.4672	-0.3849	-0.3570

Table D1. Continued.

η	$x/c_R = .2$		$x/c_R = .4$		$x/c_R = .6$		$x/c_R = .8$		$x/c_R = .95$	
	$C_{p,u}$	$C_{p,l}$	$C_{p,u}$	$C_{p,l}$	$C_{p,u}$	$C_{p,l}$	$C_{p,u}$	$C_{p,l}$	$C_{p,u}$	$C_{p,l}$
0.050	-0.0717	-0.0451	0.0613	0.0613	0.0613	0.0613	0.0613	0.0613	0.0613	0.0613
0.100	-0.0786	-0.0526	0.0497	0.0497	0.0497	0.0497	0.0497	0.0497	0.0497	0.0497
0.150	-0.0887	-0.0543	0.0418	0.0418	0.0418	0.0418	0.0418	0.0418	0.0418	0.0418
0.200	-0.0956	-0.0542	0.0222	0.0222	0.0222	0.0222	0.0222	0.0222	0.0222	0.0222
0.250	0.0000	-0.0582	0.0126	-0.1139	-0.2608	-0.2608	-0.2608	-0.2608	-0.2608	-0.2608
0.300	-0.1007	-0.0578	-0.0110	-0.0995	-0.2696	-0.2696	-0.2696	-0.2696	-0.2696	-0.2696
0.350	-0.1111	-0.0581	-0.0175	-0.0974	-0.2740	-0.2740	-0.2740	-0.2740	-0.2740	-0.2740
0.400	-0.1189	-0.0682	-0.0231	-0.0951	-0.2732	-0.2732	-0.2732	-0.2732	-0.2732	-0.2732
0.450	-0.1361	-0.0676	-0.0330	-0.0872	-0.2701	-0.2701	-0.2701	-0.2701	-0.2701	-0.2701
0.500	-0.1472	-0.0827	-0.0452	-0.0925	-0.2726	-0.2726	-0.2726	-0.2726	-0.2726	-0.2726
0.525	0.0000	-0.0813	-0.0520	-0.0909	-0.2801	-0.2801	-0.2801	-0.2801	-0.2801	-0.2801
0.550	-0.1599	-0.0887	-0.0551	-0.0913	-0.2706	-0.2706	-0.2706	-0.2706	-0.2706	-0.2706
0.575	0.0000	-0.0965	-0.0558	-0.0892	-0.2678	-0.2678	-0.2678	-0.2678	-0.2678	-0.2678
0.600	-0.1622	-0.1009	-0.0667	-0.0945	-0.2672	-0.2672	-0.2672	-0.2672	-0.2672	-0.2672
0.625	0.0000	0.0000	-0.0676	-0.1033	-0.2789	-0.2789	-0.2789	-0.2789	-0.2789	-0.2789
0.650	-0.1715	-0.1160	-0.0775	-0.1020	-0.2715	-0.2715	-0.2715	-0.2715	-0.2715	-0.2715
0.675	0.0000	-0.1248	-0.0854	-0.1093	-0.2627	-0.2627	-0.2627	-0.2627	-0.2627	-0.2627
0.700	-0.1684	-0.1450	-0.0957	-0.1132	-0.2725	-0.2725	-0.2725	-0.2725	-0.2725	-0.2725
0.725	0.0000	-0.1699	0.0000	-0.1172	-0.2673	-0.2673	-0.2673	-0.2673	-0.2673	-0.2673
0.750	-0.1484	-0.1740	0.0000	-0.1278	-0.2755	-0.2755	-0.2755	-0.2755	-0.2755	-0.2755
0.775	0.0000	-0.1907	-0.1278	-0.1348	-0.2601	-0.2601	-0.2601	-0.2601	-0.2601	-0.2601
0.800	-0.1389	-0.2012	-0.1571	-0.1448	0.0000	0.0000	0.0000	0.0000	0.0000	0.0000
0.825	0.0000	-0.1994	-0.1794	-0.1660	-0.2973	-0.2973	-0.2973	-0.2973	-0.2973	-0.2973
0.850	-0.1134	-0.2073	-0.2077	-0.2011	-0.2784	-0.2784	-0.2784	-0.2784	-0.2784	-0.2784
0.875	0.0000	-0.1942	-0.2150	-0.2371	-0.3848	-0.3848	-0.3848	-0.3848	-0.3848	-0.3848
0.900	-0.0798	-0.1828	-0.2143	-0.2585	0.0000	0.0000	0.0000	0.0000	0.0000	0.0000
0.925	0.0000	-0.1526	-0.2101	-0.2668	-0.9165	-0.9165	-0.9165	-0.9165	-0.9165	-0.9165
0.950	-0.0533	-0.1081	-0.1669	-0.2440	-0.5005	-0.5005	-0.5005	-0.5005	-0.5005	-0.5005
0.975	0.0000	-0.2486	-0.2376	-0.1778	-0.3052	-0.3052	-0.3052	-0.3052	-0.3052	-0.3052

η	$x/c_R = .2$		$x/c_R = .4$		$x/c_R = .6$		$x/c_R = .8$		$x/c_R = .95$	
	$C_{p,u}$	$C_{p,l}$	$C_{p,u}$	$C_{p,l}$	$C_{p,u}$	$C_{p,l}$	$C_{p,u}$	$C_{p,l}$	$C_{p,u}$	$C_{p,l}$
-0.200	0.0264	0.0381	0.0883	0.0883	0.0883	0.0883	0.0883	0.0883	0.0883	0.0883
-0.400	0.0175	0.0412	0.0504	-0.0496	-0.3128	-0.3128	-0.3128	-0.3128	-0.3128	-0.3128
-0.600	0.0000	0.0362	0.0368	-0.0400	-0.3485	-0.3485	-0.3485	-0.3485	-0.3485	-0.3485
-0.700	0.0000	0.0198	0.0319	-0.0382	-0.3675	-0.3675	-0.3675	-0.3675	-0.3675	-0.3675
-0.800	0.0747	0.0182	0.0106	-0.0329	-0.4012	-0.4012	-0.4012	-0.4012	-0.4012	-0.4012
-0.850	0.1057	0.0351	0.0120	-0.0452	-0.4424	-0.4424	-0.4424	-0.4424	-0.4424	-0.4424
-0.900	0.1368	0.0827	0.0349	-0.0377	-0.5790	-0.5790	-0.5790	-0.5790	-0.5790	-0.5790
-0.950	0.0000	0.0000	0.1048	0.0330	-0.3304	-0.3304	-0.3304	-0.3304	-0.3304	-0.3304
-0.975	0.0000	0.1709	0.1486	0.0975	-0.1007	-0.1007	-0.1007	-0.1007	-0.1007	-0.1007

Sharp Radius L.E.
 Run No. = 84 , Point No. = 1819
 $C_N = 0.090$, $C_m = -0.0152$
 $\alpha = 3.2^\circ$, $M_\infty = 0.401$
 $R_{mac} = 6.0 \times 10^6$

Surface Pressures Near Leading Edge

● / ◆ upper, starboard/port
 ○ / ◇ lower, starboard/port

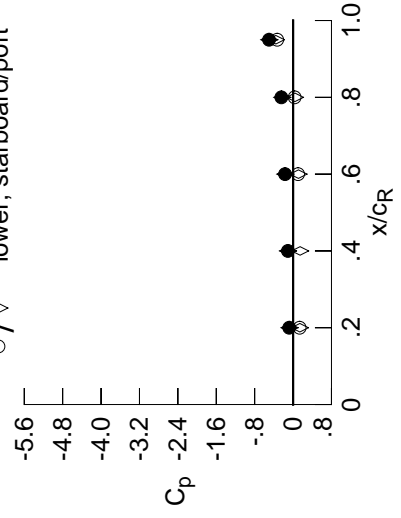

x/c_R	η	starb'd	port	starb'd	port
x/c_R	η	$C_{p,u}$	$C_{p,l}$	$C_{p,u}$	$C_{p,l}$
0.20	0.90	-0.0798	-0.0737	0.1414	0.1368
0.40	0.95	-0.1081	-0.1053	0.1466	0.1466
0.60	0.95	-0.1669	-0.1619	0.1121	0.1048
0.80	0.95	-0.2440	-0.2246	0.0391	0.0330
0.95	0.95	-0.5005	-0.4956	-0.3581	-0.3304

Table D1. Continued.

η	$x/c_R = .2$		$x/c_R = .4$		$x/c_R = .6$		$x/c_R = .8$		$x/c_R = .95$	
	$C_{p,u}$	$C_{p,l}$	$C_{p,u}$	$C_{p,l}$	$C_{p,u}$	$C_{p,l}$	$C_{p,u}$	$C_{p,l}$	$C_{p,u}$	$C_{p,l}$
0.050	-0.0874	-0.0631	0.0527	0.0527	0.0527	0.0527	0.0527	0.0527	0.0527	0.0527
0.100	-0.0977	-0.0651	0.0450	0.0450	0.0450	0.0450	0.0450	0.0450	0.0450	0.0450
0.150	-0.1090	-0.0671	0.0269	0.0269	0.0269	0.0269	0.0269	0.0269	0.0269	0.0269
0.200	-0.1197	-0.0718	0.0104	0.0104	0.0104	0.0104	0.0104	0.0104	0.0104	0.0104
0.250	*****	-0.0800	0.0028	-0.1214	0.0028	-0.1214	0.0028	-0.1214	0.0028	-0.2530
0.300	-0.1206	-0.0746	-0.0244	-0.1099	-0.0244	-0.1099	-0.0244	-0.1099	-0.0244	-0.2565
0.350	-0.1330	-0.0776	-0.0308	-0.1038	-0.0308	-0.1038	-0.0308	-0.1038	-0.0308	-0.2718
0.400	-0.1432	-0.0828	-0.0371	-0.0998	-0.0371	-0.0998	-0.0371	-0.0998	-0.0371	-0.2702
0.450	-0.1627	-0.0936	-0.0427	-0.0950	-0.0427	-0.0950	-0.0427	-0.0950	-0.0427	-0.2724
0.500	-0.1747	-0.1002	-0.0624	-0.1002	-0.0624	-0.1002	-0.0624	-0.1002	-0.0624	-0.2698
0.525	*****	-0.1096	-0.0674	-0.1007	-0.0674	-0.1007	-0.0674	-0.1007	-0.0674	-0.2824
0.550	-0.1873	-0.1099	-0.0736	-0.1051	-0.0736	-0.1051	-0.0736	-0.1051	-0.0736	-0.2704
0.575	*****	-0.1202	-0.0711	-0.1049	-0.0711	-0.1049	-0.0711	-0.1049	-0.0711	-0.2668
0.600	-0.1920	-0.1207	-0.0863	-0.1041	-0.0863	-0.1041	-0.0863	-0.1041	-0.0863	-0.2651
0.625	*****	*****	-0.0912	-0.1179	-0.0912	-0.1179	-0.0912	-0.1179	-0.0912	-0.2752
0.650	-0.2040	-0.1389	-0.0997	-0.1190	-0.0997	-0.1190	-0.0997	-0.1190	-0.0997	-0.2750
0.675	*****	-0.1495	-0.1055	-0.1282	-0.1055	-0.1282	-0.1055	-0.1282	-0.1055	-0.2642
0.700	-0.2024	-0.1738	-0.1158	-0.1290	-0.1158	-0.1290	-0.1158	-0.1290	-0.1158	-0.2768
0.725	*****	-0.2009	*****	-0.1346	-0.2009	*****	-0.1346	-0.2009	*****	-0.2737
0.750	-0.1894	-0.2099	*****	-0.1447	-0.1894	-0.2099	*****	-0.1447	-0.1894	-0.2858
0.775	*****	-0.2277	-0.1623	-0.1568	-0.2277	-0.1623	-0.1568	-0.2277	-0.1623	-0.2850
0.800	-0.1791	-0.2366	-0.1886	-0.1714	-0.1791	-0.2366	-0.1886	-0.1714	-0.1791	-0.2850
0.825	*****	-0.2399	-0.2101	-0.1937	-0.2399	-0.2101	-0.1937	-0.2399	-0.2101	-0.3376
0.850	-0.1526	-0.2450	-0.2406	-0.2307	-0.1526	-0.2450	-0.2406	-0.2307	-0.1526	-0.3196
0.875	*****	-0.2345	-0.2453	-0.2685	-0.2345	-0.2453	-0.2685	-0.2345	-0.2345	-0.4275
0.900	-0.1120	-0.2110	-0.2491	-0.2905	-0.1120	-0.2110	-0.2491	-0.2905	-0.1120	-0.3659
0.925	*****	-0.1877	-0.2383	-0.2992	-0.1877	-0.2383	-0.2992	-0.1877	-0.1877	-0.9521
0.950	-0.1171	-0.3182	-0.2815	-0.2801	-0.1171	-0.3182	-0.2815	-0.2801	-0.1171	-0.5495
0.975	*****	-0.4376	-0.4787	-0.4210	-0.4376	-0.4787	-0.4210	-0.4376	-0.4376	-0.3659

η	$x/c_R = .2$		$x/c_R = .4$		$x/c_R = .6$		$x/c_R = .8$		$x/c_R = .95$	
	$C_{p,u}$	$C_{p,l}$	$C_{p,u}$	$C_{p,l}$	$C_{p,u}$	$C_{p,l}$	$C_{p,u}$	$C_{p,l}$	$C_{p,u}$	$C_{p,l}$
-0.200	0.0511	0.0598	0.0989	0.0989	0.0989	0.0989	0.0989	0.0989	0.0989	0.0989
-0.400	0.0410	0.0633	0.0663	-0.0399	0.0663	-0.0399	0.0663	-0.0399	0.0663	-0.3144
-0.600	*****	0.0577	0.0567	-0.0294	0.0567	-0.0294	0.0567	-0.0294	0.0567	-0.3457
-0.700	*****	0.0460	0.0536	-0.0167	0.0536	-0.0167	0.0536	-0.0167	0.0536	-0.3626
-0.800	0.1069	0.0515	0.0379	-0.0132	0.0379	-0.0132	0.0379	-0.0132	0.0379	-0.3877
-0.850	0.1344	0.0675	0.0423	-0.0179	0.0423	-0.0179	0.0423	-0.0179	0.0423	-0.4251
-0.900	0.1629	0.1175	0.0718	-0.0037	0.0718	-0.0037	0.0718	-0.0037	0.0718	-0.5365
-0.950	*****	*****	0.1329	0.0682	0.1329	0.0682	0.1329	0.0682	0.1329	-0.2887
-0.975	*****	0.1838	0.1680	0.1227	0.1838	0.1680	0.1227	0.1838	0.1680	-0.0696

Sharp Radius L.E.
 Run No. = 84 , Point No. = 1820
 $C_N = 0.134$, $C_m = -0.0241$
 $\alpha = 4.2^\circ$, $M_\infty = 0.401$
 $R_{mac} = 6.0 \times 10^6$

Surface Pressures Near Leading Edge

● / ◆ upper, starboard/port
 ○ / ◇ lower, starboard/port

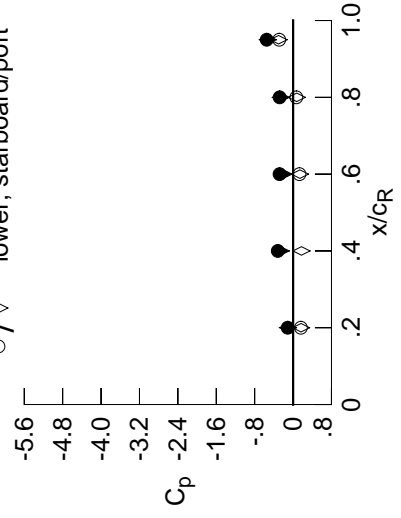

x/c_R	η	starb'd	port	starb'd	port
x/c_R	η	$C_{p,u}$	$C_{p,l}$	$C_{p,u}$	$C_{p,l}$
0.20	0.90	-0.1120	-0.1059	0.1667	0.1629
0.40	0.95	-0.3182	-0.2577	0.1754	*****
0.60	0.95	-0.2815	-0.2000	0.1430	0.1329
0.80	0.95	-0.2801	-0.2553	0.0765	0.0682
0.95	0.95	-0.5495	-0.5253	-0.3026	-0.2887

Table D1. Continued.

η	$x/c_R = .2$		$x/c_R = .4$		$x/c_R = .6$		$x/c_R = .8$		$x/c_R = .95$	
	$C_{p,u}$	$C_{p,l}$	$C_{p,u}$	$C_{p,l}$	$C_{p,u}$	$C_{p,l}$	$C_{p,u}$	$C_{p,l}$	$C_{p,u}$	$C_{p,l}$
0.050	-0.1079	-0.0769	0.0442	*****	*****	*****	*****	*****	*****	*****
0.100	-0.1156	-0.0787	0.0343	*****	*****	*****	*****	*****	*****	*****
0.150	-0.1331	-0.0812	0.0145	*****	*****	*****	*****	*****	*****	*****
0.200	-0.1346	-0.0859	-0.0045	*****	*****	*****	*****	*****	*****	*****
0.250	*****	-0.0936	-0.0097	-0.1292	-0.2533	*****	*****	*****	*****	*****
0.300	-0.1399	-0.0907	-0.0358	-0.1200	-0.2500	*****	*****	*****	*****	*****
0.350	-0.1554	-0.0943	-0.0484	-0.1090	-0.2565	*****	*****	*****	*****	*****
0.400	-0.1661	-0.1067	-0.0493	-0.1069	-0.2604	*****	*****	*****	*****	*****
0.450	-0.1879	-0.1137	-0.0609	-0.1086	-0.2647	*****	*****	*****	*****	*****
0.500	-0.2011	-0.1214	-0.0723	-0.1123	-0.2704	*****	*****	*****	*****	*****
0.525	*****	-0.1247	-0.0852	-0.1101	-0.2798	*****	*****	*****	*****	*****
0.550	-0.2162	-0.1328	-0.0887	-0.1126	-0.2744	*****	*****	*****	*****	*****
0.575	*****	-0.1411	-0.0902	-0.1160	-0.2760	*****	*****	*****	*****	*****
0.600	-0.2226	-0.1412	-0.0990	-0.1151	-0.2782	*****	*****	*****	*****	*****
0.625	*****	*****	-0.1090	-0.1296	-0.2912	*****	*****	*****	*****	*****
0.650	-0.2396	-0.1630	-0.1169	-0.1267	-0.2932	*****	*****	*****	*****	*****
0.675	*****	-0.1800	-0.1248	-0.1451	-0.2867	*****	*****	*****	*****	*****
0.700	-0.2365	-0.1996	-0.1359	-0.1436	-0.2974	*****	*****	*****	*****	*****
0.725	*****	-0.2220	*****	-0.1524	-0.3041	*****	*****	*****	*****	*****
0.750	-0.2205	-0.2351	*****	-0.1578	-0.3218	*****	*****	*****	*****	*****
0.775	*****	-0.2570	-0.1842	-0.1783	-0.3155	*****	*****	*****	*****	*****
0.800	-0.2064	-0.2673	-0.2071	-0.2007	*****	*****	*****	*****	*****	*****
0.825	*****	-0.2725	-0.2311	-0.2105	-0.3739	*****	*****	*****	*****	*****
0.850	-0.1625	-0.2637	-0.2519	-0.2516	-0.3713	*****	*****	*****	*****	*****
0.875	*****	-0.2354	-0.2525	-0.2832	-0.4638	*****	*****	*****	*****	*****
0.900	-0.2663	-0.2585	-0.2842	-0.2966	*****	*****	*****	*****	*****	*****
0.925	*****	-0.4508	-0.4482	-0.3533	-0.8292	*****	*****	*****	*****	*****
0.950	-0.1866	-0.5637	-0.5763	-0.5375	-0.5592	*****	*****	*****	*****	*****
0.975	*****	-0.5289	-0.5550	-0.5769	-0.5699	*****	*****	*****	*****	*****
-0.200	0.0689	0.0741	0.1130	*****	-0.2850	*****	*****	*****	*****	*****
-0.400	0.0639	0.0801	0.0815	-0.0318	-0.3203	*****	*****	*****	*****	*****
-0.600	*****	0.0805	0.0686	-0.0118	-0.3451	*****	*****	*****	*****	*****
-0.700	*****	0.0705	0.0744	-0.0081	-0.3515	*****	*****	*****	*****	*****
-0.800	0.1345	0.0818	0.0612	0.0079	-0.3742	*****	*****	*****	*****	*****
-0.850	0.1587	0.0951	0.0709	0.0028	-0.4053	*****	*****	*****	*****	*****
-0.900	0.1825	0.1435	0.1005	0.0228	-0.5217	*****	*****	*****	*****	*****
-0.950	*****	*****	0.1566	0.0952	-0.2508	*****	*****	*****	*****	*****
-0.975	*****	0.1843	0.1773	0.1359	-0.0428	*****	*****	*****	*****	*****

Sharp Radius L.E.
 Run No. = 84, Point No. = 1821
 $C_N = 0.178$, $C_m = -0.0339$
 $\alpha = 5.2^\circ$, $M_\infty = 0.401$
 $R_{mac} = 6.0 \times 10^6$

Surface Pressures Near Leading Edge

- / ◆ upper, starboard/port
- / ◇ lower, starboard/port

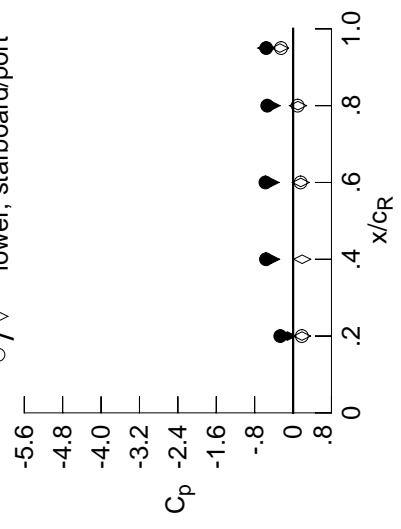

x/c_R	η	$C_{p,u}$ starb'd	$C_{p,u}$ port	$C_{p,l}$ starb'd	$C_{p,l}$ port
0.20	0.90	-0.2663	-0.1187	0.1861	0.1825
0.40	0.95	-0.5637	-0.4587	0.1894	*****
0.60	0.95	-0.5763	-0.4703	0.1612	0.1566
0.80	0.95	-0.5375	-0.4493	0.1013	0.0952
0.95	0.95	-0.5592	-0.5598	-0.2746	-0.2508

Surface Pressures

- upper, starboard
- lower, port

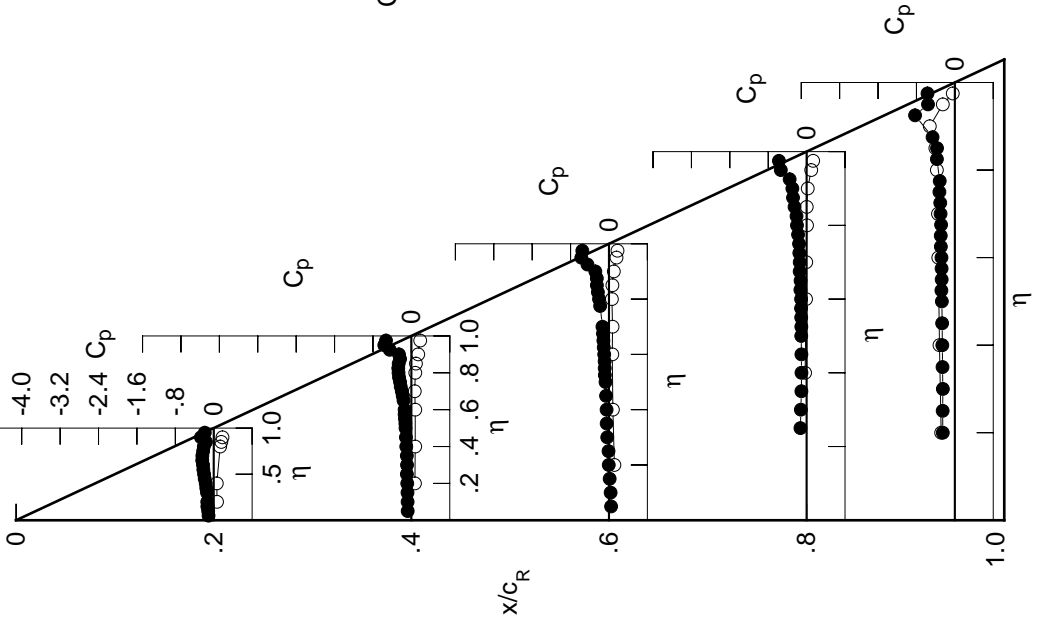

Table D1. Continued.

η	$x/c_R = .2$		$x/c_R = .4$		$x/c_R = .6$		$x/c_R = .8$		$x/c_R = .95$	
	$C_{p,u}$	$C_{p,l}$	$C_{p,u}$	$C_{p,l}$	$C_{p,u}$	$C_{p,l}$	$C_{p,u}$	$C_{p,l}$	$C_{p,u}$	$C_{p,l}$
0.050	-0.1277	-0.0940	0.0309	0.0309	0.0309	0.0309	0.0309	0.0309	0.0309	0.0309
0.100	-0.1357	-0.0983	0.0202	0.0202	0.0202	0.0202	0.0202	0.0202	0.0202	0.0202
0.150	-0.1494	-0.0985	0.0048	0.0048	0.0048	0.0048	0.0048	0.0048	0.0048	0.0048
0.200	-0.1581	-0.1029	-0.0115	-0.0115	-0.0115	-0.0115	-0.0115	-0.0115	-0.0115	-0.0115
0.250	*****	-0.1123	-0.0216	-0.1384	-0.2631	-0.2631	-0.2631	-0.2631	-0.2631	-0.2631
0.300	-0.1630	-0.1076	-0.0507	-0.1305	-0.2466	-0.2466	-0.2466	-0.2466	-0.2466	-0.2466
0.350	-0.1775	-0.1141	-0.0595	-0.1190	-0.2473	-0.2473	-0.2473	-0.2473	-0.2473	-0.2473
0.400	-0.1894	-0.1225	-0.0654	-0.1193	-0.2482	-0.2482	-0.2482	-0.2482	-0.2482	-0.2482
0.450	-0.2134	-0.1380	-0.0775	-0.1175	-0.2596	-0.2596	-0.2596	-0.2596	-0.2596	-0.2596
0.500	-0.2282	-0.1446	-0.0920	-0.1233	-0.2682	-0.2682	-0.2682	-0.2682	-0.2682	-0.2682
0.525	*****	-0.1462	-0.1000	-0.1203	-0.2894	-0.2894	-0.2894	-0.2894	-0.2894	-0.2894
0.550	-0.2439	-0.1536	-0.1046	-0.1209	-0.2850	-0.2850	-0.2850	-0.2850	-0.2850	-0.2850
0.575	*****	-0.1615	-0.1059	-0.1247	-0.2974	-0.2974	-0.2974	-0.2974	-0.2974	-0.2974
0.600	-0.2508	-0.1651	-0.1175	-0.1257	-0.3042	-0.3042	-0.3042	-0.3042	-0.3042	-0.3042
0.625	*****	*****	-0.1237	-0.1374	-0.3230	-0.3230	-0.3230	-0.3230	-0.3230	-0.3230
0.650	-0.2707	-0.1830	-0.1341	-0.1355	-0.3307	-0.3307	-0.3307	-0.3307	-0.3307	-0.3307
0.675	*****	-0.2018	-0.1406	-0.1450	-0.3312	-0.3312	-0.3312	-0.3312	-0.3312	-0.3312
0.700	-0.2648	-0.2222	-0.1492	-0.1480	-0.3466	-0.3466	-0.3466	-0.3466	-0.3466	-0.3466
0.725	*****	-0.2540	*****	-0.1502	-0.3398	-0.3398	-0.3398	-0.3398	-0.3398	-0.3398
0.750	-0.2418	-0.2599	*****	-0.1584	-0.3537	-0.3537	-0.3537	-0.3537	-0.3537	-0.3537
0.775	*****	-0.2755	-0.1928	-0.1947	-0.3700	-0.3700	-0.3700	-0.3700	-0.3700	-0.3700
0.800	-0.2055	-0.2765	-0.2159	-0.2517	*****	*****	*****	*****	*****	*****
0.825	*****	-0.2758	-0.2342	-0.2795	-0.5323	-0.5323	-0.5323	-0.5323	-0.5323	-0.5323
0.850	-0.2341	-0.2764	-0.3002	-0.3515	-0.5726	-0.5726	-0.5726	-0.5726	-0.5726	-0.5726
0.875	*****	-0.3520	-0.4429	-0.4788	-0.6349	-0.6349	-0.6349	-0.6349	-0.6349	-0.6349
0.900	-0.4873	-0.5865	-0.6047	-0.5579	*****	*****	*****	*****	*****	*****
0.925	*****	-0.6813	-0.6743	-0.5972	-0.6228	-0.6228	-0.6228	-0.6228	-0.6228	-0.6228
0.950	-0.2854	-0.6685	-0.6469	-0.5862	-0.5226	-0.5226	-0.5226	-0.5226	-0.5226	-0.5226
0.975	*****	-0.6470	-0.6241	-0.5710	-0.4513	-0.4513	-0.4513	-0.4513	-0.4513	-0.4513

Sharp Radius L.E.
 Run No. = 84 , Point No. = 1822
 $C_N = 0.232$, $C_m = -0.0480$
 $\alpha = 6.3^\circ$, $M_\infty = 0.400$
 $R_{mac} = 6.0 \times 10^6$

Surface Pressures Near Leading Edge

● / ◆ upper, starboard/port
 ○ / ◇ lower, starboard/port

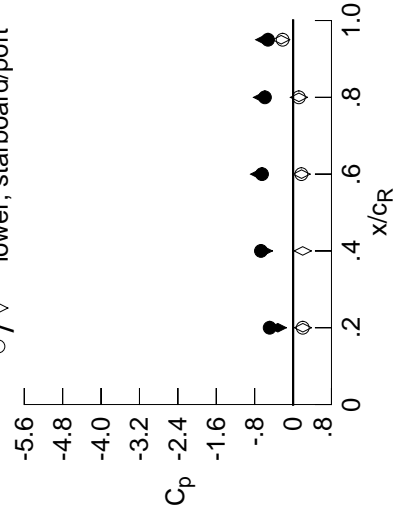

x/c_R	η	starb'd	port	starb'd	port
		$C_{p,u}$	$C_{p,l}$	$C_{p,u}$	$C_{p,l}$
0.20	0.90	-0.4873	-0.3169	0.2036	0.2019
0.40	0.95	-0.6685	-0.6079	0.2012	*****
0.60	0.95	-0.6469	-0.7070	0.1768	0.1728
0.80	0.95	-0.5862	-0.6473	0.1214	0.1204
0.95	0.95	-0.5226	-0.6005	-0.2477	-0.2177

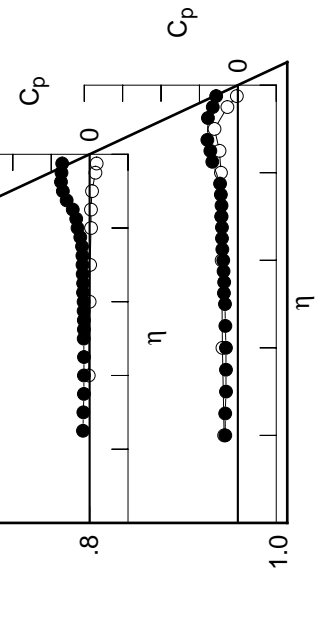

η	$C_{p,l}$	$C_{p,l}$	$C_{p,l}$	$C_{p,l}$	$C_{p,l}$
-0.200	0.0924	0.0932	0.1249	*****	-0.2860
-0.400	0.0887	0.0964	0.0950	-0.0188	-0.3212
-0.600	*****	0.1049	0.0884	0.0003	-0.3379
-0.700	*****	0.0944	0.0980	0.0100	-0.3391
-0.800	0.1620	0.1118	0.0847	0.0293	-0.3523
-0.850	0.1834	0.1230	0.0971	0.0277	-0.3816
-0.900	0.2019	0.1714	0.1294	0.0504	-0.4868
-0.950	*****	*****	0.1728	0.1204	-0.2177
-0.975	*****	0.1820	0.1776	0.1466	-0.0210

Table D1. Continued.

η	x/c_R .2	$C_{p,u}$	x/c_R .4	$C_{p,u}$	x/c_R .6	$C_{p,u}$	x/c_R .8	$C_{p,u}$	x/c_R .95	$C_{p,u}$
0.050		-0.1445	-0.1056	0.0197	0.0197	0.0197	0.0197	0.0197	0.0197	0.0197
0.100		-0.1543	-0.1123	0.0066	0.0066	0.0066	0.0066	0.0066	0.0066	0.0066
0.150		-0.1706	-0.1158	-0.0055	-0.0055	-0.0055	-0.0055	-0.0055	-0.0055	-0.0055
0.200		-0.1791	-0.1218	-0.0236	-0.0236	-0.0236	-0.0236	-0.0236	-0.0236	-0.0236
0.250		*****	-0.1265	-0.0325	-0.1492	-0.2715	-0.2715	-0.2715	-0.2715	-0.2715
0.300		-0.1810	-0.1289	-0.0713	-0.1386	-0.2427	-0.2427	-0.2427	-0.2427	-0.2427
0.350		-0.1967	-0.1309	-0.0786	-0.1309	-0.2352	-0.2352	-0.2352	-0.2352	-0.2352
0.400		-0.2093	-0.1445	-0.0800	-0.1254	-0.2341	-0.2341	-0.2341	-0.2341	-0.2341
0.450		-0.2361	-0.1612	-0.0857	-0.1231	-0.2524	-0.2524	-0.2524	-0.2524	-0.2524
0.500		-0.2522	-0.1653	-0.1040	-0.1246	-0.2761	-0.2761	-0.2761	-0.2761	-0.2761
0.525		*****	-0.1677	-0.1103	-0.1254	-0.3029	-0.3029	-0.3029	-0.3029	-0.3029
0.550		-0.2683	-0.1746	-0.1157	-0.1219	-0.3101	-0.3101	-0.3101	-0.3101	-0.3101
0.575		*****	-0.1763	-0.1155	-0.1234	-0.3235	-0.3235	-0.3235	-0.3235	-0.3235
0.600		-0.2762	-0.1826	-0.1269	-0.1227	-0.3353	-0.3353	-0.3353	-0.3353	-0.3353
0.625		*****	*****	-0.1328	-0.1325	-0.3557	-0.3557	-0.3557	-0.3557	-0.3557
0.650		-0.2952	-0.2002	-0.1414	-0.1227	-0.3577	-0.3577	-0.3577	-0.3577	-0.3577
0.675		*****	-0.2220	-0.1470	-0.1245	-0.3401	-0.3401	-0.3401	-0.3401	-0.3401
0.700		-0.2808	-0.2447	-0.1445	-0.1083	-0.3391	-0.3391	-0.3391	-0.3391	-0.3391
0.725		*****	-0.2661	*****	-0.0889	-0.3295	-0.3295	-0.3295	-0.3295	-0.3295
0.750		-0.2385	-0.2677	*****	-0.1275	-0.4306	-0.4306	-0.4306	-0.4306	-0.4306
0.775		*****	-0.2682	-0.1905	-0.3154	-0.6219	-0.6219	-0.6219	-0.6219	-0.6219
0.800		-0.2278	-0.2638	-0.3136	-0.5255	*****	*****	*****	*****	*****
0.825		*****	-0.3296	-0.4977	-0.6517	-0.8028	-0.8028	-0.8028	-0.8028	-0.8028
0.850		-0.5052	-0.4872	-0.6678	-0.6956	-0.7028	-0.7028	-0.7028	-0.7028	-0.7028
0.875		*****	-0.6828	-0.7213	-0.6805	-0.6197	-0.6197	-0.6197	-0.6197	-0.6197
0.900		-0.5618	-0.8088	-0.7409	-0.6228	*****	*****	*****	*****	*****
0.925		*****	-0.7967	-0.7194	-0.5854	-0.5412	-0.5412	-0.5412	-0.5412	-0.5412
0.950		-0.4260	-0.7576	-0.6853	-0.5622	-0.4554	-0.4554	-0.4554	-0.4554	-0.4554
0.975		*****	-0.7462	-0.6687	-0.5505	-0.3945	-0.3945	-0.3945	-0.3945	-0.3945
-0.200		$C_{p,l}$	0.1192	0.1111	0.1438	*****	-0.2805	-0.2805	-0.2805	-0.2805
-0.400		*****	0.1072	0.1212	0.1158	-0.0093	-0.3209	-0.3209	-0.3209	-0.3209
-0.600		*****	0.1238	0.1069	0.1069	0.0172	-0.3185	-0.3185	-0.3185	-0.3185
-0.700		*****	0.1239	0.1239	0.1166	0.0280	-0.3129	-0.3129	-0.3129	-0.3129
-0.800		0.1875	0.1401	0.1110	0.0510	-0.3243	-0.3243	-0.3243	-0.3243	-0.3243
-0.850		0.2048	0.1499	0.1253	0.0515	-0.3616	-0.3616	-0.3616	-0.3616	-0.3616
-0.900		0.2163	0.1941	0.1584	0.0736	-0.4536	-0.4536	-0.4536	-0.4536	-0.4536
-0.950		*****	*****	0.1893	0.1370	-0.1905	-0.1905	-0.1905	-0.1905	-0.1905
-0.975		*****	0.1740	0.1785	0.1559	-0.0029	-0.0029	-0.0029	-0.0029	-0.0029

Sharp Radius L.E.
 Run No. = 84 , Point No. = 1823
 $C_N = 0.281$, $C_m = -0.0560$
 $\alpha = 7.3^\circ$, $M_\infty = 0.401$
 $R_{mac} = 6.0 \times 10^6$

Surface Pressures Near Leading Edge

● / ◆ upper, starboard/port
 ○ / ◇ lower, starboard/port

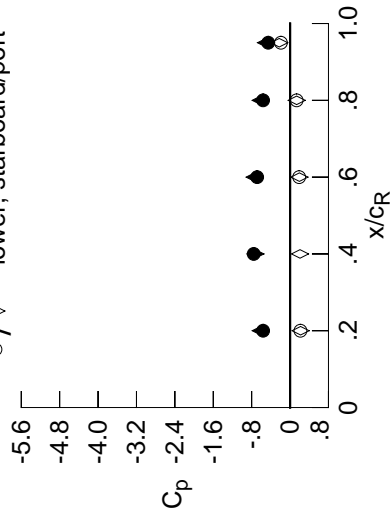

x/c_R	η	starb'd	port	starb'd	port
0.20	0.90	-0.5618	-0.6121	0.2190	0.2163
0.40	0.95	-0.7576	-0.7222	0.2071	*****
0.60	0.95	-0.6853	-0.7389	0.1947	0.1893
0.80	0.95	-0.5622	-0.6128	0.1379	0.1370
0.95	0.95	-0.4554	-0.5014	-0.2259	-0.1905

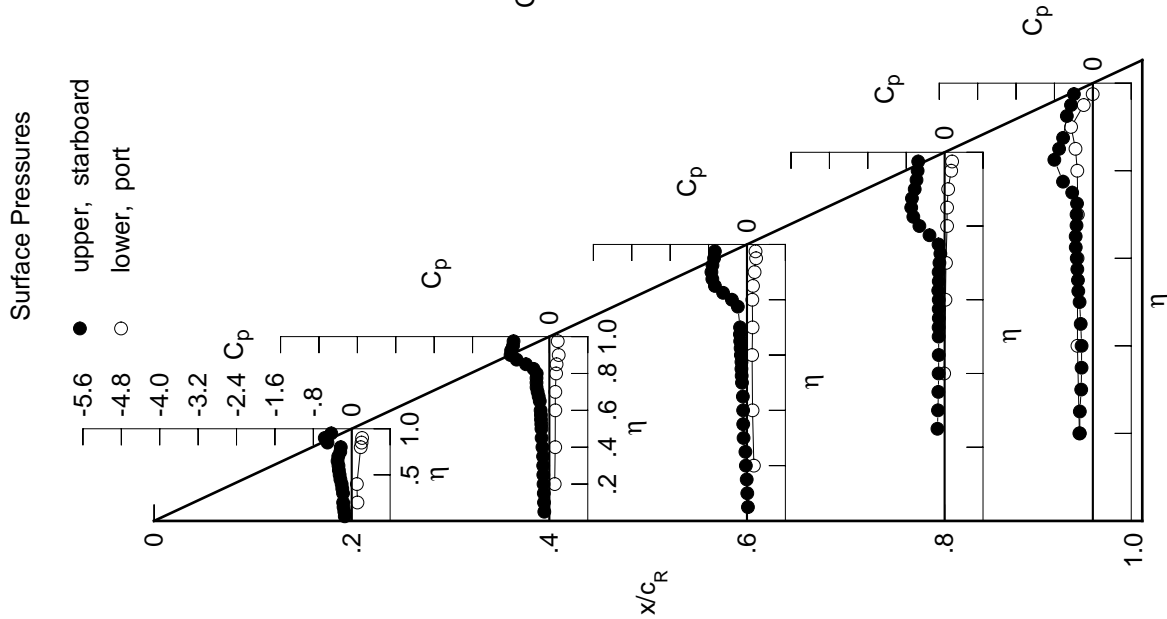

Table D1. Continued.

η	$x/c_R = .2$		$x/c_R = .4$		$x/c_R = .6$		$x/c_R = .8$		$x/c_R = .95$	
	$C_{p,u}$	$C_{p,l}$	$C_{p,u}$	$C_{p,l}$	$C_{p,u}$	$C_{p,l}$	$C_{p,u}$	$C_{p,l}$	$C_{p,u}$	$C_{p,l}$
0.050	-0.1614	-0.1282	0.0090	0.0090	0.0090	0.0090	0.0090	0.0090	0.0090	0.0090
0.100	-0.1733	-0.1278	-0.0016	-0.0016	-0.0016	-0.0016	-0.0016	-0.0016	-0.0016	-0.0016
0.150	-0.1946	-0.1330	-0.0228	-0.0228	-0.0228	-0.0228	-0.0228	-0.0228	-0.0228	-0.0228
0.200	-0.1963	-0.1346	-0.0348	-0.0348	-0.0348	-0.0348	-0.0348	-0.0348	-0.0348	-0.0348
0.250	*****	-0.1457	-0.0487	-0.1557	-0.1557	-0.1557	-0.1557	-0.1557	-0.1557	-0.1557
0.300	-0.2041	-0.1469	-0.0843	-0.1527	-0.2317	-0.2317	-0.2317	-0.2317	-0.2317	-0.2317
0.350	-0.2196	-0.1455	-0.0984	-0.1339	-0.2201	-0.2201	-0.2201	-0.2201	-0.2201	-0.2201
0.400	-0.2339	-0.1651	-0.0924	-0.1309	-0.2249	-0.2249	-0.2249	-0.2249	-0.2249	-0.2249
0.450	-0.2584	-0.1928	-0.0956	-0.1259	-0.2612	-0.2612	-0.2612	-0.2612	-0.2612	-0.2612
0.500	-0.2773	-0.1947	-0.1160	-0.1309	-0.2854	-0.2854	-0.2854	-0.2854	-0.2854	-0.2854
0.525	*****	-0.1898	-0.1202	-0.1254	-0.3219	-0.3219	-0.3219	-0.3219	-0.3219	-0.3219
0.550	-0.2944	-0.1945	-0.1281	-0.1230	-0.3260	-0.3260	-0.3260	-0.3260	-0.3260	-0.3260
0.575	*****	-0.1932	-0.1210	-0.1231	-0.3397	-0.3397	-0.3397	-0.3397	-0.3397	-0.3397
0.600	-0.2973	-0.1956	-0.1313	-0.1129	-0.3487	-0.3487	-0.3487	-0.3487	-0.3487	-0.3487
0.625	*****	*****	-0.1336	-0.1227	-0.3605	-0.3605	-0.3605	-0.3605	-0.3605	-0.3605
0.650	-0.3077	-0.2193	-0.1379	-0.1080	-0.3565	-0.3565	-0.3565	-0.3565	-0.3565	-0.3565
0.675	*****	-0.2260	-0.1327	-0.0963	-0.3206	-0.3206	-0.3206	-0.3206	-0.3206	-0.3206
0.700	-0.2802	-0.2461	-0.1138	-0.0688	-0.3244	-0.3244	-0.3244	-0.3244	-0.3244	-0.3244
0.725	*****	-0.2533	*****	-0.0822	-0.3724	-0.3724	-0.3724	-0.3724	-0.3724	-0.3724
0.750	-0.2423	-0.2497	*****	-0.2361	-0.5904	-0.5904	-0.5904	-0.5904	-0.5904	-0.5904
0.775	*****	-0.2668	-0.3721	-0.5563	-0.8003	-0.8003	-0.8003	-0.8003	-0.8003	-0.8003
0.800	-0.4435	-0.3717	-0.6869	-0.7998	*****	*****	*****	*****	*****	*****
0.825	*****	-0.6103	-0.8704	-0.9169	-0.8698	-0.8698	-0.8698	-0.8698	-0.8698	-0.8698
0.850	-0.7279	-0.8215	-0.9103	-0.9067	-0.6269	-0.6269	-0.6269	-0.6269	-0.6269	-0.6269
0.875	*****	-0.9192	-0.8400	-0.7515	-0.5485	-0.5485	-0.5485	-0.5485	-0.5485	-0.5485
0.900	-0.6450	-0.9288	-0.7930	-0.6318	*****	*****	*****	*****	*****	*****
0.925	*****	-0.8859	-0.7522	-0.5995	-0.5060	-0.5060	-0.5060	-0.5060	-0.5060	-0.5060
0.950	-0.5954	-0.8511	-0.7200	-0.5609	-0.4315	-0.4315	-0.4315	-0.4315	-0.4315	-0.4315
0.975	*****	-0.8395	-0.7037	-0.5498	-0.3786	-0.3786	-0.3786	-0.3786	-0.3786	-0.3786

Sharp Radius L.E.
 Run No. = 84, Point No. = 1824
 $C_N = 0.331$, $C_m = -0.0639$
 $\alpha = 8.3^\circ$, $M_\infty = 0.400$
 $R_{mac} = 6.0 \times 10^6$

Surface Pressures Near Leading Edge

● / ◆ upper, starboard/port
 ○ / ◇ lower, starboard/port

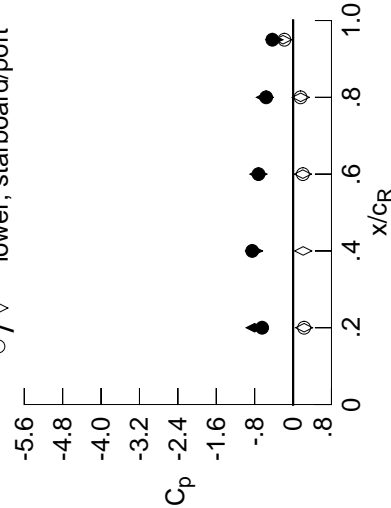

x/c_R	η	starb'd	port	starb'd	port
0.20	0.90	-0.6450	-0.8015	0.2295	0.2300
0.40	0.95	-0.8511	-0.8133	0.2103	*****
0.60	0.95	-0.7200	-0.7234	0.2030	0.2040
0.80	0.95	-0.5609	-0.5876	0.1585	0.1559
0.95	0.95	-0.4315	-0.3913	-0.2094	-0.1810

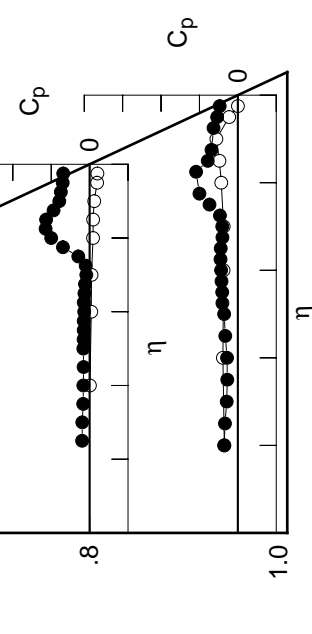

Table D1. Continued.

η	x/c_R .2	$C_{p,u}$	x/c_R .4	$C_{p,u}$	x/c_R .6	$C_{p,u}$	x/c_R .8	$C_{p,u}$	x/c_R .95	$C_{p,u}$
0.050		-0.1850	-0.1440	-0.0064	*****	*****	*****	*****	*****	*****
0.100		-0.1969	-0.1476	-0.0142	*****	*****	*****	*****	*****	*****
0.150		-0.2121	-0.1511	-0.0345	*****	*****	*****	*****	*****	*****
0.200		-0.2218	-0.1523	-0.0517	*****	*****	*****	*****	*****	*****
0.250		*****	-0.1651	-0.0605	-0.1671	-0.2574	*****	*****	*****	*****
0.300		-0.2256	-0.1632	-0.0961	-0.1588	-0.2189	*****	*****	*****	*****
0.350		-0.2434	-0.1664	-0.1174	-0.1425	-0.2116	*****	*****	*****	*****
0.400		-0.2974	-0.1789	-0.1087	-0.1340	-0.2263	*****	*****	*****	*****
0.450		-0.2860	-0.2155	-0.1132	-0.1275	-0.2721	*****	*****	*****	*****
0.500		-0.3003	-0.2253	-0.1244	-0.1316	-0.3093	*****	*****	*****	*****
0.525		*****	-0.2188	-0.1280	-0.1247	-0.3377	*****	*****	*****	*****
0.550		-0.3172	-0.2207	-0.1349	-0.1243	-0.3440	*****	*****	*****	*****
0.575		*****	-0.2162	-0.1249	-0.1153	-0.3478	*****	*****	*****	*****
0.600		-0.3146	-0.2142	-0.1348	-0.1085	-0.3537	*****	*****	*****	*****
0.625		*****	*****	-0.1269	-0.1089	-0.3599	*****	*****	*****	*****
0.650		-0.2986	-0.2232	-0.1254	-0.0910	-0.3502	*****	*****	*****	*****
0.675		*****	-0.2265	-0.1070	-0.0841	-0.3398	*****	*****	*****	*****
0.700		-0.2551	-0.2299	-0.0865	-0.0951	-0.4133	*****	*****	*****	*****
0.725		*****	-0.2234	*****	-0.1990	-0.5731	*****	*****	*****	*****
0.750		-0.3714	-0.2384	*****	-0.4820	-0.7898	*****	*****	*****	*****
0.775		*****	-0.4174	-0.6918	-0.8019	-0.9085	*****	*****	*****	*****
0.800		-0.7494	-0.7195	-1.0193	-1.0031	*****	*****	*****	*****	*****
0.825		*****	-0.9632	-1.1343	-1.0555	-0.6176	*****	*****	*****	*****
0.850		-0.8764	-1.0663	-1.1126	-0.8665	-0.5142	*****	*****	*****	*****
0.875		*****	-1.0677	-0.9479	-0.6734	-0.5034	*****	*****	*****	*****
0.900		-0.7403	-1.0279	-0.8302	-0.6480	*****	*****	*****	*****	*****
0.925		*****	-0.9705	-0.7877	-0.6044	-0.4696	*****	*****	*****	*****
0.950		-0.7422	-0.9263	-0.7452	-0.5861	-0.3928	*****	*****	*****	*****
0.975		*****	-0.9128	-0.7222	-0.5728	-0.3413	*****	*****	*****	*****
-0.200		$C_{p,l}$	$C_{p,l}$	$C_{p,l}$	$C_{p,l}$	$C_{p,l}$	$C_{p,l}$	$C_{p,l}$	$C_{p,l}$	$C_{p,l}$
-0.400		0.1628	0.1532	0.1763	*****	-0.2796	*****	*****	*****	*****
-0.600		0.1579	0.1637	0.1488	0.0162	-0.3179	*****	*****	*****	*****
-0.700		*****	0.1687	0.1436	0.0449	-0.2988	*****	*****	*****	*****
-0.800		*****	0.1738	0.1576	0.0555	-0.3012	*****	*****	*****	*****
-0.850		0.2323	0.1893	0.1551	0.0827	-0.3486	*****	*****	*****	*****
-0.900		0.2410	0.1981	0.1704	0.0889	-0.3880	*****	*****	*****	*****
-0.950		0.2382	0.2311	0.2032	0.1139	-0.4402	*****	*****	*****	*****
-0.975		*****	*****	0.2132	0.1655	-0.1643	*****	*****	*****	*****
		*****	0.1467	0.1751	0.1616	0.0102	*****	*****	*****	*****

Sharp Radius L.E.
 Run No. = 84 , Point No. = 1825
 $C_N = 0.380$, $C_m = -0.0717$
 $\alpha = 9.3^\circ$, $M_\infty = 0.401$
 $R_{mac} = 6.0 \times 10^6$

Surface Pressures Near Leading Edge

● / ◆ upper, starboard/port
 ○ / ◇ lower, starboard/port

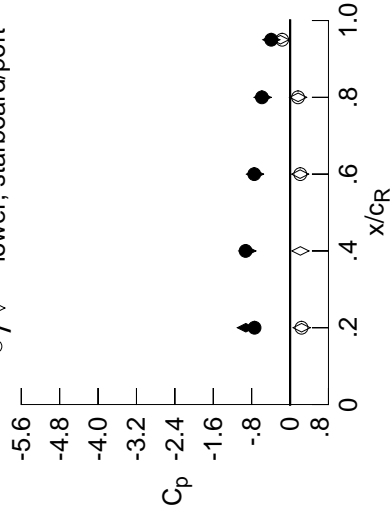

x/c_R	η	starb'd	port	starb'd	port
0.20	0.90	-0.7403	-0.9216	0.2403	0.2382
0.40	0.95	-0.9263	-0.8909	0.2142	*****
0.60	0.95	-0.7452	-0.7303	0.2096	0.2132
0.80	0.95	-0.5861	-0.5728	0.1683	0.1655
0.95	0.95	-0.3928	-0.3914	-0.2012	-0.1643

Surface Pressures

● upper, starboard
 ○ lower, port

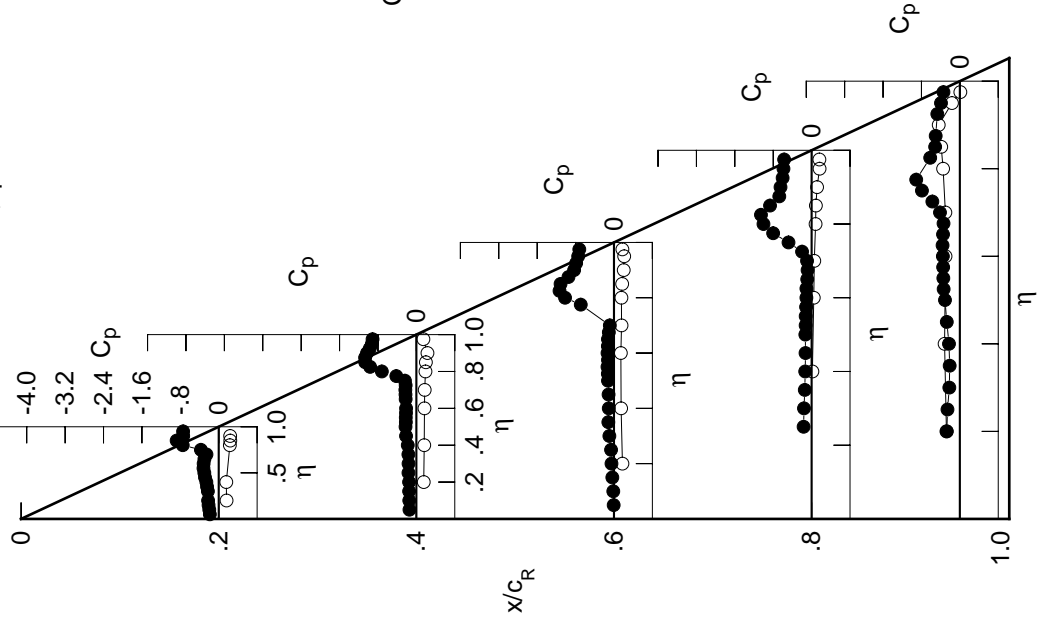

Table D1. Continued.

η	$x/c_R = .2$		$x/c_R = .4$		$x/c_R = .6$		$x/c_R = .8$		$x/c_R = .95$	
	$C_{p,u}$	$C_{p,l}$	$C_{p,u}$	$C_{p,l}$	$C_{p,u}$	$C_{p,l}$	$C_{p,u}$	$C_{p,l}$	$C_{p,u}$	$C_{p,l}$
0.050	-0.2101	-0.1628	-0.0215	*****	*****	*****	*****	*****	*****	*****
0.100	-0.2198	-0.1695	-0.0305	*****	*****	*****	*****	*****	*****	*****
0.150	-0.2349	-0.1698	-0.0488	*****	*****	*****	*****	*****	*****	*****
0.200	-0.2463	-0.1814	-0.0657	*****	*****	*****	*****	*****	*****	*****
0.250	*****	-0.1827	-0.0707	-0.1720	-0.2329	*****	*****	*****	*****	*****
0.300	-0.2524	-0.1791	-0.1087	-0.1607	-0.2161	*****	*****	*****	*****	*****
0.350	-0.2669	-0.1812	-0.1188	-0.1473	-0.2153	*****	*****	*****	*****	*****
0.400	-0.2824	-0.1932	-0.1189	-0.1385	-0.2431	*****	*****	*****	*****	*****
0.450	-0.3101	-0.2208	-0.1184	-0.1322	-0.2942	*****	*****	*****	*****	*****
0.500	-0.3264	-0.2339	-0.1366	-0.1344	-0.3228	*****	*****	*****	*****	*****
0.525	*****	-0.2348	-0.1396	-0.1277	-0.3496	*****	*****	*****	*****	*****
0.550	-0.3358	-0.2358	-0.1399	-0.1236	-0.3498	*****	*****	*****	*****	*****
0.575	*****	-0.2343	-0.1290	-0.1142	-0.3548	*****	*****	*****	*****	*****
0.600	-0.3190	-0.2212	-0.1310	-0.1023	-0.3499	*****	*****	*****	*****	*****
0.625	*****	*****	-0.1230	-0.1030	-0.3656	*****	*****	*****	*****	*****
0.650	-0.2822	-0.2064	-0.1145	-0.1021	-0.3777	*****	*****	*****	*****	*****
0.675	*****	-0.1926	-0.1039	-0.1473	-0.4397	*****	*****	*****	*****	*****
0.700	-0.2528	-0.1775	-0.1263	-0.2705	-0.6040	*****	*****	*****	*****	*****
0.725	*****	-0.2206	*****	-0.5149	-0.7793	*****	*****	*****	*****	*****
0.750	-0.6120	-0.4471	*****	-0.8002	-0.9188	*****	*****	*****	*****	*****
0.775	*****	-0.8663	-1.0011	-1.0242	-0.8876	*****	*****	*****	*****	*****
0.800	-1.0198	-1.1753	-1.2519	-1.0653	*****	*****	*****	*****	*****	*****
0.825	*****	-1.2945	-1.3138	-0.9201	-0.5006	*****	*****	*****	*****	*****
0.850	-1.0361	-1.2669	-1.2151	-0.7270	-0.4599	*****	*****	*****	*****	*****
0.875	*****	-1.1803	-0.9250	-0.6911	-0.4652	*****	*****	*****	*****	*****
0.900	-0.8496	-1.0774	-0.8582	-0.6685	*****	*****	*****	*****	*****	*****
0.925	*****	-1.0077	-0.8347	-0.6288	-0.4353	*****	*****	*****	*****	*****
0.950	-0.8757	-0.9734	-0.7688	-0.6130	-0.3541	*****	*****	*****	*****	*****
0.975	*****	-0.9579	-0.7424	-0.5955	-0.3058	*****	*****	*****	*****	*****
-0.200	0.1882	0.1697	0.1901	*****	-0.2900	*****	*****	*****	*****	*****
-0.400	0.1815	0.1831	0.1619	0.0261	-0.3195	*****	*****	*****	*****	*****
-0.600	*****	0.1927	0.1586	0.0570	-0.3088	*****	*****	*****	*****	*****
-0.700	*****	0.1943	0.1729	0.0667	-0.3280	*****	*****	*****	*****	*****
-0.800	0.2545	0.2119	0.1727	0.0969	-0.3800	*****	*****	*****	*****	*****
-0.850	0.2562	0.2166	0.1888	0.1021	-0.4084	*****	*****	*****	*****	*****
-0.900	0.2446	0.2468	0.2182	0.1248	-0.4442	*****	*****	*****	*****	*****
-0.950	*****	*****	0.2186	0.1749	-0.1563	*****	*****	*****	*****	*****
-0.975	*****	0.1294	0.1658	0.1576	0.0124	*****	*****	*****	*****	*****

Sharp Radius L.E.

Run No. = 84 , Point No. = 1826

$C_N = 0.420$, $C_m = -0.0717$

$\alpha = 10.3^\circ$, $M_\infty = 0.401$

$R_{mac} = 6.0 \times 10^6$

Surface Pressures Near Leading Edge

● / ◆ upper, starboard/port
○ / ◇ lower, starboard/port

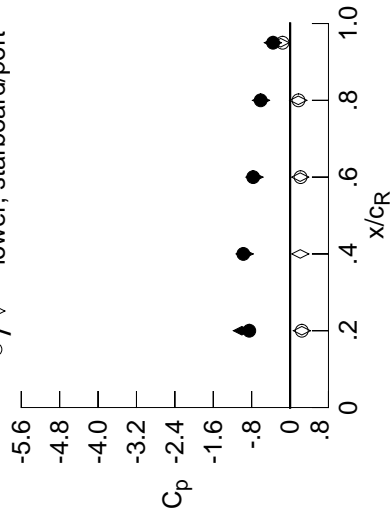

x/c_R	η	starb'd	port	$C_{p,u}$	starb'd	port	$C_{p,l}$
0.20	0.90	-0.8496	-1.0042	0.2459	0.2446	0.2118	*****
0.40	0.95	-0.9734	-0.9476	0.2102	0.2186	0.1709	0.1749
0.60	0.95	-0.7688	-0.7431	0.1709	0.1749	-0.1943	-0.1563
0.80	0.95	-0.6130	-0.6047	0.1709	0.1749	-0.1943	-0.1563
0.95	0.95	-0.3541	-0.3581	-0.1943	-0.1563	0.1749	0.1749

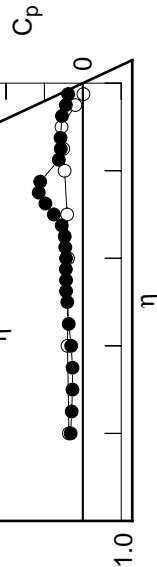

Table D1. Continued.

η	$x/c_R = .2$		$x/c_R = .4$		$x/c_R = .6$		$x/c_R = .8$		$x/c_R = .95$	
	$C_{p,u}$	$C_{p,u}$	$C_{p,u}$	$C_{p,u}$	$C_{p,u}$	$C_{p,u}$	$C_{p,u}$	$C_{p,u}$	$C_{p,u}$	$C_{p,u}$
0.050	-0.2315	-0.1788	-0.0309	*****	*****	*****	*****	*****	*****	*****
0.100	-0.2423	-0.1845	-0.0454	*****	*****	*****	*****	*****	*****	*****
0.150	-0.2559	-0.1876	-0.0589	*****	*****	*****	*****	*****	*****	*****
0.200	-0.2699	-0.1945	-0.0765	*****	*****	*****	*****	*****	*****	*****
0.250	*****	-0.2007	-0.0820	-0.1737	-0.2108	*****	*****	*****	*****	*****
0.300	-0.2721	-0.1982	-0.1137	-0.1577	-0.2252	*****	*****	*****	*****	*****
0.350	-0.2903	-0.1974	-0.1240	-0.1495	-0.2420	*****	*****	*****	*****	*****
0.400	-0.3030	-0.2028	-0.1295	-0.1383	-0.2713	*****	*****	*****	*****	*****
0.450	-0.3321	-0.2201	-0.1326	-0.1314	-0.3126	*****	*****	*****	*****	*****
0.500	-0.3447	-0.2325	-0.1448	-0.1272	-0.3350	*****	*****	*****	*****	*****
0.525	*****	-0.2344	-0.1437	-0.1184	-0.3574	*****	*****	*****	*****	*****
0.550	-0.3482	-0.2330	-0.1431	-0.1112	-0.3529	*****	*****	*****	*****	*****
0.575	*****	-0.2232	-0.1287	-0.1039	-0.3541	*****	*****	*****	*****	*****
0.600	-0.3133	-0.2013	-0.1354	-0.1040	-0.3561	*****	*****	*****	*****	*****
0.625	*****	*****	-0.1235	-0.1326	-0.4008	*****	*****	*****	*****	*****
0.650	-0.2633	-0.1668	-0.1418	-0.1872	-0.4677	*****	*****	*****	*****	*****
0.675	*****	-0.1806	-0.1879	-0.3330	-0.5897	*****	*****	*****	*****	*****
0.700	-0.3395	-0.3202	-0.3292	-0.5555	-0.7675	*****	*****	*****	*****	*****
0.725	*****	-0.6459	*****	-0.8214	-0.9024	*****	*****	*****	*****	*****
0.750	-0.8993	-1.0469	*****	-1.0336	-0.9506	*****	*****	*****	*****	*****
0.775	*****	-1.3450	-1.2438	-1.1220	-0.8008	*****	*****	*****	*****	*****
0.800	-1.2363	-1.4548	-1.4028	-1.0094	*****	*****	*****	*****	*****	*****
0.825	*****	-1.4281	-1.3216	-0.8012	-0.4442	*****	*****	*****	*****	*****
0.850	-1.1802	-1.3242	-1.0377	-0.7232	-0.4203	*****	*****	*****	*****	*****
0.875	*****	-1.1905	-0.8793	-0.7187	-0.4291	*****	*****	*****	*****	*****
0.900	-0.9667	-1.0914	-0.8818	-0.6810	*****	*****	*****	*****	*****	*****
0.925	*****	-1.0380	-0.8530	-0.6445	-0.4045	*****	*****	*****	*****	*****
0.950	-1.0075	-1.0070	-0.8015	-0.6262	-0.3292	*****	*****	*****	*****	*****
0.975	*****	-0.9815	-0.7813	-0.6036	-0.2850	*****	*****	*****	*****	*****
-0.200	$C_{p,l}$	0.2134	0.1910	0.2050	*****	*****	*****	*****	*****	*****
-0.400	$C_{p,l}$	0.2081	0.2027	0.1774	0.0369	-0.3154	*****	*****	*****	*****
-0.600	$C_{p,l}$	*****	0.2139	0.1791	0.0674	-0.3125	*****	*****	*****	*****
-0.700	$C_{p,l}$	*****	0.2187	0.1901	0.0823	-0.3465	*****	*****	*****	*****
-0.800	$C_{p,l}$	0.2746	0.2304	0.1931	0.1083	-0.3992	*****	*****	*****	*****
-0.850	$C_{p,l}$	0.2705	0.2359	0.2082	0.1204	-0.4219	*****	*****	*****	*****
-0.900	$C_{p,l}$	0.2509	0.2608	0.2339	0.1410	-0.4430	*****	*****	*****	*****
-0.950	$C_{p,l}$	*****	*****	0.2188	0.1832	-0.1460	*****	*****	*****	*****
-0.975	$C_{p,l}$	*****	0.1163	0.1558	0.1553	0.0155	*****	*****	*****	*****

Sharp Radius L.E.
 Run No. = 84, Point No. = 1827
 $C_N = 0.470$, $C_m = -0.0788$
 $\alpha = 11.3^\circ$, $M_\infty = 0.401$
 $R_{mac} = 6.0 \times 10^6$

Surface Pressures Near Leading Edge

● / ◆ upper, starboard/port
 ○ / ◇ lower, starboard/port

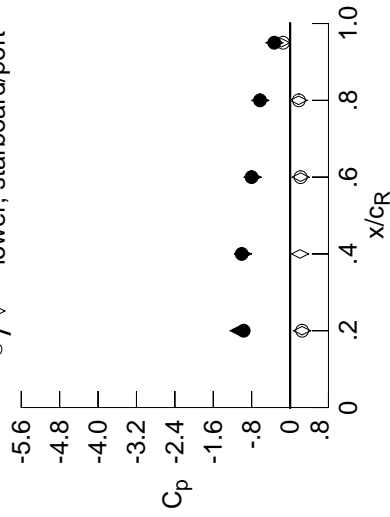

x/c_R	η	starb'd	port	starb'd	port
		$C_{p,u}$	$C_{p,l}$	$C_{p,u}$	$C_{p,l}$
0.20	0.90	-0.9667	-1.0718	0.2506	0.2509
0.40	0.95	-1.0070	-0.9843	0.2077	*****
0.60	0.95	-0.8015	-0.7805	0.2195	0.2188
0.80	0.95	-0.6262	-0.6215	0.1790	0.1832
0.95	0.95	-0.3292	-0.3276	-0.1833	-0.1460

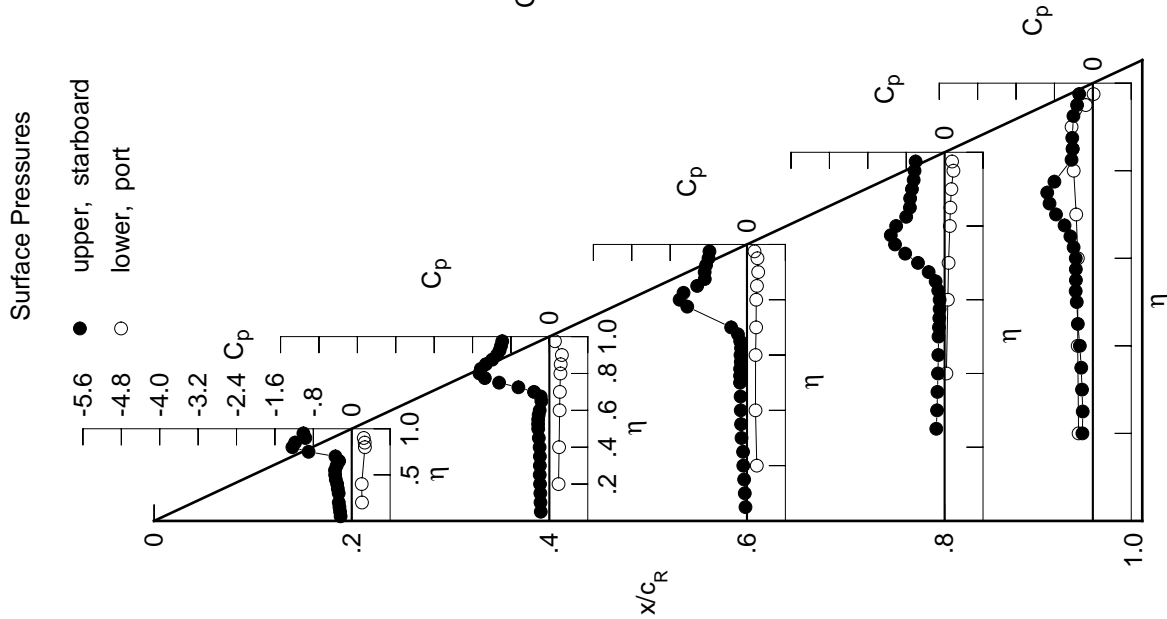

Table D1. Continued.

η	$x/c_R = .2$		$x/c_R = .4$		$x/c_R = .6$		$x/c_R = .8$		$x/c_R = .95$	
	$C_{p,u}$	$C_{p,l}$	$C_{p,u}$	$C_{p,l}$	$C_{p,u}$	$C_{p,l}$	$C_{p,u}$	$C_{p,l}$	$C_{p,u}$	$C_{p,l}$
0.050	-0.2577	-0.2004	-0.0440	*****	*****	*****	*****	*****	*****	*****
0.100	-0.2674	-0.2056	-0.0553	*****	*****	*****	*****	*****	*****	*****
0.150	-0.2855	-0.2106	-0.0727	*****	*****	*****	*****	*****	*****	*****
0.200	-0.2958	-0.2128	-0.0888	*****	*****	*****	*****	*****	*****	*****
0.250	*****	-0.2189	-0.0961	-0.1799	-0.1886	*****	*****	*****	*****	*****
0.300	-0.2994	-0.2175	-0.1257	-0.1619	-0.2268	*****	*****	*****	*****	*****
0.350	-0.3165	-0.2166	-0.1353	-0.1547	-0.2631	*****	*****	*****	*****	*****
0.400	-0.3279	-0.2199	-0.1408	-0.1439	-0.2952	*****	*****	*****	*****	*****
0.450	-0.3562	-0.2279	-0.1433	-0.1335	-0.3341	*****	*****	*****	*****	*****
0.500	-0.3633	-0.2281	-0.1576	-0.1288	-0.3454	*****	*****	*****	*****	*****
0.525	*****	-0.2281	-0.1532	-0.1186	-0.3702	*****	*****	*****	*****	*****
0.550	-0.3564	-0.2243	-0.1557	-0.1163	-0.3632	*****	*****	*****	*****	*****
0.575	*****	-0.2072	-0.1426	-0.1202	-0.3725	*****	*****	*****	*****	*****
0.600	-0.2992	-0.1855	-0.1584	-0.1437	-0.3971	*****	*****	*****	*****	*****
0.625	*****	*****	-0.1688	-0.2201	-0.4759	*****	*****	*****	*****	*****
0.650	-0.2607	-0.2054	-0.2360	-0.3492	-0.5888	*****	*****	*****	*****	*****
0.675	*****	-0.3406	-0.3632	-0.5673	-0.7240	*****	*****	*****	*****	*****
0.700	-0.5356	-0.6793	-0.5955	-0.8212	-0.8919	*****	*****	*****	*****	*****
0.725	*****	-1.1115	*****	-1.0496	-0.9689	*****	*****	*****	*****	*****
0.750	-1.1881	-1.4291	*****	-1.1775	-0.9120	*****	*****	*****	*****	*****
0.775	*****	-1.6089	-1.4177	-1.1303	-0.6430	*****	*****	*****	*****	*****
0.800	-1.4419	-1.6345	-1.4312	-0.9093	*****	*****	*****	*****	*****	*****
0.825	*****	-1.5459	-1.1516	-0.7565	-0.4139	*****	*****	*****	*****	*****
0.850	-1.3296	-1.4004	-0.9494	-0.7350	-0.3984	*****	*****	*****	*****	*****
0.875	*****	-1.2268	-0.9081	-0.7374	-0.4103	*****	*****	*****	*****	*****
0.900	-1.0880	-1.1372	-0.9157	-0.7056	*****	*****	*****	*****	*****	*****
0.925	*****	-1.0928	-0.8869	-0.6595	-0.3944	*****	*****	*****	*****	*****
0.950	-1.1233	-1.0546	-0.8567	-0.6463	-0.3084	*****	*****	*****	*****	*****
0.975	*****	-1.0249	-0.8410	-0.6229	-0.2725	*****	*****	*****	*****	*****

η	$x/c_R = .2$		$x/c_R = .4$		$x/c_R = .6$		$x/c_R = .8$		$x/c_R = .95$	
	$C_{p,u}$	$C_{p,l}$	$C_{p,u}$	$C_{p,l}$	$C_{p,u}$	$C_{p,l}$	$C_{p,u}$	$C_{p,l}$	$C_{p,u}$	$C_{p,l}$
-0.200	0.2366	0.2106	0.2265	*****	*****	*****	*****	*****	*****	*****
-0.400	0.2345	0.2251	0.1975	0.0489	-0.3135	*****	*****	*****	*****	*****
-0.600	*****	0.2358	0.1945	0.0820	-0.3253	*****	*****	*****	*****	*****
-0.700	*****	0.2423	0.2110	0.0929	-0.3694	*****	*****	*****	*****	*****
-0.800	0.2917	0.2545	0.2086	0.1211	-0.4188	*****	*****	*****	*****	*****
-0.850	0.2807	0.2538	0.2251	0.1342	-0.4303	*****	*****	*****	*****	*****
-0.900	0.2524	0.2700	0.2464	0.1554	-0.4394	*****	*****	*****	*****	*****
-0.950	*****	*****	0.2191	0.1888	-0.1366	*****	*****	*****	*****	*****
-0.975	*****	0.0978	0.1385	0.1502	0.0204	*****	*****	*****	*****	*****

Sharp Radius L.E.
 Run No. = 84 , Point No. = 1828
 $C_N = 0.516$, $C_m = -0.0813$
 $\alpha = 12.3^\circ$, $M_\infty = 0.400$
 $R_{mac} = 6.0 \times 10^6$

Surface Pressures Near Leading Edge

● / ◆ upper, starboard/port
 ○ / ◇ lower, starboard/port

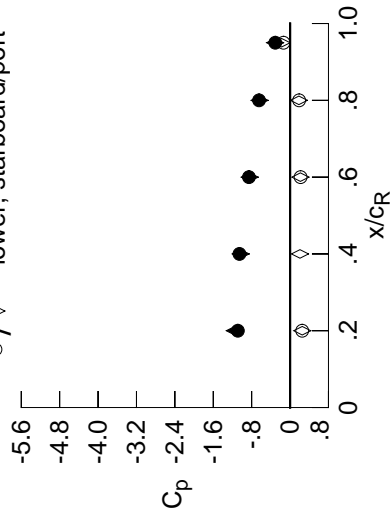

x/c_R	η	starb'd	port	starb'd	port
		$C_{p,u}$	$C_{p,l}$	$C_{p,u}$	$C_{p,l}$
0.20	0.90	-1.0880	-1.1522	0.2536	0.2524
0.40	0.95	-1.0546	-1.0289	0.2065	*****
0.60	0.95	-0.8567	-0.8414	0.2153	0.2191
0.80	0.95	-0.6463	-0.6360	0.1839	0.1888
0.95	0.95	-0.3084	-0.3117	-0.1760	-0.1366

Table D1. Continued.

η	$x/c_R = .2$		$x/c_R = .4$		$x/c_R = .6$		$x/c_R = .8$		$x/c_R = .95$	
	$C_{p,u}$	$C_{p,l}$	$C_{p,u}$	$C_{p,l}$	$C_{p,u}$	$C_{p,l}$	$C_{p,u}$	$C_{p,l}$	$C_{p,u}$	$C_{p,l}$
0.050	-0.2838	-0.2216	-0.0561	*****	*****	*****	*****	*****	*****	*****
0.100	-0.2934	-0.2329	-0.0759	*****	*****	*****	*****	*****	*****	*****
0.150	-0.3074	-0.2284	-0.0853	*****	*****	*****	*****	*****	*****	*****
0.200	-0.3243	-0.2358	-0.1086	*****	*****	*****	*****	*****	*****	*****
0.250	*****	-0.2460	-0.1106	-0.1901	-0.1748	*****	*****	*****	*****	*****
0.300	-0.3265	-0.2380	-0.1449	-0.1678	-0.2263	*****	*****	*****	*****	*****
0.350	-0.3433	-0.2412	-0.1489	-0.1567	-0.2681	*****	*****	*****	*****	*****
0.400	-0.3527	-0.2408	-0.1561	-0.1449	-0.3042	*****	*****	*****	*****	*****
0.450	-0.3786	-0.2437	-0.1573	-0.1298	-0.3373	*****	*****	*****	*****	*****
0.500	-0.3768	-0.2368	-0.1677	-0.1315	-0.3519	*****	*****	*****	*****	*****
0.525	*****	-0.2328	-0.1721	-0.1244	-0.3726	*****	*****	*****	*****	*****
0.550	-0.3590	-0.2245	-0.1725	-0.1308	-0.3751	*****	*****	*****	*****	*****
0.575	*****	-0.2036	-0.1735	-0.1548	-0.4015	*****	*****	*****	*****	*****
0.600	-0.2869	-0.1922	-0.2105	-0.2085	-0.4476	*****	*****	*****	*****	*****
0.625	*****	*****	-0.2569	-0.3335	-0.5611	*****	*****	*****	*****	*****
0.650	-0.3055	-0.2829	-0.3949	-0.5076	-0.6924	*****	*****	*****	*****	*****
0.675	*****	-0.5156	-0.5976	-0.7574	-0.8335	*****	*****	*****	*****	*****
0.700	-0.8053	-0.9276	-0.8685	-1.0121	-0.9633	*****	*****	*****	*****	*****
0.725	*****	-1.3705	*****	-1.1968	-0.9708	*****	*****	*****	*****	*****
0.750	-1.4446	-1.6671	*****	-1.2560	-0.8128	*****	*****	*****	*****	*****
0.775	*****	-1.8205	-1.4945	-1.1248	-0.4950	*****	*****	*****	*****	*****
0.800	-1.6360	-1.8307	-1.3712	-0.8622	*****	*****	*****	*****	*****	*****
0.825	*****	-1.7080	-1.0612	-0.7646	-0.3915	*****	*****	*****	*****	*****
0.850	-1.4682	-1.4795	-0.9819	-0.7485	-0.3827	*****	*****	*****	*****	*****
0.875	*****	-1.2744	-0.9577	-0.7555	-0.4014	*****	*****	*****	*****	*****
0.900	-1.2052	-1.2089	-0.9613	-0.7233	*****	*****	*****	*****	*****	*****
0.925	*****	-1.1685	-0.9340	-0.6774	-0.3869	*****	*****	*****	*****	*****
0.950	-1.2291	-1.1145	-0.9015	-0.6574	-0.3055	*****	*****	*****	*****	*****
0.975	*****	-1.0677	-0.8838	-0.6373	-0.2611	*****	*****	*****	*****	*****
-0.200	0.2618	0.2365	0.2361	*****	-0.3159	*****	*****	*****	*****	*****
-0.400	0.2591	0.2488	0.2110	0.0599	-0.3147	*****	*****	*****	*****	*****
-0.600	*****	0.2554	0.2123	0.0904	-0.3377	*****	*****	*****	*****	*****
-0.700	*****	0.2642	0.2250	0.1045	-0.3894	*****	*****	*****	*****	*****
-0.800	0.3067	0.2704	0.2252	0.1341	-0.4290	*****	*****	*****	*****	*****
-0.850	0.2883	0.2669	0.2410	0.1462	-0.4323	*****	*****	*****	*****	*****
-0.900	0.2523	0.2757	0.2559	0.1658	-0.4318	*****	*****	*****	*****	*****
-0.950	*****	*****	0.2145	0.1938	-0.1259	*****	*****	*****	*****	*****
-0.975	*****	0.0744	0.1214	0.1422	0.0216	*****	*****	*****	*****	*****

Sharp Radius L.E.
 Run No. = 84 , Point No. = 1829
 $C_N = 0.570$, $C_m = -0.0908$
 $\alpha = 13.3^\circ$, $M_\infty = 0.400$
 $R_{mac} = 6.0 \times 10^6$

Surface Pressures Near Leading Edge

● / ◆ upper, starboard/port
 ○ / ◇ lower, starboard/port

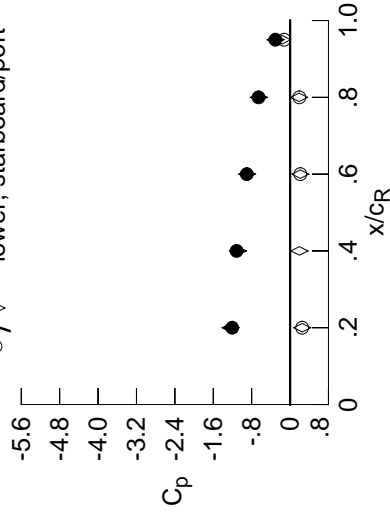

x/c_R	η	starb'd	port	$C_{p,u}$	starb'd	port	$C_{p,l}$
0.20	0.90	-1.2052	-1.2407	0.2524	0.2523	0.2523	0.2523
0.40	0.95	-1.1145	-1.0880	0.1945	0.1945	0.1945	0.1945
0.60	0.95	-0.9015	-0.8962	0.2144	0.2144	0.2144	0.2144
0.80	0.95	-0.6574	-0.6520	0.1879	0.1879	0.1879	0.1879
0.95	0.95	-0.3055	-0.3048	-0.1654	-0.1654	-0.1654	-0.1654

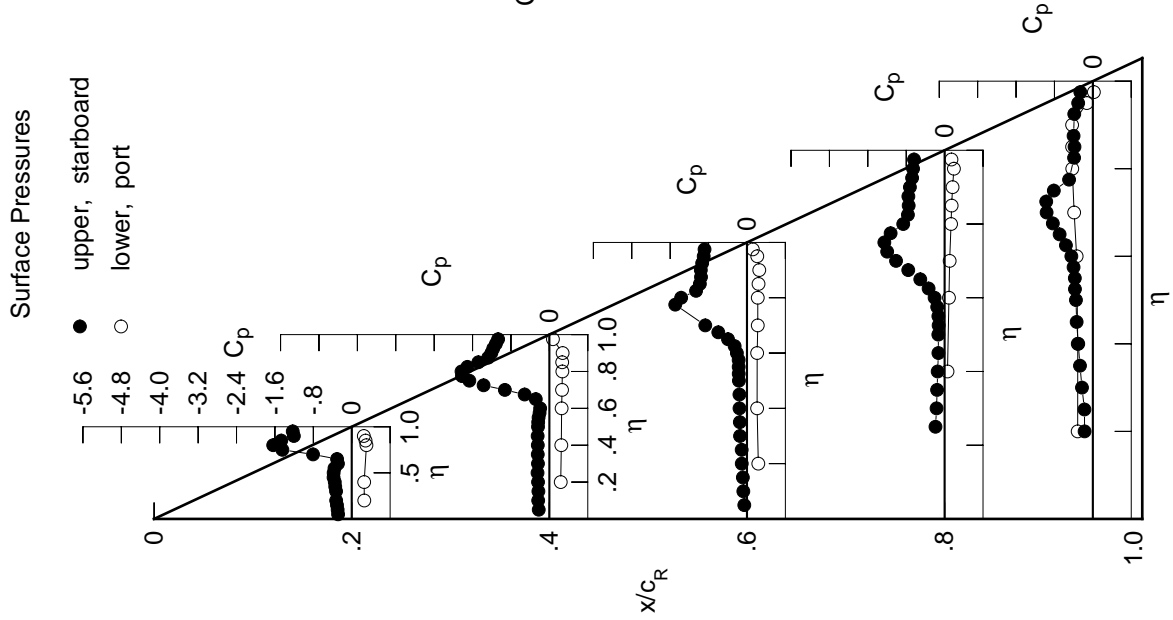

Table D1. Continued.

η	$x/c_R = .2$		$x/c_R = .4$		$x/c_R = .6$		$x/c_R = .8$		$x/c_R = .95$	
	$C_{p,u}$	$C_{p,l}$	$C_{p,u}$	$C_{p,l}$	$C_{p,u}$	$C_{p,l}$	$C_{p,u}$	$C_{p,l}$	$C_{p,u}$	$C_{p,l}$
0.050	-0.3088	-0.2454	-0.0755	*****	*****	*****	*****	*****	*****	*****
0.100	-0.3175	-0.2516	-0.0878	*****	*****	*****	*****	*****	*****	*****
0.150	-0.3374	-0.2534	-0.0968	*****	*****	*****	*****	*****	*****	*****
0.200	-0.3498	-0.2571	-0.1211	*****	*****	*****	*****	*****	*****	*****
0.250	*****	-0.2655	-0.1253	-0.1936	-0.1673	*****	*****	*****	*****	*****
0.300	-0.3519	-0.2614	-0.1613	-0.1733	-0.2191	*****	*****	*****	*****	*****
0.350	-0.3690	-0.2599	-0.1668	-0.1665	-0.2724	*****	*****	*****	*****	*****
0.400	-0.3765	-0.2658	-0.1672	-0.1507	-0.3063	*****	*****	*****	*****	*****
0.450	-0.3990	-0.2675	-0.1722	-0.1423	-0.3445	*****	*****	*****	*****	*****
0.500	-0.3898	-0.2557	-0.1870	-0.1449	-0.3598	*****	*****	*****	*****	*****
0.525	*****	-0.2473	-0.1935	-0.1455	-0.3878	*****	*****	*****	*****	*****
0.550	-0.3594	-0.2422	-0.2070	-0.1705	-0.4045	*****	*****	*****	*****	*****
0.575	*****	-0.2289	-0.2245	-0.2174	-0.4458	*****	*****	*****	*****	*****
0.600	-0.2883	-0.2252	-0.2948	-0.3074	-0.5239	*****	*****	*****	*****	*****
0.625	*****	*****	-0.3876	-0.4694	-0.6518	*****	*****	*****	*****	*****
0.650	-0.4243	-0.4198	-0.5943	-0.6778	-0.7896	*****	*****	*****	*****	*****
0.675	*****	-0.7143	-0.8374	-0.9411	-0.9012	*****	*****	*****	*****	*****
0.700	-1.0891	-1.1540	-1.1167	-1.1724	-0.9795	*****	*****	*****	*****	*****
0.725	*****	-1.5941	*****	-1.3070	-0.9028	*****	*****	*****	*****	*****
0.750	-1.6844	-1.8699	*****	-1.2821	-0.6565	*****	*****	*****	*****	*****
0.775	*****	-2.0145	-1.5343	-1.0800	-0.4138	*****	*****	*****	*****	*****
0.800	-1.8227	-2.0027	-1.3161	-0.8281	*****	*****	*****	*****	*****	*****
0.825	*****	-1.8014	-1.0626	-0.7692	-0.3902	*****	*****	*****	*****	*****
0.850	-1.6050	-1.4831	-1.0345	-0.7673	-0.3734	*****	*****	*****	*****	*****
0.875	*****	-1.3278	-1.0123	-0.7698	-0.3883	*****	*****	*****	*****	*****
0.900	-1.3228	-1.2947	-1.0085	-0.7444	*****	*****	*****	*****	*****	*****
0.925	*****	-1.2548	-0.9772	-0.6936	-0.3819	*****	*****	*****	*****	*****
0.950	-1.3299	-1.1745	-0.9439	-0.6765	-0.2967	*****	*****	*****	*****	*****
0.975	*****	-1.1321	-0.9278	-0.6587	-0.2594	*****	*****	*****	*****	*****

η	$x/c_R = .2$		$x/c_R = .4$		$x/c_R = .6$		$x/c_R = .8$		$x/c_R = .95$	
	$C_{p,u}$	$C_{p,l}$	$C_{p,u}$	$C_{p,l}$	$C_{p,u}$	$C_{p,l}$	$C_{p,u}$	$C_{p,l}$	$C_{p,u}$	$C_{p,l}$
-0.200	0.2851	0.2554	0.2546	*****	*****	*****	*****	*****	*****	*****
-0.400	0.2859	0.2670	0.2300	0.0694	-0.3191	*****	*****	*****	*****	*****
-0.600	*****	0.2776	0.2298	0.1033	-0.3587	*****	*****	*****	*****	*****
-0.700	*****	0.2854	0.2462	0.1199	-0.4107	*****	*****	*****	*****	*****
-0.800	0.3201	0.2887	0.2436	0.1467	-0.4417	*****	*****	*****	*****	*****
-0.850	0.2970	0.2791	0.2553	0.1603	-0.4338	*****	*****	*****	*****	*****
-0.900	0.2506	0.2784	0.2665	0.1782	-0.4240	*****	*****	*****	*****	*****
-0.950	*****	*****	0.2086	0.1968	-0.1127	*****	*****	*****	*****	*****
-0.975	*****	0.0457	0.1017	0.1341	0.0266	*****	*****	*****	*****	*****

Sharp Radius L.E.

Run No. = 84 , Point No. = 1830

$C_N = 0.615$, $C_m = -0.0916$

$\alpha = 14.4^\circ$, $M_\infty = 0.401$

$R_{mac} = 6.0 \times 10^6$

Surface Pressures Near Leading Edge

● / ◆ upper, starboard/port
○ / ◇ lower, starboard/port

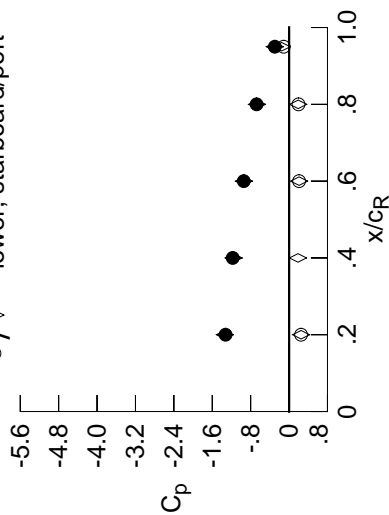

x/c_R	η	starb'd	port	starb'd	port
x/c_R	η	$C_{p,u}$	$C_{p,l}$	$C_{p,u}$	$C_{p,l}$
0.20	0.90	-1.3228	-1.3376	0.2501	0.2506
0.40	0.95	-1.1745	-1.1549	0.1859	*****
0.60	0.95	-0.9439	-0.9417	0.2087	0.2086
0.80	0.95	-0.6765	-0.6684	0.1908	0.1968
0.95	0.95	-0.2967	-0.2978	-0.1528	-0.1127

Table D1. Continued.

η	$x/c_R = .2$		$x/c_R = .4$		$x/c_R = .6$		$x/c_R = .8$		$x/c_R = .95$	
	$C_{p,u}$	$C_{p,l}$	$C_{p,u}$	$C_{p,l}$	$C_{p,u}$	$C_{p,l}$	$C_{p,u}$	$C_{p,l}$	$C_{p,u}$	$C_{p,l}$
0.050	-0.3394	-0.2691	-0.0880	*****	*****	*****	*****	*****	*****	*****
0.100	-0.3484	-0.2812	-0.1027	*****	*****	*****	*****	*****	*****	*****
0.150	-0.3660	-0.2806	-0.1136	*****	*****	*****	*****	*****	*****	*****
0.200	-0.3773	-0.2812	-0.1354	*****	*****	*****	*****	*****	*****	*****
0.250	*****	-0.2935	-0.1451	-0.2004	-0.1670	*****	*****	*****	*****	*****
0.300	-0.3798	-0.2884	-0.1738	-0.1791	-0.2300	*****	*****	*****	*****	*****
0.350	-0.3967	-0.2870	-0.1819	-0.1715	-0.2768	*****	*****	*****	*****	*****
0.400	-0.4019	-0.2921	-0.1817	-0.1593	-0.3119	*****	*****	*****	*****	*****
0.450	-0.4191	-0.2877	-0.1868	-0.1531	-0.3472	*****	*****	*****	*****	*****
0.500	-0.4006	-0.2771	-0.2099	-0.1711	-0.3749	*****	*****	*****	*****	*****
0.525	*****	-0.2708	-0.2275	-0.1837	-0.4139	*****	*****	*****	*****	*****
0.550	-0.3610	-0.2723	-0.2527	-0.2313	-0.4425	*****	*****	*****	*****	*****
0.575	*****	-0.2694	-0.2974	-0.3044	-0.5031	*****	*****	*****	*****	*****
0.600	-0.3215	-0.3008	-0.4137	-0.4293	-0.5973	*****	*****	*****	*****	*****
0.625	*****	*****	-0.5488	-0.6271	-0.7434	*****	*****	*****	*****	*****
0.650	-0.6141	-0.6189	-0.8020	-0.8496	-0.8671	*****	*****	*****	*****	*****
0.675	*****	-0.9634	-1.0718	-1.1026	-0.9388	*****	*****	*****	*****	*****
0.700	-1.3872	-1.4126	-1.3418	-1.3009	-0.9540	*****	*****	*****	*****	*****
0.725	*****	-1.8271	*****	-1.3670	-0.7963	*****	*****	*****	*****	*****
0.750	-1.9232	-2.0721	*****	-1.2776	-0.5191	*****	*****	*****	*****	*****
0.775	*****	-2.1769	-1.5323	-1.0263	-0.3958	*****	*****	*****	*****	*****
0.800	-2.0079	-2.0912	-1.2621	-0.8192	*****	*****	*****	*****	*****	*****
0.825	*****	-1.7574	-1.0924	-0.7820	-0.3927	*****	*****	*****	*****	*****
0.850	-1.7149	-1.4757	-1.0770	-0.7799	-0.3742	*****	*****	*****	*****	*****
0.875	*****	-1.3942	-1.0564	-0.7883	-0.3730	*****	*****	*****	*****	*****
0.900	-1.4406	-1.3797	-1.0539	-0.7584	*****	*****	*****	*****	*****	*****
0.925	*****	-1.3251	-1.0228	-0.7088	-0.3721	*****	*****	*****	*****	*****
0.950	-1.4274	-1.2430	-0.9856	-0.6933	-0.2881	*****	*****	*****	*****	*****
0.975	*****	-1.2024	-0.9652	-0.6707	-0.2537	*****	*****	*****	*****	*****
-0.200	$C_{p,l}$	0.3102	0.2761	0.2709	*****	*****	*****	*****	*****	*****
-0.400	$C_{p,l}$	0.3102	0.2839	0.2471	0.0796	0.3254	*****	*****	*****	*****
-0.600	*****	*****	0.2991	0.2441	0.1161	-0.3794	*****	*****	*****	*****
-0.700	*****	*****	0.3054	0.2613	0.1263	-0.4327	*****	*****	*****	*****
-0.800	$C_{p,l}$	0.3312	0.3051	0.2584	0.1582	-0.4462	*****	*****	*****	*****
-0.850	$C_{p,l}$	0.3013	0.2878	0.2713	0.1739	-0.4340	*****	*****	*****	*****
-0.900	$C_{p,l}$	0.2441	0.2802	0.2728	0.1875	-0.4153	*****	*****	*****	*****
-0.950	*****	*****	*****	0.2009	0.1982	-0.1048	*****	*****	*****	*****
-0.975	*****	*****	0.0158	0.0824	0.1250	0.0295	*****	*****	*****	*****

Sharp Radius L.E.

Run No. = 84, Point No. = 1831

$C_N = 0.666$, $C_m = -0.0960$

$\alpha = 15.4^\circ$, $M_\infty = 0.401$

$R_{mac} = 6.0 \times 10^6$

Surface Pressures Near Leading Edge

● / ◆ upper, starboard/port
○ / ◇ lower, starboard/port

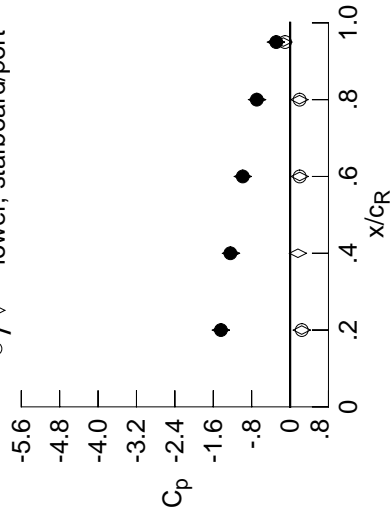

x/cR	η	$C_{p,u}$ starb'd	$C_{p,u}$ port	$C_{p,l}$ starb'd	$C_{p,l}$ port
0.20	0.90	-1.4406	-1.4421	0.2433	0.2441
0.40	0.95	-1.2430	-1.2297	0.1639	*****
0.60	0.95	-0.9856	-0.9851	0.2001	0.2009
0.80	0.95	-0.6933	-0.6861	0.1954	0.1982
0.95	0.95	-0.2881	-0.2944	-0.1401	-0.1048

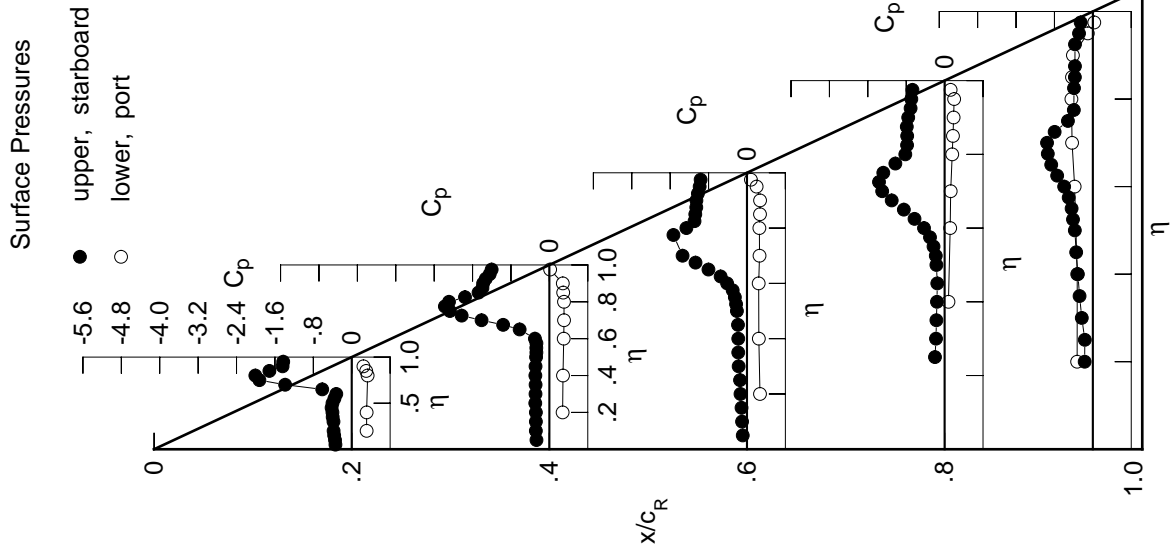

Table D1. Continued.

η	$x/c_R = .2$		$x/c_R = .4$		$x/c_R = .6$		$x/c_R = .8$		$x/c_R = .95$	
	$C_{p,u}$	$C_{p,l}$	$C_{p,u}$	$C_{p,l}$	$C_{p,u}$	$C_{p,l}$	$C_{p,u}$	$C_{p,l}$	$C_{p,u}$	$C_{p,l}$
0.050	-0.3602	-0.2917	-0.0940	*****	*****	*****	*****	*****	*****	*****
0.100	-0.3685	-0.2970	-0.1102	*****	*****	*****	*****	*****	*****	*****
0.150	-0.3887	-0.3002	-0.1226	*****	*****	*****	*****	*****	*****	*****
0.200	-0.4009	-0.3002	-0.1444	*****	*****	*****	*****	*****	*****	*****
0.250	*****	-0.3114	-0.1512	-0.2035	-0.1692	*****	*****	*****	*****	*****
0.300	-0.4018	-0.3041	-0.1845	-0.1801	-0.2244	*****	*****	*****	*****	*****
0.350	-0.4161	-0.3072	-0.1876	-0.1766	-0.2749	*****	*****	*****	*****	*****
0.400	-0.4193	-0.3035	-0.1976	-0.1625	-0.3077	*****	*****	*****	*****	*****
0.450	-0.4318	-0.2979	-0.2055	-0.1652	-0.3512	*****	*****	*****	*****	*****
0.500	-0.4069	-0.2945	-0.2368	-0.2015	-0.3852	*****	*****	*****	*****	*****
0.525	*****	-0.3012	-0.2700	-0.2342	-0.4375	*****	*****	*****	*****	*****
0.550	-0.3662	-0.3103	-0.3147	-0.2969	-0.4800	*****	*****	*****	*****	*****
0.575	*****	-0.3332	-0.3921	-0.3995	-0.5607	*****	*****	*****	*****	*****
0.600	-0.3863	-0.4018	-0.5461	-0.5552	-0.6693	*****	*****	*****	*****	*****
0.625	*****	*****	-0.7239	-0.7686	-0.8091	*****	*****	*****	*****	*****
0.650	-0.8348	-0.8328	-1.0053	-1.0041	-0.9133	*****	*****	*****	*****	*****
0.675	*****	-1.2165	-1.2838	-1.2455	-0.9310	*****	*****	*****	*****	*****
0.700	-1.6550	-1.6567	-1.5224	-1.3897	-0.8827	*****	*****	*****	*****	*****
0.725	*****	-2.0473	*****	-1.3963	-0.6608	*****	*****	*****	*****	*****
0.750	-2.1392	-2.2522	*****	-1.2315	-0.4337	*****	*****	*****	*****	*****
0.775	*****	-2.2914	-1.4967	-0.9602	-0.3971	*****	*****	*****	*****	*****
0.800	-2.1745	-2.0834	-1.2227	-0.8122	*****	*****	*****	*****	*****	*****
0.825	*****	-1.6703	-1.1161	-0.7897	-0.3947	*****	*****	*****	*****	*****
0.850	-1.7793	-1.5010	-1.1194	-0.7895	-0.3747	*****	*****	*****	*****	*****
0.875	*****	-1.4653	-1.0971	-0.7977	-0.3656	*****	*****	*****	*****	*****
0.900	-1.5408	-1.4552	-1.0947	-0.7667	*****	*****	*****	*****	*****	*****
0.925	*****	-1.3833	-1.0597	-0.7218	-0.3583	*****	*****	*****	*****	*****
0.950	-1.5158	-1.3052	-1.0192	-0.7056	-0.2789	*****	*****	*****	*****	*****
0.975	*****	-1.2665	-1.0056	-0.6841	-0.2441	*****	*****	*****	*****	*****
-0.200	0.3406	0.2999	0.2885	*****	*****	*****	*****	*****	*****	*****
-0.400	0.3419	0.3074	0.2670	0.0963	-0.3269	*****	*****	*****	*****	*****
-0.600	*****	0.3246	0.2707	0.1361	-0.3911	*****	*****	*****	*****	*****
-0.700	*****	0.3311	0.2834	0.1466	-0.4428	*****	*****	*****	*****	*****
-0.800	0.3494	0.3274	0.2830	0.1787	-0.4453	*****	*****	*****	*****	*****
-0.850	0.3134	0.3004	0.2908	0.1924	-0.4239	*****	*****	*****	*****	*****
-0.900	0.2462	0.2893	0.2860	0.2069	-0.3985	*****	*****	*****	*****	*****
-0.950	*****	*****	0.2008	0.2040	-0.0880	*****	*****	*****	*****	*****
-0.975	*****	-0.0090	0.0678	0.1262	0.0387	*****	*****	*****	*****	*****

Sharp Radius L.E.
 Run No. = 84, Point No. = 1832
 $C_N = 0.716$, $C_m = -0.1003$
 $\alpha = 16.4^\circ$, $M_\infty = 0.401$
 $R_{mac} = 6.0 \times 10^6$

Surface Pressures Near Leading Edge

● / ◆ upper, starboard/port
 ○ / ◇ lower, starboard/port

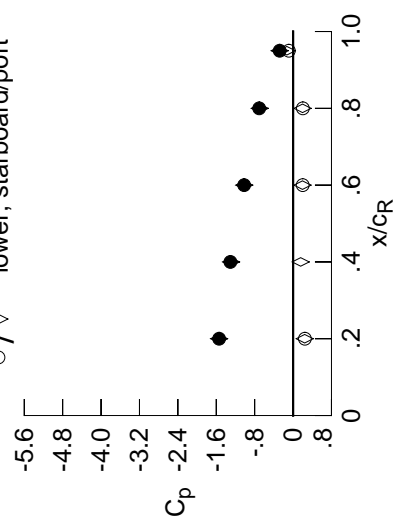

x/c_R	η	starb'd	port	starb'd	port
		$C_{p,u}$	$C_{p,l}$	$C_{p,u}$	$C_{p,l}$
0.20	0.90	-1.5408	-1.5405	0.2427	0.2462
0.40	0.95	-1.3052	-1.2910	0.1583	*****
0.60	0.95	-1.0192	-1.0174	0.1959	0.2008
0.80	0.95	-0.7056	-0.6944	0.1975	0.2040
0.95	0.95	-0.2789	-0.2798	-0.1289	-0.0880

Table D1. Continued.

η	$x/c_R = .2$		$x/c_R = .4$		$x/c_R = .6$		$x/c_R = .8$		$x/c_R = .95$	
	$C_{p,u}$	$C_{p,u}$	$C_{p,u}$	$C_{p,u}$	$C_{p,u}$	$C_{p,u}$	$C_{p,u}$	$C_{p,u}$	$C_{p,u}$	$C_{p,u}$
0.050	-0.3925	-0.3208	-0.1127	*****	*****	*****	*****	*****	*****	*****
0.100	-0.3985	-0.3220	-0.1224	*****	*****	*****	*****	*****	*****	*****
0.150	-0.4226	-0.3258	-0.1410	*****	*****	*****	*****	*****	*****	*****
0.200	-0.4309	-0.3300	-0.1552	*****	*****	*****	*****	*****	*****	*****
0.250	*****	-0.3373	-0.1671	-0.2115	-0.1756	*****	*****	*****	*****	*****
0.300	-0.4323	-0.3307	-0.1978	-0.1912	-0.2304	*****	*****	*****	*****	*****
0.350	-0.4456	-0.3286	-0.2065	-0.1848	-0.2754	*****	*****	*****	*****	*****
0.400	-0.4432	-0.3378	-0.2124	-0.1821	-0.3129	*****	*****	*****	*****	*****
0.450	-0.4510	-0.3310	-0.2285	-0.1899	-0.3577	*****	*****	*****	*****	*****
0.500	-0.4207	-0.3325	-0.2862	-0.2477	-0.4102	*****	*****	*****	*****	*****
0.525	*****	-0.3464	-0.3273	-0.2964	-0.4727	*****	*****	*****	*****	*****
0.550	-0.3936	-0.3757	-0.4071	-0.3870	-0.5276	*****	*****	*****	*****	*****
0.575	*****	-0.4349	-0.5083	-0.5191	-0.6224	*****	*****	*****	*****	*****
0.600	-0.4980	-0.5471	-0.7069	-0.6882	-0.7282	*****	*****	*****	*****	*****
0.625	*****	*****	-0.9109	-0.9248	-0.8585	*****	*****	*****	*****	*****
0.650	-1.0964	-1.0848	-1.2132	-1.1501	-0.9260	*****	*****	*****	*****	*****
0.675	*****	-1.4781	-1.4796	-1.3584	-0.9027	*****	*****	*****	*****	*****
0.700	-1.9294	-1.9162	-1.6819	-1.4509	-0.7927	*****	*****	*****	*****	*****
0.725	*****	-2.2657	*****	-1.3925	-0.5484	*****	*****	*****	*****	*****
0.750	-2.3742	-2.4119	*****	-1.1827	-0.4130	*****	*****	*****	*****	*****
0.775	*****	-2.3236	-1.4420	-0.9133	-0.4010	*****	*****	*****	*****	*****
0.800	-2.3363	-1.9590	-1.2142	-0.8171	*****	*****	*****	*****	*****	*****
0.825	*****	-1.6114	-1.1569	-0.8043	-0.3972	*****	*****	*****	*****	*****
0.850	-1.8170	-1.5447	-1.1646	-0.8051	-0.3782	*****	*****	*****	*****	*****
0.875	*****	-1.5316	-1.1360	-0.8106	-0.3640	*****	*****	*****	*****	*****
0.900	-1.6454	-1.5232	-1.1427	-0.7758	*****	*****	*****	*****	*****	*****
0.925	*****	-1.4463	-1.0943	-0.7300	-0.3473	*****	*****	*****	*****	*****
0.950	-1.6060	-1.3791	-1.0600	-0.7119	-0.2750	*****	*****	*****	*****	*****
0.975	*****	-1.3410	-1.0450	-0.6905	-0.2408	*****	*****	*****	*****	*****
-0.200	$C_{p,l}$	$C_{p,l}$	$C_{p,l}$	$C_{p,l}$	$C_{p,l}$	$C_{p,l}$	$C_{p,l}$	$C_{p,l}$	$C_{p,l}$	$C_{p,l}$
-0.400	0.3653	0.3213	0.3114	*****	-0.3153	*****	*****	*****	*****	*****
-0.600	0.3680	0.3315	0.2858	0.1125	-0.3356	*****	*****	*****	*****	*****
-0.700	*****	0.3426	0.2875	0.1469	-0.4102	*****	*****	*****	*****	*****
-0.800	*****	0.3489	0.3011	0.1644	-0.4591	*****	*****	*****	*****	*****
-0.800	0.3584	0.3413	0.3003	0.1898	-0.4447	*****	*****	*****	*****	*****
-0.850	0.3169	0.3073	0.3037	0.2044	-0.4201	*****	*****	*****	*****	*****
-0.900	0.2394	0.2891	0.2925	0.2163	-0.3875	*****	*****	*****	*****	*****
-0.950	*****	*****	0.1929	0.2039	-0.0748	*****	*****	*****	*****	*****
-0.975	*****	-0.0378	0.0437	0.1160	0.0399	*****	*****	*****	*****	*****

Sharp Radius L.E.
 Run No. = 84, Point No. = 1833
 $C_N = 0.771$, $C_m = -0.1080$
 $\alpha = 17.4^\circ$, $M_\infty = 0.401$
 $R_{mac} = 6.0 \times 10^6$

Surface Pressures Near Leading Edge

● / ◆ upper, starboard/port
 ○ / ◇ lower, starboard/port

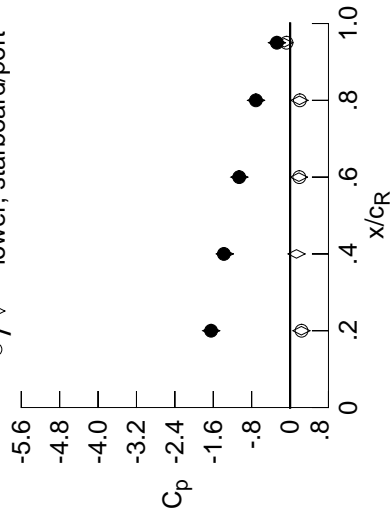

x/c_R	η	starb'd	port	starb'd	port
		$C_{p,u}$	$C_{p,l}$	$C_{p,u}$	$C_{p,l}$
0.20	0.90	-1.6454	-1.6434	0.2353	0.2394
0.40	0.95	-1.3791	-1.3610	0.1338	*****
0.60	0.95	-1.0600	-1.0573	0.1836	0.1929
0.80	0.95	-0.7119	-0.7082	0.1953	0.2039
0.95	0.95	-0.2750	-0.2730	-0.1183	-0.0748

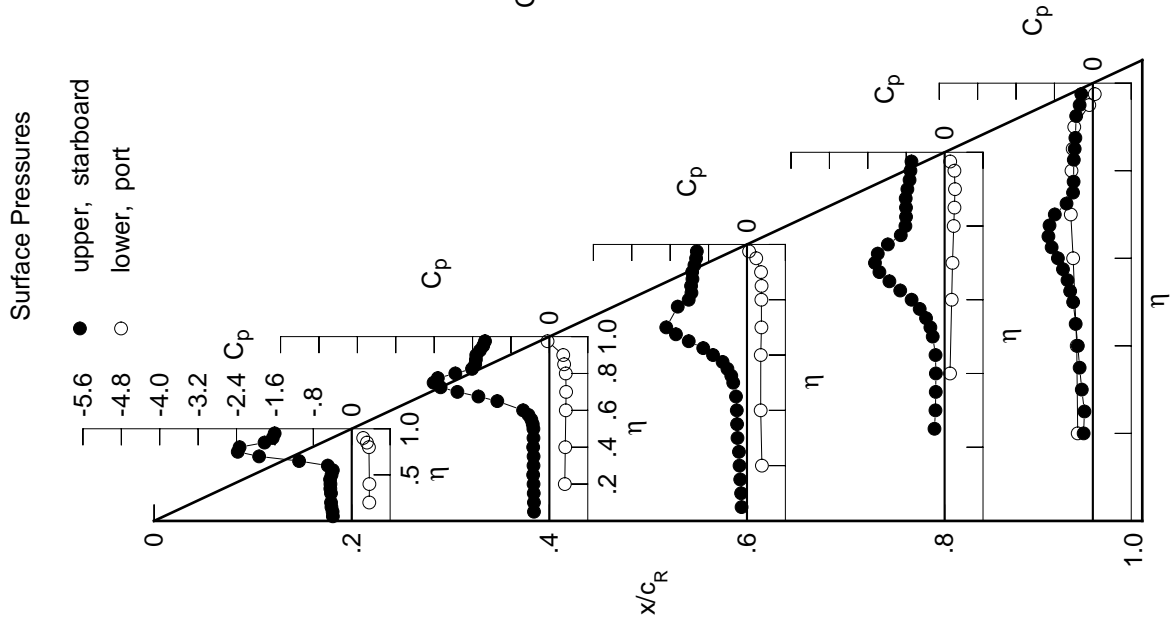

Table D1. Continued.

η	$x/c_R = .2$		$x/c_R = .4$		$x/c_R = .6$		$x/c_R = .8$		$x/c_R = .95$	
	$C_{p,u}$	$C_{p,u}$	$C_{p,u}$	$C_{p,u}$	$C_{p,u}$	$C_{p,u}$	$C_{p,u}$	$C_{p,u}$	$C_{p,u}$	$C_{p,u}$
0.050	-0.4297	-0.3539	-0.1263	*****	*****	*****	*****	*****	*****	*****
0.100	-0.4340	-0.3481	-0.1411	*****	*****	*****	*****	*****	*****	*****
0.150	-0.4577	-0.3601	-0.1576	*****	*****	*****	*****	*****	*****	*****
0.200	-0.4656	-0.3563	-0.1718	*****	*****	*****	*****	*****	*****	*****
0.250	*****	-0.3689	-0.1886	-0.2193	-0.1832	*****	*****	*****	*****	*****
0.300	-0.4643	-0.3620	-0.2145	-0.2092	-0.2412	*****	*****	*****	*****	*****
0.350	-0.4757	-0.3636	-0.2283	-0.1972	-0.2779	*****	*****	*****	*****	*****
0.400	-0.4728	-0.3671	-0.2400	-0.2079	-0.3141	*****	*****	*****	*****	*****
0.450	-0.4762	-0.3671	-0.2689	-0.2222	-0.3718	*****	*****	*****	*****	*****
0.500	-0.4449	-0.3920	-0.3458	-0.3144	-0.4390	*****	*****	*****	*****	*****
0.525	*****	-0.4180	-0.4129	-0.3801	-0.5185	*****	*****	*****	*****	*****
0.550	-0.4445	-0.4775	-0.5231	-0.4962	-0.5800	*****	*****	*****	*****	*****
0.575	*****	-0.5708	-0.6515	-0.6512	-0.6843	*****	*****	*****	*****	*****
0.600	-0.6632	-0.7361	-0.8892	-0.8407	-0.7843	*****	*****	*****	*****	*****
0.625	*****	*****	-1.1148	-1.0843	-0.8975	*****	*****	*****	*****	*****
0.650	-1.3937	-1.3697	-1.4267	-1.2937	-0.9212	*****	*****	*****	*****	*****
0.675	*****	-1.7687	-1.6734	-1.4568	-0.8412	*****	*****	*****	*****	*****
0.700	-2.2406	-2.1845	-1.8216	-1.4867	-0.6934	*****	*****	*****	*****	*****
0.725	*****	-2.4818	*****	-1.3634	-0.4557	*****	*****	*****	*****	*****
0.750	-2.6281	-2.5159	*****	-1.1105	-0.4199	*****	*****	*****	*****	*****
0.775	*****	-2.2498	-1.3779	-0.8775	-0.4092	*****	*****	*****	*****	*****
0.800	-2.4469	-1.8031	-1.2271	-0.8190	*****	*****	*****	*****	*****	*****
0.825	*****	-1.6217	-1.1991	-0.8103	-0.4034	*****	*****	*****	*****	*****
0.850	-1.8467	-1.6060	-1.2054	-0.8156	-0.3819	*****	*****	*****	*****	*****
0.875	*****	-1.6004	-1.1803	-0.8145	-0.3593	*****	*****	*****	*****	*****
0.900	-1.7522	-1.5837	-1.1828	-0.7897	*****	*****	*****	*****	*****	*****
0.925	*****	-1.5062	-1.1371	-0.7452	-0.3366	*****	*****	*****	*****	*****
0.950	-1.7052	-1.4521	-1.1015	-0.7210	-0.2714	*****	*****	*****	*****	*****
0.975	*****	-1.4274	-1.0866	-0.7017	-0.2450	*****	*****	*****	*****	*****
-0.200	$C_{p,l}$	0.3911	0.3475	0.3289	*****	*****	*****	*****	*****	*****
-0.400	$C_{p,l}$	0.3944	0.3569	0.3039	0.1277	-0.3376	*****	*****	*****	*****
-0.600	$C_{p,l}$	*****	0.3627	0.3098	0.1620	-0.4314	*****	*****	*****	*****
-0.700	$C_{p,l}$	*****	0.3706	0.3202	0.1738	-0.4660	*****	*****	*****	*****
-0.800	$C_{p,l}$	0.3695	0.3557	0.3145	0.2063	-0.4451	*****	*****	*****	*****
-0.850	$C_{p,l}$	0.3187	0.3116	0.3177	0.2182	-0.4137	*****	*****	*****	*****
-0.900	$C_{p,l}$	0.2291	0.2863	0.2948	0.2255	-0.3744	*****	*****	*****	*****
-0.950	$C_{p,l}$	*****	*****	0.1821	0.2024	-0.0675	*****	*****	*****	*****
-0.975	$C_{p,l}$	*****	-0.0783	0.0196	0.1031	0.0402	*****	*****	*****	*****

Sharp Radius L.E.

Run No. = 84 , Point No. = 1834

$C_N = 0.827$, $C_m = -0.1131$

$\alpha = 18.4^\circ$, $M_\infty = 0.400$

$R_{mac} = 6.0 \times 10^6$

Surface Pressures Near Leading Edge

● / ◆ upper, starboard/port
○ / ◇ lower, starboard/port

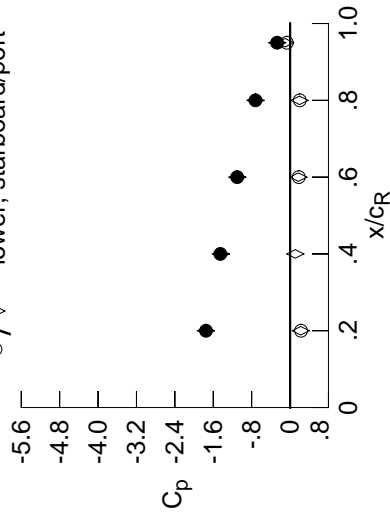

x/c_R	η	starb'd	port	$C_{p,u}$	starb'd	port	$C_{p,l}$
0.20	0.90	-1.7522	-1.7527	0.2227	0.2291	0.2227	0.2291
0.40	0.95	-1.4521	-1.4411	0.1087	*****	0.1087	*****
0.60	0.95	-1.1015	-1.0998	0.1731	0.1821	0.1731	0.1821
0.80	0.95	-0.7210	-0.7199	0.1967	0.2024	0.1967	0.2024
0.95	0.95	-0.2714	-0.2689	-0.1040	-0.0675	-0.1040	-0.0675

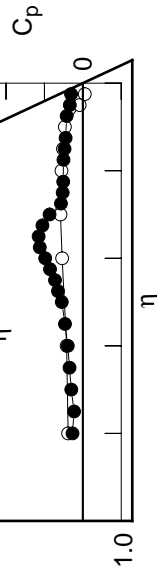

Table D1. Continued.

η	$x/c_R = .2$		$x/c_R = .4$		$x/c_R = .6$		$x/c_R = .8$		$x/c_R = .95$	
	$C_{p,u}$	$C_{p,l}$	$C_{p,u}$	$C_{p,l}$	$C_{p,u}$	$C_{p,l}$	$C_{p,u}$	$C_{p,l}$	$C_{p,u}$	$C_{p,l}$
0.050	-0.4663	-0.3827	-0.1472	*****	*****	*****	*****	*****	*****	*****
0.100	-0.4709	-0.3800	-0.1543	*****	*****	*****	*****	*****	*****	*****
0.150	-0.4994	-0.3911	-0.1758	*****	*****	*****	*****	*****	*****	*****
0.200	-0.5041	-0.3894	-0.1917	*****	*****	*****	*****	*****	*****	*****
0.250	*****	-0.4003	-0.2037	-0.2401	-0.2046	*****	*****	*****	*****	*****
0.300	-0.5016	-0.3952	-0.2420	-0.2231	-0.2489	*****	*****	*****	*****	*****
0.350	-0.5106	-0.3911	-0.2539	-0.2221	-0.2847	*****	*****	*****	*****	*****
0.400	-0.5041	-0.4074	-0.2712	-0.2347	-0.3161	*****	*****	*****	*****	*****
0.450	-0.5054	-0.4141	-0.3115	-0.2717	-0.3892	*****	*****	*****	*****	*****
0.500	-0.4818	-0.4549	-0.4282	-0.3884	-0.4698	*****	*****	*****	*****	*****
0.525	*****	-0.5123	-0.5081	-0.4764	-0.5603	*****	*****	*****	*****	*****
0.550	-0.5261	-0.6055	-0.6439	-0.6106	-0.6275	*****	*****	*****	*****	*****
0.575	*****	-0.7407	-0.8028	-0.7877	-0.7288	*****	*****	*****	*****	*****
0.600	-0.8655	-0.9491	-1.0728	-0.9814	-0.8208	*****	*****	*****	*****	*****
0.625	*****	*****	-1.3131	-1.2195	-0.9039	*****	*****	*****	*****	*****
0.650	-1.7071	-1.6467	-1.6138	-1.3999	-0.8997	*****	*****	*****	*****	*****
0.675	*****	-2.0444	-1.8281	-1.5214	-0.7796	*****	*****	*****	*****	*****
0.700	-2.5407	-2.4162	-1.9155	-1.4916	-0.6142	*****	*****	*****	*****	*****
0.725	*****	-2.6207	*****	-1.3222	-0.4153	*****	*****	*****	*****	*****
0.750	-2.8508	-2.5025	*****	-1.0467	-0.4304	*****	*****	*****	*****	*****
0.775	*****	-2.0916	-1.3486	-0.8610	-0.4118	*****	*****	*****	*****	*****
0.800	-2.4620	-1.7365	-1.2566	-0.8258	*****	*****	*****	*****	*****	*****
0.825	*****	-1.6706	-1.2328	-0.8127	-0.3991	*****	*****	*****	*****	*****
0.850	-1.9055	-1.6766	-1.2416	-0.8220	-0.3763	*****	*****	*****	*****	*****
0.875	*****	-1.6706	-1.2214	-0.8193	-0.3569	*****	*****	*****	*****	*****
0.900	-1.8547	-1.6384	-1.2233	-0.7931	*****	*****	*****	*****	*****	*****
0.925	*****	-1.5702	-1.1801	-0.7541	-0.3240	*****	*****	*****	*****	*****
0.950	-1.8087	-1.5321	-1.1418	-0.7278	-0.2738	*****	*****	*****	*****	*****
0.975	*****	-1.5130	-1.1303	-0.7054	-0.2507	*****	*****	*****	*****	*****
-0.200	0.4162	0.3637	0.3454	*****	-0.3020	*****	*****	*****	*****	*****
-0.400	0.4196	0.3779	0.3185	0.1361	-0.3483	*****	*****	*****	*****	*****
-0.600	*****	0.3829	0.3275	0.1780	-0.4474	*****	*****	*****	*****	*****
-0.700	*****	0.3858	0.3348	0.1843	-0.4779	*****	*****	*****	*****	*****
-0.800	0.3734	0.3667	0.3278	0.2185	-0.4450	*****	*****	*****	*****	*****
-0.850	0.3140	0.3169	0.3259	0.2302	-0.4115	*****	*****	*****	*****	*****
-0.900	0.2161	0.2801	0.2967	0.2336	-0.3661	*****	*****	*****	*****	*****
-0.950	*****	*****	0.1670	0.2004	-0.0597	*****	*****	*****	*****	*****
-0.975	*****	-0.1180	-0.0077	0.0929	0.0412	*****	*****	*****	*****	*****

Sharp Radius L.E.
 Run No. = 84 , Point No. = 1835
 $C_N = 0.885$, $C_m = -0.1202$
 $\alpha = 19.4^\circ$, $M_\infty = 0.401$
 $R_{mac} = 6.0 \times 10^6$

Surface Pressures Near Leading Edge

● / ◆ upper, starboard/port
 ○ / ◇ lower, starboard/port

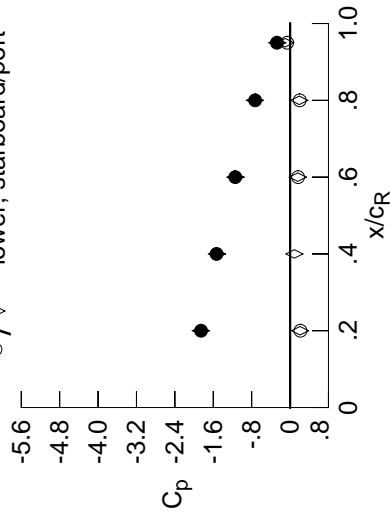

x/c_R	η	starb'd	port	$C_{p,u}$	starb'd	port	$C_{p,l}$
0.20	0.90	-1.8547	-1.8578	0.2074	0.2161	*****	*****
0.40	0.95	-1.5321	-1.5225	0.0888	*****	*****	*****
0.60	0.95	-1.1418	-1.1369	0.1599	0.1670	*****	*****
0.80	0.95	-0.7278	-0.7317	0.1917	0.2004	*****	*****
0.95	0.95	-0.2738	-0.2672	-0.1013	-0.0597	*****	*****

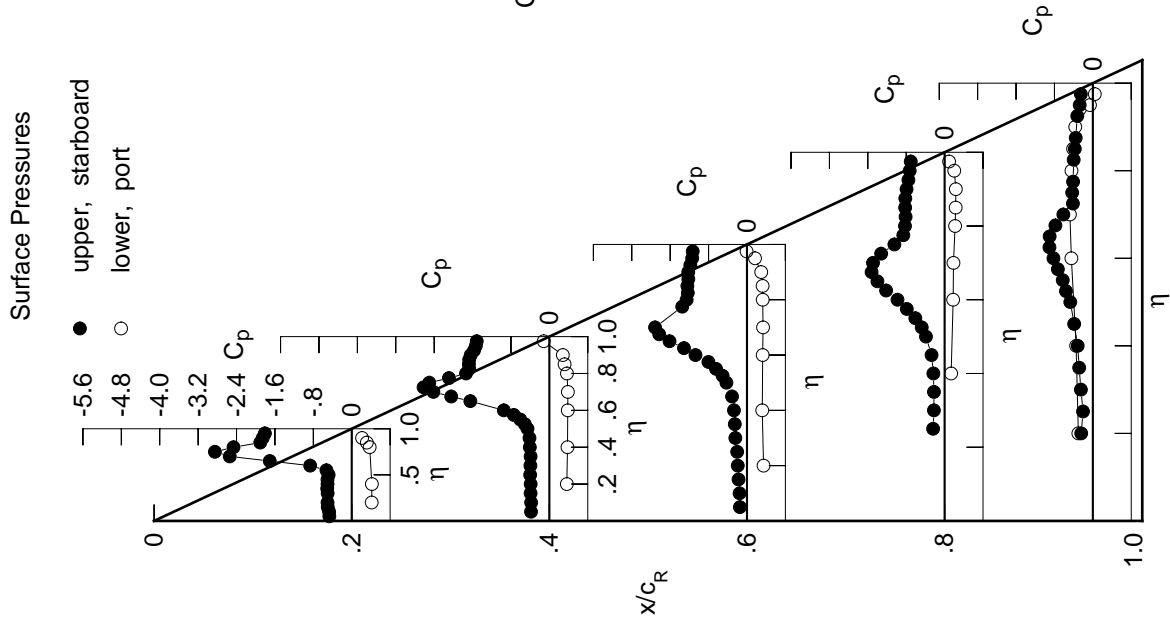

Table D1. Continued.

η	$x/c_R = .2$		$x/c_R = .4$		$x/c_R = .6$		$x/c_R = .8$		$x/c_R = .95$	
	$C_{p,u}$	$C_{p,l}$	$C_{p,u}$	$C_{p,l}$	$C_{p,u}$	$C_{p,l}$	$C_{p,u}$	$C_{p,l}$	$C_{p,u}$	$C_{p,l}$
0.050	-0.5074	-0.4151	-0.1609	*****	*****	*****	*****	*****	*****	*****
0.100	-0.5139	-0.4172	-0.1794	*****	*****	*****	*****	*****	*****	*****
0.150	-0.5334	-0.4192	-0.1880	*****	*****	*****	*****	*****	*****	*****
0.200	-0.5463	-0.4262	-0.2155	*****	*****	*****	*****	*****	*****	*****
0.250	*****	-0.4335	-0.2251	-0.2573	-0.2342	*****	*****	*****	*****	*****
0.300	-0.5385	-0.4321	-0.2678	-0.2425	-0.2571	*****	*****	*****	*****	*****
0.350	-0.5474	-0.4307	-0.2801	-0.2432	-0.2906	*****	*****	*****	*****	*****
0.400	-0.5357	-0.4508	-0.3128	-0.2688	-0.3293	*****	*****	*****	*****	*****
0.450	-0.5394	-0.4776	-0.3693	-0.3265	-0.4050	*****	*****	*****	*****	*****
0.500	-0.5325	-0.5496	-0.5145	-0.4724	-0.5040	*****	*****	*****	*****	*****
0.525	*****	-0.6299	-0.6248	-0.5788	-0.5987	*****	*****	*****	*****	*****
0.550	-0.6384	-0.7534	-0.7850	-0.7315	-0.6728	*****	*****	*****	*****	*****
0.575	*****	-0.9277	-0.9731	-0.9194	-0.7661	*****	*****	*****	*****	*****
0.600	-1.1069	-1.1770	-1.2583	-1.1189	-0.8439	*****	*****	*****	*****	*****
0.625	*****	*****	-1.5025	-1.3404	-0.8937	*****	*****	*****	*****	*****
0.650	-2.0341	-1.9193	-1.7903	-1.4871	-0.8556	*****	*****	*****	*****	*****
0.675	*****	-2.3049	-1.9572	-1.5532	-0.7151	*****	*****	*****	*****	*****
0.700	-2.8486	-2.6155	-1.9848	-1.4756	-0.5381	*****	*****	*****	*****	*****
0.725	*****	-2.6965	*****	-1.2586	-0.4024	*****	*****	*****	*****	*****
0.750	-3.0217	-2.4222	*****	-0.9815	-0.4321	*****	*****	*****	*****	*****
0.775	*****	-1.9455	-1.3429	-0.8458	-0.4087	*****	*****	*****	*****	*****
0.800	-2.3998	-1.7538	-1.2897	-0.8242	*****	*****	*****	*****	*****	*****
0.825	*****	-1.7311	-1.2694	-0.8111	-0.3931	*****	*****	*****	*****	*****
0.850	-1.9688	-1.7432	-1.2795	-0.8121	-0.3719	*****	*****	*****	*****	*****
0.875	*****	-1.7456	-1.2626	-0.8156	-0.3547	*****	*****	*****	*****	*****
0.900	-1.9490	-1.7045	-1.2656	-0.7913	*****	*****	*****	*****	*****	*****
0.925	*****	-1.6389	-1.2182	-0.7535	-0.3128	*****	*****	*****	*****	*****
0.950	-1.9094	-1.6041	-1.1750	-0.7279	-0.2809	*****	*****	*****	*****	*****
0.975	*****	-1.5955	-1.1647	-0.7115	-0.2680	*****	*****	*****	*****	*****
-0.200	0.4412	0.3862	0.3621	*****	-0.2926	*****	*****	*****	*****	*****
-0.400	0.4450	0.3999	0.3385	0.1527	-0.3512	*****	*****	*****	*****	*****
-0.600	*****	0.4031	0.3404	0.1878	-0.4577	*****	*****	*****	*****	*****
-0.700	*****	0.4036	0.3517	0.1974	-0.4825	*****	*****	*****	*****	*****
-0.800	0.3778	0.3770	0.3417	0.2286	-0.4432	*****	*****	*****	*****	*****
-0.850	0.3102	0.3207	0.3359	0.2397	-0.4070	*****	*****	*****	*****	*****
-0.900	0.2004	0.2744	0.2970	0.2388	-0.3576	*****	*****	*****	*****	*****
-0.950	*****	*****	0.1540	0.1974	-0.0538	*****	*****	*****	*****	*****
-0.975	*****	-0.1562	-0.0338	0.0808	0.0382	*****	*****	*****	*****	*****

Sharp Radius L.E.

Run No. = 84 , Point No. = 1836

$C_N = 0.942$, $C_m = -0.1282$

$\alpha = 20.5^\circ$, $M_\infty = 0.401$

$R_{mac} = 6.0 \times 10^6$

Surface Pressures Near Leading Edge

● / ◆ upper, starboard/port
○ / ◇ lower, starboard/port

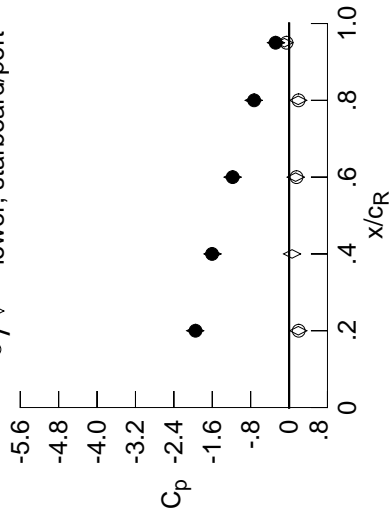

x/c_R	η	starb'd	port	$C_{p,u}$	starb'd	port	$C_{p,l}$
0.20	0.90	-1.9490	-1.9564	0.1918	0.2004	*****	*****
0.40	0.95	-1.6041	-1.5962	0.0627	*****	*****	*****
0.60	0.95	-1.1750	-1.1773	0.1371	0.1540	*****	*****
0.80	0.95	-0.7279	-0.7378	0.1908	0.1974	*****	*****
0.95	0.95	-0.2809	-0.2717	-0.0970	-0.0538	*****	*****

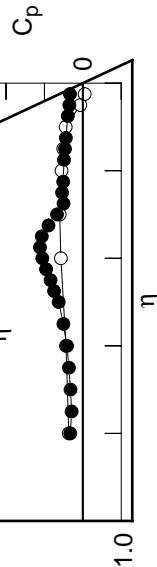

Table D1. Continued.

η	$x/c_R = .2$		$x/c_R = .4$		$x/c_R = .6$		$x/c_R = .8$		$x/c_R = .95$	
	$C_{p,u}$	$C_{p,u}$	$C_{p,u}$	$C_{p,u}$	$C_{p,u}$	$C_{p,u}$	$C_{p,u}$	$C_{p,u}$	$C_{p,u}$	$C_{p,u}$
0.050	-0.5471	-0.4461	-0.1758	*****	*****	*****	*****	*****	*****	*****
0.100	-0.5523	-0.4503	-0.1938	*****	*****	*****	*****	*****	*****	*****
0.150	-0.5759	-0.4533	-0.2115	*****	*****	*****	*****	*****	*****	*****
0.200	-0.5854	-0.4593	-0.2377	*****	*****	*****	*****	*****	*****	*****
0.250	*****	-0.4699	-0.2488	-0.2760	-0.2613	*****	*****	*****	*****	*****
0.300	-0.5782	-0.4673	-0.2938	-0.2612	-0.2714	*****	*****	*****	*****	*****
0.350	-0.5850	-0.4716	-0.3107	-0.2759	-0.3012	*****	*****	*****	*****	*****
0.400	-0.5750	-0.5023	-0.3547	-0.3063	-0.3416	*****	*****	*****	*****	*****
0.450	-0.5768	-0.5436	-0.4344	-0.3879	-0.4299	*****	*****	*****	*****	*****
0.500	-0.5989	-0.6539	-0.6118	-0.5588	-0.5391	*****	*****	*****	*****	*****
0.525	*****	-0.7661	-0.7457	-0.6859	-0.6373	*****	*****	*****	*****	*****
0.550	-0.7819	-0.9218	-0.9344	-0.8521	-0.7078	*****	*****	*****	*****	*****
0.575	*****	-1.1341	-1.1367	-1.0419	-0.7915	*****	*****	*****	*****	*****
0.600	-1.3679	-1.4116	-1.4369	-1.2386	-0.8528	*****	*****	*****	*****	*****
0.625	*****	*****	-1.6805	-1.4352	-0.8781	*****	*****	*****	*****	*****
0.650	-2.3759	-2.1800	-1.9373	-1.5432	-0.8117	*****	*****	*****	*****	*****
0.675	*****	-2.5301	-2.0535	-1.5609	-0.6528	*****	*****	*****	*****	*****
0.700	-3.1455	-2.7580	-2.0192	-1.4380	-0.4818	*****	*****	*****	*****	*****
0.725	*****	-2.7042	*****	-1.1879	-0.3925	*****	*****	*****	*****	*****
0.750	-3.1083	-2.3165	*****	-0.9213	-0.4236	*****	*****	*****	*****	*****
0.775	*****	-1.8880	-1.3577	-0.8381	-0.4006	*****	*****	*****	*****	*****
0.800	-2.3451	-1.8100	-1.3266	-0.8140	*****	*****	*****	*****	*****	*****
0.825	*****	-1.7986	-1.3026	-0.8016	-0.3814	*****	*****	*****	*****	*****
0.850	-2.0467	-1.8133	-1.3155	-0.8046	-0.3656	*****	*****	*****	*****	*****
0.875	*****	-1.8163	-1.2971	-0.8038	-0.3515	*****	*****	*****	*****	*****
0.900	-2.0444	-1.7696	-1.3017	-0.7885	*****	*****	*****	*****	*****	*****
0.925	*****	-1.7047	-1.2552	-0.7550	-0.3191	*****	*****	*****	*****	*****
0.950	-2.0136	-1.6731	-1.2138	-0.7306	-0.2958	*****	*****	*****	*****	*****
0.975	*****	-1.6657	-1.2046	-0.7084	-0.2866	*****	*****	*****	*****	*****
-0.200	0.4694	0.4063	0.3798	*****	-0.2888	*****	*****	*****	*****	*****
-0.400	0.4669	0.4204	0.3582	0.1639	-0.3551	*****	*****	*****	*****	*****
-0.600	*****	0.4243	0.3562	0.2029	-0.4667	*****	*****	*****	*****	*****
-0.700	*****	0.4203	0.3721	0.2125	-0.4844	*****	*****	*****	*****	*****
-0.800	0.3798	0.3861	0.3550	0.2396	-0.4406	*****	*****	*****	*****	*****
-0.850	0.3060	0.3206	0.3415	0.2497	-0.4010	*****	*****	*****	*****	*****
-0.900	0.1819	0.2701	0.2965	0.2455	-0.3476	*****	*****	*****	*****	*****
-0.950	*****	*****	0.1338	0.1914	-0.0476	*****	*****	*****	*****	*****
-0.975	*****	-0.2022	-0.0628	0.0690	0.0340	*****	*****	*****	*****	*****

Sharp Radius L.E.

Run No. = 84 , Point No. = 1837

$C_N = 0.997$, $C_m = -0.1340$

$\alpha = 21.5^\circ$, $M_\infty = 0.401$

$R_{mac} = 6.0 \times 10^6$

Surface Pressures Near Leading Edge

● / ◆ upper, starboard/port
○ / ◇ lower, starboard/port

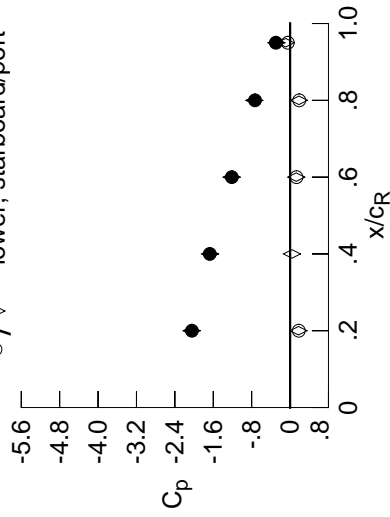

x/c_R	η	starb'd	port	starb'd	port
		$C_{p,u}$	$C_{p,u}$	$C_{p,l}$	$C_{p,l}$
0.20	0.90	-2.0444	-2.0523	0.1751	0.1819
0.40	0.95	-1.6731	-1.6670	0.0390	*****
0.60	0.95	-1.2138	-1.2184	0.1281	0.1338
0.80	0.95	-0.7306	-0.7452	0.1851	0.1914
0.95	0.95	-0.2958	-0.2857	-0.0903	-0.0476

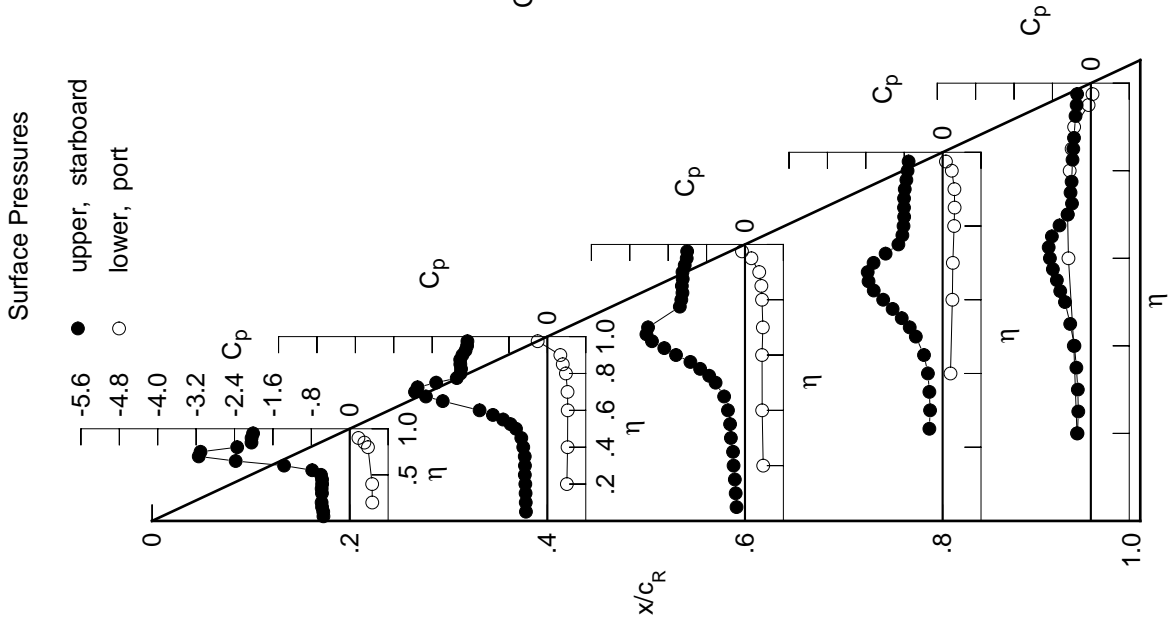

Table D1. Continued.

η	$x/c_R = .2$		$x/c_R = .4$		$x/c_R = .6$		$x/c_R = .8$		$x/c_R = .95$	
	$C_{p,u}$	$C_{p,l}$	$C_{p,u}$	$C_{p,l}$	$C_{p,u}$	$C_{p,l}$	$C_{p,u}$	$C_{p,l}$	$C_{p,u}$	$C_{p,l}$
0.050	-0.5902	-0.4802	-0.1945	*****	*****	*****	*****	*****	*****	*****
0.100	-0.5975	-0.4841	-0.2116	*****	*****	*****	*****	*****	*****	*****
0.150	-0.6189	-0.4857	-0.2296	*****	*****	*****	*****	*****	*****	*****
0.200	-0.6302	-0.4905	-0.2577	*****	*****	*****	*****	*****	*****	*****
0.250	*****	-0.5046	-0.2707	-0.2947	-0.2887	*****	*****	*****	*****	*****
0.300	-0.6213	-0.5046	-0.3208	-0.2834	-0.2972	*****	*****	*****	*****	*****
0.350	-0.6280	-0.5202	-0.3494	-0.3049	-0.3172	*****	*****	*****	*****	*****
0.400	-0.6169	-0.5546	-0.4019	-0.3528	-0.3612	*****	*****	*****	*****	*****
0.450	-0.6292	-0.6266	-0.5096	-0.4520	-0.4497	*****	*****	*****	*****	*****
0.500	-0.6899	-0.7719	-0.7218	-0.6558	-0.5774	*****	*****	*****	*****	*****
0.525	*****	-0.9151	-0.8795	-0.7929	-0.6731	*****	*****	*****	*****	*****
0.550	-0.9670	-1.1057	-1.0865	-0.9714	-0.7417	*****	*****	*****	*****	*****
0.575	*****	-1.3507	-1.3071	-1.1598	-0.8146	*****	*****	*****	*****	*****
0.600	-1.6710	-1.6522	-1.6085	-1.3434	-0.8495	*****	*****	*****	*****	*****
0.625	*****	*****	-1.8408	-1.5088	-0.8525	*****	*****	*****	*****	*****
0.650	-2.7402	-2.4204	-2.0642	-1.5751	-0.7583	*****	*****	*****	*****	*****
0.675	*****	-2.7223	-2.1334	-1.5381	-0.5949	*****	*****	*****	*****	*****
0.700	-3.4144	-2.8563	-2.0449	-1.3739	-0.4372	*****	*****	*****	*****	*****
0.725	*****	-2.6868	*****	-1.0985	-0.3992	*****	*****	*****	*****	*****
0.750	-3.0844	-2.2302	*****	-0.8668	-0.4273	*****	*****	*****	*****	*****
0.775	*****	-1.9069	-1.3844	-0.8223	-0.4060	*****	*****	*****	*****	*****
0.800	-2.3451	-1.8777	-1.3607	-0.8013	*****	*****	*****	*****	*****	*****
0.825	*****	-1.8705	-1.3414	-0.7874	-0.3949	*****	*****	*****	*****	*****
0.850	-2.1478	-1.8871	-1.3552	-0.7868	-0.3800	*****	*****	*****	*****	*****
0.875	*****	-1.8878	-1.3362	-0.7936	-0.3829	*****	*****	*****	*****	*****
0.900	-2.1463	-1.8407	-1.3392	-0.7741	*****	*****	*****	*****	*****	*****
0.925	*****	-1.7743	-1.2985	-0.7512	-0.3542	*****	*****	*****	*****	*****
0.950	-2.1120	-1.7408	-1.2499	-0.7283	-0.3351	*****	*****	*****	*****	*****
0.975	*****	-1.7312	-1.2418	-0.7057	-0.3217	*****	*****	*****	*****	*****
-0.200	$C_{p,l}$	0.4915	0.4342	0.3966	*****	-0.2924	*****	*****	*****	*****
-0.400	0.4915	0.4397	0.3745	0.1784	-0.3600	*****	*****	*****	*****	*****
-0.600	*****	0.4418	0.3745	0.2163	-0.4701	*****	*****	*****	*****	*****
-0.700	*****	0.4379	0.3827	0.2264	-0.4868	*****	*****	*****	*****	*****
-0.800	0.3815	0.3954	0.3663	0.2499	-0.4382	*****	*****	*****	*****	*****
-0.850	0.2975	0.3211	0.3496	0.2614	-0.3976	*****	*****	*****	*****	*****
-0.900	0.1649	0.2593	0.2970	0.2506	-0.3386	*****	*****	*****	*****	*****
-0.950	*****	*****	0.1186	0.1889	-0.0441	*****	*****	*****	*****	*****
-0.975	*****	-0.2433	-0.0888	0.0562	0.0285	*****	*****	*****	*****	*****

Sharp Radius L.E.

Run No. = 84, Point No. = 1838

$C_N = 1.057$, $C_m = -0.1435$

$\alpha = 22.5^\circ$, $M_\infty = 0.401$

$R_{mac} = 6.0 \times 10^6$

Surface Pressures Near Leading Edge

● / ◆ upper, starboard/port
○ / ◇ lower, starboard/port

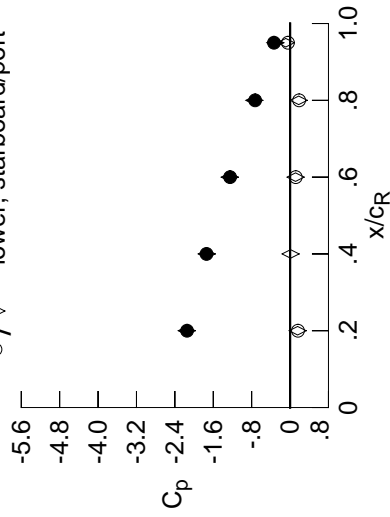

x/c_R	η	starb'd	port	starb'd	port
		$C_{p,u}$	$C_{p,l}$	$C_{p,u}$	$C_{p,l}$
0.20	0.90	-2.1463	-2.1527	0.1575	0.1649
0.40	0.95	-1.7408	-1.7372	0.0100	*****
0.60	0.95	-1.2499	-1.2575	0.1142	0.1186
0.80	0.95	-0.7283	-0.7446	0.1801	0.1889
0.95	0.95	-0.3351	-0.3083	-0.0889	-0.0441

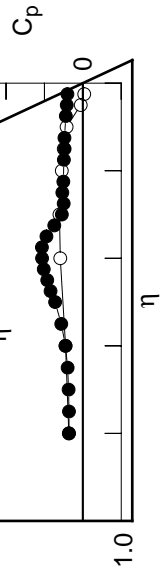

Table D1. Continued.

η	$x/c_R = .2$		$x/c_R = .4$		$x/c_R = .6$		$x/c_R = .8$		$x/c_R = .95$	
	$C_{p,u}$	$C_{p,l}$	$C_{p,u}$	$C_{p,l}$	$C_{p,u}$	$C_{p,l}$	$C_{p,u}$	$C_{p,l}$	$C_{p,u}$	$C_{p,l}$
0.050	-0.6356	-0.5128	-0.2129	*****	*****	*****	*****	*****	*****	*****
0.100	-0.6432	-0.5160	-0.2309	*****	*****	*****	*****	*****	*****	*****
0.150	-0.6640	-0.5213	-0.2459	*****	*****	*****	*****	*****	*****	*****
0.200	-0.6741	-0.5241	-0.2813	*****	*****	*****	*****	*****	*****	-0.2897
0.250	*****	-0.5427	-0.2952	-0.3150	-0.3081	*****	*****	*****	*****	-0.3081
0.300	-0.6636	-0.5427	-0.3478	-0.3105	-0.3152	*****	*****	*****	*****	-0.3152
0.350	-0.6689	-0.5671	-0.3885	-0.3380	-0.3359	*****	*****	*****	*****	-0.3359
0.400	-0.6647	-0.6182	-0.4596	-0.4026	-0.3802	*****	*****	*****	*****	-0.3802
0.450	-0.6939	-0.7167	-0.5901	-0.5260	-0.4831	*****	*****	*****	*****	-0.4831
0.500	-0.8021	-0.9064	-0.8353	-0.7528	-0.6104	*****	*****	*****	*****	-0.6104
0.525	*****	-1.0818	-1.0161	-0.8976	-0.7076	*****	*****	*****	*****	-0.7076
0.550	-1.1768	-1.2953	-1.2367	-1.0773	-0.7646	*****	*****	*****	*****	-0.7646
0.575	*****	-1.5685	-1.4680	-1.2621	-0.8235	*****	*****	*****	*****	-0.8235
0.600	-1.9924	-1.8851	-1.7662	-1.4233	-0.8411	*****	*****	*****	*****	-0.8411
0.625	*****	*****	-1.9801	-1.5557	-0.8163	*****	*****	*****	*****	-0.8163
0.650	-3.1131	-2.6341	-2.1637	-1.5728	-0.7152	*****	*****	*****	*****	-0.7152
0.675	*****	-2.8689	-2.1852	-1.4926	-0.5461	*****	*****	*****	*****	-0.5461
0.700	-3.6309	-2.9123	-2.0510	-1.2913	-0.4299	*****	*****	*****	*****	-0.4299
0.725	*****	-2.6447	*****	-1.0054	-0.4182	*****	*****	*****	*****	-0.4182
0.750	-2.9899	-2.1712	*****	-0.8282	-0.4535	*****	*****	*****	*****	-0.4535
0.775	*****	-1.9523	-1.4087	-0.8072	-0.4368	*****	*****	*****	*****	-0.4368
0.800	-2.3729	-1.9431	-1.3947	-0.7864	*****	*****	*****	*****	*****	-0.7864
0.825	*****	-1.9401	-1.3697	-0.7783	-0.4384	*****	*****	*****	*****	-0.4384
0.850	-2.2638	-1.9568	-1.3838	-0.7747	-0.4304	*****	*****	*****	*****	-0.4304
0.875	*****	-1.9622	-1.3612	-0.7718	-0.4339	*****	*****	*****	*****	-0.4339
0.900	-2.2463	-1.9093	-1.3716	-0.7608	*****	*****	*****	*****	*****	-0.7608
0.925	*****	-1.8369	-1.3341	-0.7457	-0.4038	*****	*****	*****	*****	-0.4038
0.950	-2.2078	-1.8039	-1.2875	-0.7264	-0.3764	*****	*****	*****	*****	-0.3764
0.975	*****	-1.7932	-1.2788	-0.7057	-0.3661	*****	*****	*****	*****	-0.3661
-0.200	$C_{p,l}$	0.5180	0.4515	0.4153	*****	*****	*****	*****	*****	-0.2969
-0.400	*****	0.5154	0.4601	0.3939	0.1944	-0.3604	*****	*****	*****	-0.3604
-0.600	*****	*****	0.4614	0.3910	0.2311	-0.4747	*****	*****	*****	-0.4747
-0.700	*****	*****	0.4552	0.4009	0.2419	-0.4822	*****	*****	*****	-0.4822
-0.800	*****	0.3817	0.4039	0.3798	0.2647	-0.4333	*****	*****	*****	-0.4333
-0.850	*****	0.2909	0.3224	0.3594	0.2727	-0.3907	*****	*****	*****	-0.3907
-0.900	*****	0.1466	0.2485	0.2958	0.2572	-0.3294	*****	*****	*****	-0.3294
-0.950	*****	*****	*****	0.1034	0.1843	-0.0417	*****	*****	*****	-0.0417
-0.975	*****	*****	-0.2824	-0.1169	0.0458	0.0215	*****	*****	*****	0.0215

Sharp Radius L.E.
 Run No. = 84 , Point No. = 1839
 $C_N = 1.113$, $C_m = -0.1485$
 $\alpha = 23.5^\circ$, $M_\infty = 0.401$
 $R_{mac} = 6.0 \times 10^6$

Surface Pressures Near Leading Edge

● / ◆ upper, starboard/port
 ○ / ◇ lower, starboard/port

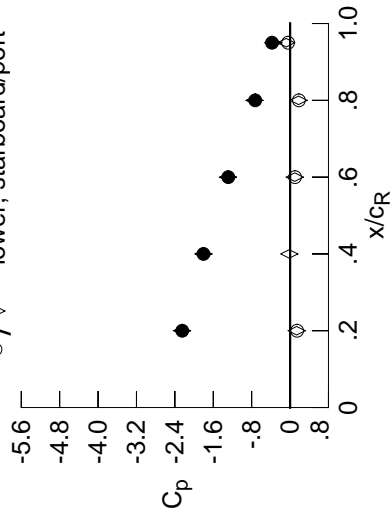

x/c_R	η	starb'd	port	starb'd	port
		$C_{p,u}$	$C_{p,l}$	$C_{p,u}$	$C_{p,l}$
0.20	0.90	-2.2463	-2.2501	0.1372	0.1466
0.40	0.95	-1.8039	-1.8046	-0.0168	*****
0.60	0.95	-1.2875	-1.2944	0.0968	0.1034
0.80	0.95	-0.7264	-0.7419	0.1768	0.1843
0.95	0.95	-0.3764	-0.3509	-0.0812	-0.0417

Table D1. Continued.

η	$x/c_R = .2$		$x/c_R = .4$		$x/c_R = .6$		$x/c_R = .8$		$x/c_R = .95$	
	$C_{p,u}$	$C_{p,l}$	$C_{p,u}$	$C_{p,l}$	$C_{p,u}$	$C_{p,l}$	$C_{p,u}$	$C_{p,l}$	$C_{p,u}$	$C_{p,l}$
0.050	-0.6853	-0.5506	-0.2307	*****	*****	*****	*****	*****	*****	*****
0.100	-0.6904	-0.5524	-0.2505	*****	*****	*****	*****	*****	*****	*****
0.150	-0.7158	-0.5617	-0.2714	*****	*****	*****	*****	*****	*****	*****
0.200	-0.7213	-0.5648	-0.3041	*****	*****	*****	*****	*****	*****	*****
0.250	*****	-0.5818	-0.3282	-0.3371	-0.3274	*****	*****	*****	*****	*****
0.300	-0.7132	-0.5887	-0.3840	-0.3420	-0.3392	*****	*****	*****	*****	*****
0.350	-0.7210	-0.6226	-0.4346	-0.3819	-0.3553	*****	*****	*****	*****	*****
0.400	-0.7227	-0.6897	-0.5205	-0.4603	-0.4089	*****	*****	*****	*****	*****
0.450	-0.7750	-0.8191	-0.6781	-0.5994	-0.5113	*****	*****	*****	*****	*****
0.500	-0.9435	-1.0528	-0.9570	-0.8553	-0.6455	*****	*****	*****	*****	*****
0.525	*****	-1.2523	-1.1536	-1.0003	-0.7375	*****	*****	*****	*****	*****
0.550	-1.4208	-1.4945	-1.3860	-1.1810	-0.7913	*****	*****	*****	*****	*****
0.575	*****	-1.7866	-1.6203	-1.3515	-0.8311	*****	*****	*****	*****	*****
0.600	-2.3320	-2.1134	-1.9157	-1.4854	-0.8329	*****	*****	*****	*****	*****
0.625	*****	*****	-2.1060	-1.5798	-0.8008	*****	*****	*****	*****	*****
0.650	-3.5297	-2.8210	-2.2547	-1.5567	-0.6907	*****	*****	*****	*****	*****
0.675	*****	-2.9893	-2.2343	-1.4367	-0.5294	*****	*****	*****	*****	*****
0.700	-3.7583	-2.9469	-2.0624	-1.2074	-0.4425	*****	*****	*****	*****	*****
0.725	*****	-2.6008	*****	-0.9312	-0.4482	*****	*****	*****	*****	*****
0.750	-2.8976	-2.1568	*****	-0.8198	-0.4937	*****	*****	*****	*****	*****
0.775	*****	-2.0155	-1.4429	-0.8108	-0.4866	*****	*****	*****	*****	*****
0.800	-2.4295	-2.0154	-1.4276	-0.7901	*****	*****	*****	*****	*****	*****
0.825	*****	-2.0103	-1.4076	-0.7819	-0.4905	*****	*****	*****	*****	*****
0.850	-2.3975	-2.0309	-1.4164	-0.7772	-0.4730	*****	*****	*****	*****	*****
0.875	*****	-2.0322	-1.4006	-0.7703	-0.4789	*****	*****	*****	*****	*****
0.900	-2.3530	-1.9824	-1.4132	-0.7589	*****	*****	*****	*****	*****	*****
0.925	*****	-1.9053	-1.3702	-0.7488	-0.4345	*****	*****	*****	*****	*****
0.950	-2.3044	-1.8726	-1.3274	-0.7334	-0.4169	*****	*****	*****	*****	*****
0.975	*****	-1.8705	-1.3140	-0.7135	-0.4098	*****	*****	*****	*****	*****

η	$x/c_R = .2$		$x/c_R = .4$		$x/c_R = .6$		$x/c_R = .8$		$x/c_R = .95$	
	$C_{p,u}$	$C_{p,l}$	$C_{p,u}$	$C_{p,l}$	$C_{p,u}$	$C_{p,l}$	$C_{p,u}$	$C_{p,l}$	$C_{p,u}$	$C_{p,l}$
-0.200	0.5416	0.4728	0.4307	*****	*****	*****	*****	*****	*****	*****
-0.400	0.5369	0.4771	0.4114	0.2064	-0.3633	*****	*****	*****	*****	*****
-0.600	*****	0.4779	0.4106	0.2445	-0.4760	*****	*****	*****	*****	*****
-0.700	*****	0.4704	0.4165	0.2538	-0.4789	*****	*****	*****	*****	*****
-0.800	0.3791	0.4089	0.3890	0.2769	-0.4268	*****	*****	*****	*****	*****
-0.850	0.2806	0.3186	0.3632	0.2818	-0.3853	*****	*****	*****	*****	*****
-0.900	0.1247	0.2300	0.2922	0.2591	-0.3177	*****	*****	*****	*****	*****
-0.950	*****	*****	0.0844	0.1751	-0.0355	*****	*****	*****	*****	*****
-0.975	*****	-0.3279	-0.1479	0.0315	0.0146	*****	*****	*****	*****	*****

Sharp Radius L.E.
 Run No. = 84 , Point No. = 1840
 $C_N = 1.172$, $C_m = -0.1558$
 $\alpha = 24.5^\circ$, $M_\infty = 0.401$
 $R_{mac} = 6.0 \times 10^6$

Surface Pressures Near Leading Edge

● / ◆ upper, starboard/port
 ○ / ◇ lower, starboard/port

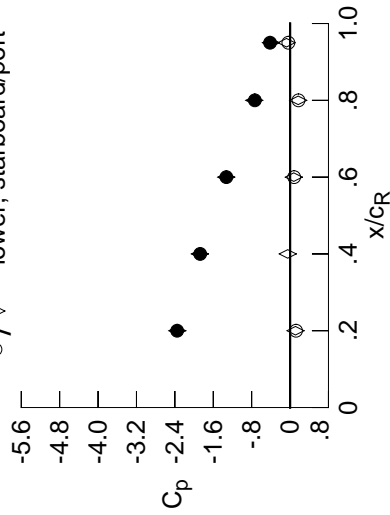

x/c_R	η	starb'd	port	starb'd	port
		$C_{p,u}$	$C_{p,l}$	$C_{p,u}$	$C_{p,l}$
0.20	0.90	-2.3530	-2.3496	0.1130	0.1247
0.40	0.95	-1.8726	-1.8788	-0.0491	*****
0.60	0.95	-1.3274	-1.3307	0.0778	0.0844
0.80	0.95	-0.7334	-0.7461	0.1696	0.1751
0.95	0.95	-0.4169	-0.3984	-0.0754	-0.0355

Table D1. Continued.

η	$x/c_R = .2$		$x/c_R = .4$		$x/c_R = .6$		$x/c_R = .8$		$x/c_R = .95$	
	$C_{p,u}$	$C_{p,l}$	$C_{p,u}$	$C_{p,l}$	$C_{p,u}$	$C_{p,l}$	$C_{p,u}$	$C_{p,l}$	$C_{p,u}$	$C_{p,l}$
0.050	-0.7232	-0.5728	-0.2367	*****	*****	*****	*****	*****	*****	*****
0.100	-0.7275	-0.5759	-0.2588	*****	*****	*****	*****	*****	*****	*****
0.150	-0.7535	-0.5852	-0.2826	*****	*****	*****	*****	*****	*****	*****
0.200	-0.7656	-0.5941	-0.3174	*****	*****	*****	*****	*****	*****	*****
0.250	*****	-0.6144	-0.3455	-0.3665	-0.3398	*****	*****	*****	*****	*****
0.300	-0.7530	-0.6288	-0.4166	-0.3723	-0.3630	*****	*****	*****	*****	*****
0.350	-0.7644	-0.6686	-0.4763	-0.4253	-0.3843	*****	*****	*****	*****	*****
0.400	-0.7773	-0.7589	-0.5778	-0.5129	-0.4354	*****	*****	*****	*****	*****
0.450	-0.8594	-0.9131	-0.7525	-0.6745	-0.5392	*****	*****	*****	*****	*****
0.500	-1.0964	-1.1905	-1.0651	-0.9325	-0.6678	*****	*****	*****	*****	*****
0.525	*****	-1.4106	-1.2691	-1.0810	-0.7558	*****	*****	*****	*****	*****
0.550	-1.6738	-1.6680	-1.5088	-1.2511	-0.7968	*****	*****	*****	*****	*****
0.575	*****	-1.9673	-1.7360	-1.4038	-0.8321	*****	*****	*****	*****	*****
0.600	-2.6545	-2.2938	-2.0162	-1.5160	-0.8222	*****	*****	*****	*****	*****
0.625	*****	*****	-2.1834	-1.5805	-0.7896	*****	*****	*****	*****	*****
0.650	-3.9237	-2.9501	-2.2983	-1.5295	-0.6820	*****	*****	*****	*****	*****
0.675	*****	-3.0557	-2.2427	-1.3878	-0.5358	*****	*****	*****	*****	*****
0.700	-3.7684	-2.9465	-2.0565	-1.1548	-0.4617	*****	*****	*****	*****	*****
0.725	*****	-2.5700	*****	-0.8953	-0.4647	*****	*****	*****	*****	*****
0.750	-2.8455	-2.1668	*****	-0.8253	-0.5168	*****	*****	*****	*****	*****
0.775	*****	-2.0626	-1.4633	-0.8195	-0.5104	*****	*****	*****	*****	*****
0.800	-2.4813	-2.0675	-1.4482	-0.8040	*****	*****	*****	*****	*****	*****
0.825	*****	-2.0660	-1.4245	-0.7907	-0.5233	*****	*****	*****	*****	*****
0.850	-2.5087	-2.0847	-1.4343	-0.7872	-0.5066	*****	*****	*****	*****	*****
0.875	*****	-2.0884	-1.4127	-0.7759	-0.5115	*****	*****	*****	*****	*****
0.900	-2.4358	-2.0365	-1.4305	-0.7595	*****	*****	*****	*****	*****	*****
0.925	*****	-1.9570	-1.3945	-0.7502	-0.4674	*****	*****	*****	*****	*****
0.950	-2.3751	-1.9215	-1.3430	-0.7358	-0.4628	*****	*****	*****	*****	*****
0.975	*****	-1.9204	-1.3333	-0.7139	-0.4586	*****	*****	*****	*****	*****
-0.200	$C_{p,l}$	0.5680	0.5004	0.4493	*****	*****	*****	*****	*****	*****
-0.400	$C_{p,l}$	0.5637	0.5003	0.4339	0.2170	-0.3913	*****	*****	*****	*****
-0.600	$C_{p,l}$	*****	0.4979	0.4276	0.2540	-0.4893	*****	*****	*****	*****
-0.700	$C_{p,l}$	*****	0.4876	0.4353	0.2615	-0.4860	*****	*****	*****	*****
-0.800	$C_{p,l}$	0.3822	0.4189	0.4058	0.2842	-0.4242	*****	*****	*****	*****
-0.850	$C_{p,l}$	0.2745	0.3219	0.3765	0.2885	-0.3786	*****	*****	*****	*****
-0.900	$C_{p,l}$	0.1083	0.2228	0.3011	0.2641	-0.3096	*****	*****	*****	*****
-0.950	$C_{p,l}$	*****	*****	0.0904	0.1780	-0.0269	*****	*****	*****	*****
-0.975	$C_{p,l}$	*****	-0.3593	-0.1409	0.0311	0.0200	*****	*****	*****	*****

Sharp Radius L.E.
 Run No. = 84, Point No. = 1841
 $C_N = 1.211$, $C_m = -0.1588$
 $\alpha = 25.5^\circ$, $M_\infty = 0.401$
 $R_{mac} = 6.0 \times 10^6$

Surface Pressures Near Leading Edge

● / ◆ upper, starboard/port
 ○ / ◇ lower, starboard/port

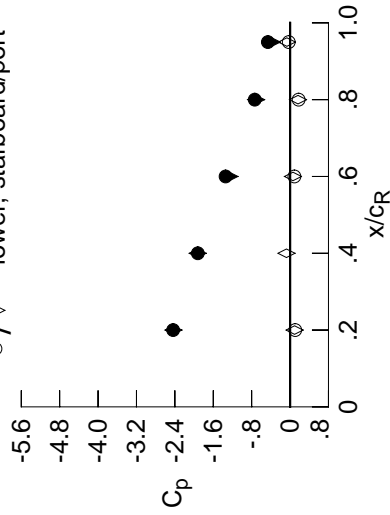

x/cR	η	$C_{p,u}$ starb'd	$C_{p,u}$ port	$C_{p,l}$ starb'd	$C_{p,l}$ port
0.20	0.90	-2.4358	-2.4301	0.0933	0.1083
0.40	0.95	-1.9215	-1.9259	-0.0755	*****
0.60	0.95	-1.3430	-1.2633	0.0603	0.0904
0.80	0.95	-0.7358	-0.7076	0.1658	0.1780
0.95	0.95	-0.4628	-0.3796	-0.0667	-0.0269

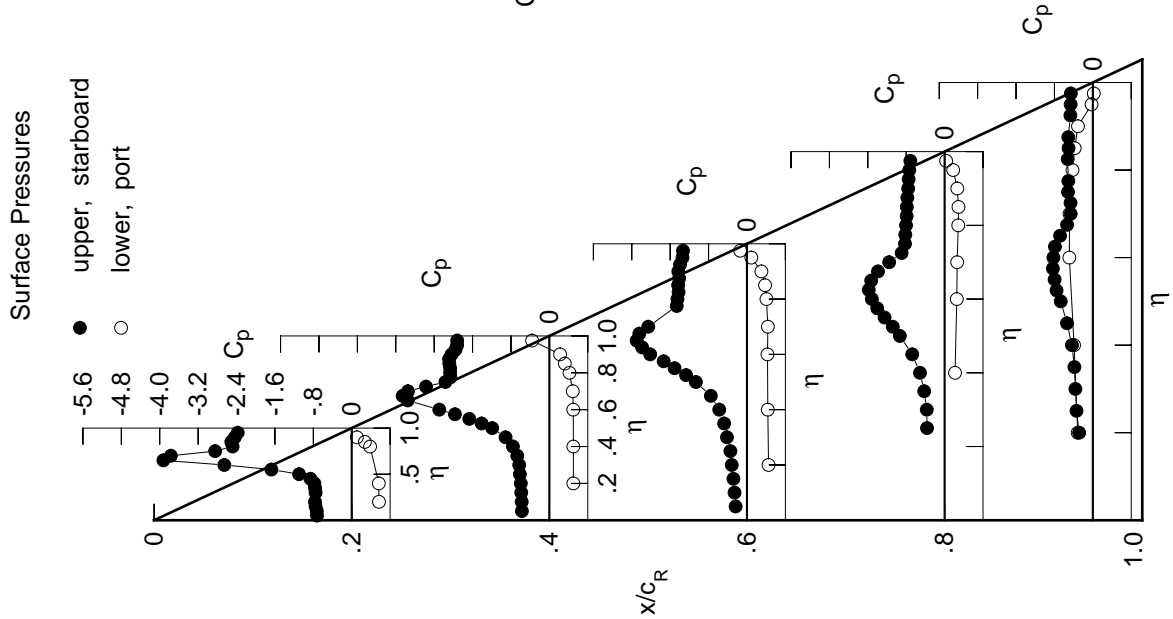

Table D1. Continued.

η	$x/c_R = .2$		$x/c_R = .4$		$x/c_R = .6$		$x/c_R = .8$		$x/c_R = .95$	
	$C_{p,u}$	$C_{p,u}$	$C_{p,u}$	$C_{p,u}$	$C_{p,u}$	$C_{p,u}$	$C_{p,u}$	$C_{p,u}$	$C_{p,u}$	$C_{p,u}$
0.050	-0.7679	-0.5973	-0.2437	*****	*****	*****	*****	*****	*****	*****
0.100	-0.7742	-0.6002	-0.2623	*****	*****	*****	*****	*****	*****	*****
0.150	-0.8006	-0.6133	-0.2851	*****	*****	*****	*****	*****	*****	*****
0.200	-0.8086	-0.6177	-0.3272	*****	*****	*****	*****	*****	*****	*****
0.250	*****	-0.6447	-0.3547	-0.3704	-0.3971	*****	*****	*****	*****	*****
0.300	-0.8025	-0.6637	-0.4333	-0.3796	-0.4282	*****	*****	*****	*****	*****
0.350	-0.8232	-0.7193	-0.5038	-0.4267	-0.4601	*****	*****	*****	*****	*****
0.400	-0.8488	-0.8221	-0.6251	-0.5028	-0.5128	*****	*****	*****	*****	*****
0.450	-0.9756	-1.0129	-0.8221	-0.6404	-0.6153	*****	*****	*****	*****	*****
0.500	-1.2859	-1.3264	-1.1563	-0.8525	-0.7132	*****	*****	*****	*****	*****
0.525	*****	-1.5683	-1.3697	-0.9629	-0.7833	*****	*****	*****	*****	*****
0.550	-1.9556	-1.8437	-1.6072	-1.0905	-0.8019	*****	*****	*****	*****	*****
0.575	*****	-2.1542	-1.8238	-1.1993	-0.8232	*****	*****	*****	*****	*****
0.600	-2.9647	-2.4697	-2.0767	-1.2797	-0.8136	*****	*****	*****	*****	*****
0.625	*****	*****	-2.1946	-1.3324	-0.7881	*****	*****	*****	*****	*****
0.650	-4.2128	-3.0593	-2.2559	-1.3192	-0.7145	*****	*****	*****	*****	*****
0.675	*****	-3.0924	-2.1528	-1.2624	-0.5936	*****	*****	*****	*****	*****
0.700	-3.5993	-2.9142	-1.9257	-1.1355	-0.5113	*****	*****	*****	*****	*****
0.725	*****	-2.5069	*****	-0.9713	-0.4687	*****	*****	*****	*****	*****
0.750	-2.7801	-2.1653	*****	-0.8202	-0.5124	*****	*****	*****	*****	*****
0.775	*****	-2.1040	-1.3916	-0.7880	-0.5307	*****	*****	*****	*****	*****
0.800	-2.5540	-2.1047	-1.3724	-0.7694	*****	*****	*****	*****	*****	*****
0.825	*****	-2.1035	-1.3447	-0.7624	-0.5535	*****	*****	*****	*****	*****
0.850	-2.6359	-2.1267	-1.3534	-0.7517	-0.5360	*****	*****	*****	*****	*****
0.875	*****	-2.1321	-1.3288	-0.7485	-0.5351	*****	*****	*****	*****	*****
0.900	-2.5234	-2.0767	-1.3455	-0.7260	*****	*****	*****	*****	*****	*****
0.925	*****	-2.0019	-1.3164	-0.7225	-0.4728	*****	*****	*****	*****	*****
0.950	-2.4622	-1.9618	-1.2726	-0.7142	-0.4510	*****	*****	*****	*****	*****
0.975	*****	-1.9584	-1.2574	-0.6954	-0.4387	*****	*****	*****	*****	*****
-0.200	0.5923	0.5130	0.4662	*****	-0.3272	*****	*****	*****	*****	*****
-0.400	0.5849	0.5207	0.4442	0.2289	-0.4024	*****	*****	*****	*****	*****
-0.600	*****	0.5105	0.4421	0.2663	-0.4885	*****	*****	*****	*****	*****
-0.700	*****	0.4999	0.4461	0.2696	-0.4834	*****	*****	*****	*****	*****
-0.800	0.3771	0.4234	0.4135	0.2915	-0.4138	*****	*****	*****	*****	*****
-0.850	0.2619	0.3205	0.3805	0.2943	-0.3652	*****	*****	*****	*****	*****
-0.900	0.0847	0.2084	0.2978	0.2642	-0.2931	*****	*****	*****	*****	*****
-0.950	*****	*****	0.0785	0.1645	-0.0174	*****	*****	*****	*****	*****
-0.975	*****	-0.3927	-0.1519	0.0079	0.0239	*****	*****	*****	*****	*****

Sharp Radius L.E.

Run No. = 84 , Point No. = 1842

$C_N = 1.250$, $C_m = -0.1649$

$\alpha = 26.5^\circ$, $M_\infty = 0.401$

$R_{mac} = 6.0 \times 10^6$

Surface Pressures Near Leading Edge

● / ◆ upper, starboard/port
○ / ◇ lower, starboard/port

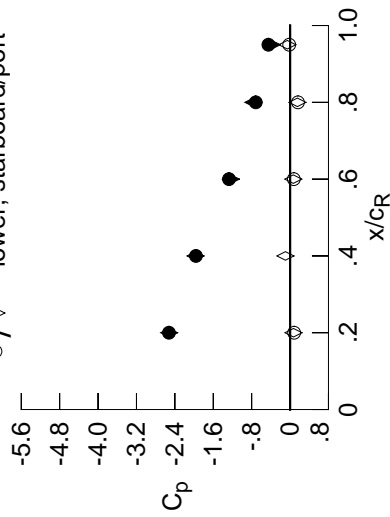

x/c_R	η	starb'd	port	starb'd	port
		$C_{p,u}$	$C_{p,l}$	$C_{p,u}$	$C_{p,l}$
0.20	0.90	-2.5234	-2.5185	0.0709	0.0847
0.40	0.95	-1.9618	-1.9701	-0.0967	*****
0.60	0.95	-1.2726	-1.2330	0.0664	0.0785
0.80	0.95	-0.7142	-0.7652	0.1550	0.1645
0.95	0.95	-0.4510	-0.3796	-0.0576	-0.0174

Table D1. Concluded.

η	$x/c_R = .2$		$x/c_R = .4$		$x/c_R = .6$		$x/c_R = .8$		$x/c_R = .95$	
	$C_{p,u}$	$C_{p,l}$	$C_{p,u}$	$C_{p,l}$	$C_{p,u}$	$C_{p,l}$	$C_{p,u}$	$C_{p,l}$	$C_{p,u}$	$C_{p,l}$
0.050	-0.0235	-0.0083	0.0948	*****	*****	*****	*****	*****	*****	*****
0.100	-0.0118	-0.0021	0.0753	*****	*****	*****	*****	*****	*****	*****
0.150	-0.0129	-0.0054	0.0630	*****	*****	*****	*****	*****	*****	*****
0.200	-0.0176	-0.0076	0.0495	*****	*****	*****	*****	*****	*****	*****
0.250	*****	-0.0073	0.0329	-0.0903	-0.2697	*****	*****	*****	*****	*****
0.300	-0.0522	-0.0102	0.0339	-0.0844	-0.2772	*****	*****	*****	*****	*****
0.350	-0.0551	-0.0167	0.0186	-0.0691	-0.2826	*****	*****	*****	*****	*****
0.400	-0.0644	-0.0168	0.0125	-0.0681	-0.2963	*****	*****	*****	*****	*****
0.450	-0.0733	-0.0146	0.0135	-0.0753	-0.2958	*****	*****	*****	*****	*****
0.500	-0.0770	-0.0196	0.0005	-0.0654	-0.3047	*****	*****	*****	*****	*****
0.525	*****	-0.0219	-0.0063	-0.0732	-0.3012	*****	*****	*****	*****	*****
0.550	-0.0791	-0.0244	-0.0090	-0.0781	-0.3046	*****	*****	*****	*****	*****
0.575	*****	-0.0285	-0.0060	-0.0774	-0.3106	*****	*****	*****	*****	*****
0.600	-0.0641	-0.0280	-0.0149	-0.0696	-0.3203	*****	*****	*****	*****	*****
0.625	*****	*****	-0.0126	-0.0685	-0.3261	*****	*****	*****	*****	*****
0.650	-0.0466	-0.0297	-0.0175	-0.0733	-0.3192	*****	*****	*****	*****	*****
0.675	*****	-0.0562	-0.0205	-0.0718	-0.3283	*****	*****	*****	*****	*****
0.700	-0.0412	-0.0626	-0.0226	-0.0773	-0.3311	*****	*****	*****	*****	*****
0.725	*****	-0.0747	*****	-0.0739	-0.3427	*****	*****	*****	*****	*****
0.750	-0.0371	-0.0831	*****	-0.0864	-0.3438	*****	*****	*****	*****	*****
0.775	*****	-0.0874	-0.0548	-0.0820	-0.3570	*****	*****	*****	*****	*****
0.800	-0.0203	-0.0821	-0.0644	-0.0891	*****	*****	*****	*****	*****	*****
0.825	*****	-0.0814	-0.0881	-0.0932	-0.3976	*****	*****	*****	*****	*****
0.850	0.0009	-0.0637	-0.0920	-0.1204	-0.3726	*****	*****	*****	*****	*****
0.875	*****	-0.0524	-0.0795	-0.1345	-0.4572	*****	*****	*****	*****	*****
0.900	0.0359	-0.0249	-0.0705	-0.1418	*****	*****	*****	*****	*****	*****
0.925	*****	-0.0023	-0.0454	-0.1202	-0.8832	*****	*****	*****	*****	*****
0.950	0.0878	0.0348	-0.0146	-0.0759	-0.4208	*****	*****	*****	*****	*****
0.975	*****	0.0897	0.0495	-0.0065	-0.1906	*****	*****	*****	*****	*****
-0.200	-0.0429	-0.0057	0.0486	*****	-0.2670	*****	*****	*****	*****	*****
-0.400	-0.0626	-0.0072	0.0079	-0.0697	-0.2948	*****	*****	*****	*****	*****
-0.600	*****	-0.0222	-0.0136	-0.0833	-0.3142	*****	*****	*****	*****	*****
-0.700	*****	-0.0675	-0.0342	-0.0743	-0.3424	*****	*****	*****	*****	*****
-0.800	-0.0411	-0.0928	-0.0757	-0.0888	-0.3776	*****	*****	*****	*****	*****
-0.850	-0.0070	-0.0781	-0.0946	-0.1321	-0.4532	*****	*****	*****	*****	*****
-0.900	0.0297	-0.0507	-0.1002	-0.1482	-0.6903	*****	*****	*****	*****	*****
-0.950	*****	*****	-0.0290	-0.1084	-0.4436	*****	*****	*****	*****	*****
-0.975	*****	0.0721	0.0246	-0.0330	-0.2134	*****	*****	*****	*****	*****

Sharp Radius L.E.
 Run No. = 84 , Point No. = 1843
 $C_N = -0.012$, $C_m = -0.0024$
 $\alpha = 0.1^\circ$, $M_\infty = 0.401$
 $R_{mac} = 6.0 \times 10^6$

Surface Pressures Near Leading Edge

● / ◆ upper, starboard/port
 ○ / ◇ lower, starboard/port

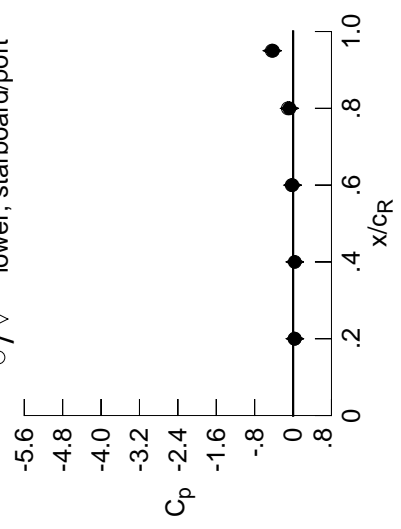

x/c_R	η	starb'd	port	starb'd	port
		$C_{p,u}$	$C_{p,l}$	$C_{p,u}$	$C_{p,l}$
0.20	0.90	0.0359	0.0420	0.0351	0.0297
0.40	0.95	0.0348	0.0380	0.0351	*****
0.60	0.95	-0.0146	-0.0077	-0.0137	-0.0290
0.80	0.95	-0.0759	-0.0651	-0.0851	-0.1084
0.95	0.95	-0.4208	-0.4228	-0.4475	-0.4436

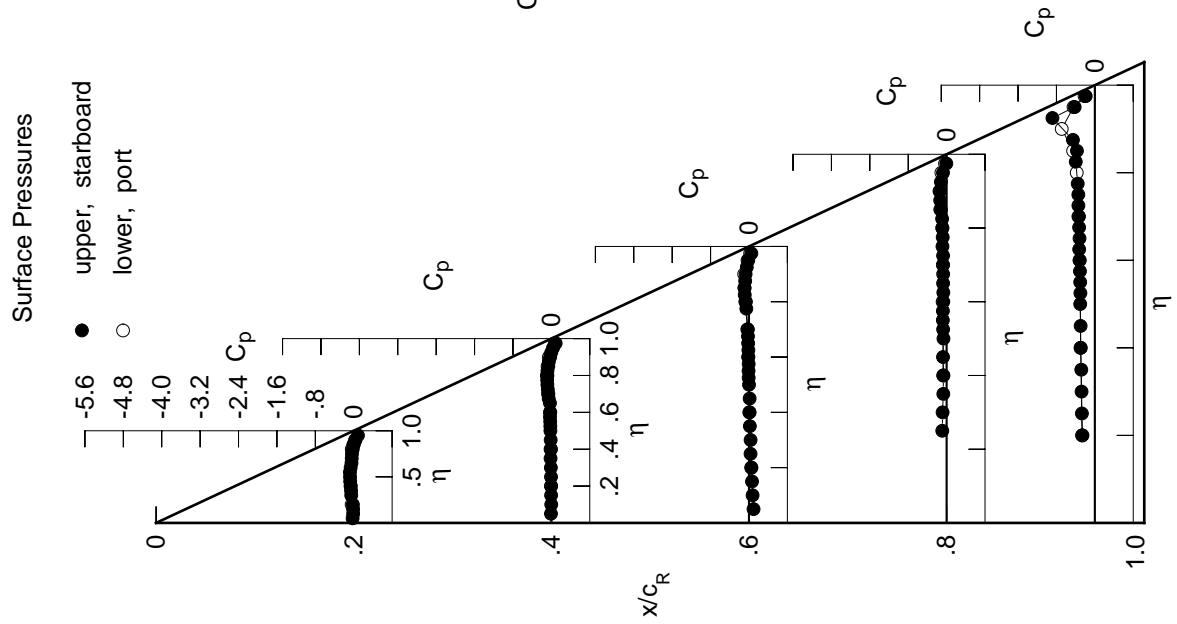

Table D2. Tabulations and Plots of Surface Pressure Coefficients.

η	$x/c_R = .2$		$x/c_R = .4$		$x/c_R = .6$		$x/c_R = .8$		$x/c_R = .95$	
	$C_{p,u}$	$C_{p,l}$	$C_{p,u}$	$C_{p,l}$	$C_{p,u}$	$C_{p,l}$	$C_{p,u}$	$C_{p,l}$	$C_{p,u}$	$C_{p,l}$
0.050	-0.0094	0.0027	0.1033	*****	*****	*****	*****	*****	*****	*****
0.100	-0.0025	0.0057	0.0892	*****	*****	*****	*****	*****	*****	*****
0.150	-0.0070	0.0023	0.0765	*****	*****	*****	*****	*****	*****	*****
0.200	-0.0100	0.0024	0.0623	*****	*****	*****	*****	*****	*****	*****
0.250	*****	-0.0005	0.0498	-0.1006	-0.2877	*****	*****	*****	*****	*****
0.300	-0.0387	-0.0005	0.0432	-0.0875	-0.3076	*****	*****	*****	*****	*****
0.350	-0.0441	-0.0048	0.0309	-0.0785	-0.3165	*****	*****	*****	*****	*****
0.400	-0.0495	-0.0062	0.0253	-0.0742	-0.3243	*****	*****	*****	*****	*****
0.450	-0.0613	-0.0112	0.0246	-0.0742	-0.3306	*****	*****	*****	*****	*****
0.500	-0.0645	-0.0086	0.0115	-0.0712	-0.3372	*****	*****	*****	*****	*****
0.525	*****	-0.0125	0.0091	-0.0721	-0.3365	*****	*****	*****	*****	*****
0.550	-0.0685	-0.0121	0.0042	-0.0723	-0.3439	*****	*****	*****	*****	*****
0.575	*****	-0.0177	0.0065	-0.0716	-0.3482	*****	*****	*****	*****	*****
0.600	-0.0474	-0.0181	-0.0019	-0.0689	-0.3555	*****	*****	*****	*****	*****
0.625	*****	*****	-0.0004	-0.0660	-0.3561	*****	*****	*****	*****	*****
0.650	-0.0421	-0.0228	-0.0081	-0.0676	-0.3529	*****	*****	*****	*****	*****
0.675	*****	-0.0337	-0.0095	-0.0701	-0.3542	*****	*****	*****	*****	*****
0.700	-0.0335	-0.0436	-0.0081	-0.0745	-0.3559	*****	*****	*****	*****	*****
0.725	*****	-0.0562	*****	-0.0716	-0.3630	*****	*****	*****	*****	*****
0.750	-0.0194	-0.0704	*****	-0.0745	-0.3674	*****	*****	*****	*****	*****
0.775	*****	-0.0736	-0.0342	-0.0783	-0.3718	*****	*****	*****	*****	*****
0.800	-0.0008	-0.0710	-0.0489	-0.0850	*****	*****	*****	*****	*****	*****
0.825	*****	-0.0670	-0.0604	-0.0860	-0.4241	*****	*****	*****	*****	*****
0.850	0.0270	-0.0516	-0.0716	-0.1057	-0.3697	*****	*****	*****	*****	*****
0.875	*****	-0.0373	-0.0619	-0.1213	-0.4979	*****	*****	*****	*****	*****
0.900	0.0659	-0.0109	-0.0500	-0.1243	*****	*****	*****	*****	*****	*****
0.925	*****	0.0183	-0.0257	-0.0975	-0.8973	*****	*****	*****	*****	*****
0.950	0.1117	0.0576	0.0144	-0.0550	-0.3872	*****	*****	*****	*****	*****
0.975	*****	0.1085	0.0786	0.0186	-0.1528	*****	*****	*****	*****	*****

η	$x/c_R = .2$		$x/c_R = .4$		$x/c_R = .6$		$x/c_R = .8$		$x/c_R = .95$	
	$C_{p,u}$	$C_{p,l}$	$C_{p,u}$	$C_{p,l}$	$C_{p,u}$	$C_{p,l}$	$C_{p,u}$	$C_{p,l}$	$C_{p,u}$	$C_{p,l}$
-0.200	-0.0545	-0.0148	0.0520	*****	*****	*****	*****	*****	*****	*****
-0.400	-0.0779	-0.0167	0.0098	-0.0897	-0.3222	*****	*****	*****	*****	*****
-0.600	*****	-0.0316	-0.0217	-0.0879	-0.3471	*****	*****	*****	*****	*****
-0.700	*****	-0.0776	-0.0344	-0.0904	-0.3931	*****	*****	*****	*****	*****
-0.800	-0.0518	-0.1148	-0.0925	-0.0965	-0.4352	*****	*****	*****	*****	*****
-0.850	-0.0206	-0.0959	-0.1160	-0.1498	-0.5163	*****	*****	*****	*****	*****
-0.900	0.0166	-0.0702	-0.1181	-0.1757	-0.7794	*****	*****	*****	*****	*****
-0.950	*****	*****	-0.0521	-0.1320	-0.4124	*****	*****	*****	*****	*****
-0.975	*****	0.0479	0.0040	-0.0598	-0.2027	*****	*****	*****	*****	*****

Sharp Radius L.E.
 Run No. = 85 , Point No. = 1844
 $C_N = -0.036$, $C_m = 0.0082$
 $\alpha = -0.4^\circ$, $M_\infty = 0.599$
 $R_{mac} = 6.0 \times 10^6$

Surface Pressures Near Leading Edge

● / ◆ upper, starboard/port
 ○ / ◇ lower, starboard/port

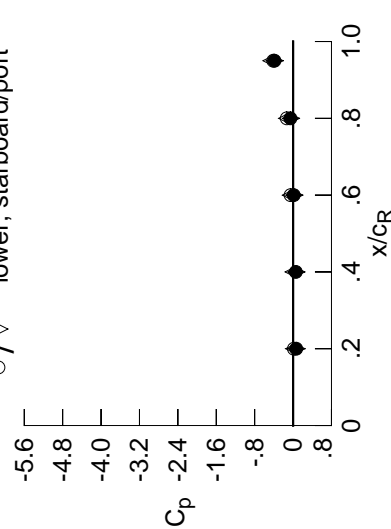

x/c_R	η	starb'd	port	starb'd	port
x/c_R	η	$C_{p,u}$	$C_{p,l}$	$C_{p,u}$	$C_{p,l}$
0.20	0.90	0.0659	0.0708	0.0216	0.0166
0.40	0.95	0.0576	0.0673	0.0113	*****
0.60	0.95	0.0144	0.0252	-0.0445	-0.0521
0.80	0.95	-0.0550	-0.0432	-0.1233	-0.1320
0.95	0.95	-0.3872	-0.3839	-0.4508	-0.4124

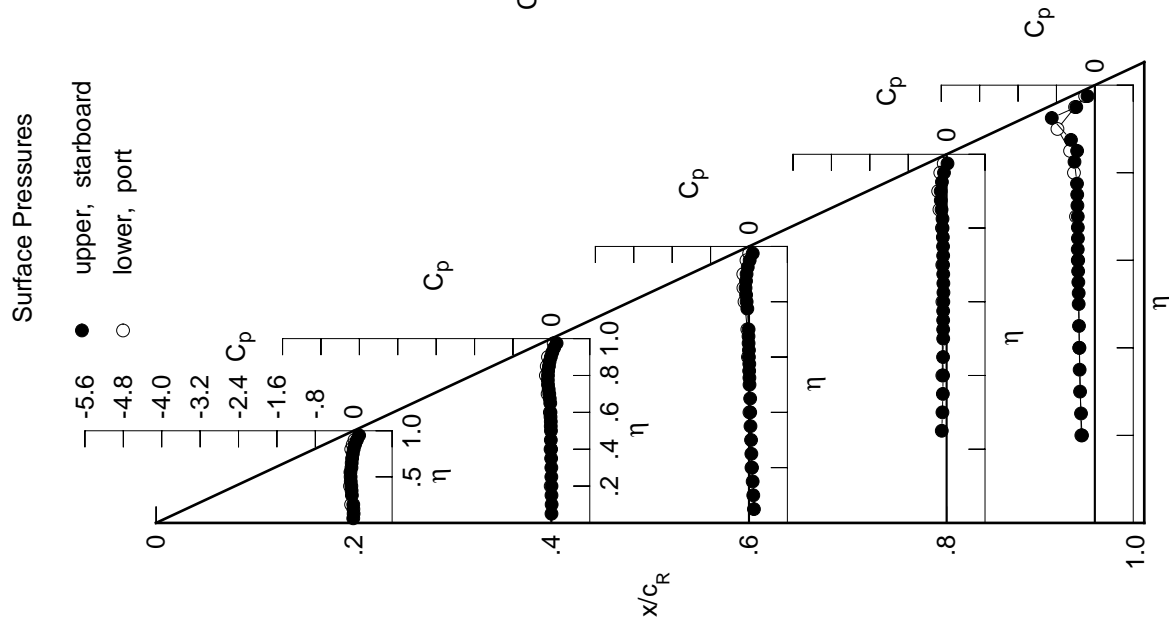

Table D2. Continued.

η	$x/c_R = .2$		$x/c_R = .4$		$x/c_R = .6$		$x/c_R = .8$		$x/c_R = .95$	
	$C_{p,u}$	$C_{p,l}$	$C_{p,u}$	$C_{p,l}$	$C_{p,u}$	$C_{p,l}$	$C_{p,u}$	$C_{p,l}$	$C_{p,u}$	$C_{p,l}$
0.050	-0.0122	-0.0055	0.1001	*****	*****	*****	*****	*****	*****	*****
0.100	-0.0101	-0.0017	0.0872	*****	*****	*****	*****	*****	*****	*****
0.150	-0.0183	-0.0057	0.0716	*****	*****	*****	*****	*****	*****	*****
0.200	-0.0188	-0.0047	0.0572	*****	*****	*****	*****	*****	*****	*****
0.250	*****	-0.0076	0.0444	-0.1031	-0.2864	*****	*****	*****	*****	*****
0.300	-0.0478	-0.0071	0.0377	-0.0896	-0.3043	*****	*****	*****	*****	*****
0.350	-0.0529	-0.0133	0.0271	-0.0824	-0.3118	*****	*****	*****	*****	*****
0.400	-0.0592	-0.0149	0.0214	-0.0781	-0.3216	*****	*****	*****	*****	*****
0.450	-0.0708	-0.0176	0.0184	-0.0784	-0.3278	*****	*****	*****	*****	*****
0.500	-0.0757	-0.0187	0.0053	-0.0753	-0.3342	*****	*****	*****	*****	*****
0.525	*****	-0.0203	0.0033	-0.0775	-0.3351	*****	*****	*****	*****	*****
0.550	-0.0783	-0.0210	-0.0027	-0.0783	-0.3428	*****	*****	*****	*****	*****
0.575	*****	-0.0224	-0.0016	-0.0758	-0.3463	*****	*****	*****	*****	*****
0.600	-0.0617	-0.0253	-0.0097	-0.0753	-0.3556	*****	*****	*****	*****	*****
0.625	*****	*****	-0.0083	-0.0707	-0.3593	*****	*****	*****	*****	*****
0.650	-0.0554	-0.0304	-0.0175	-0.0736	-0.3580	*****	*****	*****	*****	*****
0.675	*****	-0.0567	-0.0176	-0.0792	-0.3601	*****	*****	*****	*****	*****
0.700	-0.0472	-0.0638	-0.0167	-0.0797	-0.3708	*****	*****	*****	*****	*****
0.725	*****	-0.0756	*****	-0.0764	-0.3773	*****	*****	*****	*****	*****
0.750	-0.0354	-0.0861	*****	-0.0808	-0.3915	*****	*****	*****	*****	*****
0.775	*****	-0.0911	-0.0460	-0.0851	-0.3967	*****	*****	*****	*****	*****
0.800	-0.0175	-0.0913	-0.0691	-0.0934	*****	*****	*****	*****	*****	*****
0.825	*****	-0.0886	-0.0858	-0.0921	-0.4537	*****	*****	*****	*****	*****
0.850	0.0100	-0.0713	-0.0833	-0.1269	-0.4203	*****	*****	*****	*****	*****
0.875	*****	-0.0589	-0.0847	-0.1440	-0.5164	*****	*****	*****	*****	*****
0.900	0.0497	-0.0316	-0.0688	-0.1475	*****	*****	*****	*****	*****	*****
0.925	*****	-0.0007	-0.0514	-0.1214	-0.8713	*****	*****	*****	*****	*****
0.950	0.0954	0.0385	-0.0099	-0.0828	-0.3859	*****	*****	*****	*****	*****
0.975	*****	0.0863	0.0543	-0.0071	-0.1635	*****	*****	*****	*****	*****
-0.200	-0.0427	-0.0062	0.0547	*****	-0.2800	*****	*****	*****	*****	*****
-0.400	-0.0570	-0.0068	0.0177	-0.0855	-0.3212	*****	*****	*****	*****	*****
-0.600	*****	-0.0226	-0.0085	-0.0801	-0.3501	*****	*****	*****	*****	*****
-0.700	*****	-0.0645	-0.0249	-0.0833	-0.3839	*****	*****	*****	*****	*****
-0.800	-0.0335	-0.0945	-0.0776	-0.0880	-0.4296	*****	*****	*****	*****	*****
-0.850	-0.0009	-0.0758	-0.0951	-0.1343	-0.5080	*****	*****	*****	*****	*****
-0.900	0.0363	-0.0456	-0.0934	-0.1545	-0.7554	*****	*****	*****	*****	*****
-0.950	*****	*****	-0.0233	-0.1034	-0.3934	*****	*****	*****	*****	*****
-0.975	*****	0.0741	0.0332	-0.0296	-0.1792	*****	*****	*****	*****	*****

Sharp Radius L.E.
 Run No. = 85 , Point No. = 1845
 $C_N = -0.016$, $C_m = 0.0041$
 $\alpha = 0.1^\circ$, $M_\infty = 0.599$
 $R_{mac} = 6.0 \times 10^6$

Surface Pressures Near Leading Edge

● / ◆ upper, starboard/port
 ○ / ◇ lower, starboard/port

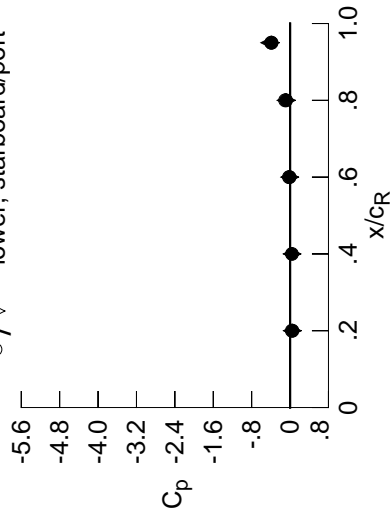

x/c_R	η	starb'd	port	starb'd	port
		$C_{p,u}$	$C_{p,l}$	$C_{p,u}$	$C_{p,l}$
0.20	0.90	0.0497	0.0532	0.0404	0.0363
0.40	0.95	0.0385	0.0455	0.0376	*****
0.60	0.95	-0.0099	-0.0007	-0.0140	-0.0233
0.80	0.95	-0.0828	-0.0684	-0.0922	-0.1034
0.95	0.95	-0.3859	-0.4060	-0.4316	-0.3934

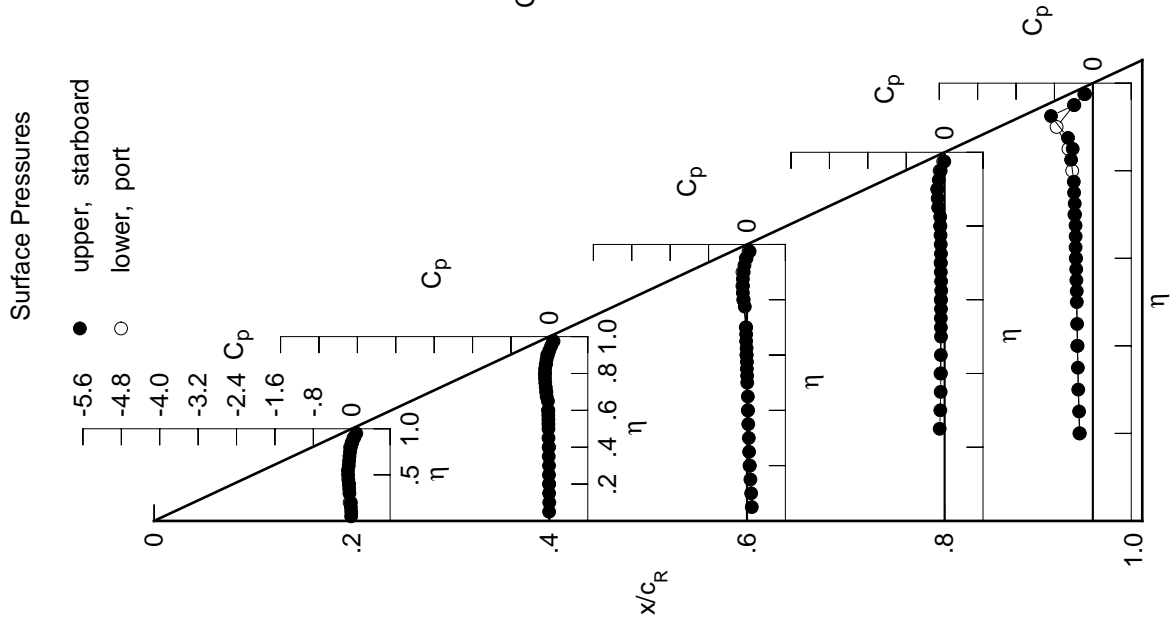

Table D2. Continued.

η	$x/c_R = .2$		$x/c_R = .4$		$x/c_R = .6$		$x/c_R = .8$		$x/c_R = .95$	
	$C_{p,u}$	$C_{p,l}$	$C_{p,u}$	$C_{p,l}$	$C_{p,u}$	$C_{p,l}$	$C_{p,u}$	$C_{p,l}$	$C_{p,u}$	$C_{p,l}$
0.050	-0.0357	-0.0201	0.0891	0.0891	0.0891	0.0891	0.0891	0.0891	0.0891	0.0891
0.100	-0.0315	-0.0171	0.0718	0.0718	0.0718	0.0718	0.0718	0.0718	0.0718	0.0718
0.150	-0.0378	-0.0214	0.0610	0.0610	0.0610	0.0610	0.0610	0.0610	0.0610	0.0610
0.200	-0.0432	-0.0218	0.0449	0.0449	0.0449	0.0449	0.0449	0.0449	0.0449	0.0449
0.250	*****	-0.0243	0.0311	-0.1131	-0.1131	-0.1131	-0.1131	-0.1131	-0.1131	-0.1131
0.300	-0.0723	-0.0266	0.0242	-0.1003	-0.1003	-0.1003	-0.1003	-0.1003	-0.1003	-0.1003
0.350	-0.0773	-0.0310	0.0114	-0.0903	-0.0903	-0.0903	-0.0903	-0.0903	-0.0903	-0.0903
0.400	-0.0827	-0.0345	0.0074	-0.0863	-0.0863	-0.0863	-0.0863	-0.0863	-0.0863	-0.0863
0.450	-0.0945	-0.0375	0.0015	-0.0870	-0.0870	-0.0870	-0.0870	-0.0870	-0.0870	-0.0870
0.500	-0.1013	-0.0401	-0.0096	-0.0867	-0.0867	-0.0867	-0.0867	-0.0867	-0.0867	-0.0867
0.525	*****	-0.0440	-0.0144	-0.0874	-0.0874	-0.0874	-0.0874	-0.0874	-0.0874	-0.0874
0.550	-0.1064	-0.0482	-0.0212	-0.0923	-0.0923	-0.0923	-0.0923	-0.0923	-0.0923	-0.0923
0.575	*****	-0.0506	-0.0213	-0.0882	-0.0882	-0.0882	-0.0882	-0.0882	-0.0882	-0.0882
0.600	-0.0953	-0.0543	-0.0294	-0.0881	-0.0881	-0.0881	-0.0881	-0.0881	-0.0881	-0.0881
0.625	*****	*****	-0.0295	-0.0875	-0.0875	-0.0875	-0.0875	-0.0875	-0.0875	-0.0875
0.650	-0.0896	-0.0607	-0.0399	-0.0897	-0.0897	-0.0897	-0.0897	-0.0897	-0.0897	-0.0897
0.675	*****	-0.0797	-0.0414	-0.0958	-0.0958	-0.0958	-0.0958	-0.0958	-0.0958	-0.0958
0.700	-0.0830	-0.0869	-0.0426	-0.0997	-0.0997	-0.0997	-0.0997	-0.0997	-0.0997	-0.0997
0.725	*****	-0.1060	*****	-0.0957	-0.0957	-0.0957	-0.0957	-0.0957	-0.0957	-0.0957
0.750	-0.0751	-0.1117	*****	-0.1041	-0.1041	-0.1041	-0.1041	-0.1041	-0.1041	-0.1041
0.775	*****	-0.1196	-0.0795	-0.1099	-0.1099	-0.1099	-0.1099	-0.1099	-0.1099	-0.1099
0.800	-0.0581	-0.1278	-0.0996	-0.1213	-0.1213	-0.1213	-0.1213	-0.1213	-0.1213	-0.1213
0.825	*****	-0.1228	-0.1166	-0.1233	-0.1233	-0.1233	-0.1233	-0.1233	-0.1233	-0.1233
0.850	-0.0310	-0.1118	-0.1312	-0.1570	-0.1570	-0.1570	-0.1570	-0.1570	-0.1570	-0.1570
0.875	*****	-0.1044	-0.1255	-0.1823	-0.1823	-0.1823	-0.1823	-0.1823	-0.1823	-0.1823
0.900	0.0070	-0.0792	-0.1166	-0.1941	-0.1941	-0.1941	-0.1941	-0.1941	-0.1941	-0.1941
0.925	*****	-0.0522	-0.1013	-0.1751	-0.1751	-0.1751	-0.1751	-0.1751	-0.1751	-0.1751
0.950	0.0517	-0.0143	-0.0664	-0.1436	-0.1436	-0.1436	-0.1436	-0.1436	-0.1436	-0.1436
0.975	*****	0.0294	-0.0029	-0.0734	-0.0734	-0.0734	-0.0734	-0.0734	-0.0734	-0.0734

η	$x/c_R = .2$		$x/c_R = .4$		$x/c_R = .6$		$x/c_R = .8$		$x/c_R = .95$	
	$C_{p,u}$	$C_{p,l}$	$C_{p,u}$	$C_{p,l}$	$C_{p,u}$	$C_{p,l}$	$C_{p,u}$	$C_{p,l}$	$C_{p,u}$	$C_{p,l}$
-0.200	-0.0173	0.0114	0.0673	0.0673	0.0673	0.0673	0.0673	0.0673	0.0673	0.0673
-0.400	-0.0324	0.0078	0.0292	-0.0777	-0.0777	-0.0777	-0.0777	-0.0777	-0.0777	-0.0777
-0.600	*****	-0.0041	0.0046	-0.0692	-0.0692	-0.0692	-0.0692	-0.0692	-0.0692	-0.0692
-0.700	*****	-0.0345	-0.0081	-0.0683	-0.0683	-0.0683	-0.0683	-0.0683	-0.0683	-0.0683
-0.800	0.0050	-0.0558	-0.0402	-0.0751	-0.0751	-0.0751	-0.0751	-0.0751	-0.0751	-0.0751
-0.850	0.0364	-0.0339	-0.0581	-0.0954	-0.0954	-0.0954	-0.0954	-0.0954	-0.0954	-0.0954
-0.900	0.0749	0.0022	-0.0445	-0.1085	-0.1085	-0.1085	-0.1085	-0.1085	-0.1085	-0.1085
-0.950	*****	*****	0.0299	-0.0456	-0.0456	-0.0456	-0.0456	-0.0456	-0.0456	-0.0456
-0.975	*****	0.1201	0.0874	0.0269	0.0269	0.0269	0.0269	0.0269	0.0269	0.0269

Sharp Radius L.E.
 Run No. = 85 , Point No. = 1846
 $C_N = 0.029$, $C_m = -0.0083$
 $\alpha = 1.1^\circ$, $M_\infty = 0.599$
 $R_{mac} = 6.0 \times 10^6$

Surface Pressures Near Leading Edge

● / ◆ upper, starboard/port
 ○ / ◇ lower, starboard/port

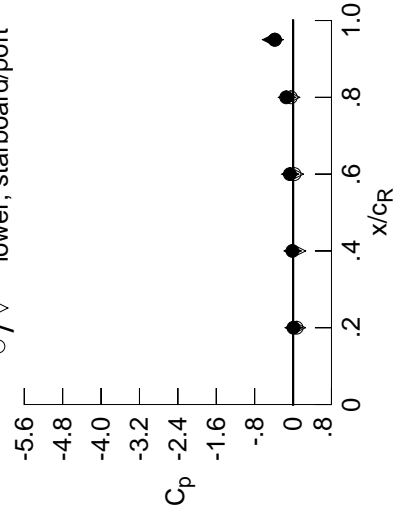

x/c_R	η	starb'd	port	starb'd	port
		$C_{p,u}$	$C_{p,l}$	$C_{p,u}$	$C_{p,l}$
0.20	0.90	0.0070	0.0110	0.0798	0.0749
0.40	0.95	-0.0143	-0.0093	0.0832	*****
0.60	0.95	-0.0664	-0.0607	0.0366	0.0299
0.80	0.95	-0.1436	-0.1287	-0.0389	-0.0456
0.95	0.95	-0.3856	-0.4586	-0.3852	-0.3749

Table D2. Continued.

η	$x/c_R = .2$		$x/c_R = .4$		$x/c_R = .6$		$x/c_R = .8$		$x/c_R = .95$	
	$C_{p,u}$	$C_{p,l}$	$C_{p,u}$	$C_{p,l}$	$C_{p,u}$	$C_{p,l}$	$C_{p,u}$	$C_{p,l}$	$C_{p,u}$	$C_{p,l}$
0.050	-0.0517	-0.0358	0.0776	0.0776	0.0776	0.0776	0.0776	0.0776	0.0776	0.0776
0.100	-0.0500	-0.0323	0.0603	0.0603	0.0603	0.0603	0.0603	0.0603	0.0603	0.0603
0.150	-0.0604	-0.0350	0.0537	0.0537	0.0537	0.0537	0.0537	0.0537	0.0537	0.0537
0.200	-0.0651	-0.0396	0.0353	0.0353	0.0353	0.0353	0.0353	0.0353	0.0353	0.0353
0.250	*****	-0.0433	0.0227	-0.1179	-0.2734	-0.2734	-0.2734	-0.2734	-0.2734	-0.2734
0.300	-0.0820	-0.0413	0.0139	-0.1030	-0.2887	-0.2887	-0.2887	-0.2887	-0.2887	-0.2887
0.350	-0.0892	-0.0487	0.0001	-0.0978	-0.2929	-0.2929	-0.2929	-0.2929	-0.2929	-0.2929
0.400	-0.0971	-0.0500	-0.0049	-0.0916	-0.2991	-0.2991	-0.2991	-0.2991	-0.2991	-0.2991
0.450	-0.1138	-0.0564	-0.0119	-0.0949	-0.3072	-0.3072	-0.3072	-0.3072	-0.3072	-0.3072
0.500	-0.1214	-0.0577	-0.0262	-0.0925	-0.3050	-0.3050	-0.3050	-0.3050	-0.3050	-0.3050
0.525	*****	-0.0646	-0.0310	-0.0974	-0.3026	-0.3026	-0.3026	-0.3026	-0.3026	-0.3026
0.550	-0.1298	-0.0651	-0.0369	-0.0990	-0.3061	-0.3061	-0.3061	-0.3061	-0.3061	-0.3061
0.575	*****	-0.0703	-0.0375	-0.0982	-0.3106	-0.3106	-0.3106	-0.3106	-0.3106	-0.3106
0.600	-0.1320	-0.0798	-0.0435	-0.0947	-0.3151	-0.3151	-0.3151	-0.3151	-0.3151	-0.3151
0.625	*****	*****	-0.0460	-0.0969	-0.3151	-0.3151	-0.3151	-0.3151	-0.3151	-0.3151
0.650	-0.1275	-0.0885	-0.0610	-0.0999	-0.3074	-0.3074	-0.3074	-0.3074	-0.3074	-0.3074
0.675	*****	-0.1075	-0.0600	-0.1039	-0.3059	-0.3059	-0.3059	-0.3059	-0.3059	-0.3059
0.700	-0.1182	-0.1174	-0.0671	-0.1119	-0.3044	-0.3044	-0.3044	-0.3044	-0.3044	-0.3044
0.725	*****	-0.1354	*****	-0.1100	-0.3046	-0.3046	-0.3046	-0.3046	-0.3046	-0.3046
0.750	-0.1064	-0.1469	*****	-0.1202	-0.3066	-0.3066	-0.3066	-0.3066	-0.3066	-0.3066
0.775	*****	-0.1575	-0.1087	-0.1284	-0.3045	-0.3045	-0.3045	-0.3045	-0.3045	-0.3045
0.800	-0.0946	-0.1686	-0.1290	-0.1404	*****	*****	*****	*****	*****	*****
0.825	*****	-0.1665	-0.1516	-0.1507	-0.3395	-0.3395	-0.3395	-0.3395	-0.3395	-0.3395
0.850	-0.0692	-0.1593	-0.1698	-0.1842	-0.3565	-0.3565	-0.3565	-0.3565	-0.3565	-0.3565
0.875	*****	-0.1539	-0.1727	-0.2113	-0.4317	-0.4317	-0.4317	-0.4317	-0.4317	-0.4317
0.900	-0.0345	-0.1309	-0.1673	-0.2304	*****	*****	*****	*****	*****	*****
0.925	*****	-0.1075	-0.1604	-0.2225	-0.9987	-0.9987	-0.9987	-0.9987	-0.9987	-0.9987
0.950	0.0059	-0.0701	-0.1268	-0.1992	-0.4861	-0.4861	-0.4861	-0.4861	-0.4861	-0.4861
0.975	*****	-0.0309	-0.0661	-0.1338	-0.2691	-0.2691	-0.2691	-0.2691	-0.2691	-0.2691
-0.200	0.0114	0.0276	0.0784	0.0784	0.0784	0.0784	0.0784	0.0784	0.0784	0.0784
-0.400	-0.0042	0.0293	0.0447	-0.0697	-0.3392	-0.3392	-0.3392	-0.3392	-0.3392	-0.3392
-0.600	*****	0.0189	0.0215	-0.0587	-0.3749	-0.3749	-0.3749	-0.3749	-0.3749	-0.3749
-0.700	*****	-0.0078	0.0147	-0.0564	-0.4031	-0.4031	-0.4031	-0.4031	-0.4031	-0.4031
-0.800	0.0420	0.0142	-0.0124	-0.0534	-0.4378	-0.4378	-0.4378	-0.4378	-0.4378	-0.4378
-0.850	0.0718	0.0027	-0.0167	-0.0706	-0.4922	-0.4922	-0.4922	-0.4922	-0.4922	-0.4922
-0.900	0.1086	0.0450	-0.0016	-0.0659	-0.6695	-0.6695	-0.6695	-0.6695	-0.6695	-0.6695
-0.950	*****	*****	0.0729	-0.0016	-0.3407	-0.3407	-0.3407	-0.3407	-0.3407	-0.3407
-0.975	*****	0.1533	0.1259	0.0687	-0.1119	-0.1119	-0.1119	-0.1119	-0.1119	-0.1119

Sharp Radius L.E.
 Run No. = 85 , Point No. = 1847
 $C_N = 0.054$, $C_m = -0.0052$
 $\alpha = 2.2^\circ$, $M_\infty = 0.599$
 $R_{mac} = 6.0 \times 10^6$

Surface Pressures Near Leading Edge

● / ◆ upper, starboard/port
 ○ / ◇ lower, starboard/port

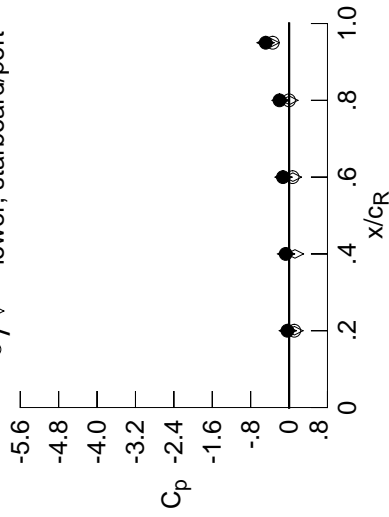

x/c_R	η	starb'd	port	starb'd	port
		$C_{p,u}$	$C_{p,l}$	$C_{p,u}$	$C_{p,l}$
0.20	0.90	-0.0345	-0.0273	0.1123	0.1086
0.40	0.95	-0.0701	-0.0623	0.1236	*****
0.60	0.95	-0.1268	-0.1159	0.0799	0.0729
0.80	0.95	-0.1992	-0.1785	0.0065	-0.0016
0.95	0.95	-0.4861	-0.4910	-0.3811	-0.3407

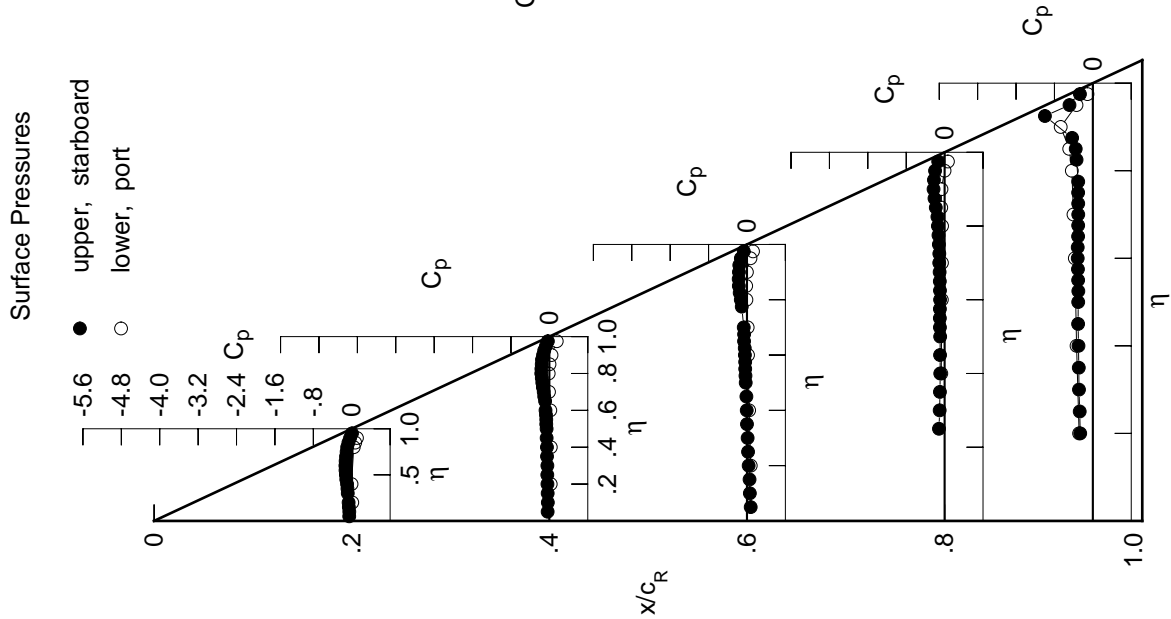

Table D2. Continued.

η	$x/c_R = .2$		$x/c_R = .4$		$x/c_R = .6$		$x/c_R = .8$		$x/c_R = .95$	
	$C_{p,u}$	$C_{p,l}$	$C_{p,u}$	$C_{p,l}$	$C_{p,u}$	$C_{p,l}$	$C_{p,u}$	$C_{p,l}$	$C_{p,u}$	$C_{p,l}$
0.050	-0.0712	-0.0473	0.0668	*****	*****	*****	*****	*****	*****	*****
0.100	-0.0733	-0.0492	0.0517	*****	*****	*****	*****	*****	*****	*****
0.150	-0.0856	-0.0500	0.0371	*****	*****	*****	*****	*****	*****	*****
0.200	-0.0904	-0.0527	0.0216	*****	*****	*****	*****	*****	*****	*****
0.250	*****	-0.0566	0.0075	-0.1245	-0.2716	*****	*****	*****	*****	*****
0.300	-0.1031	-0.0589	0.0011	-0.1097	-0.2894	*****	*****	*****	*****	*****
0.350	-0.1129	-0.0648	-0.0126	-0.1040	-0.2900	*****	*****	*****	*****	*****
0.400	-0.1215	-0.0712	-0.0188	-0.1021	-0.2957	*****	*****	*****	*****	*****
0.450	-0.1389	-0.0764	-0.0271	-0.1022	-0.2988	*****	*****	*****	*****	*****
0.500	-0.1490	-0.0788	-0.0406	-0.1040	-0.2994	*****	*****	*****	*****	*****
0.525	*****	-0.0864	-0.0454	-0.1048	-0.2985	*****	*****	*****	*****	*****
0.550	-0.1587	-0.0881	-0.0511	-0.1047	-0.2984	*****	*****	*****	*****	*****
0.575	*****	-0.0955	-0.0575	-0.1067	-0.2995	*****	*****	*****	*****	*****
0.600	-0.1626	-0.1004	-0.0641	-0.1074	-0.3046	*****	*****	*****	*****	*****
0.625	*****	*****	-0.0651	-0.1096	-0.3057	*****	*****	*****	*****	*****
0.650	-0.1598	-0.1123	-0.0773	-0.1137	-0.3004	*****	*****	*****	*****	*****
0.675	*****	-0.1308	-0.0805	-0.1210	-0.2970	*****	*****	*****	*****	*****
0.700	-0.1549	-0.1465	-0.0863	-0.1272	-0.2974	*****	*****	*****	*****	*****
0.725	*****	-0.1655	*****	-0.1283	-0.2957	*****	*****	*****	*****	*****
0.750	-0.1465	-0.1823	*****	-0.1373	-0.2973	*****	*****	*****	*****	*****
0.775	*****	-0.1951	-0.1352	-0.1495	-0.2915	*****	*****	*****	*****	*****
0.800	-0.1355	-0.2051	-0.1603	-0.1648	*****	*****	*****	*****	*****	*****
0.825	*****	-0.2116	-0.1861	-0.1756	-0.3141	*****	*****	*****	*****	*****
0.850	-0.1128	-0.2050	-0.2080	-0.2105	-0.3074	*****	*****	*****	*****	*****
0.875	*****	-0.2009	-0.2132	-0.2475	-0.4053	*****	*****	*****	*****	*****
0.900	-0.0792	-0.1794	-0.2158	-0.2700	*****	*****	*****	*****	*****	*****
0.925	*****	-0.1514	-0.2104	-0.2708	-0.9973	*****	*****	*****	*****	*****
0.950	-0.0476	-0.1113	-0.1664	-0.2504	-0.5141	*****	*****	*****	*****	*****
0.975	*****	-0.2319	-0.2308	-0.1929	-0.3082	*****	*****	*****	*****	*****
-0.200	0.0365	0.0428	0.0936	*****	-0.2913	*****	*****	*****	*****	*****
-0.400	0.0177	0.0453	0.0580	-0.0564	-0.3448	*****	*****	*****	*****	*****
-0.600	*****	0.0378	0.0400	-0.0479	-0.3810	*****	*****	*****	*****	*****
-0.700	*****	0.0192	0.0339	-0.0387	-0.4115	*****	*****	*****	*****	*****
-0.800	0.0739	0.0228	0.0150	-0.0365	-0.4387	*****	*****	*****	*****	*****
-0.850	0.1031	0.0370	0.0172	-0.0449	-0.4934	*****	*****	*****	*****	*****
-0.900	0.1381	0.0820	0.0377	-0.0311	-0.6526	*****	*****	*****	*****	*****
-0.950	*****	*****	0.1091	0.0376	-0.3192	*****	*****	*****	*****	*****
-0.975	*****	0.1753	0.1529	0.1006	-0.0899	*****	*****	*****	*****	*****

Sharp Radius L.E.
 Run No. = 85 , Point No. = 1848
 $C_N = 0.096$, $C_m = -0.0138$
 $\alpha = 3.2^\circ$, $M_\infty = 0.599$
 $R_{mac} = 6.0 \times 10^6$

Surface Pressures Near Leading Edge

● / ◆ upper, starboard/port
 ○ / ◇ lower, starboard/port

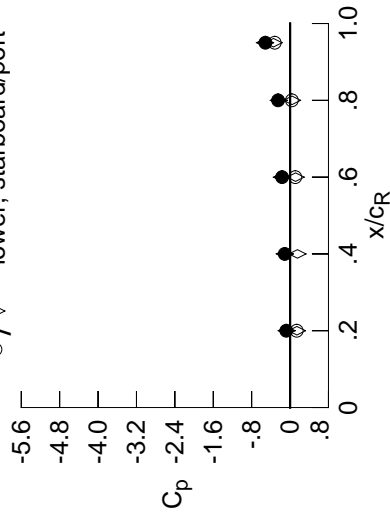

x/c_R	η	starb'd	port	$C_{p,u}$	starb'd	port	$C_{p,l}$
0.20	0.90	-0.0792	-0.0715	0.1432	0.1381	0.1432	0.1381
0.40	0.95	-0.1113	-0.1101	0.1533	*****	0.1533	*****
0.60	0.95	-0.1664	-0.1706	0.1155	0.1091	0.1155	0.1091
0.80	0.95	-0.2504	-0.2345	0.0408	0.0376	0.0408	0.0376
0.95	0.95	-0.5141	-0.5218	-0.3447	-0.3192	-0.3447	-0.3192

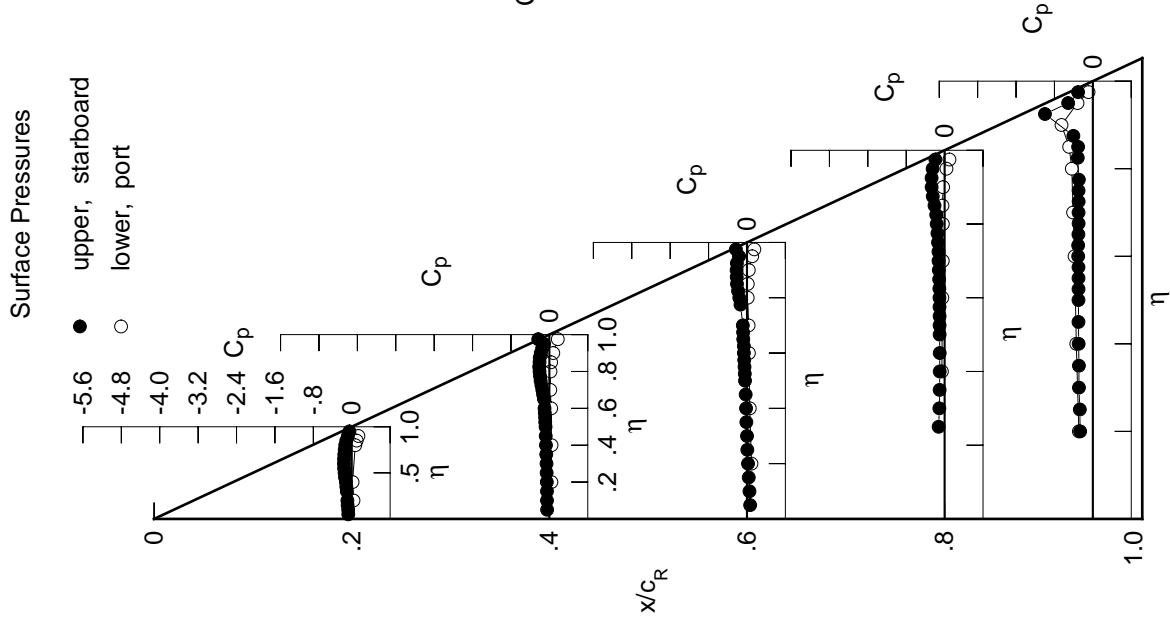

Table D2. Continued.

η	$x/c_R = .2$		$x/c_R = .4$		$x/c_R = .6$		$x/c_R = .8$		$x/c_R = .95$	
	$C_{p,u}$	$C_{p,l}$	$C_{p,u}$	$C_{p,l}$	$C_{p,u}$	$C_{p,l}$	$C_{p,u}$	$C_{p,l}$	$C_{p,u}$	$C_{p,l}$
0.050	-0.0925	-0.0658	0.0556	0.0556	0.0556	0.0556	0.0556	0.0556	0.0556	0.0556
0.100	-0.0973	-0.0641	0.0408	0.0408	0.0408	0.0408	0.0408	0.0408	0.0408	0.0408
0.150	-0.1062	-0.0657	0.0272	0.0272	0.0272	0.0272	0.0272	0.0272	0.0272	0.0272
0.200	-0.1106	-0.0696	0.0130	0.0130	0.0130	0.0130	0.0130	0.0130	0.0130	0.0130
0.250	0.0000	-0.0751	-0.0033	-0.1352	-0.2727	-0.2727	-0.2727	-0.2727	-0.2727	-0.2727
0.300	-0.1251	-0.0760	-0.0121	-0.1214	-0.2828	-0.2828	-0.2828	-0.2828	-0.2828	-0.2828
0.350	-0.1353	-0.0818	-0.0260	-0.1126	-0.2906	-0.2906	-0.2906	-0.2906	-0.2906	-0.2906
0.400	-0.1460	-0.0908	-0.0317	-0.1093	-0.2952	-0.2952	-0.2952	-0.2952	-0.2952	-0.2952
0.450	-0.1648	-0.0948	-0.0387	-0.1146	-0.2977	-0.2977	-0.2977	-0.2977	-0.2977	-0.2977
0.500	-0.1761	-0.1006	-0.0569	-0.1161	-0.2982	-0.2982	-0.2982	-0.2982	-0.2982	-0.2982
0.525	0.0000	-0.1087	-0.0648	-0.1181	-0.2974	-0.2974	-0.2974	-0.2974	-0.2974	-0.2974
0.550	-0.1898	-0.1087	-0.0722	-0.1232	-0.2947	-0.2947	-0.2947	-0.2947	-0.2947	-0.2947
0.575	0.0000	-0.1177	-0.0746	-0.1232	-0.2995	-0.2995	-0.2995	-0.2995	-0.2995	-0.2995
0.600	-0.1943	-0.1255	-0.0847	-0.1243	-0.3037	-0.3037	-0.3037	-0.3037	-0.3037	-0.3037
0.625	0.0000	0.0000	-0.0864	-0.1262	-0.3050	-0.3050	-0.3050	-0.3050	-0.3050	-0.3050
0.650	-0.1966	-0.1405	-0.1007	-0.1303	-0.3029	-0.3029	-0.3029	-0.3029	-0.3029	-0.3029
0.675	0.0000	-0.1620	-0.1048	-0.1385	-0.3020	-0.3020	-0.3020	-0.3020	-0.3020	-0.3020
0.700	-0.1914	-0.1778	-0.1111	-0.1480	-0.3052	-0.3052	-0.3052	-0.3052	-0.3052	-0.3052
0.725	0.0000	-0.1986	0.0000	-0.1496	-0.3081	-0.3081	-0.3081	-0.3081	-0.3081	-0.3081
0.750	-0.1865	-0.2165	0.0000	-0.1608	-0.3175	-0.3175	-0.3175	-0.3175	-0.3175	-0.3175
0.775	0.0000	-0.2322	-0.1632	-0.1758	-0.3215	-0.3215	-0.3215	-0.3215	-0.3215	-0.3215
0.800	-0.1776	-0.2473	-0.1912	-0.1901	0.0000	0.0000	0.0000	0.0000	0.0000	0.0000
0.825	0.0000	-0.2538	-0.2189	-0.2022	-0.3609	-0.3609	-0.3609	-0.3609	-0.3609	-0.3609
0.850	-0.1541	-0.2459	-0.2451	-0.2436	-0.3398	-0.3398	-0.3398	-0.3398	-0.3398	-0.3398
0.875	0.0000	-0.2420	-0.2492	-0.2803	-0.4520	-0.4520	-0.4520	-0.4520	-0.4520	-0.4520
0.900	-0.1155	-0.2101	-0.2502	-0.3075	0.0000	0.0000	0.0000	0.0000	0.0000	0.0000
0.925	0.0000	-0.1898	-0.2375	-0.3070	-1.0267	-1.0267	-1.0267	-1.0267	-1.0267	-1.0267
0.950	-0.1072	-0.3085	-0.2984	-0.2946	-0.5562	-0.5562	-0.5562	-0.5562	-0.5562	-0.5562
0.975	0.0000	-0.4242	-0.4678	-0.4600	-0.3850	-0.3850	-0.3850	-0.3850	-0.3850	-0.3850
-0.200	0.0534	0.0620	0.1078	0.0000	-0.2922	-0.2922	-0.2922	-0.2922	-0.2922	-0.2922
-0.400	0.0423	0.0630	0.0682	-0.0495	-0.3512	-0.3512	-0.3512	-0.3512	-0.3512	-0.3512
-0.600	0.0000	0.0621	0.0569	-0.0309	-0.3850	-0.3850	-0.3850	-0.3850	-0.3850	-0.3850
-0.700	0.0000	0.0454	0.0534	-0.0268	-0.4034	-0.4034	-0.4034	-0.4034	-0.4034	-0.4034
-0.800	0.1037	0.0544	0.0410	-0.0142	-0.4316	-0.4316	-0.4316	-0.4316	-0.4316	-0.4316
-0.850	0.1320	0.0681	0.0467	-0.0195	-0.4773	-0.4773	-0.4773	-0.4773	-0.4773	-0.4773
-0.900	0.1629	0.1154	0.0723	0.0016	-0.6050	-0.6050	-0.6050	-0.6050	-0.6050	-0.6050
-0.950	0.0000	0.0000	0.1388	0.0703	-0.2810	-0.2810	-0.2810	-0.2810	-0.2810	-0.2810
-0.975	0.0000	0.1855	0.1706	0.1224	-0.0626	-0.0626	-0.0626	-0.0626	-0.0626	-0.0626

Sharp Radius L.E.
 Run No. = 85 , Point No. = 1849
 $C_N = 0.139$, $C_m = -0.0224$
 $\alpha = 4.2^\circ$, $M_\infty = 0.599$
 $R_{mac} = 6.0 \times 10^6$

Surface Pressures Near Leading Edge

● / ◆ upper, starboard/port
 ○ / ◇ lower, starboard/port

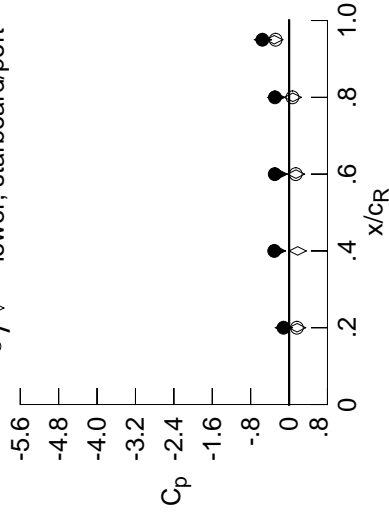

x/c_R	η	starb'd	port	starb'd	port
		$C_{p,u}$	$C_{p,l}$	$C_{p,u}$	$C_{p,l}$
0.20	0.90	-0.1155	-0.1077	0.1679	0.1629
0.40	0.95	-0.3085	-0.2537	0.1793	0.1388
0.60	0.95	-0.2984	-0.2156	0.1447	0.1388
0.80	0.95	-0.2946	-0.2674	0.0782	0.0703
0.95	0.95	-0.5562	-0.5438	-0.3087	-0.2810

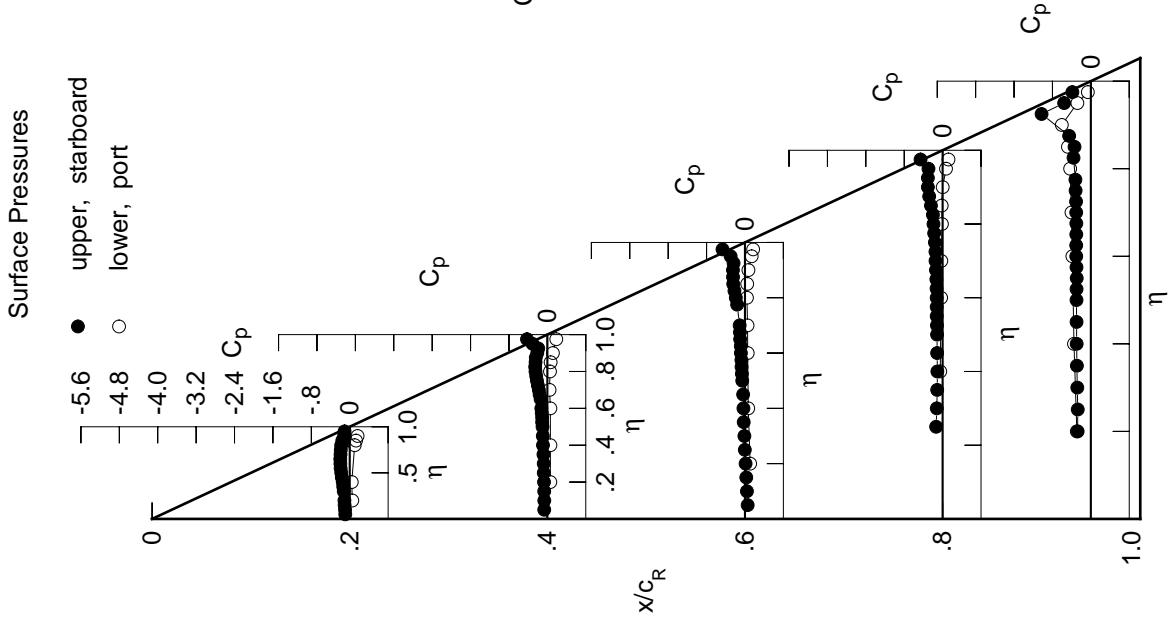

Table D2. Continued.

η	$x/c_R = .2$		$x/c_R = .4$		$x/c_R = .6$		$x/c_R = .8$		$x/c_R = .95$	
	$C_{p,u}$	$C_{p,l}$	$C_{p,u}$	$C_{p,l}$	$C_{p,u}$	$C_{p,l}$	$C_{p,u}$	$C_{p,l}$	$C_{p,u}$	$C_{p,l}$
0.050	-0.1096	-0.0794	0.0442	*****	*****	*****	*****	*****	*****	*****
0.100	-0.1136	-0.0786	0.0310	*****	*****	*****	*****	*****	*****	*****
0.150	-0.1252	-0.0838	0.0145	*****	*****	*****	*****	*****	*****	*****
0.200	-0.1297	-0.0832	-0.0009	*****	*****	*****	*****	*****	*****	*****
0.250	*****	-0.0916	-0.0155	-0.1397	-0.2679	*****	*****	*****	*****	*****
0.300	-0.1458	-0.0949	-0.0251	-0.1292	-0.2674	*****	*****	*****	*****	*****
0.350	-0.1566	-0.1020	-0.0420	-0.1217	-0.2718	*****	*****	*****	*****	*****
0.400	-0.1685	-0.1081	-0.0456	-0.1191	-0.2822	*****	*****	*****	*****	*****
0.450	-0.1903	-0.1190	-0.0558	-0.1225	-0.2861	*****	*****	*****	*****	*****
0.500	-0.2036	-0.1215	-0.0722	-0.1276	-0.2941	*****	*****	*****	*****	*****
0.525	*****	-0.1306	-0.0769	-0.1298	-0.2967	*****	*****	*****	*****	*****
0.550	-0.2181	-0.1311	-0.0852	-0.1329	-0.2978	*****	*****	*****	*****	*****
0.575	*****	-0.1390	-0.0902	-0.1341	-0.3060	*****	*****	*****	*****	*****
0.600	-0.2241	-0.1461	-0.1017	-0.1365	-0.3174	*****	*****	*****	*****	*****
0.625	*****	*****	-0.1076	-0.1374	-0.3224	*****	*****	*****	*****	*****
0.650	-0.2310	-0.1634	-0.1199	-0.1436	-0.3263	*****	*****	*****	*****	*****
0.675	*****	-0.1887	-0.1235	-0.1525	-0.3321	*****	*****	*****	*****	*****
0.700	-0.2270	-0.2052	-0.1301	-0.1586	-0.3324	*****	*****	*****	*****	*****
0.725	*****	-0.2266	*****	-0.1651	-0.3496	*****	*****	*****	*****	*****
0.750	-0.2199	-0.2492	*****	-0.1753	-0.3596	*****	*****	*****	*****	*****
0.775	*****	-0.2650	-0.1892	-0.1987	-0.3666	*****	*****	*****	*****	*****
0.800	-0.2068	-0.2758	-0.2172	-0.2249	*****	*****	*****	*****	*****	*****
0.825	*****	-0.2803	-0.2408	-0.2212	-0.4233	*****	*****	*****	*****	*****
0.850	-0.1711	-0.2670	-0.2579	-0.2671	-0.4105	*****	*****	*****	*****	*****
0.875	*****	-0.2439	-0.2492	-0.2978	-0.5081	*****	*****	*****	*****	*****
0.900	-0.2354	-0.2713	-0.3114	-0.3127	*****	*****	*****	*****	*****	*****
0.925	*****	-0.4508	-0.4631	-0.4063	-0.8574	*****	*****	*****	*****	*****
0.950	-0.1771	-0.5543	-0.5852	-0.5655	-0.5974	*****	*****	*****	*****	*****
0.975	*****	-0.5233	-0.5563	-0.5929	-0.5933	*****	*****	*****	*****	*****
-0.200	0.0772	0.0787	0.1222	*****	-0.2971	*****	*****	*****	*****	*****
-0.400	0.0669	0.0838	0.0871	-0.0371	-0.3580	*****	*****	*****	*****	*****
-0.600	*****	0.0846	0.0743	-0.0201	-0.3781	*****	*****	*****	*****	*****
-0.700	*****	0.0718	0.0755	-0.0098	-0.3948	*****	*****	*****	*****	*****
-0.800	0.1340	0.0852	0.0676	0.0059	-0.4077	*****	*****	*****	*****	*****
-0.850	0.1603	0.0988	0.0770	0.0062	-0.4516	*****	*****	*****	*****	*****
-0.900	0.1858	0.1452	0.1042	0.0311	-0.5774	*****	*****	*****	*****	*****
-0.950	*****	*****	0.1619	0.0985	-0.2474	*****	*****	*****	*****	*****
-0.975	*****	0.1912	0.1800	0.1374	-0.0404	*****	*****	*****	*****	*****

Sharp Radius L.E.
 Run No. = 85 , Point No. = 1850
 $C_N = 0.184$, $C_m = -0.0316$
 $\alpha = 5.2^\circ$, $M_\infty = 0.599$
 $R_{mac} = 6.0 \times 10^6$

Surface Pressures Near Leading Edge

● / ◆ upper, starboard/port
 ○ / ◇ lower, starboard/port

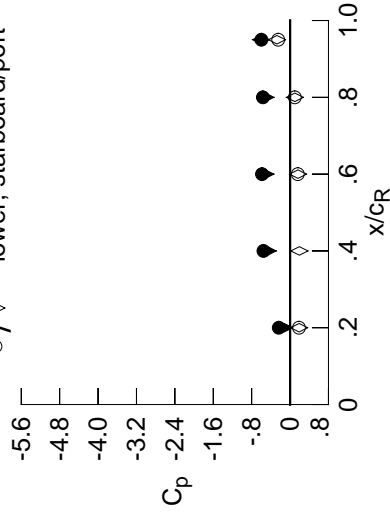

x/c_R	η	starb'd	port	starb'd	port
		$C_{p,u}$	$C_{p,l}$	$C_{p,u}$	$C_{p,l}$
0.20	0.90	-0.2354	-0.1222	0.1885	0.1858
0.40	0.95	-0.5543	-0.4660	0.1945	*****
0.60	0.95	-0.5852	-0.5145	0.1657	0.1619
0.80	0.95	-0.5655	-0.5128	0.1002	0.0985
0.95	0.95	-0.5974	-0.6052	-0.2730	-0.2474

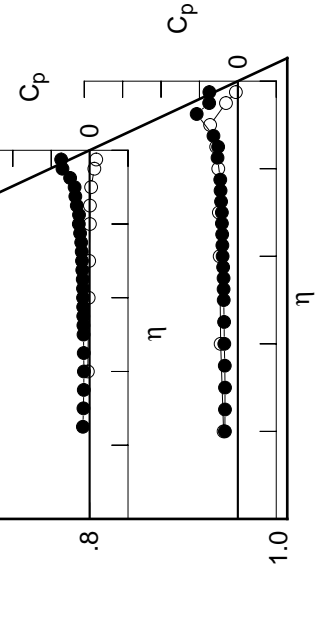

Table D2. Continued.

η	$x/c_R = .2$		$x/c_R = .4$		$x/c_R = .6$		$x/c_R = .8$		$x/c_R = .95$	
	$C_{p,u}$	$C_{p,l}$	$C_{p,u}$	$C_{p,l}$	$C_{p,u}$	$C_{p,l}$	$C_{p,u}$	$C_{p,l}$	$C_{p,u}$	$C_{p,l}$
0.050	-0.1329	-0.0937	0.0352	*****	*****	*****	*****	*****	*****	*****
0.100	-0.1345	-0.0966	0.0172	*****	*****	*****	*****	*****	*****	*****
0.150	-0.1466	-0.1011	0.0082	*****	*****	*****	*****	*****	*****	*****
0.200	-0.1506	-0.1009	-0.0153	*****	*****	*****	*****	*****	*****	*****
0.250	*****	-0.1117	-0.0268	-0.1546	-0.2738	*****	*****	*****	*****	*****
0.300	-0.1681	-0.1127	-0.0432	-0.1400	-0.2596	*****	*****	*****	*****	*****
0.350	-0.1796	-0.1201	-0.0553	-0.1376	-0.2548	*****	*****	*****	*****	*****
0.400	-0.1923	-0.1291	-0.0593	-0.1282	-0.2606	*****	*****	*****	*****	*****
0.450	-0.2152	-0.1451	-0.0708	-0.1346	-0.2713	*****	*****	*****	*****	*****
0.500	-0.2312	-0.1453	-0.0884	-0.1355	-0.2816	*****	*****	*****	*****	*****
0.525	*****	-0.1517	-0.0962	-0.1419	-0.2977	*****	*****	*****	*****	*****
0.550	-0.2464	-0.1579	-0.1040	-0.1411	-0.3069	*****	*****	*****	*****	*****
0.575	*****	-0.1603	-0.1079	-0.1430	-0.3270	*****	*****	*****	*****	*****
0.600	-0.2535	-0.1722	-0.1154	-0.1468	-0.3512	*****	*****	*****	*****	*****
0.625	*****	*****	-0.1213	-0.1443	-0.3642	*****	*****	*****	*****	*****
0.650	-0.2589	-0.1857	-0.1352	-0.1455	-0.3799	*****	*****	*****	*****	*****
0.675	*****	-0.2165	-0.1399	-0.1551	-0.3833	*****	*****	*****	*****	*****
0.700	-0.2530	-0.2299	-0.1412	-0.1558	-0.3978	*****	*****	*****	*****	*****
0.725	*****	*****	*****	-0.1559	-0.3968	*****	*****	*****	*****	*****
0.750	-0.2423	-0.2667	*****	-0.1585	-0.4081	*****	*****	*****	*****	*****
0.775	*****	-0.2799	-0.1925	-0.2149	-0.4440	*****	*****	*****	*****	*****
0.800	-0.2096	-0.2884	-0.2229	-0.2940	*****	*****	*****	*****	*****	*****
0.825	*****	-0.2843	-0.2606	-0.3378	-0.6363	*****	*****	*****	*****	*****
0.850	-0.2317	-0.2884	-0.3410	-0.4433	-0.5966	*****	*****	*****	*****	*****
0.875	*****	-0.3917	-0.4936	-0.5412	-0.6659	*****	*****	*****	*****	*****
0.900	-0.4705	-0.5965	-0.6266	-0.5926	*****	*****	*****	*****	*****	*****
0.925	*****	-0.6724	-0.6648	-0.5975	-0.6245	*****	*****	*****	*****	*****
0.950	-0.2902	-0.6596	-0.6459	-0.5792	-0.5382	*****	*****	*****	*****	*****
0.975	*****	-0.6409	-0.6199	-0.5737	-0.4575	*****	*****	*****	*****	*****
-0.200	$C_{p,l}$	0.1003	0.0990	0.1402	*****	-0.3136	*****	*****	*****	*****
-0.400	0.0913	0.1058	0.1033	-0.0238	-0.3587	*****	*****	*****	*****	*****
-0.600	*****	0.1048	0.0934	-0.0030	-0.3718	*****	*****	*****	*****	*****
-0.700	*****	0.0980	0.0951	0.0074	-0.3715	*****	*****	*****	*****	*****
-0.800	0.1615	0.1161	0.0922	0.0293	-0.3764	*****	*****	*****	*****	*****
-0.850	0.1839	0.1289	0.1046	0.0314	-0.4219	*****	*****	*****	*****	*****
-0.900	0.2042	0.1728	0.1317	0.0607	-0.5340	*****	*****	*****	*****	*****
-0.950	*****	*****	0.1787	0.1207	-0.2137	*****	*****	*****	*****	*****
-0.975	*****	0.1874	0.1819	0.1486	-0.0200	*****	*****	*****	*****	*****

Sharp Radius L.E.

Run No. = 85, Point No. = 1851

$C_N = 0.238$, $C_m = -0.0439$

$\alpha = 6.3^\circ$, $M_\infty = 0.599$

$R_{mac} = 6.0 \times 10^6$

Surface Pressures Near Leading Edge

● / ◆ upper, starboard/port
○ / ◇ lower, starboard/port

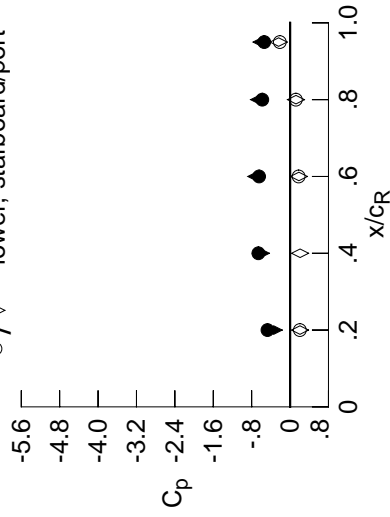

x/c_R	η	$C_{p,u}$ starb'd	$C_{p,u}$ port	$C_{p,l}$ starb'd	$C_{p,l}$ port
0.20	0.90	-0.4705	-0.3406	0.2067	0.2042
0.40	0.95	-0.6596	-0.6083	0.2086	*****
0.60	0.95	-0.6459	-0.7040	0.1843	0.1787
0.80	0.95	-0.5792	-0.6452	0.1232	0.1207
0.95	0.95	-0.5382	-0.5954	-0.2384	-0.2137

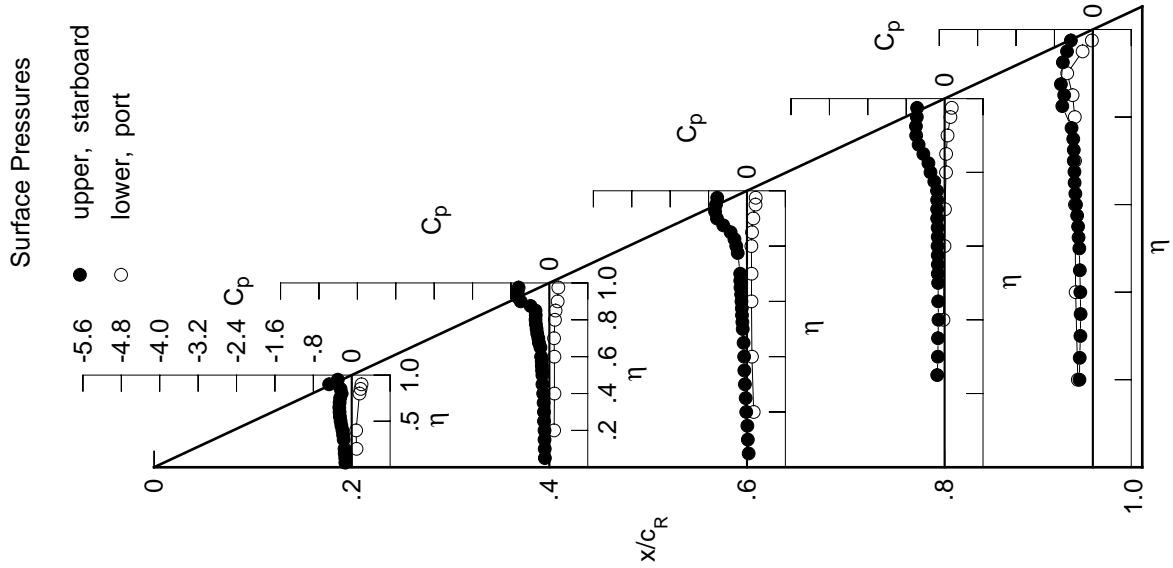

Table D2. Continued.

η	$x/c_R = .2$		$x/c_R = .4$		$x/c_R = .6$		$x/c_R = .8$		$x/c_R = .95$	
	$C_{p,u}$	$C_{p,l}$	$C_{p,u}$	$C_{p,l}$	$C_{p,u}$	$C_{p,l}$	$C_{p,u}$	$C_{p,l}$	$C_{p,u}$	$C_{p,l}$
0.050	-0.1494	-0.1115	0.0206	0.0206	0.0206	0.0206	0.0206	0.0206	0.0206	0.0206
0.100	-0.1528	-0.1137	0.0041	0.0041	0.0041	0.0041	0.0041	0.0041	0.0041	0.0041
0.150	-0.1649	-0.1186	-0.0091	-0.0091	-0.0091	-0.0091	-0.0091	-0.0091	-0.0091	-0.0091
0.200	-0.1719	-0.1225	-0.0259	-0.0259	-0.0259	-0.0259	-0.0259	-0.0259	-0.0259	-0.0259
0.250	*****	-0.1286	-0.0417	-0.1635	-0.1635	-0.1635	-0.1635	-0.1635	-0.1635	-0.1635
0.300	-0.1894	-0.1293	-0.0637	-0.1597	-0.1597	-0.1597	-0.1597	-0.1597	-0.1597	-0.1597
0.350	-0.2006	-0.1390	-0.0757	-0.1428	-0.1428	-0.1428	-0.1428	-0.1428	-0.1428	-0.1428
0.400	-0.2147	-0.1514	-0.0783	-0.1415	-0.1415	-0.1415	-0.1415	-0.1415	-0.1415	-0.1415
0.450	-0.2396	-0.1708	-0.0834	-0.1425	-0.1425	-0.1425	-0.1425	-0.1425	-0.1425	-0.1425
0.500	-0.2564	-0.1679	-0.1025	-0.1433	-0.1433	-0.1433	-0.1433	-0.1433	-0.1433	-0.1433
0.525	*****	-0.1738	-0.1085	-0.1437	-0.1437	-0.1437	-0.1437	-0.1437	-0.1437	-0.1437
0.550	-0.2748	-0.1726	-0.1162	-0.1456	-0.1456	-0.1456	-0.1456	-0.1456	-0.1456	-0.1456
0.575	*****	-0.1819	-0.1184	-0.1437	-0.1437	-0.1437	-0.1437	-0.1437	-0.1437	-0.1437
0.600	-0.2797	-0.1890	-0.1255	-0.1403	-0.1403	-0.1403	-0.1403	-0.1403	-0.1403	-0.1403
0.625	*****	*****	-0.1310	-0.1388	-0.1388	-0.1388	-0.1388	-0.1388	-0.1388	-0.1388
0.650	-0.2867	-0.2050	-0.1444	-0.1367	-0.1367	-0.1367	-0.1367	-0.1367	-0.1367	-0.1367
0.675	*****	-0.2312	-0.1456	-0.1334	-0.1334	-0.1334	-0.1334	-0.1334	-0.1334	-0.1334
0.700	-0.2711	-0.2480	-0.1359	-0.1184	-0.1184	-0.1184	-0.1184	-0.1184	-0.1184	-0.1184
0.725	*****	-0.2669	*****	-0.1014	-0.1014	-0.1014	-0.1014	-0.1014	-0.1014	-0.1014
0.750	-0.2373	-0.2768	*****	-0.1703	-0.1703	-0.1703	-0.1703	-0.1703	-0.1703	-0.1703
0.775	*****	-0.2702	-0.2108	-0.4286	-0.4286	-0.4286	-0.4286	-0.4286	-0.4286	-0.4286
0.800	-0.2378	-0.2760	-0.3941	-0.6204	-0.6204	-0.6204	-0.6204	-0.6204	-0.6204	-0.6204
0.825	*****	-0.3687	-0.5881	-0.7024	-0.7024	-0.7024	-0.7024	-0.7024	-0.7024	-0.7024
0.850	-0.4955	-0.5440	-0.7063	-0.7184	-0.6976	-0.6976	-0.6976	-0.6976	-0.6976	-0.6976
0.875	*****	-0.7184	-0.7186	-0.6741	-0.6322	-0.6322	-0.6322	-0.6322	-0.6322	-0.6322
0.900	-0.5588	-0.7879	-0.7233	-0.6191	*****	*****	*****	*****	*****	*****
0.925	*****	-0.7745	-0.7007	-0.5832	-0.5619	-0.5619	-0.5619	-0.5619	-0.5619	-0.5619
0.950	-0.4420	-0.7473	-0.6724	-0.5633	-0.4834	-0.4834	-0.4834	-0.4834	-0.4834	-0.4834
0.975	*****	-0.7363	-0.6569	-0.5596	-0.4225	-0.4225	-0.4225	-0.4225	-0.4225	-0.4225

Sharp Radius L.E.
 Run No. = 85 , Point No. = 1852
 $C_N = 0.292$, $C_m = -0.0543$
 $\alpha = 7.3^\circ$, $M_\infty = 0.599$
 $R_{mac} = 6.0 \times 10^6$

Surface Pressures Near Leading Edge

● / ◆ upper, starboard/port
 ○ / ◇ lower, starboard/port

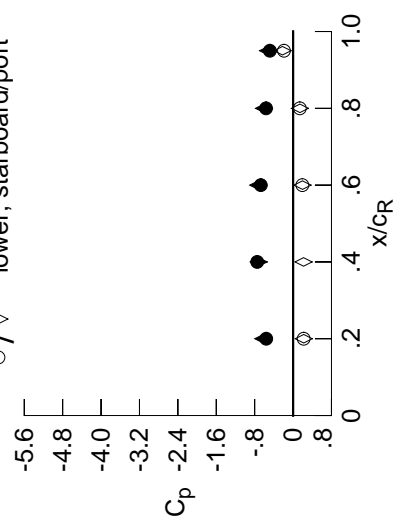

x/c_R	η	starb'd	port	starb'd	port
		$C_{p,u}$	$C_{p,l}$	$C_{p,u}$	$C_{p,l}$
0.20	0.90	-0.5588	-0.6206	0.2223	0.2205
0.40	0.95	-0.7473	-0.7171	0.2187	*****
0.60	0.95	-0.6724	-0.7254	0.1964	0.1933
0.80	0.95	-0.5633	-0.6053	0.1422	0.1406
0.95	0.95	-0.4834	-0.5206	-0.2205	-0.1899

Surface Pressures

● upper, starboard
 ○ lower, port

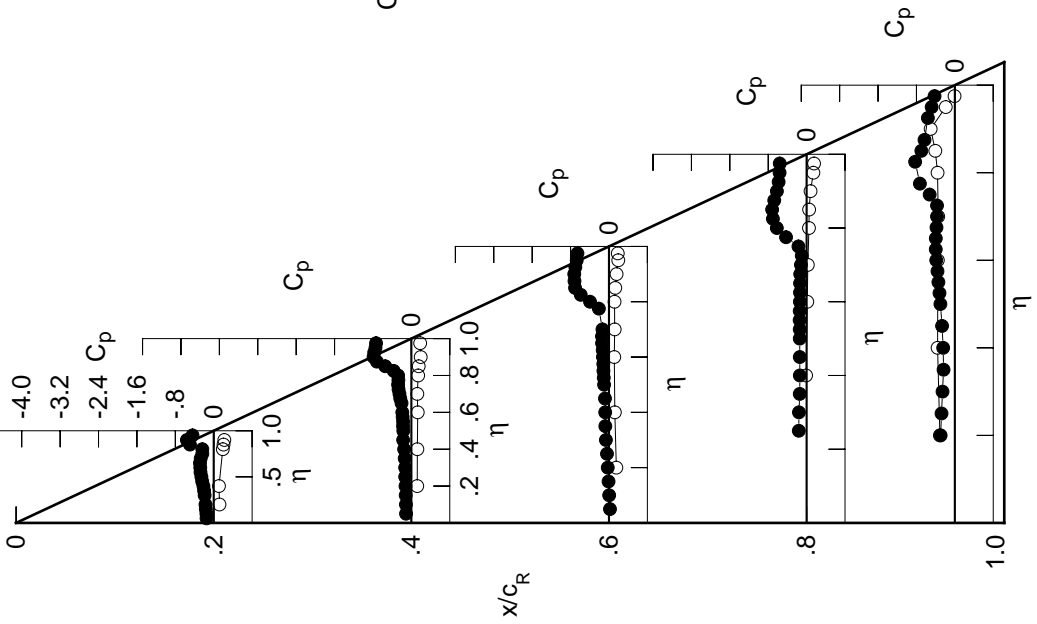

η	$C_{p,l}$	$C_{p,l}$	$C_{p,l}$	$C_{p,l}$	$C_{p,l}$
-0.200	0.1202	0.1223	0.1534	*****	-0.3117
-0.400	0.1097	0.1244	0.1220	-0.0111	-0.3594
-0.600	*****	0.1325	0.1107	0.0136	-0.3543
-0.700	*****	0.1237	0.1191	0.0249	-0.3463
-0.800	0.1886	0.1414	0.1161	0.0486	-0.3604
-0.850	0.2040	0.1525	0.1312	0.0523	-0.4069
-0.900	0.2205	0.1946	0.1581	0.0816	-0.5040
-0.950	*****	*****	0.1933	0.1406	-0.1899
-0.975	*****	0.1830	0.1830	0.1546	-0.0067

Table D2. Continued.

η	$x/c_R = .2$		$x/c_R = .4$		$x/c_R = .6$		$x/c_R = .8$		$x/c_R = .95$	
	$C_{p,u}$	$C_{p,l}$	$C_{p,u}$	$C_{p,l}$	$C_{p,u}$	$C_{p,l}$	$C_{p,u}$	$C_{p,l}$	$C_{p,u}$	$C_{p,l}$
0.050	-0.1692	-0.1349	0.0048	*****	*****	*****	*****	*****	*****	*****
0.100	-0.1752	-0.1340	-0.0105	*****	*****	*****	*****	*****	*****	*****
0.150	-0.1899	-0.1377	-0.0249	*****	*****	*****	*****	*****	*****	*****
0.200	-0.1936	-0.1418	-0.0453	*****	*****	*****	*****	*****	*****	*****
0.250	*****	-0.1498	-0.0587	-0.1750	-0.2832	*****	*****	*****	*****	*****
0.300	-0.2112	-0.1557	-0.0805	-0.1722	-0.2436	*****	*****	*****	*****	*****
0.350	-0.2252	-0.1608	-0.0950	-0.1523	-0.2230	*****	*****	*****	*****	*****
0.400	-0.2385	-0.1759	-0.0951	-0.1483	-0.2363	*****	*****	*****	*****	*****
0.450	-0.2654	-0.2057	-0.0989	-0.1469	-0.2779	*****	*****	*****	*****	*****
0.500	-0.2818	-0.1970	-0.1173	-0.1478	-0.3230	*****	*****	*****	*****	*****
0.525	*****	-0.1988	-0.1224	-0.1466	-0.3436	*****	*****	*****	*****	*****
0.550	-0.3003	-0.1973	-0.1289	-0.1480	-0.3653	*****	*****	*****	*****	*****
0.575	*****	-0.2000	-0.1293	-0.1436	-0.3789	*****	*****	*****	*****	*****
0.600	-0.3034	-0.2088	-0.1356	-0.1385	-0.3990	*****	*****	*****	*****	*****
0.625	*****	*****	-0.1319	-0.1284	-0.4003	*****	*****	*****	*****	*****
0.650	-0.2989	-0.2209	-0.1387	-0.1169	-0.3882	*****	*****	*****	*****	*****
0.675	*****	-0.2416	-0.1248	-0.1034	-0.3645	*****	*****	*****	*****	*****
0.700	-0.2665	-0.2502	-0.1033	-0.0908	-0.3715	*****	*****	*****	*****	*****
0.725	*****	-0.2569	*****	-0.1432	-0.4893	*****	*****	*****	*****	*****
0.750	-0.2443	-0.2629	*****	-0.3958	-0.7267	*****	*****	*****	*****	*****
0.775	*****	-0.3048	-0.5373	-0.7069	-0.8964	*****	*****	*****	*****	*****
0.800	-0.4686	-0.4679	-0.8062	-0.8760	*****	*****	*****	*****	*****	*****
0.825	*****	-0.6906	-0.8973	-0.9226	-0.8121	*****	*****	*****	*****	*****
0.850	-0.7094	-0.8364	-0.8856	-0.8735	-0.6262	*****	*****	*****	*****	*****
0.875	*****	-0.9059	-0.8012	-0.7096	-0.5577	*****	*****	*****	*****	*****
0.900	-0.6382	-0.8946	-0.7611	-0.6297	*****	*****	*****	*****	*****	*****
0.925	*****	-0.8598	-0.7279	-0.5914	-0.5204	*****	*****	*****	*****	*****
0.950	-0.6124	-0.8316	-0.7039	-0.5620	-0.4533	*****	*****	*****	*****	*****
0.975	*****	-0.8261	-0.6852	-0.5553	-0.4011	*****	*****	*****	*****	*****
-0.200	$C_{p,l}$	0.1457	0.1416	0.1668	*****	*****	*****	*****	*****	*****
-0.400	$C_{p,l}$	0.1319	0.1454	0.1412	0.0004	-0.3607	*****	*****	*****	*****
-0.600	*****	0.1571	0.1285	0.0268	-0.3376	*****	*****	*****	*****	*****
-0.700	*****	0.1492	0.1403	0.0390	-0.3393	*****	*****	*****	*****	*****
-0.800	$C_{p,l}$	0.2111	0.1695	0.1399	0.0659	-0.3760	*****	*****	*****	*****
-0.850	$C_{p,l}$	0.2223	0.1771	0.1553	0.0710	-0.4275	*****	*****	*****	*****
-0.900	$C_{p,l}$	0.2326	0.2142	0.1853	0.0997	-0.4899	*****	*****	*****	*****
-0.950	*****	*****	0.2049	0.1557	-0.1811	*****	*****	*****	*****	*****
-0.975	*****	0.1731	0.1814	0.1577	-0.0014	*****	*****	*****	*****	*****

Sharp Radius L.E.

Run No. = 85 , Point No. = 1853

$C_N = 0.338$, $C_m = -0.0586$

$\alpha = 8.3^\circ$, $M_\infty = 0.599$

$R_{mac} = 6.0 \times 10^6$

Surface Pressures Near Leading Edge

● / ◆ upper, starboard/port
○ / ◇ lower, starboard/port

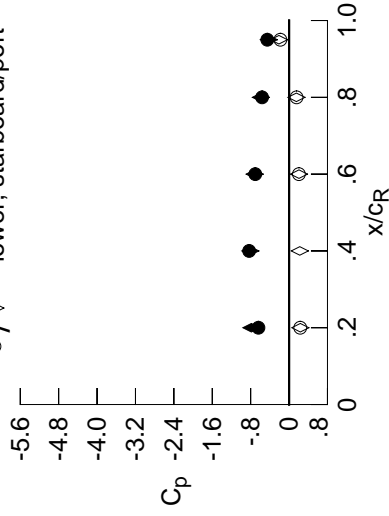

x/c_R	η	starb'd	port	$C_{p,u}$	starb'd	port	$C_{p,l}$
0.20	0.90	-0.6382	-0.7846	0.2343	0.2326	*****	*****
0.40	0.95	-0.8316	-0.8070	0.2235	*****	*****	*****
0.60	0.95	-0.7039	-0.7173	0.2066	0.2049	*****	*****
0.80	0.95	-0.5620	-0.5869	0.1525	0.1557	*****	*****
0.95	0.95	-0.4533	-0.4213	-0.2111	-0.1811	*****	*****

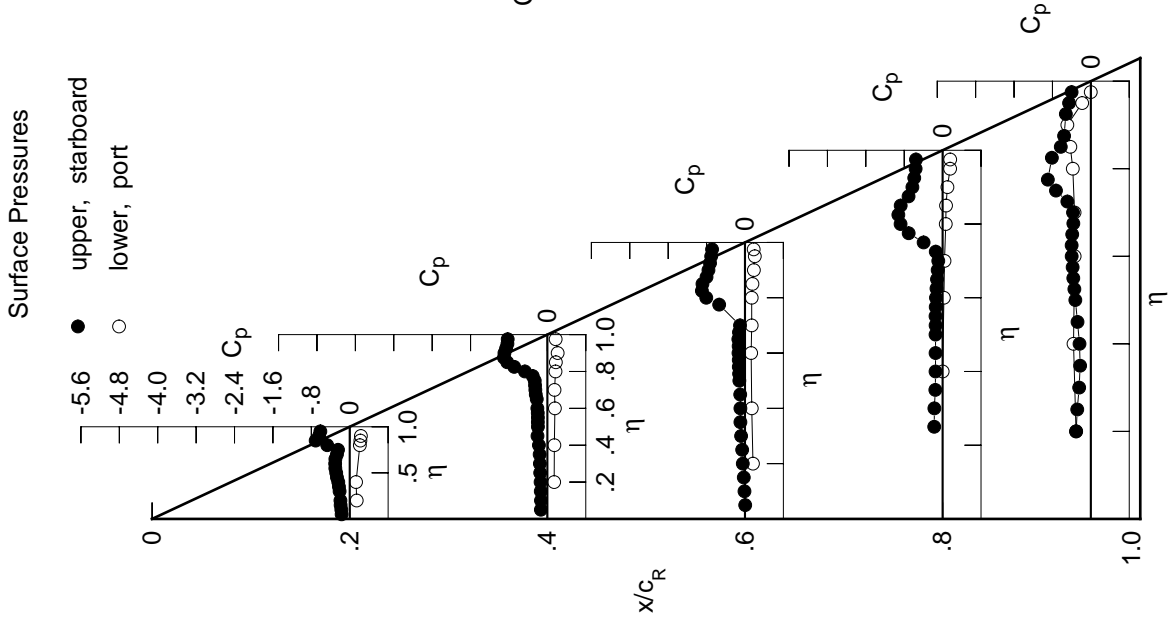

Table D2. Continued.

η	$x/c_R = .2$		$x/c_R = .4$		$x/c_R = .6$		$x/c_R = .8$		$x/c_R = .95$	
	$C_{p,u}$	$C_{p,l}$	$C_{p,u}$	$C_{p,l}$	$C_{p,u}$	$C_{p,l}$	$C_{p,u}$	$C_{p,l}$	$C_{p,u}$	$C_{p,l}$
0.050	-0.1940	-0.1512	-0.0111	*****	*****	*****	*****	*****	*****	*****
0.100	-0.1993	-0.1566	-0.0235	*****	*****	*****	*****	*****	*****	*****
0.150	-0.2106	-0.1578	-0.0375	*****	*****	*****	*****	*****	*****	*****
0.200	-0.2174	-0.1647	-0.0591	*****	*****	*****	*****	*****	*****	*****
0.250	*****	-0.1684	-0.0688	-0.1820	-0.2713	*****	*****	*****	*****	*****
0.300	-0.2326	-0.1723	-0.0934	-0.1784	-0.2299	*****	*****	*****	*****	*****
0.350	-0.2490	-0.1795	-0.1118	-0.1584	-0.2186	*****	*****	*****	*****	*****
0.400	-0.2620	-0.1885	-0.1122	-0.1494	-0.2415	*****	*****	*****	*****	*****
0.450	-0.2905	-0.2291	-0.1105	-0.1512	-0.2997	*****	*****	*****	*****	*****
0.500	-0.3066	-0.2240	-0.1293	-0.1489	-0.3440	*****	*****	*****	*****	*****
0.525	*****	-0.2228	-0.1290	-0.1499	-0.3660	*****	*****	*****	*****	*****
0.550	-0.3225	-0.2213	-0.1370	-0.1447	-0.3812	*****	*****	*****	*****	*****
0.575	*****	-0.2200	-0.1338	-0.1394	-0.3967	*****	*****	*****	*****	*****
0.600	-0.3165	-0.2188	-0.1361	-0.1262	-0.4012	*****	*****	*****	*****	*****
0.625	*****	*****	-0.1272	-0.1142	-0.4001	*****	*****	*****	*****	*****
0.650	-0.2889	-0.2199	-0.1228	-0.1021	-0.3891	*****	*****	*****	*****	*****
0.675	*****	-0.2306	-0.1026	-0.1042	-0.4075	*****	*****	*****	*****	*****
0.700	-0.2452	-0.2261	-0.0886	-0.1677	-0.5203	*****	*****	*****	*****	*****
0.725	*****	-0.2338	*****	-0.3674	-0.7132	*****	*****	*****	*****	*****
0.750	-0.4145	-0.3371	*****	-0.6769	-0.8917	*****	*****	*****	*****	*****
0.775	*****	-0.5983	-0.8853	-0.9315	-0.9283	*****	*****	*****	*****	*****
0.800	-0.7468	-0.8390	-1.0699	-1.0255	*****	*****	*****	*****	*****	*****
0.825	*****	-0.9786	-1.0886	-0.9756	-0.5379	*****	*****	*****	*****	*****
0.850	-0.8358	-1.0069	-1.0241	-0.7506	-0.5335	*****	*****	*****	*****	*****
0.875	*****	-1.0010	-0.8673	-0.6747	-0.4989	*****	*****	*****	*****	*****
0.900	-0.7213	-0.9626	-0.7852	-0.6526	*****	*****	*****	*****	*****	*****
0.925	*****	-0.9248	-0.7535	-0.5964	-0.4748	*****	*****	*****	*****	*****
0.950	-0.7494	-0.9020	-0.7178	-0.5904	-0.4090	*****	*****	*****	*****	*****
0.975	*****	-0.8884	-0.6973	-0.5793	-0.3577	*****	*****	*****	*****	*****
-0.200	$C_{p,l}$	0.1706	0.1627	0.1877	*****	*****	*****	*****	*****	*****
-0.400	$C_{p,l}$	0.1568	0.1680	0.1549	0.0171	-0.3613	*****	*****	*****	*****
-0.600	$C_{p,l}$	*****	0.1766	0.1500	0.0384	-0.3403	*****	*****	*****	*****
-0.700	$C_{p,l}$	*****	0.1738	0.1550	0.0552	-0.3488	*****	*****	*****	*****
-0.800	$C_{p,l}$	0.2332	0.1947	0.1613	0.0767	-0.3911	*****	*****	*****	*****
-0.850	$C_{p,l}$	0.2418	0.1988	0.1771	0.0883	-0.4353	*****	*****	*****	*****
-0.900	$C_{p,l}$	0.2439	0.2315	0.2048	0.1183	-0.4824	*****	*****	*****	*****
-0.950	$C_{p,l}$	*****	*****	0.2175	0.1655	-0.1685	*****	*****	*****	*****
-0.975	$C_{p,l}$	*****	0.1611	0.1785	0.1584	0.0012	*****	*****	*****	*****

Sharp Radius L.E.
 Run No. = 85, Point No. = 1854
 $C_N = 0.385$, $C_m = -0.0647$
 $\alpha = 9.3^\circ$, $M_\infty = 0.599$
 $R_{mac} = 6.0 \times 10^6$

Surface Pressures Near Leading Edge

● / ◆ upper, starboard/port
 ○ / ◇ lower, starboard/port

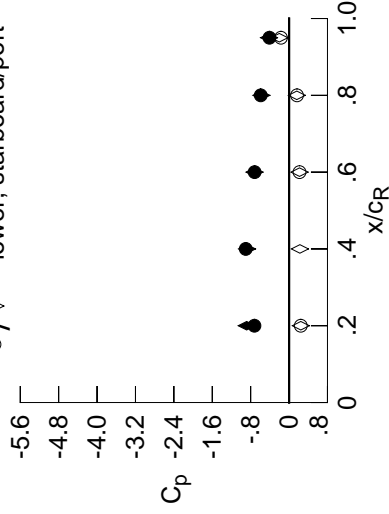

x/c_R	η	starb'd	port	starb'd	port
		$C_{p,u}$	$C_{p,l}$	$C_{p,u}$	$C_{p,l}$
0.20	0.90	-0.7213	-0.8829	0.2447	0.2439
0.40	0.95	-0.9020	-0.8753	0.2255	*****
0.60	0.95	-0.7178	-0.7206	0.2177	0.2175
0.80	0.95	-0.5904	-0.5768	0.1615	0.1655
0.95	0.95	-0.4090	-0.4174	-0.2031	-0.1685

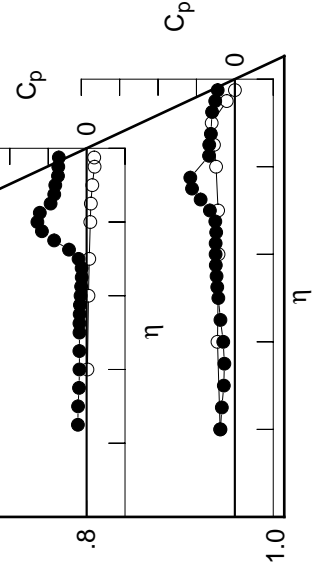

Table D2. Continued.

η	$x/c_R = .2$		$x/c_R = .4$		$x/c_R = .6$		$x/c_R = .8$		$x/c_R = .95$	
	$C_{p,u}$	$C_{p,l}$	$C_{p,u}$	$C_{p,l}$	$C_{p,u}$	$C_{p,l}$	$C_{p,u}$	$C_{p,l}$	$C_{p,u}$	$C_{p,l}$
0.050	-0.2136	-0.1747	-0.0247	*****	*****	*****	*****	*****	*****	*****
0.100	-0.2202	-0.1735	-0.0418	*****	*****	*****	*****	*****	*****	*****
0.150	-0.2353	-0.1822	-0.0532	*****	*****	*****	*****	*****	*****	*****
0.200	-0.2360	-0.1789	-0.0707	*****	*****	*****	*****	*****	*****	*****
0.250	*****	-0.1884	-0.0857	-0.1920	-0.2381	*****	*****	*****	*****	*****
0.300	-0.2567	-0.1920	-0.1002	-0.1783	-0.2256	*****	*****	*****	*****	*****
0.350	-0.2724	-0.1973	-0.1262	-0.1667	-0.2207	*****	*****	*****	*****	*****
0.400	-0.2884	-0.2021	-0.1207	-0.1559	-0.2635	*****	*****	*****	*****	*****
0.450	-0.3139	-0.2324	-0.1267	-0.1523	-0.3206	*****	*****	*****	*****	*****
0.500	-0.3288	-0.2471	-0.1381	-0.1527	-0.3636	*****	*****	*****	*****	*****
0.525	*****	-0.2434	-0.1380	-0.1451	-0.3756	*****	*****	*****	*****	*****
0.550	-0.3384	-0.2470	-0.1398	-0.1456	-0.3914	*****	*****	*****	*****	*****
0.575	*****	-0.2346	-0.1351	-0.1327	-0.3919	*****	*****	*****	*****	*****
0.600	-0.3198	-0.2308	-0.1350	-0.1256	-0.4040	*****	*****	*****	*****	*****
0.625	*****	*****	-0.1134	-0.1254	-0.4113	*****	*****	*****	*****	*****
0.650	-0.2610	-0.2012	-0.1172	-0.1466	-0.4579	*****	*****	*****	*****	*****
0.675	*****	-0.1891	-0.1203	-0.2336	-0.5677	*****	*****	*****	*****	*****
0.700	-0.2802	-0.2095	-0.2203	-0.4281	-0.7358	*****	*****	*****	*****	*****
0.725	*****	-0.3876	*****	-0.6891	-0.8838	*****	*****	*****	*****	*****
0.750	-0.7156	-0.7425	*****	-0.9386	-0.9314	*****	*****	*****	*****	*****
0.775	*****	-1.0482	-1.1205	-1.0574	-0.8023	*****	*****	*****	*****	*****
0.800	-0.9710	-1.1796	-1.2486	-0.9736	*****	*****	*****	*****	*****	*****
0.825	*****	-1.1810	-1.2337	-0.7507	-0.4768	*****	*****	*****	*****	*****
0.850	-0.9566	-1.1311	-1.0718	-0.6973	-0.4688	*****	*****	*****	*****	*****
0.875	*****	-1.0671	-0.8415	-0.6961	-0.4597	*****	*****	*****	*****	*****
0.900	-0.8190	-0.9992	-0.8136	-0.6574	*****	*****	*****	*****	*****	*****
0.925	*****	-0.9637	-0.7853	-0.6290	-0.4258	*****	*****	*****	*****	*****
0.950	-0.8719	-0.9412	-0.7404	-0.6233	-0.3628	*****	*****	*****	*****	*****
0.975	*****	-0.9297	-0.7116	-0.6119	-0.3156	*****	*****	*****	*****	*****
-0.200	$C_{p,l}$	0.1978	0.1787	0.1975	*****	*****	*****	*****	*****	*****
-0.400	*****	0.1852	0.1920	0.1749	0.0216	-0.3681	*****	*****	*****	*****
-0.600	*****	*****	0.1997	0.1623	0.0530	-0.3570	*****	*****	*****	*****
-0.700	*****	*****	0.1993	0.1775	0.0626	-0.3877	*****	*****	*****	*****
-0.800	*****	0.2561	0.2193	0.1807	0.0914	-0.4239	*****	*****	*****	*****
-0.850	*****	0.2572	0.2222	0.1955	0.1028	-0.4617	*****	*****	*****	*****
-0.900	*****	0.2518	0.2478	0.2199	0.1333	-0.4901	*****	*****	*****	*****
-0.950	*****	*****	*****	0.2209	0.1723	-0.1625	*****	*****	*****	*****
-0.975	*****	*****	0.1475	0.1740	0.1546	0.0051	*****	*****	*****	*****

Sharp Radius L.E.
 Run No. = 85 , Point No. = 1855
 $C_N = 0.432$, $C_m = -0.0695$
 $\alpha = 10.4^\circ$, $M_\infty = 0.599$
 $R_{mac} = 6.0 \times 10^6$

Surface Pressures Near Leading Edge

● / ◆ upper, starboard/port
 ○ / ◇ lower, starboard/port

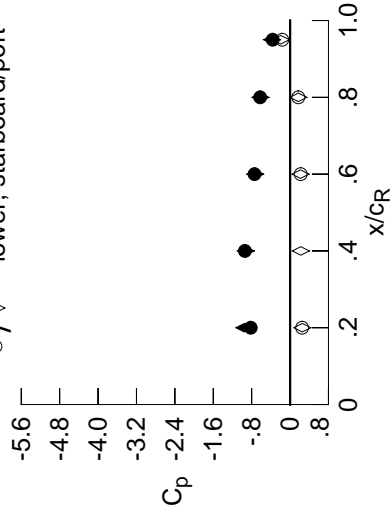

x/c_R	η	starb'd	port	starb'd	port
		$C_{p,u}$	$C_{p,l}$	$C_{p,u}$	$C_{p,l}$
0.20	0.90	-0.8190	-0.9536	0.2552	0.2518
0.40	0.95	-0.9412	-0.9226	0.2241	*****
0.60	0.95	-0.7404	-0.7275	0.2171	0.2209
0.80	0.95	-0.6233	-0.6173	0.1726	0.1723
0.95	0.95	-0.3628	-0.3766	-0.1935	-0.1625

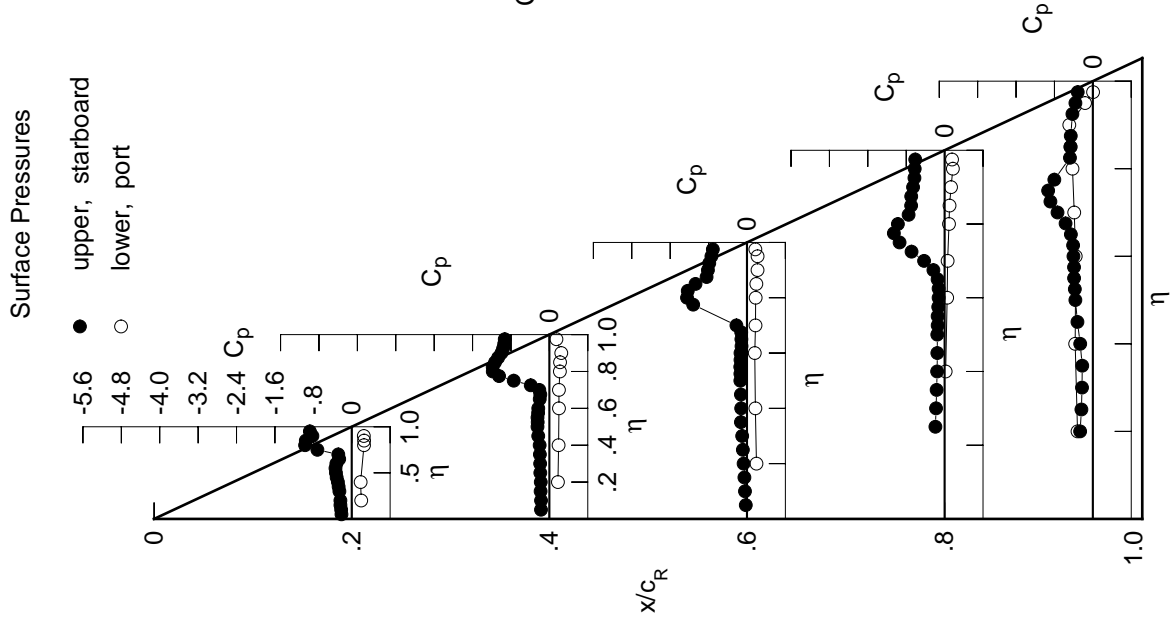

Table D2. Continued.

η	$x/c_R = .2$		$x/c_R = .4$		$x/c_R = .6$		$x/c_R = .8$		$x/c_R = .95$	
	$C_{p,u}$	$C_{p,l}$	$C_{p,u}$	$C_{p,l}$	$C_{p,u}$	$C_{p,l}$	$C_{p,u}$	$C_{p,l}$	$C_{p,u}$	$C_{p,l}$
0.050	-0.2401	-0.1975	-0.0380	*****	*****	*****	*****	*****	*****	*****
0.100	-0.2428	-0.1976	-0.0560	*****	*****	*****	*****	*****	*****	*****
0.150	-0.2575	-0.2014	-0.0664	*****	*****	*****	*****	*****	*****	*****
0.200	-0.2664	-0.2028	-0.0846	*****	*****	*****	*****	*****	*****	*****
0.250	*****	-0.2117	-0.0965	-0.1947	-0.2050	*****	*****	*****	*****	*****
0.300	-0.2820	-0.2114	-0.1114	-0.1813	-0.2374	*****	*****	*****	*****	*****
0.350	-0.2975	-0.2161	-0.1321	-0.1718	-0.2634	*****	*****	*****	*****	*****
0.400	-0.3115	-0.2175	-0.1351	-0.1614	-0.3045	*****	*****	*****	*****	*****
0.450	-0.3395	-0.2372	-0.1353	-0.1598	-0.3509	*****	*****	*****	*****	*****
0.500	-0.3505	-0.2471	-0.1474	-0.1516	-0.3766	*****	*****	*****	*****	*****
0.525	*****	-0.2507	-0.1440	-0.1472	-0.3880	*****	*****	*****	*****	*****
0.550	-0.3510	-0.2440	-0.1472	-0.1455	-0.3919	*****	*****	*****	*****	*****
0.575	*****	-0.2332	-0.1377	-0.1432	-0.4026	*****	*****	*****	*****	*****
0.600	-0.3073	-0.2121	-0.1378	-0.1580	-0.4287	*****	*****	*****	*****	*****
0.625	*****	*****	-0.1344	-0.2033	-0.4921	*****	*****	*****	*****	*****
0.650	-0.2388	-0.1912	-0.1748	-0.3150	-0.6003	*****	*****	*****	*****	*****
0.675	*****	-0.3014	-0.2847	-0.5100	-0.7402	*****	*****	*****	*****	*****
0.700	-0.4719	-0.5956	-0.5162	-0.7506	-0.8888	*****	*****	*****	*****	*****
0.725	*****	-0.9541	*****	-0.9608	-0.9544	*****	*****	*****	*****	*****
0.750	-0.9989	-1.1987	*****	-1.0754	-0.8830	*****	*****	*****	*****	*****
0.775	*****	-1.3114	-1.3011	-1.0330	-0.6299	*****	*****	*****	*****	*****
0.800	-1.1404	-1.3146	-1.3376	-0.8350	*****	*****	*****	*****	*****	*****
0.825	*****	-1.2608	-1.1206	-0.7191	-0.4417	*****	*****	*****	*****	*****
0.850	-1.0723	-1.1780	-0.8984	-0.7152	-0.4300	*****	*****	*****	*****	*****
0.875	*****	-1.0948	-0.8383	-0.7161	-0.4339	*****	*****	*****	*****	*****
0.900	-0.9221	-1.10281	-0.8474	-0.6725	*****	*****	*****	*****	*****	*****
0.925	*****	-0.9945	-0.8065	-0.6485	-0.4023	*****	*****	*****	*****	*****
0.950	-0.9883	-0.9707	-0.7777	-0.6408	-0.3346	*****	*****	*****	*****	*****
0.975	*****	-0.9539	-0.7595	-0.6277	-0.2952	*****	*****	*****	*****	*****

η	$x/c_R = .2$		$x/c_R = .4$		$x/c_R = .6$		$x/c_R = .8$		$x/c_R = .95$	
	$C_{p,u}$	$C_{p,l}$	$C_{p,u}$	$C_{p,l}$	$C_{p,u}$	$C_{p,l}$	$C_{p,u}$	$C_{p,l}$	$C_{p,u}$	$C_{p,l}$
-0.200	0.2192	0.2049	0.2185	*****	*****	*****	*****	*****	*****	*****
-0.400	0.2100	0.2081	0.1880	0.0353	-0.3621	*****	*****	*****	*****	*****
-0.600	*****	0.2223	0.1834	0.0646	-0.3668	*****	*****	*****	*****	*****
-0.700	*****	0.2203	0.1937	0.0797	-0.4093	*****	*****	*****	*****	*****
-0.800	0.2749	0.2408	0.1987	0.1064	-0.4478	*****	*****	*****	*****	*****
-0.850	0.2730	0.2406	0.2136	0.1185	-0.4744	*****	*****	*****	*****	*****
-0.900	0.2608	0.2625	0.2337	0.1476	-0.4905	*****	*****	*****	*****	*****
-0.950	*****	*****	0.2241	0.1800	-0.1578	*****	*****	*****	*****	*****
-0.975	*****	0.1398	0.1622	0.1520	0.0047	*****	*****	*****	*****	*****

Sharp Radius L.E.
 Run No. = 85, Point No. = 1856
 $C_N = 0.479$, $C_m = -0.0737$
 $\alpha = 11.4^\circ$, $M_\infty = 0.599$
 $R_{mac} = 6.0 \times 10^6$

Surface Pressures Near Leading Edge

● / ◆ upper, starboard/port
 ○ / ◇ lower, starboard/port

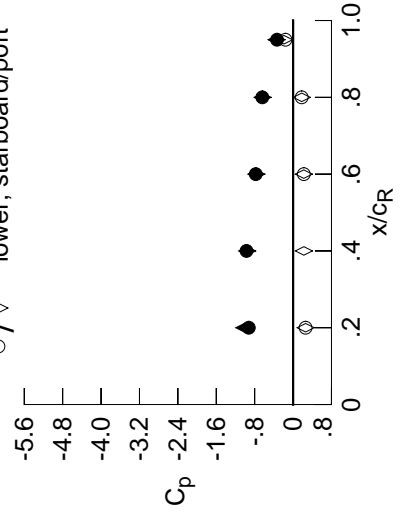

x/c_R	η	starb'd	port	starb'd	port
		$C_{p,u}$	$C_{p,l}$	$C_{p,u}$	$C_{p,l}$
0.20	0.90	-0.9221	-1.0167	0.2618	0.2608
0.40	0.95	-0.9707	-0.9560	0.2248	*****
0.60	0.95	-0.7777	-0.7659	0.2230	0.2241
0.80	0.95	-0.6408	-0.6348	0.1812	0.1800
0.95	0.95	-0.3346	-0.3446	-0.1892	-0.1578

Table D2. Continued.

η	$x/c_R = .2$		$x/c_R = .4$		$x/c_R = .6$		$x/c_R = .8$		$x/c_R = .95$	
	$C_{p,u}$	$C_{p,l}$	$C_{p,u}$	$C_{p,l}$	$C_{p,u}$	$C_{p,l}$	$C_{p,u}$	$C_{p,l}$	$C_{p,u}$	$C_{p,l}$
0.050	-0.2657	-0.2187	-0.0557	*****	*****	*****	*****	*****	*****	*****
0.100	-0.2685	-0.2231	-0.0732	*****	*****	*****	*****	*****	*****	*****
0.150	-0.2838	-0.2251	-0.0837	*****	*****	*****	*****	*****	*****	*****
0.200	-0.2901	-0.2287	-0.1016	*****	*****	*****	*****	*****	*****	*****
0.250	*****	-0.2331	-0.1139	-0.2005	-0.1717	*****	*****	*****	*****	*****
0.300	-0.3081	-0.2375	-0.1246	-0.1832	-0.2424	*****	*****	*****	*****	*****
0.350	-0.3241	-0.2384	-0.1399	-0.1779	-0.2878	*****	*****	*****	*****	*****
0.400	-0.3374	-0.2425	-0.1485	-0.1638	-0.3359	*****	*****	*****	*****	*****
0.450	-0.3618	-0.2394	-0.1453	-0.1608	-0.3735	*****	*****	*****	*****	*****
0.500	-0.3661	-0.2440	-0.1597	-0.1537	-0.3900	*****	*****	*****	*****	*****
0.525	*****	-0.2439	-0.1582	-0.1559	-0.4001	*****	*****	*****	*****	*****
0.550	-0.3529	-0.2391	-0.1570	-0.1647	-0.4096	*****	*****	*****	*****	*****
0.575	*****	-0.2248	-0.1537	-0.1894	-0.4383	*****	*****	*****	*****	*****
0.600	-0.2837	-0.2141	-0.1737	-0.2479	-0.5002	*****	*****	*****	*****	*****
0.625	*****	*****	-0.2053	-0.3649	-0.6086	*****	*****	*****	*****	*****
0.650	-0.2808	-0.3814	-0.3322	-0.5477	-0.7500	*****	*****	*****	*****	*****
0.675	*****	-0.6877	-0.5388	-0.7752	-0.8859	*****	*****	*****	*****	*****
0.700	-0.7907	-1.0453	-0.8247	-0.9992	-0.9816	*****	*****	*****	*****	*****
0.725	*****	-1.3074	*****	-1.1244	-0.9364	*****	*****	*****	*****	*****
0.750	-1.2338	-1.4255	*****	-1.1146	-0.6962	*****	*****	*****	*****	*****
0.775	*****	-1.4479	-1.3848	-0.9438	-0.4724	*****	*****	*****	*****	*****
0.800	-1.2931	-1.4078	-1.1621	-0.7714	*****	*****	*****	*****	*****	*****
0.825	*****	-1.3266	-0.9123	-0.7304	-0.4289	*****	*****	*****	*****	*****
0.850	-1.1860	-1.2183	-0.8843	-0.7396	-0.4135	*****	*****	*****	*****	*****
0.875	*****	-1.1202	-0.8621	-0.7369	-0.4261	*****	*****	*****	*****	*****
0.900	-1.0313	-1.0607	-0.8625	-0.6910	*****	*****	*****	*****	*****	*****
0.925	*****	-1.0314	-0.8392	-0.6628	-0.3925	*****	*****	*****	*****	*****
0.950	-1.0926	-1.0062	-0.8401	-0.6551	-0.3222	*****	*****	*****	*****	*****
0.975	*****	-0.9901	-0.8268	-0.6409	-0.2827	*****	*****	*****	*****	*****
-0.200	0.2461	0.2247	0.2302	*****	-0.3540	*****	*****	*****	*****	*****
-0.400	0.2386	0.2330	0.2051	0.0471	-0.3638	*****	*****	*****	*****	*****
-0.600	*****	0.2426	0.1987	0.0765	-0.3796	*****	*****	*****	*****	*****
-0.700	*****	0.2448	0.2125	0.0913	-0.4387	*****	*****	*****	*****	*****
-0.800	0.2940	0.2623	0.2174	0.1230	-0.4642	*****	*****	*****	*****	*****
-0.850	0.2880	0.2587	0.2301	0.1340	-0.4821	*****	*****	*****	*****	*****
-0.900	0.2665	0.2739	0.2455	0.1615	-0.4845	*****	*****	*****	*****	*****
-0.950	*****	*****	0.2216	0.1863	-0.1488	*****	*****	*****	*****	*****
-0.975	*****	0.1246	0.1449	0.1460	0.0056	*****	*****	*****	*****	*****

Sharp Radius L.E.
 Run No. = 85, Point No. = 1857
 $C_N = 0.533$, $C_m = -0.0814$
 $\alpha = 12.4^\circ$, $M_\infty = 0.599$
 $R_{mac} = 6.0 \times 10^6$

Surface Pressures Near Leading Edge

● / ◆ upper, starboard/port
 ○ / ◇ lower, starboard/port

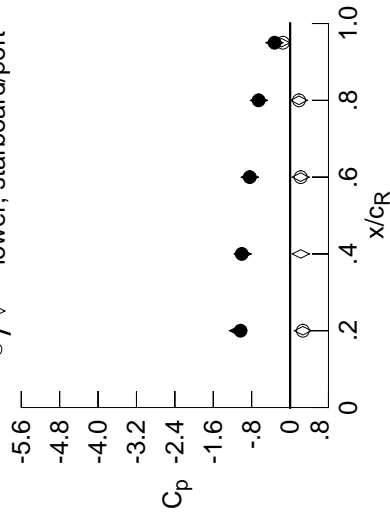

x/c_R	η	starb'd	port	starb'd	port
		$C_{p,u}$	$C_{p,l}$	$C_{p,u}$	$C_{p,l}$
0.20	0.90	-1.0313	-1.0840	0.2666	0.2665
0.40	0.95	-1.0062	-0.9888	0.2224	*****
0.60	0.95	-0.8401	-0.8396	0.2187	0.2216
0.80	0.95	-0.6551	-0.6485	0.1853	0.1863
0.95	0.95	-0.3222	-0.3278	-0.1809	-0.1488

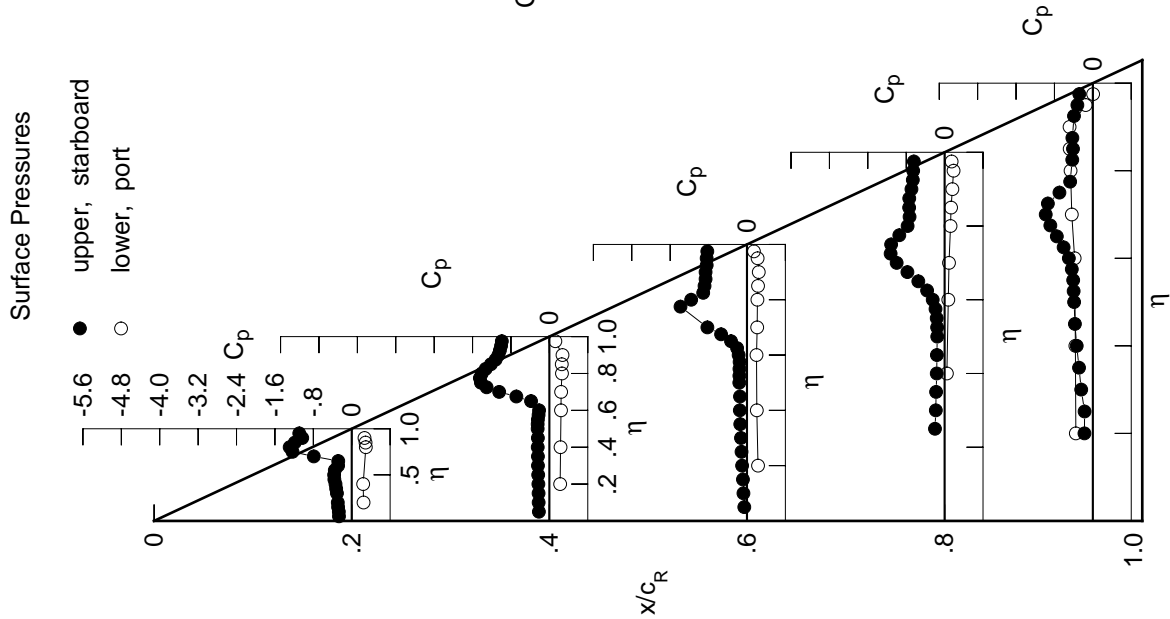

Table D2. Continued.

η	$x/c_R = .2$		$x/c_R = .4$		$x/c_R = .6$		$x/c_R = .8$		$x/c_R = .95$	
	$C_{p,u}$	$C_{p,l}$	$C_{p,u}$	$C_{p,l}$	$C_{p,u}$	$C_{p,l}$	$C_{p,u}$	$C_{p,l}$	$C_{p,u}$	$C_{p,l}$
0.050	-0.2962	-0.2437	-0.0711	*****	*****	*****	*****	*****	*****	*****
0.100	-0.2983	-0.2477	-0.0924	*****	*****	*****	*****	*****	*****	*****
0.150	-0.3127	-0.2539	-0.0974	*****	*****	*****	*****	*****	*****	*****
0.200	-0.3209	-0.2529	-0.1193	*****	*****	*****	*****	*****	*****	*****
0.250	*****	-0.2619	-0.1296	-0.2086	-0.1607	*****	*****	*****	*****	*****
0.300	-0.3359	-0.2587	-0.1467	-0.1893	-0.2320	*****	*****	*****	*****	*****
0.350	-0.3513	-0.2659	-0.1571	-0.1815	-0.2894	*****	*****	*****	*****	*****
0.400	-0.3636	-0.2628	-0.1631	-0.1673	-0.3401	*****	*****	*****	*****	*****
0.450	-0.3839	-0.2654	-0.1637	-0.1667	-0.3811	*****	*****	*****	*****	*****
0.500	-0.3804	-0.2515	-0.1752	-0.1645	-0.4000	*****	*****	*****	*****	*****
0.525	*****	-0.2491	-0.1802	-0.1791	-0.4186	*****	*****	*****	*****	*****
0.550	-0.3513	-0.2383	-0.1891	-0.2004	-0.4419	*****	*****	*****	*****	*****
0.575	*****	-0.2323	-0.2061	-0.2615	-0.4928	*****	*****	*****	*****	*****
0.600	-0.2776	-0.2576	-0.2609	-0.3621	-0.5870	*****	*****	*****	*****	*****
0.625	*****	*****	-0.3471	-0.5262	-0.7211	*****	*****	*****	*****	*****
0.650	-0.4366	-0.6067	-0.5444	-0.7414	-0.8684	*****	*****	*****	*****	*****
0.675	*****	-0.9736	-0.8053	-0.9746	-0.9643	*****	*****	*****	*****	*****
0.700	-1.0886	-1.3006	-1.0839	-1.1590	-0.9851	*****	*****	*****	*****	*****
0.725	*****	-1.5192	*****	-1.2141	-0.8164	*****	*****	*****	*****	*****
0.750	-1.4166	-1.5993	*****	-1.1098	-0.5353	*****	*****	*****	*****	*****
0.775	*****	-1.5992	-1.2778	-0.8891	-0.4469	*****	*****	*****	*****	*****
0.800	-1.4322	-1.5406	-1.0009	-0.7793	*****	*****	*****	*****	*****	*****
0.825	*****	-1.4294	-0.9235	-0.7573	-0.4267	*****	*****	*****	*****	*****
0.850	-1.3003	-1.2777	-0.9282	-0.7649	-0.4102	*****	*****	*****	*****	*****
0.875	*****	-1.1702	-0.9044	-0.7634	-0.4168	*****	*****	*****	*****	*****
0.900	-1.1359	-1.1208	-0.8940	-0.7133	*****	*****	*****	*****	*****	*****
0.925	*****	-1.0910	-0.8994	-0.6781	-0.3893	*****	*****	*****	*****	*****
0.950	-1.1785	-1.0494	-0.8943	-0.6742	-0.3141	*****	*****	*****	*****	*****
0.975	*****	-1.0238	-0.8753	-0.6608	-0.2772	*****	*****	*****	*****	*****

η	$x/c_R = .2$		$x/c_R = .4$		$x/c_R = .6$		$x/c_R = .8$		$x/c_R = .95$	
	$C_{p,u}$	$C_{p,l}$	$C_{p,u}$	$C_{p,l}$	$C_{p,u}$	$C_{p,l}$	$C_{p,u}$	$C_{p,l}$	$C_{p,u}$	$C_{p,l}$
-0.200	0.2722	0.2464	0.2522	*****	*****	*****	*****	*****	*****	*****
-0.400	0.2645	0.2558	0.2206	0.0597	-0.3722	*****	*****	*****	*****	*****
-0.600	*****	0.2646	0.2180	0.0871	-0.4050	*****	*****	*****	*****	*****
-0.700	*****	0.2687	0.2272	0.1051	-0.4615	*****	*****	*****	*****	*****
-0.800	0.3107	0.2820	0.2341	0.1341	-0.4788	*****	*****	*****	*****	*****
-0.850	0.2986	0.2744	0.2456	0.1479	-0.4872	*****	*****	*****	*****	*****
-0.900	0.2707	0.2835	0.2567	0.1734	-0.4791	*****	*****	*****	*****	*****
-0.950	*****	*****	0.2195	0.1881	-0.1406	*****	*****	*****	*****	*****
-0.975	*****	0.1074	0.1296	0.1389	0.0061	*****	*****	*****	*****	*****

Sharp Radius L.E.
 Run No. = 85 , Point No. = 1858
 $C_N = 0.586$, $C_m = -0.0902$
 $\alpha = 13.4^\circ$, $M_\infty = 0.599$
 $R_{mac} = 6.0 \times 10^6$

Surface Pressures Near Leading Edge

● / ◆ upper, starboard/port
 ○ / ◇ lower, starboard/port

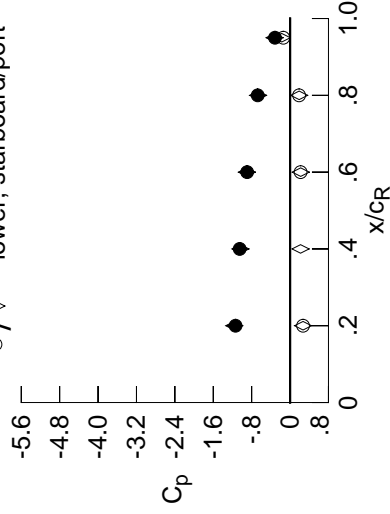

x/c_R	η	starb'd	port	starb'd	port
		$C_{p,u}$	$C_{p,l}$	$C_{p,u}$	$C_{p,l}$
0.20	0.90	-1.1359	-1.1633	0.2701	0.2707
0.40	0.95	-1.0494	-1.0345	0.2182	*****
0.60	0.95	-0.8943	-0.8997	0.2214	0.2195
0.80	0.95	-0.6742	-0.6664	0.1895	0.1881
0.95	0.95	-0.3141	-0.3234	-0.1731	-0.1406

Table D2. Continued.

η	$x/c_R = .2$		$x/c_R = .4$		$x/c_R = .6$		$x/c_R = .8$		$x/c_R = .95$	
	$C_{p,u}$	$C_{p,l}$	$C_{p,u}$	$C_{p,l}$	$C_{p,u}$	$C_{p,l}$	$C_{p,u}$	$C_{p,l}$	$C_{p,u}$	$C_{p,l}$
0.050	-0.3257	-0.2760	-0.0929	*****	*****	*****	*****	*****	*****	*****
0.100	-0.3279	-0.2759	-0.1084	*****	*****	*****	*****	*****	*****	*****
0.150	-0.3442	-0.2821	-0.1190	*****	*****	*****	*****	*****	*****	*****
0.200	-0.3504	-0.2824	-0.1376	*****	*****	*****	*****	*****	*****	*****
0.250	*****	-0.2890	-0.1527	-0.2201	-0.1575	*****	*****	*****	*****	*****
0.300	-0.3680	-0.2906	-0.1660	-0.2009	-0.2323	*****	*****	*****	*****	*****
0.350	-0.3829	-0.2928	-0.1789	-0.1916	-0.2924	*****	*****	*****	*****	*****
0.400	-0.3906	-0.2945	-0.1844	-0.1796	-0.3478	*****	*****	*****	*****	*****
0.450	-0.4065	-0.2897	-0.1869	-0.1780	-0.3875	*****	*****	*****	*****	*****
0.500	-0.3917	-0.2736	-0.2089	-0.1960	-0.4185	*****	*****	*****	*****	*****
0.525	*****	-0.2720	-0.2207	-0.2180	-0.4439	*****	*****	*****	*****	*****
0.550	-0.3501	-0.2696	-0.2508	-0.2691	-0.4875	*****	*****	*****	*****	*****
0.575	*****	-0.2845	-0.2927	-0.3567	-0.5652	*****	*****	*****	*****	*****
0.600	-0.3168	-0.3482	-0.4061	-0.4945	-0.6792	*****	*****	*****	*****	*****
0.625	*****	*****	-0.5423	-0.6856	-0.8245	*****	*****	*****	*****	*****
0.650	-0.7104	-0.8301	-0.7946	-0.9140	-0.9486	*****	*****	*****	*****	*****
0.675	*****	-1.1992	-1.0597	-1.1332	-0.9855	*****	*****	*****	*****	*****
0.700	-1.3588	-1.5099	-1.2998	-1.2752	-0.9058	*****	*****	*****	*****	*****
0.725	*****	-1.7069	*****	-1.2557	-0.6599	*****	*****	*****	*****	*****
0.750	-1.5800	-1.7694	*****	-1.0802	-0.4633	*****	*****	*****	*****	*****
0.775	*****	-1.7460	-1.1686	-0.8597	-0.4521	*****	*****	*****	*****	*****
0.800	-1.5534	-1.6606	-1.0029	-0.7984	*****	*****	*****	*****	*****	*****
0.825	*****	-1.4844	-0.9797	-0.7808	-0.4357	*****	*****	*****	*****	*****
0.850	-1.4022	-1.3036	-0.9897	-0.7895	-0.4102	*****	*****	*****	*****	*****
0.875	*****	-1.2252	-0.9530	-0.7884	-0.4147	*****	*****	*****	*****	*****
0.900	-1.2347	-1.1893	-0.9501	-0.7359	*****	*****	*****	*****	*****	*****
0.925	*****	-1.1547	-0.9461	-0.6988	-0.3881	*****	*****	*****	*****	*****
0.950	-1.2576	-1.1037	-0.9346	-0.6862	-0.3101	*****	*****	*****	*****	*****
0.975	*****	-1.0682	-0.9153	-0.6734	-0.2721	*****	*****	*****	*****	*****
-0.200	$C_{p,l}$	0.2982	0.2675	0.2638	*****	*****	*****	*****	*****	*****
-0.400	$C_{p,l}$	0.2904	0.2752	0.2387	0.0686	-0.3873	*****	*****	*****	*****
-0.600	$C_{p,l}$	*****	0.2860	0.2328	0.1027	-0.4309	*****	*****	*****	*****
-0.700	$C_{p,l}$	*****	0.2888	0.2457	0.1138	-0.4869	*****	*****	*****	*****
-0.800	$C_{p,l}$	0.3277	0.2969	0.2493	0.1472	-0.4884	*****	*****	*****	*****
-0.850	$C_{p,l}$	0.3066	0.2858	0.2597	0.1595	-0.4907	*****	*****	*****	*****
-0.900	$C_{p,l}$	0.2710	0.2848	0.2643	0.1829	-0.4722	*****	*****	*****	*****
-0.950	$C_{p,l}$	*****	*****	0.2148	0.1894	-0.1339	*****	*****	*****	*****
-0.975	$C_{p,l}$	*****	0.0828	0.1130	0.1283	0.0054	*****	*****	*****	*****

Sharp Radius L.E.

Run No. = 85 , Point No. = 1859

$C_N = 0.637$, $C_m = -0.0948$

$\alpha = 14.5^\circ$, $M_\infty = 0.599$

$R_{mac} = 6.0 \times 10^6$

Surface Pressures Near Leading Edge

● / ◆ upper, starboard/port
○ / ◇ lower, starboard/port

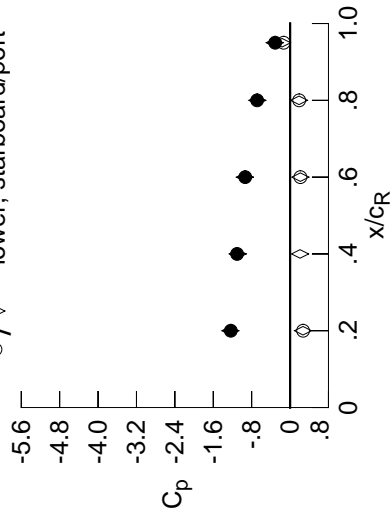

x/c_R	η	starb'd	port	starb'd	port
		$C_{p,u}$	$C_{p,l}$	$C_{p,u}$	$C_{p,l}$
0.20	0.90	-1.2347	-1.2451	0.2695	0.2710
0.40	0.95	-1.1037	-1.0911	0.2076	*****
0.60	0.95	-0.9346	-0.9425	0.2147	0.2148
0.80	0.95	-0.6862	-0.6834	0.1871	0.1894
0.95	0.95	-0.3101	-0.3205	-0.1666	-0.1339

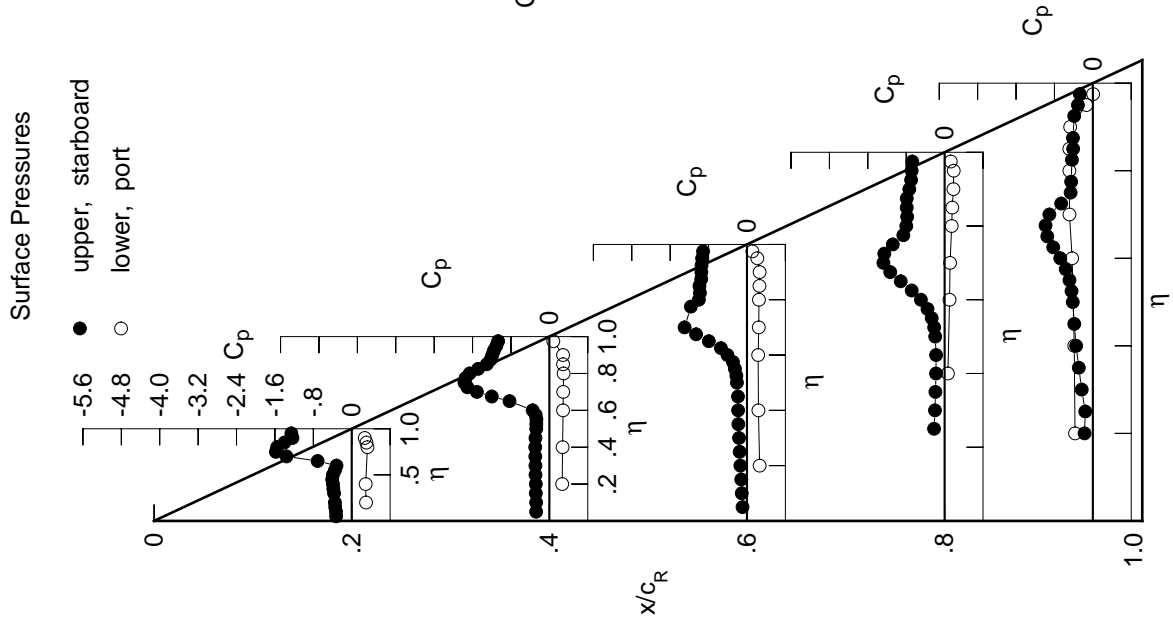

Table D2. Continued.

η	$x/c_R = .2$		$x/c_R = .4$		$x/c_R = .6$		$x/c_R = .8$		$x/c_R = .95$	
	$C_{p,u}$	$C_{p,u}$	$C_{p,u}$	$C_{p,u}$	$C_{p,u}$	$C_{p,u}$	$C_{p,u}$	$C_{p,u}$	$C_{p,u}$	$C_{p,u}$
0.050	-0.3542	-0.3019	-0.1124	*****	*****	*****	*****	*****	*****	*****
0.100	-0.3573	-0.3048	-0.1235	*****	*****	*****	*****	*****	*****	*****
0.150	-0.3743	-0.3076	-0.1413	*****	*****	*****	*****	*****	*****	*****
0.200	-0.3798	-0.3082	-0.1536	*****	*****	*****	*****	*****	*****	*****
0.250	*****	-0.3131	-0.1685	-0.2269	-0.1620	*****	*****	*****	*****	*****
0.300	-0.3966	-0.3181	-0.1873	-0.2096	-0.2352	*****	*****	*****	*****	*****
0.350	-0.4097	-0.3151	-0.1955	-0.1996	-0.2967	*****	*****	*****	*****	*****
0.400	-0.4145	-0.3181	-0.2059	-0.1893	-0.3468	*****	*****	*****	*****	*****
0.450	-0.4258	-0.3121	-0.2077	-0.1987	-0.3975	*****	*****	*****	*****	*****
0.500	-0.4003	-0.2995	-0.2528	-0.2302	-0.4363	*****	*****	*****	*****	*****
0.525	*****	-0.3087	-0.2763	-0.2773	-0.4835	*****	*****	*****	*****	*****
0.550	-0.3584	-0.3199	-0.3360	-0.3493	-0.5368	*****	*****	*****	*****	*****
0.575	*****	-0.3776	-0.4135	-0.4711	-0.6401	*****	*****	*****	*****	*****
0.600	-0.4289	-0.4923	-0.5820	-0.6298	-0.7626	*****	*****	*****	*****	*****
0.625	*****	*****	-0.7600	-0.8421	-0.8989	*****	*****	*****	*****	*****
0.650	-1.0126	-1.0638	-1.0334	-1.0677	-0.9784	*****	*****	*****	*****	*****
0.675	*****	-1.4171	-1.2812	-1.2625	-0.9388	*****	*****	*****	*****	*****
0.700	-1.5808	-1.6971	-1.4522	-1.3463	-0.7836	*****	*****	*****	*****	*****
0.725	*****	-1.8717	*****	-1.2591	-0.5275	*****	*****	*****	*****	*****
0.750	-1.7259	-1.9135	*****	-1.0333	-0.4583	*****	*****	*****	*****	*****
0.775	*****	-1.8483	-1.1293	-0.8519	-0.4585	*****	*****	*****	*****	*****
0.800	-1.6654	-1.6882	-1.0444	-0.8135	*****	*****	*****	*****	*****	*****
0.825	*****	-1.4494	-1.0320	-0.7997	-0.4405	*****	*****	*****	*****	*****
0.850	-1.4805	-1.3253	-1.0403	-0.8097	-0.4116	*****	*****	*****	*****	*****
0.875	*****	-1.2850	-0.9987	-0.8118	-0.4073	*****	*****	*****	*****	*****
0.900	-1.3216	-1.2638	-0.9948	-0.7561	*****	*****	*****	*****	*****	*****
0.925	*****	-1.2126	-0.9860	-0.7147	-0.3808	*****	*****	*****	*****	*****
0.950	-1.3297	-1.1595	-0.9691	-0.6967	-0.3058	*****	*****	*****	*****	*****
0.975	*****	-1.1174	-0.9509	-0.6863	-0.2700	*****	*****	*****	*****	*****

η	$C_{p,i}$		$C_{p,i}$		$C_{p,i}$		$C_{p,i}$		$C_{p,i}$	
	$C_{p,i}$	$C_{p,i}$	$C_{p,i}$	$C_{p,i}$	$C_{p,i}$	$C_{p,i}$	$C_{p,i}$	$C_{p,i}$	$C_{p,i}$	$C_{p,i}$
-0.200	0.3226	0.2849	0.2854	*****	*****	*****	*****	*****	*****	*****
-0.400	0.3159	0.2913	0.2537	0.0848	-0.3951	*****	*****	*****	*****	*****
-0.600	*****	0.3064	0.2553	0.1119	-0.4564	*****	*****	*****	*****	*****
-0.700	*****	0.3099	0.2614	0.1278	-0.5070	*****	*****	*****	*****	*****
-0.800	0.3425	0.3142	0.2668	0.1601	-0.4938	*****	*****	*****	*****	*****
-0.850	0.3172	0.2976	0.2750	0.1737	-0.4903	*****	*****	*****	*****	*****
-0.900	0.2731	0.2910	0.2748	0.1947	-0.4631	*****	*****	*****	*****	*****
-0.950	*****	*****	0.2118	0.1921	-0.1262	*****	*****	*****	*****	*****
-0.975	*****	0.0627	0.0975	0.1214	0.0065	*****	*****	*****	*****	*****

Sharp Radius L.E.
 Run No. = 85 , Point No. = 1860
 $C_N = 0.687$, $C_m = -0.0995$
 $\alpha = 15.5^\circ$, $M_\infty = 0.599$
 $R_{mac} = 6.0 \times 10^6$

Surface Pressures Near Leading Edge

● / ◆ upper, starboard/port
 ○ / ◇ lower, starboard/port

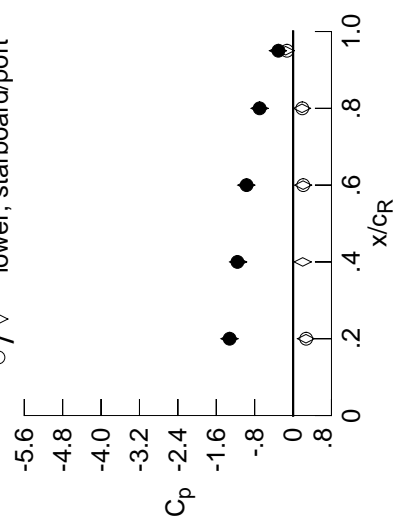

x/c_R	η	starb'd	port	starb'd	port
		$C_{p,u}$		$C_{p,l}$	
0.20	0.90	-1.3216	-1.3254	0.2689	0.2731
0.40	0.95	-1.1595	-1.1450	0.2005	*****
0.60	0.95	-0.9691	-0.9753	0.2091	0.2118
0.80	0.95	-0.6967	-0.6986	0.1861	0.1921
0.95	0.95	-0.3058	-0.3154	-0.1546	-0.1262

Surface Pressures
 ● upper, starboard
 ○ lower, port

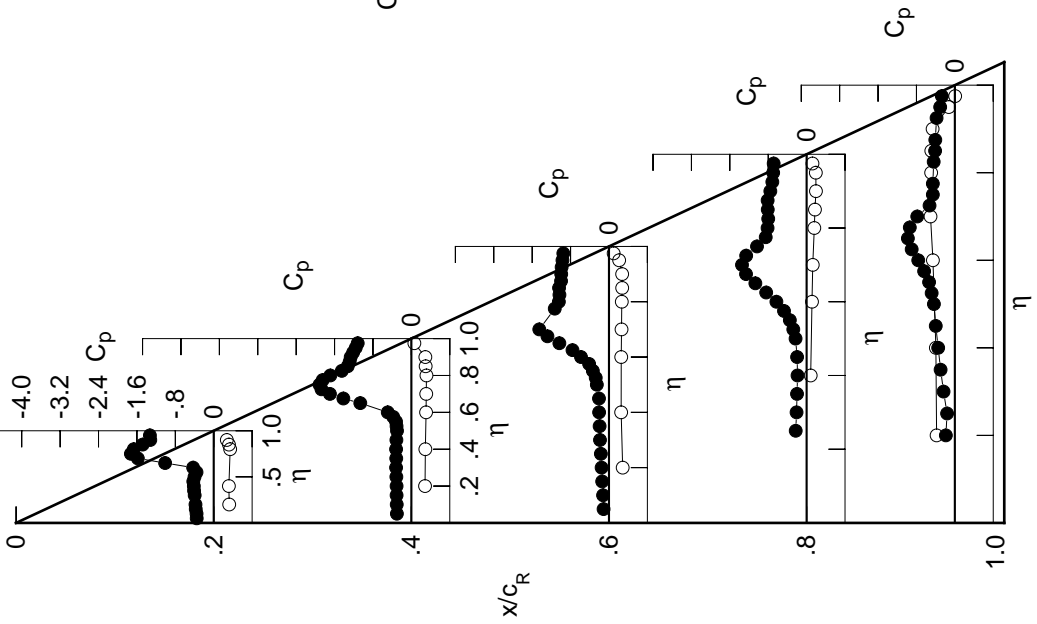

Table D2. Continued.

η	$x/c_R = .2$		$x/c_R = .4$		$x/c_R = .6$		$x/c_R = .8$		$x/c_R = .95$	
	$C_{p,u}$	$C_{p,l}$	$C_{p,u}$	$C_{p,l}$	$C_{p,u}$	$C_{p,l}$	$C_{p,u}$	$C_{p,l}$	$C_{p,u}$	$C_{p,l}$
0.050	-0.3901	-0.3359	-0.1267	*****	*****	*****	*****	*****	*****	*****
0.100	-0.3950	-0.3366	-0.1480	*****	*****	*****	*****	*****	*****	*****
0.150	-0.4101	-0.3416	-0.1566	*****	*****	*****	*****	*****	*****	*****
0.200	-0.4159	-0.3416	-0.1782	*****	*****	*****	*****	*****	*****	*****
0.250	*****	-0.3493	-0.1896	-0.2432	-0.1818	*****	*****	*****	*****	*****
0.300	-0.4306	-0.3481	-0.2085	-0.2234	-0.2450	*****	*****	*****	*****	*****
0.350	-0.4411	-0.3502	-0.2196	-0.2169	-0.3057	*****	*****	*****	*****	*****
0.400	-0.4420	-0.3483	-0.2313	-0.2068	-0.3558	*****	*****	*****	*****	*****
0.450	-0.4452	-0.3470	-0.2474	-0.2319	-0.4088	*****	*****	*****	*****	*****
0.500	-0.4143	-0.3463	-0.3089	-0.2869	-0.4695	*****	*****	*****	*****	*****
0.525	*****	-0.3717	-0.3617	-0.3519	-0.5275	*****	*****	*****	*****	*****
0.550	-0.3964	-0.4168	-0.4509	-0.4544	-0.6020	*****	*****	*****	*****	*****
0.575	*****	-0.5154	-0.5691	-0.5966	-0.7132	*****	*****	*****	*****	*****
0.600	-0.6367	-0.6954	-0.7771	-0.7813	-0.8359	*****	*****	*****	*****	*****
0.625	*****	-0.9814	-0.9957	-0.9412	*****	*****	*****	*****	*****	*****
0.650	-1.3107	-1.3105	-1.2578	-1.2128	-0.9642	*****	*****	*****	*****	*****
0.675	*****	-1.6355	-1.4742	-1.3716	-0.8616	*****	*****	*****	*****	*****
0.700	-1.7860	-1.8826	-1.5804	-1.3904	-0.6605	*****	*****	*****	*****	*****
0.725	*****	-2.0273	*****	-1.2314	-0.4742	*****	*****	*****	*****	*****
0.750	-1.8794	-2.0156	*****	-0.9852	-0.4746	*****	*****	*****	*****	*****
0.775	*****	-1.8465	-1.1270	-0.8535	-0.4777	*****	*****	*****	*****	*****
0.800	-1.7709	-1.6026	-1.0922	-0.8384	*****	*****	*****	*****	*****	*****
0.825	*****	-1.4163	-1.0854	-0.8207	-0.4506	*****	*****	*****	*****	*****
0.850	-1.5343	-1.3641	-1.0937	-0.8308	-0.4110	*****	*****	*****	*****	*****
0.875	*****	-1.3515	-1.0499	-0.8337	-0.3964	*****	*****	*****	*****	*****
0.900	-1.4104	-1.3337	-1.0354	-0.7804	*****	*****	*****	*****	*****	*****
0.925	*****	-1.2755	-1.0217	-0.7319	-0.3723	*****	*****	*****	*****	*****
0.950	-1.4044	-1.2167	-1.0050	-0.7157	-0.3031	*****	*****	*****	*****	*****
0.975	*****	-1.1827	-0.9855	-0.7025	-0.2698	*****	*****	*****	*****	*****
-0.200	0.3466	0.3052	0.3011	*****	-0.3835	*****	*****	*****	*****	*****
-0.400	0.3429	0.3098	0.2736	0.0934	-0.4141	*****	*****	*****	*****	*****
-0.600	*****	0.3275	0.2698	0.1234	-0.4819	*****	*****	*****	*****	*****
-0.700	*****	0.3284	0.2793	0.1416	-0.5270	*****	*****	*****	*****	*****
-0.800	0.3547	0.3309	0.2803	0.1705	-0.5010	*****	*****	*****	*****	*****
-0.850	0.3234	0.3057	0.2862	0.1836	-0.4915	*****	*****	*****	*****	*****
-0.900	0.2716	0.2922	0.2799	0.2006	-0.4561	*****	*****	*****	*****	*****
-0.950	*****	*****	0.2034	0.1895	-0.1194	*****	*****	*****	*****	*****
-0.975	*****	0.0362	0.0775	0.1093	0.0054	*****	*****	*****	*****	*****

Sharp Radius L.E.

Run No. = 85, Point No. = 1861

$C_N = 0.742$, $C_m = -0.1062$

$\alpha = 16.5^\circ$, $M_\infty = 0.599$

$R_{mac} = 6.0 \times 10^6$

Surface Pressures Near Leading Edge

● / ◆ upper, starboard/port
○ / ◇ lower, starboard/port

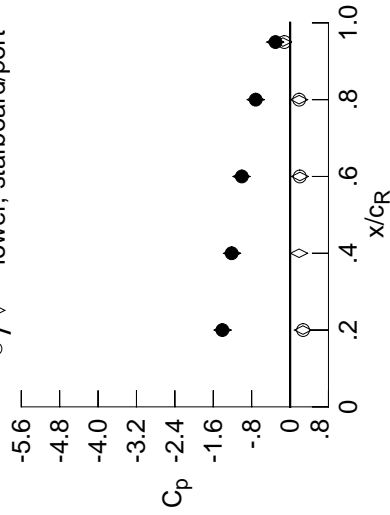

x/cR	η	$C_{p,u}$ starb'd	$C_{p,u}$ port	$C_{p,l}$ starb'd	$C_{p,l}$ port
0.20	0.90	-1.4104	-1.4062	0.2677	0.2716
0.40	0.95	-1.2167	-1.2083	0.1877	*****
0.60	0.95	-1.0050	-1.0129	0.2048	0.2034
0.80	0.95	-0.7157	-0.7157	0.1885	0.1895
0.95	0.95	-0.3031	-0.3107	-0.1492	-0.1194

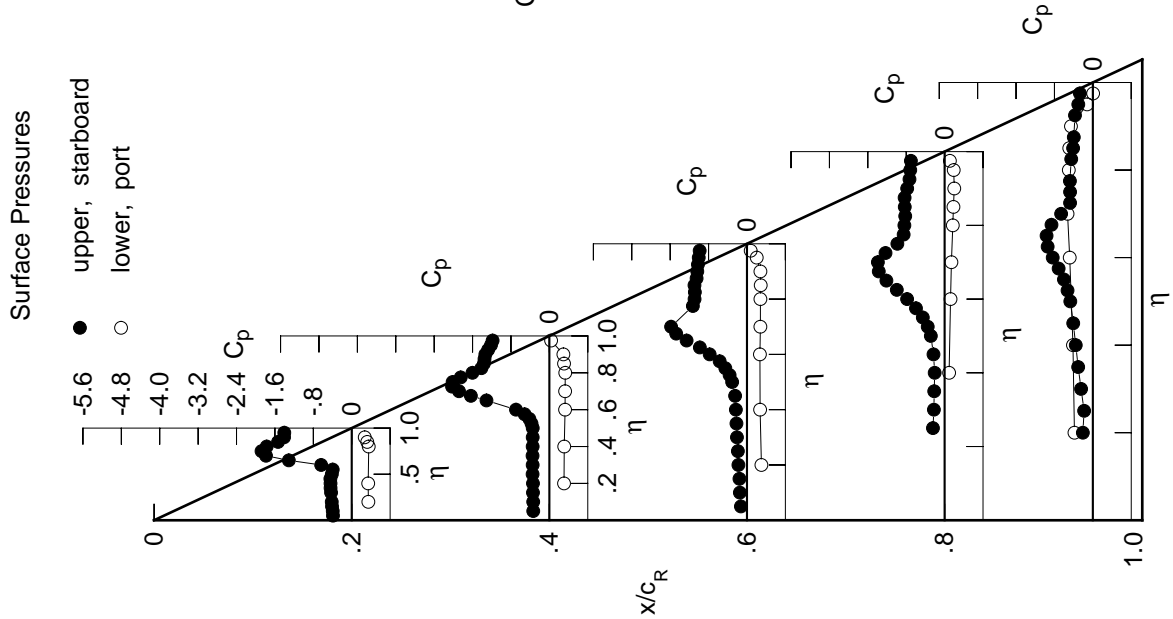

Table D2. Continued.

η	$x/c_R = .2$		$x/c_R = .4$		$x/c_R = .6$		$x/c_R = .8$		$x/c_R = .95$	
	$C_{p,u}$	$C_{p,l}$	$C_{p,u}$	$C_{p,l}$	$C_{p,u}$	$C_{p,l}$	$C_{p,u}$	$C_{p,l}$	$C_{p,u}$	$C_{p,l}$
0.050	-0.4228	-0.3697	-0.1427	*****	*****	*****	*****	*****	*****	*****
0.100	-0.4261	-0.3673	-0.1675	*****	*****	*****	*****	*****	*****	*****
0.150	-0.4465	-0.3754	-0.1769	*****	*****	*****	*****	*****	*****	*****
0.200	-0.4478	-0.3719	-0.1951	*****	*****	*****	*****	*****	*****	*****
0.250	*****	-0.3815	-0.2099	-0.2592	-0.2031	*****	*****	*****	*****	*****
0.300	-0.4601	-0.3815	-0.2270	-0.2315	-0.2570	*****	*****	*****	*****	*****
0.350	-0.4699	-0.3829	-0.2465	-0.2371	-0.3116	*****	*****	*****	*****	*****
0.400	-0.4668	-0.3846	-0.2572	-0.2327	-0.3617	*****	*****	*****	*****	*****
0.450	-0.4632	-0.3893	-0.2918	-0.2668	-0.4225	*****	*****	*****	*****	*****
0.500	-0.4349	-0.4160	-0.3798	-0.3584	-0.5035	*****	*****	*****	*****	*****
0.525	*****	-0.4679	-0.4646	-0.4428	-0.5734	*****	*****	*****	*****	*****
0.550	-0.4814	-0.5575	-0.5846	-0.5663	-0.6604	*****	*****	*****	*****	*****
0.575	*****	-0.7043	-0.7438	-0.7279	-0.7719	*****	*****	*****	*****	*****
0.600	-0.9155	-0.9286	-0.9797	-0.9293	-0.8845	*****	*****	*****	*****	*****
0.625	*****	*****	-1.1955	-1.1455	-0.9412	*****	*****	*****	*****	*****
0.650	-1.6417	-1.5423	-1.4616	-1.3411	-0.9118	*****	*****	*****	*****	*****
0.675	*****	-1.8250	-1.6338	-1.4487	-0.7606	*****	*****	*****	*****	*****
0.700	-1.9235	-2.0517	-1.6583	-1.3925	-0.5532	*****	*****	*****	*****	*****
0.725	*****	-2.1606	*****	-1.1776	-0.4639	*****	*****	*****	*****	*****
0.750	-2.0397	-2.0186	*****	-0.9363	-0.4825	*****	*****	*****	*****	*****
0.775	*****	-1.7042	-1.1438	-0.8589	-0.4822	*****	*****	*****	*****	*****
0.800	-1.8281	-1.4970	-1.1271	-0.8496	*****	*****	*****	*****	*****	*****
0.825	*****	-1.4289	-1.1238	-0.8295	-0.4482	*****	*****	*****	*****	*****
0.850	-1.5658	-1.4182	-1.1359	-0.8462	-0.4060	*****	*****	*****	*****	*****
0.875	*****	-1.4185	-1.0885	-0.8430	-0.3852	*****	*****	*****	*****	*****
0.900	-1.4872	-1.3856	-1.0749	-0.7970	*****	*****	*****	*****	*****	*****
0.925	*****	-1.3300	-1.0524	-0.7477	-0.3587	*****	*****	*****	*****	*****
0.950	-1.4739	-1.2804	-1.0392	-0.7240	-0.3016	*****	*****	*****	*****	*****
0.975	*****	-1.2592	-1.0231	-0.7166	-0.2697	*****	*****	*****	*****	*****
-0.200	0.3771	0.3252	0.3190	*****	-0.3789	*****	*****	*****	*****	*****
-0.400	0.3692	0.3371	0.2929	0.1036	-0.4231	*****	*****	*****	*****	*****
-0.600	*****	0.3456	0.2843	0.1416	-0.5038	*****	*****	*****	*****	*****
-0.700	*****	0.3466	0.2994	0.1504	-0.5423	*****	*****	*****	*****	*****
-0.800	0.3673	0.3473	0.2974	0.1872	-0.5014	*****	*****	*****	*****	*****
-0.850	0.3306	0.3149	0.2989	0.1962	-0.4893	*****	*****	*****	*****	*****
-0.900	0.2698	0.2938	0.2864	0.2112	-0.4465	*****	*****	*****	*****	*****
-0.950	*****	*****	0.1956	0.1888	-0.1113	*****	*****	*****	*****	*****
-0.975	*****	0.0102	0.0599	0.1003	0.0045	*****	*****	*****	*****	*****

Sharp Radius L.E.

Run No. = 85, Point No. = 1862

$C_N = 0.796$, $C_m = -0.1124$

$\alpha = 17.5^\circ$, $M_\infty = 0.599$

$R_{mac} = 6.0 \times 10^6$

Surface Pressures Near Leading Edge

● / ◆ upper, starboard/port
○ / ◇ lower, starboard/port

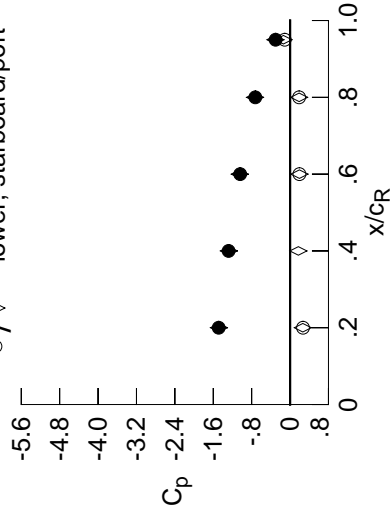

x/c_R	η	starb'd	port	starb'd	port
		$C_{p,u}$	$C_{p,l}$	$C_{p,u}$	$C_{p,l}$
0.20	0.90	-1.4872	-1.4814	0.2658	0.2698
0.40	0.95	-1.2804	-1.2751	0.1727	*****
0.60	0.95	-1.0392	-1.0488	0.1956	0.1956
0.80	0.95	-0.7240	-0.7300	0.1885	0.1888
0.95	0.95	-0.3016	-0.3052	-0.1381	-0.1113

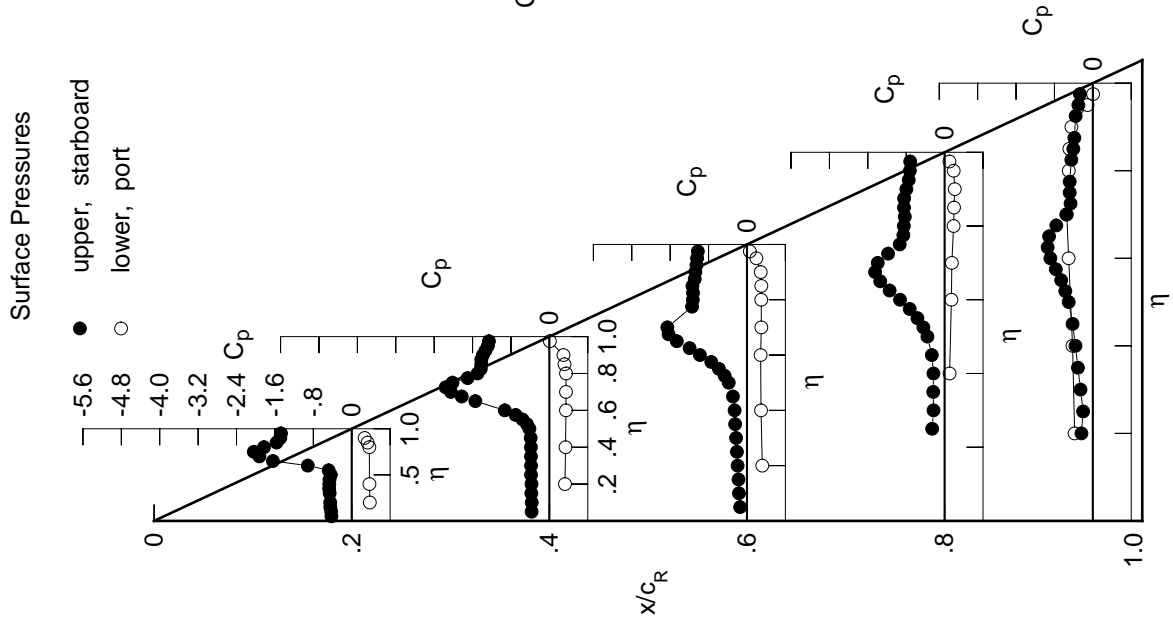

Table D2. Continued.

η	$x/c_R = .2$		$x/c_R = .4$		$x/c_R = .6$		$x/c_R = .8$		$x/c_R = .95$	
	$C_{p,u}$	$C_{p,l}$	$C_{p,u}$	$C_{p,l}$	$C_{p,u}$	$C_{p,l}$	$C_{p,u}$	$C_{p,l}$	$C_{p,u}$	$C_{p,l}$
0.050	-0.4622	-0.4087	-0.1647	*****	*****	*****	*****	*****	*****	*****
0.100	-0.4634	-0.4009	-0.1803	*****	*****	*****	*****	*****	*****	*****
0.150	-0.4839	-0.4090	-0.1962	*****	*****	*****	*****	*****	*****	*****
0.200	-0.4849	-0.4069	-0.2138	*****	*****	*****	*****	*****	*****	*****
0.250	*****	-0.4178	-0.2360	-0.2719	-0.2353	*****	*****	*****	*****	*****
0.300	-0.4962	-0.4173	-0.2457	-0.2550	-0.2751	*****	*****	*****	*****	*****
0.350	-0.5024	-0.4198	-0.2724	-0.2563	-0.3194	*****	*****	*****	*****	*****
0.400	-0.4956	-0.4304	-0.2924	-0.2646	-0.3760	*****	*****	*****	*****	*****
0.450	-0.4888	-0.4469	-0.3478	-0.3172	-0.4463	*****	*****	*****	*****	*****
0.500	-0.4811	-0.5176	-0.4790	-0.4441	-0.5471	*****	*****	*****	*****	*****
0.525	*****	-0.6010	-0.5875	-0.5462	-0.6251	*****	*****	*****	*****	*****
0.550	-0.6341	-0.7309	-0.7444	-0.6951	-0.7178	*****	*****	*****	*****	*****
0.575	*****	-0.9164	-0.9253	-0.8724	-0.8185	*****	*****	*****	*****	*****
0.600	-1.2161	-1.1654	-1.1866	-1.0790	-0.8999	*****	*****	*****	*****	*****
0.625	*****	*****	-1.3981	-1.2899	-0.9143	*****	*****	*****	*****	*****
0.650	-1.9993	-1.7489	-1.6548	-1.4512	-0.8400	*****	*****	*****	*****	*****
0.675	*****	-2.0163	-1.7643	-1.4836	-0.6627	*****	*****	*****	*****	*****
0.700	-2.0610	-2.2260	-1.6746	-1.3570	-0.4862	*****	*****	*****	*****	*****
0.725	*****	-2.1882	*****	-1.0944	-0.4743	*****	*****	*****	*****	*****
0.750	-2.1505	-1.8337	*****	-0.9033	-0.4913	*****	*****	*****	*****	*****
0.775	*****	-1.5699	-1.1732	-0.8637	-0.4861	*****	*****	*****	*****	*****
0.800	-1.8283	-1.4973	-1.1648	-0.8556	*****	*****	*****	*****	*****	*****
0.825	*****	-1.4843	-1.1594	-0.8347	-0.4379	*****	*****	*****	*****	*****
0.850	-1.6157	-1.4887	-1.1766	-0.8524	-0.3967	*****	*****	*****	*****	*****
0.875	*****	-1.4889	-1.1266	-0.8539	-0.3747	*****	*****	*****	*****	*****
0.900	-1.5606	-1.4371	-1.1113	-0.8024	*****	*****	*****	*****	*****	*****
0.925	*****	-1.3838	-1.0892	-0.7554	-0.3480	*****	*****	*****	*****	*****
0.950	-1.5424	-1.3520	-1.0753	-0.7336	-0.3010	*****	*****	*****	*****	*****
0.975	*****	-1.3365	-1.0618	-0.7216	-0.2724	*****	*****	*****	*****	*****
-0.200	0.4045	0.3471	0.3383	*****	-0.3674	*****	*****	*****	*****	*****
-0.400	0.3953	0.3597	0.3104	0.1178	-0.4350	*****	*****	*****	*****	*****
-0.600	*****	0.3665	0.3028	0.1547	-0.5230	*****	*****	*****	*****	*****
-0.700	*****	0.3664	0.3159	0.1651	-0.5534	*****	*****	*****	*****	*****
-0.800	0.3784	0.3607	0.3160	0.1954	-0.5024	*****	*****	*****	*****	*****
-0.850	0.3355	0.3223	0.3106	0.2085	-0.4836	*****	*****	*****	*****	*****
-0.900	0.2664	0.2947	0.2925	0.2191	-0.4357	*****	*****	*****	*****	*****
-0.950	*****	*****	0.1863	0.1875	-0.1048	*****	*****	*****	*****	*****
-0.975	*****	-0.0156	0.0395	0.0888	0.0037	*****	*****	*****	*****	*****

Sharp Radius L.E.

Run No. = 85, Point No. = 1863

$C_N = 0.850$, $C_m = -0.1174$

$\alpha = 18.5^\circ$, $M_\infty = 0.599$

$R_{mac} = 6.0 \times 10^6$

Surface Pressures Near Leading Edge

● / ◆ upper, starboard/port
○ / ◇ lower, starboard/port

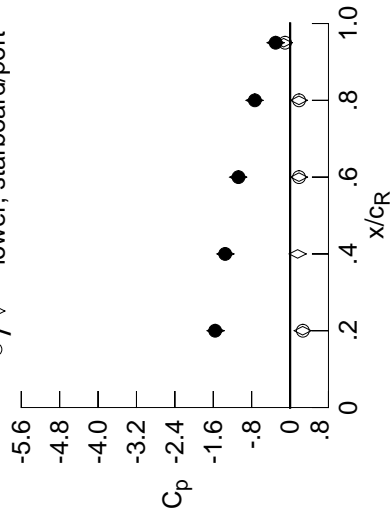

x/c_R	η	starb'd	port	$C_{p,u}$	starb'd	port	$C_{p,l}$
0.20	0.90	-1.5606	-1.5531	0.2626	0.2664	0.2664	0.2664
0.40	0.95	-1.3520	-1.3481	0.1580	*****	*****	*****
0.60	0.95	-1.0753	-1.0812	0.1860	0.1863	0.1863	0.1863
0.80	0.95	-0.7336	-0.7413	0.1845	0.1875	0.1875	0.1875
0.95	0.95	-0.3010	-0.3020	-0.1322	-0.1048	-0.1048	-0.1048

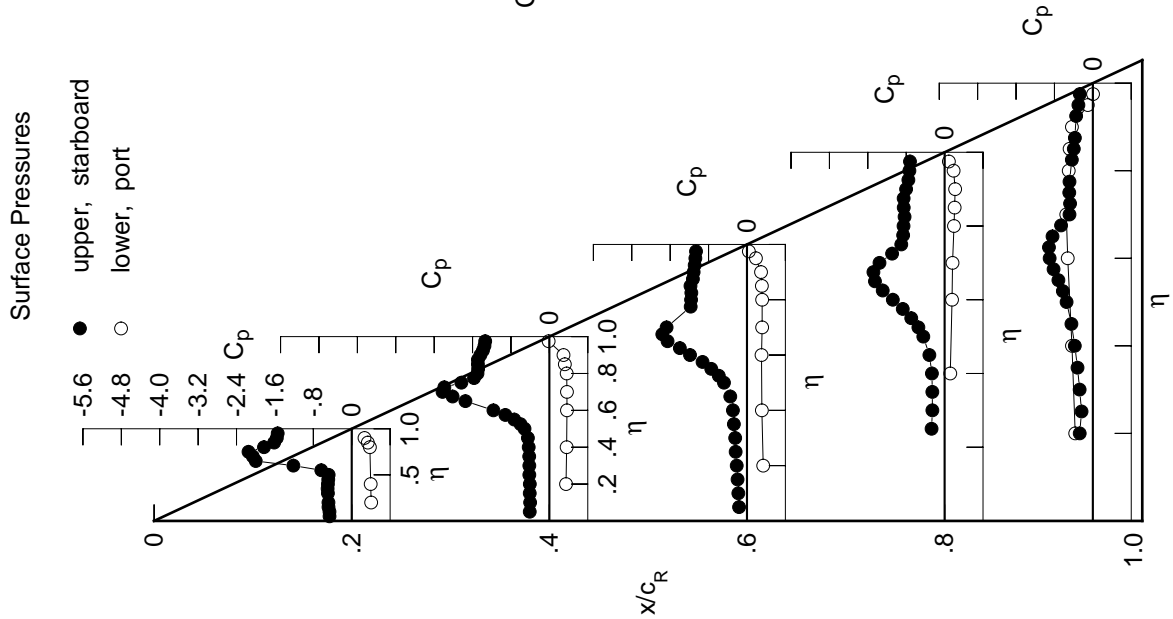

Table D2. Continued.

η	$x/c_R = .2$		$x/c_R = .4$		$x/c_R = .6$		$x/c_R = .8$		$x/c_R = .95$	
	$C_{p,u}$	$C_{p,l}$	$C_{p,u}$	$C_{p,l}$	$C_{p,u}$	$C_{p,l}$	$C_{p,u}$	$C_{p,l}$	$C_{p,u}$	$C_{p,l}$
0.050	-0.5036	-0.4459	-0.1860	*****	*****	*****	*****	*****	*****	*****
0.100	-0.5046	-0.4390	-0.1995	*****	*****	*****	*****	*****	*****	*****
0.150	-0.5244	-0.4448	-0.2177	*****	*****	*****	*****	*****	*****	*****
0.200	-0.5243	-0.4445	-0.2380	*****	*****	*****	*****	*****	*****	*****
0.250	*****	-0.4558	-0.2579	-0.2900	-0.2738	*****	*****	*****	*****	*****
0.300	-0.5352	-0.4582	-0.2732	-0.2773	-0.3049	*****	*****	*****	*****	*****
0.350	-0.5387	-0.4620	-0.3071	-0.2771	-0.3331	*****	*****	*****	*****	*****
0.400	-0.5286	-0.4837	-0.3393	-0.3071	-0.3924	*****	*****	*****	*****	*****
0.450	-0.5285	-0.5237	-0.4169	-0.3732	-0.4668	*****	*****	*****	*****	*****
0.500	-0.5671	-0.6370	-0.5946	-0.5386	-0.5884	*****	*****	*****	*****	*****
0.525	*****	-0.7549	-0.7282	-0.6518	-0.6700	*****	*****	*****	*****	*****
0.550	-0.8567	-0.9147	-0.9146	-0.8209	-0.7544	*****	*****	*****	*****	*****
0.575	*****	-1.1277	-1.1048	-1.0078	-0.8476	*****	*****	*****	*****	*****
0.600	-1.5308	-1.3876	-1.3806	-1.2160	-0.8876	*****	*****	*****	*****	*****
0.625	*****	*****	-1.5841	-1.4178	-0.8759	*****	*****	*****	*****	*****
0.650	-2.1561	-1.9479	-1.8187	-1.5415	-0.7604	*****	*****	*****	*****	*****
0.675	*****	-2.1920	-1.8471	-1.4857	-0.5866	*****	*****	*****	*****	*****
0.700	-2.4792	-2.3425	-1.6606	-1.2922	-0.4643	*****	*****	*****	*****	*****
0.725	*****	-1.9424	*****	-1.0094	-0.4801	*****	*****	*****	*****	*****
0.750	-2.0839	-1.6722	*****	-0.8912	-0.4888	*****	*****	*****	*****	*****
0.775	*****	-1.5683	-1.2109	-0.8656	-0.4721	*****	*****	*****	*****	*****
0.800	-1.7979	-1.5886	-1.2049	-0.8552	*****	*****	*****	*****	*****	*****
0.825	*****	-1.5615	-1.1990	-0.8417	-0.4132	*****	*****	*****	*****	*****
0.850	-1.6866	-1.5748	-1.2128	-0.8533	-0.3819	*****	*****	*****	*****	*****
0.875	*****	-1.5528	-1.1660	-0.8614	-0.3680	*****	*****	*****	*****	*****
0.900	-1.6287	-1.4866	-1.1513	-0.8150	*****	*****	*****	*****	*****	*****
0.925	*****	-1.4397	-1.1242	-0.7606	-0.3440	*****	*****	*****	*****	*****
0.950	-1.6135	-1.4230	-1.1028	-0.7418	-0.3024	*****	*****	*****	*****	*****
0.975	*****	-1.4124	-1.0890	-0.7309	-0.2839	*****	*****	*****	*****	*****

η	$x/c_R = .2$		$x/c_R = .4$		$x/c_R = .6$		$x/c_R = .8$		$x/c_R = .95$	
	$C_{p,u}$	$C_{p,l}$	$C_{p,u}$	$C_{p,l}$	$C_{p,u}$	$C_{p,l}$	$C_{p,u}$	$C_{p,l}$	$C_{p,u}$	$C_{p,l}$
-0.200	0.4260	0.3735	0.3487	*****	*****	*****	*****	*****	*****	*****
-0.400	0.4200	0.3767	0.3275	0.1348	-0.4466	*****	*****	*****	*****	*****
-0.600	*****	0.3907	0.3216	0.1662	-0.5405	*****	*****	*****	*****	*****
-0.700	*****	0.3850	0.3323	0.1805	-0.5615	*****	*****	*****	*****	*****
-0.800	0.3909	0.3719	0.3257	0.2076	-0.5030	*****	*****	*****	*****	*****
-0.850	0.3405	0.3264	0.3233	0.2183	-0.4799	*****	*****	*****	*****	*****
-0.900	0.2637	0.2915	0.2947	0.2235	-0.4261	*****	*****	*****	*****	*****
-0.950	*****	*****	0.1762	0.1852	-0.1001	*****	*****	*****	*****	*****
-0.975	*****	-0.0462	0.0167	0.0756	-0.0006	*****	*****	*****	*****	*****

Sharp Radius L.E.
 Run No. = 85, Point No. = 1864
 $C_N = 0.904$, $C_m = -0.1231$
 $\alpha = 19.5^\circ$, $M_\infty = 0.599$
 $R_{mac} = 6.0 \times 10^6$

Surface Pressures Near Leading Edge

● / ◆ upper, starboard/port
 ○ / ◇ lower, starboard/port

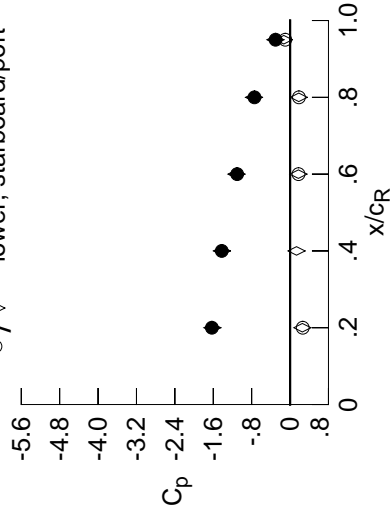

x/c_R	η	starb'd	port	starb'd	port
		$C_{p,u}$	$C_{p,l}$	$C_{p,u}$	$C_{p,l}$
0.20	0.90	-1.6287	-1.6191	0.2560	0.2637
0.40	0.95	-1.4230	-1.4203	0.1341	*****
0.60	0.95	-1.1028	-1.1179	0.1735	0.1762
0.80	0.95	-0.7418	-0.7511	0.1815	0.1852
0.95	0.95	-0.3024	-0.3057	-0.1298	-0.1001

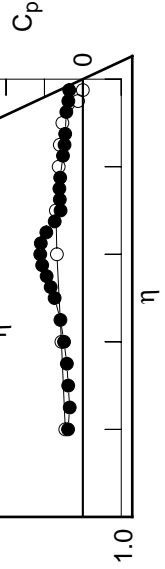

Table D2. Continued.

η	$x/c_R = .2$		$x/c_R = .4$		$x/c_R = .6$		$x/c_R = .8$		$x/c_R = .95$	
	$C_{p,u}$	$C_{p,l}$	$C_{p,u}$	$C_{p,l}$	$C_{p,u}$	$C_{p,l}$	$C_{p,u}$	$C_{p,l}$	$C_{p,u}$	$C_{p,l}$
0.050	-0.5465	-0.4816	-0.2045	*****	*****	*****	*****	*****	*****	*****
0.100	-0.5465	-0.4762	-0.2182	*****	*****	*****	*****	*****	*****	*****
0.150	-0.5690	-0.4867	-0.2389	*****	*****	*****	*****	*****	*****	*****
0.200	-0.5683	-0.4865	-0.2576	*****	*****	*****	*****	*****	*****	*****
0.250	*****	-0.4954	-0.2821	-0.3067	-0.3200	*****	*****	*****	*****	*****
0.300	-0.5740	-0.5022	-0.3033	-0.2980	-0.3373	*****	*****	*****	*****	*****
0.350	-0.5772	-0.5123	-0.3424	-0.3065	-0.3531	*****	*****	*****	*****	*****
0.400	-0.5689	-0.5480	-0.3905	-0.3474	-0.4086	*****	*****	*****	*****	*****
0.450	-0.5889	-0.6154	-0.4948	-0.4393	-0.4954	*****	*****	*****	*****	*****
0.500	-0.7074	-0.7751	-0.7133	-0.6311	-0.6211	*****	*****	*****	*****	*****
0.525	*****	-0.9189	-0.8717	-0.7646	-0.7065	*****	*****	*****	*****	*****
0.550	-1.1423	-1.1016	-1.0741	-0.9419	-0.7839	*****	*****	*****	*****	*****
0.575	*****	-1.3322	-1.2821	-1.1390	-0.8540	*****	*****	*****	*****	*****
0.600	-1.8526	-1.5907	-1.5547	-1.3428	-0.8684	*****	*****	*****	*****	*****
0.625	*****	*****	-1.7624	-1.5221	-0.8252	*****	*****	*****	*****	*****
0.650	-2.3377	-2.1317	-1.9608	-1.5853	-0.6999	*****	*****	*****	*****	*****
0.675	*****	-2.3406	-1.8804	-1.4508	-0.5307	*****	*****	*****	*****	*****
0.700	-2.6187	-2.1373	-1.6260	-1.2051	-0.4563	*****	*****	*****	*****	*****
0.725	*****	-1.7516	*****	-0.9520	-0.4738	*****	*****	*****	*****	*****
0.750	-2.0543	-1.6403	*****	-0.8832	-0.4781	*****	*****	*****	*****	*****
0.775	*****	-1.6129	-1.2537	-0.8658	-0.4538	*****	*****	*****	*****	*****
0.800	-1.7929	-1.6233	-1.2417	-0.8579	*****	*****	*****	*****	*****	*****
0.825	*****	-1.6374	-1.2360	-0.8392	-0.4012	*****	*****	*****	*****	*****
0.850	-1.7581	-1.6535	-1.2549	-0.8552	-0.3725	*****	*****	*****	*****	*****
0.875	*****	-1.6104	-1.2075	-0.8641	-0.3678	*****	*****	*****	*****	*****
0.900	-1.6939	-1.5415	-1.1927	-0.8188	*****	*****	*****	*****	*****	*****
0.925	*****	-1.5046	-1.1595	-0.7734	-0.3496	*****	*****	*****	*****	*****
0.950	-1.6885	-1.4931	-1.1417	-0.7462	-0.3177	*****	*****	*****	*****	*****
0.975	*****	-1.4850	-1.1284	-0.7365	-0.2938	*****	*****	*****	*****	*****
-0.200	0.4546	0.3932	0.3711	*****	-0.3672	*****	*****	*****	*****	*****
-0.400	0.4461	0.4040	0.3454	0.1482	-0.4528	*****	*****	*****	*****	*****
-0.600	*****	0.4116	0.3391	0.1818	-0.5519	*****	*****	*****	*****	*****
-0.700	*****	0.4035	0.3496	0.1922	-0.5638	*****	*****	*****	*****	*****
-0.800	0.3999	0.3861	0.3403	0.2215	-0.4986	*****	*****	*****	*****	*****
-0.850	0.3440	0.3339	0.3328	0.2298	-0.4740	*****	*****	*****	*****	*****
-0.900	0.2586	0.2907	0.2979	0.2314	-0.4168	*****	*****	*****	*****	*****
-0.950	*****	*****	0.1649	0.1817	-0.0956	*****	*****	*****	*****	*****
-0.975	*****	-0.0674	-0.0033	0.0649	-0.0040	*****	*****	*****	*****	*****

Sharp Radius L.E.

Run No. = 85 , Point No. = 1865

$C_N = 0.962$, $C_m = -0.1318$

$\alpha = 20.6^\circ$, $M_\infty = 0.599$

$R_{mac} = 6.0 \times 10^6$

Surface Pressures Near Leading Edge

● / ◆ upper, starboard/port
○ / ◇ lower, starboard/port

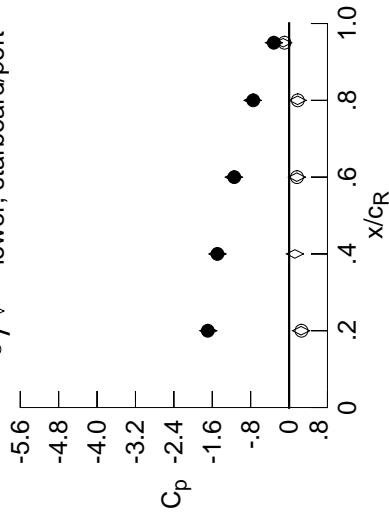

x/c_R	η	starb'd	port	starb'd	port
		$C_{p,u}$	$C_{p,l}$	$C_{p,u}$	$C_{p,l}$
0.20	0.90	-1.6939	-1.6841	0.2506	0.2586
0.40	0.95	-1.4931	-1.4939	0.1216	*****
0.60	0.95	-1.1417	-1.1525	0.1623	0.1649
0.80	0.95	-0.7462	-0.7602	0.1776	0.1817
0.95	0.95	-0.3177	-0.3150	-0.1232	-0.0956

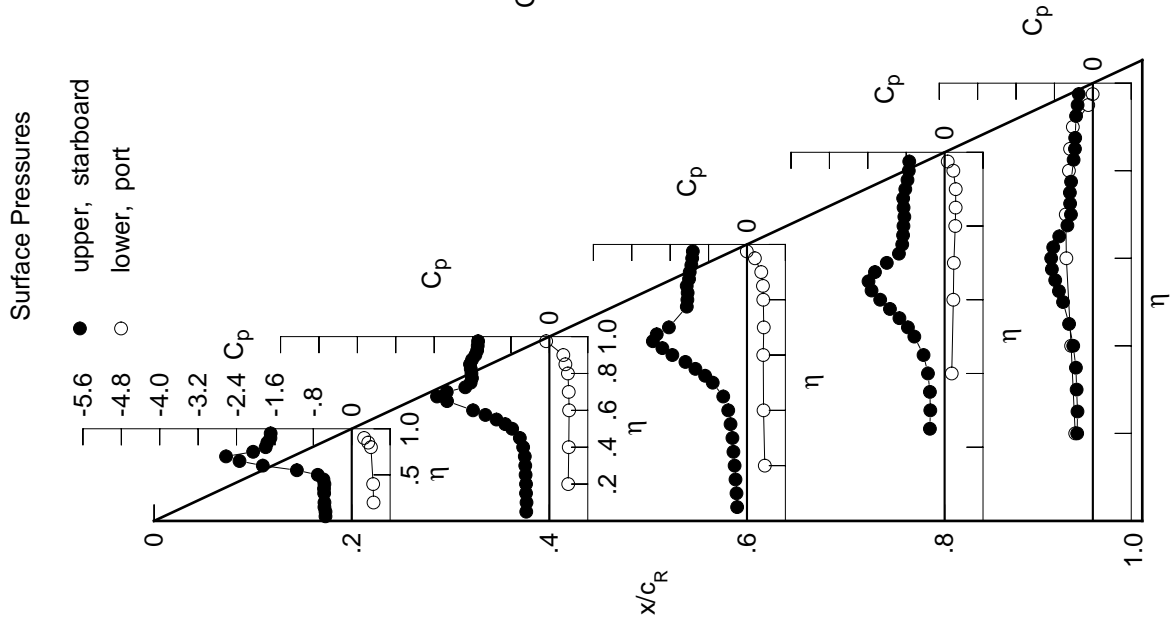

Table D2. Continued.

η	$x/c_R = .2$		$x/c_R = .4$		$x/c_R = .6$		$x/c_R = .8$		$x/c_R = .95$	
	$C_{p,u}$	$C_{p,l}$	$C_{p,u}$	$C_{p,l}$	$C_{p,u}$	$C_{p,l}$	$C_{p,u}$	$C_{p,l}$	$C_{p,u}$	$C_{p,l}$
0.050	-0.5973	-0.5152	-0.2198	*****	*****	*****	*****	*****	*****	*****
0.100	-0.5987	-0.5177	-0.2428	*****	*****	*****	*****	*****	*****	*****
0.150	-0.6077	-0.5225	-0.2519	*****	*****	*****	*****	*****	*****	*****
0.200	-0.6166	-0.5242	-0.2864	*****	*****	*****	*****	*****	*****	*****
0.250	*****	-0.5379	-0.3031	-0.3313	-0.3557	*****	*****	*****	*****	*****
0.300	-0.6199	-0.5435	-0.3375	-0.3209	-0.3651	*****	*****	*****	*****	*****
0.350	-0.6236	-0.5711	-0.3770	-0.3456	-0.3845	*****	*****	*****	*****	*****
0.400	-0.6266	-0.6152	-0.4502	-0.3931	-0.4294	*****	*****	*****	*****	*****
0.450	-0.6887	-0.7244	-0.5806	-0.5160	-0.5278	*****	*****	*****	*****	*****
0.500	-0.9124	-0.9161	-0.8373	-0.7263	-0.6561	*****	*****	*****	*****	*****
0.525	*****	-1.0952	-1.0175	-0.8803	-0.7439	*****	*****	*****	*****	*****
0.550	-1.4567	-1.2869	-1.2284	-1.0628	-0.8041	*****	*****	*****	*****	*****
0.575	*****	-1.5293	-1.4496	-1.2654	-0.8571	*****	*****	*****	*****	*****
0.600	-2.1349	-1.7764	-1.7124	-1.4632	-0.8473	*****	*****	*****	*****	*****
0.625	*****	-1.9227	-1.6024	-0.7759	*****	*****	*****	*****	*****	*****
0.650	-2.5525	-2.2881	-2.0785	-1.5762	-0.6423	*****	*****	*****	*****	*****
0.675	*****	-2.3132	-1.8689	-1.3759	-0.4887	*****	*****	*****	*****	*****
0.700	-2.5727	-1.8973	-1.5777	-1.1037	-0.4567	*****	*****	*****	*****	*****
0.725	*****	-1.6997	*****	-0.9178	-0.4655	*****	*****	*****	*****	*****
0.750	-1.9850	-1.6595	*****	-0.8760	-0.4601	*****	*****	*****	*****	*****
0.775	*****	-1.6585	-1.2918	-0.8652	-0.4349	*****	*****	*****	*****	*****
0.800	-1.8473	-1.6767	-1.2870	-0.8504	*****	*****	*****	*****	*****	*****
0.825	*****	-1.6993	-1.2812	-0.8421	-0.3910	*****	*****	*****	*****	*****
0.850	-1.8280	-1.7070	-1.2972	-0.8550	-0.3785	*****	*****	*****	*****	*****
0.875	*****	-1.6614	-1.2525	-0.8686	-0.3706	*****	*****	*****	*****	*****
0.900	-1.7622	-1.5976	-1.2305	-0.8257	*****	*****	*****	*****	*****	*****
0.925	*****	-1.5709	-1.2017	-0.7753	-0.3533	*****	*****	*****	*****	*****
0.950	-1.7699	-1.5562	-1.1765	-0.7585	-0.3307	*****	*****	*****	*****	*****
0.975	*****	-1.5486	-1.1626	-0.7461	-0.3104	*****	*****	*****	*****	*****
-0.200	0.4778	0.4179	0.3911	*****	-0.3726	*****	*****	*****	*****	*****
-0.400	0.4723	0.4278	0.3617	0.1663	-0.4528	*****	*****	*****	*****	*****
-0.600	*****	0.4286	0.3595	0.1927	-0.5606	*****	*****	*****	*****	*****
-0.700	*****	0.4202	0.3614	0.2083	-0.5584	*****	*****	*****	*****	*****
-0.800	0.4093	0.3988	0.3538	0.2335	-0.4984	*****	*****	*****	*****	*****
-0.850	0.3479	0.3401	0.3411	0.2417	-0.4657	*****	*****	*****	*****	*****
-0.900	0.2523	0.2877	0.2985	0.2385	-0.4040	*****	*****	*****	*****	*****
-0.950	*****	*****	0.1529	0.1773	-0.0920	*****	*****	*****	*****	*****
-0.975	*****	-0.1090	-0.0274	0.0535	-0.0097	*****	*****	*****	*****	*****

Sharp Radius L.E.
 Run No. = 85 , Point No. = 1866
 $C_N = 1.020$, $C_m = -0.1406$
 $\alpha = 21.6^\circ$, $M_\infty = 0.599$
 $R_{mac} = 6.0 \times 10^6$

Surface Pressures Near Leading Edge

● / ◆ upper, starboard/port
 ○ / ◇ lower, starboard/port

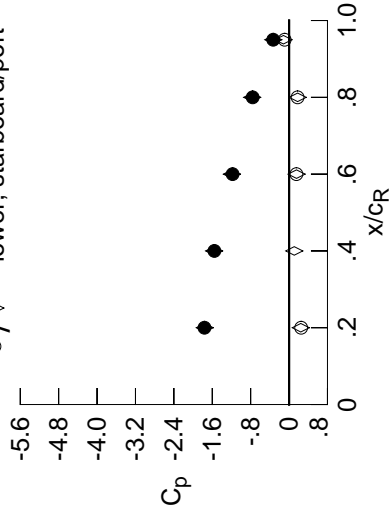

x/c_R	η	starb'd	port	starb'd	port
		$C_{p,u}$	$C_{p,l}$	$C_{p,u}$	$C_{p,l}$
0.20	0.90	-1.7622	-1.7563	0.2436	0.2523
0.40	0.95	-1.5562	-1.5618	0.1081	*****
0.60	0.95	-1.1765	-1.1908	0.1556	0.1529
0.80	0.95	-0.7585	-0.7685	0.1783	0.1773
0.95	0.95	-0.3307	-0.3291	-0.1175	-0.0920

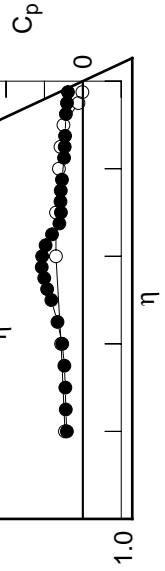

Table D2. Continued.

η	$x/c_R = .2$		$x/c_R = .4$		$x/c_R = .6$		$x/c_R = .8$		$x/c_R = .95$	
	$C_{p,u}$	$C_{p,l}$	$C_{p,u}$	$C_{p,l}$	$C_{p,u}$	$C_{p,l}$	$C_{p,u}$	$C_{p,l}$	$C_{p,u}$	$C_{p,l}$
0.050	-0.6440	-0.5572	-0.2422	*****	*****	*****	*****	*****	*****	*****
0.100	-0.6462	-0.5567	-0.2639	*****	*****	*****	*****	*****	*****	*****
0.150	-0.6590	-0.5617	-0.2773	*****	*****	*****	*****	*****	*****	*****
0.200	-0.6663	-0.5660	-0.3075	*****	*****	*****	*****	*****	*****	*****
0.250	*****	-0.5801	-0.3329	-0.3516	-0.3769	*****	*****	*****	*****	*****
0.300	-0.6714	-0.5950	-0.3719	-0.3529	-0.3915	*****	*****	*****	*****	*****
0.350	-0.6840	-0.6281	-0.4260	-0.3850	-0.4104	*****	*****	*****	*****	*****
0.400	-0.7104	-0.6963	-0.5167	-0.4479	-0.4583	*****	*****	*****	*****	*****
0.450	-0.8310	-0.8322	-0.6734	-0.5931	-0.5634	*****	*****	*****	*****	*****
0.500	-1.1605	-1.0666	-0.9650	-0.8300	-0.6915	*****	*****	*****	*****	*****
0.525	*****	-1.2579	-1.1547	-0.9961	-0.7744	*****	*****	*****	*****	*****
0.550	-1.7533	-1.4667	-1.3731	-1.1858	-0.8231	*****	*****	*****	*****	*****
0.575	*****	-1.7052	-1.5951	-1.3908	-0.8497	*****	*****	*****	*****	*****
0.600	-2.3701	-1.9441	-1.8518	-1.5843	-0.8196	*****	*****	*****	*****	*****
0.625	*****	*****	-2.0552	-1.6558	-0.7282	*****	*****	*****	*****	*****
0.650	-2.6761	-2.4060	-2.1537	-1.5050	-0.5890	*****	*****	*****	*****	*****
0.675	*****	-2.1152	-1.8147	-1.2554	-0.4599	*****	*****	*****	*****	*****
0.700	-2.3661	-1.8193	-1.5266	-1.0036	-0.4600	*****	*****	*****	*****	*****
0.725	*****	-1.7234	*****	-0.9004	-0.4594	*****	*****	*****	*****	*****
0.750	-1.9679	-1.7085	*****	-0.8721	-0.4532	*****	*****	*****	*****	*****
0.775	*****	-1.7128	-1.3339	-0.8608	-0.4290	*****	*****	*****	*****	*****
0.800	-1.9335	-1.7339	-1.3312	-0.8532	*****	*****	*****	*****	*****	*****
0.825	*****	-1.7606	-1.3236	-0.8388	-0.4038	*****	*****	*****	*****	*****
0.850	-1.8942	-1.7667	-1.3385	-0.8527	-0.3845	*****	*****	*****	*****	*****
0.875	*****	-1.7097	-1.2868	-0.8699	-0.3929	*****	*****	*****	*****	*****
0.900	-1.8342	-1.6475	-1.2744	-0.8338	*****	*****	*****	*****	*****	*****
0.925	*****	-1.6280	-1.2441	-0.7850	-0.3743	*****	*****	*****	*****	*****
0.950	-1.8547	-1.6182	-1.2221	-0.7653	-0.3541	*****	*****	*****	*****	*****
0.975	*****	-1.6079	-1.2088	-0.7551	-0.3319	*****	*****	*****	*****	*****
-0.200	$C_{p,l}$	0.5041	0.4362	0.4060	*****	*****	*****	*****	*****	*****
-0.400	*****	0.4961	0.4470	0.3782	0.1765	-0.4591	*****	*****	*****	*****
-0.600	*****	*****	0.4481	0.3738	0.2078	-0.5639	*****	*****	*****	*****
-0.700	*****	*****	0.4369	0.3778	0.2177	-0.5598	*****	*****	*****	*****
-0.800	*****	0.4136	0.4089	0.3651	0.2461	-0.4899	*****	*****	*****	*****
-0.850	*****	0.3474	0.3425	0.3489	0.2510	-0.4624	*****	*****	*****	*****
-0.900	*****	0.2452	0.2834	0.2969	0.2430	-0.3967	*****	*****	*****	*****
-0.950	*****	*****	*****	0.1395	0.1713	-0.0898	*****	*****	*****	*****
-0.975	*****	*****	-0.1317	-0.0501	0.0408	-0.0154	*****	*****	*****	*****

Sharp Radius L.E.
 Run No. = 85 , Point No. = 1867
 $C_N = 1.069$, $C_m = -0.1431$
 $\alpha = 22.6^\circ$, $M_\infty = 0.599$
 $R_{mac} = 6.0 \times 10^6$

Surface Pressures Near Leading Edge

● / ◆ upper, starboard/port
 ○ / ◇ lower, starboard/port

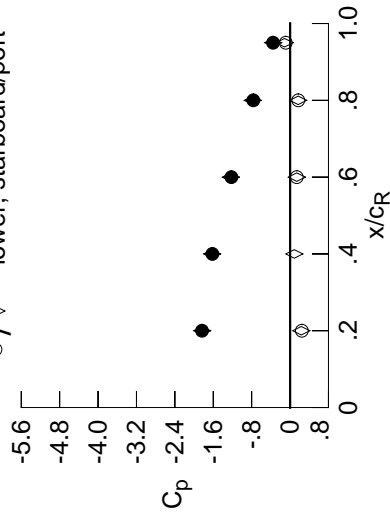

x/c_R	η	starb'd	port	starb'd	port
		$C_{p,u}$	$C_{p,l}$	$C_{p,u}$	$C_{p,l}$
0.20	0.90	-1.8342	-1.8309	0.2339	0.2452
0.40	0.95	-1.6182	-1.6245	0.0877	*****
0.60	0.95	-1.2221	-1.2352	0.1397	0.1395
0.80	0.95	-0.7653	-0.7774	0.1693	0.1713
0.95	0.95	-0.3541	-0.3522	-0.1148	-0.0898

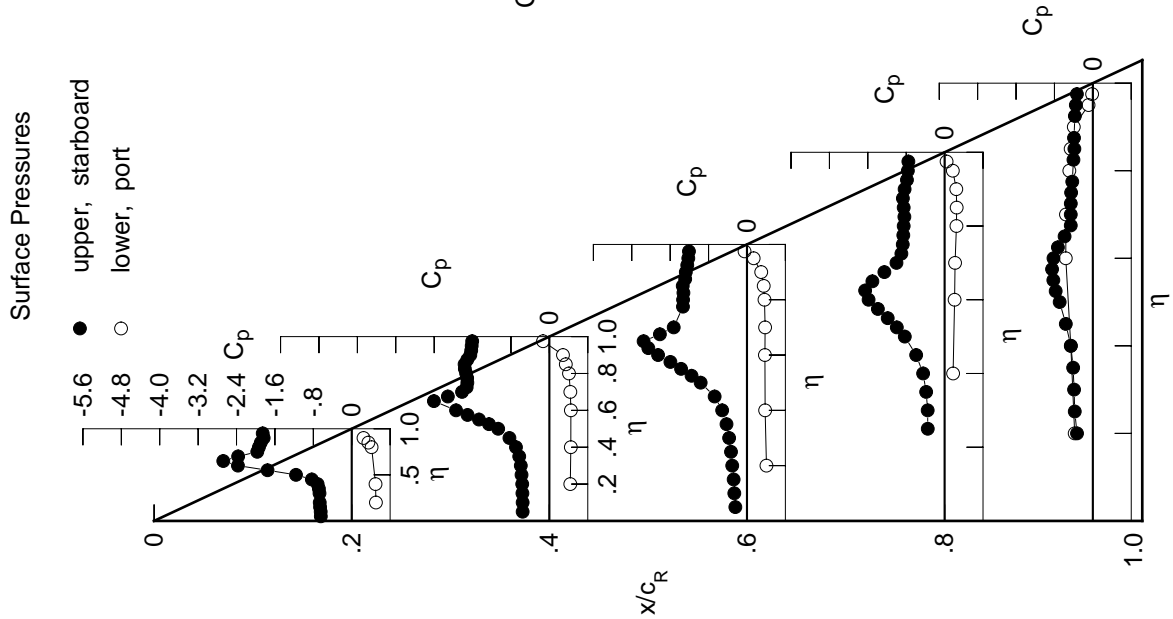

Table D2. Continued.

η	$x/c_R = .2$		$x/c_R = .4$		$x/c_R = .6$		$x/c_R = .8$		$x/c_R = .95$	
	$C_{p,u}$	$C_{p,u}$	$C_{p,u}$	$C_{p,u}$	$C_{p,u}$	$C_{p,u}$	$C_{p,u}$	$C_{p,u}$	$C_{p,u}$	$C_{p,u}$
0.050	-0.6924	-0.5921	-0.2586	*****	*****	*****	*****	*****	*****	*****
0.100	-0.6947	-0.5929	-0.2811	*****	*****	*****	*****	*****	*****	*****
0.150	-0.7097	-0.6007	-0.3000	*****	*****	*****	*****	*****	*****	*****
0.200	-0.7173	-0.6064	-0.3313	*****	*****	*****	*****	*****	*****	*****
0.250	*****	-0.6258	-0.3615	-0.3740	-0.3897	*****	*****	*****	*****	*****
0.300	-0.7266	-0.6467	-0.4059	-0.3821	-0.4150	*****	*****	*****	*****	*****
0.350	-0.7536	-0.6920	-0.4752	-0.4240	-0.4334	*****	*****	*****	*****	*****
0.400	-0.8118	-0.7818	-0.5858	-0.5082	-0.4880	*****	*****	*****	*****	*****
0.450	-0.9981	-0.9481	-0.7726	-0.6664	-0.5918	*****	*****	*****	*****	*****
0.500	-1.4081	-1.2181	-1.0856	-0.9339	-0.7196	*****	*****	*****	*****	*****
0.525	*****	-1.4241	-1.2850	-1.1024	-0.7854	*****	*****	*****	*****	*****
0.550	-2.0055	-1.6350	-1.5045	-1.2999	-0.8191	*****	*****	*****	*****	*****
0.575	*****	-1.8701	-1.7222	-1.5053	-0.8259	*****	*****	*****	*****	*****
0.600	-2.5675	-2.0983	-1.9734	-1.6769	-0.7730	*****	*****	*****	*****	*****
0.625	*****	*****	-2.1663	-1.6147	-0.6748	*****	*****	*****	*****	*****
0.650	-2.6814	-2.3963	-2.1832	-1.3779	-0.5408	*****	*****	*****	*****	*****
0.675	*****	-1.9878	-1.7605	-1.1131	-0.4524	*****	*****	*****	*****	*****
0.700	-2.1935	-1.8218	-1.5009	-0.9420	-0.4630	*****	*****	*****	*****	*****
0.725	*****	-1.7778	*****	-0.8964	-0.4640	*****	*****	*****	*****	*****
0.750	-2.0252	-1.7733	*****	-0.8761	-0.4606	*****	*****	*****	*****	*****
0.775	*****	-1.7773	-1.3777	-0.8636	-0.4418	*****	*****	*****	*****	*****
0.800	-2.0104	-1.7963	-1.3702	-0.8622	*****	*****	*****	*****	*****	*****
0.825	*****	-1.8306	-1.3649	-0.8478	-0.4278	*****	*****	*****	*****	*****
0.850	-1.9632	-1.8323	-1.3766	-0.8518	-0.4092	*****	*****	*****	*****	*****
0.875	*****	-1.7671	-1.3205	-0.8694	-0.4180	*****	*****	*****	*****	*****
0.900	-1.9082	-1.7031	-1.3145	-0.8330	*****	*****	*****	*****	*****	*****
0.925	*****	-1.6817	-1.2855	-0.7875	-0.3982	*****	*****	*****	*****	*****
0.950	-1.9380	-1.6756	-1.2616	-0.7662	-0.3772	*****	*****	*****	*****	*****
0.975	*****	-1.6691	-1.2494	-0.7538	-0.3565	*****	*****	*****	*****	*****
-0.200	$C_{p,l}$	0.5294	0.4614	0.4212	*****	*****	*****	*****	*****	*****
-0.400	*****	0.5217	0.4672	0.4007	0.1903	-0.4630	*****	*****	*****	*****
-0.600	*****	*****	0.4674	0.3903	0.2234	-0.5607	*****	*****	*****	*****
-0.700	*****	*****	0.4555	0.3979	0.2328	-0.5565	*****	*****	*****	*****
-0.800	*****	0.4204	0.4187	0.3778	0.2565	-0.4840	*****	*****	*****	*****
-0.850	*****	0.3478	0.3468	0.3567	0.2610	-0.4544	*****	*****	*****	*****
-0.900	*****	0.2377	0.2791	0.2991	0.2494	-0.3844	*****	*****	*****	*****
-0.950	*****	*****	*****	0.1264	0.1672	-0.0874	*****	*****	*****	*****
-0.975	*****	*****	-0.1573	-0.0740	0.0285	-0.0234	*****	*****	*****	*****

Sharp Radius L.E.
 Run No. = 85 , Point No. = 1868
 $C_N = 1.129$, $C_m = -0.1549$
 $\alpha = 23.6^\circ$, $M_\infty = 0.599$
 $R_{mac} = 6.0 \times 10^6$

Surface Pressures Near Leading Edge

● / ◆ upper, starboard/port
 ○ / ◇ lower, starboard/port

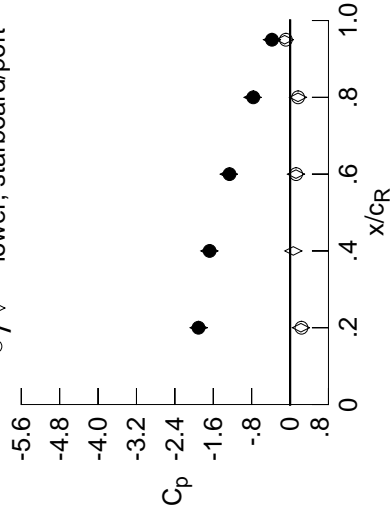

x/c_R	η	starb'd	port	$C_{p,u}$	starb'd	port	$C_{p,l}$
0.20	0.90	-1.9082	-1.9055	0.2253	0.2377	*****	*****
0.40	0.95	-1.6756	-1.6825	0.0676	*****	*****	*****
0.60	0.95	-1.2616	-1.2787	0.1233	0.1264	*****	*****
0.80	0.95	-0.7662	-0.7824	0.1653	0.1672	*****	*****
0.95	0.95	-0.3772	-0.3765	-0.1128	-0.0874	*****	*****

Table D2. Continued.

η	$x/c_R = .2$		$x/c_R = .4$		$x/c_R = .6$		$x/c_R = .8$		$x/c_R = .95$	
	$C_{p,u}$	$C_{p,l}$	$C_{p,u}$	$C_{p,l}$	$C_{p,u}$	$C_{p,l}$	$C_{p,u}$	$C_{p,l}$	$C_{p,u}$	$C_{p,l}$
0.050	-0.7457	-0.6346	-0.2781	*****	*****	*****	*****	*****	*****	*****
0.100	-0.7476	-0.6324	-0.3018	*****	*****	*****	*****	*****	*****	*****
0.150	-0.7648	-0.6455	-0.3207	*****	*****	*****	*****	*****	*****	*****
0.200	-0.7678	-0.6497	-0.3565	*****	*****	*****	*****	*****	*****	*****
0.250	*****	-0.6752	-0.3902	-0.4016	-0.3998	*****	*****	*****	*****	*****
0.300	-0.7894	-0.7060	-0.4457	-0.4169	-0.4393	*****	*****	*****	*****	*****
0.350	-0.8321	-0.7679	-0.5258	-0.4728	-0.4619	*****	*****	*****	*****	*****
0.400	-0.9226	-0.8838	-0.6546	-0.5730	-0.5202	*****	*****	*****	*****	*****
0.450	-1.1689	-1.0870	-0.8609	-0.7549	-0.6287	*****	*****	*****	*****	*****
0.500	-1.6284	-1.3884	-1.1906	-1.0368	-0.7402	*****	*****	*****	*****	*****
0.525	*****	-1.6000	-1.3946	-1.2094	-0.7963	*****	*****	*****	*****	*****
0.550	-2.2103	-1.8101	-1.6130	-1.4081	-0.8076	*****	*****	*****	*****	*****
0.575	*****	-2.0389	-1.8261	-1.6075	-0.7968	*****	*****	*****	*****	*****
0.600	-2.7326	-2.2487	-2.0709	-1.6624	-0.7383	*****	*****	*****	*****	*****
0.625	*****	*****	-2.2621	-1.4677	-0.6353	*****	*****	*****	*****	*****
0.650	-2.5324	-2.3062	-2.1647	-1.2212	-0.5192	*****	*****	*****	*****	*****
0.675	*****	-1.9809	-1.6903	-0.9982	-0.4736	*****	*****	*****	*****	*****
0.700	-2.2427	-1.8829	-1.4874	-0.9215	-0.4965	*****	*****	*****	*****	*****
0.725	*****	-1.8585	*****	-0.9018	-0.4943	*****	*****	*****	*****	*****
0.750	-2.1787	-1.8608	*****	-0.8802	-0.4998	*****	*****	*****	*****	*****
0.775	*****	-1.8607	-1.4271	-0.8769	-0.4821	*****	*****	*****	*****	*****
0.800	-2.1366	-1.8762	-1.4212	-0.8742	*****	*****	*****	*****	*****	*****
0.825	*****	-1.9072	-1.4143	-0.8578	-0.4719	*****	*****	*****	*****	*****
0.850	-2.0559	-1.8970	-1.4308	-0.8556	-0.4516	*****	*****	*****	*****	*****
0.875	*****	-1.8306	-1.3690	-0.8593	-0.4618	*****	*****	*****	*****	*****
0.900	-1.9830	-1.7673	-1.3548	-0.8275	*****	*****	*****	*****	*****	*****
0.925	*****	-1.7426	-1.3260	-0.7897	-0.4318	*****	*****	*****	*****	*****
0.950	-2.0140	-1.7355	-1.3009	-0.7742	-0.4174	*****	*****	*****	*****	*****
0.975	*****	-1.7305	-1.2892	-0.7603	-0.3995	*****	*****	*****	*****	*****
-0.200	*****	0.5557	0.4813	0.4430	*****	*****	*****	*****	*****	*****
-0.400	*****	0.5469	0.4876	0.4142	0.2069	-0.4625	*****	*****	*****	*****
-0.600	*****	*****	0.4852	0.4091	0.2381	-0.5625	*****	*****	*****	*****
-0.700	*****	*****	0.4716	0.4125	0.2453	-0.5498	*****	*****	*****	*****
-0.800	*****	0.4270	0.4290	0.3897	0.2716	-0.4798	*****	*****	*****	*****
-0.850	*****	0.3485	0.3494	0.3649	0.2717	-0.4490	*****	*****	*****	*****
-0.900	*****	0.2300	0.2778	0.2972	0.2538	-0.3768	*****	*****	*****	*****
-0.950	*****	*****	*****	0.1126	0.1617	-0.0857	*****	*****	*****	*****
-0.975	*****	*****	-0.1879	-0.0973	0.0167	-0.0340	*****	*****	*****	*****

Sharp Radius L.E.
 Run No. = 85 , Point No. = 1869
 $C_N = 1.180$, $C_m = -0.1595$
 $\alpha = 24.6^\circ$, $M_\infty = 0.599$
 $R_{mac} = 6.0 \times 10^6$

Surface Pressures Near Leading Edge

● / ◆ upper, starboard/port
 ○ / ◇ lower, starboard/port

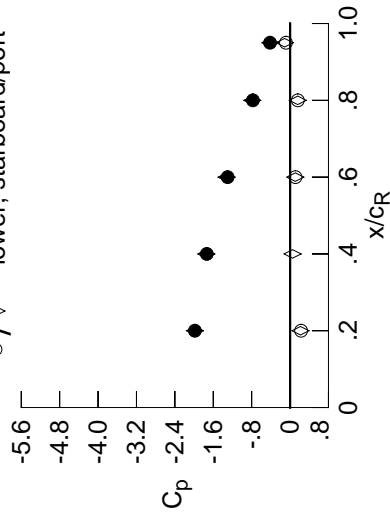

x/c_R	η	starb'd	port	$C_{p,u}$	starb'd	port	$C_{p,l}$
0.20	0.90	-1.9830	-1.9819	0.2169	0.2300	*****	*****
0.40	0.95	-1.7355	-1.7462	0.0519	*****	*****	*****
0.60	0.95	-1.3009	-1.3236	0.1089	0.1126	*****	*****
0.80	0.95	-0.7742	-0.7880	0.1596	0.1617	*****	*****
0.95	0.95	-0.4174	-0.4115	-0.1125	-0.0857	*****	*****

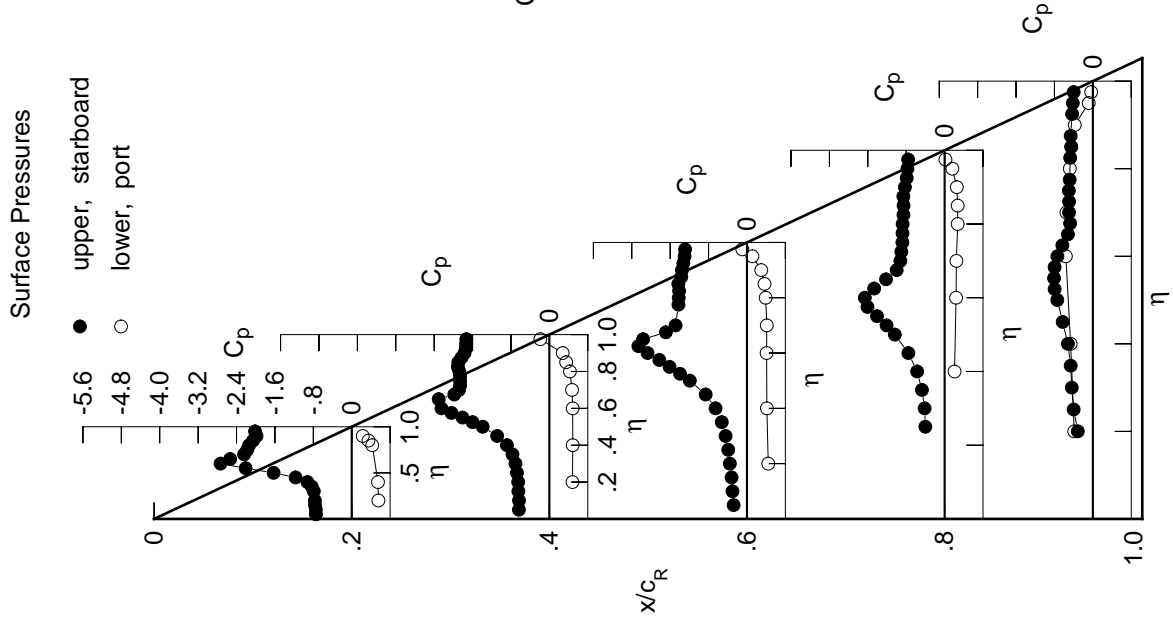

Table D2. Continued.

η	$x/c_R = .2$		$x/c_R = .4$		$x/c_R = .6$		$x/c_R = .8$		$x/c_R = .95$	
	$C_{p,u}$	$C_{p,l}$	$C_{p,u}$	$C_{p,l}$	$C_{p,u}$	$C_{p,l}$	$C_{p,u}$	$C_{p,l}$	$C_{p,u}$	$C_{p,l}$
0.050	-0.7960	-0.6685	-0.2975	*****	*****	*****	*****	*****	*****	*****
0.100	-0.7977	-0.6693	-0.3190	*****	*****	*****	*****	*****	*****	*****
0.150	-0.8203	-0.6817	-0.3432	*****	*****	*****	*****	*****	*****	*****
0.200	-0.8224	-0.6879	-0.3787	*****	*****	*****	*****	*****	*****	*****
0.250	*****	-0.7151	-0.4200	-0.4352	-0.4017	*****	*****	*****	*****	-0.2974
0.300	-0.8545	-0.7545	-0.4824	-0.4577	-0.4563	*****	*****	*****	*****	-0.4017
0.350	-0.9096	-0.8223	-0.5765	-0.5273	-0.4892	*****	*****	*****	*****	-0.4563
0.400	-1.0167	-0.9636	-0.7216	-0.6471	-0.5536	*****	*****	*****	*****	-0.4892
0.450	-1.2778	-1.1947	-0.9463	-0.8528	-0.6611	*****	*****	*****	*****	-0.5536
0.500	-1.7404	-1.5300	-1.2906	-1.1494	-0.7555	*****	*****	*****	*****	-0.6611
0.525	*****	-1.7540	-1.4893	-1.3276	-0.7970	*****	*****	*****	*****	-0.7555
0.550	-2.3122	-1.9737	-1.7108	-1.5203	-0.7958	*****	*****	*****	*****	-0.7970
0.575	*****	-2.1989	-1.9144	-1.6329	-0.7748	*****	*****	*****	*****	-0.7958
0.600	-2.8204	-2.3950	-2.1518	-1.5002	-0.7114	*****	*****	*****	*****	-0.7748
0.625	*****	*****	-2.3301	-1.2977	-0.6201	*****	*****	*****	*****	-0.7114
0.650	-2.3723	-2.3163	-1.9494	-1.0708	-0.5268	*****	*****	*****	*****	-0.6201
0.675	*****	-2.0161	-1.6064	-0.9350	-0.5087	*****	*****	*****	*****	-0.5268
0.700	-2.2657	-1.9398	-1.4934	-0.9263	-0.5367	*****	*****	*****	*****	-0.5087
0.725	*****	-1.9263	*****	-0.9068	-0.5458	*****	*****	*****	*****	-0.5367
0.750	-2.2582	-1.9393	*****	-0.8948	-0.5574	*****	*****	*****	*****	-0.5458
0.775	*****	-1.9477	-1.4631	-0.8893	-0.5501	*****	*****	*****	*****	-0.5574
0.800	-2.2935	-1.9717	-1.4629	-0.8885	*****	*****	*****	*****	*****	-0.5501
0.825	*****	-2.0133	-1.4633	-0.8728	-0.5379	*****	*****	*****	*****	*****
0.850	-2.1675	-2.0173	-1.4847	-0.8638	-0.5108	*****	*****	*****	*****	-0.5379
0.875	*****	-1.9393	-1.4126	-0.8555	-0.5292	*****	*****	*****	*****	-0.5108
0.900	-2.0487	-1.8439	-1.3977	-0.8245	*****	*****	*****	*****	*****	-0.5292
0.925	*****	-1.7969	-1.3650	-0.8008	-0.5063	*****	*****	*****	*****	*****
0.950	-2.0872	-1.7813	-1.3449	-0.7840	-0.4972	*****	*****	*****	*****	-0.5063
0.975	*****	-1.7784	-1.3334	-0.7695	-0.4809	*****	*****	*****	*****	-0.4972
-0.200	0.5816	0.5058	0.4589	*****	-0.3899	*****	*****	*****	*****	*****
-0.400	0.5712	0.5080	0.4364	0.2198	-0.4718	*****	*****	*****	*****	-0.3899
-0.600	*****	0.5053	0.4256	0.2519	-0.5581	*****	*****	*****	*****	-0.4718
-0.700	*****	0.4894	0.4294	0.2606	-0.5492	*****	*****	*****	*****	-0.5581
-0.800	0.4322	0.4379	0.4025	0.2830	-0.4723	*****	*****	*****	*****	-0.5492
-0.850	0.3466	0.3530	0.3702	0.2803	-0.4421	*****	*****	*****	*****	-0.4723
-0.900	0.2217	0.2726	0.2975	0.2579	-0.3670	*****	*****	*****	*****	-0.4421
-0.950	*****	*****	0.0991	0.1575	-0.0858	*****	*****	*****	*****	-0.3670
-0.975	*****	-0.2147	-0.1215	0.0041	-0.0446	*****	*****	*****	*****	-0.0858

Sharp Radius L.E.
 Run No. = 85 , Point No. = 1870
 $C_N = 1.237$, $C_m = -0.1706$
 $\alpha = 25.7^\circ$, $M_\infty = 0.599$
 $R_{mac} = 6.0 \times 10^6$

Surface Pressures Near Leading Edge

● / ◆ upper, starboard/port
 ○ / ◇ lower, starboard/port

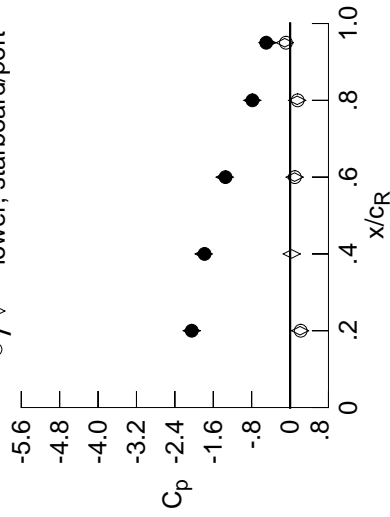

x/c_R	η	starb'd	port	starb'd	port
		$C_{p,u}$	$C_{p,l}$	$C_{p,u}$	$C_{p,l}$
0.20	0.90	-2.0487	-2.0503	0.2079	0.2217
0.40	0.95	-1.7813	-1.8025	0.0337	*****
0.60	0.95	-1.3449	-1.3650	0.0936	0.0991
0.80	0.95	-0.7840	-0.7878	0.1479	0.1575
0.95	0.95	-0.4972	-0.4731	-0.1104	-0.0858

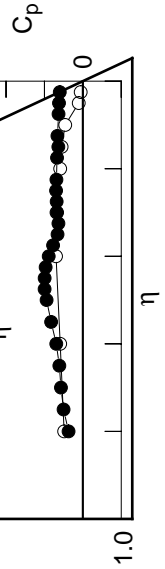

Table D2. Continued.

η	$x/c_R = .2$		$x/c_R = .4$		$x/c_R = .6$		$x/c_R = .8$		$x/c_R = .95$	
	$C_{p,u}$	$C_{p,u}$	$C_{p,u}$	$C_{p,u}$	$C_{p,u}$	$C_{p,u}$	$C_{p,u}$	$C_{p,u}$	$C_{p,u}$	$C_{p,u}$
0.050	-0.8544	-0.7063	-0.3159	*****	*****	*****	*****	*****	*****	*****
0.100	-0.8581	-0.7113	-0.3404	*****	*****	*****	*****	*****	*****	*****
0.150	-0.8790	-0.7223	-0.3655	*****	*****	*****	*****	*****	*****	*****
0.200	-0.8879	-0.7355	-0.4054	*****	*****	*****	*****	*****	*****	*****
0.250	*****	-0.7638	-0.4506	-0.4629	-0.4006	*****	*****	*****	*****	*****
0.300	-0.9357	-0.8159	-0.5261	-0.4981	-0.4707	*****	*****	*****	*****	*****
0.350	-1.0132	-0.8982	-0.6309	-0.5775	-0.5102	*****	*****	*****	*****	*****
0.400	-1.1579	-1.0563	-0.7972	-0.7140	-0.5816	*****	*****	*****	*****	*****
0.450	-1.4648	-1.3062	-1.0383	-0.9326	-0.6834	*****	*****	*****	*****	*****
0.500	-1.9414	-1.6514	-1.3934	-1.2409	-0.7684	*****	*****	*****	*****	*****
0.525	*****	-1.8776	-1.5946	-1.4178	-0.8007	*****	*****	*****	*****	*****
0.550	-2.4791	-2.0898	-1.8091	-1.5890	-0.7918	*****	*****	*****	*****	*****
0.575	*****	-2.3069	-2.0091	-1.5505	-0.7667	*****	*****	*****	*****	*****
0.600	-2.8511	-2.4877	-2.2297	-1.4037	-0.7059	*****	*****	*****	*****	*****
0.625	*****	*****	-2.3914	-1.2073	-0.6256	*****	*****	*****	*****	*****
0.650	-2.3538	-2.2666	-1.8775	-1.0082	-0.5462	*****	*****	*****	*****	*****
0.675	*****	-2.0421	-1.5991	-0.9478	-0.5397	*****	*****	*****	*****	*****
0.700	-2.3071	-1.9748	-1.5220	-0.9495	-0.5702	*****	*****	*****	*****	*****
0.725	*****	-1.9576	*****	-0.9301	-0.5887	*****	*****	*****	*****	*****
0.750	-2.3197	-1.9723	*****	-0.9113	-0.6089	*****	*****	*****	*****	*****
0.775	*****	-1.9876	-1.5001	-0.9058	-0.5986	*****	*****	*****	*****	*****
0.800	-2.3554	-2.0166	-1.4973	-0.8985	*****	*****	*****	*****	*****	*****
0.825	*****	-2.0722	-1.5005	-0.8814	-0.5912	*****	*****	*****	*****	*****
0.850	-2.2125	-2.0800	-1.5260	-0.8720	-0.5634	*****	*****	*****	*****	*****
0.875	*****	-1.9914	-1.4542	-0.8608	-0.5875	*****	*****	*****	*****	*****
0.900	-2.1230	-1.8929	-1.4347	-0.8284	*****	*****	*****	*****	*****	*****
0.925	*****	-1.8475	-1.4024	-0.8073	-0.5660	*****	*****	*****	*****	*****
0.950	-2.1707	-1.8392	-1.3742	-0.7932	-0.5543	*****	*****	*****	*****	*****
0.975	*****	-1.8338	-1.3603	-0.7807	-0.5361	*****	*****	*****	*****	*****
-0.200	$C_{p,l}$	0.6021	0.5263	0.4741	*****	*****	*****	*****	*****	*****
-0.400	$C_{p,l}$	0.5917	0.5266	0.4551	0.2369	-0.4730	*****	*****	*****	*****
-0.600	$C_{p,l}$	*****	0.5242	0.4411	0.2638	-0.5501	*****	*****	*****	*****
-0.700	$C_{p,l}$	*****	0.5043	0.4416	0.2745	-0.5386	*****	*****	*****	*****
-0.800	$C_{p,l}$	0.4356	0.4446	0.4108	0.2917	-0.4630	*****	*****	*****	*****
-0.850	$C_{p,l}$	0.3427	0.3549	0.3767	0.2889	-0.4309	*****	*****	*****	*****
-0.900	$C_{p,l}$	0.2117	0.2602	0.2933	0.2594	-0.3560	*****	*****	*****	*****
-0.950	$C_{p,l}$	*****	*****	0.0829	0.1483	-0.0833	*****	*****	*****	*****
-0.975	$C_{p,l}$	*****	-0.2412	-0.1445	-0.0132	-0.0556	*****	*****	*****	*****

Sharp Radius L.E.

Run No. = 85, Point No. = 1871

$C_N = 1.286$, $C_m = -0.1746$

$\alpha = 26.7^\circ$, $M_\infty = 0.599$

$R_{mac} = 6.0 \times 10^6$

Surface Pressures Near Leading Edge

● / ◆ upper, starboard/port
○ / ◇ lower, starboard/port

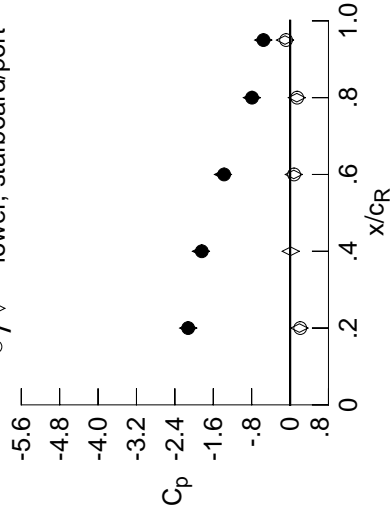

x/cR	η	$C_{p,u}$ starb'd	$C_{p,u}$ port	$C_{p,l}$ starb'd	$C_{p,l}$ port
0.20	0.90	-2.1230	-2.1222	0.1946	0.2117
0.40	0.95	-1.8392	-1.8565	0.0127	*****
0.60	0.95	-1.3742	-1.3977	0.0775	0.0829
0.80	0.95	-0.7932	-0.7962	0.1410	0.1483
0.95	0.95	-0.5543	-0.5589	-0.1058	-0.0833

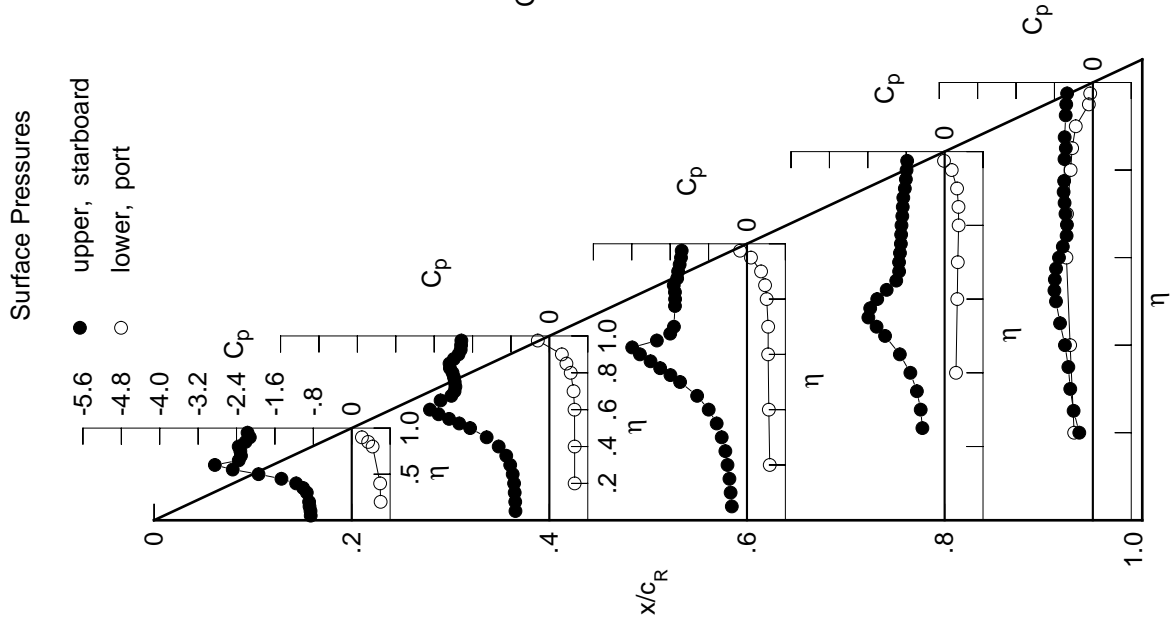

Table D2. Concluded.

η	$x/c_R = .2$		$x/c_R = .4$		$x/c_R = .6$		$x/c_R = .8$		$x/c_R = .95$	
	$C_{p,u}$	$C_{p,l}$	$C_{p,u}$	$C_{p,l}$	$C_{p,u}$	$C_{p,l}$	$C_{p,u}$	$C_{p,l}$	$C_{p,u}$	$C_{p,l}$
0.050	-0.0159	-0.0038	0.1028	0.1028	0.1028	0.1028	0.1028	0.1028	0.1028	0.1028
0.100	-0.0128	-0.0068	0.0921	0.0921	0.0921	0.0921	0.0921	0.0921	0.0921	0.0921
0.150	-0.0136	-0.0052	0.0755	0.0755	0.0755	0.0755	0.0755	0.0755	0.0755	0.0755
0.200	-0.0210	-0.0079	0.0635	0.0635	0.0635	0.0635	0.0635	0.0635	0.0635	0.0635
0.250	*****	-0.0054	0.0510	-0.1025	0.0510	-0.1025	0.0510	-0.1025	0.0510	-0.1025
0.300	-0.0441	-0.0052	0.0386	-0.0936	0.0386	-0.0936	0.0386	-0.0936	0.0386	-0.0936
0.350	-0.0500	-0.0082	0.0298	-0.0850	0.0298	-0.0850	0.0298	-0.0850	0.0298	-0.0850
0.400	-0.0605	-0.0126	0.0173	-0.0747	0.0173	-0.0747	0.0173	-0.0747	0.0173	-0.0747
0.450	-0.0668	-0.0113	0.0187	-0.0757	0.0187	-0.0757	0.0187	-0.0757	0.0187	-0.0757
0.500	-0.0743	-0.0143	0.0073	-0.0688	0.0073	-0.0688	0.0073	-0.0688	0.0073	-0.0688
0.525	*****	-0.0163	0.0036	-0.0709	0.0036	-0.0709	0.0036	-0.0709	0.0036	-0.0709
0.550	-0.0764	-0.0215	0.0017	-0.0701	0.0017	-0.0701	0.0017	-0.0701	0.0017	-0.0701
0.575	*****	-0.0289	0.0042	-0.0690	0.0042	-0.0690	0.0042	-0.0690	0.0042	-0.0690
0.600	-0.0621	-0.0258	-0.0005	-0.0696	-0.0005	-0.0696	-0.0005	-0.0696	-0.0005	-0.0696
0.625	*****	*****	-0.0087	-0.0691	-0.0087	-0.0691	-0.0087	-0.0691	-0.0087	-0.0691
0.650	-0.0540	-0.0338	-0.0038	-0.0691	-0.0038	-0.0691	-0.0038	-0.0691	-0.0038	-0.0691
0.675	*****	-0.0542	-0.0167	-0.0698	-0.0167	-0.0698	-0.0167	-0.0698	-0.0167	-0.0698
0.700	-0.0468	-0.0654	-0.0188	-0.0718	-0.0188	-0.0718	-0.0188	-0.0718	-0.0188	-0.0718
0.725	*****	-0.0761	*****	-0.0773	-0.0773	-0.0773	-0.0773	-0.0773	-0.0773	-0.0773
0.750	-0.0300	-0.0777	*****	-0.0828	-0.0828	-0.0828	-0.0828	-0.0828	-0.0828	-0.0828
0.775	*****	-0.0932	-0.0378	-0.0771	-0.0378	-0.0771	-0.0378	-0.0771	-0.0378	-0.0771
0.800	-0.0151	-0.0839	-0.0673	-0.0804	-0.0673	-0.0804	-0.0673	-0.0804	-0.0673	-0.0804
0.825	*****	-0.0784	-0.0826	-0.0868	-0.0826	-0.0868	-0.0826	-0.0868	-0.0826	-0.0868
0.850	0.0089	-0.0649	-0.0799	-0.1176	-0.0799	-0.1176	-0.0799	-0.1176	-0.0799	-0.1176
0.875	*****	-0.0562	-0.0785	-0.1393	-0.0785	-0.1393	-0.0785	-0.1393	-0.0785	-0.1393
0.900	0.0462	-0.0368	-0.0735	-0.1422	-0.0735	-0.1422	-0.0735	-0.1422	-0.0735	-0.1422
0.925	*****	-0.0042	-0.0418	-0.1179	-0.0418	-0.1179	-0.0418	-0.1179	-0.0418	-0.1179
0.950	0.0949	0.0396	-0.0078	-0.0782	-0.0078	-0.0782	-0.0078	-0.0782	-0.0078	-0.0782
0.975	*****	0.0864	0.0539	-0.0014	-0.0014	-0.0014	-0.0014	-0.0014	-0.0014	-0.0014
-0.200	-0.0450	-0.0074	0.0585	0.0585	0.0585	0.0585	0.0585	0.0585	0.0585	0.0585
-0.400	-0.0568	-0.0124	0.0187	-0.0800	0.0187	-0.0800	0.0187	-0.0800	0.0187	-0.0800
-0.600	*****	-0.0181	-0.0079	-0.0756	-0.0079	-0.0756	-0.0079	-0.0756	-0.0079	-0.0756
-0.700	*****	-0.0611	-0.0225	-0.0778	-0.0225	-0.0778	-0.0225	-0.0778	-0.0225	-0.0778
-0.800	-0.0343	-0.0919	-0.0735	-0.0899	-0.0735	-0.0899	-0.0735	-0.0899	-0.0735	-0.0899
-0.850	0.0009	-0.0741	-0.0897	-0.1335	-0.0897	-0.1335	-0.0897	-0.1335	-0.0897	-0.1335
-0.900	0.0351	-0.0446	-0.0932	-0.1533	-0.0932	-0.1533	-0.0932	-0.1533	-0.0932	-0.1533
-0.950	*****	*****	-0.0226	-0.1061	-0.0226	-0.1061	-0.0226	-0.1061	-0.0226	-0.1061
-0.975	*****	0.0783	0.0315	-0.0290	-0.0290	-0.0290	-0.0290	-0.0290	-0.0290	-0.0290

Sharp Radius L.E.
 Run No. = 85 , Point No. = 1872
 $C_N = -0.009$, $C_m = -0.0029$
 $\alpha = 0.1^\circ$, $M_\infty = 0.600$
 $R_{mac} = 6.0 \times 10^6$

Surface Pressures Near Leading Edge

● / ◆ upper, starboard/port
 ○ / ◇ lower, starboard/port

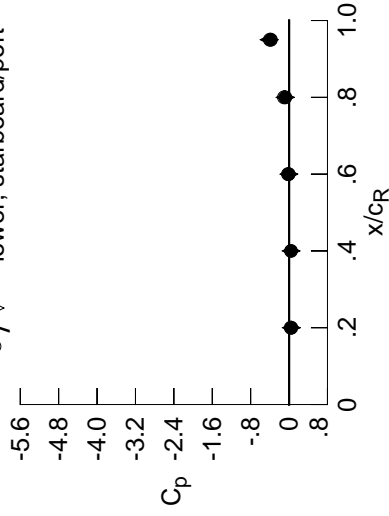

x/c_R	η	starb'd	port	starb'd	port
		$C_{p,u}$	$C_{p,l}$	$C_{p,u}$	$C_{p,l}$
0.20	0.90	0.0462	0.0518	0.0418	0.0351
0.40	0.95	0.0396	0.0467	0.0386	*****
0.60	0.95	-0.0078	0.0014	-0.0090	-0.0226
0.80	0.95	-0.0782	-0.0693	-0.0911	-0.1061
0.95	0.95	-0.3792	-0.4083	-0.4227	-0.4010

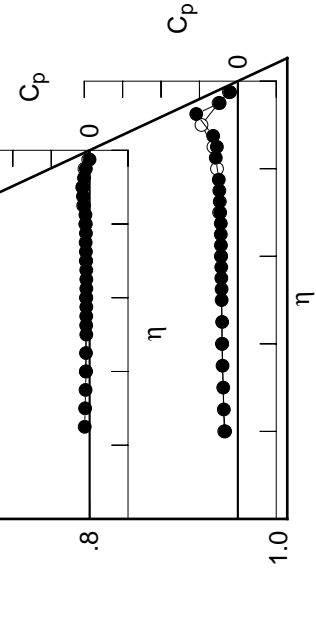

Table D3. Tabulations and Plots of Surface Pressure Coefficients.

η	$x/c_R = .2$		$x/c_R = .4$		$x/c_R = .6$		$x/c_R = .8$		$x/c_R = .95$	
	$C_{p,u}$	$C_{p,l}$	$C_{p,u}$	$C_{p,l}$	$C_{p,u}$	$C_{p,l}$	$C_{p,u}$	$C_{p,l}$	$C_{p,u}$	$C_{p,l}$
0.050	-0.0096	0.0061	0.1200	0.1200	0.1200	0.1200	0.1200	0.1200	0.1200	0.1200
0.100	-0.0052	0.0023	0.1102	0.1102	0.1102	0.1102	0.1102	0.1102	0.1102	0.1102
0.150	-0.0060	0.0049	0.0971	0.0971	0.0971	0.0971	0.0971	0.0971	0.0971	0.0971
0.200	-0.0096	0.0028	0.0857	0.0857	0.0857	0.0857	0.0857	0.0857	0.0857	0.0857
0.250	*****	0.0045	0.0735	-0.1246	0.0735	-0.1246	0.0735	-0.1246	0.0735	-0.1246
0.300	-0.0287	0.0034	0.0593	-0.1086	0.0593	-0.1086	0.0593	-0.1086	0.0593	-0.1086
0.350	-0.0369	0.0034	0.0504	-0.1022	0.0504	-0.1022	0.0504	-0.1022	0.0504	-0.1022
0.400	-0.0461	-0.0028	0.0414	-0.0888	0.0414	-0.0888	0.0414	-0.0888	0.0414	-0.0888
0.450	-0.0577	-0.0010	0.0400	-0.0851	0.0400	-0.0851	0.0400	-0.0851	0.0400	-0.0851
0.500	-0.0611	-0.0044	0.0266	-0.0788	0.0266	-0.0788	0.0266	-0.0788	0.0266	-0.0788
0.525	*****	-0.0085	0.0279	-0.0774	0.0279	-0.0774	0.0279	-0.0774	0.0279	-0.0774
0.550	-0.0607	-0.0108	0.0194	-0.0750	0.0194	-0.0750	0.0194	-0.0750	0.0194	-0.0750
0.575	*****	-0.0163	0.0241	-0.0748	0.0241	-0.0748	0.0241	-0.0748	0.0241	-0.0748
0.600	-0.0442	-0.0168	0.0150	-0.0724	0.0150	-0.0724	0.0150	-0.0724	0.0150	-0.0724
0.625	*****	0.0135	-0.0748	-0.4210	0.0135	-0.0748	-0.4210	0.0135	-0.0748	-0.4210
0.650	-0.0348	-0.0217	0.0101	-0.0701	0.0101	-0.0701	0.0101	-0.0701	0.0101	-0.0701
0.675	*****	-0.0271	0.0052	-0.0712	0.0052	-0.0712	0.0052	-0.0712	0.0052	-0.0712
0.700	-0.0226	-0.0413	-0.0011	-0.0743	-0.0450	-0.0743	-0.0450	-0.0743	-0.0450	-0.0743
0.725	*****	-0.0514	*****	-0.0724	-0.4711	*****	-0.0724	-0.4711	*****	-0.0724
0.750	-0.0110	-0.0575	*****	-0.0778	-0.4913	*****	-0.0778	-0.4913	*****	-0.0778
0.775	*****	-0.0712	-0.0180	-0.0723	-0.5162	*****	-0.0723	-0.5162	*****	-0.0723
0.800	0.0075	-0.0642	-0.0363	-0.0808	*****	*****	-0.0808	*****	*****	*****
0.825	*****	-0.0558	-0.0469	-0.0875	-0.6448	*****	-0.0875	-0.6448	*****	-0.0875
0.850	0.0355	-0.0444	-0.0534	-0.1013	-0.5754	*****	-0.1013	-0.5754	*****	-0.5754
0.875	*****	-0.0299	-0.0483	-0.1189	-0.6889	*****	-0.1189	-0.6889	*****	-0.6889
0.900	0.0740	-0.0100	-0.0344	-0.1181	*****	*****	-0.1181	*****	*****	*****
0.925	*****	0.0248	-0.0083	-0.0918	-0.7527	*****	-0.0918	-0.7527	*****	-0.7527
0.950	0.1199	0.0682	0.0264	-0.0510	-0.3490	*****	-0.0510	-0.3490	*****	-0.3490
0.975	*****	0.1115	0.0903	0.0275	-0.1479	*****	0.0275	-0.1479	*****	-0.1479
-0.200	-0.0518	-0.0143	0.0730	*****	-0.2972	*****	*****	-0.2972	*****	*****
-0.400	-0.0772	-0.0139	0.0251	-0.1020	-0.3613	*****	-0.1020	-0.3613	*****	-0.3613
-0.600	*****	-0.0288	0.0000	-0.0923	-0.3904	*****	-0.0923	-0.3904	*****	-0.3904
-0.700	*****	-0.0777	-0.0215	-0.0928	-0.5116	*****	-0.0928	-0.5116	*****	-0.5116
-0.800	-0.0484	-0.1115	-0.0862	-0.1017	-0.7361	*****	-0.1017	-0.7361	*****	-0.7361
-0.850	-0.0152	-0.0930	-0.1076	-0.1530	-0.7529	*****	-0.1530	-0.7529	*****	-0.7529
-0.900	0.0220	-0.0665	-0.1111	-0.1815	-0.9566	*****	-0.1815	-0.9566	*****	-0.9566
-0.950	*****	*****	-0.0427	-0.1344	-0.4057	*****	-0.1344	-0.4057	*****	-0.4057
-0.975	*****	0.0553	0.0135	-0.0605	-0.2232	*****	-0.0605	-0.2232	*****	-0.2232

Sharp Radius L.E.

Run No. = 86 , Point No. = 1873

$C_N = -0.034$, $C_m = 0.0066$

$\alpha = -0.4^\circ$, $M_\infty = 0.799$

$R_{mac} = 6.0 \times 10^6$

Surface Pressures Near Leading Edge

● / ◆ upper, starboard/port
○ / ◇ lower, starboard/port

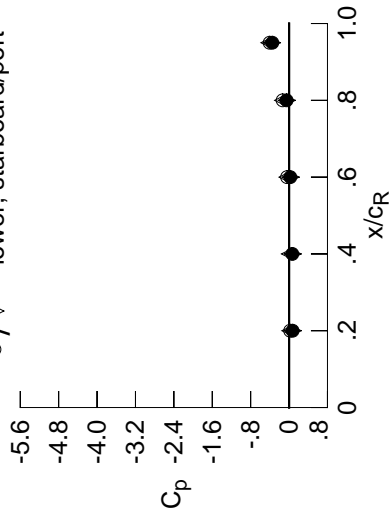

x/c_R	η	starb'd	port	$C_{p,u}$	starb'd	port	$C_{p,l}$
0.20	0.90	0.0740	0.0752	0.0272	0.0220	0.0220	0.0220
0.40	0.95	0.0682	0.0745	0.0182	*****	0.0182	*****
0.60	0.95	0.0264	0.0332	-0.0316	-0.0427	-0.0316	-0.0427
0.80	0.95	-0.0510	-0.0477	-0.1225	-0.1344	-0.1225	-0.1344
0.95	0.95	-0.3490	-0.3573	-0.4086	-0.4057	-0.4086	-0.4057

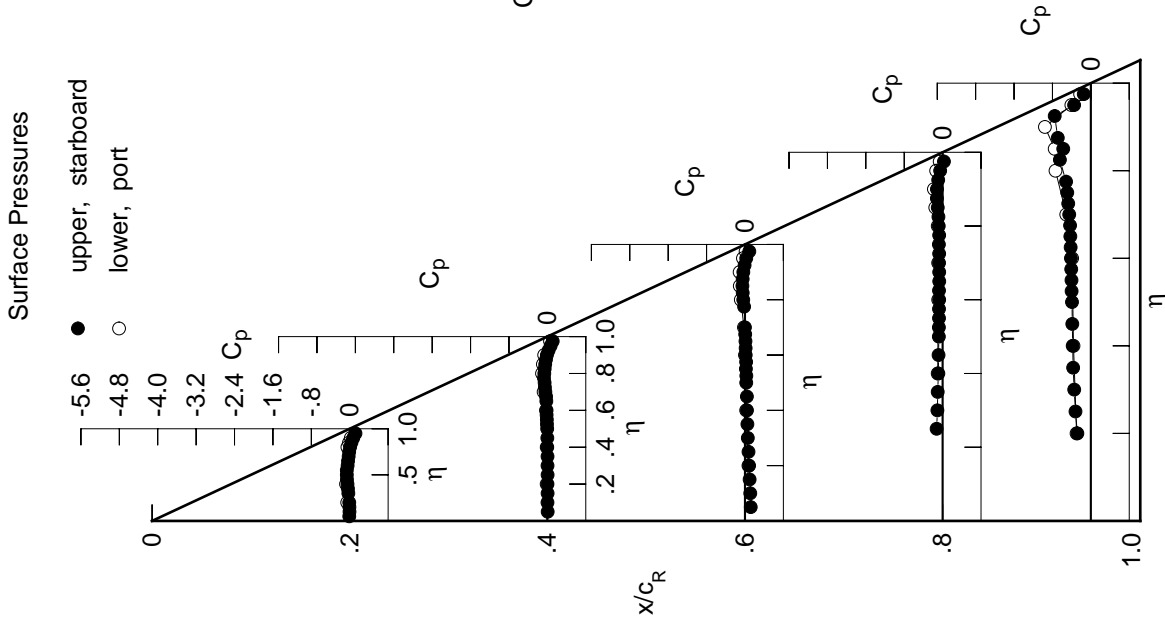

Table D3. Continued.

η	$x/c_R = .2$		$x/c_R = .4$		$x/c_R = .6$		$x/c_R = .8$		$x/c_R = .95$	
	$C_{p,u}$	$C_{p,l}$	$C_{p,u}$	$C_{p,l}$	$C_{p,u}$	$C_{p,l}$	$C_{p,u}$	$C_{p,l}$	$C_{p,u}$	$C_{p,l}$
0.050	-0.0134	-0.0036	0.1159	*****	*****	*****	*****	*****	*****	*****
0.100	-0.0123	-0.0065	0.1050	*****	*****	*****	*****	*****	*****	*****
0.150	-0.0156	-0.0072	0.0914	*****	*****	*****	*****	*****	*****	*****
0.200	-0.0240	-0.0037	0.0788	*****	*****	*****	*****	*****	*****	*****
0.250	*****	-0.0067	0.0645	-0.1308	-0.3188	*****	*****	*****	*****	*****
0.300	-0.0438	-0.0045	0.0541	-0.1154	-0.3442	*****	*****	*****	*****	*****
0.350	-0.0528	-0.0064	0.0412	-0.1068	-0.3633	*****	*****	*****	*****	*****
0.400	-0.0611	-0.0135	0.0355	-0.0950	-0.3757	*****	*****	*****	*****	*****
0.450	-0.0695	-0.0125	0.0324	-0.0920	-0.3822	*****	*****	*****	*****	*****
0.500	-0.0740	-0.0167	0.0196	-0.0857	-0.3911	*****	*****	*****	*****	*****
0.525	*****	-0.0167	0.0175	-0.0843	-0.4003	*****	*****	*****	*****	*****
0.550	-0.0752	-0.0228	0.0128	-0.0828	-0.4032	*****	*****	*****	*****	*****
0.575	*****	-0.0274	0.0157	-0.0801	-0.4108	*****	*****	*****	*****	*****
0.600	-0.0604	-0.0290	0.0075	-0.0796	-0.4164	*****	*****	*****	*****	*****
0.625	*****	*****	0.0045	-0.0813	-0.4216	*****	*****	*****	*****	*****
0.650	-0.0522	-0.0303	-0.0001	-0.0809	-0.4303	*****	*****	*****	*****	*****
0.675	*****	-0.0409	-0.0060	-0.0808	-0.4358	*****	*****	*****	*****	*****
0.700	-0.0432	-0.0621	-0.0104	-0.0827	-0.4551	*****	*****	*****	*****	*****
0.725	*****	-0.0755	*****	-0.0826	-0.4730	*****	*****	*****	*****	*****
0.750	-0.0279	-0.0821	*****	-0.0866	-0.4992	*****	*****	*****	*****	*****
0.775	*****	-0.0909	-0.0298	-0.0861	-0.5210	*****	*****	*****	*****	*****
0.800	-0.0109	-0.0866	-0.0580	-0.0902	*****	*****	*****	*****	*****	*****
0.825	*****	-0.0786	-0.0719	-0.0941	-0.6464	*****	*****	*****	*****	*****
0.850	0.0170	-0.0666	-0.0744	-0.1218	-0.5839	*****	*****	*****	*****	*****
0.875	*****	-0.0554	-0.0723	-0.1440	-0.6386	*****	*****	*****	*****	*****
0.900	0.0568	-0.0342	-0.0611	-0.1430	*****	*****	*****	*****	*****	*****
0.925	*****	0.0021	-0.0348	-0.1191	-0.6755	*****	*****	*****	*****	*****
0.950	0.1015	0.0445	0.0005	-0.0801	-0.3570	*****	*****	*****	*****	*****
0.975	*****	0.0910	0.0651	-0.0011	-0.1647	*****	*****	*****	*****	*****

η	$C_{p,l}$		$C_{p,i}$		$C_{p,u}$		$C_{p,i}$		$C_{p,l}$	
	$C_{p,l}$	$C_{p,i}$	$C_{p,l}$	$C_{p,i}$	$C_{p,l}$	$C_{p,i}$	$C_{p,l}$	$C_{p,i}$	$C_{p,l}$	$C_{p,i}$
-0.200	-0.0440	-0.0074	0.0763	*****	*****	*****	*****	*****	*****	*****
-0.400	-0.0579	-0.0078	0.0310	-0.1001	-0.3671	*****	*****	*****	*****	*****
-0.600	*****	-0.0209	0.0046	-0.0853	-0.4058	*****	*****	*****	*****	*****
-0.700	*****	-0.0583	-0.0086	-0.0879	-0.5068	*****	*****	*****	*****	*****
-0.800	-0.0292	-0.0928	-0.0676	-0.0967	-0.7321	*****	*****	*****	*****	*****
-0.850	0.0030	-0.0725	-0.0864	-0.1395	-0.7632	*****	*****	*****	*****	*****
-0.900	0.0400	-0.0415	-0.0843	-0.1601	-0.9661	*****	*****	*****	*****	*****
-0.950	*****	*****	-0.0134	-0.1055	-0.3871	*****	*****	*****	*****	*****
-0.975	*****	0.0806	0.0430	-0.0296	-0.1988	*****	*****	*****	*****	*****

Sharp Radius L.E.
 Run No. = 86 , Point No. = 1874
 $C_N = -0.013$, $C_m = 0.0017$
 $\alpha = 0.1^\circ$, $M_\infty = 0.799$
 $R_{mac} = 6.0 \times 10^6$

Surface Pressures Near Leading Edge

● / ◆ upper, starboard/port
 ○ / ◇ lower, starboard/port

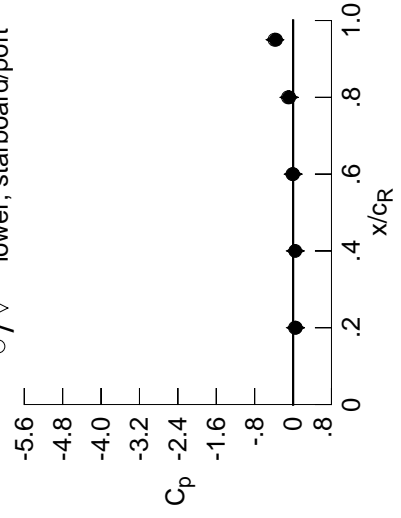

x/c_R	η	starb'd	port	starb'd	port
		$C_{p,u}$	$C_{p,l}$	$C_{p,u}$	$C_{p,l}$
0.20	0.90	0.0568	0.0585	0.0441	0.0400
0.40	0.95	0.0445	0.0507	0.0427	*****
0.60	0.95	0.0005	0.0074	-0.0021	-0.0134
0.80	0.95	-0.0801	-0.0734	-0.0935	-0.1055
0.95	0.95	-0.3570	-0.3731	-0.3809	-0.3871

Table D3. Continued.

η	$x/c_R = .2$		$x/c_R = .4$		$x/c_R = .6$		$x/c_R = .8$		$x/c_R = .95$	
	$C_{p,u}$	$C_{p,l}$	$C_{p,u}$	$C_{p,l}$	$C_{p,u}$	$C_{p,l}$	$C_{p,u}$	$C_{p,l}$	$C_{p,u}$	$C_{p,l}$
0.050	-0.0354	-0.0204	0.1024	0.1024	0.1024	0.1024	0.1024	0.1024	0.1024	0.1024
0.100	-0.0346	-0.0235	0.0931	0.0931	0.0931	0.0931	0.0931	0.0931	0.0931	0.0931
0.150	-0.0386	-0.0190	0.0771	0.0771	0.0771	0.0771	0.0771	0.0771	0.0771	0.0771
0.200	-0.0478	-0.0237	0.0664	0.0664	0.0664	0.0664	0.0664	0.0664	0.0664	0.0664
0.250	*****	-0.0242	0.0512	-0.1403	0.3098	0.3098	0.3098	0.3098	0.3098	0.3098
0.300	-0.0684	-0.0236	0.0388	-0.1270	0.3375	0.3375	0.3375	0.3375	0.3375	0.3375
0.350	-0.0756	-0.0254	0.0278	-0.1191	0.3478	0.3478	0.3478	0.3478	0.3478	0.3478
0.400	-0.0832	-0.0312	0.0199	-0.1076	0.3608	0.3608	0.3608	0.3608	0.3608	0.3608
0.450	-0.0917	-0.0333	0.0144	-0.1032	0.3629	0.3629	0.3629	0.3629	0.3629	0.3629
0.500	-0.0992	-0.0375	0.0023	-0.0981	0.3641	0.3641	0.3641	0.3641	0.3641	0.3641
0.525	*****	-0.0411	-0.0017	-0.0969	0.3650	0.3650	0.3650	0.3650	0.3650	0.3650
0.550	-0.1034	-0.0426	-0.0056	-0.0986	0.3663	0.3663	0.3663	0.3663	0.3663	0.3663
0.575	*****	-0.0533	-0.0046	-0.0947	0.3732	0.3732	0.3732	0.3732	0.3732	0.3732
0.600	-0.0924	-0.0567	-0.0134	-0.0974	0.3797	0.3797	0.3797	0.3797	0.3797	0.3797
0.625	*****	*****	-0.0171	-0.0966	0.3850	0.3850	0.3850	0.3850	0.3850	0.3850
0.650	-0.0841	-0.0643	-0.0241	-0.0952	0.3947	0.3947	0.3947	0.3947	0.3947	0.3947
0.675	*****	-0.0724	-0.0322	-0.0975	0.3982	0.3982	0.3982	0.3982	0.3982	0.3982
0.700	-0.0787	-0.0876	-0.0364	-0.1034	0.4195	0.4195	0.4195	0.4195	0.4195	0.4195
0.725	*****	-0.1015	*****	-0.1037	0.4407	0.4407	0.4407	0.4407	0.4407	0.4407
0.750	-0.0647	-0.1075	*****	-0.1098	0.4635	0.4635	0.4635	0.4635	0.4635	0.4635
0.775	*****	-0.1248	-0.0663	-0.1117	0.4863	0.4863	0.4863	0.4863	0.4863	0.4863
0.800	-0.0492	-0.1254	-0.0876	-0.1196	0.5196	0.5196	0.5196	0.5196	0.5196	0.5196
0.825	*****	-0.1208	-0.1044	-0.1253	0.6129	0.6129	0.6129	0.6129	0.6129	0.6129
0.850	-0.0230	-0.1139	-0.1187	-0.1581	0.5848	0.5848	0.5848	0.5848	0.5848	0.5848
0.875	*****	-0.1044	-0.1188	-0.1853	0.6460	0.6460	0.6460	0.6460	0.6460	0.6460
0.900	0.0151	-0.0846	-0.1127	-0.1941	0.6460	0.6460	0.6460	0.6460	0.6460	0.6460
0.925	*****	-0.0483	-0.0904	-0.1735	0.6749	0.6749	0.6749	0.6749	0.6749	0.6749
0.950	0.0603	-0.0066	-0.0540	-0.1436	0.3884	0.3884	0.3884	0.3884	0.3884	0.3884
0.975	*****	0.0324	0.0042	-0.0667	0.2144	0.2144	0.2144	0.2144	0.2144	0.2144
-0.200	-0.0129	0.0110	0.0886	0.0886	0.3163	0.3163	0.3163	0.3163	0.3163	0.3163
-0.400	-0.0272	0.0101	0.0471	-0.0880	0.3820	0.3820	0.3820	0.3820	0.3820	0.3820
-0.600	*****	-0.0008	0.0208	-0.0687	0.4283	0.4283	0.4283	0.4283	0.4283	0.4283
-0.700	*****	-0.0294	0.0084	-0.0701	0.4754	0.4754	0.4754	0.4754	0.4754	0.4754
-0.800	0.0081	-0.0503	-0.0294	-0.0749	0.5698	0.5698	0.5698	0.5698	0.5698	0.5698
-0.850	0.0411	-0.0294	-0.0470	-0.0963	0.7151	0.7151	0.7151	0.7151	0.7151	0.7151
-0.900	0.0779	0.0077	-0.0346	-0.1108	0.9204	0.9204	0.9204	0.9204	0.9204	0.9204
-0.950	*****	*****	0.0409	-0.0465	0.3427	0.3427	0.3427	0.3427	0.3427	0.3427
-0.975	*****	0.1268	0.0969	0.0285	0.1483	0.1483	0.1483	0.1483	0.1483	0.1483

Sharp Radius L.E.
 Run No. = 86 , Point No. = 1875
 $C_N = 0.027$, $C_m = -0.0044$
 $\alpha = 1.1^\circ$, $M_\infty = 0.799$
 $R_{mac} = 6.0 \times 10^6$

Surface Pressures Near Leading Edge

● / ◆ upper, starboard/port
 ○ / ◇ lower, starboard/port

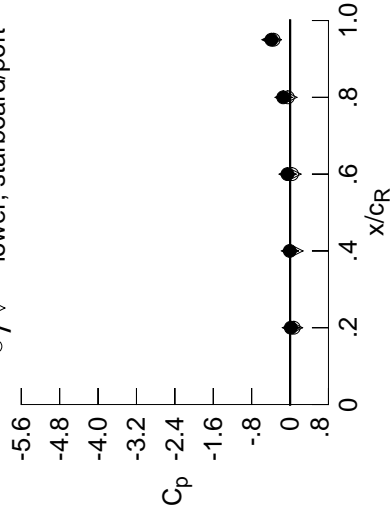

x/c_R	η	starb'd	port	starb'd	port
		$C_{p,u}$	$C_{p,l}$	$C_{p,u}$	$C_{p,l}$
0.20	0.90	0.0151	0.0187	0.0833	0.0779
0.40	0.95	-0.0066	-0.0019	0.0906	*****
0.60	0.95	-0.0540	-0.0519	0.0487	0.0409
0.80	0.95	-0.1436	-0.1362	-0.0360	-0.0465
0.95	0.95	-0.3884	-0.4094	-0.3604	-0.3427

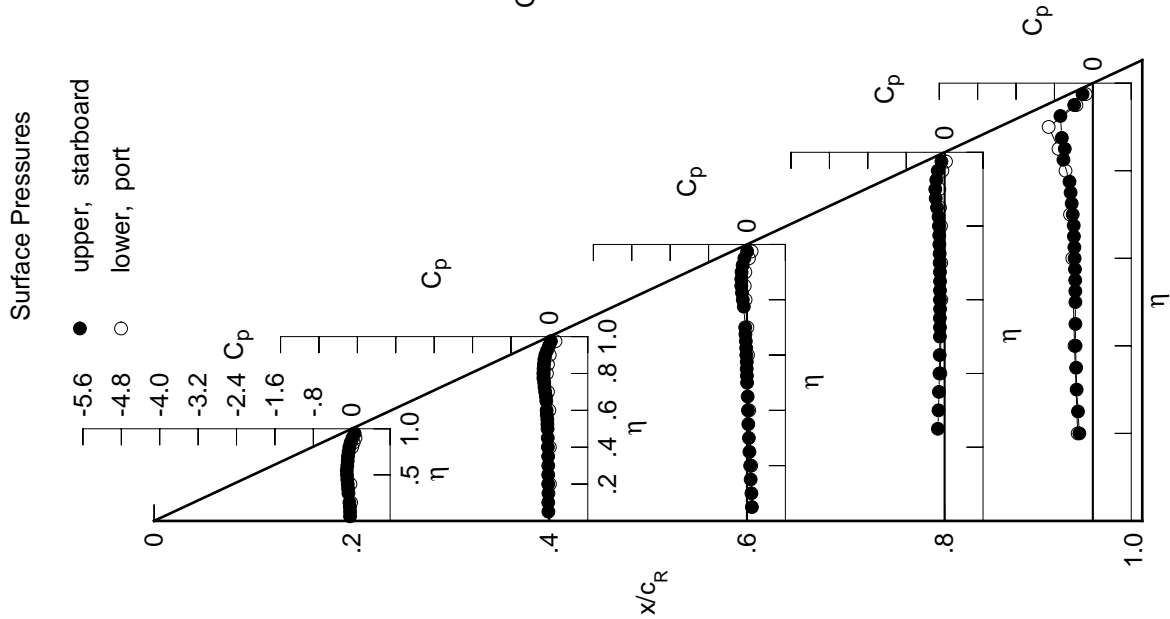

Table D3. Continued.

η	$x/c_R = .2$		$x/c_R = .4$		$x/c_R = .6$		$x/c_R = .8$		$x/c_R = .95$	
	$C_{p,u}$	$C_{p,l}$	$C_{p,u}$	$C_{p,l}$	$C_{p,u}$	$C_{p,l}$	$C_{p,u}$	$C_{p,l}$	$C_{p,u}$	$C_{p,l}$
0.050	-0.0517	-0.0331	0.0902	0.0902	0.0902	0.0902	0.0902	0.0902	0.0902	0.0902
0.100	-0.0505	-0.0386	0.0813	0.0813	0.0813	0.0813	0.0813	0.0813	0.0813	0.0813
0.150	-0.0540	-0.0392	0.0652	0.0652	0.0652	0.0652	0.0652	0.0652	0.0652	0.0652
0.200	-0.0605	-0.0407	0.0528	0.0528	0.0528	0.0528	0.0528	0.0528	0.0528	0.0528
0.250	*****	-0.0412	0.0383	-0.1499	0.0383	-0.1499	0.0383	-0.1499	0.0383	-0.2689
0.300	-0.0747	-0.0428	0.0269	-0.1363	0.0269	-0.1363	0.0269	-0.1363	0.0269	-0.2988
0.350	-0.0848	-0.0462	0.0135	-0.1286	0.0135	-0.1286	0.0135	-0.1286	0.0135	-0.3243
0.400	-0.0957	-0.0535	0.0050	-0.1162	0.0050	-0.1162	0.0050	-0.1162	0.0050	-0.3379
0.450	-0.1097	-0.0533	-0.0008	-0.1134	-0.0008	-0.1134	-0.0008	-0.1134	-0.0008	-0.3484
0.500	-0.1185	-0.0558	-0.0128	-0.1093	-0.0128	-0.1093	-0.0128	-0.1093	-0.0128	-0.3552
0.525	*****	-0.0637	-0.0168	-0.1083	-0.0168	-0.1083	-0.0168	-0.1083	-0.0168	-0.3560
0.550	-0.1269	-0.0673	-0.0222	-0.1087	-0.0222	-0.1087	-0.0222	-0.1087	-0.0222	-0.3594
0.575	*****	-0.0766	-0.0239	-0.1092	-0.0239	-0.1092	-0.0239	-0.1092	-0.0239	-0.3604
0.600	-0.1273	-0.0798	-0.0312	-0.1107	-0.0312	-0.1107	-0.0312	-0.1107	-0.0312	-0.3642
0.625	*****	*****	-0.0371	-0.1136	-0.0371	-0.1136	-0.0371	-0.1136	-0.0371	-0.3635
0.650	-0.1217	-0.0909	-0.0429	-0.1105	-0.0429	-0.1105	-0.0429	-0.1105	-0.0429	-0.3636
0.675	*****	-0.1010	-0.0533	-0.1165	-0.0533	-0.1165	-0.0533	-0.1165	-0.0533	-0.3560
0.700	-0.1122	-0.1184	-0.0593	-0.1203	-0.0593	-0.1203	-0.0593	-0.1203	-0.0593	-0.3624
0.725	*****	-0.1334	*****	-0.1227	-0.1227	-0.3684	*****	-0.1227	-0.3684	*****
0.750	-0.0986	-0.1431	*****	-0.1306	-0.1306	-0.3740	*****	-0.1306	-0.3740	*****
0.775	*****	-0.1608	-0.0982	-0.1351	-0.0982	-0.3735	*****	-0.1351	-0.3735	*****
0.800	-0.0864	-0.1635	-0.1214	-0.1462	-0.1214	-0.1462	*****	-0.1462	*****	*****
0.825	*****	-0.1649	-0.1423	-0.1580	-0.1423	-0.4256	*****	-0.1580	-0.4256	*****
0.850	-0.0592	-0.1570	-0.1613	-0.1891	-0.1613	-0.4538	*****	-0.1891	-0.4538	*****
0.875	*****	-0.1541	-0.1672	-0.2230	-0.1672	-0.4822	*****	-0.2230	-0.4822	*****
0.900	-0.0236	-0.1349	-0.1670	-0.2371	-0.1670	-0.2371	*****	-0.2371	*****	*****
0.925	*****	-0.1030	-0.1519	-0.2266	-0.1519	-0.2266	-0.8503	-0.2266	-0.8503	*****
0.950	0.0181	-0.0630	-0.1179	-0.2051	-0.1179	-0.2051	-0.4514	-0.2051	-0.4514	*****
0.975	*****	-0.0245	-0.0595	-0.1358	-0.0595	-0.1358	-0.2766	-0.1358	-0.2766	*****

η	$x/c_R = .2$		$x/c_R = .4$		$x/c_R = .6$		$x/c_R = .8$		$x/c_R = .95$	
	$C_{p,u}$	$C_{p,l}$	$C_{p,u}$	$C_{p,l}$	$C_{p,u}$	$C_{p,l}$	$C_{p,u}$	$C_{p,l}$	$C_{p,u}$	$C_{p,l}$
-0.200	0.0180	0.0295	0.1030	0.1030	0.1030	0.1030	0.1030	0.1030	0.1030	0.1030
-0.400	-0.0028	0.0293	0.0622	-0.0763	0.0622	-0.0763	0.0622	-0.0763	0.0622	-0.3203
-0.600	*****	0.0236	0.0385	-0.0549	0.0385	-0.0549	0.0385	-0.0549	0.0385	-0.3967
-0.700	*****	-0.0022	0.0301	-0.0551	0.0301	-0.0551	0.0301	-0.0551	0.0301	-0.4547
-0.800	0.0449	0.0086	0.0007	-0.0529	0.0007	-0.0529	0.0007	-0.0529	0.0007	-0.5386
-0.850	0.0759	0.0090	-0.0036	-0.0670	-0.0036	-0.0670	-0.0036	-0.0670	-0.0036	-0.6734
-0.900	0.1128	0.0507	0.0124	-0.0654	0.0124	-0.0654	0.0124	-0.0654	0.0124	-0.7362
-0.950	*****	*****	0.0857	0.0021	0.0857	0.0021	0.0857	0.0021	0.0857	-0.8851
-0.975	*****	0.1608	0.1370	0.0725	0.1370	0.0725	0.1370	0.0725	0.1370	-0.3156

Sharp Radius L.E.
 Run No. = 86 , Point No. = 1876
 $C_N = 0.065$, $C_m = -0.0100$
 $\alpha = 2.2^\circ$, $M_\infty = 0.799$
 $R_{mac} = 6.0 \times 10^6$

Surface Pressures Near Leading Edge

● / ◆ upper, starboard/port
 ○ / ◇ lower, starboard/port

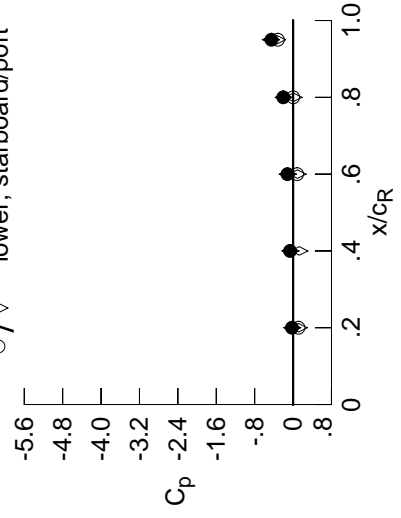

x/c_R	η	starb'd	port	starb'd	port
x/c_R	η	$C_{p,u}$	$C_{p,l}$	$C_{p,u}$	$C_{p,l}$
0.20	0.90	-0.0236	-0.0184	0.1173	0.1128
0.40	0.95	-0.0630	-0.0560	0.1295	*****
0.60	0.95	-0.1179	-0.1122	0.0921	0.0857
0.80	0.95	-0.2051	-0.1950	0.0091	0.0021
0.95	0.95	-0.4514	-0.4607	-0.3365	-0.3156

Table D3. Continued.

η	$x/c_R = .2$		$x/c_R = .4$		$x/c_R = .6$		$x/c_R = .8$		$x/c_R = .95$	
	$C_{p,u}$	$C_{p,l}$	$C_{p,u}$	$C_{p,l}$	$C_{p,u}$	$C_{p,l}$	$C_{p,u}$	$C_{p,l}$	$C_{p,u}$	$C_{p,l}$
0.050	-0.0721	-0.0541	0.0774	0.0774	0.0774	0.0774	0.0774	0.0774	0.0774	0.0774
0.100	-0.0756	-0.0542	0.0701	0.0701	0.0701	0.0701	0.0701	0.0701	0.0701	0.0701
0.150	-0.0862	-0.0559	0.0531	0.0531	0.0531	0.0531	0.0531	0.0531	0.0531	0.0531
0.200	-0.0877	-0.0566	0.0442	0.0442	0.0442	0.0442	0.0442	0.0442	0.0442	0.0442
0.250	*****	-0.0595	0.0261	-0.1577	0.0261	-0.1577	0.0261	-0.1577	0.0261	-0.2638
0.300	-0.0995	-0.0605	0.0128	-0.1478	0.0128	-0.1478	0.0128	-0.1478	0.0128	-0.3211
0.350	-0.1099	-0.0632	-0.0001	-0.1357	-0.0001	-0.1357	-0.0001	-0.1357	-0.0001	-0.3421
0.400	-0.1212	-0.0710	-0.0100	-0.1282	-0.0100	-0.1282	-0.0100	-0.1282	-0.0100	-0.3497
0.450	-0.1358	-0.0745	-0.0168	-0.1242	-0.0168	-0.1242	-0.0168	-0.1242	-0.0168	-0.3499
0.500	-0.1468	-0.0787	-0.0291	-0.1221	-0.0291	-0.1221	-0.0291	-0.1221	-0.0291	-0.3544
0.525	*****	-0.0863	-0.0331	-0.1219	-0.0331	-0.1219	-0.0331	-0.1219	-0.0331	-0.3529
0.550	-0.1561	-0.0880	-0.0403	-0.1226	-0.0403	-0.1226	-0.0403	-0.1226	-0.0403	-0.3523
0.575	*****	-0.0997	-0.0429	-0.1227	-0.0429	-0.1227	-0.0429	-0.1227	-0.0429	-0.3494
0.600	-0.1597	-0.1042	-0.0496	-0.1238	-0.0496	-0.1238	-0.0496	-0.1238	-0.0496	-0.3520
0.625	*****	*****	-0.0588	-0.1300	-0.0588	-0.1300	-0.0588	-0.1300	-0.0588	-0.3526
0.650	-0.1548	-0.1171	-0.0639	-0.1270	-0.0639	-0.1270	-0.0639	-0.1270	-0.0639	-0.3541
0.675	*****	-0.1287	-0.0782	-0.1340	-0.0782	-0.1340	-0.0782	-0.1340	-0.0782	-0.3463
0.700	-0.1470	-0.1492	-0.0833	-0.1390	-0.0833	-0.1390	-0.0833	-0.1390	-0.0833	-0.3519
0.725	*****	-0.1675	*****	-0.1451	-0.1451	-0.1451	-0.1451	-0.1451	-0.1451	-0.3481
0.750	-0.1377	-0.1802	*****	-0.1538	-0.1538	-0.1538	-0.1538	-0.1538	-0.1538	-0.3471
0.775	*****	-0.2022	-0.1286	-0.1630	-0.1286	-0.1630	-0.1286	-0.1630	-0.1286	-0.3379
0.800	-0.1279	-0.2048	-0.1543	-0.1731	-0.1543	-0.1731	-0.1543	-0.1731	-0.1543	-0.3379
0.825	*****	-0.2096	-0.1800	-0.1879	-0.1800	-0.1879	-0.1800	-0.1879	-0.1800	-0.3487
0.850	-0.1019	-0.2052	-0.2042	-0.2246	-0.2042	-0.2246	-0.2042	-0.2246	-0.2042	-0.3817
0.875	*****	-0.2047	-0.2123	-0.2608	-0.2047	-0.2608	-0.2047	-0.2608	-0.2047	-0.4439
0.900	-0.0675	-0.1887	-0.2179	-0.2830	-0.2179	-0.2830	-0.2179	-0.2830	-0.2179	-0.4439
0.925	*****	-0.1555	-0.2041	-0.2834	-0.1555	-0.2834	-0.1555	-0.2834	-0.1555	-0.8877
0.950	-0.0347	-0.1082	-0.1649	-0.2648	-0.1649	-0.2648	-0.1649	-0.2648	-0.1649	-0.4987
0.975	*****	-0.1929	-0.2104	-0.2020	-0.1929	-0.2020	-0.1929	-0.2020	-0.1929	-0.3277
-0.200	0.0373	0.0443	0.1167	0.1167	0.1167	0.1167	0.1167	0.1167	0.1167	-0.3320
-0.400	0.0203	0.0492	0.0763	-0.0667	0.0763	-0.0667	0.0763	-0.0667	0.0763	-0.4088
-0.600	*****	0.0425	0.0580	-0.0429	0.0580	-0.0429	0.0580	-0.0429	0.0580	-0.4777
-0.700	*****	0.0244	0.0503	-0.0400	0.0503	-0.0400	0.0503	-0.0400	0.0503	-0.5756
-0.800	0.0766	0.0262	0.0274	-0.0309	0.0274	-0.0309	0.0274	-0.0309	0.0274	-0.6773
-0.850	0.1072	0.0425	0.0291	-0.0405	0.0291	-0.0405	0.0291	-0.0405	0.0291	-0.7171
-0.900	0.1412	0.0875	0.0494	-0.0283	0.0494	-0.0283	0.0494	-0.0283	0.0494	-0.8330
-0.950	*****	*****	0.1201	0.0407	0.1201	0.0407	0.1201	0.0407	0.1201	-0.2898
-0.975	*****	0.1807	0.1622	0.1036	0.1622	0.1036	0.1622	0.1036	0.1622	-0.0927

Sharp Radius L.E.
 Run No. = 86 , Point No. = 1877
 $C_N = 0.105$, $C_m = -0.0170$
 $\alpha = 3.2^\circ$, $M_\infty = 0.799$
 $R_{mac} = 6.0 \times 10^6$

Surface Pressures Near Leading Edge

● / ◆ upper, starboard/port
 ○ / ◇ lower, starboard/port

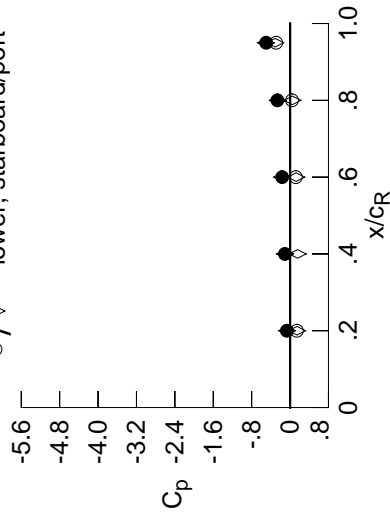

x/c_R	η	starb'd	port	$C_{p,u}$	starb'd	port	$C_{p,l}$
0.20	0.90	-0.0675	-0.0635	0.1455	0.1412	0.1455	0.1412
0.40	0.95	-0.1082	-0.1089	0.1571	0.1571	0.1571	0.1571
0.60	0.95	-0.1649	-0.1680	0.1276	0.1201	0.1276	0.1201
0.80	0.95	-0.2648	-0.2555	0.0478	0.0407	0.0478	0.0407
0.95	0.95	-0.4987	-0.5034	-0.3111	-0.2898	-0.3111	-0.2898

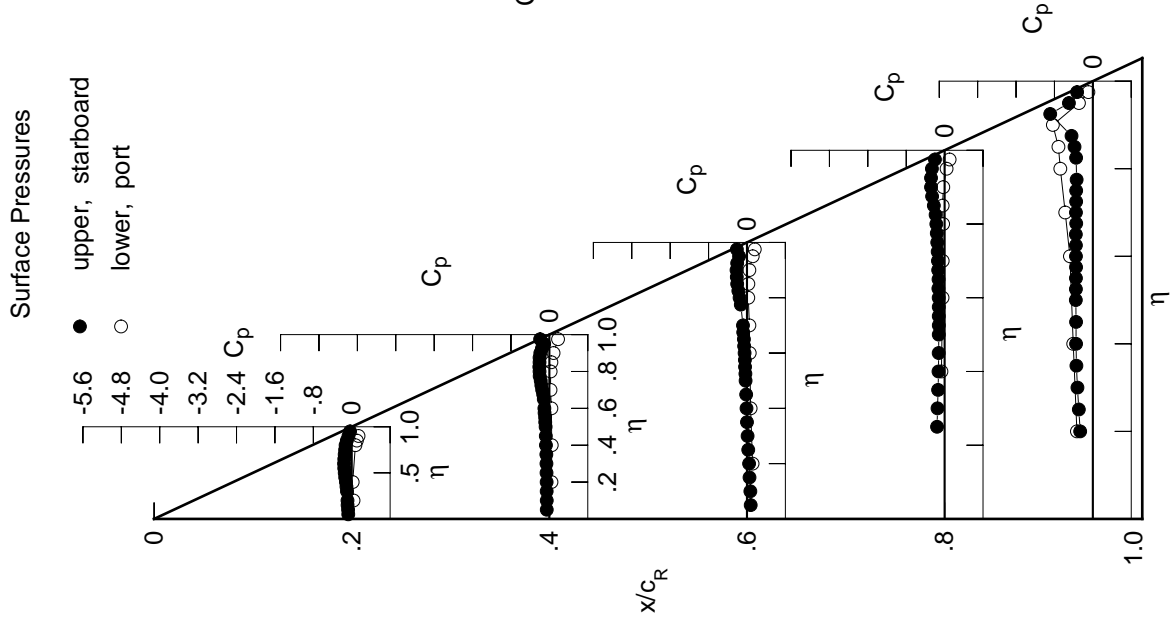

Table D3. Continued.

η	$x/c_R = .2$		$x/c_R = .4$		$x/c_R = .6$		$x/c_R = .8$		$x/c_R = .95$	
	$C_{p,u}$	$C_{p,l}$	$C_{p,u}$	$C_{p,l}$	$C_{p,u}$	$C_{p,l}$	$C_{p,u}$	$C_{p,l}$	$C_{p,u}$	$C_{p,l}$
0.050	-0.0958	-0.0676	0.0651	0.0651	0.0651	0.0651	0.0651	0.0651	0.0651	0.0651
0.100	-0.1000	-0.0743	0.0555	0.0555	0.0555	0.0555	0.0555	0.0555	0.0555	0.0555
0.150	-0.1068	-0.0725	0.0449	0.0449	0.0449	0.0449	0.0449	0.0449	0.0449	0.0449
0.200	-0.1137	-0.0771	0.0251	0.0251	0.0251	0.0251	0.0251	0.0251	0.0251	0.0251
0.250	*****	-0.0762	0.0169	-0.1730	-0.2927	0.0169	-0.1730	-0.2927	0.0169	-0.1730
0.300	-0.1224	-0.0789	-0.0046	-0.1569	-0.3062	-0.0046	-0.1569	-0.3062	-0.0046	-0.1569
0.350	-0.1348	-0.0815	-0.0138	-0.1520	-0.3335	-0.0138	-0.1520	-0.3335	-0.0138	-0.1520
0.400	-0.1461	-0.0937	-0.0276	-0.1390	-0.3467	-0.0276	-0.1390	-0.3467	-0.0276	-0.1390
0.450	-0.1621	-0.0963	-0.0301	-0.1391	-0.3427	-0.0301	-0.1391	-0.3427	-0.0301	-0.1391
0.500	-0.1748	-0.1052	-0.0500	-0.1370	-0.3437	-0.0500	-0.1370	-0.3437	-0.0500	-0.1370
0.525	*****	-0.1102	-0.0524	-0.1387	-0.3509	-0.0524	-0.1387	-0.3509	-0.0524	-0.1387
0.550	-0.1861	-0.1161	-0.0613	-0.1376	-0.3478	-0.0613	-0.1376	-0.3478	-0.0613	-0.1376
0.575	*****	-0.1250	-0.0630	-0.1389	-0.3484	-0.0630	-0.1389	-0.3484	-0.0630	-0.1389
0.600	-0.1903	-0.1330	-0.0730	-0.1425	-0.3493	-0.0730	-0.1425	-0.3493	-0.0730	-0.1425
0.625	*****	*****	-0.0842	-0.1487	-0.3529	-0.0842	-0.1487	-0.3529	-0.0842	-0.1487
0.650	-0.1920	-0.1474	-0.0881	-0.1479	-0.3588	-0.0881	-0.1479	-0.3588	-0.0881	-0.1479
0.675	*****	-0.1608	-0.1015	-0.1566	-0.3554	-0.1015	-0.1566	-0.3554	-0.1015	-0.1566
0.700	-0.1864	-0.1807	-0.1092	-0.1619	-0.3648	-0.1092	-0.1619	-0.3648	-0.1092	-0.1619
0.725	*****	-0.2007	*****	-0.1678	-0.3691	*****	-0.1678	-0.3691	*****	-0.1678
0.750	-0.1779	-0.2158	*****	-0.1807	-0.3774	*****	-0.1807	-0.3774	*****	-0.1807
0.775	*****	-0.2401	-0.1588	-0.1892	-0.3800	-0.1588	-0.1892	-0.3800	-0.1588	-0.1892
0.800	-0.1692	-0.2483	-0.1898	-0.2019	*****	-0.1898	-0.2019	*****	-0.1898	-0.2019
0.825	*****	-0.2528	-0.2141	-0.2206	-0.4130	-0.2141	-0.2206	-0.4130	-0.2141	-0.2206
0.850	-0.1448	-0.2520	-0.2408	-0.2586	-0.3817	-0.2408	-0.2586	-0.3817	-0.2408	-0.2586
0.875	*****	-0.2463	-0.2478	-0.2992	-0.4688	-0.2463	-0.2478	-0.2992	-0.2463	-0.2478
0.900	-0.1083	-0.2214	-0.2561	-0.3211	*****	-0.2561	-0.3211	*****	-0.2561	-0.3211
0.925	*****	-0.1913	-0.2351	-0.3234	-0.8930	-0.1913	-0.2351	-0.3234	-0.1913	-0.2351
0.950	-0.0895	-0.2895	-0.3137	-0.3260	-0.5271	-0.3137	-0.3260	-0.5271	-0.3137	-0.3260
0.975	*****	-0.4080	-0.4654	-0.4881	-0.4496	-0.4080	-0.4654	-0.4881	-0.4080	-0.4496

η	$x/c_R = .2$		$x/c_R = .4$		$x/c_R = .6$		$x/c_R = .8$		$x/c_R = .95$	
	$C_{p,u}$	$C_{p,l}$	$C_{p,u}$	$C_{p,l}$	$C_{p,u}$	$C_{p,l}$	$C_{p,u}$	$C_{p,l}$	$C_{p,u}$	$C_{p,l}$
-0.200	0.0577	0.0643	0.1301	*****	-0.3406	0.1301	*****	-0.3406	0.1301	*****
-0.400	0.0444	0.0663	0.0919	-0.0520	-0.4236	0.0919	-0.0520	-0.4236	0.0919	-0.0520
-0.600	*****	0.0670	0.0749	-0.0279	-0.4862	0.0749	-0.0279	-0.4862	0.0749	-0.0279
-0.700	*****	0.0509	0.0709	-0.0197	-0.5746	0.0709	-0.0197	-0.5746	0.0709	-0.0197
-0.800	0.1077	0.0610	0.0552	-0.0091	-0.6464	0.0552	-0.0091	-0.6464	0.0552	-0.0091
-0.850	0.1358	0.0765	0.0617	-0.0132	-0.6852	0.0617	-0.0132	-0.6852	0.0617	-0.0132
-0.900	0.1664	0.1219	0.0860	0.0040	-0.7768	0.0860	0.0040	-0.7768	0.0860	0.0040
-0.950	*****	*****	0.1488	0.0737	-0.2616	0.1488	0.0737	-0.2616	0.1488	0.0737
-0.975	*****	0.1936	0.1790	0.1242	-0.0710	0.1790	0.1242	-0.0710	0.1790	0.1242

Sharp Radius L.E.
 Run No. = 86 , Point No. = 1878
 $C_N = 0.151$, $C_m = -0.0261$
 $\alpha = 4.2^\circ$, $M_\infty = 0.799$
 $R_{mac} = 6.0 \times 10^6$

Surface Pressures Near Leading Edge

● / ◆ upper, starboard/port
 ○ / ◇ lower, starboard/port

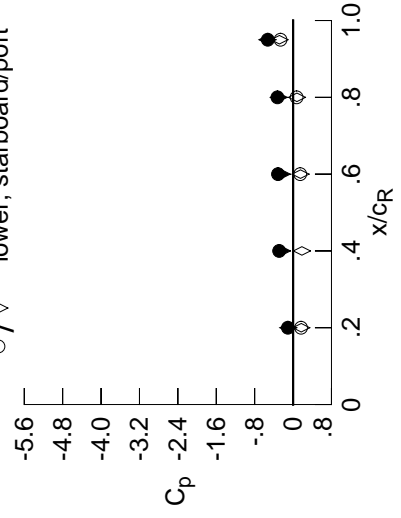

x/c_R	η	starb'd	port	starb'd	port
x/c_R	η	$C_{p,u}$	$C_{p,l}$	$C_{p,u}$	$C_{p,l}$
0.20	0.90	-0.1083	-0.1003	0.1706	0.1664
0.40	0.95	-0.2895	-0.2327	0.1841	*****
0.60	0.95	-0.3137	-0.2370	0.1550	0.1488
0.80	0.95	-0.3260	-0.2982	0.0805	0.0737
0.95	0.95	-0.5271	-0.5346	-0.2849	-0.2616

Table D3. Continued.

η	$x/c_R = .2$		$x/c_R = .4$		$x/c_R = .6$		$x/c_R = .8$		$x/c_R = .95$	
	$C_{p,u}$	$C_{p,l}$	$C_{p,u}$	$C_{p,l}$	$C_{p,u}$	$C_{p,l}$	$C_{p,u}$	$C_{p,l}$	$C_{p,u}$	$C_{p,l}$
0.050	-0.1129	-0.0849	0.0545	*****	*****	*****	*****	*****	*****	*****
0.100	-0.1163	-0.0896	0.0454	*****	*****	*****	*****	*****	*****	*****
0.150	-0.1266	-0.0902	0.0302	*****	*****	*****	*****	*****	*****	*****
0.200	-0.1327	-0.0916	0.0145	*****	*****	*****	*****	*****	*****	*****
0.250	*****	-0.0942	0.0013	-0.1829	-0.2900	*****	*****	*****	*****	*****
0.300	-0.1438	-0.0968	-0.0174	-0.1682	-0.2875	*****	*****	*****	*****	*****
0.350	-0.1559	-0.1016	-0.0303	-0.1601	-0.3095	*****	*****	*****	*****	*****
0.400	-0.1691	-0.1138	-0.0399	-0.1524	-0.3281	*****	*****	*****	*****	*****
0.450	-0.1867	-0.1203	-0.0473	-0.1507	-0.3297	*****	*****	*****	*****	*****
0.500	-0.2011	-0.1253	-0.0651	-0.1520	-0.3275	*****	*****	*****	*****	*****
0.525	*****	-0.1342	-0.0711	-0.1517	-0.3372	*****	*****	*****	*****	*****
0.550	-0.2148	-0.1372	-0.0785	-0.1503	-0.3389	*****	*****	*****	*****	*****
0.575	*****	-0.1490	-0.0810	-0.1536	-0.3463	*****	*****	*****	*****	*****
0.600	-0.2202	-0.1552	-0.0920	-0.1579	-0.3518	*****	*****	*****	*****	*****
0.625	*****	*****	-0.1020	-0.1649	-0.3663	*****	*****	*****	*****	*****
0.650	-0.2246	-0.1730	-0.1081	-0.1649	-0.3846	*****	*****	*****	*****	*****
0.675	*****	-0.1883	-0.1223	-0.1718	-0.3934	*****	*****	*****	*****	*****
0.700	-0.2194	-0.2097	-0.1331	-0.1785	-0.4072	*****	*****	*****	*****	*****
0.725	*****	-0.2336	*****	-0.1826	-0.4249	*****	*****	*****	*****	*****
0.750	-0.2129	-0.2501	*****	-0.1967	-0.4413	*****	*****	*****	*****	*****
0.775	*****	-0.2740	-0.1835	-0.2148	-0.4549	*****	*****	*****	*****	*****
0.800	-0.2025	-0.2825	-0.2177	-0.2356	*****	*****	*****	*****	*****	*****
0.825	*****	-0.2842	-0.2404	-0.2446	-0.5414	*****	*****	*****	*****	*****
0.850	-0.1712	-0.2776	-0.2575	-0.2893	-0.4561	*****	*****	*****	*****	*****
0.875	*****	-0.2595	-0.2595	-0.3262	-0.6066	*****	*****	*****	*****	*****
0.900	-0.1774	-0.2851	-0.3268	-0.3528	*****	*****	*****	*****	*****	*****
0.925	*****	-0.4198	-0.4565	-0.4640	-0.9263	*****	*****	*****	*****	*****
0.950	-0.1522	-0.5306	-0.5840	-0.5853	-0.6089	*****	*****	*****	*****	*****
0.975	*****	-0.5167	-0.5658	-0.6120	-0.5475	*****	*****	*****	*****	*****
-0.200	0.0813	0.0857	0.1479	*****	*****	*****	*****	*****	*****	*****
-0.400	0.0713	0.0887	0.1084	-0.0394	-0.4397	*****	*****	*****	*****	*****
-0.600	*****	0.0906	0.0945	-0.0099	-0.4840	*****	*****	*****	*****	*****
-0.700	*****	0.0791	0.0945	-0.0026	-0.5474	*****	*****	*****	*****	*****
-0.800	0.1372	0.0898	0.0820	0.0136	-0.5918	*****	*****	*****	*****	*****
-0.850	0.1629	0.1063	0.0912	0.0130	-0.6411	*****	*****	*****	*****	*****
-0.900	0.1886	0.1516	0.1182	0.0340	-0.7269	*****	*****	*****	*****	*****
-0.950	*****	*****	0.1720	0.1011	-0.2335	*****	*****	*****	*****	*****
-0.975	*****	0.2010	0.1897	0.1388	-0.0455	*****	*****	*****	*****	*****

Sharp Radius L.E.
 Run No. = 86 , Point No. = 1879
 $C_N = 0.198$, $C_m = -0.0351$
 $\alpha = 5.2^\circ$, $M_\infty = 0.799$
 $R_{mac} = 6.0 \times 10^6$

Surface Pressures Near Leading Edge

● / ◆ upper, starboard/port
 ○ / ◇ lower, starboard/port

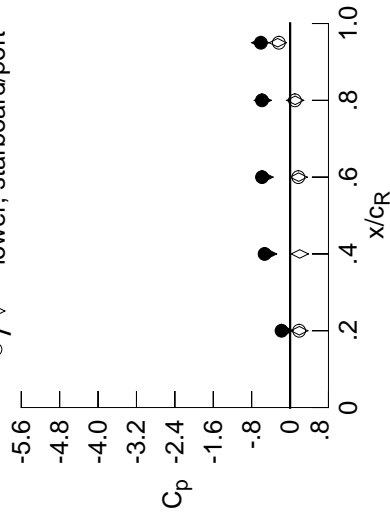

x/c_R	η	starb'd	port	starb'd	port
		$C_{p,u}$	$C_{p,l}$	$C_{p,u}$	$C_{p,l}$
0.20	0.90	-0.1774	-0.1165	0.1927	0.1886
0.40	0.95	-0.5306	-0.4574	0.2028	*****
0.60	0.95	-0.5840	-0.5326	0.1792	0.1720
0.80	0.95	-0.5853	-0.5676	0.1065	0.1011
0.95	0.95	-0.6089	-0.6236	-0.2579	-0.2335

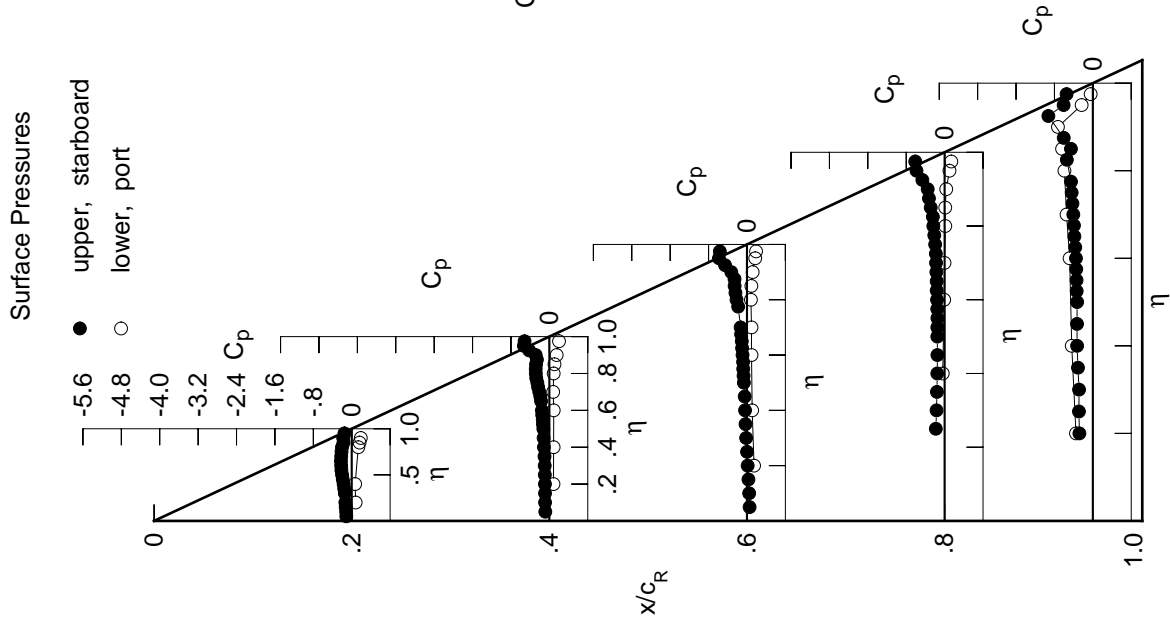

Table D3. Continued.

η	$x/c_R = .2$		$x/c_R = .4$		$x/c_R = .6$		$x/c_R = .8$		$x/c_R = .95$	
	$C_{p,u}$	$C_{p,l}$	$C_{p,u}$	$C_{p,l}$	$C_{p,u}$	$C_{p,l}$	$C_{p,u}$	$C_{p,l}$	$C_{p,u}$	$C_{p,l}$
0.050	-0.1345	-0.1051	0.0416	0.0416	0.0416	0.0416	0.0416	0.0416	0.0416	0.0416
0.100	-0.1367	-0.1080	0.0299	0.0299	0.0299	0.0299	0.0299	0.0299	0.0299	0.0299
0.150	-0.1469	-0.1091	0.0174	0.0174	0.0174	0.0174	0.0174	0.0174	0.0174	0.0174
0.200	-0.1537	-0.1094	0.0002	0.0002	0.0002	0.0002	0.0002	0.0002	0.0002	0.0002
0.250	0.0000	-0.1148	-0.0145	-0.1990	-0.1990	-0.1990	-0.1990	-0.1990	-0.1990	-0.1990
0.300	-0.1644	-0.1180	-0.0385	-0.1833	-0.2855	-0.2855	-0.2855	-0.2855	-0.2855	-0.2855
0.350	-0.1790	-0.1234	-0.0481	-0.1788	-0.2890	-0.2890	-0.2890	-0.2890	-0.2890	-0.2890
0.400	-0.1914	-0.1384	-0.0571	-0.1688	-0.2939	-0.2939	-0.2939	-0.2939	-0.2939	-0.2939
0.450	-0.2121	-0.1452	-0.0660	-0.1681	-0.2858	-0.2858	-0.2858	-0.2858	-0.2858	-0.2858
0.500	-0.2275	-0.1478	-0.0817	-0.1680	-0.2921	-0.2921	-0.2921	-0.2921	-0.2921	-0.2921
0.525	0.0000	-0.1541	-0.0901	-0.1655	-0.3186	-0.3186	-0.3186	-0.3186	-0.3186	-0.3186
0.550	-0.2427	-0.1624	-0.0991	-0.1656	-0.3345	-0.3345	-0.3345	-0.3345	-0.3345	-0.3345
0.575	0.0000	-0.1744	-0.0998	-0.1646	-0.3672	-0.3672	-0.3672	-0.3672	-0.3672	-0.3672
0.600	-0.2499	-0.1806	-0.1089	-0.1691	-0.3984	-0.3984	-0.3984	-0.3984	-0.3984	-0.3984
0.625	0.0000	0.0000	-0.1205	-0.1736	-0.4318	-0.4318	-0.4318	-0.4318	-0.4318	-0.4318
0.650	-0.2542	-0.1959	-0.1274	-0.1711	-0.4593	-0.4593	-0.4593	-0.4593	-0.4593	-0.4593
0.675	0.0000	-0.2149	-0.1386	-0.1737	-0.4760	-0.4760	-0.4760	-0.4760	-0.4760	-0.4760
0.700	-0.2501	-0.2373	-0.1464	-0.1756	-0.4989	-0.4989	-0.4989	-0.4989	-0.4989	-0.4989
0.725	0.0000	-0.2613	0.0000	-0.1729	-0.5108	-0.5108	-0.5108	-0.5108	-0.5108	-0.5108
0.750	-0.2377	-0.2765	0.0000	-0.1709	-0.5331	-0.5331	-0.5331	-0.5331	-0.5331	-0.5331
0.775	0.0000	-0.2991	-0.1902	-0.2257	-0.6073	-0.6073	-0.6073	-0.6073	-0.6073	-0.6073
0.800	-0.2139	-0.2963	-0.2236	-0.3409	0.0000	0.0000	0.0000	0.0000	0.0000	0.0000
0.825	0.0000	-0.2944	-0.2607	-0.4308	-0.7911	-0.7911	-0.7911	-0.7911	-0.7911	-0.7911
0.850	-0.2008	-0.3081	-0.3706	-0.5317	-0.6367	-0.6367	-0.6367	-0.6367	-0.6367	-0.6367
0.875	0.0000	-0.3921	-0.5202	-0.5872	-0.7347	-0.7347	-0.7347	-0.7347	-0.7347	-0.7347
0.900	-0.4057	-0.5695	-0.6294	-0.6030	0.0000	0.0000	0.0000	0.0000	0.0000	0.0000
0.925	0.0000	-0.6439	-0.6559	-0.6036	-0.6399	-0.6399	-0.6399	-0.6399	-0.6399	-0.6399
0.950	-0.2677	-0.6435	-0.6415	-0.5891	-0.5147	-0.5147	-0.5147	-0.5147	-0.5147	-0.5147
0.975	0.0000	-0.6260	-0.6212	-0.5807	-0.4169	-0.4169	-0.4169	-0.4169	-0.4169	-0.4169

Sharp Radius L.E.
 Run No. = 86 , Point No. = 1880
 $C_N = 0.250$, $C_m = -0.0452$
 $\alpha = 6.3^\circ$, $M_\infty = 0.800$
 $R_{mac} = 6.0 \times 10^6$

Surface Pressures Near Leading Edge

● / ◆ upper, starboard/port
 ○ / ◇ lower, starboard/port

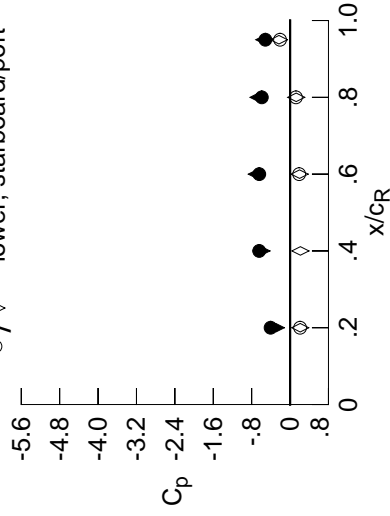

x/c_R	η	starb'd	port	starb'd	port
		$C_{p,u}$	$C_{p,l}$	$C_{p,u}$	$C_{p,l}$
0.20	0.90	-0.4057	-0.2961	0.2112	0.2088
0.40	0.95	-0.6435	-0.5965	0.2150	0.2150
0.60	0.95	-0.6415	-0.6938	0.1983	0.1896
0.80	0.95	-0.5891	-0.6576	0.1282	0.1225
0.95	0.95	-0.5147	-0.5378	-0.2317	-0.2086

Surface Pressures

● upper, starboard
 ○ lower, port

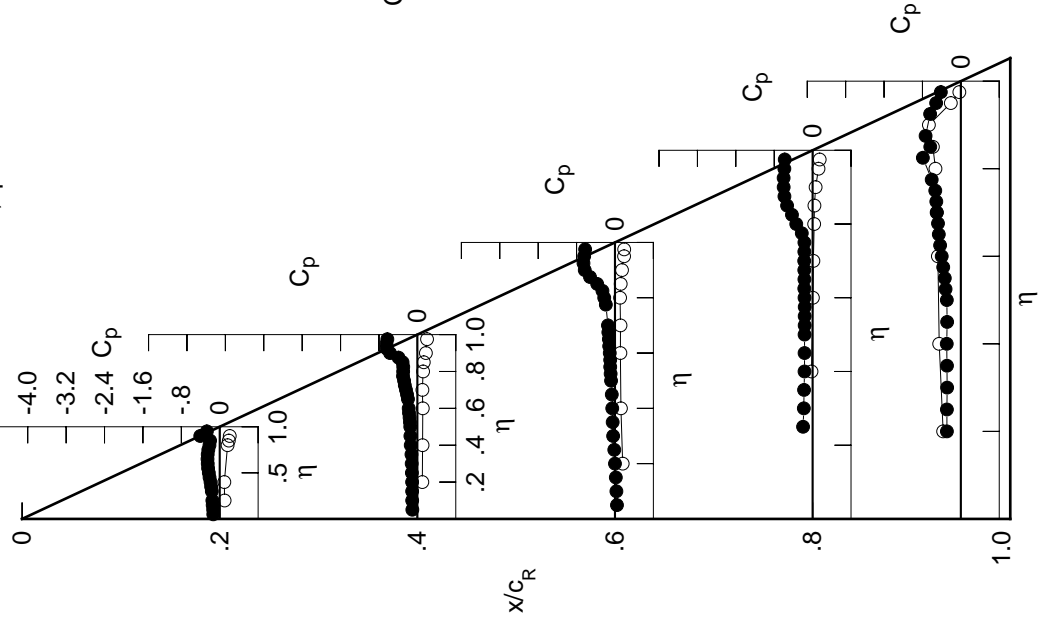

Table D3. Continued.

η	$x/c_R = .2$		$x/c_R = .4$		$x/c_R = .6$		$x/c_R = .8$		$x/c_R = .95$	
	$C_{p,u}$	$C_{p,l}$	$C_{p,u}$	$C_{p,l}$	$C_{p,u}$	$C_{p,l}$	$C_{p,u}$	$C_{p,l}$	$C_{p,u}$	$C_{p,l}$
0.050	-0.1520	-0.1216	0.0272	*****	*****	*****	*****	*****	*****	*****
0.100	-0.1577	-0.1271	0.0140	*****	*****	*****	*****	*****	*****	*****
0.150	-0.1648	-0.1275	0.0016	*****	*****	*****	*****	*****	*****	*****
0.200	-0.1752	-0.1325	-0.0172	*****	*****	*****	*****	*****	*****	*****
0.250	*****	-0.1342	-0.0296	-0.2149	-0.3014	*****	*****	*****	*****	*****
0.300	-0.1857	-0.1395	-0.0581	-0.2022	-0.2732	*****	*****	*****	*****	*****
0.350	-0.2002	-0.1414	-0.0660	-0.1919	-0.2449	*****	*****	*****	*****	*****
0.400	-0.2145	-0.1613	-0.0759	-0.1820	-0.2412	*****	*****	*****	*****	*****
0.450	-0.2362	-0.1692	-0.0834	-0.1796	-0.2624	*****	*****	*****	*****	*****
0.500	-0.2526	-0.1728	-0.0999	-0.1763	-0.3118	*****	*****	*****	*****	*****
0.525	*****	-0.1776	-0.1034	-0.1743	-0.3479	*****	*****	*****	*****	*****
0.550	-0.2689	-0.1819	-0.1131	-0.1732	-0.3787	*****	*****	*****	*****	*****
0.575	*****	-0.1969	-0.1108	-0.1698	-0.4183	*****	*****	*****	*****	*****
0.600	-0.2754	-0.2037	-0.1218	-0.1715	-0.4514	*****	*****	*****	*****	*****
0.625	*****	*****	-0.1277	-0.1734	-0.4799	*****	*****	*****	*****	*****
0.650	-0.2801	-0.2199	-0.1385	-0.1660	-0.4874	*****	*****	*****	*****	*****
0.675	*****	-0.2371	-0.1427	-0.1545	-0.4742	*****	*****	*****	*****	*****
0.700	-0.2697	-0.2599	-0.1409	-0.1385	-0.4591	*****	*****	*****	*****	*****
0.725	*****	-0.2784	*****	-0.1196	-0.5092	*****	*****	*****	*****	*****
0.750	-0.2413	-0.2837	*****	-0.2476	-0.7177	*****	*****	*****	*****	*****
0.775	*****	-0.2886	-0.2285	-0.5413	-0.8738	*****	*****	*****	*****	*****
0.800	-0.2303	-0.3016	-0.4792	-0.7024	*****	*****	*****	*****	*****	*****
0.825	*****	-0.4082	-0.6418	-0.7457	-0.8861	*****	*****	*****	*****	*****
0.850	-0.4071	-0.5603	-0.7167	-0.7281	-0.7377	*****	*****	*****	*****	*****
0.875	*****	-0.6897	-0.7044	-0.6774	-0.6920	*****	*****	*****	*****	*****
0.900	-0.5288	-0.7591	-0.7059	-0.6200	*****	*****	*****	*****	*****	*****
0.925	*****	-0.7506	-0.6805	-0.5927	-0.6377	*****	*****	*****	*****	*****
0.950	-0.4265	-0.7228	-0.6638	-0.5761	-0.5624	*****	*****	*****	*****	*****
0.975	*****	-0.7219	-0.6514	-0.5712	-0.4883	*****	*****	*****	*****	*****
-0.200	$C_{p,l}$	0.1257	0.1249	0.1796	*****	*****	*****	*****	*****	*****
-0.400	*****	0.1172	0.1316	0.1443	-0.0070	-0.4608	*****	*****	*****	*****
-0.600	*****	*****	0.1392	0.1342	0.0228	-0.4598	*****	*****	*****	*****
-0.700	*****	*****	0.1331	0.1363	0.0332	-0.4678	*****	*****	*****	*****
-0.800	0.1916	0.1478	0.1313	0.0537	-0.4988	*****	*****	*****	*****	*****
-0.850	0.2103	0.1614	0.1454	0.0591	-0.5487	*****	*****	*****	*****	*****
-0.900	0.2267	0.2024	0.1717	0.0868	-0.6082	*****	*****	*****	*****	*****
-0.950	*****	*****	*****	0.2053	0.1404	-0.1884	*****	*****	*****	*****
-0.975	*****	0.1995	0.1958	0.1538	-0.0204	*****	*****	*****	*****	*****

Sharp Radius L.E.

Run No. = 86, Point No. = 1881

$C_N = 0.303$, $C_m = -0.0544$

$\alpha = 7.3^\circ$, $M_\infty = 0.799$

$R_{mac} = 6.0 \times 10^6$

Surface Pressures Near Leading Edge

● / ◆ upper, starboard/port
○ / ◇ lower, starboard/port

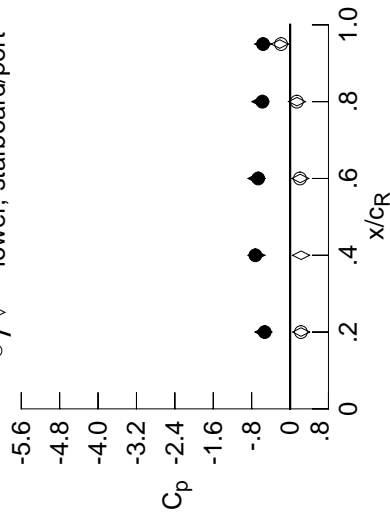

x/c_R	η	$C_{p,u}$ starb'd	$C_{p,u}$ port	$C_{p,l}$ starb'd	$C_{p,l}$ port
0.20	0.90	-0.5288	-0.5565	0.2294	0.2267
0.40	0.95	-0.7228	-0.7006	0.2299	*****
0.60	0.95	-0.6638	-0.7007	0.2124	0.2053
0.80	0.95	-0.5761	-0.6188	0.1442	0.1404
0.95	0.95	-0.5624	-0.5602	-0.2150	-0.1884

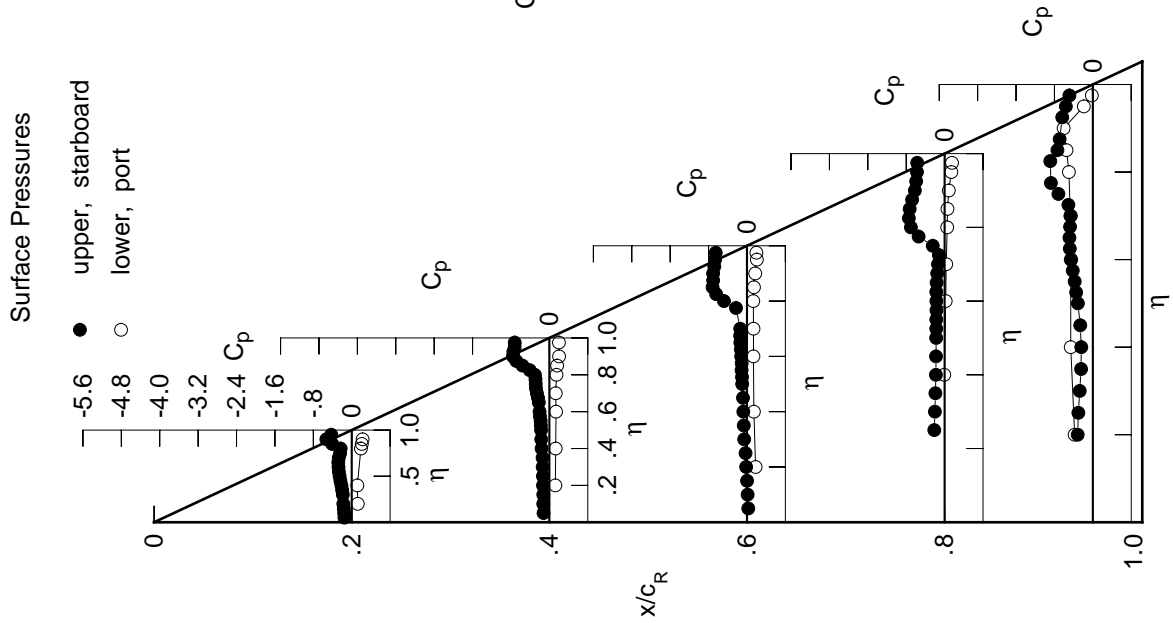

Table D3. Continued.

η	$x/c_R = .2$		$x/c_R = .4$		$x/c_R = .6$		$x/c_R = .8$		$x/c_R = .95$	
	$C_{p,u}$	$C_{p,l}$	$C_{p,u}$	$C_{p,l}$	$C_{p,u}$	$C_{p,l}$	$C_{p,u}$	$C_{p,l}$	$C_{p,u}$	$C_{p,l}$
0.050	-0.1718	-0.1431	0.0089	0.0089	0.0089	0.0089	0.0089	0.0089	0.0089	0.0089
0.100	-0.1797	-0.1493	-0.0045	-0.0045	-0.0045	-0.0045	-0.0045	-0.0045	-0.0045	-0.0045
0.150	-0.1862	-0.1492	-0.0144	-0.0144	-0.0144	-0.0144	-0.0144	-0.0144	-0.0144	-0.0144
0.200	-0.1964	-0.1513	-0.0337	-0.0337	-0.0337	-0.0337	-0.0337	-0.0337	-0.0337	-0.0337
0.250	*****	-0.1575	-0.0477	-0.2309	-0.3141	-0.3141	-0.3141	-0.3141	-0.3141	-0.3141
0.300	-0.2068	-0.1617	-0.0792	-0.2213	-0.2373	-0.2373	-0.2373	-0.2373	-0.2373	-0.2373
0.350	-0.2217	-0.1667	-0.0876	-0.2054	-0.2113	-0.2113	-0.2113	-0.2113	-0.2113	-0.2113
0.400	-0.2368	-0.1835	-0.0943	-0.1922	-0.2316	-0.2316	-0.2316	-0.2316	-0.2316	-0.2316
0.450	-0.2608	-0.2031	-0.1003	-0.1883	-0.2888	-0.2888	-0.2888	-0.2888	-0.2888	-0.2888
0.500	-0.2776	-0.2016	-0.1161	-0.1852	-0.3600	-0.3600	-0.3600	-0.3600	-0.3600	-0.3600
0.525	*****	-0.2024	-0.1180	-0.1817	-0.4037	-0.4037	-0.4037	-0.4037	-0.4037	-0.4037
0.550	-0.2951	-0.2045	-0.1253	-0.1783	-0.4356	-0.4356	-0.4356	-0.4356	-0.4356	-0.4356
0.575	*****	-0.2125	-0.1239	-0.1754	-0.4747	-0.4747	-0.4747	-0.4747	-0.4747	-0.4747
0.600	-0.2986	-0.2224	-0.1302	-0.1701	-0.4952	-0.4952	-0.4952	-0.4952	-0.4952	-0.4952
0.625	*****	*****	-0.1313	-0.1633	-0.5022	-0.5022	-0.5022	-0.5022	-0.5022	-0.5022
0.650	-0.2960	-0.2370	-0.1321	-0.1463	-0.4850	-0.4850	-0.4850	-0.4850	-0.4850	-0.4850
0.675	*****	-0.2500	-0.1259	-0.1296	-0.4597	-0.4597	-0.4597	-0.4597	-0.4597	-0.4597
0.700	-0.2705	-0.2664	-0.1068	-0.1419	-0.5147	-0.5147	-0.5147	-0.5147	-0.5147	-0.5147
0.725	*****	-0.2692	*****	-0.2831	-0.7065	-0.7065	-0.7065	-0.7065	-0.7065	-0.7065
0.750	-0.2451	-0.2710	*****	-0.5991	-0.9052	-0.9052	-0.9052	-0.9052	-0.9052	-0.9052
0.775	*****	-0.3507	-0.6804	-0.8158	-0.9833	-0.9833	-0.9833	-0.9833	-0.9833	-0.9833
0.800	-0.4132	-0.5350	-0.8415	-0.8837	*****	*****	*****	*****	*****	*****
0.825	*****	-0.7141	-0.8596	-0.8873	-0.7440	-0.7440	-0.7440	-0.7440	-0.7440	-0.7440
0.850	-0.6223	-0.8074	-0.8342	-0.8164	-0.6841	-0.6841	-0.6841	-0.6841	-0.6841	-0.6841
0.875	*****	-0.8500	-0.7548	-0.6879	-0.5975	-0.5975	-0.5975	-0.5975	-0.5975	-0.5975
0.900	-0.5996	-0.8486	-0.7266	-0.6393	*****	*****	*****	*****	*****	*****
0.925	*****	-0.8222	-0.6971	-0.6038	-0.5848	-0.5848	-0.5848	-0.5848	-0.5848	-0.5848
0.950	-0.5846	-0.8012	-0.6833	-0.5867	-0.5247	-0.5247	-0.5247	-0.5247	-0.5247	-0.5247
0.975	*****	-0.8010	-0.6695	-0.5778	-0.4671	-0.4671	-0.4671	-0.4671	-0.4671	-0.4671

η	$x/c_R = .2$		$x/c_R = .4$		$x/c_R = .6$		$x/c_R = .8$		$x/c_R = .95$	
	$C_{p,u}$	$C_{p,l}$	$C_{p,u}$	$C_{p,l}$	$C_{p,u}$	$C_{p,l}$	$C_{p,u}$	$C_{p,l}$	$C_{p,u}$	$C_{p,l}$
-0.200	0.1477	0.1471	0.1954	0.1954	0.1954	0.1954	0.1954	0.1954	0.1954	0.1954
-0.400	0.1366	0.1530	0.1593	0.0062	-0.4738	-0.4738	-0.4738	-0.4738	-0.4738	-0.4738
-0.600	*****	0.1624	0.1545	0.0372	-0.4699	-0.4699	-0.4699	-0.4699	-0.4699	-0.4699
-0.700	*****	0.1590	0.1552	0.0497	-0.4965	-0.4965	-0.4965	-0.4965	-0.4965	-0.4965
-0.800	0.2158	0.1785	0.1545	0.0705	-0.5265	-0.5265	-0.5265	-0.5265	-0.5265	-0.5265
-0.850	0.2306	0.1869	0.1697	0.0782	-0.5590	-0.5590	-0.5590	-0.5590	-0.5590	-0.5590
-0.900	0.2416	0.2245	0.1948	0.1039	-0.5911	-0.5911	-0.5911	-0.5911	-0.5911	-0.5911
-0.950	*****	*****	0.2183	0.1544	-0.1793	-0.1793	-0.1793	-0.1793	-0.1793	-0.1793
-0.975	*****	0.1941	0.1962	0.1559	-0.0153	-0.0153	-0.0153	-0.0153	-0.0153	-0.0153

Sharp Radius L.E.
 Run No. = 86 , Point No. = 1882
 $C_N = 0.357$, $C_m = -0.0641$
 $\alpha = 8.3^\circ$, $M_\infty = 0.799$
 $R_{mac} = 6.0 \times 10^6$

Surface Pressures Near Leading Edge

● / ◆ upper, starboard/port
 ○ / ◇ lower, starboard/port

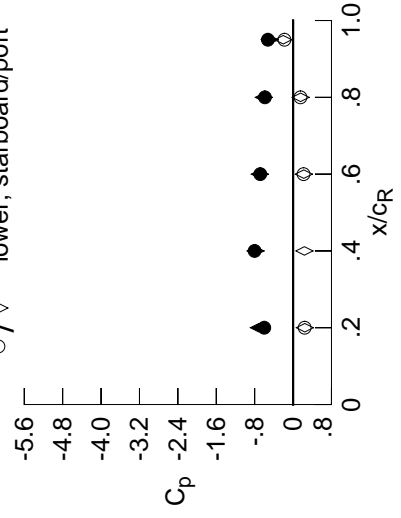

x/c_R	η	starb'd	port	starb'd	port
		$C_{p,u}$	$C_{p,l}$	$C_{p,u}$	$C_{p,l}$
0.20	0.90	-0.5996	-0.7128	0.2450	0.2416
0.40	0.95	-0.8012	-0.7825	0.2357	*****
0.60	0.95	-0.6833	-0.6936	0.2239	0.2183
0.80	0.95	-0.5867	-0.6107	0.1566	0.1544
0.95	0.95	-0.5247	-0.4878	-0.2047	-0.1793

Table D3. Continued.

η	$x/c_R = .2$		$x/c_R = .4$		$x/c_R = .6$		$x/c_R = .8$		$x/c_R = .95$	
	$C_{p,u}$	$C_{p,l}$	$C_{p,u}$	$C_{p,l}$	$C_{p,u}$	$C_{p,l}$	$C_{p,u}$	$C_{p,l}$	$C_{p,u}$	$C_{p,l}$
0.050	-0.1897	-0.1680	-0.0078	*****	*****	*****	*****	*****	*****	*****
0.100	-0.1972	-0.1691	-0.0228	*****	*****	*****	*****	*****	*****	*****
0.150	-0.2093	-0.1769	-0.0341	*****	*****	*****	*****	*****	*****	*****
0.200	-0.2140	-0.1731	-0.0517	*****	*****	*****	*****	*****	*****	*****
0.250	*****	-0.1829	-0.0663	-0.2408	-0.2979	*****	*****	*****	*****	*****
0.300	-0.2288	-0.1821	-0.0942	-0.2317	-0.2207	*****	*****	*****	*****	*****
0.350	-0.2445	-0.1875	-0.1140	-0.2151	-0.2139	*****	*****	*****	*****	*****
0.400	-0.2600	-0.2019	-0.1087	-0.1982	-0.2405	*****	*****	*****	*****	*****
0.450	-0.2839	-0.2355	-0.1162	-0.1963	-0.3248	*****	*****	*****	*****	*****
0.500	-0.3017	-0.2313	-0.1299	-0.1884	-0.4099	*****	*****	*****	*****	*****
0.525	*****	-0.2280	-0.1328	-0.1843	-0.4525	*****	*****	*****	*****	*****
0.550	-0.3165	-0.2319	-0.1356	-0.1796	-0.4800	*****	*****	*****	*****	*****
0.575	*****	-0.2312	-0.1324	-0.1679	-0.5047	*****	*****	*****	*****	*****
0.600	-0.3126	-0.2392	-0.1335	-0.1654	-0.5097	*****	*****	*****	*****	*****
0.625	*****	*****	-0.1271	-0.1508	-0.5003	*****	*****	*****	*****	*****
0.650	-0.2922	-0.2320	-0.1153	-0.1445	-0.5042	*****	*****	*****	*****	*****
0.675	*****	-0.2419	-0.1070	-0.1848	-0.5486	*****	*****	*****	*****	*****
0.700	-0.2588	-0.2481	-0.1496	-0.3407	-0.7149	*****	*****	*****	*****	*****
0.725	*****	-0.2905	*****	-0.6262	-0.8952	*****	*****	*****	*****	*****
0.750	-0.4059	-0.4610	*****	-0.8680	-1.0156	*****	*****	*****	*****	*****
0.775	*****	-0.7255	-0.9608	-0.9839	-0.8870	*****	*****	*****	*****	*****
0.800	-0.6645	-0.8604	-1.0066	-0.9810	*****	*****	*****	*****	*****	*****
0.825	*****	-0.9176	-0.9717	-0.8643	-0.5574	*****	*****	*****	*****	*****
0.850	-0.7508	-0.9223	-0.9063	-0.7262	-0.5909	*****	*****	*****	*****	*****
0.875	*****	-0.9218	-0.7879	-0.6996	-0.5393	*****	*****	*****	*****	*****
0.900	-0.6727	-0.9027	-0.7450	-0.6683	*****	*****	*****	*****	*****	*****
0.925	*****	-0.8733	-0.7174	-0.6185	-0.5270	*****	*****	*****	*****	*****
0.950	-0.7214	-0.8551	-0.6958	-0.6188	-0.4629	*****	*****	*****	*****	*****
0.975	*****	-0.8575	-0.6787	-0.6091	-0.4062	*****	*****	*****	*****	*****

η	$x/c_R = .2$		$x/c_R = .4$		$x/c_R = .6$		$x/c_R = .8$		$x/c_R = .95$	
	$C_{p,u}$	$C_{p,l}$	$C_{p,u}$	$C_{p,l}$	$C_{p,u}$	$C_{p,l}$	$C_{p,u}$	$C_{p,l}$	$C_{p,u}$	$C_{p,l}$
-0.200	0.1743	0.1676	0.2125	*****	*****	*****	*****	*****	*****	*****
-0.400	0.1621	0.1759	0.1768	0.0195	-0.4851	*****	*****	*****	*****	*****
-0.600	*****	0.1841	0.1728	0.0507	-0.4828	*****	*****	*****	*****	*****
-0.700	*****	0.1839	0.1747	0.0638	-0.5235	*****	*****	*****	*****	*****
-0.800	0.2407	0.2041	0.1764	0.0863	-0.5423	*****	*****	*****	*****	*****
-0.850	0.2504	0.2092	0.1923	0.0953	-0.5596	*****	*****	*****	*****	*****
-0.900	0.2563	0.2426	0.2171	0.1210	-0.5726	*****	*****	*****	*****	*****
-0.950	*****	*****	0.2277	0.1649	-0.1715	*****	*****	*****	*****	*****
-0.975	*****	0.1885	0.1935	0.1570	-0.0144	*****	*****	*****	*****	*****

Sharp Radius L.E.
 Run No. = 86 , Point No. = 1883
 $C_N = 0.406$, $C_m = -0.0707$
 $\alpha = 9.3^\circ$, $M_\infty = 0.800$
 $R_{mac} = 6.0 \times 10^6$

Surface Pressures Near Leading Edge

● / ◆ upper, starboard/port
 ○ / ◇ lower, starboard/port

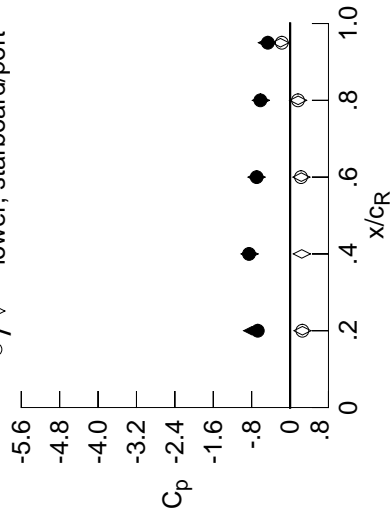

x/c_R	η	starb'd	port	starb'd	port
		$C_{p,u}$	$C_{p,l}$	$C_{p,u}$	$C_{p,l}$
0.20	0.90	-0.6727	-0.7903	0.2579	0.2563
0.40	0.95	-0.8551	-0.8447	0.2443	*****
0.60	0.95	-0.6958	-0.6999	0.2345	0.2277
0.80	0.95	-0.6188	-0.6083	0.1677	0.1649
0.95	0.95	-0.4629	-0.4832	-0.1997	-0.1715

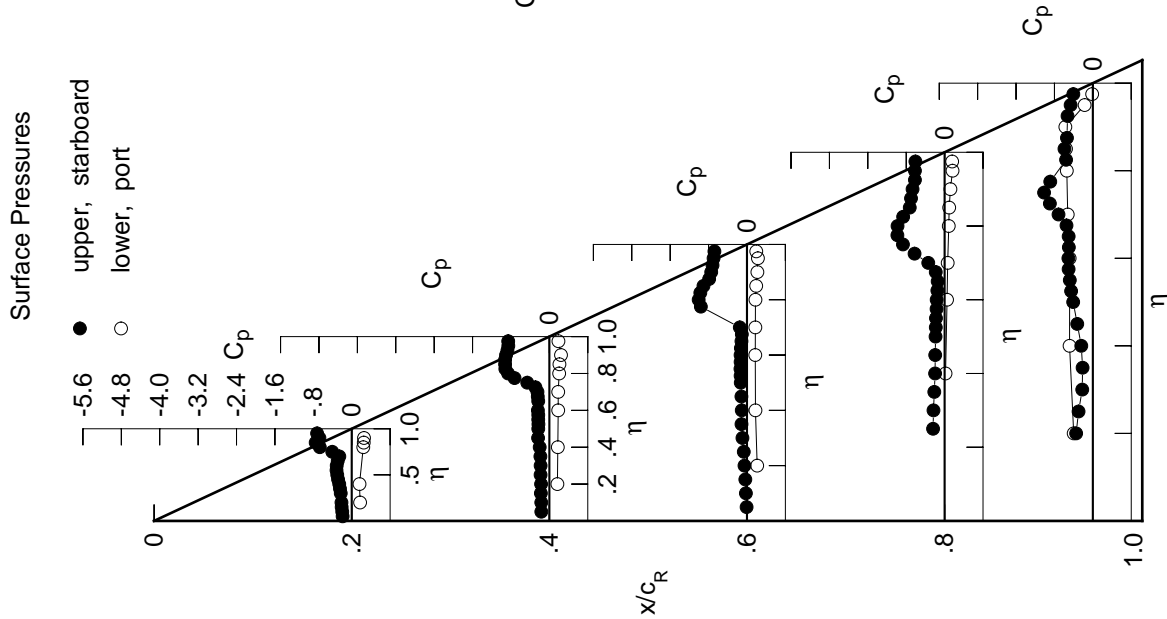

Table D3. Continued.

η	$x/c_R = .2$		$x/c_R = .4$		$x/c_R = .6$		$x/c_R = .8$		$x/c_R = .95$	
	$C_{p,u}$	$C_{p,l}$	$C_{p,u}$	$C_{p,l}$	$C_{p,u}$	$C_{p,l}$	$C_{p,u}$	$C_{p,l}$	$C_{p,u}$	$C_{p,l}$
0.050	-0.2144	-0.1923	-0.0297	*****	*****	*****	*****	*****	*****	*****
0.100	-0.2190	-0.1942	-0.0386	*****	*****	*****	*****	*****	*****	*****
0.150	-0.2315	-0.1990	-0.0555	*****	*****	*****	*****	*****	*****	*****
0.200	-0.2371	-0.1999	-0.0670	*****	*****	*****	*****	*****	*****	*****
0.250	*****	-0.2045	-0.0832	-0.2500	-0.2449	*****	*****	*****	*****	*****
0.300	-0.2518	-0.2064	-0.1022	-0.2369	-0.2339	*****	*****	*****	*****	*****
0.350	-0.2668	-0.2083	-0.1303	-0.2226	-0.2364	*****	*****	*****	*****	*****
0.400	-0.2838	-0.2160	-0.1272	-0.2080	-0.2857	*****	*****	*****	*****	*****
0.450	-0.3079	-0.2484	-0.1288	-0.2019	-0.3734	*****	*****	*****	*****	*****
0.500	-0.3232	-0.2611	-0.1425	-0.1951	-0.4514	*****	*****	*****	*****	*****
0.525	*****	-0.2572	-0.1419	-0.1858	-0.4817	*****	*****	*****	*****	*****
0.550	-0.3322	-0.2568	-0.1436	-0.1804	-0.4986	*****	*****	*****	*****	*****
0.575	*****	-0.2542	-0.1318	-0.1721	-0.5111	*****	*****	*****	*****	*****
0.600	-0.3121	-0.2418	-0.1314	-0.1704	-0.5211	*****	*****	*****	*****	*****
0.625	*****	*****	-0.1203	-0.1835	-0.5520	*****	*****	*****	*****	*****
0.650	-0.2661	-0.2083	-0.1297	-0.2397	-0.6404	*****	*****	*****	*****	*****
0.675	*****	-0.2108	-0.2197	-0.3964	-0.7567	*****	*****	*****	*****	*****
0.700	-0.3630	-0.3597	-0.4759	-0.6482	-0.9009	*****	*****	*****	*****	*****
0.725	*****	-0.6940	*****	-0.8943	-0.9893	*****	*****	*****	*****	*****
0.750	-0.6939	-0.9227	*****	-1.0517	-0.8345	*****	*****	*****	*****	*****
0.775	*****	-1.0327	-1.1076	-1.0262	-0.5957	*****	*****	*****	*****	*****
0.800	-0.8396	-1.0467	-1.1266	-0.8145	*****	*****	*****	*****	*****	*****
0.825	*****	-1.0254	-1.0568	-0.7047	-0.5152	*****	*****	*****	*****	*****
0.850	-0.8397	-0.9952	-0.9184	-0.7064	-0.5325	*****	*****	*****	*****	*****
0.875	*****	-0.9658	-0.7911	-0.7133	-0.5037	*****	*****	*****	*****	*****
0.900	-0.7536	-0.9370	-0.7777	-0.6674	*****	*****	*****	*****	*****	*****
0.925	*****	-0.9097	-0.7372	-0.6642	-0.4646	*****	*****	*****	*****	*****
0.950	-0.8311	-0.8901	-0.7088	-0.6651	-0.3990	*****	*****	*****	*****	*****
0.975	*****	-0.8920	-0.6911	-0.6525	-0.3536	*****	*****	*****	*****	*****

η	$x/c_R = .2$		$x/c_R = .4$		$x/c_R = .6$		$x/c_R = .8$		$x/c_R = .95$	
	$C_{p,u}$	$C_{p,l}$	$C_{p,u}$	$C_{p,l}$	$C_{p,u}$	$C_{p,l}$	$C_{p,u}$	$C_{p,l}$	$C_{p,u}$	$C_{p,l}$
-0.200	0.2031	0.1911	0.2285	*****	*****	*****	*****	*****	*****	*****
-0.400	0.1914	0.2002	0.1970	0.0314	-0.5055	*****	*****	*****	*****	*****
-0.600	*****	0.2100	0.1897	0.0669	-0.5241	*****	*****	*****	*****	*****
-0.700	*****	0.2099	0.1972	0.0770	-0.5802	*****	*****	*****	*****	*****
-0.800	0.2644	0.2312	0.1972	0.1028	-0.5629	*****	*****	*****	*****	*****
-0.850	0.2710	0.2319	0.2127	0.1120	-0.5660	*****	*****	*****	*****	*****
-0.900	0.2692	0.2631	0.2342	0.1378	-0.5618	*****	*****	*****	*****	*****
-0.950	*****	*****	0.2379	0.1713	-0.1644	*****	*****	*****	*****	*****
-0.975	*****	0.1806	0.1899	0.1525	-0.0137	*****	*****	*****	*****	*****

Sharp Radius L.E.
 Run No. = 86 , Point No. = 1884
 $C_N = 0.457$, $C_m = -0.0769$
 $\alpha = 10.4^\circ$, $M_\infty = 0.799$
 $R_{mac} = 6.0 \times 10^6$

Surface Pressures Near Leading Edge

● / ◆ upper, starboard/port
 ○ / ◇ lower, starboard/port

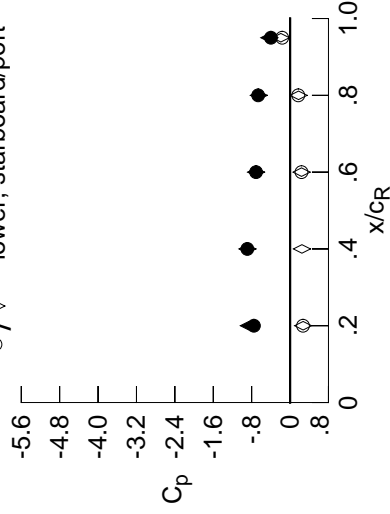

x/c_R	η	starb'd	port	starb'd	port
		$C_{p,u}$	$C_{p,l}$	$C_{p,u}$	$C_{p,l}$
0.20	0.90	-0.7536	-0.8593	0.2723	0.2692
0.40	0.95	-0.8901	-0.8885	0.2469	*****
0.60	0.95	-0.7088	-0.7077	0.2395	0.2379
0.80	0.95	-0.6651	-0.6511	0.1771	0.1713
0.95	0.95	-0.3990	-0.4328	-0.1918	-0.1644

Table D3. Continued.

η	$x/c_R = .2$		$x/c_R = .4$		$x/c_R = .6$		$x/c_R = .8$		$x/c_R = .95$	
	$C_{p,u}$	$C_{p,l}$	$C_{p,u}$	$C_{p,l}$	$C_{p,u}$	$C_{p,l}$	$C_{p,u}$	$C_{p,l}$	$C_{p,u}$	$C_{p,l}$
0.050	-0.2387	-0.2165	-0.0483	*****	*****	*****	*****	*****	*****	*****
0.100	-0.2445	-0.2237	-0.0571	*****	*****	*****	*****	*****	*****	*****
0.150	-0.2539	-0.2246	-0.0713	*****	*****	*****	*****	*****	*****	*****
0.200	-0.2625	-0.2268	-0.0843	*****	*****	*****	*****	*****	*****	*****
0.250	*****	-0.2306	-0.0972	-0.2603	-0.1711	*****	*****	*****	*****	*****
0.300	-0.2744	-0.2315	-0.1160	-0.2467	-0.2575	*****	*****	*****	*****	*****
0.350	-0.2910	-0.2320	-0.1389	-0.2369	-0.3167	*****	*****	*****	*****	*****
0.400	-0.3078	-0.2364	-0.1448	-0.2209	-0.3849	*****	*****	*****	*****	*****
0.450	-0.3301	-0.2552	-0.1412	-0.2127	-0.4502	*****	*****	*****	*****	*****
0.500	-0.3413	-0.2730	-0.1522	-0.2056	-0.4945	*****	*****	*****	*****	*****
0.525	*****	-0.2707	-0.1479	-0.2001	-0.5127	*****	*****	*****	*****	*****
0.550	-0.3380	-0.2683	-0.1496	-0.2018	-0.5207	*****	*****	*****	*****	*****
0.575	*****	-0.2592	-0.1345	-0.2104	-0.5479	*****	*****	*****	*****	*****
0.600	-0.2872	-0.2402	-0.1474	-0.2459	-0.5977	*****	*****	*****	*****	*****
0.625	*****	*****	-0.1720	-0.3305	-0.6970	*****	*****	*****	*****	*****
0.650	-0.2542	-0.3016	-0.2919	-0.4798	-0.8292	*****	*****	*****	*****	*****
0.675	*****	-0.5564	-0.5437	-0.6997	-0.9357	*****	*****	*****	*****	*****
0.700	-0.6518	-0.8910	-0.8557	-0.9258	-1.0089	*****	*****	*****	*****	*****
0.725	*****	-1.0804	*****	-1.0742	-0.8185	*****	*****	*****	*****	*****
0.750	-0.9306	-1.1359	*****	-1.0161	-0.6118	*****	*****	*****	*****	*****
0.775	*****	-1.1407	-1.2148	-0.8065	-0.5127	*****	*****	*****	*****	*****
0.800	-0.9584	-1.1169	-1.1561	-0.7222	*****	*****	*****	*****	*****	*****
0.825	*****	-1.0764	-0.9405	-0.7172	-0.4986	*****	*****	*****	*****	*****
0.850	-0.9234	-1.0308	-0.8583	-0.7327	-0.4898	*****	*****	*****	*****	*****
0.875	*****	-0.9872	-0.8192	-0.7169	-0.4755	*****	*****	*****	*****	*****
0.900	-0.8365	-0.9544	-0.8219	-0.6999	*****	*****	*****	*****	*****	*****
0.925	*****	-0.9304	-0.7616	-0.7040	-0.4288	*****	*****	*****	*****	*****
0.950	-0.9224	-0.9095	-0.7379	-0.6934	-0.3653	*****	*****	*****	*****	*****
0.975	*****	-0.9143	-0.7249	-0.6781	-0.3292	*****	*****	*****	*****	*****
-0.200	$C_{p,l}$	0.2287	0.2121	0.2438	*****	-0.4357	*****	*****	*****	*****
-0.400	*****	0.2201	0.2206	0.2129	0.0451	-0.5108	*****	*****	*****	*****
-0.600	*****	0.2334	0.2334	0.2075	0.0788	-0.5750	*****	*****	*****	*****
-0.700	*****	0.2354	0.2354	0.2130	0.0904	-0.6267	*****	*****	*****	*****
-0.800	0.2874	0.2500	0.2155	0.1169	-0.5773	*****	*****	*****	*****	*****
-0.850	0.2898	0.2517	0.2313	0.1279	-0.5684	*****	*****	*****	*****	*****
-0.900	0.2821	0.2764	0.2501	0.1529	-0.5528	*****	*****	*****	*****	*****
-0.950	*****	*****	0.2387	0.1782	-0.1587	*****	*****	*****	*****	*****
-0.975	*****	0.1745	0.1819	0.1491	-0.0158	*****	*****	*****	*****	*****

Sharp Radius L.E.
 Run No. = 86 , Point No. = 1885
 $C_N = 0.507$, $C_m = -0.0832$
 $\alpha = 11.4^\circ$, $M_\infty = 0.799$
 $R_{mac} = 6.0 \times 10^6$

Surface Pressures Near Leading Edge

● / ◆ upper, starboard/port
 ○ / ◇ lower, starboard/port

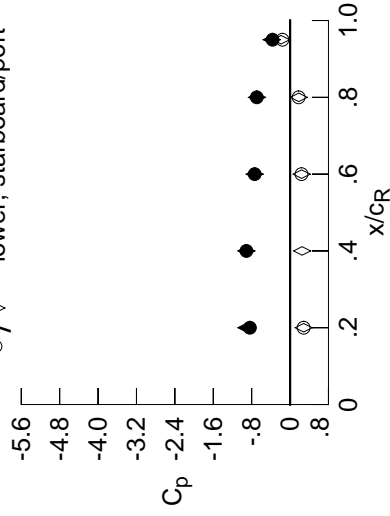

x/c_R	η	starb'd	port	starb'd	port
		$C_{p,u}$	$C_{p,l}$	$C_{p,u}$	$C_{p,l}$
0.20	0.90	-0.8365	-0.9114	0.2832	0.2821
0.40	0.95	-0.9095	-0.9114	0.2501	*****
0.60	0.95	-0.7379	-0.7395	0.2405	0.2387
0.80	0.95	-0.6934	-0.6894	0.1818	0.1782
0.95	0.95	-0.3653	-0.3860	-0.1874	-0.1587

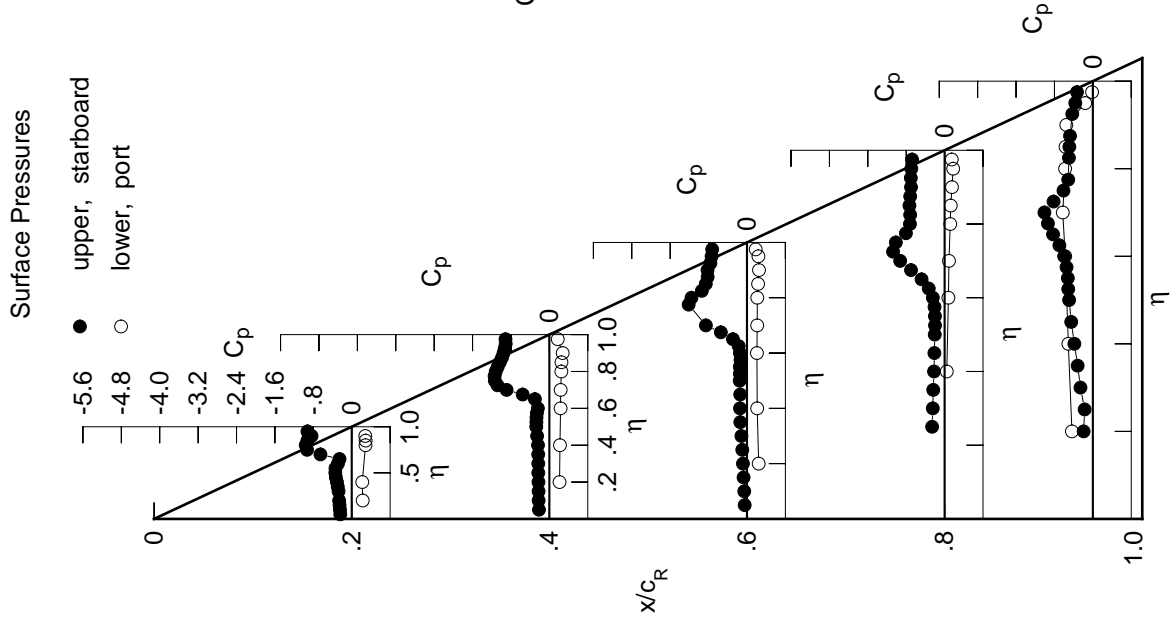

Table D3. Continued.

η	$x/c_R = .2$		$x/c_R = .4$		$x/c_R = .6$		$x/c_R = .8$		$x/c_R = .95$	
	$C_{p,u}$	$C_{p,l}$	$C_{p,u}$	$C_{p,l}$	$C_{p,u}$	$C_{p,l}$	$C_{p,u}$	$C_{p,l}$	$C_{p,u}$	$C_{p,l}$
0.050	-0.2621	-0.2490	-0.0668	*****	*****	*****	*****	*****	*****	*****
0.100	-0.2685	-0.2544	-0.0762	*****	*****	*****	*****	*****	*****	*****
0.150	-0.2771	-0.2558	-0.0891	*****	*****	*****	*****	*****	*****	*****
0.200	-0.2870	-0.2564	-0.1016	*****	*****	*****	*****	*****	*****	*****
0.250	*****	-0.2601	-0.1164	-0.2726	-0.1420	*****	*****	*****	*****	*****
0.300	-0.2974	-0.2616	-0.1338	-0.2567	-0.2498	*****	*****	*****	*****	*****
0.350	-0.3157	-0.2594	-0.1468	-0.2471	-0.3391	*****	*****	*****	*****	*****
0.400	-0.3305	-0.2647	-0.1575	-0.2334	-0.4241	*****	*****	*****	*****	*****
0.450	-0.3500	-0.2617	-0.1542	-0.2253	-0.4918	*****	*****	*****	*****	*****
0.500	-0.3535	-0.2732	-0.1618	-0.2252	-0.5232	*****	*****	*****	*****	*****
0.525	*****	-0.2769	-0.1577	-0.2297	-0.5473	*****	*****	*****	*****	*****
0.550	-0.3344	-0.2755	-0.1622	-0.2483	-0.5687	*****	*****	*****	*****	*****
0.575	*****	-0.2751	-0.1675	-0.2904	-0.6266	*****	*****	*****	*****	*****
0.600	-0.2533	-0.2934	-0.2266	-0.3755	-0.7177	*****	*****	*****	*****	*****
0.625	*****	*****	-0.3399	-0.5182	-0.8502	*****	*****	*****	*****	*****
0.650	-0.3942	-0.6984	-0.5847	-0.7085	-0.9969	*****	*****	*****	*****	*****
0.675	*****	-0.9884	-0.8879	-0.9262	-1.0916	*****	*****	*****	*****	*****
0.700	-0.9309	-1.1663	-1.1367	-1.1014	-0.8636	*****	*****	*****	*****	*****
0.725	*****	-1.2349	*****	-1.0830	-0.5827	*****	*****	*****	*****	*****
0.750	-1.0811	-1.2285	*****	-0.8920	-0.5200	*****	*****	*****	*****	*****
0.775	*****	-1.2031	-1.1939	-0.7722	-0.4993	*****	*****	*****	*****	*****
0.800	-1.0568	-1.1567	-0.9809	-0.7571	*****	*****	*****	*****	*****	*****
0.825	*****	-1.1048	-0.8944	-0.7627	-0.4952	*****	*****	*****	*****	*****
0.850	-1.0047	-1.0501	-0.8814	-0.7721	-0.4713	*****	*****	*****	*****	*****
0.875	*****	-1.0067	-0.8619	-0.7488	-0.4625	*****	*****	*****	*****	*****
0.900	-0.9154	-0.9758	-0.8481	-0.7223	*****	*****	*****	*****	*****	*****
0.925	*****	-0.9536	-0.7890	-0.7221	-0.4150	*****	*****	*****	*****	*****
0.950	-0.9977	-0.9363	-0.7745	-0.7118	-0.3517	*****	*****	*****	*****	*****
0.975	*****	-0.9447	-0.7674	-0.6938	-0.3209	*****	*****	*****	*****	*****

η	$x/c_R = .2$		$x/c_R = .4$		$x/c_R = .6$		$x/c_R = .8$		$x/c_R = .95$	
	$C_{p,u}$	$C_{p,l}$	$C_{p,u}$	$C_{p,l}$	$C_{p,u}$	$C_{p,l}$	$C_{p,u}$	$C_{p,l}$	$C_{p,u}$	$C_{p,l}$
-0.200	0.2551	0.2361	0.2618	*****	-0.4876	*****	*****	*****	*****	*****
-0.400	0.2475	0.2429	0.2289	0.0567	-0.5313	*****	*****	*****	*****	*****
-0.600	*****	0.2565	0.2259	0.0919	-0.6115	*****	*****	*****	*****	*****
-0.700	*****	0.2604	0.2319	0.1043	-0.6403	*****	*****	*****	*****	*****
-0.800	0.3090	0.2742	0.2335	0.1314	-0.5788	*****	*****	*****	*****	*****
-0.850	0.3058	0.2714	0.2474	0.1433	-0.5638	*****	*****	*****	*****	*****
-0.900	0.2932	0.2888	0.2610	0.1665	-0.5403	*****	*****	*****	*****	*****
-0.950	*****	*****	0.2400	0.1836	-0.1551	*****	*****	*****	*****	*****
-0.975	*****	0.1662	0.1699	0.1424	-0.0186	*****	*****	*****	*****	*****

Sharp Radius L.E.
 Run No. = 86 , Point No. = 1886
 $C_N = 0.558$, $C_m = -0.0894$
 $\alpha = 12.4^\circ$, $M_\infty = 0.799$
 $R_{mac} = 6.0 \times 10^6$

Surface Pressures Near Leading Edge

● / ◆ upper, starboard/port
 ○ / ◇ lower, starboard/port

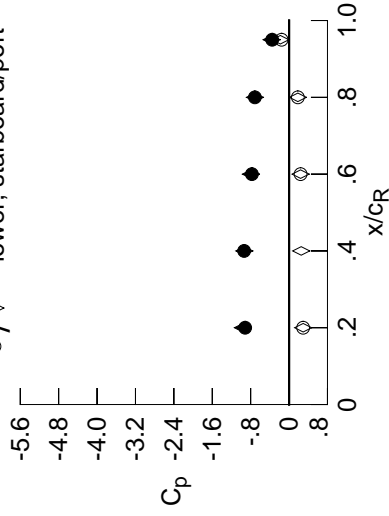

x/c_R	η	starb'd	port	starb'd	port
x/c_R	η	$C_{p,u}$	$C_{p,l}$	$C_{p,u}$	$C_{p,l}$
0.20	0.90	-0.9154	-0.9618	0.2937	0.2932
0.40	0.95	-0.9363	-0.9329	0.2525	*****
0.60	0.95	-0.7745	-0.7950	0.2404	0.2400
0.80	0.95	-0.7118	-0.7110	0.1832	0.1836
0.95	0.95	-0.3517	-0.3642	-0.1816	-0.1551

Table D3. Continued.

η	$x/c_R = .2$		$x/c_R = .4$		$x/c_R = .6$		$x/c_R = .8$		$x/c_R = .95$	
	$C_{p,u}$	$C_{p,l}$	$C_{p,u}$	$C_{p,l}$	$C_{p,u}$	$C_{p,l}$	$C_{p,u}$	$C_{p,l}$	$C_{p,u}$	$C_{p,l}$
0.050	-0.2873	-0.2787	-0.0842	*****	*****	*****	*****	*****	*****	*****
0.100	-0.2917	-0.2841	-0.0963	*****	*****	*****	*****	*****	*****	*****
0.150	-0.3030	-0.2882	-0.1068	*****	*****	*****	*****	*****	*****	*****
0.200	-0.3087	-0.2847	-0.1211	*****	*****	*****	*****	*****	*****	*****
0.250	*****	-0.2902	-0.1340	-0.2869	-0.1450	*****	*****	*****	*****	*****
0.300	-0.3224	-0.2902	-0.1510	-0.2683	-0.2336	*****	*****	*****	*****	*****
0.350	-0.3381	-0.2925	-0.1650	-0.2590	-0.3304	*****	*****	*****	*****	*****
0.400	-0.3516	-0.2931	-0.1715	-0.2456	-0.4220	*****	*****	*****	*****	*****
0.450	-0.3669	-0.2880	-0.1681	-0.2428	-0.4894	*****	*****	*****	*****	*****
0.500	-0.3600	-0.2781	-0.1801	-0.2552	-0.5336	*****	*****	*****	*****	*****
0.525	*****	-0.2808	-0.1875	-0.2728	-0.5711	*****	*****	*****	*****	*****
0.550	-0.3171	-0.2888	-0.2117	-0.3195	-0.6205	*****	*****	*****	*****	*****
0.575	*****	-0.3324	-0.2529	-0.3963	-0.7107	*****	*****	*****	*****	*****
0.600	-0.2498	-0.4458	-0.3852	-0.5245	-0.8286	*****	*****	*****	*****	*****
0.625	*****	*****	-0.5769	-0.6968	-0.9812	*****	*****	*****	*****	*****
0.650	-0.7090	-0.9962	-0.8686	-0.8952	-1.1242	*****	*****	*****	*****	*****
0.675	*****	-1.2090	-1.1328	-1.0925	-0.9626	*****	*****	*****	*****	*****
0.700	-1.1495	-1.3229	-1.3184	-1.1703	-0.6061	*****	*****	*****	*****	*****
0.725	*****	-1.3486	*****	-0.9834	-0.5321	*****	*****	*****	*****	*****
0.750	-1.1859	-1.3238	*****	-0.8334	-0.5091	*****	*****	*****	*****	*****
0.775	*****	-1.2859	-1.0471	-0.7883	-0.5009	*****	*****	*****	*****	*****
0.800	-1.1414	-1.2273	-0.9580	-0.7881	*****	*****	*****	*****	*****	*****
0.825	*****	-1.1617	-0.9248	-0.7950	-0.4807	*****	*****	*****	*****	*****
0.850	-1.0762	-1.0917	-0.9247	-0.8025	-0.4570	*****	*****	*****	*****	*****
0.875	*****	-1.0434	-0.9071	-0.7723	-0.4393	*****	*****	*****	*****	*****
0.900	-0.9876	-1.0164	-0.8708	-0.7442	*****	*****	*****	*****	*****	*****
0.925	*****	-0.9882	-0.8230	-0.7426	-0.3929	*****	*****	*****	*****	*****
0.950	-1.0586	-0.9681	-0.8192	-0.7348	-0.3376	*****	*****	*****	*****	*****
0.975	*****	-0.9711	-0.8129	-0.7190	-0.3141	*****	*****	*****	*****	*****
-0.200	0.2825	0.2568	0.2808	*****	-0.5054	*****	*****	*****	*****	*****
-0.400	0.2759	0.2655	0.2494	0.0727	-0.5844	*****	*****	*****	*****	*****
-0.600	*****	0.2807	0.2457	0.1080	-0.6537	*****	*****	*****	*****	*****
-0.700	*****	0.2830	0.2518	0.1197	-0.6479	*****	*****	*****	*****	*****
-0.800	0.3301	0.2955	0.2526	0.1474	-0.5737	*****	*****	*****	*****	*****
-0.850	0.3236	0.2914	0.2638	0.1571	-0.5557	*****	*****	*****	*****	*****
-0.900	0.3015	0.3012	0.2723	0.1786	-0.5252	*****	*****	*****	*****	*****
-0.950	*****	*****	0.2393	0.1865	-0.1487	*****	*****	*****	*****	*****
-0.975	*****	0.1562	0.1587	0.1359	-0.0207	*****	*****	*****	*****	*****

Sharp Radius L.E.
 Run No. = 86 , Point No. = 1887
 $C_N = 0.608$, $C_m = -0.0948$
 $\alpha = 13.4^\circ$, $M_\infty = 0.799$
 $R_{mac} = 6.0 \times 10^6$

Surface Pressures Near Leading Edge

● / ◆ upper, starboard/port
 ○ / ◇ lower, starboard/port

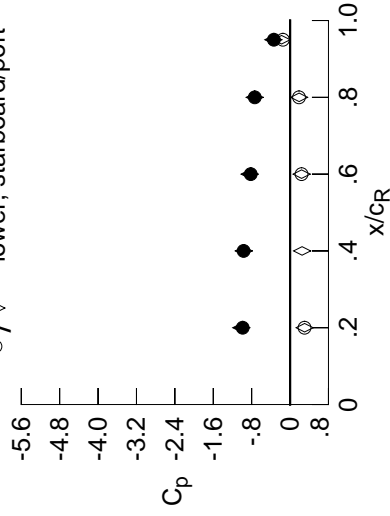

x/c_R	η	starb'd	port	starb'd	port
		$C_{p,u}$	$C_{p,l}$	$C_{p,u}$	$C_{p,l}$
0.20	0.90	-0.9876	-1.0166	0.3035	0.3015
0.40	0.95	-0.9681	-0.9646	0.2508	*****
0.60	0.95	-0.8192	-0.8441	0.2396	0.2393
0.80	0.95	-0.7348	-0.7379	0.1886	0.1865
0.95	0.95	-0.3376	-0.3486	-0.1759	-0.1487

Surface Pressures

● upper, starboard
 ○ lower, port

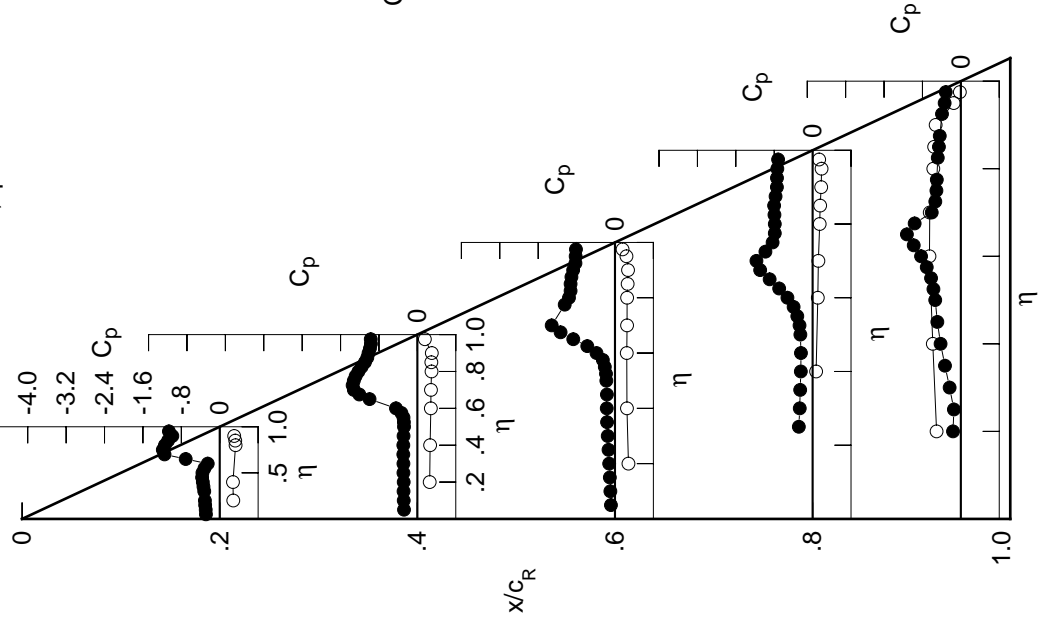

Table D3. Continued.

η	$x/c_R = .2$		$x/c_R = .4$		$x/c_R = .6$		$x/c_R = .8$		$x/c_R = .95$	
	$C_{p,u}$	$C_{p,l}$	$C_{p,u}$	$C_{p,l}$	$C_{p,u}$	$C_{p,l}$	$C_{p,u}$	$C_{p,l}$	$C_{p,u}$	$C_{p,l}$
0.050	-0.3158	-0.3145	-0.1078	*****	*****	*****	*****	*****	*****	*****
0.100	-0.3188	-0.3167	-0.1141	*****	*****	*****	*****	*****	*****	*****
0.150	-0.3315	-0.3225	-0.1299	*****	*****	*****	*****	*****	*****	*****
0.200	-0.3377	-0.3201	-0.1419	*****	*****	*****	*****	*****	*****	*****
0.250	*****	-0.3230	-0.1558	-0.3027	-0.1660	*****	*****	*****	*****	*****
0.300	-0.3501	-0.3226	-0.1758	-0.2851	-0.2443	*****	*****	*****	*****	*****
0.350	-0.3655	-0.3224	-0.1848	-0.2765	-0.3406	*****	*****	*****	*****	*****
0.400	-0.3769	-0.3267	-0.1940	-0.2638	-0.4315	*****	*****	*****	*****	*****
0.450	-0.3876	-0.3205	-0.1923	-0.2691	-0.5025	*****	*****	*****	*****	*****
0.500	-0.3687	-0.3125	-0.2208	-0.3012	-0.5649	*****	*****	*****	*****	*****
0.525	*****	-0.3274	-0.2452	-0.3450	-0.6216	*****	*****	*****	*****	*****
0.550	-0.3193	-0.3603	-0.3043	-0.4157	-0.6972	*****	*****	*****	*****	*****
0.575	*****	-0.4639	-0.3995	-0.5290	-0.8141	*****	*****	*****	*****	*****
0.600	-0.4142	-0.6557	-0.5979	-0.6808	-0.9470	*****	*****	*****	*****	*****
0.625	*****	*****	-0.8259	-0.8670	-1.0995	*****	*****	*****	*****	*****
0.650	-1.0044	-1.1964	-1.0860	-1.0532	-1.0994	*****	*****	*****	*****	*****
0.675	*****	-1.3594	-1.2925	-1.2117	-0.6397	*****	*****	*****	*****	*****
0.700	-1.2197	-1.4396	-1.4261	-1.0897	-0.5679	*****	*****	*****	*****	*****
0.725	*****	-1.4465	*****	-0.9045	-0.5264	*****	*****	*****	*****	*****
0.750	-1.3302	-1.4176	*****	-0.8314	-0.5186	*****	*****	*****	*****	*****
0.775	*****	-1.3805	-1.0196	-0.8179	-0.5088	*****	*****	*****	*****	*****
0.800	-1.2241	-1.3084	-1.0084	-0.8191	*****	*****	*****	*****	*****	*****
0.825	*****	-1.2249	-0.9979	-0.8268	-0.4713	*****	*****	*****	*****	*****
0.850	-1.1384	-1.1392	-1.0087	-0.8300	-0.4388	*****	*****	*****	*****	*****
0.875	*****	-1.0946	-0.9577	-0.8016	-0.4199	*****	*****	*****	*****	*****
0.900	-1.0539	-1.0714	-0.9065	-0.7684	*****	*****	*****	*****	*****	*****
0.925	*****	-1.0340	-0.8743	-0.7705	-0.3784	*****	*****	*****	*****	*****
0.950	-1.1106	-1.0013	-0.8724	-0.7647	-0.3306	*****	*****	*****	*****	*****
0.975	*****	-0.9978	-0.8624	-0.7482	-0.3089	*****	*****	*****	*****	*****

η	$x/c_R = .2$		$x/c_R = .4$		$x/c_R = .6$		$x/c_R = .8$		$x/c_R = .95$	
	$C_{p,u}$	$C_{p,l}$	$C_{p,u}$	$C_{p,l}$	$C_{p,u}$	$C_{p,l}$	$C_{p,u}$	$C_{p,l}$	$C_{p,u}$	$C_{p,l}$
-0.200	0.3093	0.2777	0.2949	*****	*****	*****	*****	*****	*****	*****
-0.400	0.3038	0.2906	0.2670	0.0835	-0.6427	*****	*****	*****	*****	*****
-0.600	*****	0.3030	0.2616	0.1207	-0.6784	*****	*****	*****	*****	*****
-0.700	*****	0.3069	0.2689	0.1318	-0.6539	*****	*****	*****	*****	*****
-0.800	0.3494	0.3151	0.2682	0.1574	-0.5695	*****	*****	*****	*****	*****
-0.850	0.3379	0.3090	0.2779	0.1703	-0.5492	*****	*****	*****	*****	*****
-0.900	0.3112	0.3119	0.2825	0.1882	-0.5122	*****	*****	*****	*****	*****
-0.950	*****	*****	0.2380	0.1879	-0.1456	*****	*****	*****	*****	*****
-0.975	*****	0.1459	0.1462	0.1262	-0.0241	*****	*****	*****	*****	*****

Sharp Radius L.E.
 Run No. = 86 , Point No. = 1888
 $C_N = 0.658$, $C_m = -0.0998$
 $\alpha = 14.5^\circ$, $M_\infty = 0.799$
 $R_{mac} = 6.0 \times 10^6$

Surface Pressures Near Leading Edge

● / ◆ upper, starboard/port
 ○ / ◇ lower, starboard/port

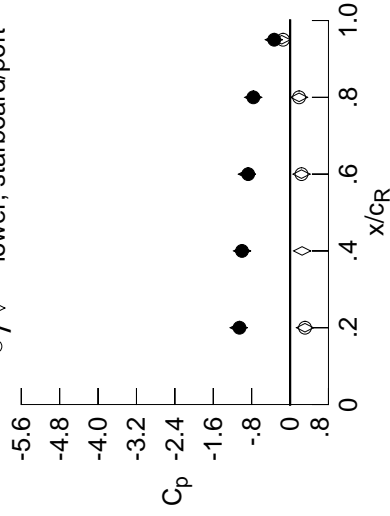

x/c_R	η	starb'd	port	starb'd	port
		$C_{p,u}$	$C_{p,l}$	$C_{p,u}$	$C_{p,l}$
0.20	0.90	-1.0539	-1.0724	0.3107	0.3112
0.40	0.95	-1.0013	-0.9999	0.2504	*****
0.60	0.95	-0.8724	-0.8993	0.2377	0.2380
0.80	0.95	-0.7647	-0.7684	0.1882	0.1879
0.95	0.95	-0.3306	-0.3393	-0.1726	-0.1456

Table D3. Continued.

η	$x/c_R = .2$		$x/c_R = .4$		$x/c_R = .6$		$x/c_R = .8$		$x/c_R = .95$	
	$C_{p,u}$	$C_{p,u}$	$C_{p,u}$	$C_{p,u}$	$C_{p,u}$	$C_{p,u}$	$C_{p,u}$	$C_{p,u}$	$C_{p,u}$	$C_{p,u}$
0.050	-0.3424	-0.3468	-0.1271	*****	*****	*****	*****	*****	*****	*****
0.100	-0.3477	-0.3519	-0.1361	*****	*****	*****	*****	*****	*****	*****
0.150	-0.3586	-0.3540	-0.1473	*****	*****	*****	*****	*****	*****	*****
0.200	-0.3668	-0.3523	-0.1637	*****	*****	*****	*****	*****	*****	*****
0.250	*****	-0.3562	-0.1767	-0.3218	-0.1873	*****	*****	*****	*****	*****
0.300	-0.3791	-0.3559	-0.1960	-0.3021	-0.2621	*****	*****	*****	*****	*****
0.350	-0.3927	-0.3552	-0.2089	-0.2950	-0.3554	*****	*****	*****	*****	*****
0.400	-0.4004	-0.3596	-0.2193	-0.2855	-0.4426	*****	*****	*****	*****	*****
0.450	-0.4044	-0.3544	-0.2271	-0.3064	-0.5229	*****	*****	*****	*****	*****
0.500	-0.3753	-0.3661	-0.2897	-0.3698	-0.6068	*****	*****	*****	*****	*****
0.525	*****	-0.4065	-0.3449	-0.4355	-0.6851	*****	*****	*****	*****	*****
0.550	-0.3494	-0.4877	-0.4523	-0.5351	-0.7798	*****	*****	*****	*****	*****
0.575	*****	-0.6508	-0.5943	-0.6730	-0.9131	*****	*****	*****	*****	*****
0.600	-0.7360	-0.8797	-0.8210	-0.8379	-1.0514	*****	*****	*****	*****	*****
0.625	*****	*****	-1.0336	-1.0220	-1.1475	*****	*****	*****	*****	*****
0.650	-1.3255	-1.3570	-1.2519	-1.1902	-0.6664	*****	*****	*****	*****	*****
0.675	*****	-1.4890	-1.4127	-1.2547	-0.5992	*****	*****	*****	*****	*****
0.700	-1.3365	-1.5543	-1.4724	-1.0015	-0.5682	*****	*****	*****	*****	*****
0.725	*****	-1.5435	*****	-0.8844	-0.5435	*****	*****	*****	*****	*****
0.750	-1.3061	-1.4936	*****	-0.8569	-0.5358	*****	*****	*****	*****	*****
0.775	*****	-1.4518	-1.0402	-0.8503	-0.5169	*****	*****	*****	*****	*****
0.800	-1.3348	-1.3362	-1.0409	-0.8546	*****	*****	*****	*****	*****	*****
0.825	*****	-1.2282	-1.0564	-0.8608	-0.4523	*****	*****	*****	*****	*****
0.850	-1.2024	-1.1735	-1.0850	-0.8623	-0.4169	*****	*****	*****	*****	*****
0.875	*****	-1.1492	-0.9931	-0.8266	-0.3962	*****	*****	*****	*****	*****
0.900	-1.1092	-1.1307	-0.9459	-0.7898	*****	*****	*****	*****	*****	*****
0.925	*****	-1.0813	-0.9246	-0.7884	-0.3663	*****	*****	*****	*****	*****
0.950	-1.1542	-1.0375	-0.9228	-0.7843	-0.3282	*****	*****	*****	*****	*****
0.975	*****	-1.0281	-0.9095	-0.7670	-0.3098	*****	*****	*****	*****	*****
-0.200	$C_{p,l}$	0.3393	0.3036	0.3169	*****	*****	*****	*****	*****	*****
-0.400	$C_{p,l}$	0.3332	0.3132	0.2870	0.1020	-0.6711	*****	*****	*****	*****
-0.600	$C_{p,l}$	*****	0.3270	0.2823	0.1371	-0.6785	*****	*****	*****	*****
-0.700	$C_{p,l}$	*****	0.3271	0.2882	0.1511	-0.6484	*****	*****	*****	*****
-0.800	$C_{p,l}$	0.3710	0.3356	0.2869	0.1754	-0.5620	*****	*****	*****	*****
-0.850	$C_{p,l}$	0.3538	0.3217	0.2960	0.1848	-0.5405	*****	*****	*****	*****
-0.900	$C_{p,l}$	0.3202	0.3217	0.2943	0.2006	-0.4982	*****	*****	*****	*****
-0.950	$C_{p,l}$	*****	*****	0.2373	0.1899	-0.1397	*****	*****	*****	*****
-0.975	$C_{p,l}$	*****	0.1351	0.1344	0.1187	-0.0268	*****	*****	*****	*****

Sharp Radius L.E.

Run No. = 86 , Point No. = 1889

$C_N = 0.708$, $C_m = -0.1048$

$\alpha = 15.5^\circ$, $M_\infty = 0.799$

$R_{mac} = 6.0 \times 10^6$

Surface Pressures Near Leading Edge

● / ◆ upper, starboard/port
○ / ◇ lower, starboard/port

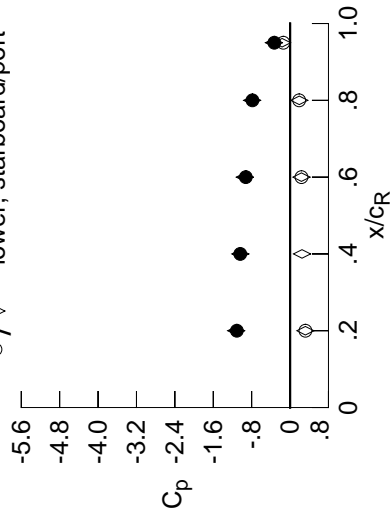

x/c_R	η	starb'd	port	starb'd	port
		$C_{p,u}$	$C_{p,l}$	$C_{p,u}$	$C_{p,l}$
0.20	0.90	-1.1092	-1.1236	0.3196	0.3202
0.40	0.95	-1.0375	-1.0365	0.2486	*****
0.60	0.95	-0.9228	-0.9442	0.2371	0.2373
0.80	0.95	-0.7843	-0.7904	0.1919	0.1899
0.95	0.95	-0.3282	-0.3369	-0.1654	-0.1397

Table D3. Continued.

η	$x/c_R = .2$		$x/c_R = .4$		$x/c_R = .6$		$x/c_R = .8$		$x/c_R = .95$	
	$C_{p,u}$	$C_{p,l}$	$C_{p,u}$	$C_{p,l}$	$C_{p,u}$	$C_{p,l}$	$C_{p,u}$	$C_{p,l}$	$C_{p,u}$	$C_{p,l}$
0.050	-0.3756	-0.3864	-0.1471	*****	*****	*****	*****	*****	*****	*****
0.100	-0.3796	-0.3875	-0.1616	*****	*****	*****	*****	*****	*****	*****
0.150	-0.3911	-0.3944	-0.1684	*****	*****	*****	*****	*****	*****	*****
0.200	-0.4005	-0.3898	-0.1892	*****	*****	*****	*****	*****	*****	*****
0.250	*****	-0.3958	-0.2009	-0.3447	-0.2228	*****	*****	*****	*****	*****
0.300	-0.4130	-0.3939	-0.2242	-0.3222	-0.2856	*****	*****	*****	*****	*****
0.350	-0.4268	-0.3951	-0.2365	-0.3222	-0.3740	*****	*****	*****	*****	*****
0.400	-0.4326	-0.3994	-0.2538	-0.3168	-0.4574	*****	*****	*****	*****	*****
0.450	-0.4336	-0.4060	-0.2853	-0.3560	-0.5498	*****	*****	*****	*****	*****
0.500	-0.4092	-0.4515	-0.3900	-0.4533	-0.6548	*****	*****	*****	*****	*****
0.525	*****	-0.5272	-0.4884	-0.5422	-0.7505	*****	*****	*****	*****	*****
0.550	-0.4934	-0.6551	-0.6265	-0.6639	-0.8566	*****	*****	*****	*****	*****
0.575	*****	-0.8518	-0.7930	-0.8158	-0.9983	*****	*****	*****	*****	*****
0.600	-1.0772	-1.0830	-1.0126	-0.9823	-1.1265	*****	*****	*****	*****	*****
0.625	*****	*****	-1.2005	-1.1504	-0.7021	*****	*****	*****	*****	*****
0.650	-1.4655	-1.4855	-1.3826	-1.3021	-0.6213	*****	*****	*****	*****	*****
0.675	*****	-1.5960	-1.5023	-1.1878	-0.5912	*****	*****	*****	*****	*****
0.700	-1.5661	-1.6552	-1.2308	-0.9613	-0.5902	*****	*****	*****	*****	*****
0.725	*****	-1.6392	*****	-0.9045	-0.5719	*****	*****	*****	*****	*****
0.750	-1.3819	-1.5263	*****	-0.8923	-0.5566	*****	*****	*****	*****	*****
0.775	*****	-1.4146	-1.0714	-0.8877	-0.5169	*****	*****	*****	*****	*****
0.800	-1.3086	-1.2986	-1.0763	-0.8910	*****	*****	*****	*****	*****	*****
0.825	*****	-1.2462	-1.0928	-0.9031	-0.4285	*****	*****	*****	*****	*****
0.850	-1.2456	-1.2276	-1.1056	-0.9018	-0.3922	*****	*****	*****	*****	*****
0.875	*****	-1.2159	-1.0053	-0.8625	-0.3858	*****	*****	*****	*****	*****
0.900	-1.1598	-1.1847	-0.9786	-0.8122	*****	*****	*****	*****	*****	*****
0.925	*****	-1.1198	-0.9707	-0.8051	-0.3691	*****	*****	*****	*****	*****
0.950	-1.1921	-1.0790	-0.9687	-0.8034	-0.3348	*****	*****	*****	*****	*****
0.975	*****	-1.0697	-0.9551	-0.7854	-0.3162	*****	*****	*****	*****	*****

η	$x/c_R = .2$		$x/c_R = .4$		$x/c_R = .6$		$x/c_R = .8$		$x/c_R = .95$	
	$C_{p,u}$	$C_{p,l}$	$C_{p,u}$	$C_{p,l}$	$C_{p,u}$	$C_{p,l}$	$C_{p,u}$	$C_{p,l}$	$C_{p,u}$	$C_{p,l}$
-0.200	0.3655	0.3245	0.3392	*****	-0.5363	*****	*****	*****	*****	*****
-0.400	0.3604	0.3324	0.3031	0.1179	-0.6760	*****	*****	*****	*****	*****
-0.600	*****	0.3463	0.3011	0.1504	-0.6759	*****	*****	*****	*****	*****
-0.700	*****	0.3473	0.3043	0.1656	-0.6388	*****	*****	*****	*****	*****
-0.800	0.3881	0.3525	0.3026	0.1888	-0.5543	*****	*****	*****	*****	*****
-0.850	0.3659	0.3346	0.3087	0.1972	-0.5298	*****	*****	*****	*****	*****
-0.900	0.3271	0.3279	0.3018	0.2092	-0.4845	*****	*****	*****	*****	*****
-0.950	*****	*****	0.2336	0.1903	-0.1356	*****	*****	*****	*****	*****
-0.975	*****	0.1234	0.1204	0.1074	-0.0329	*****	*****	*****	*****	*****

Sharp Radius L.E.
 Run No. = 86 , Point No. = 1890
 $C_N = 0.760$, $C_m = -0.1104$
 $\alpha = 16.5^\circ$, $M_\infty = 0.800$
 $R_{mac} = 6.0 \times 10^6$

Surface Pressures Near Leading Edge

● / ◆ upper, starboard/port
 ○ / ◇ lower, starboard/port

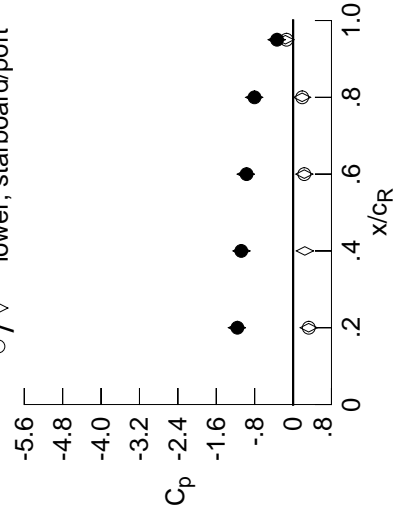

x/c_R	η	starb'd	port	starb'd	port
		$C_{p,u}$	$C_{p,l}$	$C_{p,u}$	$C_{p,l}$
0.20	0.90	-1.1598	-1.1708	0.3251	0.3271
0.40	0.95	-1.0790	-1.0757	0.2447	*****
0.60	0.95	-0.9687	-0.9875	0.2339	0.2336
0.80	0.95	-0.8034	-0.8106	0.1885	0.1903
0.95	0.95	-0.3348	-0.3427	-0.1604	-0.1356

Table D3. Continued.

η	$x/c_R = .2$		$x/c_R = .4$		$x/c_R = .6$		$x/c_R = .8$		$x/c_R = .95$	
	$C_{p,u}$	$C_{p,l}$	$C_{p,u}$	$C_{p,l}$	$C_{p,u}$	$C_{p,l}$	$C_{p,u}$	$C_{p,l}$	$C_{p,u}$	$C_{p,l}$
0.050	-0.4103	-0.4303	-0.1737	*****	*****	*****	*****	*****	*****	*****
0.100	-0.4134	-0.4301	-0.1840	*****	*****	*****	*****	*****	*****	*****
0.150	-0.4248	-0.4340	-0.1979	*****	*****	*****	*****	*****	*****	*****
0.200	-0.4332	-0.4315	-0.2126	*****	*****	*****	*****	*****	*****	*****
0.250	*****	-0.4406	-0.2315	-0.3623	-0.2897	*****	*****	*****	*****	*****
0.300	-0.4423	-0.4360	-0.2517	-0.3464	-0.3324	*****	*****	*****	*****	*****
0.350	-0.4527	-0.4394	-0.2767	-0.3445	-0.3995	*****	*****	*****	*****	*****
0.400	-0.4518	-0.4496	-0.3026	-0.3523	-0.4823	*****	*****	*****	*****	*****
0.450	-0.4442	-0.4743	-0.3618	-0.4051	-0.5814	*****	*****	*****	*****	*****
0.500	-0.4468	-0.5631	-0.5167	-0.5409	-0.7146	*****	*****	*****	*****	*****
0.525	*****	-0.6768	-0.6399	-0.6451	-0.8166	*****	*****	*****	*****	*****
0.550	-0.7272	-0.8375	-0.8025	-0.7853	-0.9305	*****	*****	*****	*****	*****
0.575	*****	-1.0494	-0.9723	-0.9435	-1.0670	*****	*****	*****	*****	*****
0.600	-1.3323	-1.2563	-1.1769	-1.1021	-0.8961	*****	*****	*****	*****	*****
0.625	*****	*****	-1.3371	-1.2647	-0.6292	*****	*****	*****	*****	*****
0.650	-1.5705	-1.6014	-1.4928	-1.3864	-0.6112	*****	*****	*****	*****	*****
0.675	*****	-1.6964	-1.4065	-1.0560	-0.6033	*****	*****	*****	*****	*****
0.700	-1.6553	-1.7386	-1.1575	-0.9572	-0.6126	*****	*****	*****	*****	*****
0.725	*****	-1.5904	*****	-0.9322	-0.5947	*****	*****	*****	*****	*****
0.750	-1.5064	-1.4628	*****	-0.9267	-0.5776	*****	*****	*****	*****	*****
0.775	*****	-1.3976	-1.1164	-0.9274	-0.5200	*****	*****	*****	*****	*****
0.800	-1.3666	-1.3542	-1.1292	-0.9325	*****	*****	*****	*****	*****	*****
0.825	*****	-1.3222	-1.1519	-0.9465	-0.4092	*****	*****	*****	*****	*****
0.850	-1.2567	-1.3025	-1.1396	-0.9513	-0.3819	*****	*****	*****	*****	*****
0.875	*****	-1.2803	-1.0305	-0.8924	-0.3868	*****	*****	*****	*****	*****
0.900	-1.2007	-1.2239	-1.0232	-0.8340	*****	*****	*****	*****	*****	*****
0.925	*****	-1.1583	-1.0176	-0.8227	-0.3888	*****	*****	*****	*****	*****
0.950	-1.2334	-1.1257	-1.0114	-0.8143	-0.3517	*****	*****	*****	*****	*****
0.975	*****	-1.1238	-0.9992	-0.7965	-0.3296	*****	*****	*****	*****	*****
-0.200	$C_{p,l}$	0.3925	0.3451	0.3552	*****	-0.5334	$C_{p,l}$	0.3925	0.3451	0.3552
-0.400	0.3888	0.3525	0.3212	0.1297	-0.6735	*****	0.3888	0.3525	0.3212	0.1297
-0.600	*****	0.3691	0.3171	0.1676	-0.6698	*****	*****	0.3691	0.3171	0.1676
-0.700	*****	0.3693	0.3238	0.1760	-0.6327	*****	*****	0.3693	0.3238	0.1760
-0.800	0.4047	0.3699	0.3179	0.2035	-0.5458	*****	0.4047	0.3699	0.3179	0.2035
-0.850	0.3801	0.3478	0.3209	0.2095	-0.5212	*****	0.3801	0.3478	0.3209	0.2095
-0.900	0.3340	0.3350	0.3091	0.2172	-0.4710	*****	0.3340	0.3350	0.3091	0.2172
-0.950	*****	*****	0.2291	0.1887	-0.1335	*****	*****	*****	0.2291	0.1887
-0.975	*****	0.1089	0.1075	0.0977	-0.0381	*****	*****	0.1089	0.1075	0.0977

Sharp Radius L.E.

Run No. = 86, Point No. = 1891

$C_N = 0.814$, $C_m = -0.1178$

$\alpha = 17.5^\circ$, $M_\infty = 0.799$

$R_{mac} = 6.0 \times 10^6$

Surface Pressures Near Leading Edge

● / ◆ upper, starboard/port
○ / ◇ lower, starboard/port

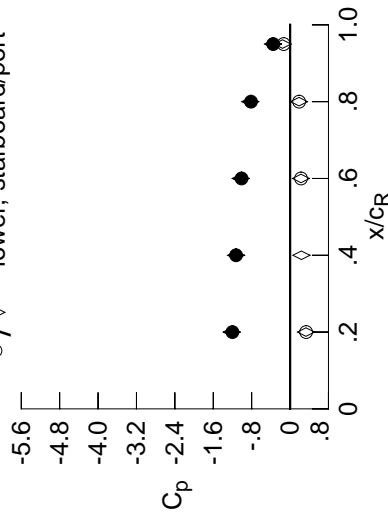

x/c_R	η	$C_{p,u}$ starb'd	$C_{p,u}$ port	$C_{p,l}$ starb'd	$C_{p,l}$ port
0.20	0.90	-1.2007	-1.2168	0.3313	0.3340
0.40	0.95	-1.1257	-1.1244	0.2359	*****
0.60	0.95	-1.0114	-1.0286	0.2272	0.2291
0.80	0.95	-0.8143	-0.8297	0.1867	0.1887
0.95	0.95	-0.3517	-0.3545	-0.1579	-0.1335

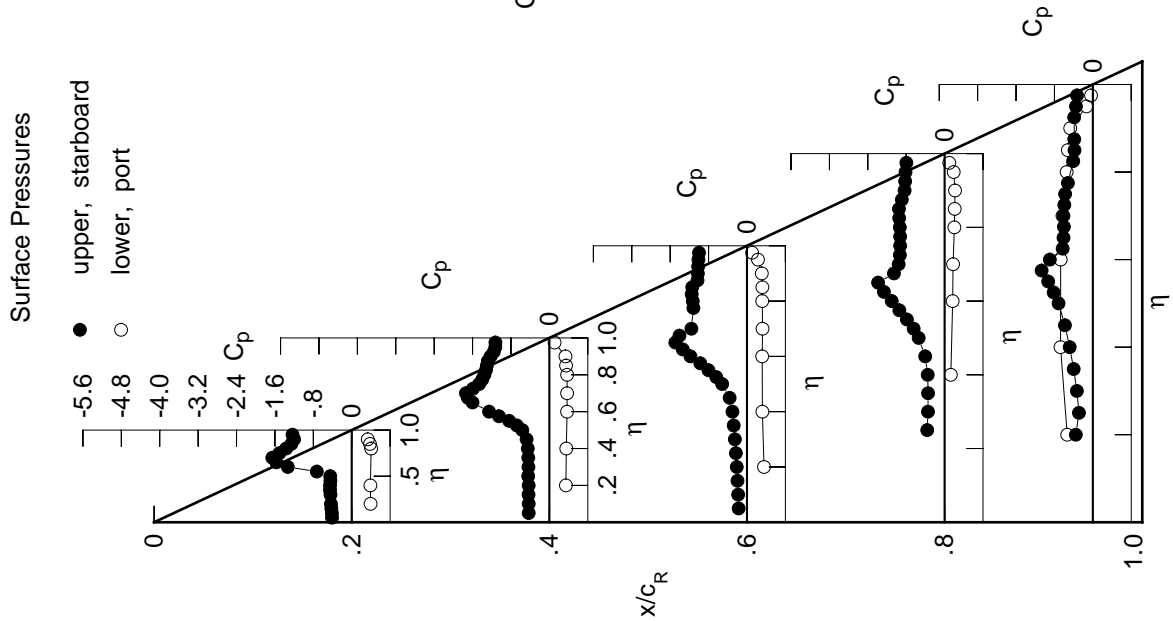

Table D3. Continued.

η	$x/c_R = .2$		$x/c_R = .4$		$x/c_R = .6$		$x/c_R = .8$		$x/c_R = .95$	
	$C_{p,u}$	$C_{p,l}$	$C_{p,u}$	$C_{p,l}$	$C_{p,u}$	$C_{p,l}$	$C_{p,u}$	$C_{p,l}$	$C_{p,u}$	$C_{p,l}$
0.050	-0.4482	-0.4790	-0.1966	*****	*****	*****	*****	*****	*****	*****
0.100	-0.4510	-0.4812	-0.2091	*****	*****	*****	*****	*****	*****	*****
0.150	-0.4604	-0.4811	-0.2230	*****	*****	*****	*****	*****	*****	*****
0.200	-0.4681	-0.4836	-0.2402	*****	*****	*****	*****	*****	*****	*****
0.250	*****	-0.4887	-0.2592	-0.3887	-0.3981	*****	*****	*****	*****	*****
0.300	-0.4727	-0.4873	-0.2846	-0.3738	-0.4228	*****	*****	*****	*****	*****
0.350	-0.4792	-0.4910	-0.3141	-0.3769	-0.4659	*****	*****	*****	*****	*****
0.400	-0.4718	-0.5107	-0.3631	-0.3931	-0.5377	*****	*****	*****	*****	*****
0.450	-0.4718	-0.5618	-0.4510	-0.4686	-0.6382	*****	*****	*****	*****	*****
0.500	-0.5701	-0.7003	-0.6541	-0.6296	-0.7833	*****	*****	*****	*****	*****
0.525	*****	-0.8471	-0.7969	-0.7456	-0.8840	*****	*****	*****	*****	*****
0.550	-1.0288	-1.0251	-0.9658	-0.8918	-0.9953	*****	*****	*****	*****	*****
0.575	*****	-1.2291	-1.1313	-1.0504	-1.0544	*****	*****	*****	*****	*****
0.600	-1.5172	-1.4044	-1.3111	-1.2037	-0.6493	*****	*****	*****	*****	*****
0.625	*****	*****	-1.4523	-1.3540	-0.6213	*****	*****	*****	*****	*****
0.650	-1.6553	-1.7071	-1.5691	-1.2886	-0.6218	*****	*****	*****	*****	*****
0.675	*****	-1.7563	-1.2697	-0.9979	-0.6215	*****	*****	*****	*****	*****
0.700	-1.6593	-1.5855	-1.1887	-0.9658	-0.6213	*****	*****	*****	*****	*****
0.725	*****	-1.4779	*****	-0.9564	-0.6020	*****	*****	*****	*****	*****
0.750	-1.5329	-1.4560	*****	-0.9585	-0.5739	*****	*****	*****	*****	*****
0.775	*****	-1.4656	-1.1728	-0.9619	-0.5016	*****	*****	*****	*****	*****
0.800	-1.3813	-1.4723	-1.1862	-0.9780	*****	*****	*****	*****	*****	*****
0.825	*****	-1.4454	-1.2131	-0.9921	-0.4045	*****	*****	*****	*****	*****
0.850	-1.2986	-1.3880	-1.1942	-0.9947	-0.3809	*****	*****	*****	*****	*****
0.875	*****	-1.3208	-1.0784	-0.9259	-0.4012	*****	*****	*****	*****	*****
0.900	-1.2479	-1.2564	-1.0636	-0.8474	*****	*****	*****	*****	*****	*****
0.925	*****	-1.2006	-1.0530	-0.8328	-0.4101	*****	*****	*****	*****	*****
0.950	-1.2833	-1.1765	-1.0462	-0.8246	-0.3705	*****	*****	*****	*****	*****
0.975	*****	-1.1747	-1.0340	-0.8055	-0.3477	*****	*****	*****	*****	*****

η	$x/c_R = .95$		$x/c_R = .8$		$x/c_R = .6$		$x/c_R = .4$		$x/c_R = .2$	
	$C_{p,u}$	$C_{p,l}$	$C_{p,u}$	$C_{p,l}$	$C_{p,u}$	$C_{p,l}$	$C_{p,u}$	$C_{p,l}$	$C_{p,u}$	$C_{p,l}$
-0.200	0.4201	0.3689	0.3708	*****	-0.5446	*****	*****	*****	*****	*****
-0.400	0.4161	0.3716	0.3357	0.1444	-0.6712	*****	*****	*****	*****	*****
-0.600	*****	0.3881	0.3342	0.1793	-0.6620	*****	*****	*****	*****	*****
-0.700	*****	0.3870	0.3380	0.1894	-0.6265	*****	*****	*****	*****	*****
-0.800	0.4211	0.3858	0.3329	0.2146	-0.5375	*****	*****	*****	*****	*****
-0.850	0.3905	0.3595	0.3328	0.2205	-0.5135	*****	*****	*****	*****	*****
-0.900	0.3390	0.3398	0.3155	0.2250	-0.4586	*****	*****	*****	*****	*****
-0.950	*****	*****	0.2240	0.1860	-0.1324	*****	*****	*****	*****	*****
-0.975	*****	0.0957	0.0933	0.0880	-0.0457	*****	*****	*****	*****	*****

Sharp Radius L.E.
 Run No. = 86 , Point No. = 1892
 $C_N = 0.872$, $C_m = -0.1284$
 $\alpha = 18.5^\circ$, $M_\infty = 0.799$
 $R_{mac} = 6.0 \times 10^6$

Surface Pressures Near Leading Edge

● / ◆ upper, starboard/port
 ○ / ◇ lower, starboard/port

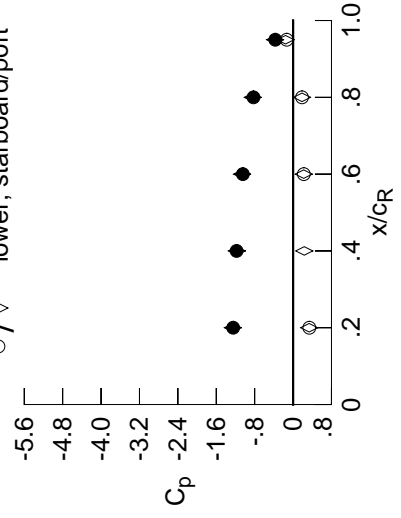

x/c_R	η	starb'd	port	starb'd	port
		$C_{p,u}$	$C_{p,l}$	$C_{p,u}$	$C_{p,l}$
0.20	0.90	-1.2479	-1.2545	0.3355	0.3390
0.40	0.95	-1.1765	-1.1717	0.2326	*****
0.60	0.95	-1.0462	-1.0629	0.2220	0.2240
0.80	0.95	-0.8246	-0.8401	0.1860	0.1860
0.95	0.95	-0.3705	-0.3752	-0.1565	-0.1324

Table D3. Continued.

η	$x/c_R = .2$		$x/c_R = .4$		$x/c_R = .6$		$x/c_R = .8$		$x/c_R = .95$	
	$C_{p,u}$	$C_{p,l}$	$C_{p,u}$	$C_{p,l}$	$C_{p,u}$	$C_{p,l}$	$C_{p,u}$	$C_{p,l}$	$C_{p,u}$	$C_{p,l}$
0.050	-0.4793	-0.5049	-0.2158	*****	*****	*****	*****	*****	*****	*****
0.100	-0.4831	-0.5063	-0.2324	*****	*****	*****	*****	*****	*****	*****
0.150	-0.4922	-0.5100	-0.2420	*****	*****	*****	*****	*****	*****	*****
0.200	-0.4971	-0.5081	-0.2638	*****	*****	*****	*****	*****	*****	*****
0.250	*****	-0.5151	-0.2808	-0.4155	-0.4554	*****	*****	*****	*****	*****
0.300	-0.5057	-0.5145	-0.3145	-0.3986	-0.4862	*****	*****	*****	*****	*****
0.350	-0.5107	-0.5271	-0.3520	-0.4104	-0.5339	*****	*****	*****	*****	*****
0.400	-0.5096	-0.5636	-0.4178	-0.4372	-0.6037	*****	*****	*****	*****	*****
0.450	-0.5507	-0.6520	-0.5425	-0.5333	-0.7101	*****	*****	*****	*****	*****
0.500	-0.7880	-0.8521	-0.7781	-0.7158	-0.8544	*****	*****	*****	*****	*****
0.525	*****	-1.0210	-0.9345	-0.8419	-0.9514	*****	*****	*****	*****	*****
0.550	-1.2815	-1.2033	-1.1002	-0.9872	-1.0280	*****	*****	*****	*****	*****
0.575	*****	-1.3843	-1.2599	-1.1402	-0.7375	*****	*****	*****	*****	*****
0.600	-1.6406	-1.5363	-1.4180	-1.2858	-0.6147	*****	*****	*****	*****	*****
0.625	*****	*****	-1.5453	-1.4224	-0.6131	*****	*****	*****	*****	*****
0.650	-1.7005	-1.7904	-1.5090	-1.0702	-0.6214	*****	*****	*****	*****	*****
0.675	*****	-1.6011	-1.2515	-0.9844	-0.6188	*****	*****	*****	*****	*****
0.700	-1.6245	-1.4785	-1.2251	-0.9683	-0.6153	*****	*****	*****	*****	*****
0.725	*****	-1.4527	*****	-0.9644	-0.5835	*****	*****	*****	*****	*****
0.750	-1.4761	-1.4576	*****	-0.9668	-0.5343	*****	*****	*****	*****	*****
0.775	*****	-1.4883	-1.2238	-0.9755	-0.4614	*****	*****	*****	*****	*****
0.800	-1.3967	-1.5172	-1.2425	-0.9988	*****	*****	*****	*****	*****	*****
0.825	*****	-1.5064	-1.2673	-1.0226	-0.4100	*****	*****	*****	*****	*****
0.850	-1.3408	-1.4426	-1.2423	-1.0172	-0.3977	*****	*****	*****	*****	*****
0.875	*****	-1.3604	-1.1259	-0.9398	-0.4243	*****	*****	*****	*****	*****
0.900	-1.2920	-1.2932	-1.1053	-0.8537	*****	*****	*****	*****	*****	*****
0.925	*****	-1.2486	-1.0894	-0.8338	-0.4300	*****	*****	*****	*****	*****
0.950	-1.3379	-1.2300	-1.0768	-0.8262	-0.3908	*****	*****	*****	*****	*****
0.975	*****	-1.2271	-1.0652	-0.8021	-0.3690	*****	*****	*****	*****	*****
-0.200	0.4481	0.3925	0.3877	*****	-0.5571	*****	*****	*****	*****	*****
-0.400	0.4432	0.3976	0.3580	0.1612	-0.6616	*****	*****	*****	*****	*****
-0.600	*****	0.4090	0.3552	0.1950	-0.6499	*****	*****	*****	*****	*****
-0.700	*****	0.4075	0.3571	0.2057	-0.6126	*****	*****	*****	*****	*****
-0.800	0.4380	0.4024	0.3489	0.2300	-0.5270	*****	*****	*****	*****	*****
-0.850	0.4021	0.3697	0.3472	0.2340	-0.4973	*****	*****	*****	*****	*****
-0.900	0.3456	0.3454	0.3222	0.2327	-0.4458	*****	*****	*****	*****	*****
-0.950	*****	*****	0.2190	0.1859	-0.1296	*****	*****	*****	*****	*****
-0.975	*****	0.0846	0.0803	0.0789	-0.0527	*****	*****	*****	*****	*****

Sharp Radius L.E.
 Run No. = 86 , Point No. = 1893
 $C_N = 0.928$, $C_m = -0.1371$
 $\alpha = 19.5^\circ$, $M_\infty = 0.799$
 $R_{mac} = 6.0 \times 10^6$

Surface Pressures Near Leading Edge

● / ◆ upper, starboard/port
 ○ / ◇ lower, starboard/port

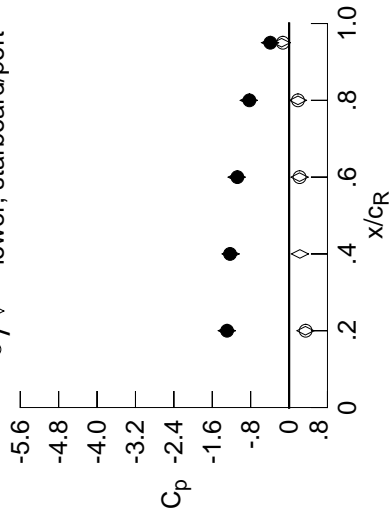

x/c_R	η	starb'd	port	$C_{p,u}$	starb'd	port	$C_{p,l}$
0.20	0.90	-1.2920	-1.2976	0.3408	0.3456	*****	*****
0.40	0.95	-1.2300	-1.2185	0.2260	*****	*****	*****
0.60	0.95	-1.0768	-1.0935	0.2180	0.2190	*****	*****
0.80	0.95	-0.8262	-0.8397	0.1858	0.1859	*****	*****
0.95	0.95	-0.3908	-0.3956	-0.1553	-0.1296	*****	*****

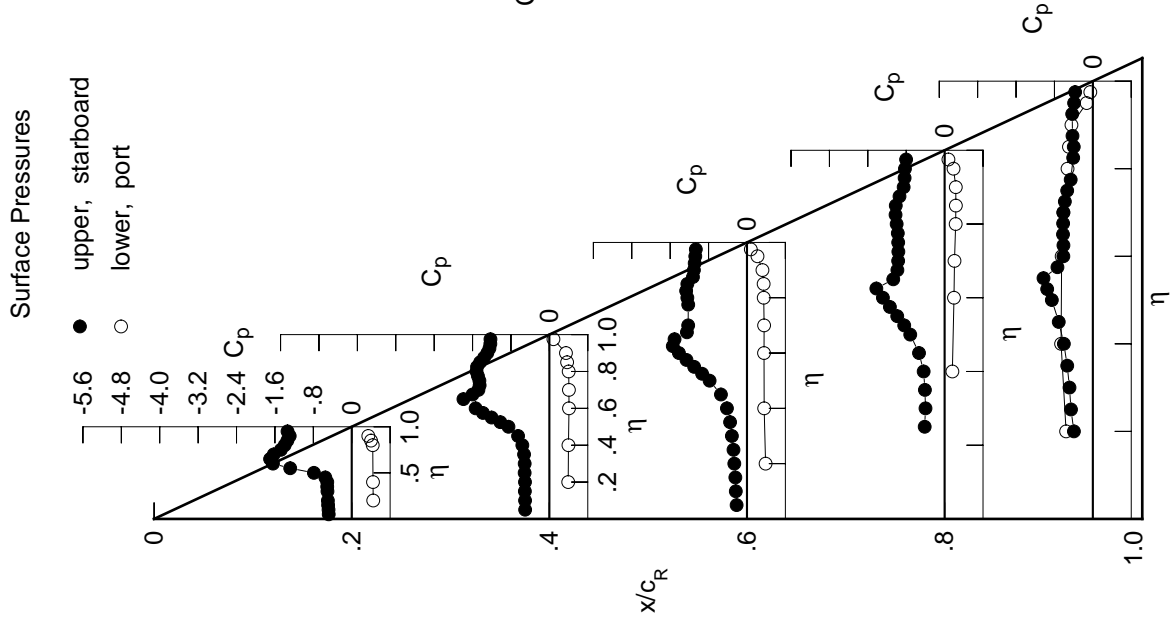

Table D3. Continued.

η	$x/c_R = .2$		$x/c_R = .4$		$x/c_R = .6$		$x/c_R = .8$		$x/c_R = .95$	
	$C_{p,u}$	$C_{p,u}$	$C_{p,u}$	$C_{p,u}$	$C_{p,u}$	$C_{p,u}$	$C_{p,u}$	$C_{p,u}$	$C_{p,u}$	$C_{p,u}$
0.050	-0.5192	-0.5296	-0.2299	*****	*****	*****	*****	*****	*****	*****
0.100	-0.5206	-0.5335	-0.2437	*****	*****	*****	*****	*****	*****	*****
0.150	-0.5295	-0.5325	-0.2551	*****	*****	*****	*****	*****	*****	*****
0.200	-0.5342	-0.5343	-0.2791	*****	*****	*****	*****	*****	*****	*****
0.250	*****	-0.5397	-0.2974	-0.4361	-0.4939	*****	*****	*****	*****	*****
0.300	-0.5407	-0.5455	-0.3355	-0.4254	-0.5408	*****	*****	*****	*****	*****
0.350	-0.5496	-0.5671	-0.3852	-0.4455	-0.5963	*****	*****	*****	*****	*****
0.400	-0.5698	-0.6296	-0.4783	-0.4885	-0.6719	*****	*****	*****	*****	*****
0.450	-0.6819	-0.7660	-0.6379	-0.6079	-0.7781	*****	*****	*****	*****	*****
0.500	-1.0200	-1.0247	-0.9151	-0.8128	-0.9111	*****	*****	*****	*****	*****
0.525	*****	-1.2037	-1.0777	-0.9427	-0.9892	*****	*****	*****	*****	*****
0.550	-1.4574	-1.3717	-1.2438	-1.0823	-0.9518	*****	*****	*****	*****	*****
0.575	*****	-1.5297	-1.3860	-1.2260	-0.6206	*****	*****	*****	*****	*****
0.600	-1.6855	-1.6501	-1.5267	-1.3595	-0.5903	*****	*****	*****	*****	*****
0.625	*****	*****	-1.6319	-1.3505	-0.5887	*****	*****	*****	*****	*****
0.650	-1.6604	-1.7026	-1.3568	-1.0007	-0.5945	*****	*****	*****	*****	*****
0.675	*****	-1.4769	-1.2801	-0.9699	-0.5861	*****	*****	*****	*****	*****
0.700	-1.5359	-1.4506	-1.2665	-0.9621	-0.5727	*****	*****	*****	*****	*****
0.725	*****	-1.4381	*****	-0.9588	-0.5327	*****	*****	*****	*****	*****
0.750	-1.4825	-1.4496	*****	-0.9689	-0.4966	*****	*****	*****	*****	*****
0.775	*****	-1.4805	-1.2729	-0.9753	-0.4605	*****	*****	*****	*****	*****
0.800	-1.4523	-1.5098	-1.2990	-1.0075	*****	*****	*****	*****	*****	*****
0.825	*****	-1.5014	-1.3386	-1.0305	-0.4518	*****	*****	*****	*****	*****
0.850	-1.3840	-1.4430	-1.3076	-1.0232	-0.4256	*****	*****	*****	*****	*****
0.875	*****	-1.3724	-1.1727	-0.9370	-0.4518	*****	*****	*****	*****	*****
0.900	-1.3412	-1.3340	-1.1455	-0.8496	*****	*****	*****	*****	*****	*****
0.925	*****	-1.3105	-1.1245	-0.8345	-0.4544	*****	*****	*****	*****	*****
0.950	-1.3975	-1.2976	-1.1162	-0.8292	-0.4130	*****	*****	*****	*****	*****
0.975	*****	-1.2982	-1.1035	-0.8039	-0.3906	*****	*****	*****	*****	*****

η	$x/c_R = .2$		$x/c_R = .4$		$x/c_R = .6$		$x/c_R = .8$		$x/c_R = .95$	
	$C_{p,l}$	$C_{p,l}$	$C_{p,l}$	$C_{p,l}$	$C_{p,l}$	$C_{p,l}$	$C_{p,l}$	$C_{p,l}$	$C_{p,l}$	$C_{p,l}$
-0.200	0.4785	0.4153	0.4026	*****	-0.5669	*****	*****	*****	*****	*****
-0.400	0.4708	0.4233	0.3784	0.1779	-0.6535	*****	*****	*****	*****	*****
-0.600	*****	0.4353	0.3728	0.2102	-0.6412	*****	*****	*****	*****	*****
-0.700	*****	0.4294	0.3762	0.2210	-0.6037	*****	*****	*****	*****	*****
-0.800	0.4535	0.4189	0.3636	0.2414	-0.5149	*****	*****	*****	*****	*****
-0.850	0.4132	0.3806	0.3565	0.2459	-0.4909	*****	*****	*****	*****	*****
-0.900	0.3510	0.3502	0.3235	0.2410	-0.4334	*****	*****	*****	*****	*****
-0.950	*****	*****	0.2104	0.1839	-0.1282	*****	*****	*****	*****	*****
-0.975	*****	0.0716	0.0659	0.0710	-0.0626	*****	*****	*****	*****	*****

Sharp Radius L.E.
 Run No. = 86 , Point No. = 1894
 $C_N = 0.980$, $C_m = -0.1457$
 $\alpha = 20.6^\circ$, $M_\infty = 0.799$
 $R_{mac} = 6.0 \times 10^6$

Surface Pressures Near Leading Edge

● / ◆ upper, starboard/port
 ○ / ◇ lower, starboard/port

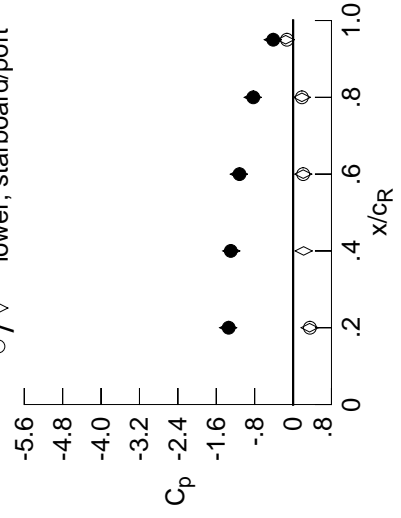

x/c_R	η	starb'd	port	$C_{p,u}$	starb'd	port	$C_{p,l}$
0.20	0.90	-1.3412	-1.3530	0.3442	0.3510	*****	*****
0.40	0.95	-1.2976	-1.2882	0.2203	*****	*****	*****
0.60	0.95	-1.1162	-1.1304	0.2114	0.2104	*****	*****
0.80	0.95	-0.8292	-0.8405	0.1838	0.1839	*****	*****
0.95	0.95	-0.4130	-0.4234	-0.1538	-0.1282	*****	*****

Table D3. Continued.

η	$x/c_R = .2$		$x/c_R = .4$		$x/c_R = .6$		$x/c_R = .8$		$x/c_R = .95$	
	$C_{p,u}$	$C_{p,u}$	$C_{p,u}$	$C_{p,u}$	$C_{p,u}$	$C_{p,u}$	$C_{p,u}$	$C_{p,u}$	$C_{p,u}$	$C_{p,u}$
0.050	-0.5610	-0.5707	-0.2412	*****	*****	*****	*****	*****	*****	*****
0.100	-0.5629	-0.5738	-0.2516	*****	*****	*****	*****	*****	*****	*****
0.150	-0.5780	-0.5745	-0.2686	*****	*****	*****	*****	*****	*****	*****
0.200	-0.5766	-0.5745	-0.2876	*****	*****	*****	*****	*****	*****	*****
0.250	*****	-0.5818	-0.3172	-0.4693	-0.5206	*****	*****	*****	*****	*****
0.300	-0.5862	-0.5964	-0.3582	-0.4638	-0.5847	*****	*****	*****	*****	*****
0.350	-0.6050	-0.6267	-0.4249	-0.4995	-0.6457	*****	*****	*****	*****	*****
0.400	-0.6576	-0.7259	-0.5410	-0.5631	-0.7252	*****	*****	*****	*****	*****
0.450	-0.8380	-0.9119	-0.7412	-0.6984	-0.8169	*****	*****	*****	*****	*****
0.500	-1.2092	-1.2064	-1.0358	-0.9179	-0.9139	*****	*****	*****	*****	*****
0.525	*****	-1.3713	-1.1942	-1.0370	-0.9664	*****	*****	*****	*****	*****
0.550	-1.5785	-1.5162	-1.3442	-1.1761	-0.7760	*****	*****	*****	*****	*****
0.575	*****	-1.6386	-1.4721	-1.3013	-0.6158	*****	*****	*****	*****	*****
0.600	-1.6257	-1.7277	-1.5965	-1.4243	-0.6045	*****	*****	*****	*****	*****
0.625	*****	*****	-1.6278	-1.1382	-0.5977	*****	*****	*****	*****	*****
0.650	-1.6022	-1.5847	-1.3175	-0.9951	-0.5964	*****	*****	*****	*****	*****
0.675	*****	-1.4858	-1.2843	-0.9772	-0.5795	*****	*****	*****	*****	*****
0.700	-1.5309	-1.4702	-1.2791	-0.9787	-0.5556	*****	*****	*****	*****	*****
0.725	*****	-1.4641	*****	-0.9715	-0.5243	*****	*****	*****	*****	*****
0.750	-1.5509	-1.4750	*****	-0.9834	-0.5025	*****	*****	*****	*****	*****
0.775	*****	-1.5112	-1.3121	-0.9912	-0.4869	*****	*****	*****	*****	*****
0.800	-1.5241	-1.5393	-1.3594	-1.0306	*****	*****	*****	*****	*****	*****
0.825	*****	-1.5225	-1.4119	-1.0520	-0.4885	*****	*****	*****	*****	*****
0.850	-1.4225	-1.4662	-1.3677	-1.0506	-0.4550	*****	*****	*****	*****	*****
0.875	*****	-1.4112	-1.2120	-0.9567	-0.4788	*****	*****	*****	*****	*****
0.900	-1.3820	-1.3844	-1.1942	-0.8603	*****	*****	*****	*****	*****	*****
0.925	*****	-1.3738	-1.1771	-0.8379	-0.4790	*****	*****	*****	*****	*****
0.950	-1.4451	-1.3602	-1.1631	-0.8306	-0.4383	*****	*****	*****	*****	*****
0.975	*****	-1.3677	-1.1436	-0.8072	-0.4163	*****	*****	*****	*****	*****
-0.200	0.5062	0.4370	0.4229	*****	-0.5691	*****	*****	*****	*****	*****
-0.400	0.4985	0.4465	0.3948	0.1910	-0.6423	*****	*****	*****	*****	*****
-0.600	*****	0.4529	0.3884	0.2273	-0.6294	*****	*****	*****	*****	*****
-0.700	*****	0.4482	0.3934	0.2334	-0.5931	*****	*****	*****	*****	*****
-0.800	0.4668	0.4354	0.3751	0.2554	-0.5045	*****	*****	*****	*****	*****
-0.850	0.4236	0.3888	0.3649	0.2572	-0.4808	*****	*****	*****	*****	*****
-0.900	0.3548	0.3545	0.3277	0.2489	-0.4217	*****	*****	*****	*****	*****
-0.950	*****	*****	0.2035	0.1819	-0.1295	*****	*****	*****	*****	*****
-0.975	*****	0.0580	0.0512	0.0629	-0.0734	*****	*****	*****	*****	*****

Sharp Radius L.E.
 Run No. = 86 , Point No. = 1895
 $C_N = 1.033$, $C_m = -0.1533$
 $\alpha = 21.6^\circ$, $M_\infty = 0.799$
 $R_{mac} = 6.0 \times 10^6$

Surface Pressures Near Leading Edge

● / ◆ upper, starboard/port
 ○ / ◇ lower, starboard/port

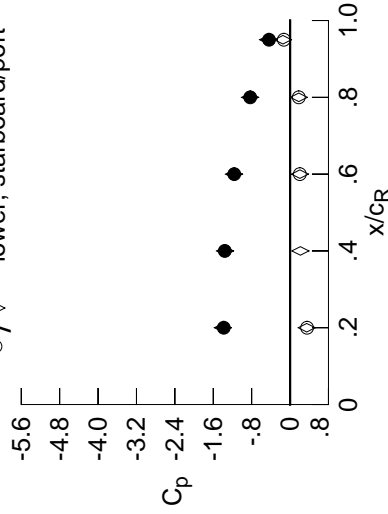

x/c_R	η	starb'd	port	starb'd	port
		$C_{p,u}$	$C_{p,u}$	$C_{p,l}$	$C_{p,l}$
0.20	0.90	-1.3820	-1.4001	0.3473	0.3548
0.40	0.95	-1.3602	-1.3544	0.2143	*****
0.60	0.95	-1.1631	-1.1671	0.2051	0.2035
0.80	0.95	-0.8306	-0.8320	0.1816	0.1819
0.95	0.95	-0.4383	-0.4568	-0.1484	-0.1295

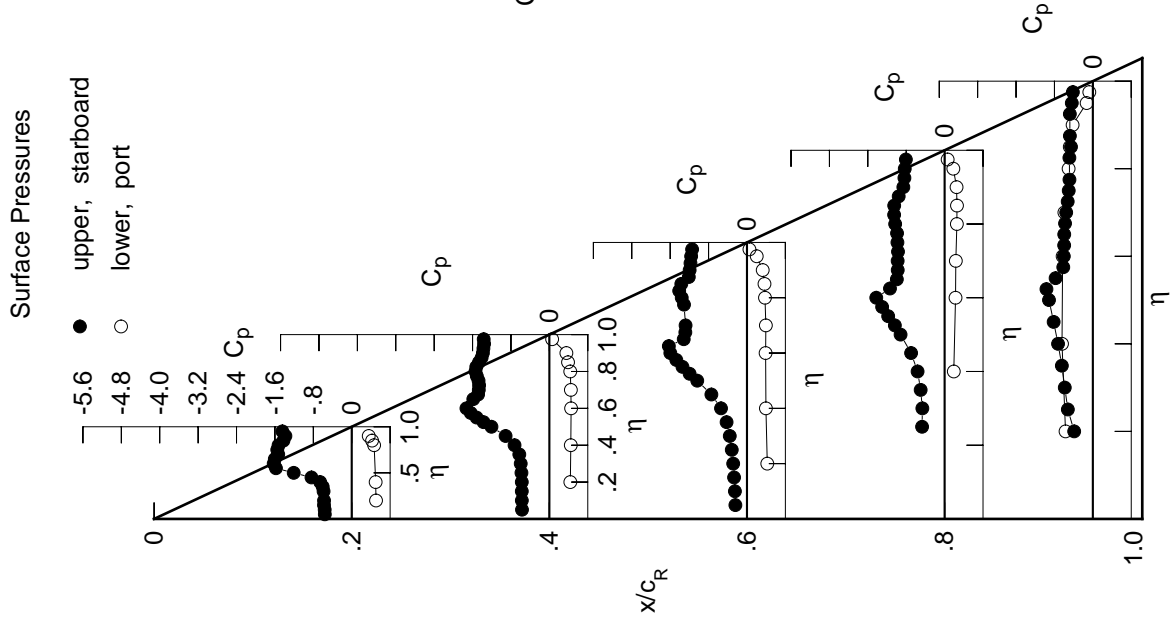

Table D3. Continued.

η	$x/c_R = .2$		$x/c_R = .4$		$x/c_R = .6$		$x/c_R = .8$		$x/c_R = .95$	
	$C_{p,u}$	$C_{p,l}$	$C_{p,u}$	$C_{p,l}$	$C_{p,u}$	$C_{p,l}$	$C_{p,u}$	$C_{p,l}$	$C_{p,u}$	$C_{p,l}$
0.050	-0.6005	-0.6168	-0.2641	*****	*****	*****	*****	*****	*****	*****
0.100	-0.6025	-0.6164	-0.2757	*****	*****	*****	*****	*****	*****	*****
0.150	-0.6153	-0.6224	-0.2955	*****	*****	*****	*****	*****	*****	*****
0.200	-0.6190	-0.6260	-0.3211	*****	*****	*****	*****	*****	*****	*****
0.250	*****	-0.6366	-0.3572	-0.5006	-0.5419	*****	*****	*****	*****	*****
0.300	-0.6327	-0.6594	-0.4155	-0.4966	-0.6326	*****	*****	*****	*****	*****
0.350	-0.6735	-0.7120	-0.5043	-0.5352	-0.6959	*****	*****	*****	*****	*****
0.400	-0.7643	-0.8424	-0.6578	-0.6126	-0.7863	*****	*****	*****	*****	*****
0.450	-0.9924	-1.0660	-0.8812	-0.7660	-0.8841	*****	*****	*****	*****	*****
0.500	-1.3518	-1.3454	-1.1706	-0.9879	-0.9766	*****	*****	*****	*****	*****
0.525	*****	-1.4892	-1.3128	-1.1103	-1.0058	*****	*****	*****	*****	*****
0.550	-1.6530	-1.6060	-1.4495	-1.2365	-0.7076	*****	*****	*****	*****	*****
0.575	*****	-1.7094	-1.5583	-1.3598	-0.6409	*****	*****	*****	*****	*****
0.600	-1.6081	-1.7794	-1.6645	-1.4664	-0.6221	*****	*****	*****	*****	*****
0.625	*****	*****	-1.5810	-1.0755	-0.6140	*****	*****	*****	*****	*****
0.650	-1.6007	-1.5917	-1.3587	-0.9990	-0.6018	*****	*****	*****	*****	*****
0.675	*****	-1.5268	-1.3359	-0.9808	-0.5795	*****	*****	*****	*****	*****
0.700	-1.5853	-1.5093	-1.3323	-0.9808	-0.5611	*****	*****	*****	*****	*****
0.725	*****	-1.5005	*****	-0.9774	-0.5430	*****	*****	*****	*****	*****
0.750	-1.6162	-1.5093	*****	-0.9827	-0.5301	*****	*****	*****	*****	*****
0.775	*****	-1.5485	-1.3543	-1.0043	-0.5206	*****	*****	*****	*****	*****
0.800	-1.5874	-1.5821	-1.3920	-1.0527	*****	*****	*****	*****	*****	*****
0.825	*****	-1.5641	-1.4350	-1.0810	-0.5185	*****	*****	*****	*****	*****
0.850	-1.4620	-1.5042	-1.3824	-1.0879	-0.4847	*****	*****	*****	*****	*****
0.875	*****	-1.4479	-1.2241	-0.9906	-0.5041	*****	*****	*****	*****	*****
0.900	-1.4262	-1.4296	-1.2238	-0.8716	*****	*****	*****	*****	*****	*****
0.925	*****	-1.4217	-1.2340	-0.8414	-0.4966	*****	*****	*****	*****	*****
0.950	-1.4843	-1.4144	-1.2352	-0.8340	-0.4586	*****	*****	*****	*****	*****
0.975	*****	-1.4221	-1.2081	-0.8057	-0.4299	*****	*****	*****	*****	*****

η	$x/c_R = .2$		$x/c_R = .4$		$x/c_R = .6$		$x/c_R = .8$		$x/c_R = .95$	
	$C_{p,u}$	$C_{p,l}$	$C_{p,u}$	$C_{p,l}$	$C_{p,u}$	$C_{p,l}$	$C_{p,u}$	$C_{p,l}$	$C_{p,u}$	$C_{p,l}$
-0.200	0.5331	0.4650	0.4419	*****	*****	*****	*****	*****	*****	*****
-0.400	0.5259	0.4687	0.4129	0.2093	0.6349	*****	*****	*****	*****	*****
-0.600	*****	0.4765	0.4073	0.2413	0.6137	*****	*****	*****	*****	*****
-0.700	*****	0.4699	0.4090	0.2500	0.5790	*****	*****	*****	*****	*****
-0.800	0.4825	0.4500	0.3911	0.2679	0.4899	*****	*****	*****	*****	*****
-0.850	0.4339	0.3991	0.3757	0.2683	0.4673	*****	*****	*****	*****	*****
-0.900	0.3591	0.3587	0.3318	0.2556	0.4069	*****	*****	*****	*****	*****
-0.950	*****	*****	0.1970	0.1800	-0.1240	*****	*****	*****	*****	*****
-0.975	*****	0.0418	0.0378	0.0545	-0.0759	*****	*****	*****	*****	*****

Sharp Radius L.E.
 Run No. = 86 , Point No. = 1896
 $C_N = 1.087$, $C_m = -0.1621$
 $\alpha = 22.6^\circ$, $M_\infty = 0.799$
 $R_{mac} = 6.0 \times 10^6$

Surface Pressures Near Leading Edge

● / ◆ upper, starboard/port
 ○ / ◇ lower, starboard/port

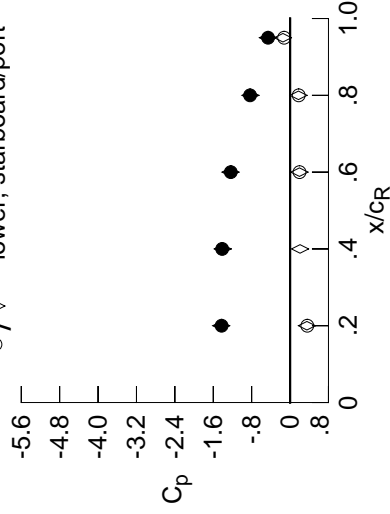

x/c_R	η	starb'd	port	starb'd	port
		$C_{p,u}$	$C_{p,l}$	$C_{p,u}$	$C_{p,l}$
0.20	0.90	-1.4262	-1.4348	0.3514	0.3591
0.40	0.95	-1.4144	-1.4034	0.2076	*****
0.60	0.95	-1.2352	-1.2425	0.1956	0.1970
0.80	0.95	-0.8340	-0.8267	0.1755	0.1800
0.95	0.95	-0.4586	-0.4627	-0.1485	-0.1240

Table D3. Continued.

η	$x/c_R = .2$		$x/c_R = .4$		$x/c_R = .6$		$x/c_R = .8$		$x/c_R = .95$	
	$C_{p,u}$	$C_{p,l}$	$C_{p,u}$	$C_{p,l}$	$C_{p,u}$	$C_{p,l}$	$C_{p,u}$	$C_{p,l}$	$C_{p,u}$	$C_{p,l}$
0.050	-0.6368	-0.6516	-0.3160	*****	*****	*****	*****	*****	*****	*****
0.100	-0.6405	-0.6542	-0.3290	*****	*****	*****	*****	*****	*****	*****
0.150	-0.6554	-0.6599	-0.3548	*****	*****	*****	*****	*****	*****	*****
0.200	-0.6583	-0.6680	-0.3881	*****	*****	*****	*****	*****	*****	*****
0.250	*****	-0.6876	-0.4306	-0.6403	-0.5419	*****	*****	*****	*****	*****
0.300	-0.6864	-0.7245	-0.5042	-0.6319	-0.6492	*****	*****	*****	*****	*****
0.350	-0.7479	-0.7972	-0.6118	-0.6594	-0.7260	*****	*****	*****	*****	*****
0.400	-0.8766	-0.9536	-0.7806	-0.7268	-0.8259	*****	*****	*****	*****	*****
0.450	-1.1322	-1.1865	-1.0138	-0.8623	-0.9384	*****	*****	*****	*****	*****
0.500	-1.4662	-1.4417	-1.2852	-1.0681	-1.0413	*****	*****	*****	*****	*****
0.525	*****	-1.5681	-1.4136	-1.1764	-0.9995	*****	*****	*****	*****	*****
0.550	-1.6846	-1.6701	-1.5336	-1.2956	-0.6962	*****	*****	*****	*****	*****
0.575	*****	-1.7591	-1.6319	-1.4089	-0.6543	*****	*****	*****	*****	*****
0.600	-1.6306	-1.8172	-1.7247	-1.3867	-0.6344	*****	*****	*****	*****	*****
0.625	*****	*****	-1.5853	-1.0532	-0.6228	*****	*****	*****	*****	*****
0.650	-1.6221	-1.5994	-1.4262	-1.0128	-0.6069	*****	*****	*****	*****	*****
0.675	*****	-1.5761	-1.4121	-0.9894	-0.5781	*****	*****	*****	*****	*****
0.700	-1.6251	-1.5512	-1.4118	-0.9852	-0.5695	*****	*****	*****	*****	*****
0.725	*****	-1.5400	*****	-0.9792	-0.5553	*****	*****	*****	*****	*****
0.750	-1.6788	-1.5480	*****	-0.9763	-0.5593	*****	*****	*****	*****	*****
0.775	*****	-1.5839	-1.4190	-1.0042	-0.5500	*****	*****	*****	*****	*****
0.800	-1.6345	-1.6216	-1.4551	-1.0595	*****	*****	*****	*****	*****	*****
0.825	*****	-1.6059	-1.5044	-1.0935	-0.5370	*****	*****	*****	*****	*****
0.850	-1.5053	-1.5427	-1.4705	-1.1108	-0.5046	*****	*****	*****	*****	*****
0.875	*****	-1.4894	-1.3018	-1.0147	-0.5029	*****	*****	*****	*****	*****
0.900	-1.4699	-1.4732	-1.2965	-0.8858	*****	*****	*****	*****	*****	*****
0.925	*****	-1.4682	-1.2981	-0.8459	-0.4787	*****	*****	*****	*****	*****
0.950	-1.5287	-1.4651	-1.3046	-0.8382	-0.4518	*****	*****	*****	*****	*****
0.975	*****	-1.4759	-1.2950	-0.8112	-0.4291	*****	*****	*****	*****	*****
-0.200	$C_{p,l}$	0.4877	0.4585	*****	*****	*****	*****	*****	*****	*****
-0.400	0.5534	0.4933	0.4348	0.2214	-0.6186	*****	*****	*****	*****	*****
-0.600	*****	0.4984	0.4233	0.2578	-0.6050	*****	*****	*****	*****	*****
-0.700	*****	0.4890	0.4275	0.2619	-0.5664	*****	*****	*****	*****	*****
-0.800	0.4952	0.4647	0.4060	0.2818	-0.4786	*****	*****	*****	*****	*****
-0.850	0.4427	0.4087	0.3863	0.2792	-0.4549	*****	*****	*****	*****	*****
-0.900	0.3641	0.3623	0.3345	0.2614	-0.3921	*****	*****	*****	*****	*****
-0.950	*****	*****	0.1886	0.1759	-0.1188	*****	*****	*****	*****	*****
-0.975	*****	0.0411	0.0222	0.0447	-0.0777	*****	*****	*****	*****	*****

Sharp Radius L.E.
 Run No. = 86 , Point No. = 1897
 $C_N = 1.143$, $C_m = -0.1728$
 $\alpha = 23.6^\circ$, $M_\infty = 0.799$
 $R_{mac} = 6.0 \times 10^6$

Surface Pressures Near Leading Edge

● / ◆ upper, starboard/port
 ○ / ◇ lower, starboard/port

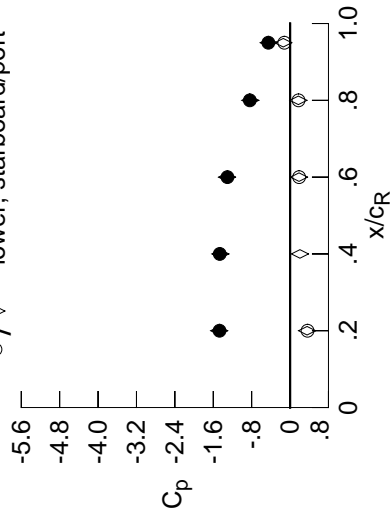

x/c_R	η	starb'd	port	$C_{p,u}$	starb'd	port	$C_{p,l}$
0.20	0.90	-1.4699	-1.4766	0.3545	0.3641	0.2059	*****
0.40	0.95	-1.4651	-1.4525	0.1861	0.1886	0.1728	0.1759
0.60	0.95	-1.3046	-1.3134	-0.4453	-0.4426	-0.1426	-0.1188
0.80	0.95	-0.8382	-0.8292	0.1728	0.1759	0.1426	0.1188
0.95	0.95	-0.4518	-0.4453	-0.1426	-0.1188	0.1426	0.1188

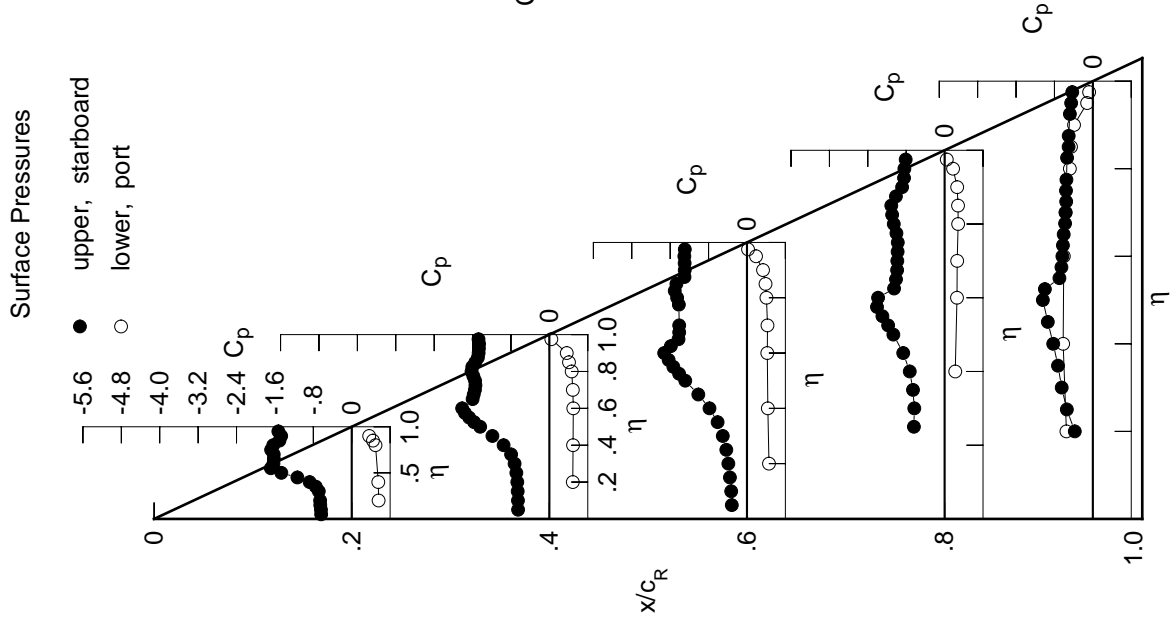

Table D3. Continued.

η	$x/c_R = .2$		$x/c_R = .4$		$x/c_R = .6$		$x/c_R = .8$		$x/c_R = .95$	
	$C_{p,u}$	$C_{p,l}$	$C_{p,u}$	$C_{p,l}$	$C_{p,u}$	$C_{p,l}$	$C_{p,u}$	$C_{p,l}$	$C_{p,u}$	$C_{p,l}$
0.050	-0.6687	-0.6674	-0.1436	*****	*****	*****	*****	*****	*****	*****
0.100	-0.6753	-0.6747	-0.1705	*****	*****	*****	*****	*****	*****	*****
0.150	-0.6878	-0.6799	-0.1988	*****	*****	*****	*****	*****	*****	*****
0.200	-0.6996	-0.6929	-0.2414	*****	*****	*****	*****	*****	*****	*****
0.250	*****	-0.7206	-0.2914	-0.7702	-0.5668	*****	*****	*****	*****	*****
0.300	-0.7431	-0.7678	-0.3780	-0.7818	-0.6795	*****	*****	*****	*****	*****
0.350	-0.8244	-0.8588	-0.4902	-0.8304	-0.7554	*****	*****	*****	*****	*****
0.400	-0.9772	-1.0226	-0.6698	-0.8996	-0.8507	*****	*****	*****	*****	*****
0.450	-1.2394	-1.2449	-0.8964	-1.0254	-0.9518	*****	*****	*****	*****	*****
0.500	-1.5438	-1.4756	-1.1773	-1.1901	-1.0351	*****	*****	*****	*****	*****
0.525	*****	-1.5936	-1.3092	-1.2825	-1.0623	*****	*****	*****	*****	*****
0.550	-1.7834	-1.6865	-1.4335	-1.3740	-0.9414	*****	*****	*****	*****	*****
0.575	*****	-1.7737	-1.5368	-1.4708	-0.7070	*****	*****	*****	*****	*****
0.600	-1.7089	-1.8252	-1.6390	-1.5508	-0.6115	*****	*****	*****	*****	*****
0.625	*****	*****	-1.6986	-1.2008	-0.5943	*****	*****	*****	*****	*****
0.650	-1.6626	-1.6043	-1.4390	-1.1267	-0.6133	*****	*****	*****	*****	*****
0.675	*****	-1.5923	-1.3655	-1.1124	-0.6202	*****	*****	*****	*****	*****
0.700	-1.6323	-1.5683	-1.3451	-1.1077	-0.6168	*****	*****	*****	*****	*****
0.725	*****	-1.5591	*****	-1.0954	-0.6038	*****	*****	*****	*****	*****
0.750	-1.6317	-1.5647	*****	-1.0943	-0.5979	*****	*****	*****	*****	*****
0.775	*****	-1.5929	-1.3260	-1.1046	-0.5796	*****	*****	*****	*****	*****
0.800	-1.6072	-1.6345	-1.3330	-1.1372	*****	*****	*****	*****	*****	*****
0.825	*****	-1.6221	-1.3692	-1.1566	-0.5658	*****	*****	*****	*****	*****
0.850	-1.5269	-1.5540	-1.3862	-1.1447	-0.5314	*****	*****	*****	*****	*****
0.875	*****	-1.4996	-1.2516	-1.0456	-0.5500	*****	*****	*****	*****	*****
0.900	-1.4940	-1.4915	-1.2043	-0.9481	*****	*****	*****	*****	*****	*****
0.925	*****	-1.4925	-1.1525	-0.9425	-0.5308	*****	*****	*****	*****	*****
0.950	-1.5453	-1.4947	-1.1352	-0.9488	-0.4830	*****	*****	*****	*****	*****
0.975	*****	-1.4997	-1.1258	-0.9151	-0.4502	*****	*****	*****	*****	*****

η	$x/c_R = .2$		$x/c_R = .4$		$x/c_R = .6$		$x/c_R = .8$		$x/c_R = .95$	
	$C_{p,u}$	$C_{p,l}$	$C_{p,u}$	$C_{p,l}$	$C_{p,u}$	$C_{p,l}$	$C_{p,u}$	$C_{p,l}$	$C_{p,u}$	$C_{p,l}$
-0.200	0.5857	0.5106	0.4782	*****	*****	*****	*****	*****	*****	*****
-0.400	0.5787	0.5160	0.4510	0.2337	-0.6364	*****	*****	*****	*****	*****
-0.600	*****	0.5199	0.4461	0.2613	-0.6158	*****	*****	*****	*****	*****
-0.700	*****	0.5095	0.4476	0.2684	-0.5810	*****	*****	*****	*****	*****
-0.800	0.5091	0.4806	0.4301	0.2821	-0.4916	*****	*****	*****	*****	*****
-0.850	0.4524	0.4199	0.4135	0.2802	-0.4715	*****	*****	*****	*****	*****
-0.900	0.3684	0.3680	0.3663	0.2616	-0.4110	*****	*****	*****	*****	*****
-0.950	*****	*****	0.2349	0.1805	-0.1423	*****	*****	*****	*****	*****
-0.975	*****	0.0277	0.0885	0.0527	-0.1077	*****	*****	*****	*****	*****

Sharp Radius L.E.
 Run No. = 86 , Point No. = 1898
 $C_N = 1.143$, $C_m = -0.1812$
 $\alpha = 24.6^\circ$, $M_\infty = 0.800$
 $R_{mac} = 6.0 \times 10^6$

Surface Pressures Near Leading Edge

● / ◆ upper, starboard/port
 ○ / ◇ lower, starboard/port

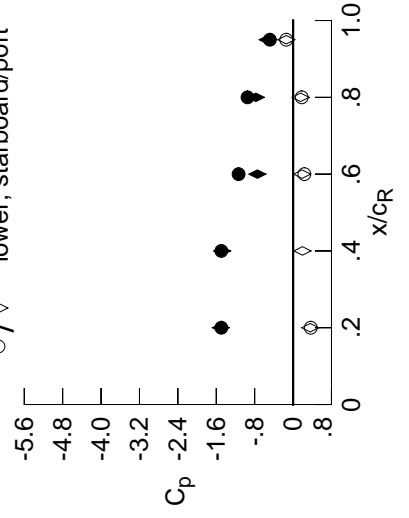

x/c_R	η	starb'd	port	starb'd	port
		$C_{p,u}$	$C_{p,l}$	$C_{p,u}$	$C_{p,l}$
0.20	0.90	-1.4940	-1.5061	0.3567	0.3684
0.40	0.95	-1.4947	-1.4773	0.1955	*****
0.60	0.95	-1.1352	-0.7429	0.1882	0.2349
0.80	0.95	-0.9488	-0.7750	0.1562	0.1805
0.95	0.95	-0.4830	-0.5311	-0.1419	-0.1423

Table D3. Continued.

η	$x/c_R = .2$		$x/c_R = .4$		$x/c_R = .6$		$x/c_R = .8$		$x/c_R = .95$	
	$C_{p,u}$	$C_{p,l}$	$C_{p,u}$	$C_{p,l}$	$C_{p,u}$	$C_{p,l}$	$C_{p,u}$	$C_{p,l}$	$C_{p,u}$	$C_{p,l}$
0.050	-0.7075	-0.7061	-0.1741	*****	*****	*****	*****	*****	*****	*****
0.100	-0.7136	-0.7124	-0.2074	*****	*****	*****	*****	*****	*****	*****
0.150	-0.7303	-0.7255	-0.2348	*****	*****	*****	*****	*****	*****	*****
0.200	-0.7482	-0.7357	-0.2841	*****	*****	*****	*****	*****	*****	*****
0.250	*****	-0.7728	-0.3402	-0.8108	-0.5566	*****	*****	*****	*****	*****
0.300	-0.8116	-0.8296	-0.4388	-0.8197	-0.6745	*****	*****	*****	*****	*****
0.350	-0.9140	-0.9373	-0.5630	-0.8727	-0.7633	*****	*****	*****	*****	*****
0.400	-1.0838	-1.1161	-0.7447	-0.9457	-0.8687	*****	*****	*****	*****	*****
0.450	-1.3432	-1.3393	-0.9707	-1.0735	-0.9821	*****	*****	*****	*****	*****
0.500	-1.6183	-1.5512	-1.2366	-1.2388	-1.0618	*****	*****	*****	*****	*****
0.525	*****	-1.6564	-1.3615	-1.3267	-1.0562	*****	*****	*****	*****	*****
0.550	-1.8240	-1.7409	-1.4733	-1.4197	-0.8874	*****	*****	*****	*****	*****
0.575	*****	-1.8138	-1.5739	-1.5089	-0.6977	*****	*****	*****	*****	*****
0.600	-1.6892	-1.8561	-1.6667	-1.5311	-0.6223	*****	*****	*****	*****	*****
0.625	*****	-1.7224	-1.1871	-0.6070	*****	*****	*****	*****	*****	*****
0.650	-1.6762	-1.6456	-1.5073	-1.1292	-0.6147	*****	*****	*****	*****	*****
0.675	*****	-1.6382	-1.4115	-1.1180	-0.6146	*****	*****	*****	*****	*****
0.700	-1.6772	-1.6124	-1.3913	-1.1091	-0.6194	*****	*****	*****	*****	*****
0.725	*****	-1.6048	*****	-1.0967	-0.6131	*****	*****	*****	*****	*****
0.750	-1.7223	-1.6115	*****	-1.0951	-0.6154	*****	*****	*****	*****	*****
0.775	*****	-1.6440	-1.3613	-1.1001	-0.6082	*****	*****	*****	*****	*****
0.800	-1.6762	-1.6901	-1.3604	-1.1316	*****	*****	*****	*****	*****	*****
0.825	*****	-1.6774	-1.3866	-1.1513	-0.6008	*****	*****	*****	*****	*****
0.850	-1.5767	-1.6082	-1.4136	-1.1421	-0.5701	*****	*****	*****	*****	*****
0.875	*****	-1.5482	-1.2856	-1.0424	-0.5785	*****	*****	*****	*****	*****
0.900	-1.5462	-1.5350	-1.2364	-0.9339	*****	*****	*****	*****	*****	*****
0.925	*****	-1.5344	-1.1891	-0.9187	-0.5513	*****	*****	*****	*****	*****
0.950	-1.5930	-1.5339	-1.1701	-0.9176	-0.5093	*****	*****	*****	*****	*****
0.975	*****	-1.5416	-1.1620	-0.8794	-0.4759	*****	*****	*****	*****	*****
-0.200	0.6150	0.5350	0.4994	*****	-0.5590	*****	*****	*****	*****	*****
-0.400	0.6065	0.5381	0.4705	0.2510	-0.6211	*****	*****	*****	*****	*****
-0.600	*****	0.5432	0.4655	0.2794	-0.6019	*****	*****	*****	*****	*****
-0.700	*****	0.5308	0.4648	0.2845	-0.5673	*****	*****	*****	*****	*****
-0.800	0.5238	0.4970	0.4440	0.2973	-0.4790	*****	*****	*****	*****	*****
-0.850	0.4634	0.4315	0.4251	0.2938	-0.4589	*****	*****	*****	*****	*****
-0.900	0.3743	0.3752	0.3712	0.2707	-0.3978	*****	*****	*****	*****	*****
-0.950	*****	*****	0.2271	0.1799	-0.1405	*****	*****	*****	*****	*****
-0.975	*****	0.0293	0.0727	0.0476	-0.1149	*****	*****	*****	*****	*****

Sharp Radius L.E.

Run No. = 86 , Point No. = 1899

$C_N = 1.187$, $C_m = -0.1873$

$\alpha = 25.6^\circ$, $M_\infty = 0.799$

$R_{mac} = 6.0 \times 10^6$

Surface Pressures Near Leading Edge

● / ◆ upper, starboard/port
○ / ◇ lower, starboard/port

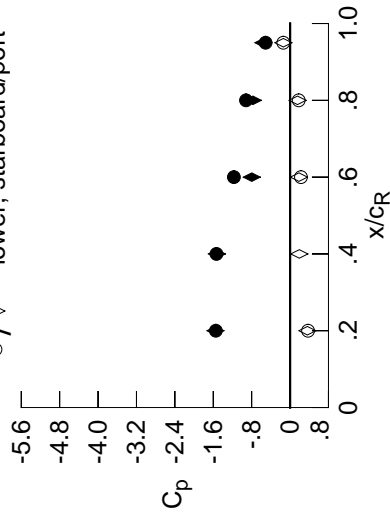

x/c_R	η	starb'd	port	$C_{p,u}$	starb'd	port	$C_{p,l}$
0.20	0.90	-1.5462	-1.5557	0.3612	0.3743	*****	*****
0.40	0.95	-1.5339	-1.5245	0.1927	*****	*****	*****
0.60	0.95	-1.1701	-0.7975	0.1846	0.2271	*****	*****
0.80	0.95	-0.9176	-0.7748	0.1549	0.1799	*****	*****
0.95	0.95	-0.5093	-0.5566	-0.1397	-0.1405	*****	*****

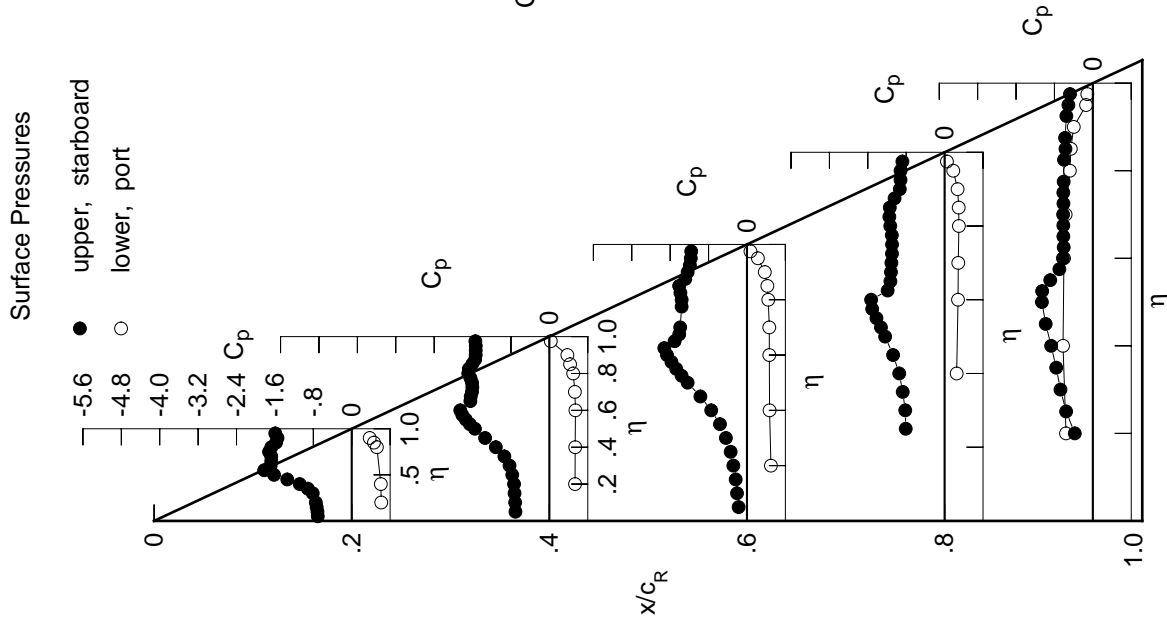

Table D3. Continued.

η	$x/c_R = .2$		$x/c_R = .4$		$x/c_R = .6$		$x/c_R = .8$		$x/c_R = .95$	
	$C_{p,u}$	$C_{p,u}$	$C_{p,u}$	$C_{p,u}$	$C_{p,u}$	$C_{p,u}$	$C_{p,u}$	$C_{p,u}$	$C_{p,u}$	$C_{p,u}$
0.050	-0.7469	-0.7299	-0.0793	*****	*****	*****	*****	*****	*****	*****
0.100	-0.7551	-0.7391	-0.0940	*****	*****	*****	*****	*****	*****	*****
0.150	-0.7742	-0.7549	-0.1105	*****	*****	*****	*****	*****	*****	*****
0.200	-0.7922	-0.7700	-0.1418	*****	*****	*****	*****	*****	*****	*****
0.250	*****	-0.8135	-0.1924	-0.9766	-0.7506	*****	*****	*****	*****	*****
0.300	-0.8799	-0.8830	-0.2813	-0.9727	-0.7839	*****	*****	*****	*****	*****
0.350	-1.0010	-0.9999	-0.4116	-0.9905	-0.7598	*****	*****	*****	*****	*****
0.400	-1.1821	-1.1780	-0.5982	-0.9669	-0.7382	*****	*****	*****	*****	*****
0.450	-1.4311	-1.3951	-0.8210	-0.9582	-0.7370	*****	*****	*****	*****	*****
0.500	-1.6794	-1.5934	-1.0952	-0.9603	-0.7445	*****	*****	*****	*****	*****
0.525	*****	-1.6902	-1.2247	-0.9634	-0.7707	*****	*****	*****	*****	*****
0.550	-1.8503	-1.7670	-1.3285	-0.9718	-0.7686	*****	*****	*****	*****	*****
0.575	*****	-1.8362	-1.3306	-0.9770	-0.7801	*****	*****	*****	*****	*****
0.600	-1.7168	-1.8661	-1.0929	-0.9880	-0.7769	*****	*****	*****	*****	*****
0.625	*****	*****	-0.9860	-0.9783	-0.7758	*****	*****	*****	*****	*****
0.650	-1.7038	-1.6681	-0.9611	-0.9727	-0.7670	*****	*****	*****	*****	*****
0.675	*****	-1.6586	-0.9419	-0.9759	-0.7415	*****	*****	*****	*****	*****
0.700	-1.7133	-1.6291	-0.9351	-0.9692	-0.7333	*****	*****	*****	*****	*****
0.725	*****	-1.6270	*****	-0.9516	-0.7113	*****	*****	*****	*****	*****
0.750	-1.7761	-1.6323	*****	-0.9279	-0.7011	*****	*****	*****	*****	*****
0.775	*****	-1.6656	-0.9083	-0.9166	-0.6710	*****	*****	*****	*****	*****
0.800	-1.7095	-1.7171	-0.9081	-0.9032	*****	*****	*****	*****	*****	*****
0.825	*****	-1.7077	-0.8948	-0.9026	-0.6426	*****	*****	*****	*****	*****
0.850	-1.6002	-1.6318	-0.8916	-0.8998	-0.6222	*****	*****	*****	*****	*****
0.875	*****	-1.5723	-0.8392	-0.8875	-0.6248	*****	*****	*****	*****	*****
0.900	-1.5741	-1.5564	-0.8328	-0.8541	*****	*****	*****	*****	*****	*****
0.925	*****	-1.5553	-0.8148	-0.8478	-0.6052	*****	*****	*****	*****	*****
0.950	-1.6185	-1.5543	-0.8074	-0.8302	-0.5668	*****	*****	*****	*****	*****
0.975	*****	-1.5593	-0.8087	-0.7970	-0.5212	*****	*****	*****	*****	*****

η	$x/c_R = .2$		$x/c_R = .4$		$x/c_R = .6$		$x/c_R = .8$		$x/c_R = .95$	
	$C_{p,l}$	$C_{p,l}$	$C_{p,l}$	$C_{p,l}$	$C_{p,l}$	$C_{p,l}$	$C_{p,l}$	$C_{p,l}$	$C_{p,l}$	$C_{p,l}$
-0.200	0.6384	0.5559	0.5135	*****	*****	*****	*****	*****	*****	*****
-0.400	0.6301	0.5585	0.4881	0.2619	-0.6103	*****	*****	*****	*****	*****
-0.600	*****	0.5587	0.4788	0.2931	-0.5909	*****	*****	*****	*****	*****
-0.700	*****	0.5463	0.4789	0.2931	-0.5550	*****	*****	*****	*****	*****
-0.800	0.5349	0.5081	0.4529	0.3069	-0.4695	*****	*****	*****	*****	*****
-0.850	0.4700	0.4385	0.4313	0.2982	-0.4469	*****	*****	*****	*****	*****
-0.900	0.3761	0.3769	0.3734	0.2695	-0.3831	*****	*****	*****	*****	*****
-0.950	*****	*****	0.2224	0.1682	-0.1347	*****	*****	*****	*****	*****
-0.975	*****	0.0178	0.0604	0.0260	-0.1168	*****	*****	*****	*****	*****

Sharp Radius L.E.
 Run No. = 86 , Point No. = 1900
 $C_N = 1.174$, $C_m = -0.1819$
 $\alpha = 26.6^\circ$, $M_\infty = 0.799$
 $R_{mac} = 6.0 \times 10^6$

Surface Pressures Near Leading Edge

● / ◆ upper, starboard/port
 ○ / ◇ lower, starboard/port

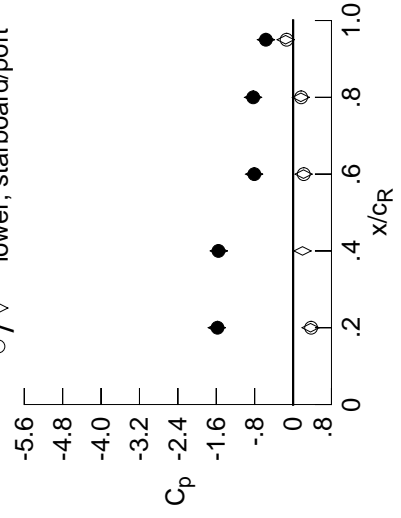

x/c_R	η	starb'd	port	starb'd	port
		$C_{p,u}$	$C_{p,u}$	$C_{p,l}$	$C_{p,l}$
0.20	0.90	-1.5741	-1.5900	0.3640	0.3761
0.40	0.95	-1.5543	-1.5483	0.1965	*****
0.60	0.95	-0.8074	-0.8121	0.2174	0.2224
0.80	0.95	-0.8302	-0.8332	0.1623	0.1682
0.95	0.95	-0.5668	-0.5647	-0.1555	-0.1347

Table D3. Concluded.

η	$x/c_R = .2$		$x/c_R = .4$		$x/c_R = .6$		$x/c_R = .8$		$x/c_R = .95$	
	$C_{p,u}$	$C_{p,l}$	$C_{p,u}$	$C_{p,l}$	$C_{p,u}$	$C_{p,l}$	$C_{p,u}$	$C_{p,l}$	$C_{p,u}$	$C_{p,l}$
0.050	-0.0130	-0.0029	0.1162	*****	*****	*****	*****	*****	*****	*****
0.100	-0.0101	-0.0070	0.1093	*****	*****	*****	*****	*****	*****	*****
0.150	-0.0135	-0.0050	0.0903	*****	*****	*****	*****	*****	*****	*****
0.200	-0.0242	-0.0024	0.0775	*****	*****	*****	*****	*****	*****	*****
0.250	*****	-0.0046	0.0672	-0.1252	-0.3121	*****	*****	*****	*****	*****
0.300	-0.0399	-0.0040	0.0563	-0.1114	-0.3410	*****	*****	*****	*****	*****
0.350	-0.0505	-0.0065	0.0446	-0.1046	-0.3571	*****	*****	*****	*****	*****
0.400	-0.0596	-0.0086	0.0369	-0.0934	-0.3739	*****	*****	*****	*****	*****
0.450	-0.0676	-0.0137	0.0375	-0.0881	-0.3741	*****	*****	*****	*****	*****
0.500	-0.0715	-0.0161	0.0216	-0.0872	-0.3898	*****	*****	*****	*****	*****
0.525	*****	-0.0176	0.0193	-0.0846	-0.3943	*****	*****	*****	*****	*****
0.550	-0.0731	-0.0206	0.0147	-0.0828	-0.3986	*****	*****	*****	*****	*****
0.575	*****	-0.0261	0.0180	-0.0806	-0.4085	*****	*****	*****	*****	*****
0.600	-0.0594	-0.0258	0.0074	-0.0799	-0.4145	*****	*****	*****	*****	*****
0.625	*****	*****	0.0047	-0.0795	-0.4183	*****	*****	*****	*****	*****
0.650	-0.0505	-0.0305	0.0045	-0.0791	-0.4263	*****	*****	*****	*****	*****
0.675	*****	-0.0467	-0.0053	-0.0788	-0.4362	*****	*****	*****	*****	*****
0.700	-0.0429	-0.0642	-0.0091	-0.0786	-0.4507	*****	*****	*****	*****	*****
0.725	*****	-0.0780	*****	-0.0776	-0.4779	*****	*****	*****	*****	*****
0.750	-0.0271	-0.0835	*****	-0.0826	-0.4983	*****	*****	*****	*****	*****
0.775	*****	-0.0874	-0.0251	-0.0822	-0.5308	*****	*****	*****	*****	*****
0.800	-0.0094	-0.0851	-0.0559	-0.0881	*****	*****	*****	*****	*****	*****
0.825	*****	-0.0783	-0.0744	-0.0922	-0.6701	*****	*****	*****	*****	*****
0.850	0.0178	-0.0680	-0.0735	-0.1191	-0.5793	*****	*****	*****	*****	*****
0.875	*****	-0.0536	-0.0708	-0.1431	-0.6578	*****	*****	*****	*****	*****
0.900	0.0551	-0.0293	-0.0611	-0.1427	*****	*****	*****	*****	*****	*****
0.925	*****	0.0018	-0.0367	-0.1200	-0.7222	*****	*****	*****	*****	*****
0.950	0.1018	0.0434	0.0025	-0.0791	-0.3612	*****	*****	*****	*****	*****
0.975	*****	0.0952	0.0638	-0.0041	-0.1695	*****	*****	*****	*****	*****
-0.200	$C_{p,l}$	-0.0439	-0.0020	0.0758	*****	-0.3048	$C_{p,l}$	$C_{p,l}$	$C_{p,l}$	$C_{p,l}$
-0.400	*****	-0.0545	-0.0057	0.0351	-0.0967	-0.3669	*****	*****	*****	*****
-0.600	*****	*****	-0.0175	0.0045	-0.0844	-0.4018	*****	*****	*****	*****
-0.700	*****	*****	-0.0579	-0.0098	-0.0842	-0.5114	*****	*****	*****	*****
-0.800	-0.0294	-0.0887	-0.0643	-0.0935	-0.7403	*****	*****	*****	*****	*****
-0.850	0.0055	-0.0686	-0.0820	-0.1363	-0.7705	*****	*****	*****	*****	*****
-0.900	0.0440	-0.0391	-0.0816	-0.1555	-0.9676	*****	*****	*****	*****	*****
-0.950	*****	*****	-0.0121	-0.1051	-0.3874	*****	*****	*****	*****	*****
-0.975	*****	0.0843	0.0454	-0.0265	-0.2013	*****	*****	*****	*****	*****

Sharp Radius L.E.
 Run No. = 86, Point No. = 1901
 $C_N = -0.017$, $C_m = 0.0050$
 $\alpha = 0.1^\circ$, $M_\infty = 0.799$
 $R_{mac} = 6.0 \times 10^6$

Surface Pressures Near Leading Edge

● / ◆ upper, starboard/port
 ○ / ◇ lower, starboard/port

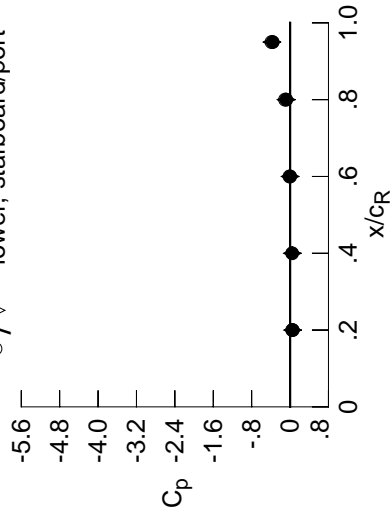

x/c_R	η	starb'd	port	starb'd	port
0.20	0.90	0.0551	0.0582	0.0485	0.0440
0.40	0.95	0.0434	0.0515	0.0430	*****
0.60	0.95	0.0025	0.0067	-0.0057	-0.0121
0.80	0.95	-0.0791	-0.0705	-0.0928	-0.1051
0.95	0.95	-0.3612	-0.3738	-0.3824	-0.3874

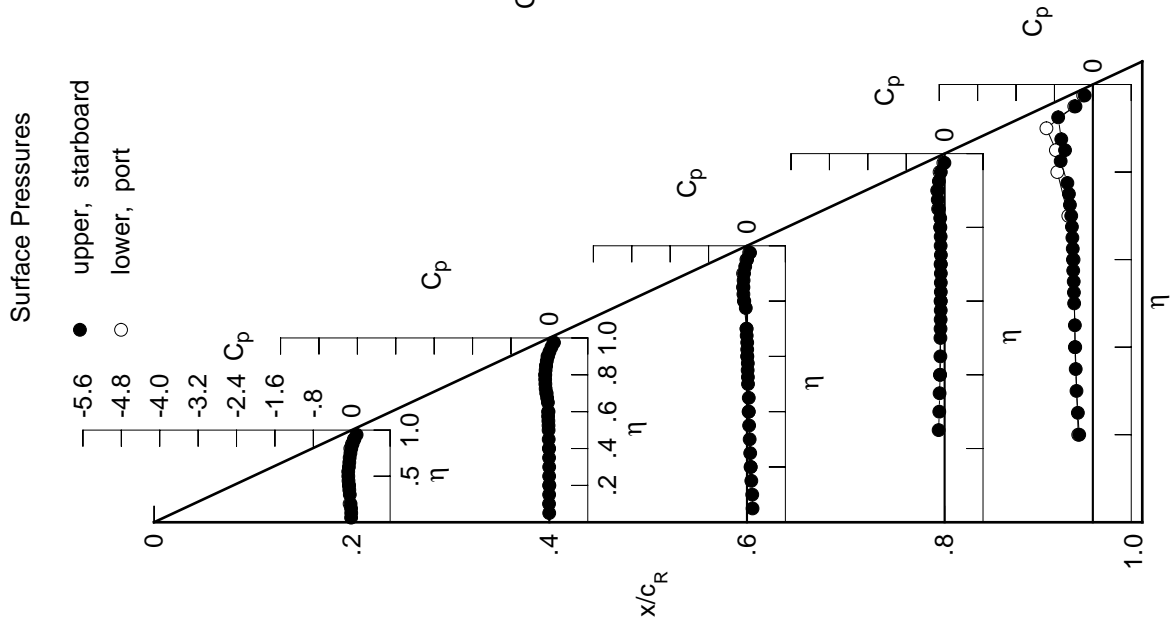

Table D4. Tabulations and Plots of Surface Pressure Coefficients.

η	$x/c_R = .2$		$x/c_R = .4$		$x/c_R = .6$		$x/c_R = .8$		$x/c_R = .95$	
	$C_{p,u}$	$C_{p,u}$	$C_{p,u}$	$C_{p,u}$	$C_{p,u}$	$C_{p,u}$	$C_{p,u}$	$C_{p,u}$	$C_{p,u}$	$C_{p,u}$
0.050	-0.0035	0.0082	0.1269	0.1269	0.1269	0.1269	0.1269	0.1269	0.1269	0.1269
0.100	0.0011	0.0046	0.1189	0.1189	0.1189	0.1189	0.1189	0.1189	0.1189	0.1189
0.150	-0.0001	0.0052	0.1038	0.1038	0.1038	0.1038	0.1038	0.1038	0.1038	0.1038
0.200	-0.0076	0.0065	0.0903	0.0903	0.0903	0.0903	0.0903	0.0903	0.0903	0.0903
0.250	*****	0.0057	0.0811	-0.1240	-0.3201	-0.2832	-0.2832	-0.2832	-0.2832	-0.2832
0.300	-0.0242	0.0066	0.0656	-0.1092	-0.3485	-0.3485	-0.3485	-0.3485	-0.3485	-0.3485
0.350	-0.0339	0.0048	0.0583	-0.1022	-0.3678	-0.3678	-0.3678	-0.3678	-0.3678	-0.3678
0.400	-0.0426	0.0026	0.0501	-0.0889	-0.3824	-0.3824	-0.3824	-0.3824	-0.3824	-0.3824
0.450	-0.0536	-0.0021	0.0497	-0.0853	-0.3902	-0.3902	-0.3902	-0.3902	-0.3902	-0.3902
0.500	-0.0571	-0.0035	0.0348	-0.0788	-0.4009	-0.4009	-0.4009	-0.4009	-0.4009	-0.4009
0.525	*****	-0.0080	0.0326	-0.0791	-0.4158	-0.4158	-0.4158	-0.4158	-0.4158	-0.4158
0.550	-0.0564	-0.0077	0.0273	-0.0759	-0.4260	-0.4260	-0.4260	-0.4260	-0.4260	-0.4260
0.575	*****	-0.0137	0.0282	-0.0770	-0.4513	-0.4513	-0.4513	-0.4513	-0.4513	-0.4513
0.600	-0.0416	-0.0137	0.0208	-0.0711	-0.4765	-0.4765	-0.4765	-0.4765	-0.4765	-0.4765
0.625	*****	*****	0.0201	-0.0726	-0.5085	-0.5085	-0.5085	-0.5085	-0.5085	-0.5085
0.650	-0.0317	-0.0183	0.0159	-0.0688	-0.5478	-0.5478	-0.5478	-0.5478	-0.5478	-0.5478
0.675	*****	-0.0279	0.0085	-0.0709	-0.5840	-0.5840	-0.5840	-0.5840	-0.5840	-0.5840
0.700	-0.0226	-0.0388	0.0064	-0.0729	-0.6253	-0.6253	-0.6253	-0.6253	-0.6253	-0.6253
0.725	*****	-0.0503	*****	-0.0686	-0.6683	-0.6683	-0.6683	-0.6683	-0.6683	-0.6683
0.750	-0.0078	-0.0589	*****	-0.0713	-0.6970	-0.6970	-0.6970	-0.6970	-0.6970	-0.6970
0.775	*****	-0.0681	-0.0119	-0.0718	-0.7151	-0.7151	-0.7151	-0.7151	-0.7151	-0.7151
0.800	0.0101	-0.0610	-0.0311	-0.0819	*****	*****	*****	*****	*****	*****
0.825	*****	-0.0570	-0.0429	-0.0827	-0.7489	-0.7489	-0.7489	-0.7489	-0.7489	-0.7489
0.850	0.0387	-0.0450	-0.0495	-0.0977	-0.6169	-0.6169	-0.6169	-0.6169	-0.6169	-0.6169
0.875	*****	-0.0296	-0.0454	-0.1192	-0.6867	-0.6867	-0.6867	-0.6867	-0.6867	-0.6867
0.900	0.0773	-0.0066	-0.0311	-0.1160	*****	*****	*****	*****	*****	*****
0.925	*****	0.0262	-0.0083	-0.0919	-0.6556	-0.6556	-0.6556	-0.6556	-0.6556	-0.6556
0.950	0.1227	0.0679	0.0328	-0.0506	-0.3338	-0.3338	-0.3338	-0.3338	-0.3338	-0.3338
0.975	*****	0.1189	0.0927	0.0272	-0.1466	-0.1466	-0.1466	-0.1466	-0.1466	-0.1466

η	$C_{p,i}$		$C_{p,i}$		$C_{p,i}$		$C_{p,i}$		$C_{p,i}$	
	$C_{p,i}$	$C_{p,i}$	$C_{p,i}$	$C_{p,i}$	$C_{p,i}$	$C_{p,i}$	$C_{p,i}$	$C_{p,i}$	$C_{p,i}$	$C_{p,i}$
-0.200	-0.0495	-0.0106	0.0780	*****	-0.2985	-0.2985	-0.2985	-0.2985	-0.2985	-0.2985
-0.400	-0.0722	-0.0099	0.0322	-0.1049	-0.3572	-0.3572	-0.3572	-0.3572	-0.3572	-0.3572
-0.600	*****	-0.0258	0.0024	-0.0922	-0.4391	-0.4391	-0.4391	-0.4391	-0.4391	-0.4391
-0.700	*****	-0.0735	-0.0112	-0.0921	-0.6927	-0.6927	-0.6927	-0.6927	-0.6927	-0.6927
-0.800	-0.0446	-0.1066	-0.0798	-0.0989	-0.7626	-0.7626	-0.7626	-0.7626	-0.7626	-0.7626
-0.850	-0.0110	-0.0874	-0.1007	-0.1502	-0.7051	-0.7051	-0.7051	-0.7051	-0.7051	-0.7051
-0.900	0.0277	-0.0609	-0.1032	-0.1758	-0.8962	-0.8962	-0.8962	-0.8962	-0.8962	-0.8962
-0.950	*****	*****	-0.0361	-0.1297	-0.3816	-0.3816	-0.3816	-0.3816	-0.3816	-0.3816
-0.975	*****	0.0609	0.0206	-0.0539	-0.2162	-0.2162	-0.2162	-0.2162	-0.2162	-0.2162

Sharp Radius L.E.
 Run No. = 87, Point No. = 1902
 $C_N = -0.034$, $C_m = 0.0074$
 $\alpha = -0.4^\circ$, $M_\infty = 0.830$
 $R_{mac} = 6.0 \times 10^6$

Surface Pressures Near Leading Edge

● / ◆ upper, starboard/port
 ○ / ◇ lower, starboard/port

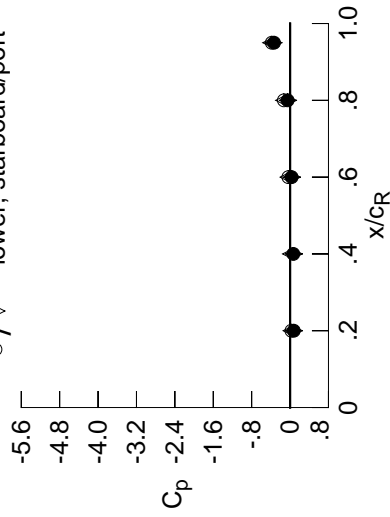

x/c_R	η	starb'd	port	starb'd	port
		$C_{p,u}$	$C_{p,i}$	$C_{p,u}$	$C_{p,i}$
0.20	0.90	0.0773	0.0794	0.0326	0.0277
0.40	0.95	0.0679	0.0772	0.0219	*****
0.60	0.95	0.0328	0.0369	-0.0293	-0.0361
0.80	0.95	-0.0506	-0.0441	-0.1221	-0.1297
0.95	0.95	-0.3338	-0.3477	-0.3916	-0.3816

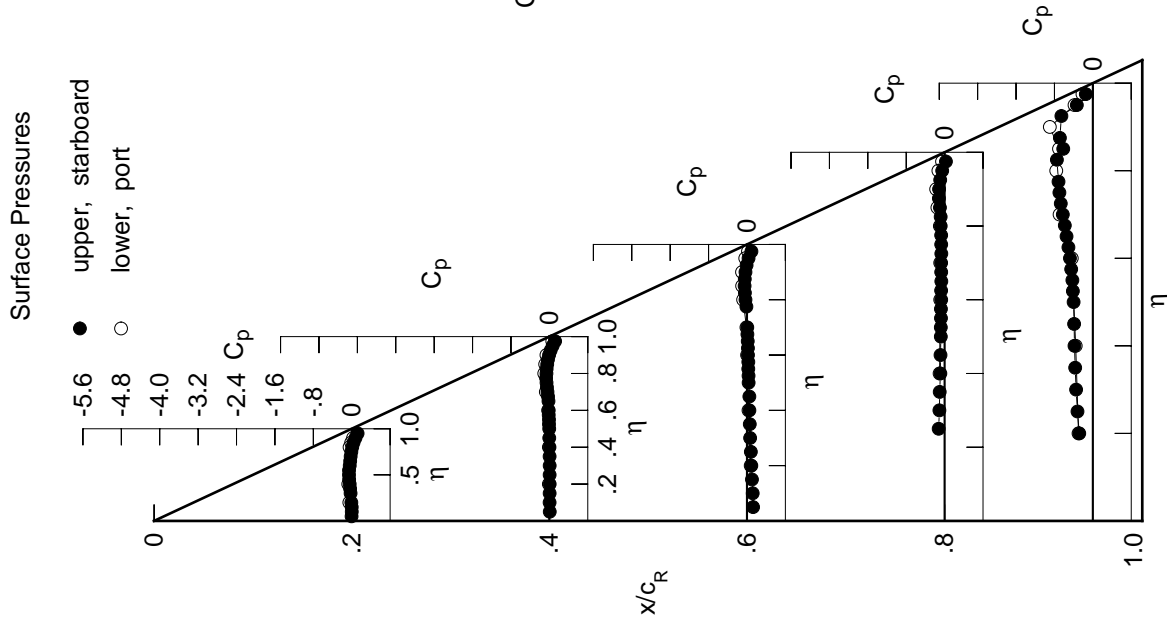

Table D4. Continued.

η	$x/c_R = .2$		$x/c_R = .4$		$x/c_R = .6$		$x/c_R = .8$		$x/c_R = .95$	
	$C_{p,u}$	$C_{p,l}$	$C_{p,u}$	$C_{p,l}$	$C_{p,u}$	$C_{p,l}$	$C_{p,u}$	$C_{p,l}$	$C_{p,u}$	$C_{p,l}$
0.050	-0.0126	-0.0020	0.1216	0.1216	0.1216	0.1216	0.1216	0.1216	0.1216	0.1216
0.100	-0.0095	-0.0058	0.1121	0.1121	0.1121	0.1121	0.1121	0.1121	0.1121	0.1121
0.150	-0.0144	-0.0041	0.0969	0.0969	0.0969	0.0969	0.0969	0.0969	0.0969	0.0969
0.200	-0.0237	-0.0022	0.0838	0.0838	0.0838	0.0838	0.0838	0.0838	0.0838	0.0838
0.250	*****	-0.0045	0.0721	-0.1337	0.0721	-0.1337	0.0721	-0.1337	0.0721	-0.1337
0.300	-0.0414	-0.0028	0.0587	-0.1173	0.0587	-0.1173	0.0587	-0.1173	0.0587	-0.1173
0.350	-0.0505	-0.0059	0.0497	-0.1076	0.0497	-0.1076	0.0497	-0.1076	0.0497	-0.1076
0.400	-0.0597	-0.0080	0.0421	-0.0970	0.0421	-0.0970	0.0421	-0.0970	0.0421	-0.0970
0.450	-0.0671	-0.0130	0.0403	-0.0917	0.0403	-0.0917	0.0403	-0.0917	0.0403	-0.0917
0.500	-0.0713	-0.0142	0.0271	-0.0883	0.0271	-0.0883	0.0271	-0.0883	0.0271	-0.0883
0.525	*****	-0.0172	0.0232	-0.0838	0.0232	-0.0838	0.0232	-0.0838	0.0232	-0.0838
0.550	-0.0726	-0.0187	0.0197	-0.0861	0.0197	-0.0861	0.0197	-0.0861	0.0197	-0.0861
0.575	*****	-0.0237	0.0198	-0.0815	0.0198	-0.0815	0.0198	-0.0815	0.0198	-0.0815
0.600	-0.0580	-0.0260	0.0116	-0.0827	0.0116	-0.0827	0.0116	-0.0827	0.0116	-0.0827
0.625	*****	*****	0.0086	-0.0800	0.0086	-0.0800	0.0086	-0.0800	0.0086	-0.0800
0.650	-0.0467	-0.0305	0.0043	-0.0807	0.0043	-0.0807	0.0043	-0.0807	0.0043	-0.0807
0.675	*****	-0.0436	0.0038	-0.0819	0.0038	-0.0819	0.0038	-0.0819	0.0038	-0.0819
0.700	-0.0407	-0.0575	-0.0049	-0.0820	-0.0049	-0.0820	-0.0049	-0.0820	-0.0049	-0.0820
0.725	*****	-0.0755	*****	-0.0778	*****	-0.0778	*****	-0.0778	*****	-0.0778
0.750	-0.0256	-0.0803	*****	-0.0840	*****	-0.0840	*****	-0.0840	*****	-0.0840
0.775	*****	-0.0872	-0.0229	-0.0834	-0.0229	-0.0834	-0.0229	-0.0834	-0.0229	-0.0834
0.800	-0.0084	-0.0846	-0.0506	-0.0917	-0.0506	-0.0917	-0.0506	-0.0917	-0.0506	-0.0917
0.825	*****	-0.0774	-0.0703	-0.0917	-0.0703	-0.0917	-0.0703	-0.0917	-0.0703	-0.0917
0.850	0.0200	-0.0654	-0.0712	-0.1185	-0.0712	-0.1185	-0.0712	-0.1185	-0.0712	-0.1185
0.875	*****	-0.0527	-0.0699	-0.1426	-0.0699	-0.1426	-0.0699	-0.1426	-0.0699	-0.1426
0.900	0.0586	-0.0293	-0.0571	-0.1401	-0.0571	-0.1401	-0.0571	-0.1401	-0.0571	-0.1401
0.925	*****	0.0025	-0.0325	-0.1176	-0.0325	-0.1176	-0.0325	-0.1176	-0.0325	-0.1176
0.950	0.1046	0.0472	0.0085	-0.0785	0.0085	-0.0785	0.0085	-0.0785	0.0085	-0.0785
0.975	*****	0.0951	0.0684	-0.0022	0.0684	-0.0022	0.0684	-0.0022	0.0684	-0.0022
-0.200	-0.0424	-0.0025	0.0809	0.0809	0.0809	0.0809	0.0809	0.0809	0.0809	0.0809
-0.400	-0.0552	-0.0062	0.0383	-0.1004	0.0383	-0.1004	0.0383	-0.1004	0.0383	-0.1004
-0.600	*****	-0.0200	-0.0072	-0.0860	-0.0072	-0.0860	-0.0072	-0.0860	-0.0072	-0.0860
-0.700	*****	-0.0559	-0.0072	-0.0874	-0.0072	-0.0874	-0.0072	-0.0874	-0.0072	-0.0874
-0.800	-0.0284	-0.0884	-0.0615	-0.0932	-0.0615	-0.0932	-0.0615	-0.0932	-0.0615	-0.0932
-0.850	0.0047	-0.0688	-0.0798	-0.1358	-0.0798	-0.1358	-0.0798	-0.1358	-0.0798	-0.1358
-0.900	0.0438	-0.0386	-0.0786	-0.1566	-0.0786	-0.1566	-0.0786	-0.1566	-0.0786	-0.1566
-0.950	*****	*****	-0.0092	-0.1029	-0.0092	-0.1029	-0.0092	-0.1029	-0.0092	-0.1029
-0.975	*****	0.0837	0.0478	-0.0250	0.0478	-0.0250	0.0478	-0.0250	0.0478	-0.0250

Sharp Radius L.E.
 Run No. = 87 , Point No. = 1903
 $C_N = -0.013$, $C_m = 0.0021$
 $\alpha = 0.1^\circ$, $M_\infty = 0.831$
 $R_{mac} = 6.0 \times 10^6$

Surface Pressures Near Leading Edge

● / ◆ upper, starboard/port
 ○ / ◇ lower, starboard/port

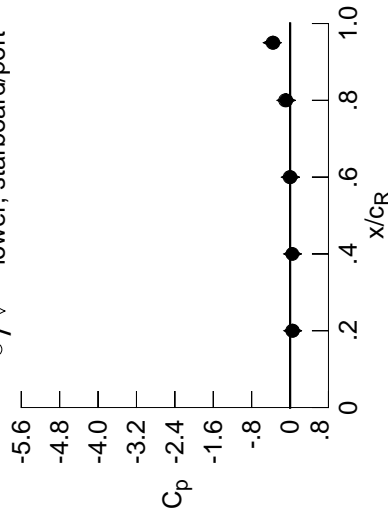

x/c_R	η	starb'd	port	starb'd	port
		$C_{p,u}$	$C_{p,l}$	$C_{p,u}$	$C_{p,l}$
0.20	0.90	0.0586	0.0609	0.0485	0.0438
0.40	0.95	0.0472	0.0538	0.0466	*****
0.60	0.95	0.0085	0.0133	-0.0024	-0.0092
0.80	0.95	-0.0785	-0.0697	-0.0957	-0.1029
0.95	0.95	-0.3478	-0.3652	-0.3795	-0.3648

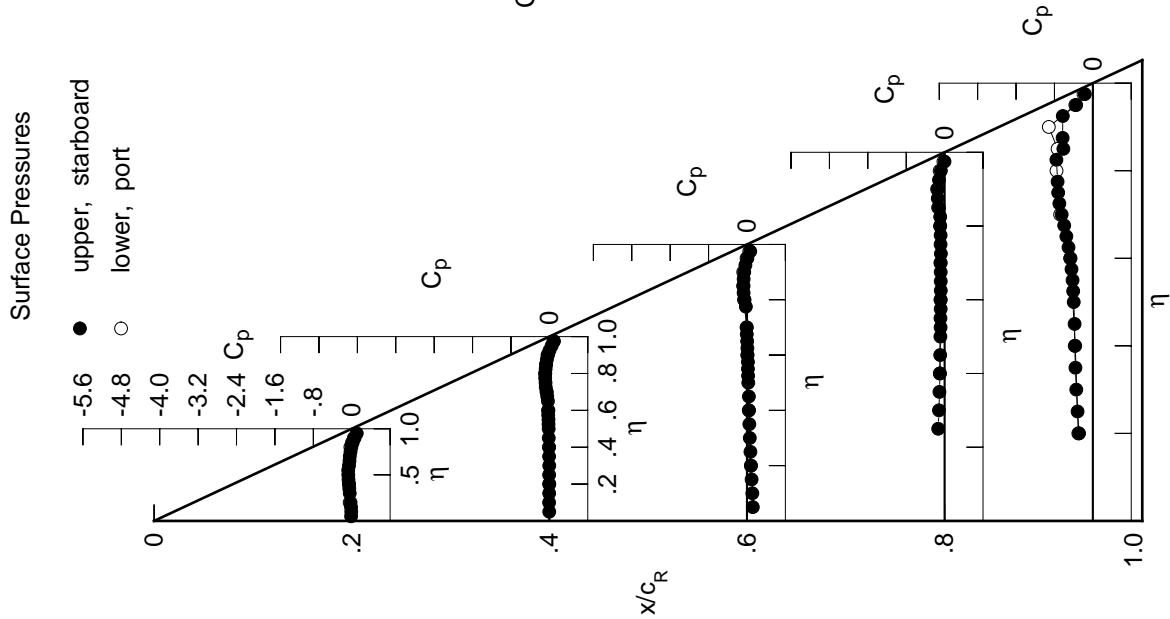

Table D4. Continued.

η	$x/c_R = .2$		$x/c_R = .4$		$x/c_R = .6$		$x/c_R = .8$		$x/c_R = .95$	
	$C_{p,u}$	$C_{p,l}$	$C_{p,u}$	$C_{p,l}$	$C_{p,u}$	$C_{p,l}$	$C_{p,u}$	$C_{p,l}$	$C_{p,u}$	$C_{p,l}$
0.050	-0.0320	-0.0208	-0.0208	-0.1074	0.1074	0.0932	0.0932	0.0932	0.0932	0.0932
0.100	-0.0308	-0.0224	-0.0224	0.0999	0.0999	0.0512	0.0512	0.0512	0.0512	0.0512
0.150	-0.0368	-0.0192	-0.0192	0.0825	0.0825	0.0257	0.0257	0.0257	0.0257	0.0257
0.200	-0.0453	-0.0205	-0.0205	0.0705	0.0705	0.0132	0.0132	0.0132	0.0132	0.0132
0.250	*****	-0.0223	-0.0223	0.0569	0.0569	0.0078	0.0078	0.0078	0.0078	0.0078
0.300	-0.0656	-0.0215	-0.0215	0.0444	0.0444	0.0048	0.0048	0.0048	0.0048	0.0048
0.350	-0.0751	-0.0248	-0.0248	0.0334	0.0334	0.0034	0.0034	0.0034	0.0034	0.0034
0.400	-0.0814	-0.0277	-0.0277	0.0260	0.0260	0.0026	0.0026	0.0026	0.0026	0.0026
0.450	-0.0903	-0.0340	-0.0340	0.0228	0.0228	0.0021	0.0021	0.0021	0.0021	0.0021
0.500	-0.0965	-0.0392	-0.0392	0.0081	0.0081	-0.1023	-0.3634	-0.3634	-0.3634	-0.3634
0.525	*****	-0.0413	-0.0413	0.0050	0.0050	-0.1004	-0.3682	-0.3682	-0.3682	-0.3682
0.550	-0.1018	-0.0410	-0.0410	-0.0009	-0.1003	-0.3691	-0.3691	-0.3691	-0.3691	-0.3691
0.575	*****	-0.0501	-0.0501	-0.0009	-0.1000	-0.3804	-0.3804	-0.3804	-0.3804	-0.3804
0.600	-0.0903	-0.0530	-0.0530	-0.0086	-0.0984	-0.3920	-0.3920	-0.3920	-0.3920	-0.3920
0.625	*****	*****	-0.0126	-0.0992	-0.4064	-0.4064	-0.4064	-0.4064	-0.4064	-0.4064
0.650	-0.0835	-0.0615	-0.0615	-0.0190	-0.0969	-0.4373	-0.4373	-0.4373	-0.4373	-0.4373
0.675	*****	-0.0742	-0.0742	-0.0276	-0.1018	-0.4725	-0.4725	-0.4725	-0.4725	-0.4725
0.700	-0.0754	-0.0874	-0.0874	-0.0320	-0.1010	-0.5355	-0.5355	-0.5355	-0.5355	-0.5355
0.725	*****	-0.1027	*****	*****	-0.1035	-0.6131	-0.6131	-0.6131	-0.6131	-0.6131
0.750	-0.0624	-0.1107	*****	*****	-0.1044	-0.6739	-0.6739	-0.6739	-0.6739	-0.6739
0.775	*****	-0.1224	-0.0609	-0.1125	-0.6961	-0.6961	-0.6961	-0.6961	-0.6961	-0.6961
0.800	-0.0460	-0.1254	-0.0833	-0.1205	*****	*****	*****	*****	*****	*****
0.825	*****	-0.1226	-0.1027	-0.1254	-0.7022	-0.7022	-0.7022	-0.7022	-0.7022	-0.7022
0.850	-0.0191	-0.1160	-0.1162	-0.1557	-0.5935	-0.5935	-0.5935	-0.5935	-0.5935	-0.5935
0.875	*****	-0.1034	-0.1157	-0.1872	-0.6041	-0.6041	-0.6041	-0.6041	-0.6041	-0.6041
0.900	0.0194	-0.0804	-0.1072	-0.1932	*****	*****	*****	*****	*****	*****
0.925	*****	-0.0483	-0.0912	-0.1735	-0.6040	-0.6040	-0.6040	-0.6040	-0.6040	-0.6040
0.950	0.0636	-0.0087	-0.0503	-0.1434	-0.3776	-0.3776	-0.3776	-0.3776	-0.3776	-0.3776
0.975	*****	0.0374	0.0073	-0.0694	-0.2141	-0.2141	-0.2141	-0.2141	-0.2141	-0.2141
-0.200	-0.0105	0.0126	0.0932	*****	*****	-0.3166	-0.3166	-0.3166	-0.3166	-0.3166
-0.400	-0.0240	0.0146	0.0512	-0.0900	-0.3868	-0.3868	-0.3868	-0.3868	-0.3868	-0.3868
-0.600	*****	-0.0029	0.0257	-0.0708	-0.5125	-0.5125	-0.5125	-0.5125	-0.5125	-0.5125
-0.700	*****	-0.0300	0.0132	-0.0715	-0.6643	-0.6643	-0.6643	-0.6643	-0.6643	-0.6643
-0.800	0.0096	-0.0481	-0.0260	-0.0726	-0.7186	-0.7186	-0.7186	-0.7186	-0.7186	-0.7186
-0.850	0.0432	-0.0271	-0.0402	-0.0941	-0.7502	-0.7502	-0.7502	-0.7502	-0.7502	-0.7502
-0.900	0.0826	0.0100	-0.0300	-0.1065	-0.9100	-0.9100	-0.9100	-0.9100	-0.9100	-0.9100
-0.950	*****	*****	0.0450	-0.0444	-0.3275	-0.3275	-0.3275	-0.3275	-0.3275	-0.3275
-0.975	*****	0.1292	0.1007	0.0316	-0.1481	-0.1481	-0.1481	-0.1481	-0.1481	-0.1481

Sharp Radius L.E.
 Run No. = 87 , Point No. = 1904
 $C_N = 0.026$, $C_m = -0.0030$
 $\alpha = 1.1^\circ$, $M_\infty = 0.831$
 $R_{mac} = 6.0 \times 10^6$

Surface Pressures Near Leading Edge

● / ◆ upper, starboard/port
 ○ / ◇ lower, starboard/port

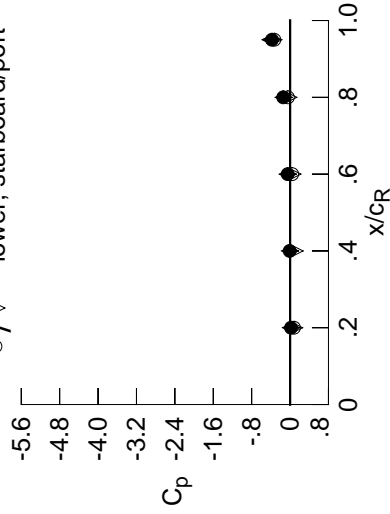

x/c_R	η	starb'd	port	starb'd	port
		$C_{p,u}$		$C_{p,l}$	
0.20	0.90	0.0194	0.0198	0.0859	0.0826
0.40	0.95	-0.0087	-0.0003	0.0926	*****
0.60	0.95	-0.0503	-0.0478	0.0472	0.0450
0.80	0.95	-0.1434	-0.1328	-0.0378	-0.0444
0.95	0.95	-0.3776	-0.4062	-0.3499	-0.3275

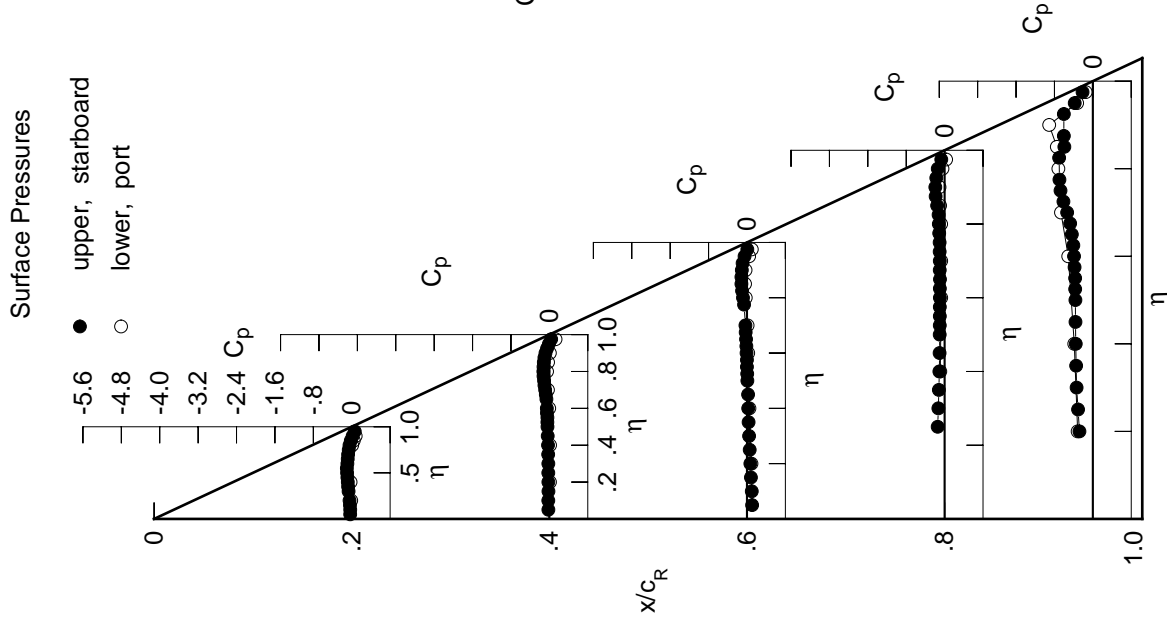

Table D4. Continued.

η	$x/c_R = .2$		$x/c_R = .4$		$x/c_R = .6$		$x/c_R = .8$		$x/c_R = .95$	
	$C_{p,u}$	$C_{p,l}$	$C_{p,u}$	$C_{p,l}$	$C_{p,u}$	$C_{p,l}$	$C_{p,u}$	$C_{p,l}$	$C_{p,u}$	$C_{p,l}$
0.050	-0.0471	-0.0345	0.0924	0.0924	0.0924	0.0924	0.0924	0.0924	0.0924	0.0924
0.100	-0.0444	-0.0381	0.0868	0.0868	0.0868	0.0868	0.0868	0.0868	0.0868	0.0868
0.150	-0.0504	-0.0395	0.0685	0.0685	0.0685	0.0685	0.0685	0.0685	0.0685	0.0685
0.200	-0.0558	-0.0369	0.0576	0.0576	0.0576	0.0576	0.0576	0.0576	0.0576	0.0576
0.250	*****	-0.0396	0.0447	-0.1534	0.0447	-0.1534	0.0447	-0.1534	0.0447	-0.1534
0.300	-0.0724	-0.0412	0.0311	-0.1429	0.0311	-0.1429	0.0311	-0.1429	0.0311	-0.1429
0.350	-0.0833	-0.0436	0.0205	-0.1309	0.0205	-0.1309	0.0205	-0.1309	0.0205	-0.1309
0.400	-0.0933	-0.0481	0.0095	-0.1229	0.0095	-0.1229	0.0095	-0.1229	0.0095	-0.1229
0.450	-0.1086	-0.0549	0.0104	-0.1174	0.0104	-0.1174	0.0104	-0.1174	0.0104	-0.1174
0.500	-0.1154	-0.0592	-0.0109	-0.1140	-0.0109	-0.1140	-0.0109	-0.1140	-0.0109	-0.1140
0.525	*****	-0.0628	-0.0105	-0.1158	-0.0105	-0.1158	-0.0105	-0.1158	-0.0105	-0.1158
0.550	-0.1234	-0.0665	-0.0204	-0.1138	-0.0204	-0.1138	-0.0204	-0.1138	-0.0204	-0.1138
0.575	*****	-0.0735	-0.0194	-0.1161	-0.0194	-0.1161	-0.0194	-0.1161	-0.0194	-0.1161
0.600	-0.1237	-0.0763	-0.0291	-0.1111	-0.0291	-0.1111	-0.0291	-0.1111	-0.0291	-0.1111
0.625	*****	*****	-0.0334	-0.1176	-0.0334	-0.1176	-0.0334	-0.1176	-0.0334	-0.1176
0.650	-0.1181	-0.0889	-0.0388	-0.1159	-0.0388	-0.1159	-0.0388	-0.1159	-0.0388	-0.1159
0.675	*****	-0.1020	-0.0498	-0.1182	-0.0498	-0.1182	-0.0498	-0.1182	-0.0498	-0.1182
0.700	-0.1074	-0.1183	-0.0537	-0.1224	-0.0537	-0.1224	-0.0537	-0.1224	-0.0537	-0.1224
0.725	*****	-0.1374	*****	-0.1250	-0.1374	*****	-0.1250	-0.1374	*****	-0.1250
0.750	-0.0963	-0.1480	*****	-0.1286	-0.0963	-0.1480	*****	-0.1286	-0.0963	-0.1480
0.775	*****	-0.1599	-0.0919	-0.1383	-0.1599	-0.0919	-0.1383	-0.1599	-0.0919	-0.1383
0.800	-0.0825	-0.1638	-0.1168	-0.1494	-0.0825	-0.1638	-0.1168	-0.1494	-0.0825	-0.1638
0.825	*****	-0.1638	-0.1407	-0.1576	-0.1638	-0.1407	-0.1576	-0.1638	-0.1407	-0.1576
0.850	-0.0553	-0.1575	-0.1610	-0.1910	-0.0553	-0.1575	-0.1610	-0.1910	-0.0553	-0.1575
0.875	*****	-0.1515	-0.1611	-0.2239	-0.1515	-0.1611	-0.2239	-0.1515	-0.1611	-0.2239
0.900	-0.0204	-0.1315	-0.1648	-0.2361	-0.0204	-0.1315	-0.1648	-0.2361	-0.0204	-0.1315
0.925	*****	-0.1029	-0.1510	-0.2345	-0.1029	-0.1510	-0.2345	-0.1029	-0.1510	-0.2345
0.950	0.0208	-0.0647	-0.1152	-0.2070	0.0208	-0.0647	-0.1152	-0.2070	0.0208	-0.0647
0.975	*****	-0.0184	-0.0590	-0.1361	-0.0184	-0.0590	-0.1361	-0.0184	-0.0590	-0.1361
-0.200	0.0177	0.0321	0.1075	0.1075	0.0177	0.0321	0.1075	0.1075	0.0177	0.0321
-0.400	0.0000	0.0323	0.0683	-0.0770	0.0000	0.0323	0.0683	-0.0770	0.0000	0.0323
-0.600	*****	0.0211	0.0439	-0.0551	0.0211	0.0439	-0.0551	0.0211	0.0439	-0.0551
-0.700	*****	-0.0014	0.0362	-0.0513	-0.0014	0.0362	-0.0513	-0.0014	0.0362	-0.0513
-0.800	0.0443	-0.0052	0.0043	-0.0504	0.0443	-0.0052	0.0043	-0.0504	0.0443	-0.0052
-0.850	0.0777	0.0115	0.0001	-0.0635	0.0777	0.0115	0.0001	-0.0635	0.0777	0.0115
-0.900	0.1138	0.0529	0.0166	-0.0612	0.1138	0.0529	0.0166	-0.0612	0.1138	0.0529
-0.950	*****	*****	0.0892	0.0026	0.1138	0.0529	0.0166	-0.0612	0.1138	0.0529
-0.975	*****	0.1627	0.1408	0.0757	0.1627	0.1408	0.0757	0.1627	0.1408	0.0757

Sharp Radius L.E.
 Run No. = 87 , Point No. = 1905
 $C_N = 0.063$, $C_m = -0.0075$
 $\alpha = 2.1^\circ$, $M_\infty = 0.831$
 $R_{mac} = 6.0 \times 10^6$

Surface Pressures Near Leading Edge

● / ◆ upper, starboard/port
 ○ / ◇ lower, starboard/port

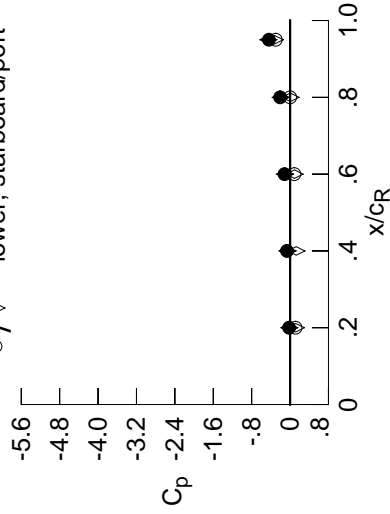

x/c_R	η	starb'd	port	starb'd	port
		$C_{p,u}$	$C_{p,l}$	$C_{p,u}$	$C_{p,l}$
0.20	0.90	-0.0204	-0.0156	0.1194	0.1138
0.40	0.95	-0.0647	-0.0534	0.1293	*****
0.60	0.95	-0.1152	-0.1084	0.0926	0.0892
0.80	0.95	-0.2070	-0.1935	0.0073	0.0026
0.95	0.95	-0.4407	-0.4526	-0.3209	-0.2986

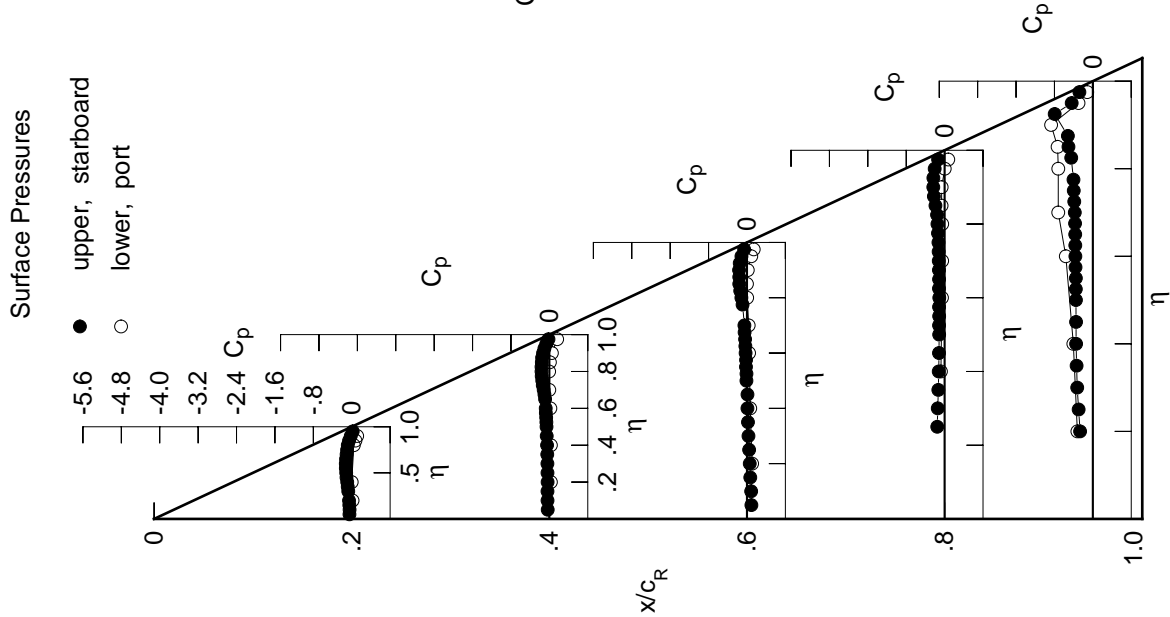

Table D4. Continued.

η	$x/c_R = .2$		$x/c_R = .4$		$x/c_R = .6$		$x/c_R = .8$		$x/c_R = .95$	
	$C_{p,u}$	$C_{p,u}$	$C_{p,u}$	$C_{p,u}$	$C_{p,u}$	$C_{p,u}$	$C_{p,u}$	$C_{p,u}$	$C_{p,u}$	$C_{p,u}$
0.050	-0.0681	-0.0516	0.0816	0.0816	0.0816	0.0816	0.0816	0.0816	0.0816	0.0816
0.100	-0.0754	-0.0569	0.0750	0.0750	0.0750	0.0750	0.0750	0.0750	0.0750	0.0750
0.150	-0.0794	-0.0543	0.0569	0.0569	0.0569	0.0569	0.0569	0.0569	0.0569	0.0569
0.200	-0.0910	-0.0551	0.0447	0.0447	0.0447	0.0447	0.0447	0.0447	0.0447	0.0447
0.250	*****	-0.0562	0.0327	-0.1651	-0.2869	0.0327	-0.1651	-0.2869	0.0327	-0.1651
0.300	-0.0962	-0.0606	0.0175	-0.1541	-0.3200	0.0175	-0.1541	-0.3200	0.0175	-0.1541
0.350	-0.1078	-0.0613	0.0073	-0.1430	-0.3371	0.0073	-0.1430	-0.3371	0.0073	-0.1430
0.400	-0.1189	-0.0688	-0.0043	-0.1339	-0.3503	-0.0043	-0.1339	-0.3503	-0.0043	-0.1339
0.450	-0.1330	-0.0761	-0.0064	-0.1293	-0.3460	-0.0064	-0.1293	-0.3460	-0.0064	-0.1293
0.500	-0.1427	-0.0814	-0.0268	-0.1287	-0.3517	-0.0268	-0.1287	-0.3517	-0.0268	-0.1287
0.525	*****	-0.0868	-0.0279	-0.1283	-0.3492	-0.0279	-0.1283	-0.3492	-0.0279	-0.1283
0.550	-0.1519	-0.0901	-0.0389	-0.1278	-0.3474	-0.0389	-0.1278	-0.3474	-0.0389	-0.1278
0.575	*****	-0.0994	-0.0384	-0.1271	-0.3487	-0.0384	-0.1271	-0.3487	-0.0384	-0.1271
0.600	-0.1564	-0.1023	-0.0499	-0.1294	-0.3487	-0.0499	-0.1294	-0.3487	-0.0499	-0.1294
0.625	*****	*****	-0.0544	-0.1344	-0.3519	-0.0544	-0.1344	-0.3519	-0.0544	-0.1344
0.650	-0.1507	-0.1181	-0.0643	-0.1347	-0.3533	-0.0643	-0.1347	-0.3533	-0.0643	-0.1347
0.675	*****	-0.1324	-0.0728	-0.1375	-0.3540	-0.0728	-0.1375	-0.3540	-0.0728	-0.1375
0.700	-0.1466	-0.1500	-0.0792	-0.1429	-0.3526	-0.0792	-0.1429	-0.3526	-0.0792	-0.1429
0.725	*****	-0.1701	*****	-0.1455	-0.3608	-0.1701	*****	-0.1455	-0.3608	*****
0.750	-0.1338	-0.1839	*****	-0.1537	-0.3552	-0.1839	*****	-0.1537	-0.3552	*****
0.775	*****	-0.1971	-0.1210	-0.1637	-0.3534	-0.1971	-0.1210	-0.1637	-0.3534	*****
0.800	-0.1238	-0.2066	-0.1499	-0.1782	*****	-0.2066	-0.1499	-0.1782	*****	*****
0.825	*****	-0.2074	-0.1792	-0.1891	-0.3759	-0.2074	-0.1792	-0.1891	-0.3759	*****
0.850	-0.0979	-0.2055	-0.2021	-0.2254	-0.4124	-0.2055	-0.2021	-0.2254	-0.4124	-0.2055
0.875	*****	-0.2031	-0.2079	-0.2644	-0.4648	-0.2031	-0.2079	-0.2644	-0.4648	*****
0.900	-0.0647	-0.1843	-0.2168	-0.2859	*****	-0.1843	-0.2168	-0.2859	*****	*****
0.925	*****	-0.1552	-0.2043	-0.2906	-0.8228	-0.1552	-0.2043	-0.2906	-0.8228	*****
0.950	-0.0303	-0.1072	-0.1620	-0.2673	-0.4846	-0.1072	-0.1620	-0.2673	-0.4846	-0.1072
0.975	*****	-0.1843	-0.2099	-0.2096	-0.3293	-0.1843	-0.2099	-0.2096	-0.3293	*****
-0.200	0.0403	0.0500	0.1199	*****	-0.3332	0.0500	0.1199	*****	-0.3332	0.0500
-0.400	0.0233	0.0500	0.0826	-0.0656	-0.4284	0.0500	0.0826	-0.0656	-0.4284	0.0500
-0.600	*****	0.0452	0.0604	-0.0400	-0.6064	0.0452	0.0604	-0.0400	-0.6064	*****
-0.700	*****	0.0267	0.0581	-0.0352	-0.7322	0.0267	0.0581	-0.0352	-0.7322	*****
-0.800	0.0772	0.0316	0.0333	-0.0272	-0.7043	0.0316	0.0333	-0.0272	-0.7043	0.0316
-0.850	0.1083	0.0474	0.0358	-0.0357	-0.7114	0.0474	0.0358	-0.0357	-0.7114	0.0474
-0.900	0.1429	0.0911	0.0558	-0.0221	-0.8155	0.0911	0.0558	-0.0221	-0.8155	0.0911
-0.950	*****	*****	0.1245	0.0429	-0.2721	*****	0.1245	0.0429	-0.2721	*****
-0.975	*****	0.1846	0.1674	0.1073	-0.0897	0.1846	0.1674	0.1073	-0.0897	0.1846

Sharp Radius L.E.
 Run No. = 87, Point No. = 1906
 $C_N = 0.108$, $C_m = -0.0173$
 $\alpha = 3.2^\circ$, $M_\infty = 0.830$
 $R_{mac} = 6.0 \times 10^6$

Surface Pressures Near Leading Edge

● / ◆ upper, starboard/port
 ○ / ◇ lower, starboard/port

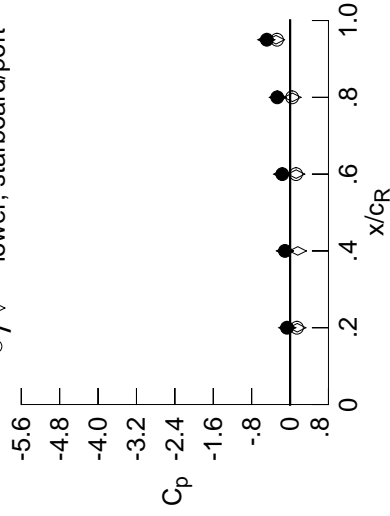

x/c_R	η	starb'd	port	$C_{p,u}$	starb'd	port	$C_{p,l}$
0.20	0.90	-0.0647	-0.0586	0.1497	0.1429	0.1497	0.1429
0.40	0.95	-0.1072	-0.1069	0.1607	0.1607	0.1607	0.1607
0.60	0.95	-0.1620	-0.1648	0.1272	0.1245	0.1272	0.1245
0.80	0.95	-0.2673	-0.2548	0.0490	0.0429	0.0490	0.0429
0.95	0.95	-0.4846	-0.4949	-0.2930	-0.2721	-0.2930	-0.2721

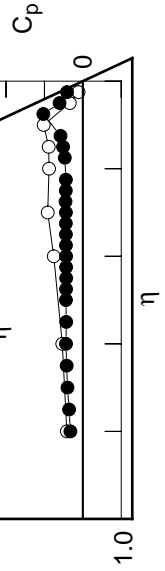

Table D4. Continued.

η	$x/c_R = .2$		$x/c_R = .4$		$x/c_R = .6$		$x/c_R = .8$		$x/c_R = .95$	
	$C_{p,u}$	$C_{p,l}$	$C_{p,u}$	$C_{p,l}$	$C_{p,u}$	$C_{p,l}$	$C_{p,u}$	$C_{p,l}$	$C_{p,u}$	$C_{p,l}$
0.050	-0.0936	-0.0692	0.0718	*****	*****	*****	*****	*****	*****	*****
0.100	-0.0958	-0.0723	0.0624	*****	*****	*****	*****	*****	*****	*****
0.150	-0.1026	-0.0736	0.0482	*****	*****	*****	*****	*****	*****	*****
0.200	-0.1118	-0.0724	0.0321	*****	*****	*****	*****	*****	*****	*****
0.250	*****	-0.0775	0.0192	-0.1788	-0.2861	*****	*****	*****	*****	*****
0.300	-0.1196	-0.0752	0.0050	-0.1654	-0.2834	*****	*****	*****	*****	*****
0.350	-0.1319	-0.0810	-0.0099	-0.1554	-0.3156	*****	*****	*****	*****	*****
0.400	-0.1439	-0.0878	-0.0160	-0.1475	-0.3437	*****	*****	*****	*****	*****
0.450	-0.1591	-0.0985	-0.0240	-0.1425	-0.3416	*****	*****	*****	*****	*****
0.500	-0.1705	-0.1066	-0.0437	-0.1449	-0.3487	*****	*****	*****	*****	*****
0.525	*****	-0.1097	-0.0494	-0.1418	-0.3504	*****	*****	*****	*****	*****
0.550	-0.1814	-0.1149	-0.0571	-0.1449	-0.3487	*****	*****	*****	*****	*****
0.575	*****	-0.1219	-0.0584	-0.1446	-0.3487	*****	*****	*****	*****	*****
0.600	-0.1876	-0.1301	-0.0713	-0.1474	-0.3486	*****	*****	*****	*****	*****
0.625	*****	*****	-0.0770	-0.1525	-0.3520	*****	*****	*****	*****	*****
0.650	-0.1850	-0.1441	-0.0863	-0.1552	-0.3582	*****	*****	*****	*****	*****
0.675	*****	-0.1626	-0.0964	-0.1593	-0.3652	*****	*****	*****	*****	*****
0.700	-0.1802	-0.1835	-0.1059	-0.1667	-0.3690	*****	*****	*****	*****	*****
0.725	*****	-0.2066	*****	-0.1677	-0.3852	*****	*****	*****	*****	*****
0.750	-0.1739	-0.2195	*****	-0.1798	-0.3915	*****	*****	*****	*****	*****
0.775	*****	-0.2384	-0.1509	-0.1916	-0.4090	*****	*****	*****	*****	*****
0.800	-0.1644	-0.2494	-0.1868	-0.2086	*****	*****	*****	*****	*****	*****
0.825	*****	-0.2515	-0.2162	-0.2199	-0.4696	*****	*****	*****	*****	*****
0.850	-0.1409	-0.2521	-0.2433	-0.2605	-0.4084	*****	*****	*****	*****	*****
0.875	*****	-0.2436	-0.2466	-0.3024	-0.4705	*****	*****	*****	*****	*****
0.900	-0.1034	-0.2200	-0.2522	-0.3244	*****	*****	*****	*****	*****	*****
0.925	*****	-0.1939	-0.2336	-0.3258	-0.7913	*****	*****	*****	*****	*****
0.950	-0.0834	-0.2803	-0.3104	-0.3298	-0.5119	*****	*****	*****	*****	*****
0.975	*****	-0.4019	-0.4643	-0.4939	-0.4656	*****	*****	*****	*****	*****
-0.200	0.0598	0.0679	0.1358	*****	-0.3571	*****	*****	*****	*****	*****
-0.400	0.0480	0.0703	0.0976	-0.0470	-0.4615	*****	*****	*****	*****	*****
-0.600	*****	0.0715	0.0801	-0.0244	-0.6339	*****	*****	*****	*****	*****
-0.700	*****	0.0541	0.0765	-0.0147	-0.7267	*****	*****	*****	*****	*****
-0.800	0.1090	0.0648	0.0611	-0.0052	-0.6878	*****	*****	*****	*****	*****
-0.850	0.1379	0.0806	0.0680	-0.0075	-0.6885	*****	*****	*****	*****	*****
-0.900	0.1690	0.1247	0.0932	0.0100	-0.7612	*****	*****	*****	*****	*****
-0.950	*****	*****	0.1546	0.0766	-0.2482	*****	*****	*****	*****	*****
-0.975	*****	0.1988	0.1848	0.1283	-0.0699	*****	*****	*****	*****	*****

Sharp Radius L.E.
 Run No. = 87 , Point No. = 1907
 $C_N = 0.153$, $C_m = -0.0259$
 $\alpha = 4.2^\circ$, $M_\infty = 0.831$
 $R_{mac} = 6.0 \times 10^6$

Surface Pressures Near Leading Edge

● / ◆ upper, starboard/port
 ○ / ◇ lower, starboard/port

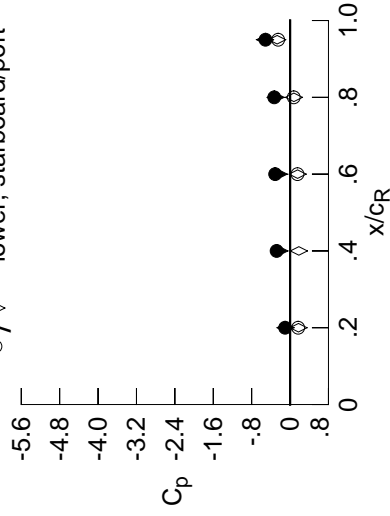

x/c_R	η	starb'd	port	$C_{p,u}$	starb'd	port	$C_{p,l}$
0.20	0.90	-0.1034	-0.0961	0.1749	0.1690	*****	*****
0.40	0.95	-0.2803	-0.2232	0.1834	*****	*****	*****
0.60	0.95	-0.3104	-0.2368	0.1565	0.1546	*****	*****
0.80	0.95	-0.3298	-0.3005	0.0799	0.0766	*****	*****
0.95	0.95	-0.5119	-0.5218	-0.2691	-0.2482	*****	*****

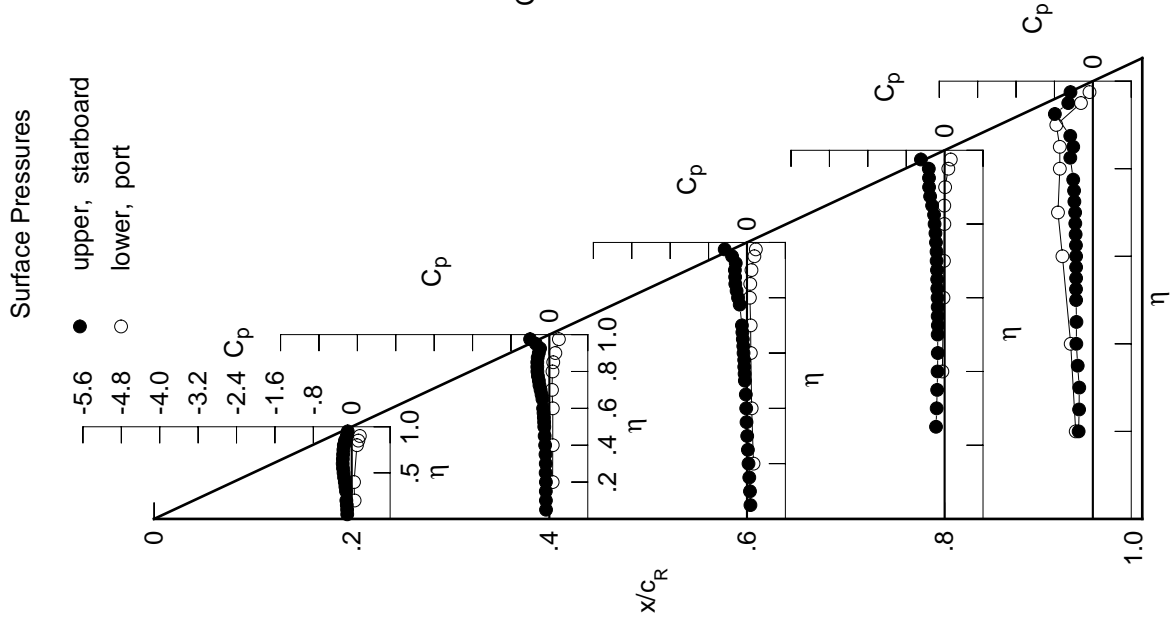

Table D4. Continued.

η	$x/c_R = .2$		$x/c_R = .4$		$x/c_R = .6$		$x/c_R = .8$		$x/c_R = .95$	
	$C_{p,u}$	$C_{p,l}$	$C_{p,u}$	$C_{p,l}$	$C_{p,u}$	$C_{p,l}$	$C_{p,u}$	$C_{p,l}$	$C_{p,u}$	$C_{p,l}$
0.050	-0.1099	-0.0867	0.0603	0.0603	0.0603	0.0603	0.0603	0.0603	0.0603	0.0603
0.100	-0.1135	-0.0876	0.0542	0.0542	0.0542	0.0542	0.0542	0.0542	0.0542	0.0542
0.150	-0.1228	-0.0910	0.0310	0.0310	0.0310	0.0310	0.0310	0.0310	0.0310	0.0310
0.200	-0.1305	-0.0886	0.0211	0.0211	0.0211	0.0211	0.0211	0.0211	0.0211	0.0211
0.250	*****	-0.0939	0.0051	-0.1900	-0.2781	-0.2781	-0.2781	-0.2781	-0.2781	-0.2781
0.300	-0.1403	-0.0977	-0.0085	-0.1767	-0.2845	-0.2845	-0.2845	-0.2845	-0.2845	-0.2845
0.350	-0.1522	-0.0995	-0.0247	-0.1678	-0.3055	-0.3055	-0.3055	-0.3055	-0.3055	-0.3055
0.400	-0.1671	-0.1122	-0.0320	-0.1621	-0.3314	-0.3314	-0.3314	-0.3314	-0.3314	-0.3314
0.450	-0.1831	-0.1210	-0.0396	-0.1565	-0.3282	-0.3282	-0.3282	-0.3282	-0.3282	-0.3282
0.500	-0.1958	-0.1278	-0.0594	-0.1608	-0.3337	-0.3337	-0.3337	-0.3337	-0.3337	-0.3337
0.525	*****	-0.1338	-0.0665	-0.1569	-0.3345	-0.3345	-0.3345	-0.3345	-0.3345	-0.3345
0.550	-0.2104	-0.1405	-0.0753	-0.1600	-0.3399	-0.3399	-0.3399	-0.3399	-0.3399	-0.3399
0.575	*****	-0.1471	-0.0778	-0.1584	-0.3421	-0.3421	-0.3421	-0.3421	-0.3421	-0.3421
0.600	-0.2161	-0.1521	-0.0922	-0.1628	-0.3496	-0.3496	-0.3496	-0.3496	-0.3496	-0.3496
0.625	*****	*****	-0.0972	-0.1695	-0.3613	-0.3613	-0.3613	-0.3613	-0.3613	-0.3613
0.650	-0.2177	-0.1730	-0.1077	-0.1713	-0.3869	-0.3869	-0.3869	-0.3869	-0.3869	-0.3869
0.675	*****	-0.1934	-0.1182	-0.1769	-0.4089	-0.4089	-0.4089	-0.4089	-0.4089	-0.4089
0.700	-0.2153	-0.2092	-0.1289	-0.1797	-0.4309	-0.4309	-0.4309	-0.4309	-0.4309	-0.4309
0.725	*****	-0.2372	*****	-0.1839	-0.4676	-0.4676	-0.4676	-0.4676	-0.4676	-0.4676
0.750	-0.2091	-0.2514	*****	-0.1998	-0.5051	-0.5051	-0.5051	-0.5051	-0.5051	-0.5051
0.775	*****	-0.2716	-0.1760	-0.2143	-0.5500	-0.5500	-0.5500	-0.5500	-0.5500	-0.5500
0.800	-0.1984	-0.2852	-0.2118	-0.2415	*****	*****	*****	*****	*****	*****
0.825	*****	-0.2855	-0.2400	-0.2457	-0.6585	-0.6585	-0.6585	-0.6585	-0.6585	-0.6585
0.850	-0.1673	-0.2784	-0.2599	-0.2976	-0.5148	-0.5148	-0.5148	-0.5148	-0.5148	-0.5148
0.875	*****	-0.2597	-0.2578	-0.3287	-0.7153	-0.7153	-0.7153	-0.7153	-0.7153	-0.7153
0.900	-0.1643	-0.2750	-0.3226	-0.3627	*****	*****	*****	*****	*****	*****
0.925	*****	-0.4063	-0.4528	-0.4764	-0.8808	-0.8808	-0.8808	-0.8808	-0.8808	-0.8808
0.950	-0.1415	-0.5222	-0.5790	-0.5864	-0.5790	-0.5790	-0.5790	-0.5790	-0.5790	-0.5790
0.975	*****	-0.5098	-0.5654	-0.6191	-0.4728	-0.4728	-0.4728	-0.4728	-0.4728	-0.4728

η	$x/c_R = .2$		$x/c_R = .4$		$x/c_R = .6$		$x/c_R = .8$		$x/c_R = .95$	
	$C_{p,u}$	$C_{p,l}$	$C_{p,u}$	$C_{p,l}$	$C_{p,u}$	$C_{p,l}$	$C_{p,u}$	$C_{p,l}$	$C_{p,u}$	$C_{p,l}$
-0.200	0.0826	0.0891	0.1504	0.1504	0.1504	0.1504	0.1504	0.1504	0.1504	0.1504
-0.400	0.0737	0.0921	0.1160	0.1160	0.1160	0.1160	0.1160	0.1160	0.1160	0.1160
-0.600	*****	0.0911	0.0991	-0.0065	-0.6389	-0.6389	-0.6389	-0.6389	-0.6389	-0.6389
-0.700	*****	0.0814	0.0999	-0.0013	-0.7080	-0.7080	-0.7080	-0.7080	-0.7080	-0.7080
-0.800	0.1383	0.0954	0.0869	0.0200	-0.6673	-0.6673	-0.6673	-0.6673	-0.6673	-0.6673
-0.850	0.1659	0.1098	0.0979	0.0172	-0.6652	-0.6652	-0.6652	-0.6652	-0.6652	-0.6652
-0.900	0.1927	0.1560	0.1237	0.0389	-0.7206	-0.7206	-0.7206	-0.7206	-0.7206	-0.7206
-0.950	*****	*****	0.1781	0.1041	-0.2220	-0.2220	-0.2220	-0.2220	-0.2220	-0.2220
-0.975	*****	0.2050	0.1941	0.1422	-0.0469	-0.0469	-0.0469	-0.0469	-0.0469	-0.0469

Sharp Radius L.E.
 Run No. = 87 , Point No. = 1908
 $C_N = 0.201$, $C_m = -0.0360$
 $\alpha = 5.2^\circ$, $M_\infty = 0.830$
 $R_{mac} = 6.0 \times 10^6$

Surface Pressures Near Leading Edge

● / ◆ upper, starboard/port
 ○ / ◇ lower, starboard/port

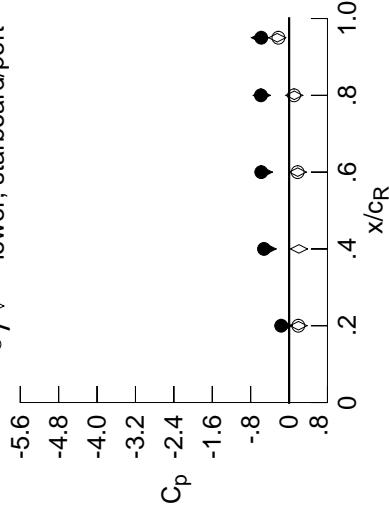

x/c_R	η	starb'd	port	starb'd	port
		$C_{p,u}$	$C_{p,l}$	$C_{p,u}$	$C_{p,l}$
0.20	0.90	-0.1643	-0.1134	0.1958	0.1927
0.40	0.95	-0.5222	-0.4486	0.2055	*****
0.60	0.95	-0.5790	-0.5268	0.1798	0.1781
0.80	0.95	-0.5864	-0.5697	0.1076	0.1041
0.95	0.95	-0.5790	-0.6071	-0.2470	-0.2220

Table D4. Continued.

η	$x/c_R = .2$		$x/c_R = .4$		$x/c_R = .6$		$x/c_R = .8$		$x/c_R = .95$	
	$C_{p,u}$	$C_{p,l}$	$C_{p,u}$	$C_{p,l}$	$C_{p,u}$	$C_{p,l}$	$C_{p,u}$	$C_{p,l}$	$C_{p,u}$	$C_{p,l}$
0.050	-0.1295	-0.1049	0.0477	*****	*****	*****	*****	*****	*****	*****
0.100	-0.1351	-0.1069	0.0358	*****	*****	*****	*****	*****	*****	*****
0.150	-0.1432	-0.1126	0.0216	*****	*****	*****	*****	*****	*****	*****
0.200	-0.1486	-0.1056	0.0034	*****	*****	*****	*****	*****	*****	*****
0.250	*****	-0.1150	-0.0080	-0.2102	-0.2812	*****	*****	*****	*****	*****
0.300	-0.1627	-0.1153	-0.0284	-0.1904	-0.2836	*****	*****	*****	*****	*****
0.350	-0.1758	-0.1208	-0.0442	-0.1858	-0.2875	*****	*****	*****	*****	*****
0.400	-0.1884	-0.1329	-0.0471	-0.1765	-0.2909	*****	*****	*****	*****	*****
0.450	-0.2088	-0.1471	-0.0595	-0.1738	-0.2758	*****	*****	*****	*****	*****
0.500	-0.2236	-0.1521	-0.0735	-0.1767	-0.2841	*****	*****	*****	*****	*****
0.525	*****	-0.1538	-0.0851	-0.1722	-0.3017	*****	*****	*****	*****	*****
0.550	-0.2381	-0.1631	-0.0938	-0.1766	-0.3239	*****	*****	*****	*****	*****
0.575	*****	-0.1721	-0.0965	-0.1726	-0.3573	*****	*****	*****	*****	*****
0.600	-0.2437	-0.1794	-0.1070	-0.1772	-0.4072	*****	*****	*****	*****	*****
0.625	*****	*****	-0.1164	-0.1774	-0.4794	*****	*****	*****	*****	*****
0.650	-0.2466	-0.1956	-0.1254	-0.1761	-0.6132	*****	*****	*****	*****	*****
0.675	*****	-0.2194	-0.1317	-0.1803	-0.6975	*****	*****	*****	*****	*****
0.700	-0.2440	-0.2371	-0.1452	-0.1794	-0.7233	*****	*****	*****	*****	*****
0.725	*****	-0.2646	*****	-0.1724	-0.7165	*****	*****	*****	*****	*****
0.750	-0.2355	-0.2796	*****	-0.1706	-0.7081	*****	*****	*****	*****	*****
0.775	*****	-0.2985	-0.1828	-0.2207	-0.7435	*****	*****	*****	*****	*****
0.800	-0.2121	-0.3012	-0.2184	-0.3534	*****	*****	*****	*****	*****	*****
0.825	*****	-0.2988	-0.2636	-0.4475	-0.8297	*****	*****	*****	*****	*****
0.850	-0.1936	-0.3111	-0.3760	-0.5452	-0.6598	*****	*****	*****	*****	*****
0.875	*****	-0.3892	-0.5222	-0.5921	-0.7368	*****	*****	*****	*****	*****
0.900	-0.3861	-0.5566	-0.6242	-0.6058	*****	*****	*****	*****	*****	*****
0.925	*****	-0.6375	-0.6572	-0.6057	-0.6114	*****	*****	*****	*****	*****
0.950	-0.2575	-0.6379	-0.6373	-0.5927	-0.4797	*****	*****	*****	*****	*****
0.975	*****	-0.6161	-0.6188	-0.5849	-0.4044	*****	*****	*****	*****	*****
-0.200	$C_{p,l}$	0.1079	0.1066	0.1686	*****	-0.3891	*****	*****	*****	*****
-0.400	0.0995	0.1144	0.1307	-0.0192	-0.5208	*****	*****	*****	*****	*****
-0.600	*****	0.1143	0.1197	0.0086	-0.6234	*****	*****	*****	*****	*****
-0.700	*****	0.1085	0.1191	0.0210	-0.6741	*****	*****	*****	*****	*****
-0.800	0.1670	0.1229	0.1125	0.0389	-0.6443	*****	*****	*****	*****	*****
-0.850	0.1900	0.1399	0.1277	0.0419	-0.6382	*****	*****	*****	*****	*****
-0.900	0.2139	0.1825	0.1529	0.0670	-0.6786	*****	*****	*****	*****	*****
-0.950	*****	*****	0.1951	0.1262	-0.2036	*****	*****	*****	*****	*****
-0.975	*****	0.2058	0.1976	0.1505	-0.0351	*****	*****	*****	*****	*****

Sharp Radius L.E.
 Run No. = 87 , Point No. = 1909
 $C_N = 0.253$, $C_m = -0.0448$
 $\alpha = 6.3^\circ$, $M_\infty = 0.830$
 $R_{mac} = 6.0 \times 10^6$

Surface Pressures Near Leading Edge

● / ◆ upper, starboard/port
 ○ / ◇ lower, starboard/port

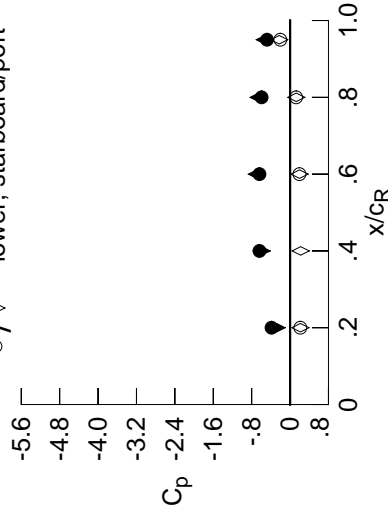

x/c_R	η	starb'd	port	starb'd	port
		$C_{p,u}$	$C_{p,l}$	$C_{p,u}$	$C_{p,l}$
0.20	0.90	-0.3861	-0.2789	0.2154	0.2139
0.40	0.95	-0.6379	-0.5924	0.2205	*****
0.60	0.95	-0.6373	-0.6925	0.1978	0.1951
0.80	0.95	-0.5927	-0.6567	0.1288	0.1262
0.95	0.95	-0.4797	-0.5287	-0.2259	-0.2036

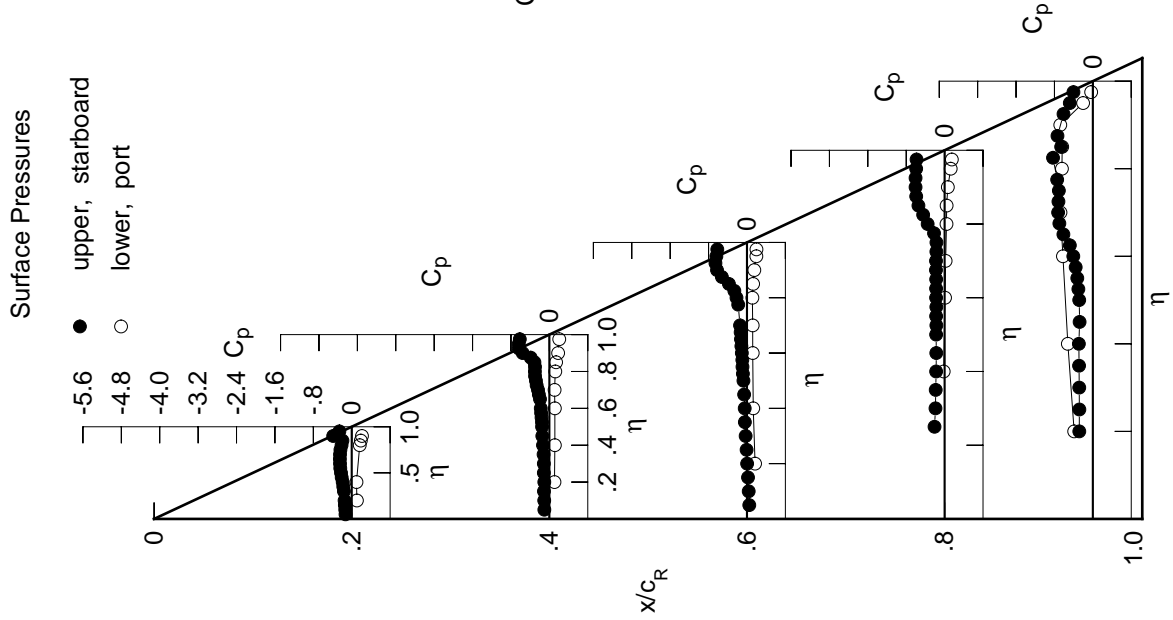

Table D4. Continued.

η	$x/c_R = .2$		$x/c_R = .4$		$x/c_R = .6$		$x/c_R = .8$		$x/c_R = .95$	
	$C_{p,u}$	$C_{p,l}$	$C_{p,u}$	$C_{p,l}$	$C_{p,u}$	$C_{p,l}$	$C_{p,u}$	$C_{p,l}$	$C_{p,u}$	$C_{p,l}$
0.050	-0.1495	-0.1253	0.0300	0.0300	0.0300	0.0300	0.0300	0.0300	0.0300	0.0300
0.100	-0.1538	-0.1250	0.0205	0.0205	0.0205	0.0205	0.0205	0.0205	0.0205	0.0205
0.150	-0.1645	-0.1318	0.0028	0.0028	0.0028	0.0028	0.0028	0.0028	0.0028	0.0028
0.200	-0.1695	-0.1275	-0.0113	-0.0113	-0.0113	-0.0113	-0.0113	-0.0113	-0.0113	-0.0113
0.250	*****	-0.1356	-0.0270	-0.2234	-0.2234	-0.2234	-0.2234	-0.2234	-0.2234	-0.2234
0.300	-0.1829	-0.1376	-0.0505	-0.2154	-0.2154	-0.2154	-0.2154	-0.2154	-0.2154	-0.2154
0.350	-0.1982	-0.1432	-0.0627	-0.2020	-0.2020	-0.2020	-0.2020	-0.2020	-0.2020	-0.2020
0.400	-0.2123	-0.1589	-0.0663	-0.1964	-0.1964	-0.1964	-0.1964	-0.1964	-0.1964	-0.1964
0.450	-0.2324	-0.1702	-0.0760	-0.1883	-0.1883	-0.1883	-0.1883	-0.1883	-0.1883	-0.1883
0.500	-0.2489	-0.1777	-0.0956	-0.1896	-0.1896	-0.1896	-0.1896	-0.1896	-0.1896	-0.1896
0.525	*****	-0.1742	-0.1008	-0.1849	-0.1849	-0.1849	-0.1849	-0.1849	-0.1849	-0.1849
0.550	-0.2641	-0.1840	-0.1093	-0.1841	-0.1841	-0.1841	-0.1841	-0.1841	-0.1841	-0.1841
0.575	*****	-0.1930	-0.1075	-0.1851	-0.1851	-0.1851	-0.1851	-0.1851	-0.1851	-0.1851
0.600	-0.2698	-0.2023	-0.1210	-0.1797	-0.1797	-0.1797	-0.1797	-0.1797	-0.1797	-0.1797
0.625	*****	*****	-0.1256	-0.1819	-0.1819	-0.1819	-0.1819	-0.1819	-0.1819	-0.1819
0.650	-0.2711	-0.2196	-0.1377	-0.1742	-0.1742	-0.1742	-0.1742	-0.1742	-0.1742	-0.1742
0.675	*****	-0.2391	-0.1406	-0.1655	-0.1655	-0.1655	-0.1655	-0.1655	-0.1655	-0.1655
0.700	-0.2671	-0.2601	-0.1360	-0.1473	-0.1473	-0.1473	-0.1473	-0.1473	-0.1473	-0.1473
0.725	*****	-0.2818	*****	-0.1275	-0.1275	-0.1275	-0.1275	-0.1275	-0.1275	-0.1275
0.750	-0.2409	-0.2907	*****	-0.2479	-0.2479	-0.2479	-0.2479	-0.2479	-0.2479	-0.2479
0.775	*****	-0.2926	-0.2182	-0.5574	-0.5574	-0.5574	-0.5574	-0.5574	-0.5574	-0.5574
0.800	-0.2257	-0.3108	-0.4769	-0.7120	-0.7120	-0.7120	-0.7120	-0.7120	-0.7120	-0.7120
0.825	*****	-0.4102	-0.6440	-0.7488	-0.7488	-0.7488	-0.7488	-0.7488	-0.7488	-0.7488
0.850	-0.3805	-0.5558	-0.7161	-0.7309	-0.7309	-0.7309	-0.7309	-0.7309	-0.7309	-0.7309
0.875	*****	-0.6769	-0.7014	-0.6760	-0.6999	-0.6999	-0.6999	-0.6999	-0.6999	-0.6999
0.900	-0.5182	-0.7421	-0.7032	-0.6202	*****	*****	*****	*****	*****	*****
0.925	*****	-0.7397	-0.6804	-0.5985	-0.6536	-0.6536	-0.6536	-0.6536	-0.6536	-0.6536
0.950	-0.4159	-0.7190	-0.6559	-0.5834	-0.5718	-0.5718	-0.5718	-0.5718	-0.5718	-0.5718
0.975	*****	-0.7123	-0.6495	-0.5790	-0.4888	-0.4888	-0.4888	-0.4888	-0.4888	-0.4888
-0.200	$C_{p,l}$	0.1262	0.1286	0.1839	*****	0.1839	0.1839	0.1839	0.1839	0.1839
-0.400	0.1191	0.1334	0.1486	-0.0044	-0.5436	-0.5436	-0.5436	-0.5436	-0.5436	-0.5436
-0.600	*****	0.1384	0.1399	0.0244	-0.6012	-0.6012	-0.6012	-0.6012	-0.6012	-0.6012
-0.700	*****	0.1360	0.1403	0.0378	-0.6212	-0.6212	-0.6212	-0.6212	-0.6212	-0.6212
-0.800	0.1922	0.1498	0.1365	0.0583	-0.6167	-0.6167	-0.6167	-0.6167	-0.6167	-0.6167
-0.850	0.2129	0.1651	0.1520	0.0631	-0.6133	-0.6133	-0.6133	-0.6133	-0.6133	-0.6133
-0.900	0.2310	0.2057	0.1776	0.0917	-0.6374	-0.6374	-0.6374	-0.6374	-0.6374	-0.6374
-0.950	*****	*****	0.2102	0.1408	-0.1887	-0.1887	-0.1887	-0.1887	-0.1887	-0.1887
-0.975	*****	0.2050	0.2004	0.1566	-0.0286	-0.0286	-0.0286	-0.0286	-0.0286	-0.0286

Sharp Radius L.E.
 Run No. = 87 , Point No. = 1910
 $C_N = 0.306$, $C_m = -0.0555$
 $\alpha = 7.3^\circ$, $M_\infty = 0.830$
 $R_{mac} = 6.0 \times 10^6$

Surface Pressures Near Leading Edge

● / ◆ upper, starboard/port
 ○ / ◇ lower, starboard/port

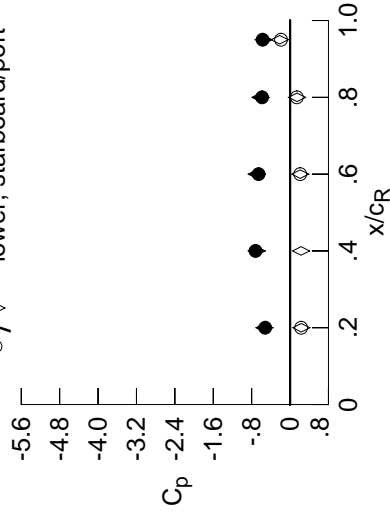

x/c_R	η	starb'd	port	starb'd	port
		$C_{p,u}$	$C_{p,l}$	$C_{p,u}$	$C_{p,l}$
0.20	0.90	-0.5182	-0.5354	0.2332	0.2310
0.40	0.95	-0.7190	-0.6950	0.2289	*****
0.60	0.95	-0.6559	-0.6955	0.2115	0.2102
0.80	0.95	-0.5834	-0.6173	0.1448	0.1408
0.95	0.95	-0.5718	-0.5516	-0.2150	-0.1887

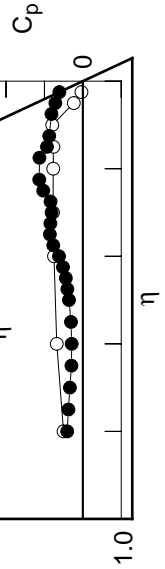

Table D4. Continued.

η	$x/c_R = .2$		$x/c_R = .4$		$x/c_R = .6$		$x/c_R = .8$		$x/c_R = .95$	
	$C_{p,u}$	$C_{p,l}$	$C_{p,u}$	$C_{p,l}$	$C_{p,u}$	$C_{p,l}$	$C_{p,u}$	$C_{p,l}$	$C_{p,u}$	$C_{p,l}$
0.050	-0.1680	-0.1431	0.0115	*****	*****	*****	*****	*****	*****	*****
0.100	-0.1751	-0.1490	0.0015	*****	*****	*****	*****	*****	*****	*****
0.150	-0.1819	-0.1512	-0.0127	*****	*****	*****	*****	*****	*****	*****
0.200	-0.1925	-0.1493	-0.0318	*****	*****	*****	*****	*****	*****	*****
0.250	*****	-0.1568	-0.0440	-0.2416	-0.3101	*****	*****	*****	*****	*****
0.300	-0.2021	-0.1612	-0.0744	-0.2359	-0.2267	*****	*****	*****	*****	*****
0.350	-0.2187	-0.1681	-0.0827	-0.2157	-0.1876	*****	*****	*****	*****	*****
0.400	-0.2346	-0.1812	-0.0867	-0.2075	-0.2041	*****	*****	*****	*****	*****
0.450	-0.2558	-0.2031	-0.0930	-0.1994	-0.2649	*****	*****	*****	*****	*****
0.500	-0.2718	-0.2017	-0.1092	-0.1985	-0.3470	*****	*****	*****	*****	*****
0.525	*****	-0.2040	-0.1166	-0.1939	-0.3920	*****	*****	*****	*****	*****
0.550	-0.2872	-0.2033	-0.1209	-0.1944	-0.4473	*****	*****	*****	*****	*****
0.575	*****	-0.2125	-0.1246	-0.1879	-0.5337	*****	*****	*****	*****	*****
0.600	-0.2916	-0.2220	-0.1284	-0.1832	-0.6097	*****	*****	*****	*****	*****
0.625	*****	*****	-0.1282	-0.1723	-0.6401	*****	*****	*****	*****	*****
0.650	-0.2889	-0.2400	-0.1293	-0.1579	-0.6299	*****	*****	*****	*****	*****
0.675	*****	-0.2563	-0.1267	-0.1428	-0.5936	*****	*****	*****	*****	*****
0.700	-0.2685	-0.2683	-0.1017	-0.1563	-0.6346	*****	*****	*****	*****	*****
0.725	*****	-0.2708	*****	-0.3123	-0.7903	*****	*****	*****	*****	*****
0.750	-0.2431	-0.2729	*****	-0.6258	-0.9314	*****	*****	*****	*****	*****
0.775	*****	-0.3588	-0.6955	-0.8253	-0.9786	*****	*****	*****	*****	*****
0.800	-0.3977	-0.5491	-0.8408	-0.8798	*****	*****	*****	*****	*****	*****
0.825	*****	-0.7090	-0.8518	-0.8798	-0.7262	*****	*****	*****	*****	*****
0.850	-0.6007	-0.7950	-0.8239	-0.8046	-0.6979	*****	*****	*****	*****	*****
0.875	*****	-0.8368	-0.7472	-0.6885	-0.6070	*****	*****	*****	*****	*****
0.900	-0.5894	-0.8366	-0.7185	-0.6425	*****	*****	*****	*****	*****	*****
0.925	*****	-0.8127	-0.6949	-0.6101	-0.6072	*****	*****	*****	*****	*****
0.950	-0.5734	-0.7919	-0.6724	-0.5927	-0.5431	*****	*****	*****	*****	*****
0.975	*****	-0.7922	-0.6657	-0.5865	-0.4800	*****	*****	*****	*****	*****
-0.200	$C_{p,l}$	0.1506	0.1524	0.1988	*****	*****	*****	*****	*****	*****
-0.400	$C_{p,l}$	0.1395	0.1551	0.1672	0.0084	-0.5973	*****	*****	*****	*****
-0.600	*****	*****	0.1647	0.1580	0.0399	-0.6105	*****	*****	*****	*****
-0.700	*****	*****	0.1613	0.1643	0.0526	-0.6599	*****	*****	*****	*****
-0.800	$C_{p,l}$	0.2168	0.1809	0.1600	0.0754	-0.6121	*****	*****	*****	*****
-0.850	$C_{p,l}$	0.2328	0.1914	0.1762	0.0820	-0.6021	*****	*****	*****	*****
-0.900	$C_{p,l}$	0.2464	0.2277	0.2004	0.1102	-0.6074	*****	*****	*****	*****
-0.950	*****	*****	*****	0.2217	0.1533	-0.1783	*****	*****	*****	*****
-0.975	*****	*****	0.2005	0.2025	0.1582	-0.0248	*****	*****	*****	*****

Sharp Radius L.E.

Run No. = 87, Point No. = 1911

$C_N = 0.359$, $C_m = -0.0639$

$\alpha = 8.5^\circ$, $M_\infty = 0.831$

$R_{mac} = 6.0 \times 10^6$

Surface Pressures Near Leading Edge

● / ◆ upper, starboard/port
○ / ◇ lower, starboard/port

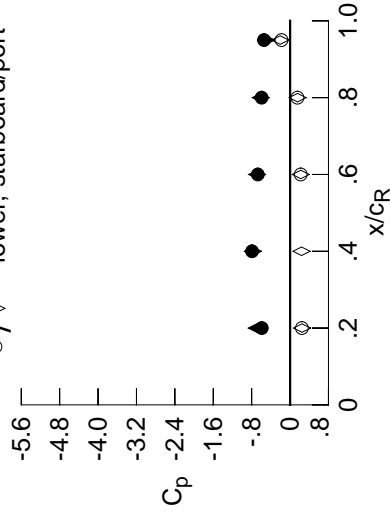

x/c_R	η	$C_{p,u}$ starb'd	$C_{p,u}$ port	$C_{p,l}$ starb'd	$C_{p,l}$ port
0.20	0.90	-0.5894	-0.6939	0.2487	0.2464
0.40	0.95	-0.7919	-0.7740	0.2393	*****
0.60	0.95	-0.6724	-0.6864	0.2230	0.2217
0.80	0.95	-0.5927	-0.6119	0.1560	0.1533
0.95	0.95	-0.5431	-0.4988	-0.2056	-0.1783

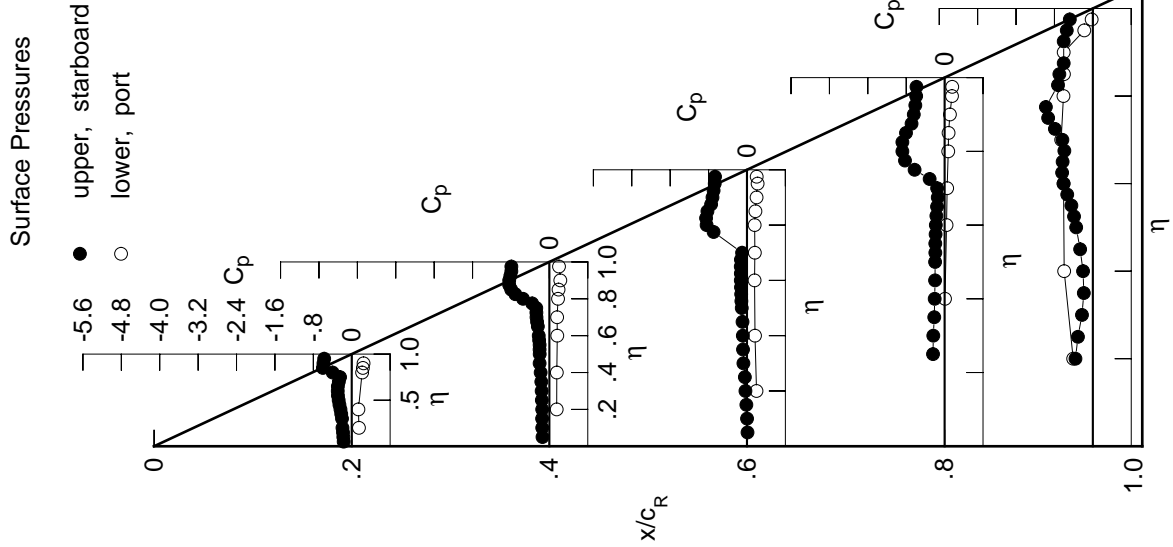

Table D4. Continued.

η	$x/c_R = .2$		$x/c_R = .4$		$x/c_R = .6$		$x/c_R = .8$		$x/c_R = .95$	
	$C_{p,u}$	$C_{p,u}$	$C_{p,u}$	$C_{p,u}$	$C_{p,u}$	$C_{p,u}$	$C_{p,u}$	$C_{p,u}$	$C_{p,u}$	$C_{p,u}$
0.050	-0.1877	-0.1696	-0.0085	*****	*****	*****	*****	*****	*****	*****
0.100	-0.1953	-0.1740	-0.0192	*****	*****	*****	*****	*****	*****	*****
0.150	-0.2040	-0.1769	-0.0327	*****	*****	*****	*****	*****	*****	*****
0.200	-0.2139	-0.1765	-0.0512	*****	*****	*****	*****	*****	*****	*****
0.250	*****	-0.1840	-0.0625	-0.2593	-0.2943	*****	*****	*****	*****	*****
0.300	-0.2252	-0.1871	-0.0916	-0.2525	-0.2080	*****	*****	*****	*****	*****
0.350	-0.2415	-0.1916	-0.1081	-0.2307	-0.1955	*****	*****	*****	*****	*****
0.400	-0.2577	-0.2014	-0.1066	-0.2199	-0.2252	*****	*****	*****	*****	*****
0.450	-0.2800	-0.2394	-0.1082	-0.2104	-0.3035	*****	*****	*****	*****	*****
0.500	-0.2970	-0.2326	-0.1268	-0.2074	-0.4103	*****	*****	*****	*****	*****
0.525	*****	-0.2313	-0.1315	-0.2010	-0.4718	*****	*****	*****	*****	*****
0.550	-0.3111	-0.2334	-0.1359	-0.1968	-0.5290	*****	*****	*****	*****	*****
0.575	*****	-0.2338	-0.1321	-0.1862	-0.5851	*****	*****	*****	*****	*****
0.600	-0.3097	-0.2375	-0.1350	-0.1785	-0.6040	*****	*****	*****	*****	*****
0.625	*****	*****	-0.1252	-0.1695	-0.6019	*****	*****	*****	*****	*****
0.650	-0.2868	-0.2376	-0.1146	-0.1651	-0.6088	*****	*****	*****	*****	*****
0.675	*****	-0.2480	-0.1081	-0.2091	-0.6585	*****	*****	*****	*****	*****
0.700	-0.2573	-0.2539	-0.1573	-0.3813	-0.7969	*****	*****	*****	*****	*****
0.725	*****	-0.2944	*****	-0.6665	-0.9440	*****	*****	*****	*****	*****
0.750	-0.3945	-0.4780	*****	-0.8883	-1.0215	*****	*****	*****	*****	*****
0.775	*****	-0.7299	-0.9534	-0.9819	-0.8190	*****	*****	*****	*****	*****
0.800	-0.6389	-0.8496	-0.9890	-0.9739	*****	*****	*****	*****	*****	*****
0.825	*****	-0.8999	-0.9505	-0.8514	-0.5713	*****	*****	*****	*****	*****
0.850	-0.7290	-0.9112	-0.8904	-0.7309	-0.6284	*****	*****	*****	*****	*****
0.875	*****	-0.9069	-0.7742	-0.7068	-0.5613	*****	*****	*****	*****	*****
0.900	-0.6613	-0.8877	-0.7386	-0.6729	*****	*****	*****	*****	*****	*****
0.925	*****	-0.8653	-0.7121	-0.6312	-0.5505	*****	*****	*****	*****	*****
0.950	-0.7091	-0.8488	-0.6901	-0.6270	-0.4831	*****	*****	*****	*****	*****
0.975	*****	-0.8506	-0.6777	-0.6196	-0.4160	*****	*****	*****	*****	*****

η	$C_{p,i}$		$C_{p,i}$		$C_{p,i}$		$C_{p,i}$		$C_{p,i}$	
	$C_{p,i}$	$C_{p,i}$	$C_{p,i}$	$C_{p,i}$	$C_{p,i}$	$C_{p,i}$	$C_{p,i}$	$C_{p,i}$	$C_{p,i}$	$C_{p,i}$
-0.200	0.1739	0.1721	0.2146	*****	-0.4381	*****	*****	*****	*****	*****
-0.400	0.1652	0.1788	0.1825	0.0212	-0.6304	*****	*****	*****	*****	*****
-0.600	*****	0.1878	0.1747	0.0538	-0.6492	*****	*****	*****	*****	*****
-0.700	*****	0.1851	0.1823	0.0686	-0.6672	*****	*****	*****	*****	*****
-0.800	0.2414	0.2089	0.1812	0.0908	-0.6037	*****	*****	*****	*****	*****
-0.850	0.2528	0.2132	0.1985	0.0988	-0.5899	*****	*****	*****	*****	*****
-0.900	0.2602	0.2473	0.2209	0.1245	-0.5850	*****	*****	*****	*****	*****
-0.950	*****	*****	0.2301	0.1642	-0.1711	*****	*****	*****	*****	*****
-0.975	*****	0.1948	0.1983	0.1581	-0.0229	*****	*****	*****	*****	*****

Sharp Radius L.E.
 Run No. = 87 , Point No. = 1912
 $C_N = 0.408$, $C_m = -0.0691$
 $\alpha = 9.4^\circ$, $M_\infty = 0.831$
 $R_{mac} = 6.0 \times 10^6$

Surface Pressures Near Leading Edge

● / ◆ upper, starboard/port
 ○ / ◇ lower, starboard/port

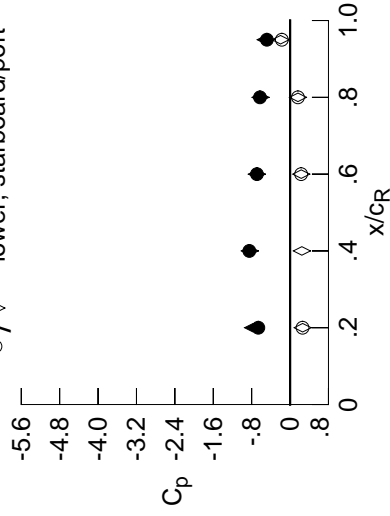

x/c_R	η	starb'd	port	starb'd	port
x/c_R	η	$C_{p,u}$	$C_{p,u}$	$C_{p,l}$	$C_{p,l}$
0.20	0.90	-0.6613	-0.7708	0.2623	0.2602
0.40	0.95	-0.8488	-0.8384	0.2456	*****
0.60	0.95	-0.6901	-0.6932	0.2330	0.2301
0.80	0.95	-0.6270	-0.6160	0.1649	0.1642
0.95	0.95	-0.4831	-0.5084	-0.1980	-0.1711

Table D4. Continued.

η	$x/c_R = .2$		$x/c_R = .4$		$x/c_R = .6$		$x/c_R = .8$		$x/c_R = .95$	
	$C_{p,u}$	$C_{p,l}$	$C_{p,u}$	$C_{p,l}$	$C_{p,u}$	$C_{p,l}$	$C_{p,u}$	$C_{p,l}$	$C_{p,u}$	$C_{p,l}$
0.050	-0.2098	-0.1919	-0.0282	*****	*****	*****	*****	*****	*****	*****
0.100	-0.2172	-0.1999	-0.0353	*****	*****	*****	*****	*****	*****	*****
0.150	-0.2232	-0.2009	-0.0530	*****	*****	*****	*****	*****	*****	*****
0.200	-0.2337	-0.2016	-0.0663	*****	*****	*****	*****	*****	*****	*****
0.250	*****	-0.2051	-0.0792	-0.2674	-0.2359	*****	*****	*****	*****	*****
0.300	-0.2457	-0.2068	-0.0997	-0.2597	-0.2301	*****	*****	*****	*****	*****
0.350	-0.2620	-0.2106	-0.1265	-0.2393	-0.2274	*****	*****	*****	*****	*****
0.400	-0.2785	-0.2140	-0.1234	-0.2279	-0.2793	*****	*****	*****	*****	*****
0.450	-0.3008	-0.2547	-0.1225	-0.2186	-0.3705	*****	*****	*****	*****	*****
0.500	-0.3149	-0.2603	-0.1394	-0.2113	-0.4791	*****	*****	*****	*****	*****
0.525	*****	-0.2614	-0.1388	-0.2056	-0.5275	*****	*****	*****	*****	*****
0.550	-0.3240	-0.2567	-0.1419	-0.1977	-0.5551	*****	*****	*****	*****	*****
0.575	*****	-0.2546	-0.1291	-0.1925	-0.5824	*****	*****	*****	*****	*****
0.600	-0.3061	-0.2418	-0.1298	-0.1884	-0.5922	*****	*****	*****	*****	*****
0.625	*****	*****	-0.1178	-0.2057	-0.6268	*****	*****	*****	*****	*****
0.650	-0.2654	-0.2117	-0.1335	-0.2696	-0.7120	*****	*****	*****	*****	*****
0.675	*****	-0.2178	-0.2485	-0.4386	-0.8300	*****	*****	*****	*****	*****
0.700	-0.3680	-0.3899	-0.5306	-0.6915	-0.9580	*****	*****	*****	*****	*****
0.725	*****	-0.7324	*****	-0.9240	-1.0277	*****	*****	*****	*****	*****
0.750	-0.6715	-0.9303	*****	-1.0574	-0.7422	*****	*****	*****	*****	*****
0.775	*****	-1.0070	-1.0868	-1.0223	-0.5819	*****	*****	*****	*****	*****
0.800	-0.8101	-1.0135	-1.0867	-0.8022	*****	*****	*****	*****	*****	*****
0.825	*****	-0.9994	-1.0235	-0.7104	-0.5290	*****	*****	*****	*****	*****
0.850	-0.8157	-0.9759	-0.8995	-0.7153	-0.5595	*****	*****	*****	*****	*****
0.875	*****	-0.9480	-0.7816	-0.7230	-0.5201	*****	*****	*****	*****	*****
0.900	-0.7387	-0.9183	-0.7702	-0.6774	*****	*****	*****	*****	*****	*****
0.925	*****	-0.8960	-0.7338	-0.6763	-0.4830	*****	*****	*****	*****	*****
0.950	-0.8163	-0.8826	-0.7006	-0.6762	-0.4115	*****	*****	*****	*****	*****
0.975	*****	-0.8808	-0.6868	-0.6647	-0.3628	*****	*****	*****	*****	*****
-0.200	0.2032	0.1979	0.2317	*****	-0.4534	*****	*****	*****	*****	*****
-0.400	0.1958	0.2027	0.2041	0.0366	-0.6487	*****	*****	*****	*****	*****
-0.600	*****	0.2130	0.1954	0.0698	-0.6772	*****	*****	*****	*****	*****
-0.700	*****	0.2138	0.2023	0.0827	-0.6665	*****	*****	*****	*****	*****
-0.800	0.2674	0.2362	0.2040	0.1068	-0.5940	*****	*****	*****	*****	*****
-0.850	0.2750	0.2385	0.2199	0.1174	-0.5776	*****	*****	*****	*****	*****
-0.900	0.2761	0.2655	0.2416	0.1431	-0.5636	*****	*****	*****	*****	*****
-0.950	*****	*****	0.2401	0.1731	-0.1586	*****	*****	*****	*****	*****
-0.975	*****	0.1897	0.1968	0.1565	-0.0182	*****	*****	*****	*****	*****

Sharp Radius L.E.
 Run No. = 87 , Point No. = 1913
 $C_N = 0.462$, $C_m = -0.0784$
 $\alpha = 10.4^\circ$, $M_\infty = 0.830$
 $R_{mac} = 6.0 \times 10^6$

Surface Pressures Near Leading Edge

● / ◆ upper, starboard/port
 ○ / ◇ lower, starboard/port

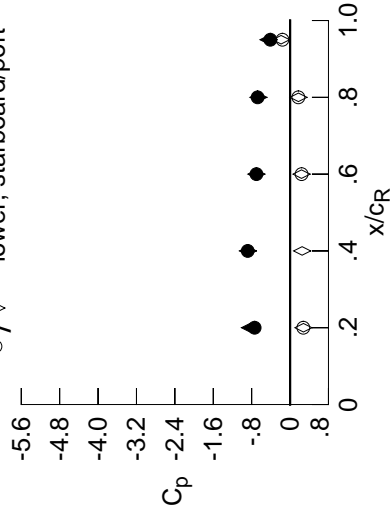

x/c_R	η	starb'd	port	starb'd	port
		$C_{p,u}$	$C_{p,l}$	$C_{p,u}$	$C_{p,l}$
0.20	0.90	-0.7387	-0.8361	0.2783	0.2761
0.40	0.95	-0.8826	-0.8782	0.2509	*****
0.60	0.95	-0.7006	-0.7028	0.2386	0.2401
0.80	0.95	-0.6762	-0.6599	0.1747	0.1731
0.95	0.95	-0.4115	-0.4497	-0.1872	-0.1586

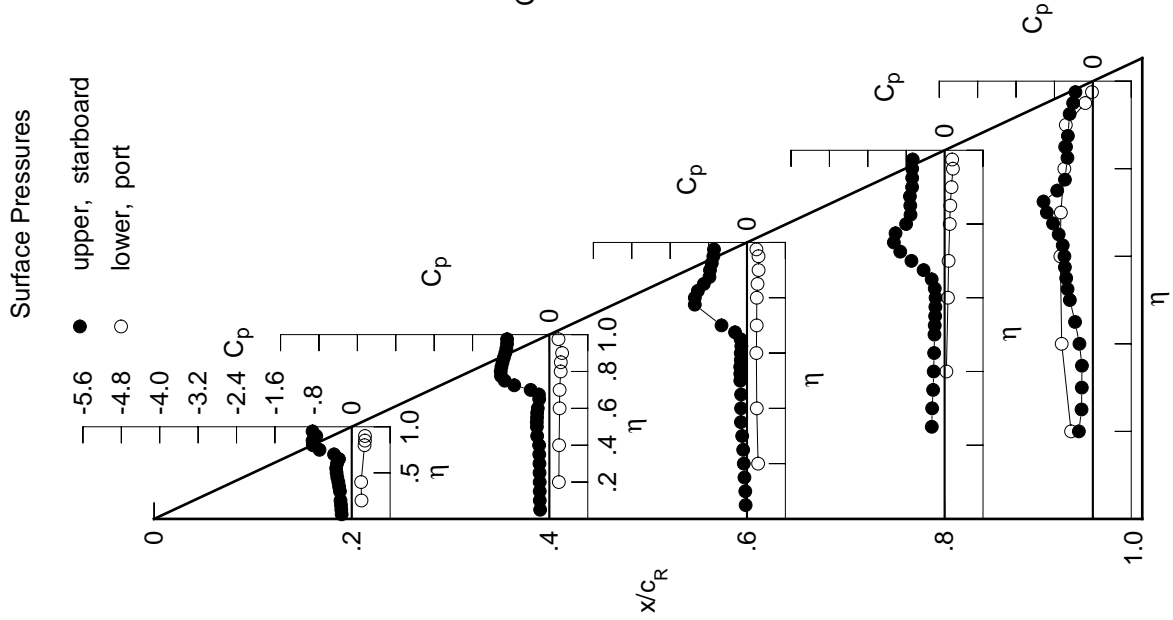

Table D4. Continued.

η	$x/c_R = .2$		$x/c_R = .4$		$x/c_R = .6$		$x/c_R = .8$		$x/c_R = .95$	
	$C_{p,u}$	$C_{p,l}$	$C_{p,u}$	$C_{p,l}$	$C_{p,u}$	$C_{p,l}$	$C_{p,u}$	$C_{p,l}$	$C_{p,u}$	$C_{p,l}$
0.050	-0.2337	-0.2238	-0.0449	*****	*****	*****	*****	*****	*****	*****
0.100	-0.2387	-0.2242	-0.0555	*****	*****	*****	*****	*****	*****	*****
0.150	-0.2479	-0.2317	-0.0686	*****	*****	*****	*****	*****	*****	*****
0.200	-0.2561	-0.2248	-0.0844	*****	*****	*****	*****	*****	*****	*****
0.250	*****	-0.2348	-0.0946	-0.2848	-0.1656	*****	*****	*****	*****	*****
0.300	-0.2697	-0.2323	-0.1129	-0.2707	-0.2606	*****	*****	*****	*****	*****
0.350	-0.2872	-0.2366	-0.1349	-0.2579	-0.3268	*****	*****	*****	*****	*****
0.400	-0.3018	-0.2347	-0.1390	-0.2439	-0.4087	*****	*****	*****	*****	*****
0.450	-0.3235	-0.2584	-0.1396	-0.2342	-0.5052	*****	*****	*****	*****	*****
0.500	-0.3324	-0.2799	-0.1488	-0.2261	-0.5731	*****	*****	*****	*****	*****
0.525	*****	-0.2743	-0.1473	-0.2232	-0.6021	*****	*****	*****	*****	*****
0.550	-0.3275	-0.2737	-0.1439	-0.2240	-0.6036	*****	*****	*****	*****	*****
0.575	*****	-0.2611	-0.1369	-0.2313	-0.6378	*****	*****	*****	*****	*****
0.600	-0.2773	-0.2466	-0.1504	-0.2662	-0.6825	*****	*****	*****	*****	*****
0.625	*****	*****	-0.1831	-0.3518	-0.7767	*****	*****	*****	*****	*****
0.650	-0.2625	-0.3153	-0.3229	-0.5073	-0.8980	*****	*****	*****	*****	*****
0.675	*****	-0.5970	-0.6005	-0.7320	-0.9952	*****	*****	*****	*****	*****
0.700	-0.6565	-0.9128	-0.9069	-0.9490	-1.0482	*****	*****	*****	*****	*****
0.725	*****	-1.0748	*****	-1.1070	-0.7247	*****	*****	*****	*****	*****
0.750	-0.8973	-1.1155	*****	-0.9818	-0.5850	*****	*****	*****	*****	*****
0.775	*****	-1.1033	-1.1832	-0.7865	-0.5240	*****	*****	*****	*****	*****
0.800	-0.9224	-1.0774	-1.1187	-0.7259	*****	*****	*****	*****	*****	*****
0.825	*****	-1.0476	-0.9305	-0.7275	-0.5113	*****	*****	*****	*****	*****
0.850	-0.8955	-1.0142	-0.8574	-0.7401	-0.5192	*****	*****	*****	*****	*****
0.875	*****	-0.9681	-0.8143	-0.7275	-0.4836	*****	*****	*****	*****	*****
0.900	-0.8159	-0.9390	-0.8120	-0.7169	*****	*****	*****	*****	*****	*****
0.925	*****	-0.9148	-0.7592	-0.7257	-0.4385	*****	*****	*****	*****	*****
0.950	-0.9033	-0.9036	-0.7285	-0.7177	-0.3727	*****	*****	*****	*****	*****
0.975	*****	-0.9016	-0.7160	-0.7034	-0.3408	*****	*****	*****	*****	*****

η	$x/c_R = .2$		$x/c_R = .4$		$x/c_R = .6$		$x/c_R = .8$		$x/c_R = .95$	
	$C_{p,u}$	$C_{p,l}$	$C_{p,u}$	$C_{p,l}$	$C_{p,u}$	$C_{p,l}$	$C_{p,u}$	$C_{p,l}$	$C_{p,u}$	$C_{p,l}$
-0.200	0.2294	0.2200	0.2504	*****	-0.4971	*****	*****	*****	*****	*****
-0.400	0.2236	0.2263	0.2183	0.0523	-0.6653	*****	*****	*****	*****	*****
-0.600	*****	0.2355	0.2161	0.0822	-0.6863	*****	*****	*****	*****	*****
-0.700	*****	0.2384	0.2177	0.0975	-0.6593	*****	*****	*****	*****	*****
-0.800	0.2920	0.2555	0.2226	0.1238	-0.5889	*****	*****	*****	*****	*****
-0.850	0.2949	0.2582	0.2396	0.1330	-0.5670	*****	*****	*****	*****	*****
-0.900	0.2905	0.2810	0.2565	0.1577	-0.5460	*****	*****	*****	*****	*****
-0.950	*****	*****	0.2450	0.1794	-0.1534	*****	*****	*****	*****	*****
-0.975	*****	0.1848	0.1894	0.1499	-0.0200	*****	*****	*****	*****	*****

Sharp Radius L.E.
 Run No. = 87, Point No. = 1914
 $C_N = 0.514$, $C_m = -0.0856$
 $\alpha = 11.4^\circ$, $M_\infty = 0.830$
 $R_{mac} = 6.0 \times 10^6$

Surface Pressures Near Leading Edge

● / ◆ upper, starboard/port
 ○ / ◇ lower, starboard/port

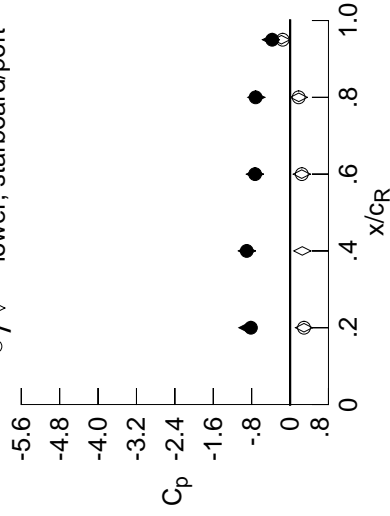

x/c_R	η	starb'd	port	starb'd	port
		$C_{p,u}$	$C_{p,l}$	$C_{p,u}$	$C_{p,l}$
0.20	0.90	-0.8159	-0.8895	0.2898	0.2905
0.40	0.95	-0.9036	-0.9001	0.2541	*****
0.60	0.95	-0.7285	-0.7326	0.2430	0.2450
0.80	0.95	-0.7177	-0.7032	0.1815	0.1794
0.95	0.95	-0.3727	-0.3989	-0.1803	-0.1534

Table D4. Continued.

η	$x/c_R = .2$		$x/c_R = .4$		$x/c_R = .6$		$x/c_R = .8$		$x/c_R = .95$	
	$C_{p,u}$	$C_{p,l}$	$C_{p,u}$	$C_{p,l}$	$C_{p,u}$	$C_{p,l}$	$C_{p,u}$	$C_{p,l}$	$C_{p,u}$	$C_{p,l}$
0.050	-0.2566	-0.2526	-0.0643	*****	*****	*****	*****	*****	*****	*****
0.100	-0.2606	-0.2580	-0.0742	*****	*****	*****	*****	*****	*****	*****
0.150	-0.2694	-0.2612	-0.0871	*****	*****	*****	*****	*****	*****	*****
0.200	-0.2805	-0.2562	-0.1000	*****	*****	*****	*****	*****	*****	*****
0.250	*****	-0.2623	-0.1115	-0.2983	-0.1464	*****	*****	*****	*****	*****
0.300	-0.2905	-0.2630	-0.1292	-0.2796	-0.2509	*****	*****	*****	*****	*****
0.350	-0.3066	-0.2635	-0.1447	-0.2713	-0.3427	*****	*****	*****	*****	*****
0.400	-0.3204	-0.2616	-0.1520	-0.2562	-0.4566	*****	*****	*****	*****	*****
0.450	-0.3377	-0.2619	-0.1488	-0.2478	-0.5481	*****	*****	*****	*****	*****
0.500	-0.3375	-0.2765	-0.1587	-0.2466	-0.5992	*****	*****	*****	*****	*****
0.525	*****	-0.2801	-0.1566	-0.2506	-0.6195	*****	*****	*****	*****	*****
0.550	-0.3143	-0.2774	-0.1623	-0.2729	-0.6452	*****	*****	*****	*****	*****
0.575	*****	-0.2789	-0.1721	-0.3108	-0.7099	*****	*****	*****	*****	*****
0.600	-0.2378	-0.3066	-0.2447	-0.3954	-0.7979	*****	*****	*****	*****	*****
0.625	*****	*****	-0.3765	-0.5376	-0.9253	*****	*****	*****	*****	*****
0.650	-0.4306	-0.7434	-0.6518	-0.7295	-1.0596	*****	*****	*****	*****	*****
0.675	*****	-1.0117	-0.9527	-0.9442	-1.1336	*****	*****	*****	*****	*****
0.700	-0.9193	-1.1558	-1.1744	-1.1245	-0.7294	*****	*****	*****	*****	*****
0.725	*****	-1.2011	*****	-1.0468	-0.5834	*****	*****	*****	*****	*****
0.750	-1.0358	-1.1921	*****	-0.8306	-0.5310	*****	*****	*****	*****	*****
0.775	*****	-1.1562	-1.1565	-0.7673	-0.5104	*****	*****	*****	*****	*****
0.800	-1.0154	-1.1170	-0.9721	-0.7658	*****	*****	*****	*****	*****	*****
0.825	*****	-1.0704	-0.8922	-0.7713	-0.4934	*****	*****	*****	*****	*****
0.850	-0.9698	-1.0247	-0.8724	-0.7825	-0.4907	*****	*****	*****	*****	*****
0.875	*****	-0.9827	-0.8504	-0.7563	-0.4602	*****	*****	*****	*****	*****
0.900	-0.8904	-0.9554	-0.8420	-0.7437	*****	*****	*****	*****	*****	*****
0.925	*****	-0.9373	-0.7807	-0.7501	-0.4158	*****	*****	*****	*****	*****
0.950	-0.9743	-0.9257	-0.7596	-0.7403	-0.3576	*****	*****	*****	*****	*****
0.975	*****	-0.9280	-0.7515	-0.7263	-0.3297	*****	*****	*****	*****	*****
-0.200	$C_{p,l}$	0.2572	0.2442	0.2694	*****	*****	*****	*****	*****	*****
-0.400	$C_{p,l}$	0.2531	0.2503	0.2401	0.0663	-0.6792	*****	*****	*****	*****
-0.600	$C_{p,l}$	*****	0.2623	0.2333	0.0981	-0.6780	*****	*****	*****	*****
-0.700	$C_{p,l}$	*****	0.2644	0.2398	0.1126	-0.6520	*****	*****	*****	*****
-0.800	$C_{p,l}$	0.3147	0.2805	0.2414	0.1401	-0.5770	*****	*****	*****	*****
-0.850	$C_{p,l}$	0.3134	0.2791	0.2562	0.1494	-0.5544	*****	*****	*****	*****
-0.900	$C_{p,l}$	0.3021	0.2967	0.2691	0.1718	-0.5264	*****	*****	*****	*****
-0.950	$C_{p,l}$	*****	*****	0.2485	0.1851	-0.1469	*****	*****	*****	*****
-0.975	$C_{p,l}$	*****	0.1782	0.1795	0.1456	-0.0211	*****	*****	*****	*****

Sharp Radius L.E.
 Run No. = 87, Point No. = 1915
 $C_N = 0.566$, $C_m = -0.0923$
 $\alpha = 12.4^\circ$, $M_\infty = 0.829$
 $R_{mac} = 6.0 \times 10^6$

Surface Pressures Near Leading Edge

● / ◆ upper, starboard/port
 ○ / ◇ lower, starboard/port

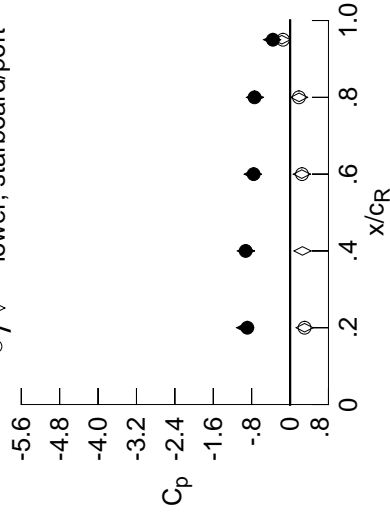

x/c_R	η	starb'd	port	$C_{p,u}$	starb'd	port	$C_{p,l}$
0.20	0.90	-0.8904	-0.9371	0.3023	0.3021	0.40	0.95
0.40	0.95	-0.9257	-0.9200	0.2588	*****	0.60	0.95
0.60	0.95	-0.7596	-0.7775	0.2449	0.2485	0.80	0.95
0.80	0.95	-0.7403	-0.7311	0.1883	0.1851	0.95	0.95
0.95	0.95	-0.3576	-0.3740	-0.1713	-0.1469		

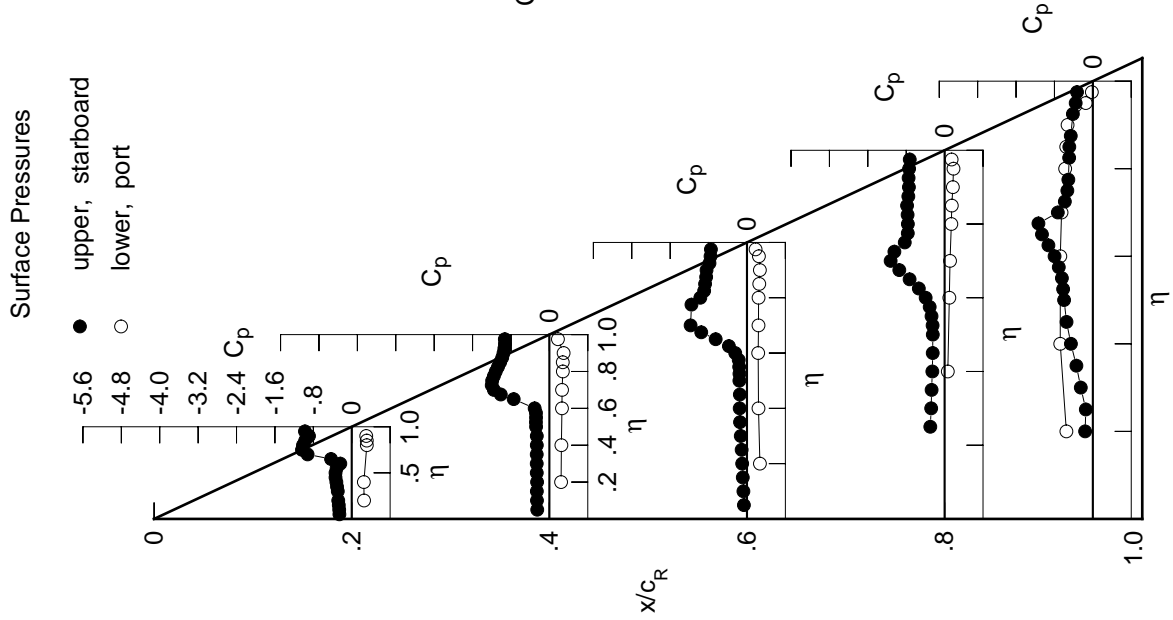

Table D4. Continued.

η	$x/c_R = .2$		$x/c_R = .4$		$x/c_R = .6$		$x/c_R = .8$		$x/c_R = .95$	
	$C_{p,u}$	$C_{p,l}$	$C_{p,u}$	$C_{p,l}$	$C_{p,u}$	$C_{p,l}$	$C_{p,u}$	$C_{p,l}$	$C_{p,u}$	$C_{p,l}$
0.050	-0.2850	-0.2878	-0.0861	*****	*****	*****	*****	*****	*****	*****
0.100	-0.2872	-0.2934	-0.0956	*****	*****	*****	*****	*****	*****	*****
0.150	-0.2968	-0.2941	-0.1092	*****	*****	*****	*****	*****	*****	*****
0.200	-0.3085	-0.2921	-0.1233	*****	*****	*****	*****	*****	*****	*****
0.250	*****	-0.2973	-0.1353	-0.3230	-0.1726	*****	*****	*****	*****	*****
0.300	-0.3169	-0.2961	-0.1520	-0.3052	-0.2475	*****	*****	*****	*****	*****
0.350	-0.3331	-0.2984	-0.1646	-0.2943	-0.3458	*****	*****	*****	*****	*****
0.400	-0.3431	-0.2973	-0.1706	-0.2802	-0.4582	*****	*****	*****	*****	*****
0.450	-0.3545	-0.2942	-0.1655	-0.2736	-0.5545	*****	*****	*****	*****	*****
0.500	-0.3457	-0.2867	-0.1836	-0.2858	-0.6130	*****	*****	*****	*****	*****
0.525	*****	-0.2864	-0.1883	-0.3050	-0.6523	*****	*****	*****	*****	*****
0.550	-0.3019	-0.3010	-0.2215	-0.3466	-0.7026	*****	*****	*****	*****	*****
0.575	*****	-0.3525	-0.2753	-0.4263	-0.7977	*****	*****	*****	*****	*****
0.600	-0.2354	-0.4917	-0.4389	-0.5470	-0.9120	*****	*****	*****	*****	*****
0.625	*****	*****	-0.6532	-0.7218	-1.0546	*****	*****	*****	*****	*****
0.650	-0.7309	-1.0343	-0.9494	-0.9195	-1.1721	*****	*****	*****	*****	*****
0.675	*****	-1.2096	-1.1830	-1.1093	-0.7378	*****	*****	*****	*****	*****
0.700	-1.1252	-1.2879	-1.3300	-1.1618	-0.6193	*****	*****	*****	*****	*****
0.725	*****	-1.3019	*****	-0.8770	-0.5558	*****	*****	*****	*****	*****
0.750	-1.1477	-1.2702	*****	-0.8074	-0.5204	*****	*****	*****	*****	*****
0.775	*****	-1.2244	-1.0450	-0.7961	-0.5102	*****	*****	*****	*****	*****
0.800	-1.0951	-1.1765	-0.9562	-0.8078	*****	*****	*****	*****	*****	*****
0.825	*****	-1.1206	-0.9252	-0.8134	-0.4815	*****	*****	*****	*****	*****
0.850	-1.0362	-1.0633	-0.9222	-0.8174	-0.4645	*****	*****	*****	*****	*****
0.875	*****	-1.0186	-0.9071	-0.7929	-0.4343	*****	*****	*****	*****	*****
0.900	-0.9572	-0.9926	-0.8774	-0.7767	*****	*****	*****	*****	*****	*****
0.925	*****	-0.9732	-0.8113	-0.7879	-0.3917	*****	*****	*****	*****	*****
0.950	-1.0329	-0.9582	-0.8024	-0.7774	-0.3460	*****	*****	*****	*****	*****
0.975	*****	-0.9574	-0.7965	-0.7649	-0.3240	*****	*****	*****	*****	*****

η	$x/c_R = .2$		$x/c_R = .4$		$x/c_R = .6$		$x/c_R = .8$		$x/c_R = .95$	
	$C_{p,u}$	$C_{p,l}$	$C_{p,u}$	$C_{p,l}$	$C_{p,u}$	$C_{p,l}$	$C_{p,u}$	$C_{p,l}$	$C_{p,u}$	$C_{p,l}$
-0.200	0.2851	0.2629	0.2825	*****	*****	*****	*****	*****	*****	*****
-0.400	0.2812	0.2685	0.2530	0.0775	-0.6947	*****	*****	*****	*****	*****
-0.600	*****	0.2814	0.2475	0.1092	-0.6739	*****	*****	*****	*****	*****
-0.700	*****	0.2852	0.2548	0.1240	-0.6485	*****	*****	*****	*****	*****
-0.800	0.3327	0.2997	0.2569	0.1497	-0.5677	*****	*****	*****	*****	*****
-0.850	0.3277	0.2959	0.2704	0.1614	-0.5442	*****	*****	*****	*****	*****
-0.900	0.3099	0.3066	0.2788	0.1825	-0.5096	*****	*****	*****	*****	*****
-0.950	*****	*****	0.2460	0.1845	-0.1422	*****	*****	*****	*****	*****
-0.975	*****	0.1676	0.1662	0.1337	-0.0258	*****	*****	*****	*****	*****

Sharp Radius L.E.
 Run No. = 87 , Point No. = 1916
 $C_N = 0.619$, $C_m = -0.0995$
 $\alpha = 13.5^\circ$, $M_\infty = 0.831$
 $R_{mac} = 6.0 \times 10^6$

Surface Pressures Near Leading Edge

● / ◆ upper, starboard/port
 ○ / ◇ lower, starboard/port

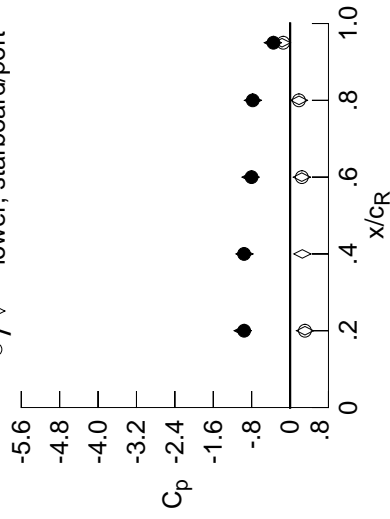

x/c_R	η	starb'd	port	starb'd	port
		$C_{p,u}$	$C_{p,l}$	$C_{p,u}$	$C_{p,l}$
0.20	0.90	-0.9572	-0.9877	0.3106	0.3099
0.40	0.95	-0.9582	-0.9511	0.2553	*****
0.60	0.95	-0.8024	-0.8247	0.2441	0.2460
0.80	0.95	-0.7774	-0.7738	0.1860	0.1845
0.95	0.95	-0.3460	-0.3600	-0.1670	-0.1422

Table D4. Continued.

η	$x/c_R = .2$		$x/c_R = .4$		$x/c_R = .6$		$x/c_R = .8$		$x/c_R = .95$	
	$C_{p,u}$	$C_{p,l}$	$C_{p,u}$	$C_{p,l}$	$C_{p,u}$	$C_{p,l}$	$C_{p,u}$	$C_{p,l}$	$C_{p,u}$	$C_{p,l}$
0.050	-0.3072	-0.3199	-0.1041	*****	*****	*****	*****	*****	*****	*****
0.100	-0.3110	-0.3258	-0.1118	*****	*****	*****	*****	*****	*****	*****
0.150	-0.3207	-0.3263	-0.1279	*****	*****	*****	*****	*****	*****	*****
0.200	-0.3330	-0.3237	-0.1398	*****	*****	*****	*****	*****	*****	*****
0.250	*****	-0.3267	-0.1540	-0.3399	-0.1883	*****	*****	*****	*****	*****
0.300	-0.3457	-0.3273	-0.1707	-0.3221	-0.2608	*****	*****	*****	*****	*****
0.350	-0.3669	-0.3276	-0.1842	-0.3113	-0.3598	*****	*****	*****	*****	*****
0.400	-0.3859	-0.3280	-0.1891	-0.3002	-0.4697	*****	*****	*****	*****	*****
0.450	-0.4024	-0.3255	-0.1853	-0.3011	-0.5632	*****	*****	*****	*****	*****
0.500	-0.3903	-0.3244	-0.2212	-0.3333	-0.6402	*****	*****	*****	*****	*****
0.525	*****	-0.3373	-0.2513	-0.3716	-0.6976	*****	*****	*****	*****	*****
0.550	-0.3389	-0.3801	-0.3250	-0.4448	-0.7717	*****	*****	*****	*****	*****
0.575	*****	-0.4982	-0.4381	-0.5541	-0.8902	*****	*****	*****	*****	*****
0.600	-0.4651	-0.7071	-0.6651	-0.7009	-1.0158	*****	*****	*****	*****	*****
0.625	*****	*****	-0.8927	-0.8851	-1.1550	*****	*****	*****	*****	*****
0.650	-1.0527	-1.2135	-1.1369	-1.0659	-0.7823	*****	*****	*****	*****	*****
0.675	*****	-1.3458	-1.3052	-1.2180	-0.6490	*****	*****	*****	*****	*****
0.700	-1.1240	-1.3936	-1.4136	-0.9706	-0.5796	*****	*****	*****	*****	*****
0.725	*****	-1.3843	*****	-0.8409	-0.5379	*****	*****	*****	*****	*****
0.750	-1.2475	-1.3568	*****	-0.8231	-0.5141	*****	*****	*****	*****	*****
0.775	*****	-1.3125	-1.0301	-0.8242	-0.5082	*****	*****	*****	*****	*****
0.800	-1.2018	-1.2486	-1.0111	-0.8383	*****	*****	*****	*****	*****	*****
0.825	*****	-1.1756	-0.9961	-0.8403	-0.4636	*****	*****	*****	*****	*****
0.850	-1.0949	-1.1082	-1.0037	-0.8382	-0.4459	*****	*****	*****	*****	*****
0.875	*****	-1.0674	-0.9586	-0.8182	-0.4117	*****	*****	*****	*****	*****
0.900	-1.0159	-1.0418	-0.9035	-0.8040	*****	*****	*****	*****	*****	*****
0.925	*****	-1.0106	-0.8528	-0.8156	-0.3740	*****	*****	*****	*****	*****
0.950	-1.0800	-0.9865	-0.8486	-0.8061	-0.3365	*****	*****	*****	*****	*****
0.975	*****	-0.9790	-0.8405	-0.7933	-0.3158	*****	*****	*****	*****	*****
-0.200	$C_{p,l}$	0.3146	0.2878	0.3031	*****	*****	*****	*****	*****	*****
-0.400	$C_{p,l}$	0.3102	0.2974	0.2741	0.0941	-0.6848	*****	*****	*****	*****
-0.600	$C_{p,l}$	*****	0.3074	0.2675	0.1266	-0.6659	*****	*****	*****	*****
-0.700	$C_{p,l}$	*****	0.3122	0.2745	0.1413	-0.6372	*****	*****	*****	*****
-0.800	$C_{p,l}$	0.3551	0.3222	0.2760	0.1662	-0.5546	*****	*****	*****	*****
-0.850	$C_{p,l}$	0.3457	0.3176	0.2881	0.1782	-0.5306	*****	*****	*****	*****
-0.900	$C_{p,l}$	0.3219	0.3192	0.2904	0.1956	-0.4916	*****	*****	*****	*****
-0.950	$C_{p,l}$	*****	*****	0.2462	0.1875	-0.1358	*****	*****	*****	*****
-0.975	$C_{p,l}$	*****	0.1602	0.1568	0.1279	-0.0267	*****	*****	*****	*****

Sharp Radius L.E.
 Run No. = 87 , Point No. = 1917
 $C_N = 0.671$, $C_m = -0.1060$
 $\alpha = 14.5^\circ$, $M_\infty = 0.830$
 $R_{mac} = 6.0 \times 10^6$

Surface Pressures Near Leading Edge

● / ◆ upper, starboard/port
 ○ / ◇ lower, starboard/port

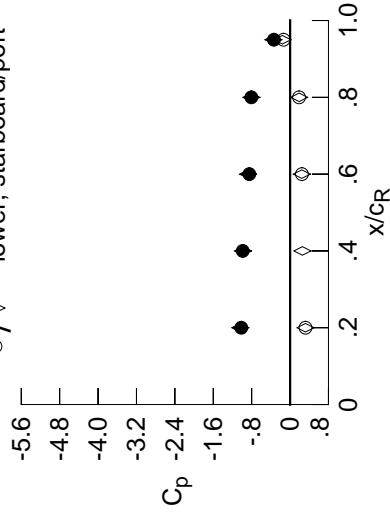

x/c_R	η	starb'd	port	starb'd	port
		$C_{p,u}$	$C_{p,l}$	$C_{p,u}$	$C_{p,l}$
0.20	0.90	-1.0159	-1.0370	0.3220	0.3219
0.40	0.95	-0.9865	-0.9801	0.2579	*****
0.60	0.95	-0.8486	-0.8762	0.2441	0.2462
0.80	0.95	-0.8061	-0.8061	0.1886	0.1875
0.95	0.95	-0.3365	-0.3486	-0.1604	-0.1358

Table D4. Continued.

η	$x/c_R = .2$		$x/c_R = .4$		$x/c_R = .6$		$x/c_R = .8$		$x/c_R = .95$	
	$C_{p,u}$	$C_{p,l}$	$C_{p,u}$	$C_{p,l}$	$C_{p,u}$	$C_{p,l}$	$C_{p,u}$	$C_{p,l}$	$C_{p,u}$	$C_{p,l}$
0.050	-0.3385	-0.3622	-0.1261	*****	*****	*****	*****	*****	*****	*****
0.100	-0.3428	-0.3666	-0.1344	*****	*****	*****	*****	*****	*****	*****
0.150	-0.3549	-0.3664	-0.1484	*****	*****	*****	*****	*****	*****	*****
0.200	-0.3677	-0.3658	-0.1629	*****	*****	*****	*****	*****	*****	*****
0.250	*****	-0.3697	-0.1761	-0.3720	-0.2170	*****	*****	*****	*****	*****
0.300	-0.3859	-0.3705	-0.1944	-0.3550	-0.2900	*****	*****	*****	*****	*****
0.350	-0.4094	-0.3704	-0.2057	-0.3441	-0.3889	*****	*****	*****	*****	*****
0.400	-0.4257	-0.3710	-0.2164	-0.3366	-0.4969	*****	*****	*****	*****	*****
0.450	-0.4376	-0.3723	-0.2264	-0.3500	-0.5932	*****	*****	*****	*****	*****
0.500	-0.4156	-0.3889	-0.3009	-0.4109	-0.6928	*****	*****	*****	*****	*****
0.525	*****	-0.4314	-0.3695	-0.4747	-0.7688	*****	*****	*****	*****	*****
0.550	-0.3946	-0.5238	-0.4923	-0.5729	-0.8621	*****	*****	*****	*****	*****
0.575	*****	-0.6988	-0.6541	-0.7100	-0.9917	*****	*****	*****	*****	*****
0.600	-0.8134	-0.9293	-0.8878	-0.8626	-1.1208	*****	*****	*****	*****	*****
0.625	*****	*****	-1.0824	-1.0392	-0.8291	*****	*****	*****	*****	*****
0.650	-1.3072	-1.3577	-1.2740	-1.1996	-0.6527	*****	*****	*****	*****	*****
0.675	*****	-1.4625	-1.4059	-1.1796	-0.6220	*****	*****	*****	*****	*****
0.700	-1.3478	-1.5000	-1.4268	-0.9101	-0.5853	*****	*****	*****	*****	*****
0.725	*****	-1.4669	*****	-0.8693	-0.5521	*****	*****	*****	*****	*****
0.750	-1.2418	-1.4251	*****	-0.8656	-0.5307	*****	*****	*****	*****	*****
0.775	*****	-1.3858	-1.0584	-0.8696	-0.5130	*****	*****	*****	*****	*****
0.800	-1.2193	-1.2833	-1.0565	-0.8824	*****	*****	*****	*****	*****	*****
0.825	*****	-1.1899	-1.0717	-0.8861	-0.4476	*****	*****	*****	*****	*****
0.850	-1.1718	-1.1468	-1.1048	-0.8794	-0.4220	*****	*****	*****	*****	*****
0.875	*****	-1.1187	-1.0062	-0.8474	-0.4001	*****	*****	*****	*****	*****
0.900	-1.0740	-1.0952	-0.9388	-0.8246	*****	*****	*****	*****	*****	*****
0.925	*****	-1.0539	-0.9009	-0.8394	-0.3753	*****	*****	*****	*****	*****
0.950	-1.1181	-1.0173	-0.8969	-0.8329	-0.3408	*****	*****	*****	*****	*****
0.975	*****	-1.0071	-0.8883	-0.8180	-0.3231	*****	*****	*****	*****	*****
-0.200	$C_{p,l}$	0.3406	0.3106	0.3194	*****	*****	*****	*****	*****	*****
-0.400		0.3406	0.3160	0.2894	0.1082	0.6789	*****	*****	*****	*****
-0.600		*****	0.3299	0.2861	0.1392	0.6587	*****	*****	*****	*****
-0.700		*****	0.3319	0.2919	0.1553	0.6305	*****	*****	*****	*****
-0.800		0.3752	0.3422	0.2927	0.1807	0.5446	*****	*****	*****	*****
-0.850		0.3610	0.3289	0.3024	0.1898	0.5200	*****	*****	*****	*****
-0.900		0.3309	0.3291	0.3008	0.2044	0.4780	*****	*****	*****	*****
-0.950		*****	*****	0.2444	0.1884	-0.1332	*****	*****	*****	*****
-0.975		*****	0.1504	0.1453	0.1172	-0.0320	*****	*****	*****	*****

Sharp Radius L.E.
 Run No. = 87, Point No. = 1918
 $C_N = 0.720$, $C_m = -0.1093$
 $\alpha = 15.5^\circ$, $M_\infty = 0.830$
 $R_{mac} = 6.0 \times 10^6$

Surface Pressures Near Leading Edge

● / ◆ upper, starboard/port
 ○ / ◇ lower, starboard/port

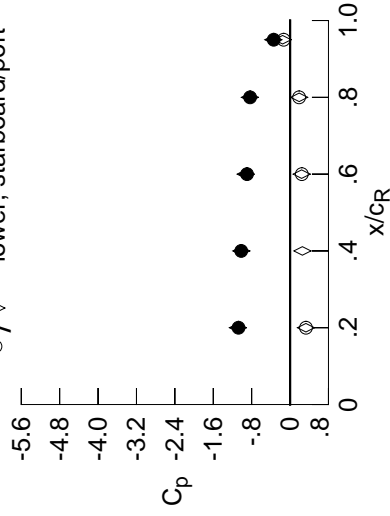

x/c_R	η	starb'd	port	starb'd	port
		$C_{p,u}$	$C_{p,l}$	$C_{p,u}$	$C_{p,l}$
0.20	0.90	-1.0740	-1.0871	0.3302	0.3309
0.40	0.95	-1.0173	-1.0161	0.2570	*****
0.60	0.95	-0.8969	-0.9254	0.2411	0.2444
0.80	0.95	-0.8329	-0.8365	0.1898	0.1884
0.95	0.95	-0.3408	-0.3500	-0.1553	-0.1332

Table D4. Continued.

η	$x/c_R = .2$		$x/c_R = .4$		$x/c_R = .6$		$x/c_R = .8$		$x/c_R = .95$	
	$C_{p,u}$	$C_{p,l}$	$C_{p,u}$	$C_{p,l}$	$C_{p,u}$	$C_{p,l}$	$C_{p,u}$	$C_{p,l}$	$C_{p,u}$	$C_{p,l}$
0.050	-0.3695	-0.4056	-0.1473	*****	*****	*****	*****	*****	*****	*****
0.100	-0.3723	-0.4099	-0.1569	*****	*****	*****	*****	*****	*****	*****
0.150	-0.3801	-0.4096	-0.1684	*****	*****	*****	*****	*****	*****	*****
0.200	-0.3910	-0.4090	-0.1877	*****	*****	*****	*****	*****	*****	*****
0.250	*****	-0.4159	-0.1981	-0.4015	-0.2516	*****	*****	*****	*****	*****
0.300	-0.4010	-0.4114	-0.2168	-0.3848	-0.3180	*****	*****	*****	*****	*****
0.350	-0.4162	-0.4124	-0.2322	-0.3795	-0.4028	*****	*****	*****	*****	*****
0.400	-0.4214	-0.4119	-0.2519	-0.3748	-0.5073	*****	*****	*****	*****	*****
0.450	-0.4183	-0.4259	-0.2828	-0.4076	-0.6098	*****	*****	*****	*****	*****
0.500	-0.3953	-0.4735	-0.4062	-0.5020	-0.7314	*****	*****	*****	*****	*****
0.525	*****	-0.5562	-0.5145	-0.5902	-0.8239	*****	*****	*****	*****	*****
0.550	-0.5062	-0.6895	-0.6653	-0.7056	-0.9275	*****	*****	*****	*****	*****
0.575	*****	-0.8927	-0.8435	-0.8532	-1.0663	*****	*****	*****	*****	*****
0.600	-1.1094	-1.1111	-1.0529	-1.0029	-1.0371	*****	*****	*****	*****	*****
0.625	*****	*****	-1.2239	-1.1609	-0.6462	*****	*****	*****	*****	*****
0.650	-1.4210	-1.4694	-1.3788	-1.2994	-0.6215	*****	*****	*****	*****	*****
0.675	*****	-1.5612	-1.4660	-1.0376	-0.6186	*****	*****	*****	*****	*****
0.700	-1.5056	-1.6059	-1.1811	-0.9266	-0.6017	*****	*****	*****	*****	*****
0.725	*****	-1.5594	*****	-0.9132	-0.5716	*****	*****	*****	*****	*****
0.750	-1.3575	-1.4509	*****	-0.9064	-0.5432	*****	*****	*****	*****	*****
0.775	*****	-1.3632	-1.0898	-0.9140	-0.5059	*****	*****	*****	*****	*****
0.800	-1.2681	-1.2642	-1.0965	-0.9274	*****	*****	*****	*****	*****	*****
0.825	*****	-1.2149	-1.1314	-0.9377	-0.4251	*****	*****	*****	*****	*****
0.850	-1.1869	-1.1935	-1.1497	-0.9245	-0.4099	*****	*****	*****	*****	*****
0.875	*****	-1.1710	-1.0185	-0.8782	-0.3959	*****	*****	*****	*****	*****
0.900	-1.1144	-1.1421	-0.9707	-0.8358	*****	*****	*****	*****	*****	*****
0.925	*****	-1.0857	-0.9508	-0.8476	-0.3868	*****	*****	*****	*****	*****
0.950	-1.1519	-1.0562	-0.9459	-0.8428	-0.3473	*****	*****	*****	*****	*****
0.975	*****	-1.0439	-0.9397	-0.8296	-0.3307	*****	*****	*****	*****	*****
-0.200	0.3671	0.3363	0.3375	*****	-0.5807	*****	*****	*****	*****	*****
-0.400	0.3668	0.3350	0.3089	0.1253	-0.6700	*****	*****	*****	*****	*****
-0.600	*****	0.3535	0.3043	0.1558	-0.6494	*****	*****	*****	*****	*****
-0.700	*****	0.3522	0.3092	0.1719	-0.6181	*****	*****	*****	*****	*****
-0.800	0.3945	0.3597	0.3089	0.1930	-0.5347	*****	*****	*****	*****	*****
-0.850	0.3753	0.3439	0.3164	0.2029	-0.5089	*****	*****	*****	*****	*****
-0.900	0.3395	0.3374	0.3082	0.2142	-0.4635	*****	*****	*****	*****	*****
-0.950	*****	*****	0.2408	0.1886	-0.1294	*****	*****	*****	*****	*****
-0.975	*****	0.1405	0.1321	0.1078	-0.0377	*****	*****	*****	*****	*****

Sharp Radius L.E.
 Run No. = 87 , Point No. = 1919
 $C_N = 0.774$, $C_m = -0.1161$
 $\alpha = 16.5^\circ$, $M_\infty = 0.830$
 $R_{mac} = 6.0 \times 10^6$

Surface Pressures Near Leading Edge

● / ◆ upper, starboard/port
 ○ / ◇ lower, starboard/port

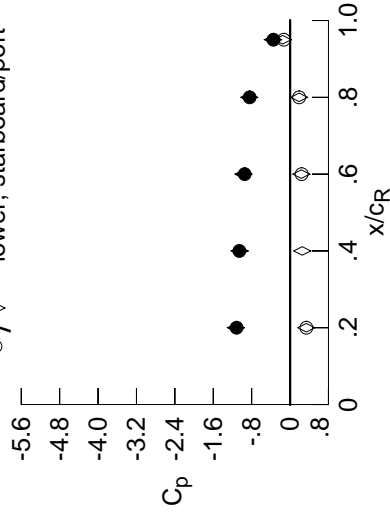

x/c_R	η	starb'd	port	$C_{p,u}$	starb'd	port	$C_{p,l}$
0.20	0.90	-1.1144	-1.1278	0.3378	0.3395	*****	*****
0.40	0.95	-1.0562	-1.0512	0.2531	*****	*****	*****
0.60	0.95	-0.9459	-0.9727	0.2348	0.2408	*****	*****
0.80	0.95	-0.8428	-0.8516	0.1876	0.1886	*****	*****
0.95	0.95	-0.3473	-0.3573	-0.1536	-0.1294	*****	*****

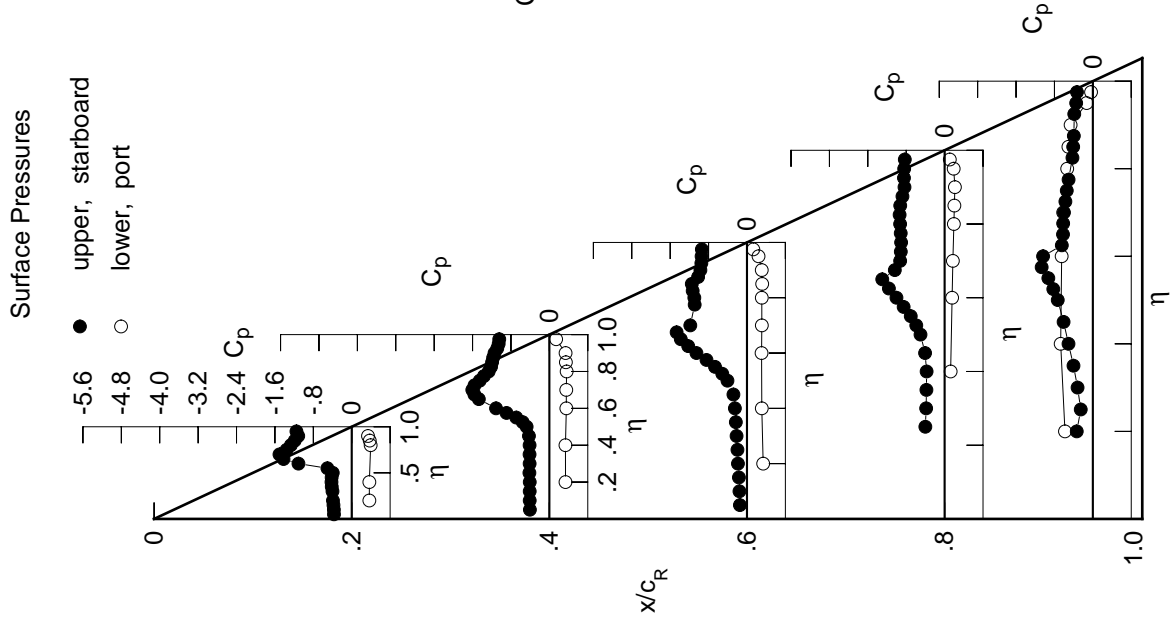

Table D4. Continued.

η	$x/c_R = .2$		$x/c_R = .4$		$x/c_R = .6$		$x/c_R = .8$		$x/c_R = .95$	
	$C_{p,u}$	$C_{p,l}$	$C_{p,u}$	$C_{p,l}$	$C_{p,u}$	$C_{p,l}$	$C_{p,u}$	$C_{p,l}$	$C_{p,u}$	$C_{p,l}$
0.050	-0.3957	-0.4360	-0.1733	*****	*****	*****	*****	*****	*****	*****
0.100	-0.3979	-0.4406	-0.1819	*****	*****	*****	*****	*****	*****	*****
0.150	-0.4061	-0.4404	-0.1973	*****	*****	*****	*****	*****	*****	*****
0.200	-0.4159	-0.4400	-0.2145	*****	*****	*****	*****	*****	*****	*****
0.250	*****	-0.4427	-0.2302	-0.4526	-0.3749	*****	*****	*****	*****	*****
0.300	-0.4194	-0.4450	-0.2508	-0.4365	-0.4093	*****	*****	*****	*****	*****
0.350	-0.4290	-0.4462	-0.2717	-0.4302	-0.4779	*****	*****	*****	*****	*****
0.400	-0.4252	-0.4529	-0.3035	-0.4403	-0.5810	*****	*****	*****	*****	*****
0.450	-0.4130	-0.4843	-0.3659	-0.4870	-0.6877	*****	*****	*****	*****	*****
0.500	-0.4232	-0.5798	-0.5378	-0.6182	-0.8224	*****	*****	*****	*****	*****
0.525	*****	-0.6972	-0.6718	-0.7175	-0.9139	*****	*****	*****	*****	*****
0.550	-0.7512	-0.8613	-0.8382	-0.8508	-1.0194	*****	*****	*****	*****	*****
0.575	*****	-1.0690	-1.0112	-0.9971	-1.1296	*****	*****	*****	*****	*****
0.600	-1.3191	-1.2570	-1.1972	-1.1419	-0.6960	*****	*****	*****	*****	*****
0.625	*****	*****	-1.3388	-1.2854	-0.6365	*****	*****	*****	*****	*****
0.650	-1.4909	-1.5657	-1.4695	-1.3153	-0.6370	*****	*****	*****	*****	*****
0.675	*****	-1.6465	-1.2698	-0.9987	-0.6436	*****	*****	*****	*****	*****
0.700	-1.5484	-1.6569	-1.1436	-0.9693	-0.6308	*****	*****	*****	*****	*****
0.725	*****	-1.4973	*****	-0.9573	-0.5970	*****	*****	*****	*****	*****
0.750	-1.4337	-1.4124	*****	-0.9617	-0.5612	*****	*****	*****	*****	*****
0.775	*****	-1.3556	-1.1264	-0.9698	-0.5098	*****	*****	*****	*****	*****
0.800	-1.3313	-1.3129	-1.1459	-0.9904	*****	*****	*****	*****	*****	*****
0.825	*****	-1.2691	-1.1862	-0.9978	-0.4251	*****	*****	*****	*****	*****
0.850	-1.2106	-1.2410	-1.1599	-0.9838	-0.4046	*****	*****	*****	*****	*****
0.875	*****	-1.2155	-1.0307	-0.9147	-0.4130	*****	*****	*****	*****	*****
0.900	-1.1554	-1.1671	-1.0127	-0.8617	*****	*****	*****	*****	*****	*****
0.925	*****	-1.1164	-1.0006	-0.8685	-0.4140	*****	*****	*****	*****	*****
0.950	-1.1873	-1.0879	-0.9965	-0.8663	-0.3715	*****	*****	*****	*****	*****
0.975	*****	-1.0787	-0.9829	-0.8518	-0.3554	*****	*****	*****	*****	*****
-0.200	$C_{p,l}$	0.3959	0.3557	0.3547	*****	*****	*****	*****	*****	*****
-0.400	*****	0.3957	0.3578	0.3274	0.1364	0.6610	*****	*****	*****	*****
-0.600	*****	*****	0.3726	0.3185	0.1703	0.6395	*****	*****	*****	*****
-0.700	*****	*****	0.3729	0.3268	0.1838	0.6085	*****	*****	*****	*****
-0.800	0.4114	0.3784	0.3253	0.2090	-0.5223	*****	*****	*****	*****	*****
-0.850	0.3890	0.3562	0.3291	0.2154	-0.4964	*****	*****	*****	*****	*****
-0.900	0.3476	0.3449	0.3152	0.2245	-0.4471	*****	*****	*****	*****	*****
-0.950	*****	*****	*****	0.2373	0.1868	-0.1280	*****	*****	*****	*****
-0.975	*****	0.1291	0.1179	0.0975	-0.0454	*****	*****	*****	*****	*****

Sharp Radius L.E.
 Run No. = 87, Point No. = 1920
 $C_N = 0.827$, $C_m = -0.1238$
 $\alpha = 17.5^\circ$, $M_\infty = 0.831$
 $R_{mac} = 6.0 \times 10^6$

Surface Pressures Near Leading Edge

● / ◆ upper, starboard/port
 ○ / ◇ lower, starboard/port

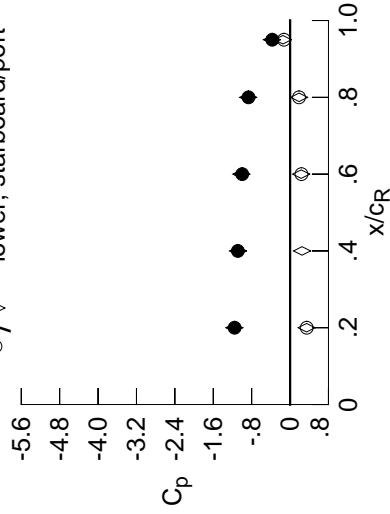

x/c_R	η	starb'd	port	starb'd	port
		$C_{p,u}$	$C_{p,l}$	$C_{p,u}$	$C_{p,l}$
0.20	0.90	-1.1554	-1.1613	0.3438	0.3476
0.40	0.95	-1.0879	-1.0844	0.2491	*****
0.60	0.95	-0.9965	-1.0157	0.2315	0.2373
0.80	0.95	-0.8663	-0.8736	0.1880	0.1868
0.95	0.95	-0.3715	-0.3784	-0.1490	-0.1280

Table D4. Continued.

η	$x/c_R = .2$		$x/c_R = .4$		$x/c_R = .6$		$x/c_R = .8$		$x/c_R = .95$	
	$C_{p,u}$	$C_{p,l}$	$C_{p,u}$	$C_{p,l}$	$C_{p,u}$	$C_{p,l}$	$C_{p,u}$	$C_{p,l}$	$C_{p,u}$	$C_{p,l}$
0.050	-0.4283	-0.4652	-0.1889	*****	*****	*****	*****	*****	*****	*****
0.100	-0.4302	-0.4673	-0.2022	*****	*****	*****	*****	*****	*****	*****
0.150	-0.4366	-0.4675	-0.2137	*****	*****	*****	*****	*****	*****	*****
0.200	-0.4462	-0.4622	-0.2369	*****	*****	*****	*****	*****	*****	*****
0.250	*****	-0.4721	-0.2498	-0.4919	-0.4798	*****	*****	*****	*****	*****
0.300	-0.4518	-0.4656	-0.2784	-0.4743	-0.5267	*****	*****	*****	*****	*****
0.350	-0.4570	-0.4736	-0.3079	-0.4780	-0.6031	*****	*****	*****	*****	*****
0.400	-0.4493	-0.4898	-0.3574	-0.4941	-0.6968	*****	*****	*****	*****	*****
0.450	-0.4492	-0.5512	-0.4548	-0.5723	-0.7960	*****	*****	*****	*****	*****
0.500	-0.5682	-0.7056	-0.6685	-0.7330	-0.9213	*****	*****	*****	*****	*****
0.525	*****	-0.8596	-0.8214	-0.8512	-1.0121	*****	*****	*****	*****	*****
0.550	-1.0487	-1.0364	-0.9854	-0.9868	-1.1062	*****	*****	*****	*****	*****
0.575	*****	-1.2288	-1.1514	-1.1282	-1.0330	*****	*****	*****	*****	*****
0.600	-1.4716	-1.3907	-1.3105	-1.2603	-0.6728	*****	*****	*****	*****	*****
0.625	*****	*****	-1.4347	-1.3844	-0.6531	*****	*****	*****	*****	*****
0.650	-1.5617	-1.6581	-1.4410	-1.1228	-0.6633	*****	*****	*****	*****	*****
0.675	*****	-1.6695	-1.1904	-1.0202	-0.6631	*****	*****	*****	*****	*****
0.700	-1.5448	-1.4939	-1.1598	-1.0049	-0.6479	*****	*****	*****	*****	*****
0.725	*****	-1.4189	*****	-1.0010	-0.6071	*****	*****	*****	*****	*****
0.750	-1.4364	-1.4106	*****	-1.0036	-0.5638	*****	*****	*****	*****	*****
0.775	*****	-1.4136	-1.1684	-1.0227	-0.4978	*****	*****	*****	*****	*****
0.800	-1.3233	-1.4054	-1.1931	-1.0425	*****	*****	*****	*****	*****	*****
0.825	*****	-1.3667	-1.2307	-1.0473	-0.4340	*****	*****	*****	*****	*****
0.850	-1.2416	-1.3043	-1.1826	-1.0238	-0.4143	*****	*****	*****	*****	*****
0.875	*****	-1.2504	-1.0626	-0.9516	-0.4336	*****	*****	*****	*****	*****
0.900	-1.1924	-1.1995	-1.0548	-0.8811	*****	*****	*****	*****	*****	*****
0.925	*****	-1.1489	-1.0446	-0.8828	-0.4400	*****	*****	*****	*****	*****
0.950	-1.2290	-1.1299	-1.0275	-0.8838	-0.3943	*****	*****	*****	*****	*****
0.975	*****	-1.1175	-1.0135	-0.8642	-0.3736	*****	*****	*****	*****	*****
-0.200	0.4234	0.3777	0.3755	*****	-0.5810	*****	*****	*****	*****	*****
-0.400	0.4231	0.3814	0.3435	0.1574	-0.6502	*****	*****	*****	*****	*****
-0.600	*****	0.3889	0.3431	0.1869	-0.6298	*****	*****	*****	*****	*****
-0.700	*****	0.3938	0.3440	0.2007	-0.5921	*****	*****	*****	*****	*****
-0.800	0.4301	0.3951	0.3413	0.2226	-0.5127	*****	*****	*****	*****	*****
-0.850	0.4024	0.3693	0.3436	0.2285	-0.4837	*****	*****	*****	*****	*****
-0.900	0.3559	0.3518	0.3237	0.2305	-0.4330	*****	*****	*****	*****	*****
-0.950	*****	*****	0.2331	0.1861	-0.1257	*****	*****	*****	*****	*****
-0.975	*****	0.1202	0.1069	0.0878	-0.0527	*****	*****	*****	*****	*****

Sharp Radius L.E.

Run No. = 87, Point No. = 1921

$C_N = 0.889$, $C_m = -0.1375$

$\alpha = 18.6^\circ$, $M_\infty = 0.831$

$R_{mac} = 6.0 \times 10^6$

Surface Pressures Near Leading Edge

● / ◆ upper, starboard/port
○ / ◇ lower, starboard/port

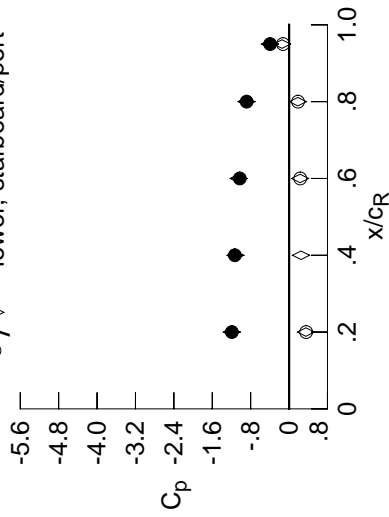

x/cR	η	$C_{p,u}$ starb'd	$C_{p,u}$ port	$C_{p,l}$ starb'd	$C_{p,l}$ port
0.20	0.90	-1.1924	-1.1948	0.3510	0.3559
0.40	0.95	-1.1299	-1.1186	0.2488	*****
0.60	0.95	-1.0275	-1.0511	0.2298	0.2331
0.80	0.95	-0.8838	-0.8875	0.1832	0.1861
0.95	0.95	-0.3943	-0.4000	-0.1465	-0.1257

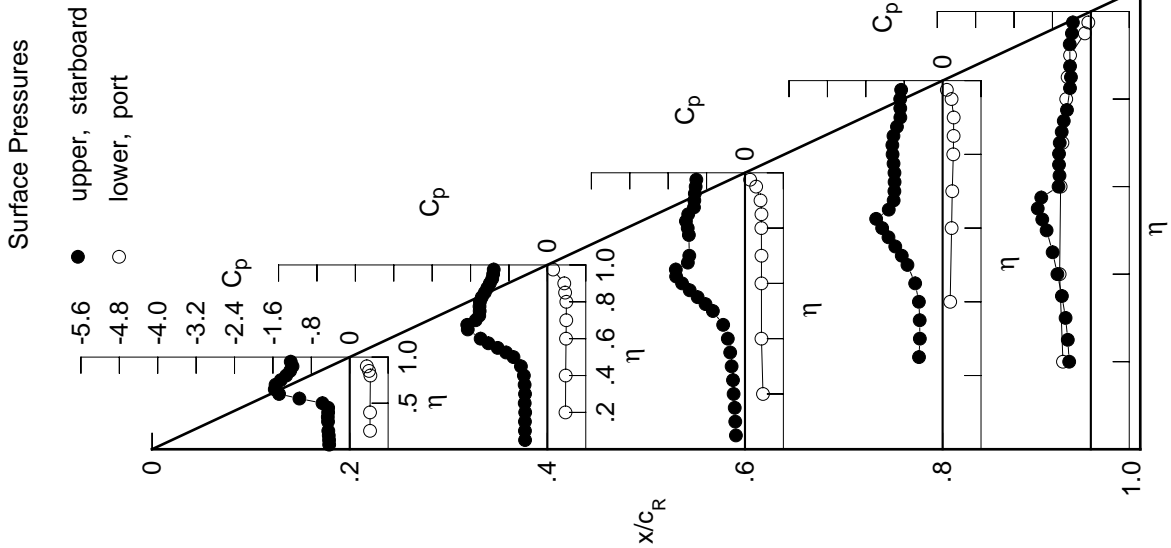

Table D4. Continued.

η	$x/c_R = .2$		$x/c_R = .4$		$x/c_R = .6$		$x/c_R = .8$		$x/c_R = .95$	
	$C_{p,u}$	$C_{p,l}$	$C_{p,u}$	$C_{p,l}$	$C_{p,u}$	$C_{p,l}$	$C_{p,u}$	$C_{p,l}$	$C_{p,u}$	$C_{p,l}$
0.050	-0.4591	-0.4867	-0.2072	*****	*****	*****	*****	*****	*****	*****
0.100	-0.4628	-0.4898	-0.2199	*****	*****	*****	*****	*****	*****	*****
0.150	-0.4703	-0.4906	-0.2361	*****	*****	*****	*****	*****	*****	*****
0.200	-0.4785	-0.4913	-0.2576	*****	*****	*****	*****	*****	*****	*****
0.250	*****	-0.4971	-0.2783	-0.5213	-0.5237	*****	*****	*****	*****	*****
0.300	-0.4799	-0.4994	-0.3114	-0.5127	-0.5946	*****	*****	*****	*****	*****
0.350	-0.4857	-0.5132	-0.3575	-0.5226	-0.6645	*****	*****	*****	*****	*****
0.400	-0.4869	-0.5518	-0.4344	-0.5639	-0.7533	*****	*****	*****	*****	*****
0.450	-0.5361	-0.6552	-0.5743	-0.6607	-0.8483	*****	*****	*****	*****	*****
0.500	-0.7988	-0.8719	-0.8308	-0.8515	-0.9905	*****	*****	*****	*****	*****
0.525	*****	-1.0409	-0.9868	-0.9671	-1.0797	*****	*****	*****	*****	*****
0.550	-1.2694	-1.2102	-1.1493	-1.1013	-1.1723	*****	*****	*****	*****	*****
0.575	*****	-1.3758	-1.2889	-1.2304	-0.7791	*****	*****	*****	*****	*****
0.600	-1.5706	-1.5048	-1.4282	-1.3464	-0.6721	*****	*****	*****	*****	*****
0.625	*****	*****	-1.5227	-1.4480	-0.6686	*****	*****	*****	*****	*****
0.650	-1.5922	-1.6966	-1.2734	-1.0971	-0.6790	*****	*****	*****	*****	*****
0.675	*****	-1.4773	-1.2043	-1.0546	-0.6701	*****	*****	*****	*****	*****
0.700	-1.5204	-1.4053	-1.1936	-1.0506	-0.6370	*****	*****	*****	*****	*****
0.725	*****	-1.3912	*****	-1.0496	-0.5911	*****	*****	*****	*****	*****
0.750	-1.3908	-1.4029	*****	-1.0626	-0.5403	*****	*****	*****	*****	*****
0.775	*****	-1.4322	-1.2068	-1.0783	-0.4907	*****	*****	*****	*****	*****
0.800	-1.3309	-1.4534	-1.2366	-1.1012	*****	*****	*****	*****	*****	*****
0.825	*****	-1.4191	-1.2744	-1.0946	-0.4575	*****	*****	*****	*****	*****
0.850	-1.2769	-1.3578	-1.2201	-1.0741	-0.4277	*****	*****	*****	*****	*****
0.875	*****	-1.2911	-1.0951	-0.9904	-0.4636	*****	*****	*****	*****	*****
0.900	-1.2337	-1.2357	-1.1013	-0.9095	*****	*****	*****	*****	*****	*****
0.925	*****	-1.2049	-1.0994	-0.9068	-0.4702	*****	*****	*****	*****	*****
0.950	-1.2785	-1.1879	-1.0851	-0.9065	-0.4143	*****	*****	*****	*****	*****
0.975	*****	-1.1840	-1.0676	-0.8903	-0.3927	*****	*****	*****	*****	*****

Sharp Radius L.E.
 Run No. = 87 , Point No. = 1922
 $C_N = 0.948$, $C_m = -0.1495$
 $\alpha = 19.6^\circ$, $M_\infty = 0.831$
 $R_{mac} = 6.0 \times 10^6$

Surface Pressures Near Leading Edge

● / ◆ upper, starboard/port
 ○ / ◇ lower, starboard/port

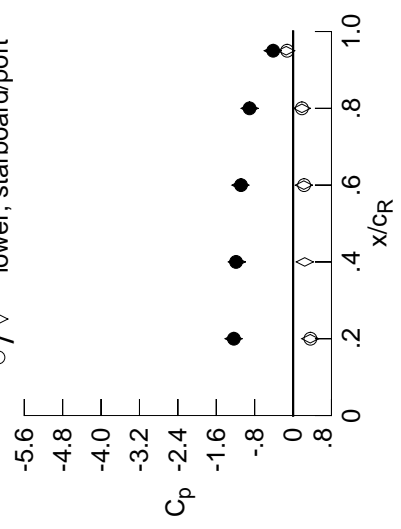

x/c_R	η	starb'd	port	starb'd	port
		$C_{p,u}$	$C_{p,l}$	$C_{p,u}$	$C_{p,l}$
0.20	0.90	-1.2337	-1.2409	0.3572	0.3614
0.40	0.95	-1.1879	-1.1721	0.2432	*****
0.60	0.95	-1.0851	-1.0983	0.2237	0.2296
0.80	0.95	-0.9065	-0.9062	0.1840	0.1843
0.95	0.95	-0.4143	-0.4246	-0.1429	-0.1230

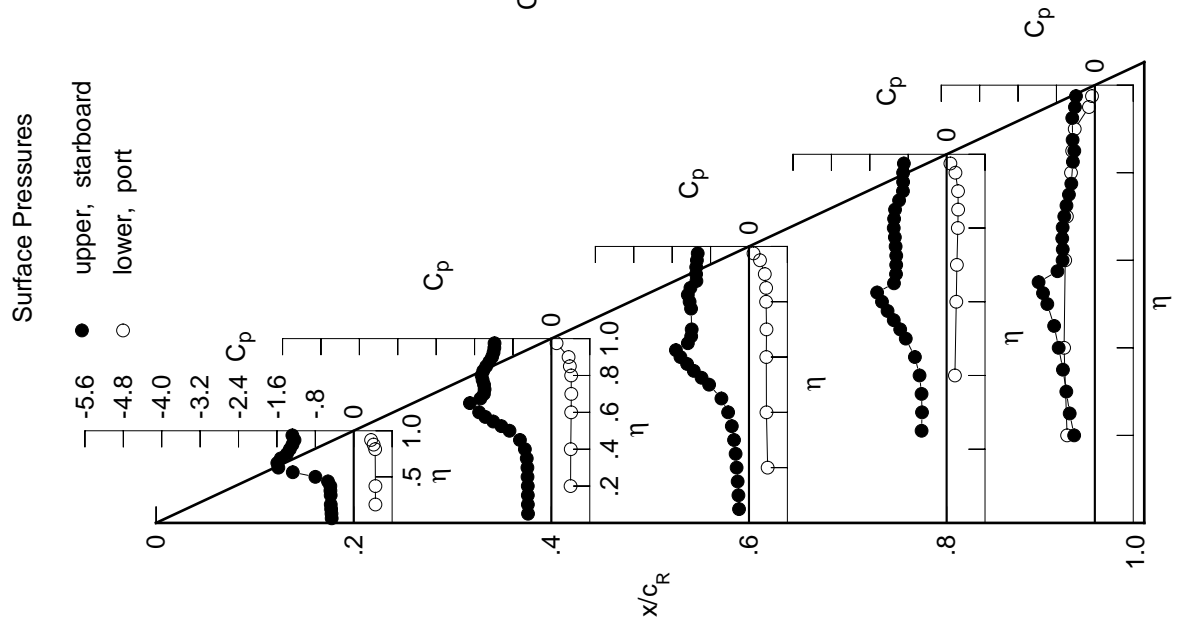

η	$C_{p,l}$	$C_{p,l}$	$C_{p,l}$	$C_{p,l}$	$C_{p,l}$
-0.200	0.4522	0.4003	0.3890	*****	-0.5780
-0.400	0.4519	0.4036	0.3637	0.1728	-0.6410
-0.600	*****	0.4127	0.3606	0.2012	-0.6172
-0.700	*****	0.4150	0.3650	0.2137	-0.5827
-0.800	0.4466	0.4126	0.3568	0.2337	-0.4966
-0.850	0.4146	0.3847	0.3565	0.2397	-0.4717
-0.900	0.3614	0.3583	0.3298	0.2379	-0.4193
-0.950	*****	*****	0.2296	0.1843	-0.1230
-0.975	*****	0.1083	0.0947	0.0785	-0.0594

Table D4. Continued.

η	$x/c_R = .2$		$x/c_R = .4$		$x/c_R = .6$		$x/c_R = .8$		$x/c_R = .95$	
	$C_{p,u}$	$C_{p,l}$	$C_{p,u}$	$C_{p,l}$	$C_{p,u}$	$C_{p,l}$	$C_{p,u}$	$C_{p,l}$	$C_{p,u}$	$C_{p,l}$
0.050	-0.4949	-0.5343	-0.2666	*****	*****	*****	*****	*****	*****	*****
0.100	-0.4970	-0.5398	-0.2777	*****	*****	*****	*****	*****	*****	*****
0.150	-0.5053	-0.5375	-0.3020	*****	*****	*****	*****	*****	*****	*****
0.200	-0.5094	-0.5404	-0.3276	*****	*****	*****	*****	*****	*****	*****
0.250	*****	-0.5451	-0.3574	-0.5810	-0.5408	*****	*****	*****	*****	*****
0.300	-0.5144	-0.5559	-0.4001	-0.5755	-0.6146	*****	*****	*****	*****	*****
0.350	-0.5237	-0.5805	-0.4621	-0.5857	-0.6789	*****	*****	*****	*****	*****
0.400	-0.5496	-0.6454	-0.5707	-0.6444	-0.7676	*****	*****	*****	*****	*****
0.450	-0.6738	-0.8027	-0.7463	-0.7597	-0.8768	*****	*****	*****	*****	*****
0.500	-1.0229	-1.0651	-1.0260	-0.9573	-1.0527	*****	*****	*****	*****	*****
0.525	*****	-1.2285	-1.1712	-1.0717	-1.1472	*****	*****	*****	*****	*****
0.550	-1.4188	-1.3721	-1.3132	-1.1944	-1.1945	*****	*****	*****	*****	*****
0.575	*****	-1.5049	-1.4289	-1.3138	-0.7434	*****	*****	*****	*****	*****
0.600	-1.5690	-1.5941	-1.5414	-1.4112	-0.7014	*****	*****	*****	*****	*****
0.625	*****	*****	-1.5383	-1.4620	-0.6998	*****	*****	*****	*****	*****
0.650	-1.5469	-1.5294	-1.2925	-1.1163	-0.6905	*****	*****	*****	*****	*****
0.675	*****	-1.3982	-1.2768	-1.0912	-0.6575	*****	*****	*****	*****	*****
0.700	-1.4498	-1.3871	-1.2724	-1.0886	-0.6092	*****	*****	*****	*****	*****
0.725	*****	-1.3867	*****	-1.0886	-0.5644	*****	*****	*****	*****	*****
0.750	-1.4149	-1.3988	*****	-1.1004	-0.5230	*****	*****	*****	*****	*****
0.775	*****	-1.4206	-1.2915	-1.1292	-0.4945	*****	*****	*****	*****	*****
0.800	-1.3826	-1.4400	-1.3281	-1.1520	*****	*****	*****	*****	*****	*****
0.825	*****	-1.4201	-1.3593	-1.1391	-0.4869	*****	*****	*****	*****	*****
0.850	-1.3168	-1.3679	-1.3082	-1.1264	-0.4497	*****	*****	*****	*****	*****
0.875	*****	-1.3115	-1.1658	-1.0329	-0.4854	*****	*****	*****	*****	*****
0.900	-1.2773	-1.2849	-1.1767	-0.9429	*****	*****	*****	*****	*****	*****
0.925	*****	-1.2774	-1.1751	-0.9386	-0.4833	*****	*****	*****	*****	*****
0.950	-1.3306	-1.2692	-1.1786	-0.9401	-0.4265	*****	*****	*****	*****	*****
0.975	*****	-1.2684	-1.1706	-0.9293	-0.4036	*****	*****	*****	*****	*****
-0.200	0.4813	0.4262	0.4079	*****	-0.5705	*****	*****	*****	*****	*****
-0.400	0.4806	0.4260	0.3862	0.1859	-0.6287	*****	*****	*****	*****	*****
-0.600	*****	0.4390	0.3766	0.2162	-0.6025	*****	*****	*****	*****	*****
-0.700	*****	0.4378	0.3828	0.2286	-0.5721	*****	*****	*****	*****	*****
-0.800	0.4637	0.4309	0.3728	0.2486	-0.4824	*****	*****	*****	*****	*****
-0.850	0.4273	0.3943	0.3649	0.2533	-0.4580	*****	*****	*****	*****	*****
-0.900	0.3684	0.3645	0.3326	0.2459	-0.4040	*****	*****	*****	*****	*****
-0.950	*****	*****	0.2206	0.1792	-0.1190	*****	*****	*****	*****	*****
-0.975	*****	0.0976	0.0801	0.0671	-0.0648	*****	*****	*****	*****	*****

Sharp Radius L.E.
 Run No. = 87, Point No. = 1923
 $C_N = 1.005$, $C_m = -0.1598$
 $\alpha = 20.6^\circ$, $M_\infty = 0.831$
 $R_{mac} = 6.0 \times 10^6$

Surface Pressures Near Leading Edge

● / ◆ upper, starboard/port
 ○ / ◇ lower, starboard/port

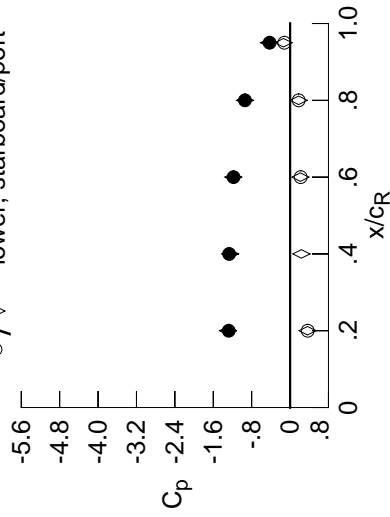

x/c_R	η	starb'd	port	$C_{p,u}$	starb'd	port	$C_{p,l}$
0.20	0.90	-1.2773	-1.2929	0.3638	0.3684	0.2357	*****
0.40	0.95	-1.2692	-1.2489	0.2141	0.2206	0.1785	0.1792
0.60	0.95	-1.1786	-1.1843	0.1785	0.1792	-0.4394	-0.1374
0.80	0.95	-0.9401	-0.9395	-0.4265	-0.4394	-0.1374	-0.1190
0.95	0.95	-0.4265	-0.4394	-0.1374	-0.1190	0.0976	0.0801

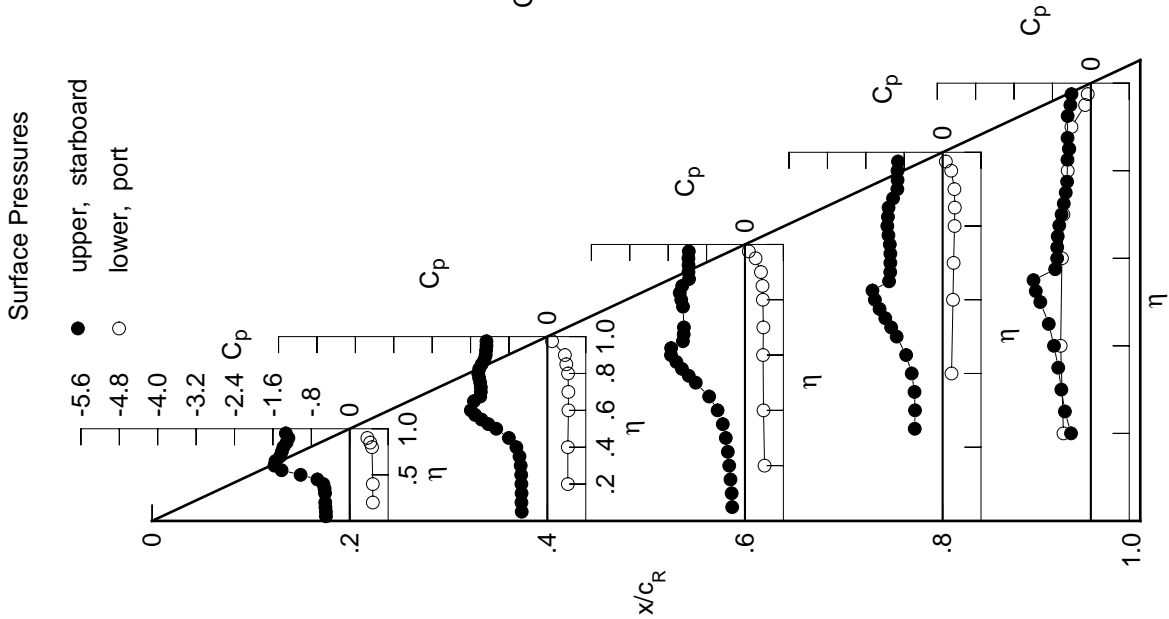

Table D4. Continued.

η	$x/c_R = .2$		$x/c_R = .4$		$x/c_R = .6$		$x/c_R = .8$		$x/c_R = .95$	
	$C_{p,u}$	$C_{p,l}$	$C_{p,u}$	$C_{p,l}$	$C_{p,u}$	$C_{p,l}$	$C_{p,u}$	$C_{p,l}$	$C_{p,u}$	$C_{p,l}$
0.050	-0.5343	-0.5698	-0.3856	*****	*****	*****	*****	*****	*****	*****
0.100	-0.5362	-0.5741	-0.4057	*****	*****	*****	*****	*****	*****	*****
0.150	-0.5418	-0.5791	-0.4307	*****	*****	*****	*****	*****	*****	*****
0.200	-0.5485	-0.5750	-0.4675	*****	*****	*****	*****	*****	*****	*****
0.250	*****	-0.5907	-0.4991	-0.6537	-0.5104	*****	*****	*****	*****	*****
0.300	-0.5591	-0.6017	-0.5533	-0.6624	-0.5914	*****	*****	*****	*****	*****
0.350	-0.5826	-0.6458	-0.6219	-0.6866	-0.6505	*****	*****	*****	*****	*****
0.400	-0.6434	-0.7445	-0.7427	-0.7455	-0.7405	*****	*****	*****	*****	*****
0.450	-0.8360	-0.9521	-0.9315	-0.8691	-0.8774	*****	*****	*****	*****	*****
0.500	-1.1961	-1.2228	-1.1927	-1.0574	-1.0699	*****	*****	*****	*****	*****
0.525	*****	-1.3680	-1.3222	-1.1667	-1.1774	*****	*****	*****	*****	*****
0.550	-1.5197	-1.4855	-1.4366	-1.2767	-1.1931	*****	*****	*****	*****	*****
0.575	*****	-1.5847	-1.5357	-1.3844	-0.7622	*****	*****	*****	*****	*****
0.600	-1.5114	-1.6541	-1.6227	-1.4739	-0.7252	*****	*****	*****	*****	*****
0.625	*****	*****	-1.5353	-1.4700	-0.7064	*****	*****	*****	*****	*****
0.650	-1.5105	-1.4969	-1.3706	-1.1444	-0.6711	*****	*****	*****	*****	*****
0.675	*****	-1.4274	-1.3636	-1.1270	-0.6345	*****	*****	*****	*****	*****
0.700	-1.4723	-1.4129	-1.3588	-1.1152	-0.5979	*****	*****	*****	*****	*****
0.725	*****	-1.4073	*****	-1.1118	-0.5576	*****	*****	*****	*****	*****
0.750	-1.4855	-1.4230	*****	-1.1161	-0.5292	*****	*****	*****	*****	*****
0.775	*****	-1.4465	-1.3736	-1.1359	-0.5089	*****	*****	*****	*****	*****
0.800	-1.4484	-1.4690	-1.4234	-1.1582	*****	*****	*****	*****	*****	*****
0.825	*****	-1.4516	-1.4558	-1.1494	-0.5130	*****	*****	*****	*****	*****
0.850	-1.3578	-1.3972	-1.3979	-1.1361	-0.4782	*****	*****	*****	*****	*****
0.875	*****	-1.3461	-1.2433	-1.0478	-0.4953	*****	*****	*****	*****	*****
0.900	-1.3232	-1.3303	-1.2633	-0.9423	*****	*****	*****	*****	*****	*****
0.925	*****	-1.3240	-1.2701	-0.9446	-0.4825	*****	*****	*****	*****	*****
0.950	-1.3775	-1.3250	-1.2683	-0.9588	-0.4313	*****	*****	*****	*****	*****
0.975	*****	-1.3222	-1.2607	-0.9488	-0.4056	*****	*****	*****	*****	*****
-0.200	*****	0.5091	0.4512	0.4281	*****	*****	*****	*****	*****	*****
-0.400	*****	0.5084	0.4514	0.4020	0.2066	-0.6175	*****	*****	*****	*****
-0.600	*****	*****	0.4632	0.3980	0.2318	-0.5916	*****	*****	*****	*****
-0.700	*****	*****	0.4605	0.3983	0.2479	-0.5584	*****	*****	*****	*****
-0.800	0.4804	0.4484	0.3872	0.2606	-0.4721	*****	*****	*****	*****	*****
-0.850	0.4405	0.4047	0.3773	0.2645	-0.4450	*****	*****	*****	*****	*****
-0.900	0.3770	0.3703	0.3403	0.2541	-0.3892	*****	*****	*****	*****	*****
-0.950	*****	*****	0.2154	0.1780	-0.1225	*****	*****	*****	*****	*****
-0.975	*****	0.0928	0.0689	0.0558	-0.0680	*****	*****	*****	*****	*****

Sharp Radius L.E.
 Run No. = 87, Point No. = 1924
 $C_N = 1.058$, $C_m = -0.1679$
 $\alpha = 21.6^\circ$, $M_\infty = 0.830$
 $R_{mac} = 6.0 \times 10^6$

Surface Pressures Near Leading Edge

● / ◆ upper, starboard/port
 ○ / ◇ lower, starboard/port

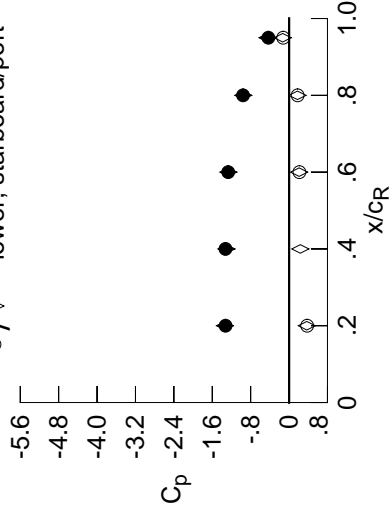

x/c_R	η	starb'd	port	starb'd	port
		$C_{p,u}$	$C_{p,l}$	$C_{p,u}$	$C_{p,l}$
0.20	0.90	-1.3232	-1.3360	0.3697	0.3770
0.40	0.95	-1.3250	-1.3052	0.2342	*****
0.60	0.95	-1.2683	-1.2646	0.2099	0.2154
0.80	0.95	-0.9588	-0.9543	0.1745	0.1780
0.95	0.95	-0.4313	-0.4502	-0.1328	-0.1225

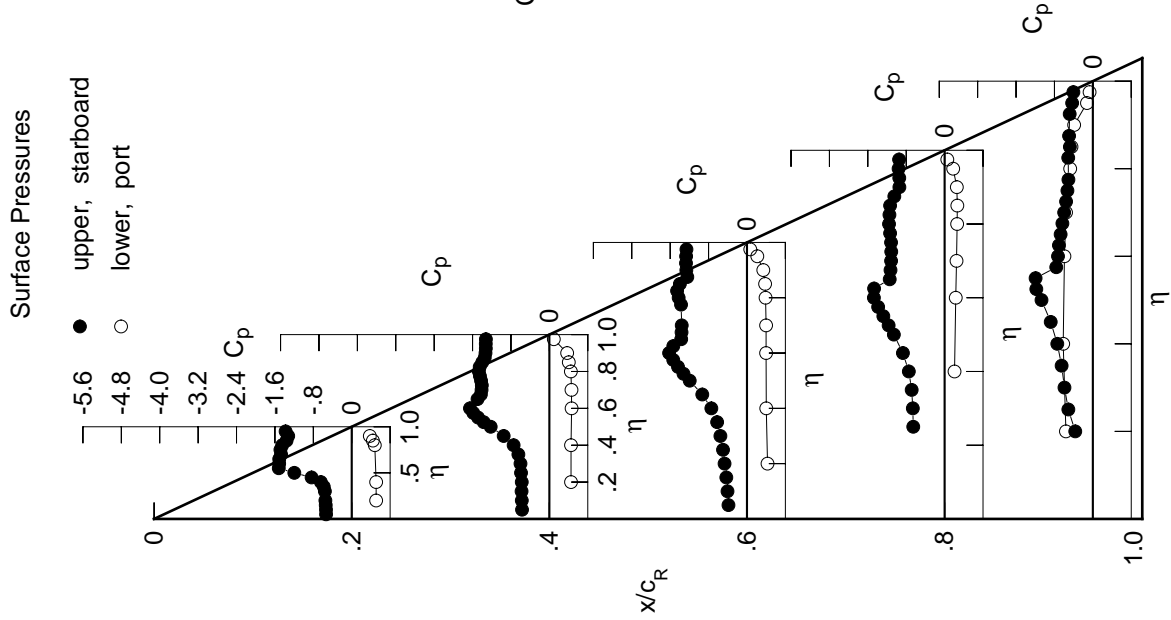

Table D4. Continued.

η	$x/c_R = .2$		$x/c_R = .4$		$x/c_R = .6$		$x/c_R = .8$		$x/c_R = .95$	
	$C_{p,u}$	$C_{p,u}$	$C_{p,u}$	$C_{p,u}$	$C_{p,u}$	$C_{p,u}$	$C_{p,u}$	$C_{p,u}$	$C_{p,u}$	$C_{p,u}$
0.050	-0.5733	-0.6039	-0.5297	*****	*****	*****	*****	*****	*****	*****
0.100	-0.5726	-0.6110	-0.5413	*****	*****	*****	*****	*****	*****	*****
0.150	-0.5811	-0.6133	-0.5589	*****	*****	*****	*****	*****	*****	*****
0.200	-0.5929	-0.6182	-0.5815	*****	*****	*****	*****	*****	*****	*****
0.250	*****	-0.6339	-0.6053	-0.6479	-0.4841	*****	*****	*****	*****	*****
0.300	-0.6083	-0.6587	-0.6554	-0.6783	-0.5835	*****	*****	*****	*****	*****
0.350	-0.6549	-0.7204	-0.7283	-0.7352	-0.6458	*****	*****	*****	*****	*****
0.400	-0.7540	-0.8504	-0.8630	-0.8289	-0.7397	*****	*****	*****	*****	*****
0.450	-0.9858	-1.0756	-1.0552	-0.9703	-0.8706	*****	*****	*****	*****	*****
0.500	-1.3222	-1.3248	-1.2969	-1.1558	-1.0602	*****	*****	*****	*****	*****
0.525	*****	-1.4499	-1.4073	-1.2573	-1.1618	*****	*****	*****	*****	*****
0.550	-1.5578	-1.5494	-1.5101	-1.3546	-1.0607	*****	*****	*****	*****	*****
0.575	*****	-1.6336	-1.5954	-1.4528	-0.7202	*****	*****	*****	*****	*****
0.600	-1.5131	-1.6908	-1.6703	-1.5297	-0.6927	*****	*****	*****	*****	*****
0.625	*****	*****	-1.5600	-1.3634	-0.6735	*****	*****	*****	*****	*****
0.650	-1.5140	-1.5006	-1.4349	-1.1755	-0.6410	*****	*****	*****	*****	*****
0.675	*****	-1.4702	-1.4282	-1.1554	-0.6097	*****	*****	*****	*****	*****
0.700	-1.5118	-1.4492	-1.4155	-1.1519	-0.5780	*****	*****	*****	*****	*****
0.725	*****	-1.4425	*****	-1.1392	-0.5451	*****	*****	*****	*****	*****
0.750	-1.5473	-1.4549	*****	-1.1312	-0.5349	*****	*****	*****	*****	*****
0.775	*****	-1.4839	-1.4214	-1.1327	-0.5403	*****	*****	*****	*****	*****
0.800	-1.5063	-1.5133	-1.4701	-1.1353	*****	*****	*****	*****	*****	*****
0.825	*****	-1.4887	-1.5016	-1.1267	-0.5584	*****	*****	*****	*****	*****
0.850	-1.3976	-1.4313	-1.4402	-1.1385	-0.5075	*****	*****	*****	*****	*****
0.875	*****	-1.3789	-1.2759	-1.0627	-0.5380	*****	*****	*****	*****	*****
0.900	-1.3634	-1.3645	-1.3008	-0.9433	*****	*****	*****	*****	*****	*****
0.925	*****	-1.3648	-1.3114	-0.9307	-0.5159	*****	*****	*****	*****	*****
0.950	-1.4184	-1.3661	-1.3085	-0.9521	-0.4596	*****	*****	*****	*****	*****
0.975	*****	-1.3678	-1.3079	-0.9457	-0.4326	*****	*****	*****	*****	*****
-0.200	$C_{p,l}$	0.4731	0.4441	*****	-0.5462	*****	*****	*****	*****	*****
-0.400	0.5355	0.4705	0.4226	0.2212	-0.6035	*****	*****	*****	*****	*****
-0.600	*****	0.4835	0.4136	0.2465	-0.5759	*****	*****	*****	*****	*****
-0.700	*****	0.4785	0.4149	0.2611	-0.5470	*****	*****	*****	*****	*****
-0.800	0.4926	0.4625	0.4004	0.2714	-0.4568	*****	*****	*****	*****	*****
-0.850	0.4497	0.4134	0.3869	0.2748	-0.4343	*****	*****	*****	*****	*****
-0.900	0.3804	0.3729	0.3424	0.2598	-0.3776	*****	*****	*****	*****	*****
-0.950	*****	*****	0.2084	0.1747	-0.1134	*****	*****	*****	*****	*****
-0.975	*****	0.0764	0.0557	0.0477	-0.0763	*****	*****	*****	*****	*****

Sharp Radius L.E.
 Run No. = 87 , Point No. = 1925
 $C_N = 1.110$, $C_m = -0.1750$
 $\alpha = 22.6^\circ$, $M_\infty = 0.830$
 $R_{mac} = 6.0 \times 10^6$

Surface Pressures Near Leading Edge

● / ◆ upper, starboard/port
 ○ / ◇ lower, starboard/port

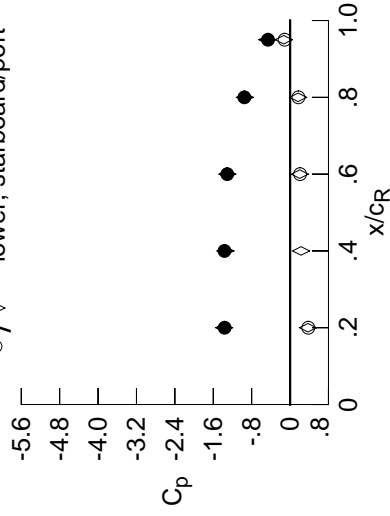

x/c_R	η	starb'd	port	starb'd	port
		$C_{p,u}$	$C_{p,u}$	$C_{p,l}$	$C_{p,l}$
0.20	0.90	-1.3634	-1.3746	0.3725	0.3804
0.40	0.95	-1.3661	-1.3480	0.2285	*****
0.60	0.95	-1.3085	-1.3080	0.2016	0.2084
0.80	0.95	-0.9521	-0.9415	0.1674	0.1747
0.95	0.95	-0.4596	-0.4762	-0.1318	-0.1134

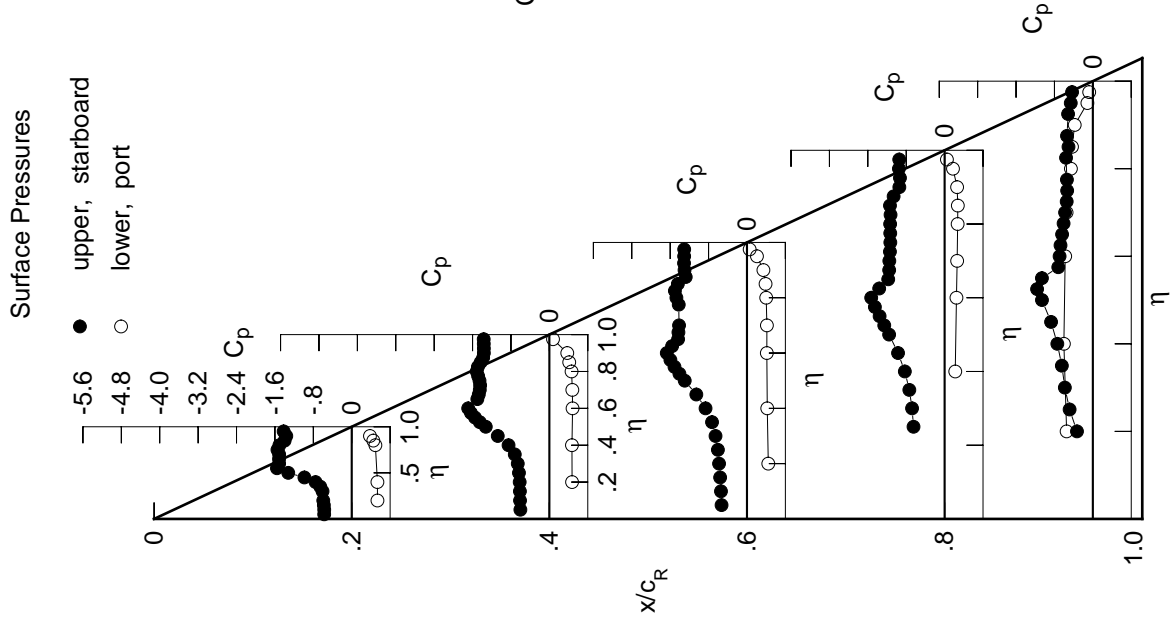

Table D4. Continued.

η	$x/c_R = .2$		$x/c_R = .4$		$x/c_R = .6$		$x/c_R = .8$		$x/c_R = .95$	
	$C_{p,u}$	$C_{p,l}$	$C_{p,u}$	$C_{p,l}$	$C_{p,u}$	$C_{p,l}$	$C_{p,u}$	$C_{p,l}$	$C_{p,u}$	$C_{p,l}$
0.050	-0.6056	-0.6430	-0.6081	*****	*****	*****	*****	*****	*****	*****
0.100	-0.6094	-0.6456	-0.6118	*****	*****	*****	*****	*****	*****	*****
0.150	-0.6204	-0.6487	-0.6245	*****	*****	*****	*****	*****	*****	*****
0.200	-0.6300	-0.6538	-0.6386	*****	*****	*****	*****	*****	*****	*****
0.250	*****	-0.6761	-0.6625	-0.6044	-0.4483	*****	*****	*****	*****	*****
0.300	-0.6602	-0.7149	-0.7155	-0.6483	-0.5284	*****	*****	*****	*****	*****
0.350	-0.7288	-0.7946	-0.8035	-0.7218	-0.5752	*****	*****	*****	*****	*****
0.400	-0.8655	-0.9478	-0.9441	-0.8363	-0.6734	*****	*****	*****	*****	*****
0.450	-1.1152	-1.1732	-1.1407	-0.9951	-0.8005	*****	*****	*****	*****	*****
0.500	-1.4175	-1.4023	-1.3635	-1.1963	-0.9532	*****	*****	*****	*****	*****
0.525	*****	-1.5076	-1.4638	-1.2885	-0.9758	*****	*****	*****	*****	*****
0.550	-1.5642	-1.5956	-1.5566	-1.3922	-0.6366	*****	*****	*****	*****	*****
0.575	*****	-1.6695	-1.6296	-1.4792	-0.5505	*****	*****	*****	*****	*****
0.600	-1.5326	-1.7104	-1.7005	-1.4085	-0.5197	*****	*****	*****	*****	*****
0.625	*****	*****	-1.5627	-1.1617	-0.5038	*****	*****	*****	*****	*****
0.650	-1.5306	-1.5179	-1.4779	-1.1475	-0.4984	*****	*****	*****	*****	*****
0.675	*****	-1.5102	-1.4638	-1.1430	-0.5024	*****	*****	*****	*****	*****
0.700	-1.5406	-1.4795	-1.4587	-1.1347	-0.5136	*****	*****	*****	*****	*****
0.725	*****	-1.4769	*****	-1.1019	-0.5301	*****	*****	*****	*****	*****
0.750	-1.6007	-1.4842	*****	-1.1025	-0.5384	*****	*****	*****	*****	*****
0.775	*****	-1.5146	-1.4561	-1.0999	-0.5458	*****	*****	*****	*****	*****
0.800	-1.5296	-1.5498	-1.5056	-1.1022	*****	*****	*****	*****	*****	*****
0.825	*****	-1.5204	-1.5395	-1.0831	-0.5451	*****	*****	*****	*****	*****
0.850	-1.4305	-1.4598	-1.4829	-1.0982	-0.5361	*****	*****	*****	*****	*****
0.875	*****	-1.4128	-1.3088	-1.0279	-0.5120	*****	*****	*****	*****	*****
0.900	-1.4043	-1.3981	-1.3285	-0.8818	*****	*****	*****	*****	*****	*****
0.925	*****	-1.4042	-1.3377	-0.8170	-0.4936	*****	*****	*****	*****	*****
0.950	-1.4523	-1.3995	-1.3437	-0.8097	-0.4467	*****	*****	*****	*****	*****
0.975	*****	-1.4063	-1.3410	-0.8028	-0.4274	*****	*****	*****	*****	*****
-0.200	$C_{p,l}$	0.5660	0.4943	0.4635	*****	*****	*****	*****	*****	*****
-0.400	*****	0.5619	0.4998	0.4399	0.2365	-0.5832	*****	*****	*****	*****
-0.600	*****	*****	0.5017	0.4303	0.2648	-0.5609	*****	*****	*****	*****
-0.700	*****	*****	0.4985	0.4315	0.2751	-0.5290	*****	*****	*****	*****
-0.800	0.5078	0.4773	0.4162	0.2886	-0.4421	*****	*****	*****	*****	*****
-0.850	0.4605	0.4237	0.3976	0.2891	-0.4197	*****	*****	*****	*****	*****
-0.900	0.3861	0.3790	0.3478	0.2706	-0.3613	*****	*****	*****	*****	*****
-0.950	*****	*****	*****	0.2062	0.1804	-0.1066	*****	*****	*****	*****
-0.975	*****	0.0767	0.0464	0.0516	-0.0739	*****	*****	*****	*****	*****

Sharp Radius L.E.
 Run No. = 87 , Point No. = 1926
 $C_N = 1.097$, $C_m = -0.1803$
 $\alpha = 23.6^\circ$, $M_\infty = 0.832$
 $R_{mac} = 6.0 \times 10^6$

Surface Pressures Near Leading Edge

● / ◆ upper, starboard/port
 ○ / ◇ lower, starboard/port

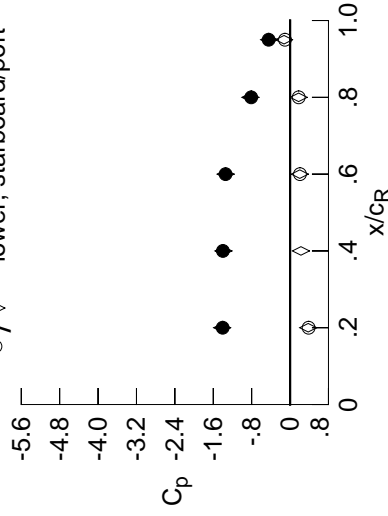

x/c_R	η	starb'd	port	starb'd	port
		$C_{p,u}$	$C_{p,l}$	$C_{p,u}$	$C_{p,l}$
0.20	0.90	-1.4043	-1.4152	0.3779	0.3861
0.40	0.95	-1.3995	-1.3892	0.2267	*****
0.60	0.95	-1.3437	-1.3436	0.2021	0.2062
0.80	0.95	-0.8097	-0.8273	0.1783	0.1804
0.95	0.95	-0.4467	-0.4353	-0.1256	-0.1066

Table D4. Continued.

η	$x/c_R = .2$		$x/c_R = .4$		$x/c_R = .6$		$x/c_R = .8$		$x/c_R = .95$	
	$C_{p,u}$	$C_{p,u}$	$C_{p,u}$	$C_{p,u}$	$C_{p,u}$	$C_{p,u}$	$C_{p,u}$	$C_{p,u}$	$C_{p,u}$	$C_{p,u}$
0.050	-0.6372	-0.6586	-0.0143	*****	*****	*****	*****	*****	*****	*****
0.100	-0.6422	-0.6635	-0.0271	*****	*****	*****	*****	*****	*****	*****
0.150	-0.6546	-0.6698	-0.0450	*****	*****	*****	*****	*****	*****	*****
0.200	-0.6682	-0.6784	-0.0767	*****	*****	*****	*****	*****	*****	*****
0.250	*****	-0.7085	-0.1186	-0.7241	-0.6204	*****	*****	*****	*****	*****
0.300	-0.7139	-0.7582	-0.1997	-0.7513	-0.6813	*****	*****	*****	*****	*****
0.350	-0.7977	-0.8476	-0.3195	-0.8241	-0.7418	*****	*****	*****	*****	*****
0.400	-0.9569	-1.0083	-0.5110	-0.8634	-0.7965	*****	*****	*****	*****	*****
0.450	-1.2088	-1.2203	-0.7493	-0.9078	-0.8044	*****	*****	*****	*****	*****
0.500	-1.4831	-1.4347	-1.0410	-0.9271	-0.7711	*****	*****	*****	*****	*****
0.525	*****	-1.5331	-1.1744	-0.9321	-0.7756	*****	*****	*****	*****	*****
0.550	-1.6798	-1.6163	-1.2962	-0.9343	-0.7601	*****	*****	*****	*****	*****
0.575	*****	-1.6868	-1.3691	-0.9347	-0.7729	*****	*****	*****	*****	*****
0.600	-1.5899	-1.7179	-1.1864	-0.9364	-0.7677	*****	*****	*****	*****	*****
0.625	*****	*****	-1.0330	-0.9240	-0.7674	*****	*****	*****	*****	*****
0.650	-1.5553	-1.5317	-1.0023	-0.9153	-0.7597	*****	*****	*****	*****	*****
0.675	*****	-1.5241	-0.9824	-0.9146	-0.7391	*****	*****	*****	*****	*****
0.700	-1.5316	-1.4981	-0.9740	-0.9072	-0.7278	*****	*****	*****	*****	*****
0.725	*****	-1.4924	*****	-0.8863	-0.7138	*****	*****	*****	*****	*****
0.750	-1.5539	-1.5010	*****	-0.8616	-0.6960	*****	*****	*****	*****	*****
0.775	*****	-1.5269	-0.8995	-0.8420	-0.6742	*****	*****	*****	*****	*****
0.800	-1.5211	-1.5678	-0.8707	-0.8313	*****	*****	*****	*****	*****	*****
0.825	*****	-1.5429	-0.8464	-0.8198	-0.6450	*****	*****	*****	*****	*****
0.850	-1.4517	-1.4744	-0.8318	-0.8187	-0.6012	*****	*****	*****	*****	*****
0.875	*****	-1.4237	-0.7667	-0.8078	-0.6200	*****	*****	*****	*****	*****
0.900	-1.4298	-1.4174	-0.7375	-0.7839	*****	*****	*****	*****	*****	*****
0.925	*****	-1.4217	-0.7093	-0.7804	-0.5983	*****	*****	*****	*****	*****
0.950	-1.4719	-1.4220	-0.6911	-0.7705	-0.5525	*****	*****	*****	*****	*****
0.975	*****	-1.4231	-0.6900	-0.7465	-0.5128	*****	*****	*****	*****	*****
-0.200	$C_{p,l}$	0.5162	0.4818	*****	*****	*****	*****	*****	*****	*****
-0.400	0.5898	0.5222	0.4574	0.2403	0.2403	0.2403	0.2403	0.2403	0.2403	0.2403
-0.600	*****	0.5245	0.4519	0.2684	0.2684	0.2684	0.2684	0.2684	0.2684	0.2684
-0.700	*****	0.5191	0.4540	0.2766	0.2766	0.2766	0.2766	0.2766	0.2766	0.2766
-0.800	0.5230	0.4950	0.4407	0.2895	0.2895	0.2895	0.2895	0.2895	0.2895	0.2895
-0.850	0.4726	0.4369	0.4263	0.2887	0.2887	0.2887	0.2887	0.2887	0.2887	0.2887
-0.900	0.3922	0.3881	0.3799	0.2706	0.2706	0.2706	0.2706	0.2706	0.2706	0.2706
-0.950	*****	*****	0.2518	0.1854	0.1854	0.1854	0.1854	0.1854	0.1854	0.1854
-0.975	*****	0.0700	0.1110	0.0623	0.0623	0.0623	0.0623	0.0623	0.0623	0.0623

Sharp Radius L.E.
 Run No. = 87 , Point No. = 1927
 $C_N = 1.080$, $C_m = -0.1716$
 $\alpha = 24.6^\circ$, $M_\infty = 0.830$
 $R_{mac} = 6.0 \times 10^6$

Surface Pressures Near Leading Edge

● / ◆ upper, starboard/port
 ○ / ◇ lower, starboard/port

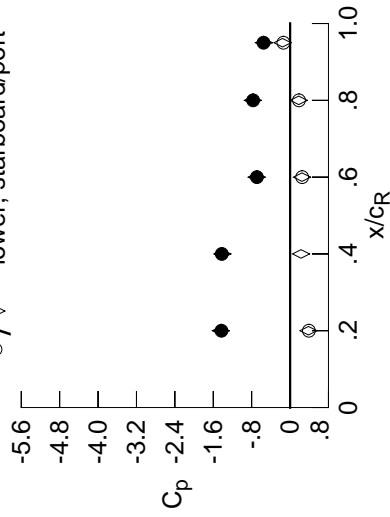

x/c_R	η	starb'd	port	starb'd	port
		$C_{p,u}$	$C_{p,u}$	$C_{p,l}$	$C_{p,l}$
0.20	0.90	-1.4298	-1.4435	0.3831	0.3922
0.40	0.95	-1.4220	-1.4103	0.2288	*****
0.60	0.95	-0.6911	-0.6973	0.2484	0.2518
0.80	0.95	-0.7705	-0.7761	0.1805	0.1854
0.95	0.95	-0.5525	-0.5453	-0.1573	-0.1383

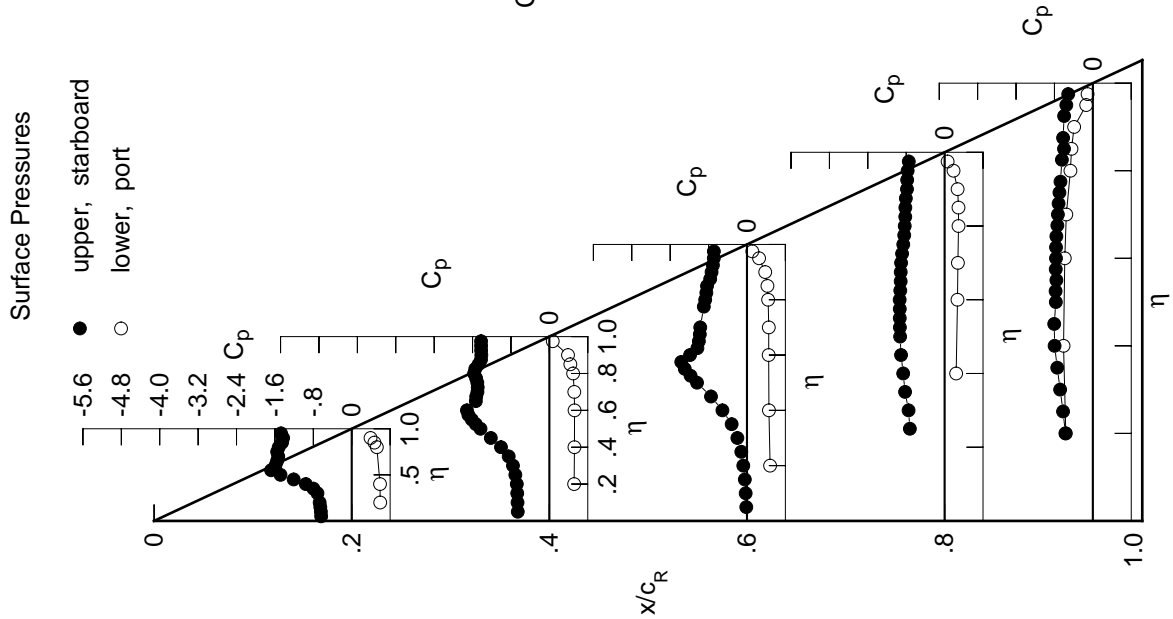

Table D4. Continued.

η	$x/c_R = .2$		$x/c_R = .4$		$x/c_R = .6$		$x/c_R = .8$		$x/c_R = .95$	
	$C_{p,u}$	$C_{p,l}$	$C_{p,u}$	$C_{p,l}$	$C_{p,u}$	$C_{p,l}$	$C_{p,u}$	$C_{p,l}$	$C_{p,u}$	$C_{p,l}$
0.050	-0.6809	-0.6893	-0.0552	*****	*****	*****	*****	*****	*****	*****
0.100	-0.6861	-0.6952	-0.0685	*****	*****	*****	*****	*****	*****	*****
0.150	-0.7018	-0.7080	-0.0840	*****	*****	*****	*****	*****	*****	*****
0.200	-0.7177	-0.7191	-0.1187	*****	*****	*****	*****	*****	*****	*****
0.250	*****	-0.7566	-0.1644	-0.8049	-0.7295	*****	*****	*****	*****	*****
0.300	-0.7856	-0.8162	-0.2475	-0.8062	-0.7779	*****	*****	*****	*****	*****
0.350	-0.8906	-0.9215	-0.3784	-0.8495	-0.7865	*****	*****	*****	*****	*****
0.400	-1.0582	-1.0932	-0.5719	-0.8531	-0.7955	*****	*****	*****	*****	*****
0.450	-1.3002	-1.3030	-0.7959	-0.8742	-0.7790	*****	*****	*****	*****	*****
0.500	-1.5475	-1.4956	-1.0676	-0.9011	-0.7593	*****	*****	*****	*****	*****
0.525	*****	-1.5828	-1.1902	-0.9076	-0.7689	*****	*****	*****	*****	*****
0.550	-1.7002	-1.6559	-1.2883	-0.9201	-0.7633	*****	*****	*****	*****	*****
0.575	*****	-1.7164	-1.3360	-0.9281	-0.7772	*****	*****	*****	*****	*****
0.600	-1.5824	-1.7356	-1.2223	-0.9381	-0.7757	*****	*****	*****	*****	*****
0.625	*****	*****	-1.0740	-0.9305	-0.7770	*****	*****	*****	*****	*****
0.650	-1.5748	-1.5635	-1.0272	-0.9229	-0.7724	*****	*****	*****	*****	*****
0.675	*****	-1.5582	-0.9985	-0.9213	-0.7516	*****	*****	*****	*****	*****
0.700	-1.5828	-1.5299	-0.9885	-0.9139	-0.7431	*****	*****	*****	*****	*****
0.725	*****	-1.5315	*****	-0.8974	-0.7296	*****	*****	*****	*****	*****
0.750	-1.6365	-1.5354	*****	-0.8769	-0.7127	*****	*****	*****	*****	*****
0.775	*****	-1.5690	-0.9146	-0.8619	-0.6933	*****	*****	*****	*****	*****
0.800	-1.5663	-1.6104	-0.8924	-0.8507	*****	*****	*****	*****	*****	*****
0.825	*****	-1.5865	-0.8717	-0.8406	-0.6635	*****	*****	*****	*****	*****
0.850	-1.4859	-1.5146	-0.8601	-0.8384	-0.6378	*****	*****	*****	*****	*****
0.875	*****	-1.4617	-0.8029	-0.8282	-0.6308	*****	*****	*****	*****	*****
0.900	-1.4642	-1.4490	-0.7863	-0.8009	*****	*****	*****	*****	*****	*****
0.925	*****	-1.4545	-0.7625	-0.7947	-0.6039	*****	*****	*****	*****	*****
0.950	-1.5044	-1.4535	-0.7495	-0.7847	-0.5583	*****	*****	*****	*****	*****
0.975	*****	-1.4547	-0.7467	-0.7590	-0.5188	*****	*****	*****	*****	*****
-0.200	0.6217	0.5420	0.5021	*****	-0.5472	*****	*****	*****	*****	*****
-0.400	0.6150	0.5445	0.4773	0.2597	-0.5934	*****	*****	*****	*****	*****
-0.600	*****	0.5473	0.4693	0.2840	-0.5695	*****	*****	*****	*****	*****
-0.700	*****	0.5402	0.4710	0.2935	-0.5363	*****	*****	*****	*****	*****
-0.800	0.5365	0.5103	0.4540	0.3037	-0.4529	*****	*****	*****	*****	*****
-0.850	0.4826	0.4466	0.4364	0.3012	-0.4297	*****	*****	*****	*****	*****
-0.900	0.3992	0.3934	0.3822	0.2789	-0.3736	*****	*****	*****	*****	*****
-0.950	*****	*****	0.2423	0.1830	-0.1339	*****	*****	*****	*****	*****
-0.975	*****	0.0639	0.0945	0.0547	-0.1159	*****	*****	*****	*****	*****

Sharp Radius L.E.
 Run No. = 87 , Point No. = 1928
 $C_N = 1.123$, $C_m = -0.1744$
 $\alpha = 25.6^\circ$, $M_\infty = 0.830$
 $R_{mac} = 6.0 \times 10^6$

Surface Pressures Near Leading Edge

● / ◆ upper, starboard/port
 ○ / ◇ lower, starboard/port

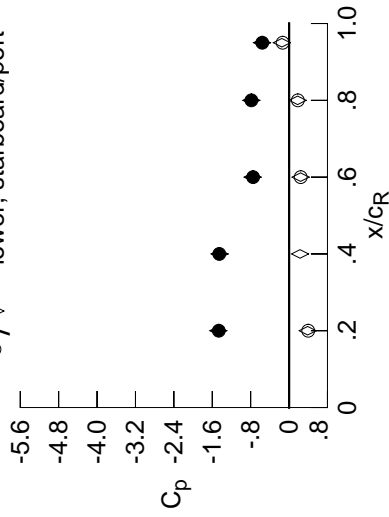

x/c_R	η	starb'd	port	starb'd	port
		$C_{p,u}$	$C_{p,l}$	$C_{p,u}$	$C_{p,l}$
0.20	0.90	-1.4642	-1.4753	0.3881	0.3992
0.40	0.95	-1.4535	-1.4481	0.2289	*****
0.60	0.95	-0.7495	-0.7606	0.2390	0.2423
0.80	0.95	-0.7847	-0.7873	0.1784	0.1830
0.95	0.95	-0.5583	-0.5633	-0.1508	-0.1339

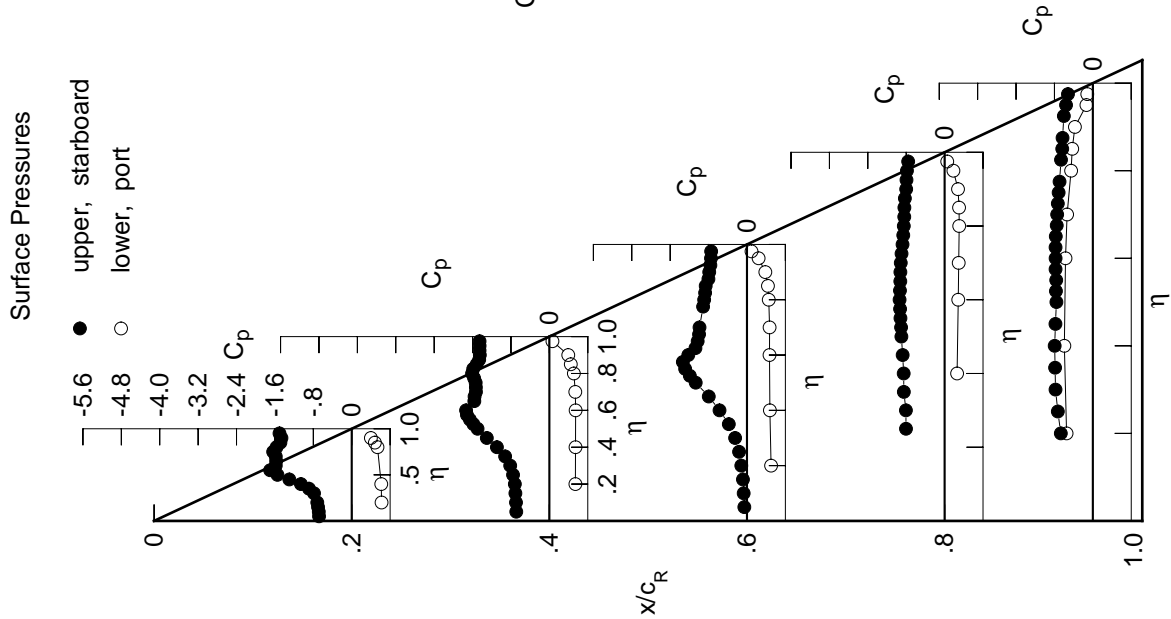

Table D4. Continued.

η	$x/c_R = .2$		$x/c_R = .4$		$x/c_R = .6$		$x/c_R = .8$		$x/c_R = .95$	
	$C_{p,u}$	$C_{p,l}$	$C_{p,u}$	$C_{p,l}$	$C_{p,u}$	$C_{p,l}$	$C_{p,u}$	$C_{p,l}$	$C_{p,u}$	$C_{p,l}$
0.050	-0.7278	-0.7240	-0.1280	*****	*****	*****	*****	*****	*****	*****
0.100	-0.7359	-0.7300	-0.1447	*****	*****	*****	*****	*****	*****	*****
0.150	-0.7494	-0.7452	-0.1572	*****	*****	*****	*****	*****	*****	*****
0.200	-0.7691	-0.7571	-0.1946	*****	*****	*****	*****	*****	*****	*****
0.250	*****	-0.8096	-0.2382	-0.9137	-0.8119	*****	*****	*****	*****	*****
0.300	-0.8565	-0.8771	-0.3302	-0.8823	-0.8567	*****	*****	*****	*****	*****
0.350	-0.9791	-0.9976	-0.4627	-0.8832	-0.8256	*****	*****	*****	*****	*****
0.400	-1.1544	-1.1662	-0.6501	-0.8522	-0.7867	*****	*****	*****	*****	*****
0.450	-1.3828	-1.3678	-0.8598	-0.8617	-0.7614	*****	*****	*****	*****	*****
0.500	-1.6009	-1.5413	-1.1029	-0.8898	-0.7599	*****	*****	*****	*****	*****
0.525	*****	-1.6202	-1.2065	-0.9124	-0.7806	*****	*****	*****	*****	*****
0.550	-1.7179	-1.6878	-1.2791	-0.9283	-0.7768	*****	*****	*****	*****	*****
0.575	*****	-1.7402	-1.3106	-0.9479	-0.7944	*****	*****	*****	*****	*****
0.600	-1.6115	-1.7562	-1.2271	-0.9614	-0.7934	*****	*****	*****	*****	*****
0.625	*****	*****	-1.0765	-0.9562	-0.7944	*****	*****	*****	*****	*****
0.650	-1.6046	-1.5943	-1.0283	-0.9466	-0.7903	*****	*****	*****	*****	*****
0.675	*****	-1.5857	-1.0147	-0.9474	-0.7685	*****	*****	*****	*****	*****
0.700	-1.6188	-1.5544	-1.0063	-0.9398	-0.7615	*****	*****	*****	*****	*****
0.725	*****	-1.5576	*****	-0.9258	-0.7447	*****	*****	*****	*****	*****
0.750	-1.6851	-1.5685	*****	-0.9080	-0.7310	*****	*****	*****	*****	*****
0.775	*****	-1.6010	-0.9499	-0.8990	-0.7083	*****	*****	*****	*****	*****
0.800	-1.5915	-1.6450	-0.9334	-0.8885	*****	*****	*****	*****	*****	*****
0.825	*****	-1.6223	-0.9154	-0.8805	-0.6730	*****	*****	*****	*****	*****
0.850	-1.5059	-1.5469	-0.9076	-0.8750	-0.6516	*****	*****	*****	*****	*****
0.875	*****	-1.4916	-0.8560	-0.8655	-0.6407	*****	*****	*****	*****	*****
0.900	-1.4853	-1.4818	-0.8568	-0.8365	*****	*****	*****	*****	*****	*****
0.925	*****	-1.4856	-0.8392	-0.8296	-0.6098	*****	*****	*****	*****	*****
0.950	-1.5274	-1.4871	-0.8237	-0.8162	-0.5656	*****	*****	*****	*****	*****
0.975	*****	-1.4835	-0.8210	-0.7870	-0.5279	*****	*****	*****	*****	*****
-0.200	0.6455	0.5659	0.5215	*****	*****	*****	*****	*****	*****	*****
-0.400	0.6421	0.5670	0.4940	0.2783	0.5750	*****	*****	*****	*****	*****
-0.600	*****	0.5671	0.4893	0.2982	0.5509	*****	*****	*****	*****	*****
-0.700	*****	0.5579	0.4838	0.3062	0.5179	*****	*****	*****	*****	*****
-0.800	0.5497	0.5231	0.4657	0.3153	-0.4389	*****	*****	*****	*****	*****
-0.850	0.4915	0.4568	0.4455	0.3120	-0.4142	*****	*****	*****	*****	*****
-0.900	0.4030	0.3977	0.3847	0.2832	-0.3571	*****	*****	*****	*****	*****
-0.950	*****	*****	0.2339	0.1781	-0.1274	*****	*****	*****	*****	*****
-0.975	*****	0.0572	0.0785	0.0415	-0.1179	*****	*****	*****	*****	*****

Sharp Radius L.E.
 Run No. = 87 , Point No. = 1929
 $C_N = 1.179$, $C_m = -0.1845$
 $\alpha = 26.7^\circ$, $M_\infty = 0.830$
 $R_{mac} = 6.0 \times 10^6$

Surface Pressures Near Leading Edge

● / ◆ upper, starboard/port
 ○ / ◇ lower, starboard/port

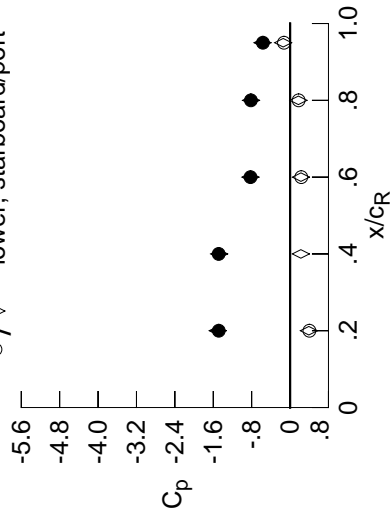

x/c_R	η	starb'd	port	starb'd	port
		$C_{p,u}$	$C_{p,l}$	$C_{p,u}$	$C_{p,l}$
0.20	0.90	-1.4853	-1.5081	0.3910	0.4030
0.40	0.95	-1.4871	-1.4773	0.2245	*****
0.60	0.95	-0.8237	-0.8268	0.2261	0.2339
0.80	0.95	-0.8162	-0.8125	0.1737	0.1781
0.95	0.95	-0.5656	-0.5755	-0.1438	-0.1274

Surface Pressures

● upper, starboard
 ○ lower, port

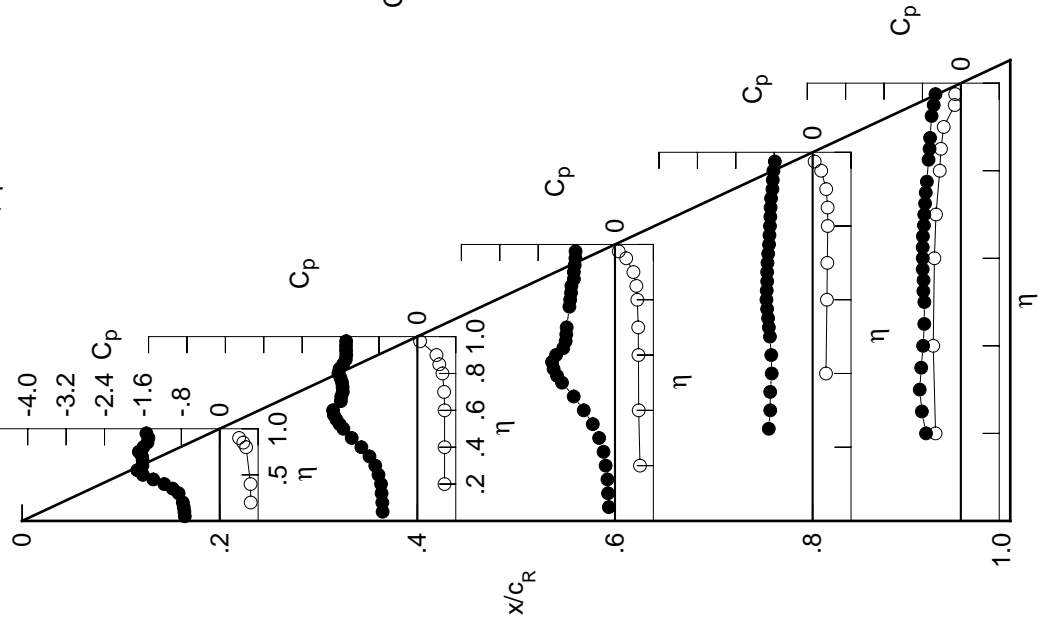

Table D4. Concluded.

η	$x/c_R = .2$		$x/c_R = .4$		$x/c_R = .6$		$x/c_R = .8$		$x/c_R = .95$	
	$C_{p,u}$	$C_{p,l}$	$C_{p,u}$	$C_{p,l}$	$C_{p,u}$	$C_{p,l}$	$C_{p,u}$	$C_{p,l}$	$C_{p,u}$	$C_{p,l}$
0.050	-0.0134	-0.0032	0.1231	*****	*****	*****	*****	*****	*****	*****
0.100	-0.0101	-0.0038	0.1107	*****	*****	*****	*****	*****	*****	*****
0.150	-0.0138	-0.0020	0.0978	*****	*****	*****	*****	*****	*****	*****
0.200	-0.0205	-0.0029	0.0856	*****	*****	*****	*****	*****	*****	*****
0.250	*****	-0.0037	0.0733	-0.1332	-0.3177	*****	*****	*****	*****	*****
0.300	-0.0424	-0.0032	0.0616	-0.1156	-0.3402	*****	*****	*****	*****	*****
0.350	-0.0521	-0.0068	0.0529	-0.1071	-0.3642	*****	*****	*****	*****	*****
0.400	-0.0599	-0.0080	0.0418	-0.0987	-0.3750	*****	*****	*****	*****	*****
0.450	-0.0686	-0.0120	0.0395	-0.0935	-0.3830	*****	*****	*****	*****	*****
0.500	-0.0730	-0.0152	0.0286	-0.0907	-0.3944	*****	*****	*****	*****	*****
0.525	*****	-0.0167	0.0219	-0.0852	-0.4113	*****	*****	*****	*****	*****
0.550	-0.0743	-0.0168	0.0197	-0.0834	-0.4249	*****	*****	*****	*****	*****
0.575	*****	-0.0232	0.0196	-0.0835	-0.4501	*****	*****	*****	*****	*****
0.600	-0.0585	-0.0256	0.0120	-0.0807	-0.4777	*****	*****	*****	*****	*****
0.625	*****	*****	0.0084	-0.0799	-0.5136	*****	*****	*****	*****	*****
0.650	-0.0468	-0.0278	0.0058	-0.0758	-0.5596	*****	*****	*****	*****	*****
0.675	*****	-0.0389	-0.0026	-0.0793	-0.6069	*****	*****	*****	*****	*****
0.700	-0.0419	-0.0605	-0.0039	-0.0769	-0.6572	*****	*****	*****	*****	*****
0.725	*****	-0.0761	*****	-0.0821	-0.7011	*****	*****	*****	*****	*****
0.750	-0.0268	-0.0796	*****	-0.0791	-0.7283	*****	*****	*****	*****	*****
0.775	*****	-0.0868	-0.0212	-0.0869	-0.7325	*****	*****	*****	*****	*****
0.800	-0.0089	-0.0837	-0.0506	-0.0908	*****	*****	*****	*****	*****	*****
0.825	*****	-0.0782	-0.0712	-0.0908	-0.7575	*****	*****	*****	*****	*****
0.850	0.0180	-0.0668	-0.0712	-0.1175	-0.5990	*****	*****	*****	*****	*****
0.875	*****	-0.0505	-0.0701	-0.1429	-0.6234	*****	*****	*****	*****	*****
0.900	0.0562	-0.0284	-0.0580	-0.1399	*****	*****	*****	*****	*****	*****
0.925	*****	0.0044	-0.0343	-0.1147	-0.6226	*****	*****	*****	*****	*****
0.950	0.1024	0.0441	0.0063	-0.0770	-0.3465	*****	*****	*****	*****	*****
0.975	*****	0.0952	0.0689	-0.0003	-0.1680	*****	*****	*****	*****	*****
-0.200	-0.0404	-0.0004	0.0814	*****	-0.3011	*****	*****	*****	*****	*****
-0.400	-0.0562	-0.0025	0.0400	-0.0962	-0.3699	*****	*****	*****	*****	*****
-0.600	*****	-0.0170	0.0108	-0.0860	-0.4628	*****	*****	*****	*****	*****
-0.700	*****	-0.0584	-0.0065	-0.0840	-0.6801	*****	*****	*****	*****	*****
-0.800	-0.0278	-0.0876	-0.0592	-0.0947	-0.7536	*****	*****	*****	*****	*****
-0.850	0.0055	-0.0704	-0.0800	-0.1363	-0.7352	*****	*****	*****	*****	*****
-0.900	0.0434	-0.0393	-0.0800	-0.1558	-0.9174	*****	*****	*****	*****	*****
-0.950	*****	*****	-0.0096	-0.1023	-0.3666	*****	*****	*****	*****	*****
-0.975	*****	0.0854	0.0479	-0.0265	-0.1954	*****	*****	*****	*****	*****

Sharp Radius L.E.
 Run No. = 87 , Point No. = 1930
 $C_N = -0.026$, $C_m = 0.0123$
 $\alpha = 0.0^\circ$, $M_\infty = 0.830$
 $R_{mac} = 6.0 \times 10^6$

Surface Pressures Near Leading Edge

● / ◆ upper, starboard/port
 ○ / ◇ lower, starboard/port

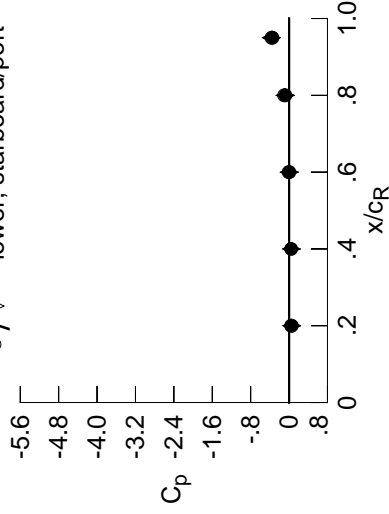

x/c_R	η	starb'd	port	starb'd	port
		$C_{p,u}$	$C_{p,l}$	$C_{p,u}$	$C_{p,l}$
0.20	0.90	0.0562	0.0601	0.0473	0.0434
0.40	0.95	0.0441	0.0516	0.0458	*****
0.60	0.95	0.0063	0.0115	-0.0044	-0.0096
0.80	0.95	-0.0770	-0.0702	-0.0910	-0.1023
0.95	0.95	-0.3465	-0.3660	-0.3762	-0.3666

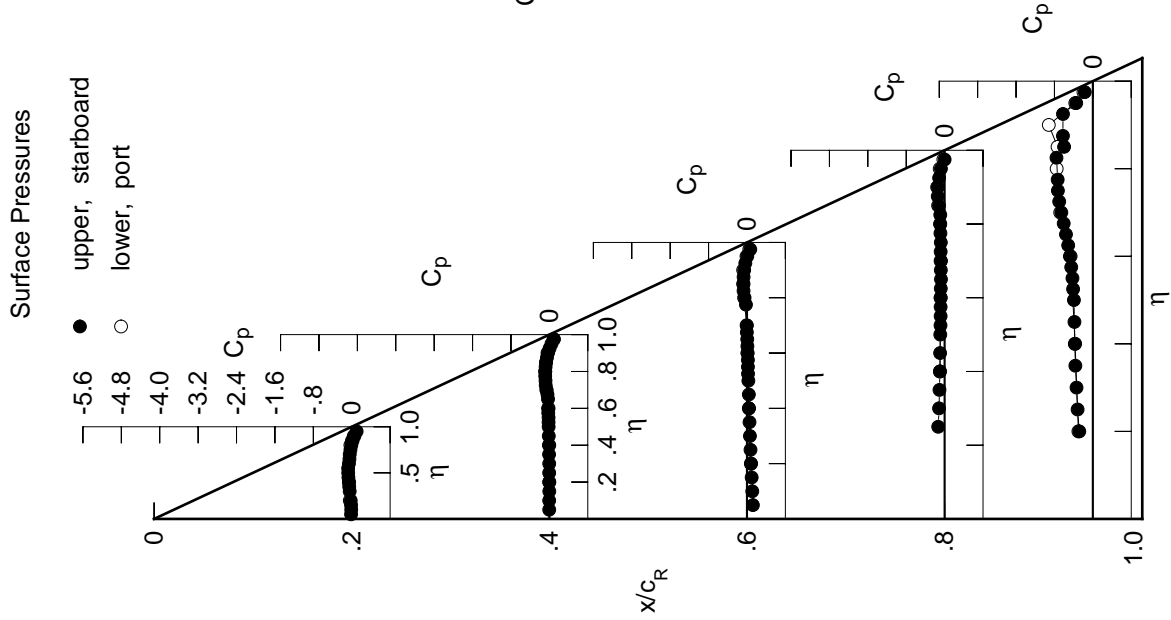

Table D5. Tabulations and Plots of Surface Pressure Coefficients.

η	$x/c_R = .2$		$x/c_R = .4$		$x/c_R = .6$		$x/c_R = .8$		$x/c_R = .95$	
	$C_{p,u}$	$C_{p,l}$	$C_{p,u}$	$C_{p,l}$	$C_{p,u}$	$C_{p,l}$	$C_{p,u}$	$C_{p,l}$	$C_{p,u}$	$C_{p,l}$
0.050	-0.0079	0.0049	0.1369	0.1369	0.1369	0.1369	0.1369	0.1369	0.1369	0.1369
0.100	-0.0048	0.0054	0.1259	0.1259	0.1259	0.1259	0.1259	0.1259	0.1259	0.1259
0.150	-0.0040	0.0060	0.1120	0.1120	0.1120	0.1120	0.1120	0.1120	0.1120	0.1120
0.200	-0.0113	0.0082	0.0975	0.0975	0.0975	0.0975	0.0975	0.0975	0.0975	0.0975
0.250	*****	0.0041	0.0881	-0.1301	0.0881	-0.1301	0.0881	-0.1301	0.0881	-0.1301
0.300	-0.0314	0.0074	0.0743	-0.1156	0.0743	-0.1156	0.0743	-0.1156	0.0743	-0.1156
0.350	-0.0405	0.0035	0.0681	-0.1037	0.0681	-0.1037	0.0681	-0.1037	0.0681	-0.1037
0.400	-0.0476	0.0019	0.0585	-0.0932	0.0585	-0.0932	0.0585	-0.0932	0.0585	-0.0932
0.450	-0.0566	-0.0020	0.0563	-0.0886	0.0563	-0.0886	0.0563	-0.0886	0.0563	-0.0886
0.500	-0.0610	-0.0035	0.0403	-0.0804	0.0403	-0.0804	0.0403	-0.0804	0.0403	-0.0804
0.525	*****	-0.0067	0.0397	-0.0812	0.0397	-0.0812	0.0397	-0.0812	0.0397	-0.0812
0.550	-0.0612	-0.0075	0.0368	-0.0771	0.0368	-0.0771	0.0368	-0.0771	0.0368	-0.0771
0.575	*****	-0.0132	0.0353	-0.0766	0.0353	-0.0766	0.0353	-0.0766	0.0353	-0.0766
0.600	-0.0426	-0.0144	0.0287	-0.0716	0.0287	-0.0716	0.0287	-0.0716	0.0287	-0.0716
0.625	*****	*****	0.0242	-0.0698	0.0242	-0.0698	0.0242	-0.0698	0.0242	-0.0698
0.650	-0.0324	-0.0204	0.0218	-0.0683	0.0218	-0.0683	0.0218	-0.0683	0.0218	-0.0683
0.675	*****	-0.0291	0.0146	-0.0679	0.0146	-0.0679	0.0146	-0.0679	0.0146	-0.0679
0.700	-0.0236	-0.0378	0.0119	-0.0678	0.0119	-0.0678	0.0119	-0.0678	0.0119	-0.0678
0.725	*****	-0.0509	*****	-0.0677	*****	-0.0677	*****	-0.0677	*****	-0.0677
0.750	-0.0086	-0.0613	*****	-0.0705	*****	-0.0705	*****	-0.0705	*****	-0.0705
0.775	*****	-0.0699	-0.0057	-0.0719	-0.0057	-0.0719	-0.0057	-0.0719	-0.0057	-0.0719
0.800	0.0114	-0.0664	-0.0285	-0.0771	-0.0285	-0.0771	-0.0285	-0.0771	-0.0285	-0.0771
0.825	*****	-0.0543	-0.0366	-0.0813	-0.0366	-0.0813	-0.0366	-0.0813	-0.0366	-0.0813
0.850	0.0371	-0.0430	-0.0467	-0.0993	-0.0467	-0.0993	-0.0467	-0.0993	-0.0467	-0.0993
0.875	*****	-0.0296	-0.0408	-0.1160	-0.0408	-0.1160	-0.0408	-0.1160	-0.0408	-0.1160
0.900	0.0759	-0.0062	-0.0276	-0.1113	-0.0276	-0.1113	-0.0276	-0.1113	-0.0276	-0.1113
0.925	*****	0.0286	-0.0031	-0.0840	-0.0031	-0.0840	-0.0031	-0.0840	-0.0031	-0.0840
0.950	0.1227	0.0678	0.0379	-0.0485	0.0379	-0.0485	0.0379	-0.0485	0.0379	-0.0485
0.975	*****	0.1164	0.0969	0.0277	0.0969	0.0277	0.0969	0.0277	0.0969	0.0277

η	$C_{p,i}$		$C_{p,l}$		$C_{p,i}$		$C_{p,l}$	
	port	starb'd	port	starb'd	port	starb'd	port	starb'd
-0.200	-0.0462	-0.0080	0.0896	0.0896	0.0896	0.0896	0.0896	0.0896
-0.400	-0.0727	-0.0069	0.0431	-0.1068	0.0431	-0.1068	0.0431	-0.1068
-0.600	*****	-0.0184	0.0114	-0.0903	0.0114	-0.0903	0.0114	-0.0903
-0.700	*****	-0.0759	-0.0051	-0.0897	-0.0051	-0.0897	-0.0051	-0.0897
-0.800	-0.0434	-0.1087	-0.0755	-0.0927	-0.0755	-0.0927	-0.0755	-0.0927
-0.850	-0.0107	-0.0887	-0.0978	-0.1479	-0.0978	-0.1479	-0.0978	-0.1479
-0.900	0.0282	-0.0618	-0.1000	-0.1750	-0.1000	-0.1750	-0.1000	-0.1750
-0.950	*****	*****	-0.0303	-0.1263	-0.0303	-0.1263	-0.0303	-0.1263
-0.975	*****	0.0629	0.0252	-0.0526	0.0252	-0.0526	0.0252	-0.0526

Sharp Radius L.E.

Run No. = 89, Point No. = 1960

$C_N = -0.038$, $C_m = 0.0110$

$\alpha = -0.4^\circ$, $M_\infty = 0.871$

$R_{mac} = 5.9 \times 10^6$

Surface Pressures Near Leading Edge

● / ◆ upper, starboard/port
○ / ◇ lower, starboard/port

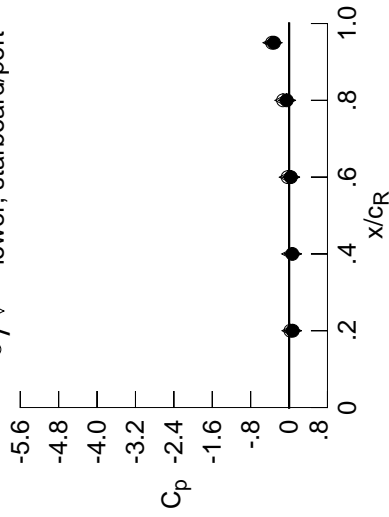

x/c_R	η	starb'd	port	starb'd	port
0.20	0.90	0.0759	0.0787	0.0313	0.0282
0.40	0.95	0.0678	0.0769	0.0252	*****
0.60	0.95	0.0379	0.0398	-0.0244	-0.0303
0.80	0.95	-0.0485	-0.0436	-0.1171	-0.1263
0.95	0.95	-0.3134	-0.3274	-0.3647	-0.3551

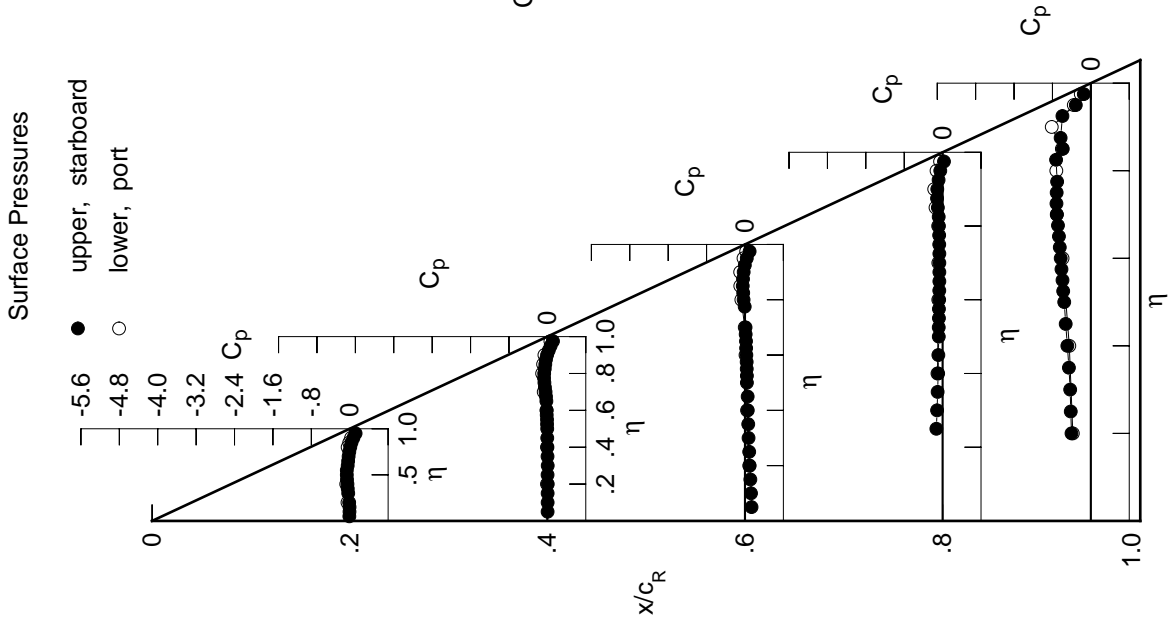

Table D5. Continued.

η	$x/c_R = .2$		$x/c_R = .4$		$x/c_R = .6$		$x/c_R = .8$		$x/c_R = .95$	
	$C_{p,u}$	$C_{p,l}$	$C_{p,u}$	$C_{p,l}$	$C_{p,u}$	$C_{p,l}$	$C_{p,u}$	$C_{p,l}$	$C_{p,u}$	$C_{p,l}$
0.050	-0.0108	0.0000	0.1334	*****	*****	*****	*****	*****	*****	*****
0.100	-0.0067	-0.0010	0.1237	*****	*****	*****	*****	*****	*****	*****
0.150	-0.0124	0.0007	0.1075	*****	*****	*****	*****	*****	*****	*****
0.200	-0.0178	0.0029	0.0952	*****	*****	*****	*****	*****	*****	*****
0.250	*****	-0.0018	0.0827	-0.1348	-0.4021	*****	*****	*****	*****	*****
0.300	-0.0408	-0.0002	0.0725	-0.1206	-0.4051	*****	*****	*****	*****	*****
0.350	-0.0490	-0.0036	0.0626	-0.1075	-0.4349	*****	*****	*****	*****	*****
0.400	-0.0589	-0.0066	0.0548	-0.0998	-0.4668	*****	*****	*****	*****	*****
0.450	-0.0660	-0.0078	0.0500	-0.0918	-0.4976	*****	*****	*****	*****	*****
0.500	-0.0701	-0.0108	0.0373	-0.0855	-0.5343	*****	*****	*****	*****	*****
0.525	*****	-0.0133	0.0315	-0.0858	-0.5595	*****	*****	*****	*****	*****
0.550	-0.0723	-0.0170	0.0311	-0.0849	-0.5797	*****	*****	*****	*****	*****
0.575	*****	-0.0212	0.0280	-0.0808	-0.5930	*****	*****	*****	*****	*****
0.600	-0.0561	-0.0204	0.0206	-0.0790	-0.6158	*****	*****	*****	*****	*****
0.625	*****	*****	0.0176	-0.0718	-0.6304	*****	*****	*****	*****	*****
0.650	-0.0437	-0.0275	0.0149	-0.0725	-0.6559	*****	*****	*****	*****	*****
0.675	*****	-0.0380	0.0079	-0.0732	-0.6793	*****	*****	*****	*****	*****
0.700	-0.0377	-0.0550	0.0055	-0.0721	-0.7049	*****	*****	*****	*****	*****
0.725	*****	-0.0706	*****	-0.0723	-0.7142	*****	*****	*****	*****	*****
0.750	-0.0221	-0.0800	*****	-0.0737	-0.7125	*****	*****	*****	*****	*****
0.775	*****	-0.0846	-0.0156	-0.0782	-0.7018	*****	*****	*****	*****	*****
0.800	-0.0046	-0.0837	-0.0420	-0.0854	*****	*****	*****	*****	*****	*****
0.825	*****	-0.0730	-0.0593	-0.0888	-0.7062	*****	*****	*****	*****	*****
0.850	0.0224	-0.0632	-0.0621	-0.1156	-0.5490	*****	*****	*****	*****	*****
0.875	*****	-0.0499	-0.0625	-0.1378	-0.5431	*****	*****	*****	*****	*****
0.900	0.0626	-0.0272	-0.0485	-0.1333	*****	*****	*****	*****	*****	*****
0.925	*****	0.0081	-0.0252	-0.1083	-0.5643	*****	*****	*****	*****	*****
0.950	0.1081	0.0487	0.0167	-0.0754	-0.3243	*****	*****	*****	*****	*****
0.975	*****	0.0967	0.0767	0.0059	-0.1644	*****	*****	*****	*****	*****
-0.200	-0.0319	0.0076	0.0987	*****	-0.3837	*****	*****	*****	*****	*****
-0.400	-0.0357	0.0064	0.0546	-0.0955	-0.4567	*****	*****	*****	*****	*****
-0.600	*****	-0.0103	0.0242	-0.0759	-0.5980	*****	*****	*****	*****	*****
-0.700	*****	-0.0539	0.0083	-0.0779	-0.7023	*****	*****	*****	*****	*****
-0.800	-0.0245	-0.0859	-0.0518	-0.0821	-0.7096	*****	*****	*****	*****	*****
-0.850	0.0079	-0.0672	-0.0737	-0.1319	-0.6355	*****	*****	*****	*****	*****
-0.900	0.0473	-0.0362	-0.0722	-0.1530	-0.8430	*****	*****	*****	*****	*****
-0.950	*****	*****	-0.0015	-0.0968	-0.3358	*****	*****	*****	*****	*****
-0.975	*****	0.0874	0.0552	-0.0223	-0.1855	*****	*****	*****	*****	*****

Sharp Radius L.E.

Run No. = 89, Point No. = 1961

$C_N = -0.025$, $C_m = 0.0106$

$\alpha = 0.0^\circ$, $M_\infty = 0.871$

$R_{mac} = 6.0 \times 10^6$

Surface Pressures Near Leading Edge

●/◆ upper, starboard/port
○/◇ lower, starboard/port

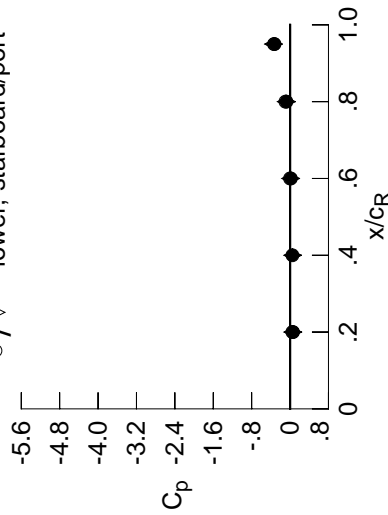

x/c_R	η	$C_{p,u}$ starb'd	$C_{p,u}$ port	$C_{p,l}$ starb'd	$C_{p,l}$ port
0.20	0.90	0.0626	0.0628	0.0503	0.0473
0.40	0.95	0.0487	0.0567	0.0508	*****
0.60	0.95	0.0167	0.0193	0.0045	-0.0015
0.80	0.95	-0.0754	-0.0680	-0.0869	-0.0968
0.95	0.95	-0.3243	-0.3432	-0.3502	-0.3358

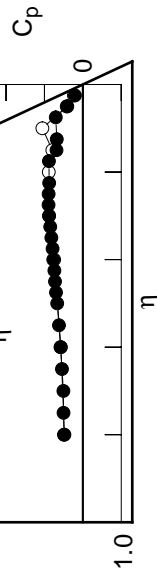

Table D5. Continued.

η	$x/c_R = .2$		$x/c_R = .4$		$x/c_R = .6$		$x/c_R = .8$		$x/c_R = .95$	
	$C_{p,u}$	$C_{p,l}$	$C_{p,u}$	$C_{p,l}$	$C_{p,u}$	$C_{p,l}$	$C_{p,u}$	$C_{p,l}$	$C_{p,u}$	$C_{p,l}$
0.050	-0.0309	-0.0207	0.1206	*****	*****	*****	*****	*****	*****	*****
0.100	-0.0300	-0.0180	0.1086	*****	*****	*****	*****	*****	*****	*****
0.150	-0.0356	-0.0174	0.0947	*****	*****	*****	*****	*****	*****	*****
0.200	-0.0429	-0.0172	0.0812	*****	*****	*****	*****	*****	*****	*****
0.250	*****	-0.0214	0.0685	-0.1488	-0.3760	*****	*****	*****	*****	*****
0.300	-0.0645	-0.0208	0.0555	-0.1343	-0.3840	*****	*****	*****	*****	*****
0.350	-0.0726	-0.0230	0.0459	-0.1238	-0.4018	*****	*****	*****	*****	*****
0.400	-0.0793	-0.0274	0.0383	-0.1140	-0.4306	*****	*****	*****	*****	*****
0.450	-0.0879	-0.0294	0.0335	-0.1075	-0.4638	*****	*****	*****	*****	*****
0.500	-0.0951	-0.0345	0.0179	-0.1022	-0.4766	*****	*****	*****	*****	*****
0.525	*****	-0.0369	0.0131	-0.1008	-0.4958	*****	*****	*****	*****	*****
0.550	-0.0999	-0.0409	0.0104	-0.1013	-0.5065	*****	*****	*****	*****	*****
0.575	*****	-0.0448	0.0085	-0.0997	-0.5293	*****	*****	*****	*****	*****
0.600	-0.0873	-0.0482	-0.0010	-0.0985	-0.5412	*****	*****	*****	*****	*****
0.625	*****	*****	-0.0040	-0.0936	-0.5581	*****	*****	*****	*****	*****
0.650	-0.0765	-0.0588	-0.0101	-0.0939	-0.5899	*****	*****	*****	*****	*****
0.675	*****	-0.0716	-0.0175	-0.0919	-0.6266	*****	*****	*****	*****	*****
0.700	-0.0702	-0.0840	-0.0236	-0.0954	-0.6764	*****	*****	*****	*****	*****
0.725	*****	-0.1004	*****	-0.0953	-0.7091	*****	*****	*****	*****	*****
0.750	-0.0586	-0.1085	*****	-0.0988	-0.7178	*****	*****	*****	*****	*****
0.775	*****	-0.1239	-0.0513	-0.1060	-0.7022	*****	*****	*****	*****	*****
0.800	-0.0424	-0.1257	-0.0783	-0.1162	*****	*****	*****	*****	*****	*****
0.825	*****	-0.1183	-0.0929	-0.1236	-0.6401	*****	*****	*****	*****	*****
0.850	-0.0166	-0.1126	-0.1082	-0.1564	-0.5198	*****	*****	*****	*****	*****
0.875	*****	-0.1003	-0.1086	-0.1824	-0.5135	*****	*****	*****	*****	*****
0.900	0.0225	-0.0799	-0.1009	-0.1859	*****	*****	*****	*****	*****	*****
0.925	*****	-0.0444	-0.0823	-0.1629	-0.4949	*****	*****	*****	*****	*****
0.950	0.0679	-0.0058	-0.0421	-0.1390	-0.3606	*****	*****	*****	*****	*****
0.975	*****	0.0378	0.0154	-0.0632	-0.2134	*****	*****	*****	*****	*****
-0.200	-0.0056	0.0217	0.1114	*****	-0.4205	*****	*****	*****	*****	*****
-0.400	-0.0255	0.0248	0.0660	-0.0838	-0.4933	*****	*****	*****	*****	*****
-0.600	*****	0.0060	0.0412	-0.0637	-0.6439	*****	*****	*****	*****	*****
-0.700	*****	-0.0278	0.0269	-0.0615	-0.7022	*****	*****	*****	*****	*****
-0.800	0.0118	-0.0465	-0.0174	-0.0614	-0.6942	*****	*****	*****	*****	*****
-0.850	0.0438	-0.0256	-0.0345	-0.0889	-0.7091	*****	*****	*****	*****	*****
-0.900	0.0826	0.0115	-0.0229	-0.1023	-0.8630	*****	*****	*****	*****	*****
-0.950	*****	*****	0.0503	-0.0401	-0.3016	*****	*****	*****	*****	*****
-0.975	*****	0.1314	0.1068	0.0347	-0.1421	*****	*****	*****	*****	*****

Sharp Radius L.E.
 Run No. = 89 , Point No. = 1962
 $C_N = 0.019$, $C_m = 0.0025$
 $\alpha = 1.1^\circ$, $M_\infty = 0.871$
 $R_{mac} = 6.0 \times 10^6$

Surface Pressures Near Leading Edge

● / ◆ upper, starboard/port
 ○ / ◇ lower, starboard/port

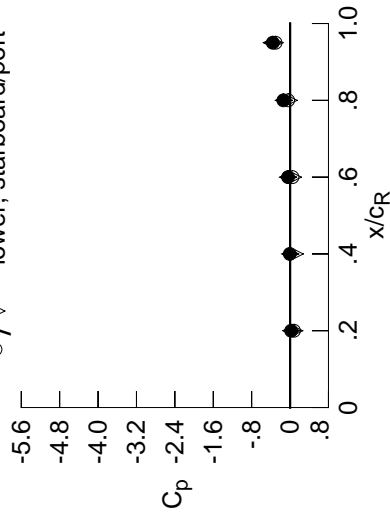

x/c_R	η	starb'd	port	$C_{p,u}$	starb'd	port	$C_{p,l}$
0.20	0.90	0.0225	0.0238	0.0867	0.0826	0.0867	0.0826
0.40	0.95	-0.0058	0.0033	0.0979	*****	0.0979	*****
0.60	0.95	-0.0421	-0.0423	0.0566	0.0503	0.0566	0.0503
0.80	0.95	-0.1390	-0.1307	-0.0309	-0.0401	-0.0309	-0.0401
0.95	0.95	-0.3606	-0.3805	-0.3244	-0.3016	-0.3244	-0.3016

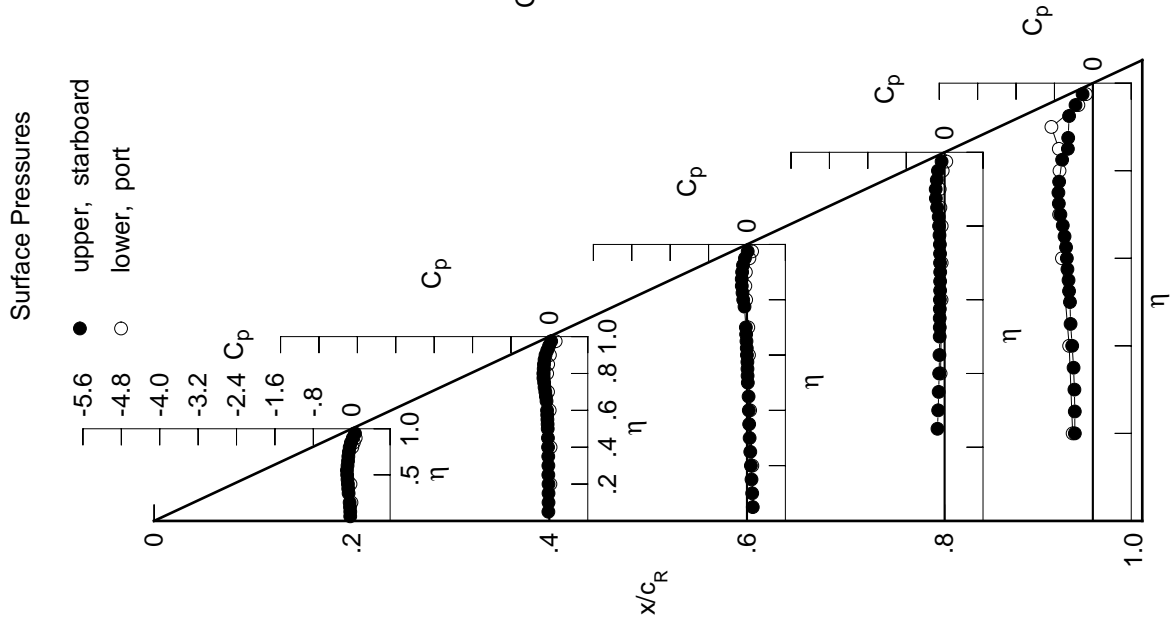

Table D5. Continued.

η	$x/c_R = .2$		$x/c_R = .4$		$x/c_R = .6$		$x/c_R = .8$		$x/c_R = .95$	
	$C_{p,u}$	$C_{p,l}$	$C_{p,u}$	$C_{p,l}$	$C_{p,u}$	$C_{p,l}$	$C_{p,u}$	$C_{p,l}$	$C_{p,u}$	$C_{p,l}$
0.050	-0.0432	-0.0352	0.1081	0.1081	0.1081	0.1081	0.1081	0.1081	0.1081	0.1081
0.100	-0.0427	-0.0351	0.0970	0.0970	0.0970	0.0970	0.0970	0.0970	0.0970	0.0970
0.150	-0.0475	-0.0354	0.0807	0.0807	0.0807	0.0807	0.0807	0.0807	0.0807	0.0807
0.200	-0.0506	-0.0338	0.0674	0.0674	0.0674	0.0674	0.0674	0.0674	0.0674	0.0674
0.250	*****	-0.0403	0.0536	-0.1642	0.0536	-0.1642	0.0536	-0.1642	0.0536	-0.3569
0.300	-0.0705	-0.0391	0.0428	-0.1472	0.0428	-0.1472	0.0428	-0.1472	0.0428	-0.3613
0.350	-0.0810	-0.0417	0.0316	-0.1370	0.0316	-0.1370	0.0316	-0.1370	0.0316	-0.3765
0.400	-0.0916	-0.0476	0.0245	-0.1276	0.0245	-0.1276	0.0245	-0.1276	0.0245	-0.3987
0.450	-0.1065	-0.0516	0.0166	-0.1213	0.0166	-0.1213	0.0166	-0.1213	0.0166	-0.4273
0.500	-0.1152	-0.0567	0.0013	-0.1172	0.0013	-0.1172	0.0013	-0.1172	0.0013	-0.4392
0.525	*****	-0.0591	-0.0044	-0.1168	-0.0044	-0.1168	-0.0044	-0.1168	-0.0044	-0.4483
0.550	-0.1228	-0.0662	-0.0080	-0.1181	-0.0080	-0.1181	-0.0080	-0.1181	-0.0080	-0.4580
0.575	*****	-0.0707	-0.0100	-0.1155	-0.0100	-0.1155	-0.0100	-0.1155	-0.0100	-0.4751
0.600	-0.1185	-0.0756	-0.0204	-0.1155	-0.0204	-0.1155	-0.0204	-0.1155	-0.0204	-0.4846
0.625	*****	*****	-0.0240	-0.1103	-0.0240	-0.1103	-0.0240	-0.1103	-0.0240	-0.4849
0.650	-0.1113	-0.0870	-0.0319	-0.1096	-0.0319	-0.1096	-0.0319	-0.1096	-0.0319	-0.4945
0.675	*****	-0.1008	-0.0395	-0.1144	-0.0395	-0.1144	-0.0395	-0.1144	-0.0395	-0.5025
0.700	-0.1039	-0.1150	-0.0468	-0.1159	-0.0468	-0.1159	-0.0468	-0.1159	-0.0468	-0.5208
0.725	*****	-0.1339	*****	-0.1202	-0.1202	-0.1202	-0.1202	-0.1202	-0.1202	-0.5469
0.750	-0.0931	-0.1448	*****	-0.1229	-0.1229	-0.1229	-0.1229	-0.1229	-0.1229	-0.5953
0.775	*****	-0.1586	-0.0816	-0.1327	-0.0816	-0.1327	-0.0816	-0.1327	-0.0816	-0.6335
0.800	-0.0783	-0.1641	-0.1127	-0.1466	-0.1127	-0.1466	-0.1127	-0.1466	-0.1127	-0.6335
0.825	*****	-0.1563	-0.1322	-0.1593	-0.1322	-0.1593	-0.1322	-0.1593	-0.1322	-0.5783
0.850	-0.0532	-0.1545	-0.1534	-0.1915	-0.1534	-0.1915	-0.1534	-0.1915	-0.1534	-0.4913
0.875	*****	-0.1490	-0.1579	-0.2227	-0.1490	-0.2227	-0.1490	-0.2227	-0.1490	-0.5148
0.900	-0.0162	-0.1301	-0.1557	-0.2322	-0.1557	-0.2322	-0.1557	-0.2322	-0.1557	-0.5148
0.925	*****	-0.0977	-0.1458	-0.2232	-0.0977	-0.2232	-0.0977	-0.2232	-0.0977	-0.7149
0.950	0.0244	-0.0615	-0.1075	-0.2047	-0.1075	-0.2047	-0.1075	-0.2047	-0.1075	-0.4126
0.975	*****	-0.0162	-0.0508	-0.1337	-0.0162	-0.1337	-0.0162	-0.1337	-0.0162	-0.2789
-0.200	0.0273	0.0410	0.1243	0.1243	0.1243	0.1243	0.1243	0.1243	0.1243	-0.4441
-0.400	0.0014	0.0435	0.0825	-0.0686	0.0825	-0.0686	0.0825	-0.0686	0.0825	-0.5263
-0.600	*****	0.0306	0.0608	-0.0449	0.0608	-0.0449	0.0608	-0.0449	0.0608	-0.6707
-0.700	*****	-0.0006	0.0483	-0.0409	0.0483	-0.0409	0.0483	-0.0409	0.0483	-0.7055
-0.800	0.0465	-0.0044	0.0128	-0.0385	0.0128	-0.0385	0.0128	-0.0385	0.0128	-0.6796
-0.850	0.0794	0.0140	0.0075	-0.0583	0.0075	-0.0583	0.0075	-0.0583	0.0075	-0.6893
-0.900	0.1162	0.0547	0.0236	-0.0580	0.0236	-0.0580	0.0236	-0.0580	0.0236	-0.8310
-0.950	*****	*****	0.0958	0.0086	0.0958	0.0086	0.0958	0.0086	0.0958	-0.2726
-0.975	*****	0.1655	0.1465	0.0776	0.1465	0.0776	0.1465	0.0776	0.1465	-0.1086

Sharp Radius L.E.
 Run No. = 89 , Point No. = 1963
 $C_N = 0.060$, $C_m = -0.0046$
 $\alpha = 2.1^\circ$, $M_\infty = 0.871$
 $R_{mac} = 6.0 \times 10^6$

Surface Pressures Near Leading Edge

● / ◆ upper, starboard/port
 ○ / ◇ lower, starboard/port

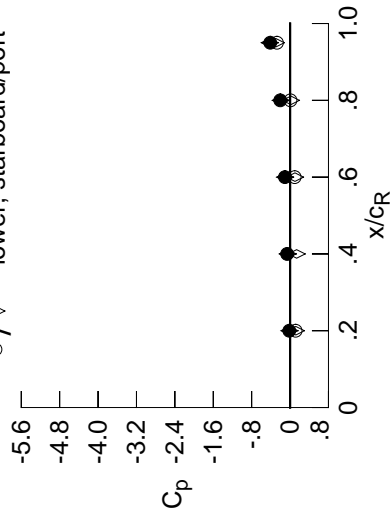

x/c_R	η	starb'd	port	starb'd	port
		$C_{p,u}$	$C_{p,l}$	$C_{p,u}$	$C_{p,l}$
0.20	0.90	-0.0162	-0.0126	0.1209	0.1162
0.40	0.95	-0.0615	-0.0491	0.1367	*****
0.60	0.95	-0.1075	-0.1044	0.1020	0.0958
0.80	0.95	-0.2047	-0.1944	0.0175	0.0086
0.95	0.95	-0.4126	-0.4234	-0.2979	-0.2726

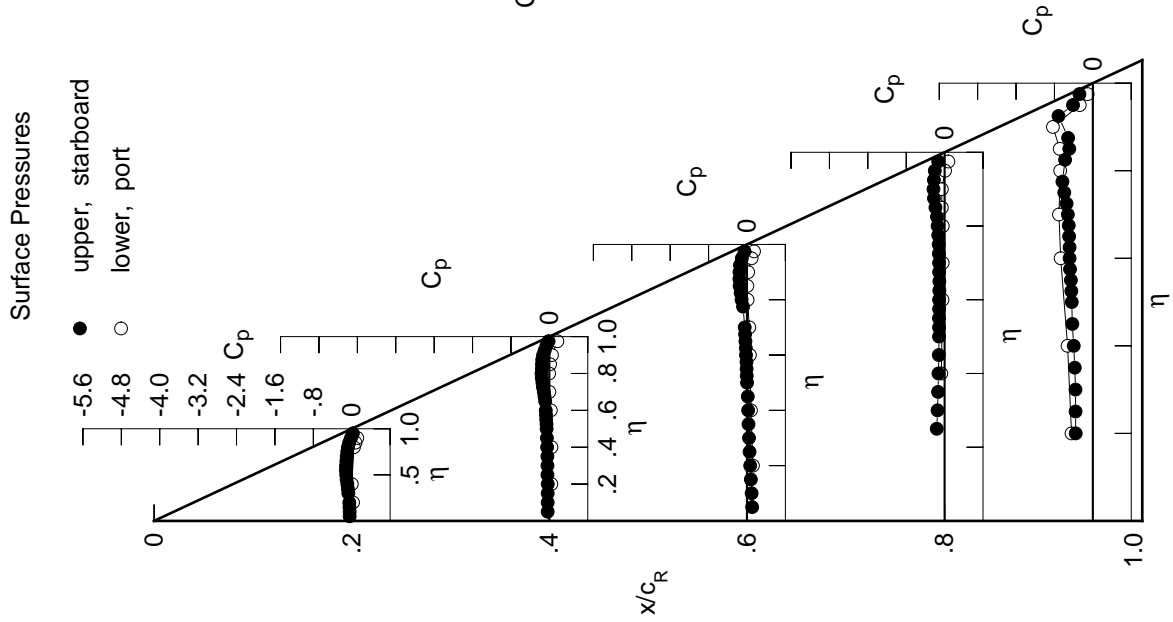

Table D5. Continued.

η	$x/c_R = .2$		$x/c_R = .4$		$x/c_R = .6$		$x/c_R = .8$		$x/c_R = .95$	
	$C_{p,u}$	$C_{p,l}$	$C_{p,u}$	$C_{p,l}$	$C_{p,u}$	$C_{p,l}$	$C_{p,u}$	$C_{p,l}$	$C_{p,u}$	$C_{p,l}$
0.050	-0.0681	-0.0556	0.0962	0.0831	0.0962	0.0831	0.0962	0.0831	0.0962	0.0831
0.100	-0.0725	-0.0552	0.0831	0.0688	0.0831	0.0688	0.0831	0.0688	0.0831	0.0688
0.150	-0.0794	-0.0542	0.0688	0.0531	0.0688	0.0531	0.0688	0.0531	0.0688	0.0531
0.200	-0.0859	-0.0512	0.0531	0.0421	0.0531	0.0421	0.0531	0.0421	0.0531	0.0421
0.250	*****	-0.0584	0.0421	0.0272	0.0421	0.0272	0.0421	0.0272	0.0421	0.0272
0.300	-0.0967	-0.0590	0.0272	0.0159	0.0272	0.0159	0.0272	0.0159	0.0272	0.0159
0.350	-0.1060	-0.0626	0.0159	0.0099	0.0159	0.0099	0.0159	0.0099	0.0159	0.0099
0.400	-0.1172	-0.0684	0.0099	-0.0010	0.0099	-0.1389	0.0099	-0.1389	0.0099	-0.3929
0.450	-0.1326	-0.0708	-0.0010	-0.1380	-0.0010	-0.1380	-0.1380	-0.1380	-0.1380	-0.4140
0.500	-0.1417	-0.0779	-0.0168	-0.1335	-0.0168	-0.1335	-0.1335	-0.1335	-0.1335	-0.4366
0.525	*****	-0.0818	-0.0250	-0.1343	-0.0250	-0.1343	-0.1343	-0.1343	-0.1343	-0.4411
0.550	-0.1512	-0.0899	-0.0239	-0.1347	-0.0239	-0.1347	-0.1347	-0.1347	-0.1347	-0.4272
0.575	*****	-0.0944	-0.0323	-0.1322	-0.0323	-0.1322	-0.1322	-0.1322	-0.1322	-0.4405
0.600	-0.1518	-0.1023	-0.0410	-0.1346	-0.0410	-0.1346	-0.1346	-0.1346	-0.1346	-0.4454
0.625	*****	*****	-0.0486	-0.1286	-0.0486	-0.1286	-0.1286	-0.1286	-0.1286	-0.4573
0.650	-0.1456	-0.1137	-0.0548	-0.1298	-0.0548	-0.1298	-0.1298	-0.1298	-0.1298	-0.4717
0.675	*****	-0.1304	-0.0657	-0.1352	-0.0657	-0.1352	-0.1352	-0.1352	-0.1352	-0.4764
0.700	-0.1397	-0.1460	-0.0745	-0.1379	-0.0745	-0.1379	-0.1379	-0.1379	-0.1379	-0.4935
0.725	*****	-0.1645	*****	-0.1447	-0.1645	-0.1447	-0.1447	-0.1447	-0.1447	-0.5008
0.750	-0.1318	-0.1818	*****	-0.1480	-0.1318	-0.1818	-0.1480	-0.1480	-0.1480	-0.5229
0.775	*****	-0.1997	-0.1164	-0.1615	-0.1997	-0.1164	-0.1615	-0.1615	-0.1615	-0.5450
0.800	-0.1183	-0.2064	-0.1489	-0.1758	-0.1183	-0.2064	-0.1489	-0.1758	-0.1183	-0.5450
0.825	*****	-0.2050	-0.1705	-0.1935	-0.2050	-0.1705	-0.1935	-0.1935	-0.2050	-0.4907
0.850	-0.0965	-0.2056	-0.1964	-0.2246	-0.0965	-0.2056	-0.1964	-0.2246	-0.0965	-0.4565
0.875	*****	-0.2027	-0.2074	-0.2644	-0.2027	-0.2074	-0.2644	-0.2644	-0.2027	-0.4834
0.900	-0.0596	-0.1837	-0.2088	-0.2793	-0.0596	-0.1837	-0.2088	-0.2793	-0.0596	-0.4834
0.925	*****	-0.1490	-0.2009	-0.2783	-0.1490	-0.2009	-0.2783	-0.2783	-0.1490	-0.7243
0.950	-0.0260	-0.1068	-0.1527	-0.2676	-0.0260	-0.1068	-0.1527	-0.2676	-0.0260	-0.4607
0.975	*****	-0.1666	-0.1979	-0.2070	-0.1666	-0.1979	-0.2070	-0.2070	-0.1666	-0.3291
-0.200	0.0477	0.0597	0.1405	0.0551	0.0477	0.0597	0.1405	0.0551	0.0477	-0.4647
-0.400	0.0235	0.0629	0.0977	-0.0551	0.0235	0.0629	0.0977	-0.0551	0.0235	-0.5617
-0.600	*****	0.0529	0.0808	-0.0309	0.0529	0.0808	-0.0309	-0.0309	0.0529	-0.6827
-0.700	*****	0.0273	0.0680	-0.0207	0.0273	0.0680	-0.0207	-0.0207	0.0273	-0.7001
-0.800	0.0798	0.0310	0.0414	-0.0141	0.0798	0.0310	0.0414	-0.0141	0.0798	-0.6652
-0.850	0.1102	0.0486	0.0416	-0.0306	0.1102	0.0486	0.0416	-0.0306	0.1102	-0.6685
-0.900	0.1456	0.0923	0.0631	-0.0199	0.1456	0.0923	0.0631	-0.0199	0.1456	-0.7786
-0.950	*****	*****	0.1310	0.0480	0.1310	0.0480	0.0480	0.0480	0.1310	-0.2489
-0.975	*****	0.1870	0.1725	0.1070	0.1870	0.1725	0.1070	0.1070	0.1870	-0.0854

Sharp Radius L.E.

Run No. = 89 , Point No. = 1964

$C_N = 0.107$, $C_m = -0.0147$

$\alpha = 3.2^\circ$, $M_\infty = 0.871$

$R_{mac} = 6.0 \times 10^6$

Surface Pressures Near Leading Edge

● / ◆ upper, starboard/port
○ / ◇ lower, starboard/port

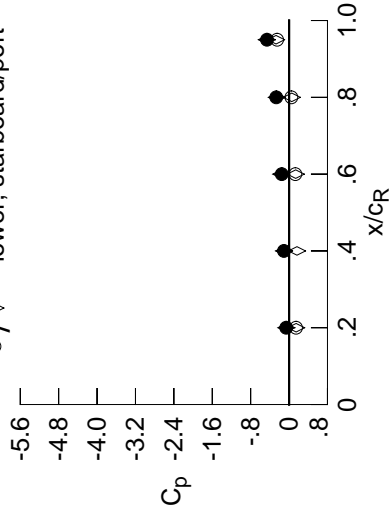

x/c_R	η	starb'd	port	$C_{p,u}$	starb'd	port	$C_{p,l}$
0.20	0.90	-0.0596	-0.0567	0.1476	0.1456	0.1456	0.1456
0.40	0.95	-0.1068	-0.1046	0.1652	0.1652	0.1652	0.1652
0.60	0.95	-0.1527	-0.1633	0.1381	0.1310	0.1310	0.1310
0.80	0.95	-0.2676	-0.2552	0.0572	0.0480	0.0480	0.0480
0.95	0.95	-0.4607	-0.4631	-0.2715	-0.2489	-0.2489	-0.2489

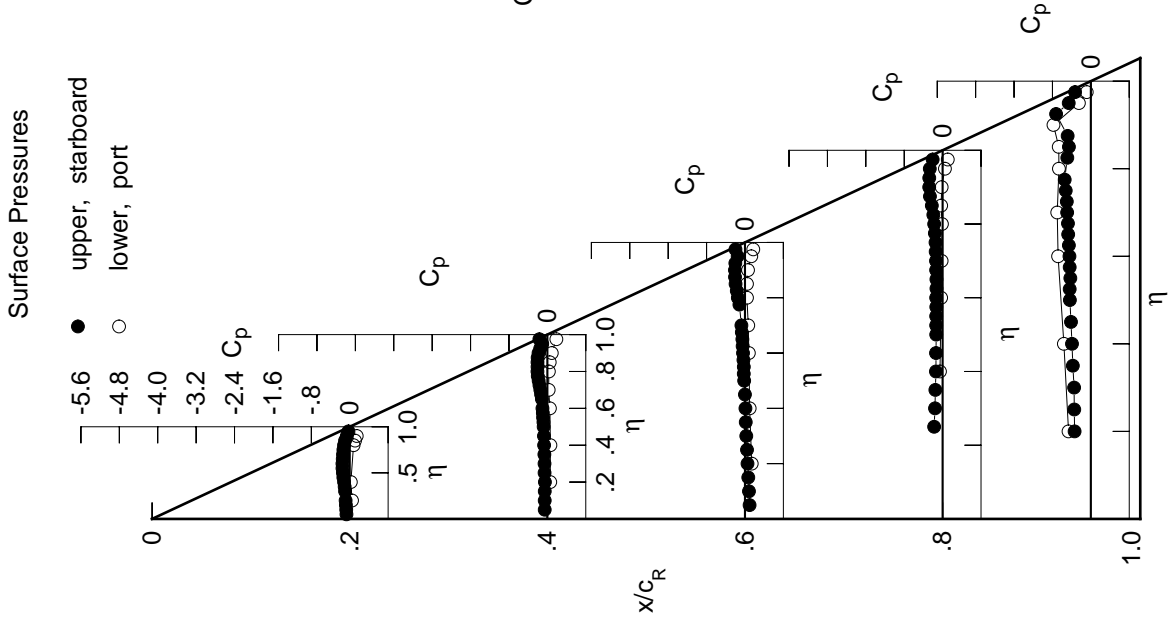

Table D5. Continued.

η	$x/c_R = .2$		$x/c_R = .4$		$x/c_R = .6$		$x/c_R = .8$		$x/c_R = .95$	
	$C_{p,u}$	$C_{p,l}$	$C_{p,u}$	$C_{p,l}$	$C_{p,u}$	$C_{p,l}$	$C_{p,u}$	$C_{p,l}$	$C_{p,u}$	$C_{p,l}$
0.050	-0.0908	-0.0723	0.0822	0.0822	0.0822	0.0822	0.0822	0.0822	0.0822	0.0822
0.100	-0.0957	-0.0730	0.0694	0.0694	0.0694	0.0694	0.0694	0.0694	0.0694	0.0694
0.150	-0.0994	-0.0696	0.0546	0.0546	0.0546	0.0546	0.0546	0.0546	0.0546	0.0546
0.200	-0.1097	-0.0724	0.0394	0.0394	0.0394	0.0394	0.0394	0.0394	0.0394	0.0394
0.250	*****	-0.0773	0.0273	0.0273	-0.1921	-0.3252	0.0273	0.0273	0.0273	0.0273
0.300	-0.1179	-0.0770	0.0134	0.0134	-0.1753	-0.3110	0.0134	0.0134	0.0134	0.0134
0.350	-0.1308	-0.0812	0.0022	0.0022	-0.1663	-0.3603	0.0022	0.0022	0.0022	0.0022
0.400	-0.1428	-0.0906	-0.0082	-0.1540	-0.3926	0.0022	0.0022	0.0022	0.0022	0.0022
0.450	-0.1576	-0.0950	-0.0159	-0.1517	-0.4035	-0.0159	-0.1517	-0.4035	-0.0159	-0.1517
0.500	-0.1697	-0.1023	-0.0354	-0.1513	-0.4332	-0.0354	-0.1513	-0.4332	-0.0354	-0.1513
0.525	*****	-0.1089	-0.0416	-0.1525	-0.4557	-0.0416	-0.1525	-0.4557	-0.0416	-0.1525
0.550	-0.1804	-0.1146	-0.0471	-0.1497	-0.4426	-0.0471	-0.1497	-0.4426	-0.0471	-0.1497
0.575	*****	-0.1219	-0.0526	-0.1519	-0.4404	-0.0526	-0.1519	-0.4404	-0.0526	-0.1519
0.600	-0.1826	-0.1283	-0.0636	-0.1538	-0.4377	-0.0636	-0.1538	-0.4377	-0.0636	-0.1538
0.625	*****	*****	-0.0716	-0.1529	-0.4577	-0.0716	-0.1529	-0.4577	-0.0716	-0.1529
0.650	-0.1792	-0.1428	-0.0781	-0.1556	-0.4919	-0.0781	-0.1556	-0.4919	-0.0781	-0.1556
0.675	*****	-0.1612	-0.0895	-0.1573	-0.5083	-0.0895	-0.1573	-0.5083	-0.0895	-0.1573
0.700	-0.1753	-0.1795	-0.0993	-0.1633	-0.5374	-0.0993	-0.1633	-0.5374	-0.0993	-0.1633
0.725	*****	-0.2028	*****	-0.1683	-0.5650	-0.2028	*****	-0.1683	-0.5650	*****
0.750	-0.1704	-0.2185	*****	-0.1781	-0.5892	-0.1704	-0.2185	*****	-0.1781	-0.5892
0.775	*****	-0.2398	-0.1469	-0.1925	-0.6146	-0.2398	-0.1469	-0.1925	-0.6146	*****
0.800	-0.1599	-0.2500	-0.1820	-0.2072	*****	-0.1599	-0.2500	-0.1820	-0.2072	*****
0.825	*****	-0.2504	-0.2071	-0.2268	-0.5679	-0.2504	-0.2071	-0.2268	-0.5679	*****
0.850	-0.1382	-0.2515	-0.2372	-0.2632	-0.4705	-0.1382	-0.2515	-0.2372	-0.2632	-0.4705
0.875	*****	-0.2458	-0.2453	-0.3024	-0.4798	-0.2458	-0.2453	-0.3024	-0.4798	*****
0.900	-0.0995	-0.2218	-0.2491	-0.3183	*****	-0.0995	-0.2218	-0.2491	-0.3183	*****
0.925	*****	-0.1874	-0.2290	-0.3206	-0.7288	-0.1874	-0.2290	-0.3206	-0.7288	*****
0.950	-0.0776	-0.2677	-0.3052	-0.3359	-0.4926	-0.0776	-0.2677	-0.3052	-0.3359	-0.4926
0.975	*****	-0.3977	-0.4601	-0.4928	-0.5027	-0.3977	-0.4601	-0.4928	-0.5027	*****

η	$x/c_R = .2$		$x/c_R = .4$		$x/c_R = .6$		$x/c_R = .8$		$x/c_R = .95$	
	$C_{p,u}$	$C_{p,l}$	$C_{p,u}$	$C_{p,l}$	$C_{p,u}$	$C_{p,l}$	$C_{p,u}$	$C_{p,l}$	$C_{p,u}$	$C_{p,l}$
-0.200	0.0700	0.0777	0.1536	0.1536	0.1536	0.1536	0.1536	0.1536	0.1536	0.1536
-0.400	0.0494	0.0826	0.1145	0.1145	-0.0403	-0.5943	0.1145	0.1145	0.1145	0.1145
-0.600	*****	0.0789	0.0970	-0.0139	-0.6883	0.0789	0.0970	-0.0139	-0.6883	*****
-0.700	*****	0.0558	0.0923	-0.0029	-0.6920	0.0558	0.0923	-0.0029	-0.6920	*****
-0.800	0.1110	0.0651	0.0688	0.0080	-0.6454	0.1110	0.0651	0.0688	0.0080	-0.6454
-0.850	0.1389	0.0823	0.0740	-0.0016	-0.6497	0.1389	0.0823	0.0740	-0.0016	-0.6497
-0.900	0.1720	0.1271	0.0987	0.0125	-0.7268	0.1720	0.1271	0.0987	0.0125	-0.7268
-0.950	*****	*****	0.1605	0.0814	-0.2270	*****	*****	0.1605	0.0814	-0.2270
-0.975	*****	0.2005	0.1905	0.1297	-0.0695	*****	0.2005	0.1905	0.1297	-0.0695

Sharp Radius L.E.
 Run No. = 89 , Point No. = 1965
 $C_N = 0.157$, $C_m = -0.0267$
 $\alpha = 4.2^\circ$, $M_\infty = 0.871$
 $R_{mac} = 6.0 \times 10^6$

Surface Pressures Near Leading Edge

● / ◆ upper, starboard/port
 ○ / ◇ lower, starboard/port

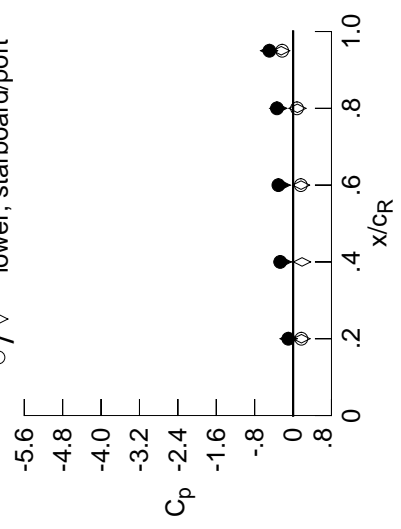

x/c_R	η	starb'd	port	starb'd	port
		$C_{p,u}$	$C_{p,l}$	$C_{p,u}$	$C_{p,l}$
0.20	0.90	-0.0995	-0.0942	0.1741	0.1720
0.40	0.95	-0.2677	-0.2152	0.1876	*****
0.60	0.95	-0.3052	-0.2394	0.1660	0.1605
0.80	0.95	-0.3359	-0.3087	0.0893	0.0814
0.95	0.95	-0.4926	-0.4989	-0.2471	-0.2270

Table D5. Continued.

η	$x/c_R = .2$		$x/c_R = .4$		$x/c_R = .6$		$x/c_R = .8$		$x/c_R = .95$	
	$C_{p,u}$	$C_{p,l}$	$C_{p,u}$	$C_{p,l}$	$C_{p,u}$	$C_{p,l}$	$C_{p,u}$	$C_{p,l}$	$C_{p,u}$	$C_{p,l}$
0.050	-0.1093	-0.0873	0.0710	0.0710	0.0710	0.0710	0.0710	0.0710	0.0710	0.0710
0.100	-0.1109	-0.0883	0.0581	0.0581	0.0581	0.0581	0.0581	0.0581	0.0581	0.0581
0.150	-0.1210	-0.0894	0.0442	0.0442	0.0442	0.0442	0.0442	0.0442	0.0442	0.0442
0.200	-0.1279	-0.0893	0.0268	0.0268	0.0268	0.0268	0.0268	0.0268	0.0268	0.0268
0.250	*****	-0.0973	0.0156	-0.2067	-0.3244	0.0156	-0.2067	-0.3244	0.0156	-0.3057
0.300	-0.1395	-0.0962	-0.0014	-0.1895	-0.3123	-0.1395	-0.0962	-0.1895	-0.3123	-0.1395
0.350	-0.1525	-0.1021	-0.0151	-0.1800	-0.3504	-0.1525	-0.1021	-0.1800	-0.3504	-0.1525
0.400	-0.1650	-0.1109	-0.0213	-0.1719	-0.3781	-0.1650	-0.1109	-0.1719	-0.3781	-0.1650
0.450	-0.1814	-0.1165	-0.0316	-0.1688	-0.3746	-0.1814	-0.1165	-0.1688	-0.3746	-0.1814
0.500	-0.1940	-0.1246	-0.0495	-0.1673	-0.3791	-0.1940	-0.1246	-0.1673	-0.3791	-0.1940
0.525	*****	-0.1313	-0.0586	-0.1677	-0.3973	*****	-0.1313	-0.0586	-0.1677	-0.3973
0.550	-0.2072	-0.1375	-0.0637	-0.1703	-0.3990	-0.2072	-0.1375	-0.0637	-0.1703	-0.3990
0.575	*****	-0.1448	-0.0721	-0.1685	-0.4045	*****	-0.1448	-0.0721	-0.1685	-0.4045
0.600	-0.2103	-0.1524	-0.0836	-0.1735	-0.4142	-0.2103	-0.1524	-0.0836	-0.1735	-0.4142
0.625	*****	*****	-0.0919	-0.1690	-0.4628	*****	*****	-0.0919	-0.1690	-0.4628
0.650	-0.2100	-0.1734	-0.0995	-0.1725	-0.5614	-0.2100	-0.1734	-0.0995	-0.1725	-0.5614
0.675	*****	-0.1919	-0.1119	-0.1786	-0.6257	*****	-0.1919	-0.1119	-0.1786	-0.6257
0.700	-0.2113	-0.2094	-0.1227	-0.1806	-0.6656	-0.2113	-0.2094	-0.1227	-0.1806	-0.6656
0.725	*****	-0.2338	*****	-0.1855	-0.7216	*****	-0.2338	*****	-0.1855	-0.7216
0.750	-0.2044	-0.2534	*****	-0.1978	-0.7389	-0.2044	-0.2534	*****	-0.1978	-0.7389
0.775	*****	-0.2741	-0.1722	-0.2192	-0.7459	*****	-0.2741	-0.1722	-0.2192	-0.7459
0.800	-0.1946	-0.2855	-0.2099	-0.2448	*****	-0.1946	-0.2855	-0.2099	-0.2448	*****
0.825	*****	-0.2842	-0.2317	-0.2543	-0.7738	*****	-0.2842	-0.2317	-0.2543	-0.7738
0.850	-0.1664	-0.2826	-0.2548	-0.3020	-0.5968	-0.1664	-0.2826	-0.2548	-0.3020	-0.5968
0.875	*****	-0.2646	-0.2589	-0.3394	-0.8131	*****	-0.2646	-0.2589	-0.3394	-0.8131
0.900	-0.1543	-0.2763	-0.3216	-0.3738	*****	-0.1543	-0.2763	-0.3216	-0.3738	*****
0.925	*****	-0.3915	-0.4515	-0.4829	-0.8361	*****	-0.3915	-0.4515	-0.4829	-0.8361
0.950	-0.1321	-0.5158	-0.5703	-0.5874	-0.5679	-0.1321	-0.5158	-0.5703	-0.5874	-0.5679
0.975	*****	-0.5048	-0.5618	-0.6148	-0.4501	*****	-0.5048	-0.5618	-0.6148	-0.4501
-0.200	0.0921	0.1006	0.1686	0.1686	0.1686	0.0921	0.1006	0.1686	0.1686	0.1686
-0.400	0.0749	0.1031	0.1313	-0.0245	-0.6186	0.0749	0.1031	0.1313	-0.0245	-0.6186
-0.600	*****	0.1024	0.1158	0.0047	-0.6863	*****	0.1024	0.1158	0.0047	-0.6863
-0.700	*****	0.0829	0.1157	0.0139	-0.6815	*****	0.0829	0.1157	0.0139	-0.6815
-0.800	0.1400	0.0952	0.0963	0.0306	-0.6296	0.1400	0.0952	0.0963	0.0306	-0.6296
-0.850	0.1664	0.1121	0.1041	0.0231	-0.6295	0.1664	0.1121	0.1041	0.0231	-0.6295
-0.900	0.1943	0.1564	0.1310	0.0427	-0.6854	0.1943	0.1564	0.1310	0.0427	-0.6854
-0.950	*****	0.1830	0.1076	-0.2034	*****	*****	0.1830	0.1076	-0.2034	*****
-0.975	*****	0.2077	0.2008	0.1427	-0.0437	*****	0.2077	0.2008	0.1427	-0.0437

Sharp Radius L.E.
 Run No. = 89 , Point No. = 1966
 $C_N = 0.203$, $C_m = -0.0355$
 $\alpha = 5.2^\circ$, $M_\infty = 0.871$
 $R_{mac} = 6.0 \times 10^6$

Surface Pressures Near Leading Edge

● / ◆ upper, starboard/port
 ○ / ◇ lower, starboard/port

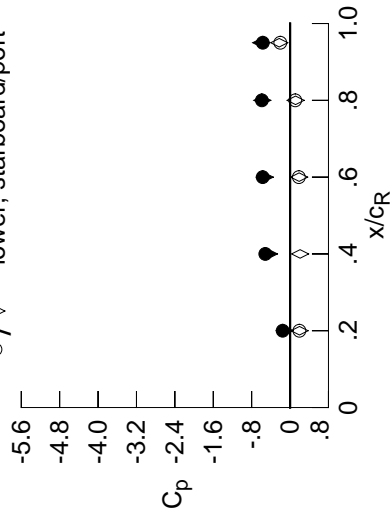

x/c_R	η	starb'd	port	starb'd	port
		$C_{p,u}$	$C_{p,l}$	$C_{p,u}$	$C_{p,l}$
0.20	0.90	-0.1543	-0.1131	0.1970	0.1943
0.40	0.95	-0.5158	-0.4401	0.2090	*****
0.60	0.95	-0.5703	-0.5284	0.1884	0.1830
0.80	0.95	-0.5874	-0.5791	0.1150	0.1076
0.95	0.95	-0.5679	-0.6013	-0.2257	-0.2034

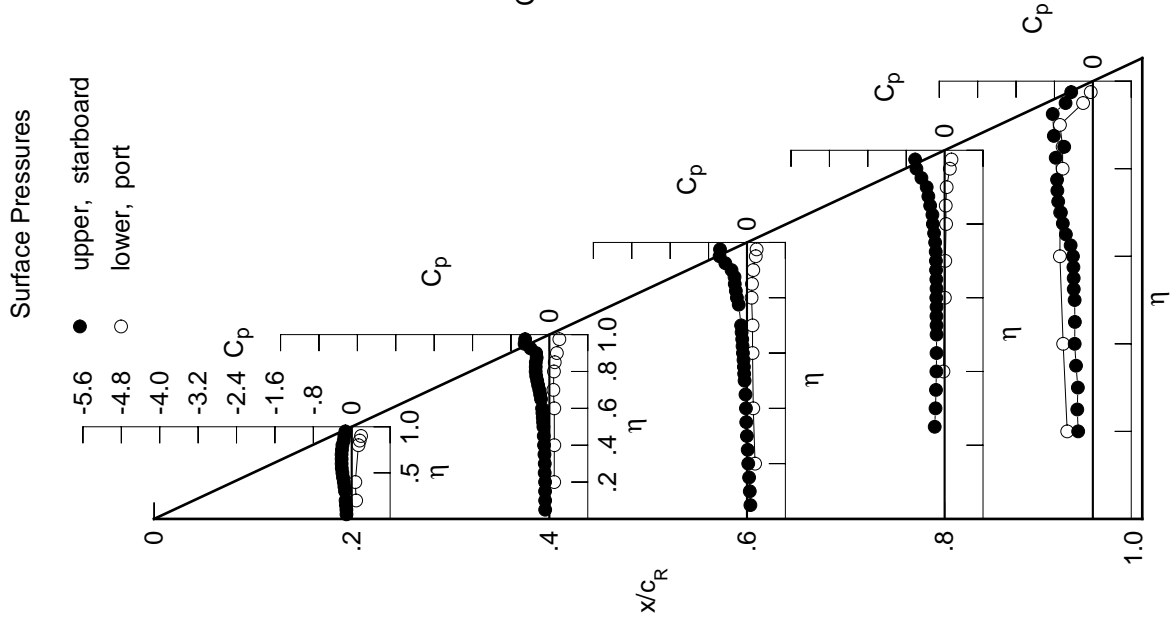

Table D5. Continued.

η	$x/c_R = .2$		$x/c_R = .4$		$x/c_R = .6$		$x/c_R = .8$		$x/c_R = .95$	
	$C_{p,u}$	$C_{p,l}$	$C_{p,u}$	$C_{p,l}$	$C_{p,u}$	$C_{p,l}$	$C_{p,u}$	$C_{p,l}$	$C_{p,u}$	$C_{p,l}$
0.050	-0.1313	-0.1058	0.0573	0.0573	0.0573	0.0573	0.0573	0.0573	0.0573	0.0573
0.100	-0.1321	-0.1083	0.0458	0.0458	0.0458	0.0458	0.0458	0.0458	0.0458	0.0458
0.150	-0.1428	-0.1084	0.0293	0.0293	0.0293	0.0293	0.0293	0.0293	0.0293	0.0293
0.200	-0.1505	-0.1100	0.0131	0.0131	0.0131	0.0131	0.0131	0.0131	0.0131	0.0131
0.250	*****	-0.1162	0.0012	-0.2274	-0.3245	-0.3245	-0.3245	-0.3245	-0.3245	-0.3245
0.300	-0.1607	-0.1181	-0.0190	-0.2116	-0.3059	-0.3059	-0.3059	-0.3059	-0.3059	-0.3059
0.350	-0.1751	-0.1212	-0.0322	-0.1997	-0.3073	-0.3073	-0.3073	-0.3073	-0.3073	-0.3073
0.400	-0.1873	-0.1354	-0.0400	-0.1945	-0.3157	-0.3157	-0.3157	-0.3157	-0.3157	-0.3157
0.450	-0.2058	-0.1420	-0.0482	-0.1890	-0.2996	-0.2996	-0.2996	-0.2996	-0.2996	-0.2996
0.500	-0.2201	-0.1500	-0.0702	-0.1926	-0.3101	-0.3101	-0.3101	-0.3101	-0.3101	-0.3101
0.525	*****	-0.1538	-0.0778	-0.1868	-0.3329	-0.3329	-0.3329	-0.3329	-0.3329	-0.3329
0.550	-0.2328	-0.1622	-0.0853	-0.1911	-0.3654	-0.3654	-0.3654	-0.3654	-0.3654	-0.3654
0.575	*****	-0.1712	-0.0891	-0.1880	-0.4244	-0.4244	-0.4244	-0.4244	-0.4244	-0.4244
0.600	-0.2382	-0.1765	-0.1032	-0.1865	-0.4952	-0.4952	-0.4952	-0.4952	-0.4952	-0.4952
0.625	*****	*****	-0.1106	-0.1828	-0.6011	-0.6011	-0.6011	-0.6011	-0.6011	-0.6011
0.650	-0.2390	-0.1995	-0.1190	-0.1822	-0.7070	-0.7070	-0.7070	-0.7070	-0.7070	-0.7070
0.675	*****	-0.2199	-0.1284	-0.1816	-0.7497	-0.7497	-0.7497	-0.7497	-0.7497	-0.7497
0.700	-0.2381	-0.2405	-0.1386	-0.1847	-0.7506	-0.7506	-0.7506	-0.7506	-0.7506	-0.7506
0.725	*****	-0.2646	*****	-0.1753	-0.7336	-0.7336	-0.7336	-0.7336	-0.7336	-0.7336
0.750	-0.2291	-0.2826	*****	-0.1657	-0.7447	-0.7447	-0.7447	-0.7447	-0.7447	-0.7447
0.775	*****	-0.3001	-0.1760	-0.2187	-0.8308	-0.8308	-0.8308	-0.8308	-0.8308	-0.8308
0.800	-0.2106	-0.3059	-0.2156	-0.3741	*****	*****	*****	*****	*****	*****
0.825	*****	-0.2985	-0.2598	-0.4850	-0.9239	-0.9239	-0.9239	-0.9239	-0.9239	-0.9239
0.850	-0.1888	-0.3139	-0.3801	-0.5686	-0.7297	-0.7297	-0.7297	-0.7297	-0.7297	-0.7297
0.875	*****	-0.3843	-0.5213	-0.5984	-0.7559	-0.7559	-0.7559	-0.7559	-0.7559	-0.7559
0.900	-0.3591	-0.5380	-0.6184	-0.6020	*****	*****	*****	*****	*****	*****
0.925	*****	-0.6225	-0.6487	-0.5999	-0.5984	-0.5984	-0.5984	-0.5984	-0.5984	-0.5984
0.950	-0.2460	-0.6342	-0.6339	-0.5889	-0.4700	-0.4700	-0.4700	-0.4700	-0.4700	-0.4700
0.975	*****	-0.6144	-0.6174	-0.5830	-0.4092	-0.4092	-0.4092	-0.4092	-0.4092	-0.4092

η	$x/c_R = .2$		$x/c_R = .4$		$x/c_R = .6$		$x/c_R = .8$		$x/c_R = .95$	
	$C_{p,u}$	$C_{p,l}$	$C_{p,u}$	$C_{p,l}$	$C_{p,u}$	$C_{p,l}$	$C_{p,u}$	$C_{p,l}$	$C_{p,u}$	$C_{p,l}$
-0.200	0.1152	0.1176	0.1824	0.1824	0.1824	0.1824	0.1824	0.1824	0.1824	0.1824
-0.400	0.1003	0.1240	0.1489	0.1489	0.1489	0.1489	0.1489	0.1489	0.1489	0.1489
-0.600	*****	0.1261	0.1345	0.1345	0.1345	0.1345	0.1345	0.1345	0.1345	0.1345
-0.700	*****	0.1090	0.1232	0.1198	0.0549	-0.6680	-0.6680	-0.6680	-0.6680	-0.6680
-0.800	0.1670	0.1232	0.1198	0.1321	0.0474	-0.6119	-0.6119	-0.6119	-0.6119	-0.6119
-0.850	0.1893	0.1407	0.1321	0.1565	0.0692	-0.6497	-0.6497	-0.6497	-0.6497	-0.6497
-0.900	0.2148	0.1832	0.1565	0.1997	0.1286	-0.1898	-0.1898	-0.1898	-0.1898	-0.1898
-0.950	*****	*****	0.1997	0.2020	0.1522	-0.0379	-0.0379	-0.0379	-0.0379	-0.0379
-0.975	*****	0.2080	0.2020	0.1522	-0.0379	-0.0379	-0.0379	-0.0379	-0.0379	-0.0379

Sharp Radius L.E.
 Run No. = 89, Point No. = 1967
 $C_N = 0.253$, $C_m = -0.0436$
 $\alpha = 6.3^\circ$, $M_\infty = 0.872$
 $R_{mac} = 6.0 \times 10^6$

Surface Pressures Near Leading Edge

● / ◆ upper, starboard/port
 ○ / ◇ lower, starboard/port

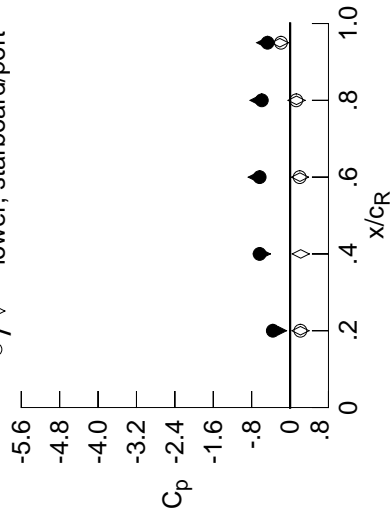

x/c_R	η	starb'd	port	starb'd	port
		$C_{p,u}$	$C_{p,l}$	$C_{p,u}$	$C_{p,l}$
0.20	0.90	-0.3591	-0.2509	0.2160	0.2148
0.40	0.95	-0.6342	-0.5878	0.2213	*****
0.60	0.95	-0.6339	-0.6953	0.2060	0.1997
0.80	0.95	-0.5889	-0.6574	0.1336	0.1286
0.95	0.95	-0.4700	-0.5185	-0.2124	-0.1898

Table D5. Continued.

η	$x/c_R = .2$		$x/c_R = .4$		$x/c_R = .6$		$x/c_R = .8$		$x/c_R = .95$	
	$C_{p,u}$	$C_{p,l}$	$C_{p,u}$	$C_{p,l}$	$C_{p,u}$	$C_{p,l}$	$C_{p,u}$	$C_{p,l}$	$C_{p,u}$	$C_{p,l}$
0.050	-0.1494	-0.1248	0.0381	0.0381	0.0381	0.0381	0.0381	0.0381	0.0381	0.0381
0.100	-0.1516	-0.1307	0.0306	0.0306	0.0306	0.0306	0.0306	0.0306	0.0306	0.0306
0.150	-0.1601	-0.1259	0.0132	0.0132	0.0132	0.0132	0.0132	0.0132	0.0132	0.0132
0.200	-0.1705	-0.1288	-0.0028	-0.0028	-0.0028	-0.0028	-0.0028	-0.0028	-0.0028	-0.0028
0.250	*****	-0.1354	-0.0197	-0.2477	-0.2477	-0.2477	-0.2477	-0.2477	-0.2477	-0.2477
0.300	-0.1800	-0.1410	-0.0418	-0.2393	-0.2393	-0.2393	-0.2393	-0.2393	-0.2393	-0.2393
0.350	-0.1951	-0.1429	-0.0473	-0.2234	-0.2234	-0.2234	-0.2234	-0.2234	-0.2234	-0.2234
0.400	-0.2093	-0.1603	-0.0595	-0.2169	-0.2169	-0.2169	-0.2169	-0.2169	-0.2169	-0.2169
0.450	-0.2273	-0.1700	-0.0667	-0.2072	-0.2072	-0.2072	-0.2072	-0.2072	-0.2072	-0.2072
0.500	-0.2426	-0.1736	-0.0879	-0.2062	-0.2062	-0.2062	-0.2062	-0.2062	-0.2062	-0.2062
0.525	*****	-0.1782	-0.0914	-0.2054	-0.2054	-0.2054	-0.2054	-0.2054	-0.2054	-0.2054
0.550	-0.2556	-0.1830	-0.1012	-0.2026	-0.2026	-0.2026	-0.2026	-0.2026	-0.2026	-0.2026
0.575	*****	-0.1964	-0.0998	-0.2009	-0.2009	-0.2009	-0.2009	-0.2009	-0.2009	-0.2009
0.600	-0.2608	-0.1983	-0.1154	-0.1984	-0.1984	-0.1984	-0.1984	-0.1984	-0.1984	-0.1984
0.625	*****	*****	-0.1200	-0.1910	-0.1910	-0.1910	-0.1910	-0.1910	-0.1910	-0.1910
0.650	-0.2599	-0.2241	-0.1295	-0.1857	-0.1857	-0.1857	-0.1857	-0.1857	-0.1857	-0.1857
0.675	*****	-0.2451	-0.1356	-0.1704	-0.1704	-0.1704	-0.1704	-0.1704	-0.1704	-0.1704
0.700	-0.2578	-0.2636	-0.1313	-0.1558	-0.1558	-0.1558	-0.1558	-0.1558	-0.1558	-0.1558
0.725	*****	-0.2824	*****	-0.1333	-0.1333	-0.1333	-0.1333	-0.1333	-0.1333	-0.1333
0.750	-0.2356	-0.2921	*****	-0.2556	-0.2556	-0.2556	-0.2556	-0.2556	-0.2556	-0.2556
0.775	*****	-0.2969	-0.2192	-0.5768	-0.5768	-0.5768	-0.5768	-0.5768	-0.5768	-0.5768
0.800	-0.2235	-0.3203	-0.4964	-0.7311	-0.7311	-0.7311	-0.7311	-0.7311	-0.7311	-0.7311
0.825	*****	-0.4149	-0.6467	-0.7619	-0.7619	-0.7619	-0.7619	-0.7619	-0.7619	-0.7619
0.850	-0.3527	-0.5466	-0.7092	-0.7384	-0.7384	-0.7384	-0.7384	-0.7384	-0.7384	-0.7384
0.875	*****	-0.6629	-0.6968	-0.6748	-0.6748	-0.6748	-0.6748	-0.6748	-0.6748	-0.6748
0.900	-0.5058	-0.7281	-0.6967	-0.6190	-0.6190	-0.6190	-0.6190	-0.6190	-0.6190	-0.6190
0.925	*****	-0.7358	-0.6724	-0.5953	-0.5953	-0.5953	-0.5953	-0.5953	-0.5953	-0.5953
0.950	-0.4072	-0.7122	-0.6518	-0.5838	-0.5838	-0.5838	-0.5838	-0.5838	-0.5838	-0.5838
0.975	*****	-0.7077	-0.6396	-0.5780	-0.5780	-0.5780	-0.5780	-0.5780	-0.5780	-0.5780
-0.200	$C_{p,l}$	0.1392	0.1420	0.1996	0.1996	0.1996	0.1996	0.1996	0.1996	0.1996
-0.400	0.1215	0.1464	0.1677	0.0018	0.0018	0.0018	0.0018	0.0018	0.0018	0.0018
-0.600	*****	0.1536	0.1518	0.0353	0.0353	0.0353	0.0353	0.0353	0.0353	0.0353
-0.700	*****	0.1365	0.1579	0.0493	0.0493	0.0493	0.0493	0.0493	0.0493	0.0493
-0.800	0.1923	0.1522	0.1452	0.0717	0.0717	0.0717	0.0717	0.0717	0.0717	0.0717
-0.850	0.2132	0.1676	0.1578	0.0696	0.0696	0.0696	0.0696	0.0696	0.0696	0.0696
-0.900	0.2332	0.2080	0.1822	0.0956	0.0956	0.0956	0.0956	0.0956	0.0956	0.0956
-0.950	*****	0.2160	0.1445	0.1445	0.1445	0.1445	0.1445	0.1445	0.1445	0.1445
-0.975	*****	0.2085	0.2065	0.1581	0.1581	0.1581	0.1581	0.1581	0.1581	0.1581

Sharp Radius L.E.

Run No. = 89, Point No. = 1968

$C_N = 0.311$, $C_m = -0.0567$

$\alpha = 7.3^\circ$, $M_\infty = 0.871$

$R_{mac} = 6.0 \times 10^6$

Surface Pressures Near Leading Edge

● / ◆ upper, starboard/port
○ / ◇ lower, starboard/port

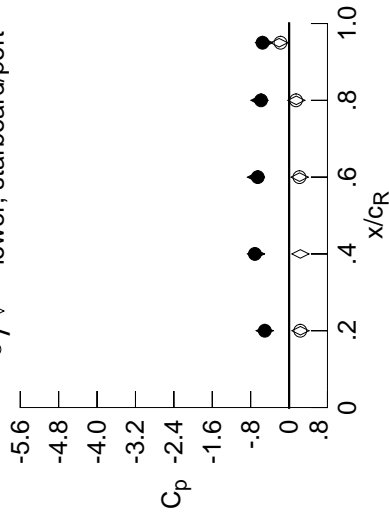

x/c_R	η	starb'd	port	starb'd	port
		$C_{p,u}$	$C_{p,l}$	$C_{p,u}$	$C_{p,l}$
0.20	0.90	-0.5058	-0.5090	0.2357	0.2332
0.40	0.95	-0.7122	-0.6892	0.2348	*****
0.60	0.95	-0.6518	-0.6900	0.2191	0.2160
0.80	0.95	-0.5838	-0.6188	0.1508	0.1445
0.95	0.95	-0.5528	-0.5208	-0.2060	-0.1784

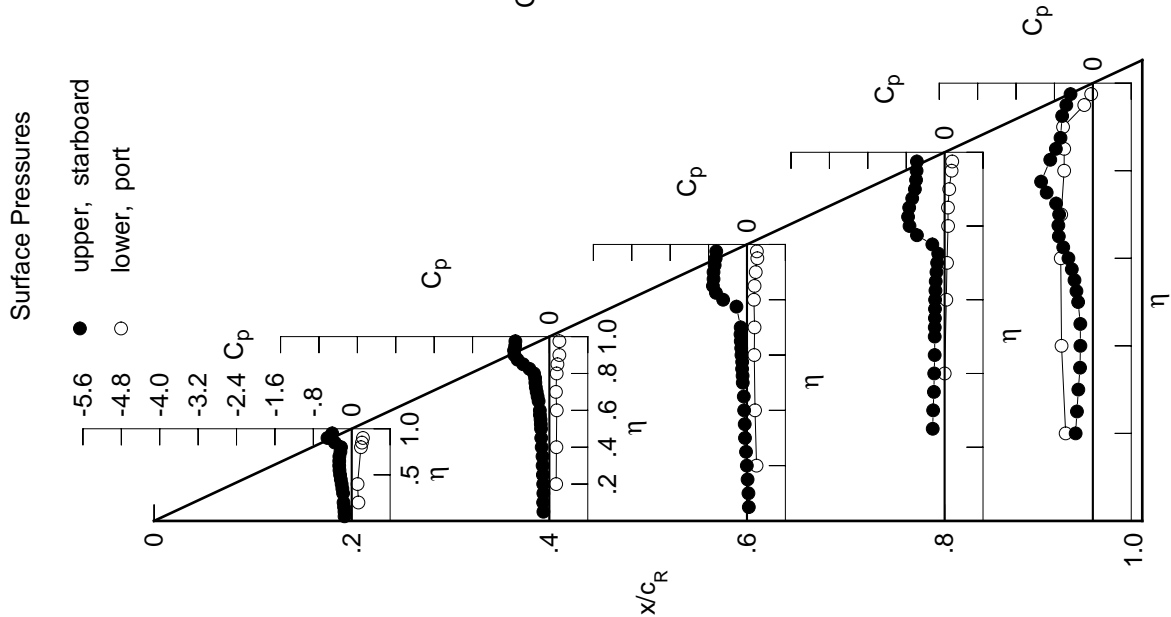

Table D5. Continued.

η	$x/c_R = .2$		$x/c_R = .4$		$x/c_R = .6$		$x/c_R = .8$		$x/c_R = .95$	
	$C_{p,u}$	$C_{p,l}$	$C_{p,u}$	$C_{p,l}$	$C_{p,u}$	$C_{p,l}$	$C_{p,u}$	$C_{p,l}$	$C_{p,u}$	$C_{p,l}$
0.050	-0.1640	-0.1453	0.0240	0.0240	0.0240	0.0240	0.0240	0.0240	0.0240	0.0240
0.100	-0.1704	-0.1491	0.0094	0.0094	0.0094	0.0094	0.0094	0.0094	0.0094	0.0094
0.150	-0.1769	-0.1508	-0.0027	-0.0027	-0.0027	-0.0027	-0.0027	-0.0027	-0.0027	-0.0027
0.200	-0.1890	-0.1502	-0.0222	-0.0222	-0.0222	-0.0222	-0.0222	-0.0222	-0.0222	-0.0222
0.250	*****	-0.1591	-0.0361	-0.2737	-0.3409	-0.4239	-0.4239	-0.4239	-0.4239	-0.4239
0.300	-0.1995	-0.1608	-0.0615	-0.2629	-0.2459	-0.2459	-0.2459	-0.2459	-0.2459	-0.2459
0.350	-0.2142	-0.1680	-0.0709	-0.2477	-0.2009	-0.2009	-0.2009	-0.2009	-0.2009	-0.2009
0.400	-0.2272	-0.1844	-0.0746	-0.2337	-0.2046	-0.2046	-0.2046	-0.2046	-0.2046	-0.2046
0.450	-0.2473	-0.1998	-0.0853	-0.2261	-0.2717	-0.2717	-0.2717	-0.2717	-0.2717	-0.2717
0.500	-0.2611	-0.2014	-0.1011	-0.2232	-0.3912	-0.3912	-0.3912	-0.3912	-0.3912	-0.3912
0.525	*****	-0.2025	-0.1066	-0.2182	-0.4943	-0.4943	-0.4943	-0.4943	-0.4943	-0.4943
0.550	-0.2754	-0.2052	-0.1099	-0.2189	-0.5916	-0.5916	-0.5916	-0.5916	-0.5916	-0.5916
0.575	*****	-0.2116	-0.1130	-0.2089	-0.6780	-0.6780	-0.6780	-0.6780	-0.6780	-0.6780
0.600	-0.2787	-0.2231	-0.1200	-0.2053	-0.7230	-0.7230	-0.7230	-0.7230	-0.7230	-0.7230
0.625	*****	*****	-0.1180	-0.1888	-0.7348	-0.7348	-0.7348	-0.7348	-0.7348	-0.7348
0.650	-0.2726	-0.2387	-0.1256	-0.1766	-0.7206	-0.7206	-0.7206	-0.7206	-0.7206	-0.7206
0.675	*****	-0.2565	-0.1194	-0.1576	-0.7222	-0.7222	-0.7222	-0.7222	-0.7222	-0.7222
0.700	-0.2560	-0.2695	-0.0997	-0.1783	-0.8106	-0.8106	-0.8106	-0.8106	-0.8106	-0.8106
0.725	*****	-0.2732	*****	-0.3399	-0.9883	-0.9883	-0.9883	-0.9883	-0.9883	-0.9883
0.750	-0.2373	-0.2766	*****	-0.6548	-1.1125	-1.1125	-1.1125	-1.1125	-1.1125	-1.1125
0.775	*****	-0.3741	-0.7104	-0.8321	-1.1052	-1.1052	-1.1052	-1.1052	-1.1052	-1.1052
0.800	-0.3732	-0.5556	-0.8366	-0.8744	*****	*****	*****	*****	*****	*****
0.825	*****	-0.6975	-0.8381	-0.8761	-0.6638	-0.6638	-0.6638	-0.6638	-0.6638	-0.6638
0.850	-0.5714	-0.7729	-0.8095	-0.7951	-0.7053	-0.7053	-0.7053	-0.7053	-0.7053	-0.7053
0.875	*****	-0.8168	-0.7340	-0.6855	-0.5939	-0.5939	-0.5939	-0.5939	-0.5939	-0.5939
0.900	-0.5752	-0.8208	-0.7047	-0.6481	*****	*****	*****	*****	*****	*****
0.925	*****	-0.8049	-0.6816	-0.6068	-0.5954	-0.5954	-0.5954	-0.5954	-0.5954	-0.5954
0.950	-0.5572	-0.7821	-0.6643	-0.6014	-0.5404	-0.5404	-0.5404	-0.5404	-0.5404	-0.5404
0.975	*****	-0.7818	-0.6572	-0.5944	-0.4787	-0.4787	-0.4787	-0.4787	-0.4787	-0.4787

η	$x/c_R = .2$		$x/c_R = .4$		$x/c_R = .6$		$x/c_R = .8$		$x/c_R = .95$	
	$C_{p,u}$	$C_{p,l}$	$C_{p,u}$	$C_{p,l}$	$C_{p,u}$	$C_{p,l}$	$C_{p,u}$	$C_{p,l}$	$C_{p,u}$	$C_{p,l}$
-0.200	0.1625	0.1645	0.2165	0.2165	0.2165	0.2165	0.2165	0.2165	0.2165	0.2165
-0.400	0.1414	0.1673	0.1856	0.0201	-0.6647	-0.6647	-0.6647	-0.6647	-0.6647	-0.6647
-0.600	*****	0.1767	0.1743	0.0523	-0.6646	-0.6646	-0.6646	-0.6646	-0.6646	-0.6646
-0.700	*****	0.1646	0.1759	0.0681	-0.6484	-0.6484	-0.6484	-0.6484	-0.6484	-0.6484
-0.800	0.2198	0.1808	0.1694	0.0872	-0.5884	-0.5884	-0.5884	-0.5884	-0.5884	-0.5884
-0.850	0.2360	0.1941	0.1831	0.0895	-0.5833	-0.5833	-0.5833	-0.5833	-0.5833	-0.5833
-0.900	0.2498	0.2309	0.2070	0.1149	-0.5903	-0.5903	-0.5903	-0.5903	-0.5903	-0.5903
-0.950	*****	*****	0.2293	0.1581	-0.1694	-0.1694	-0.1694	-0.1694	-0.1694	-0.1694
-0.975	*****	0.2073	0.2089	0.1591	-0.0371	-0.0371	-0.0371	-0.0371	-0.0371	-0.0371

Sharp Radius L.E.
 Run No. = 89, Point No. = 1969
 $C_N = 0.364$, $C_m = -0.0646$
 $\alpha = 8.3^\circ$, $M_\infty = 0.871$
 $R_{mac} = 6.0 \times 10^6$

Surface Pressures Near Leading Edge

● / ◆ upper, starboard/port
 ○ / ◇ lower, starboard/port

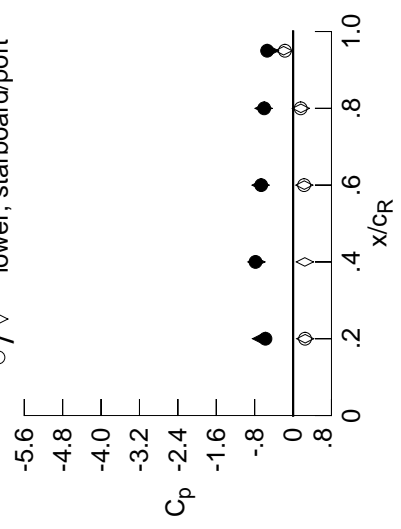

x/c_R	η	starb'd	port	starb'd	port
		$C_{p,u}$	$C_{p,l}$	$C_{p,u}$	$C_{p,l}$
0.20	0.90	-0.5752	-0.6684	0.2519	0.2498
0.40	0.95	-0.7821	-0.7649	0.2450	*****
0.60	0.95	-0.6643	-0.6783	0.2337	0.2293
0.80	0.95	-0.6014	-0.6149	0.1623	0.1581
0.95	0.95	-0.5404	-0.4790	-0.1958	-0.1694

Table D5. Continued.

η	$x/c_R = .2$		$x/c_R = .4$		$x/c_R = .6$		$x/c_R = .8$		$x/c_R = .95$	
	$C_{p,u}$	$C_{p,l}$	$C_{p,u}$	$C_{p,l}$	$C_{p,u}$	$C_{p,l}$	$C_{p,u}$	$C_{p,l}$	$C_{p,u}$	$C_{p,l}$
0.050	-0.1845	-0.1708	0.0021	*****	*****	*****	*****	*****	*****	*****
0.100	-0.1877	-0.1732	-0.0066	*****	*****	*****	*****	*****	*****	*****
0.150	-0.1982	-0.1750	-0.0246	*****	*****	*****	*****	*****	*****	*****
0.200	-0.2069	-0.1754	-0.0393	*****	*****	*****	*****	*****	*****	*****
0.250	*****	-0.1829	-0.0537	-0.2940	-0.3177	*****	*****	*****	*****	*****
0.300	-0.2185	-0.1853	-0.0822	-0.2922	-0.2296	*****	*****	*****	*****	*****
0.350	-0.2329	-0.1904	-0.0938	-0.2658	-0.2063	*****	*****	*****	*****	*****
0.400	-0.2476	-0.2013	-0.0956	-0.2558	-0.2141	*****	*****	*****	*****	*****
0.450	-0.2677	-0.2379	-0.0969	-0.2475	-0.2978	*****	*****	*****	*****	*****
0.500	-0.2800	-0.2292	-0.1191	-0.2385	-0.4893	*****	*****	*****	*****	*****
0.525	*****	-0.2316	-0.1218	-0.2345	-0.6335	*****	*****	*****	*****	*****
0.550	-0.2930	-0.2296	-0.1261	-0.2276	-0.7056	*****	*****	*****	*****	*****
0.575	*****	-0.2336	-0.1234	-0.2205	-0.7386	*****	*****	*****	*****	*****
0.600	-0.2909	-0.2331	-0.1270	-0.2064	-0.7281	*****	*****	*****	*****	*****
0.625	*****	*****	-0.1182	-0.1939	-0.7261	*****	*****	*****	*****	*****
0.650	-0.2735	-0.2400	-0.1047	-0.1915	-0.7505	*****	*****	*****	*****	*****
0.675	*****	-0.2475	-0.1038	-0.2416	-0.8357	*****	*****	*****	*****	*****
0.700	-0.2560	-0.2543	-0.1610	-0.4229	-0.9862	*****	*****	*****	*****	*****
0.725	*****	-0.2972	*****	-0.7054	-1.1069	*****	*****	*****	*****	*****
0.750	-0.3835	-0.4978	*****	-0.9027	-1.0668	*****	*****	*****	*****	*****
0.775	*****	-0.7359	-0.9433	-0.9861	-0.7029	*****	*****	*****	*****	*****
0.800	-0.6049	-0.8328	-0.9633	-0.9600	*****	*****	*****	*****	*****	*****
0.825	*****	-0.8699	-0.9208	-0.8283	-0.5888	*****	*****	*****	*****	*****
0.850	-0.7024	-0.8885	-0.8655	-0.7312	-0.6280	*****	*****	*****	*****	*****
0.875	*****	-0.8891	-0.7563	-0.7159	-0.5752	*****	*****	*****	*****	*****
0.900	-0.6424	-0.8729	-0.7286	-0.6761	*****	*****	*****	*****	*****	*****
0.925	*****	-0.8511	-0.7012	-0.6372	-0.5598	*****	*****	*****	*****	*****
0.950	-0.6892	-0.8392	-0.6804	-0.6378	-0.4951	*****	*****	*****	*****	*****
0.975	*****	-0.8399	-0.6707	-0.6300	-0.4257	*****	*****	*****	*****	*****
-0.200	$C_{p,l}$	0.1891	0.1852	0.2350	*****	*****	*****	*****	*****	*****
-0.400	$C_{p,l}$	0.1695	0.1939	0.2003	0.0370	-0.6640	*****	*****	*****	*****
-0.600	*****	0.1995	0.1933	0.0671	-0.6550	*****	*****	*****	*****	*****
-0.700	*****	0.1910	0.1948	0.0830	-0.6387	*****	*****	*****	*****	*****
-0.800	$C_{p,l}$	0.2441	0.2126	0.1916	0.1041	-0.5739	*****	*****	*****	*****
-0.850	$C_{p,l}$	0.2579	0.2184	0.2045	0.1062	-0.5685	*****	*****	*****	*****
-0.900	$C_{p,l}$	0.2649	0.2507	0.2278	0.1316	-0.5628	*****	*****	*****	*****
-0.950	*****	*****	*****	0.2389	0.1688	-0.1622	*****	*****	*****	*****
-0.975	*****	0.2035	0.2074	0.1604	-0.0297	*****	*****	*****	*****	*****

Sharp Radius L.E.
 Run No. = 89, Point No. = 1970
 $C_N = 0.425$, $C_m = -0.0787$
 $\alpha = 9.3^\circ$, $M_\infty = 0.872$
 $R_{mac} = 6.0 \times 10^6$

Surface Pressures Near Leading Edge

● / ◆ upper, starboard/port
 ○ / ◇ lower, starboard/port

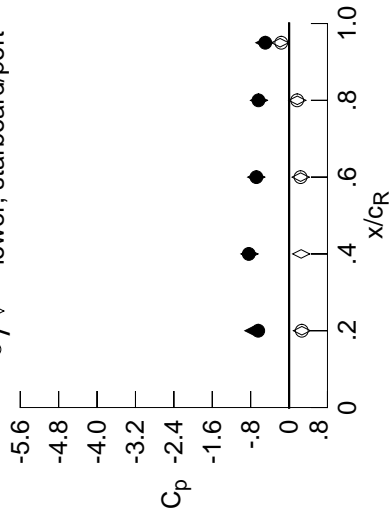

x/c_R	η	starb'd	port	starb'd	port
		$C_{p,u}$	$C_{p,l}$	$C_{p,u}$	$C_{p,l}$
0.20	0.90	-0.6424	-0.7440	0.2672	0.2649
0.40	0.95	-0.8392	-0.8262	0.2521	*****
0.60	0.95	-0.6804	-0.6840	0.2406	0.2389
0.80	0.95	-0.6378	-0.6262	0.1708	0.1688
0.95	0.95	-0.4951	-0.5153	-0.1869	-0.1622

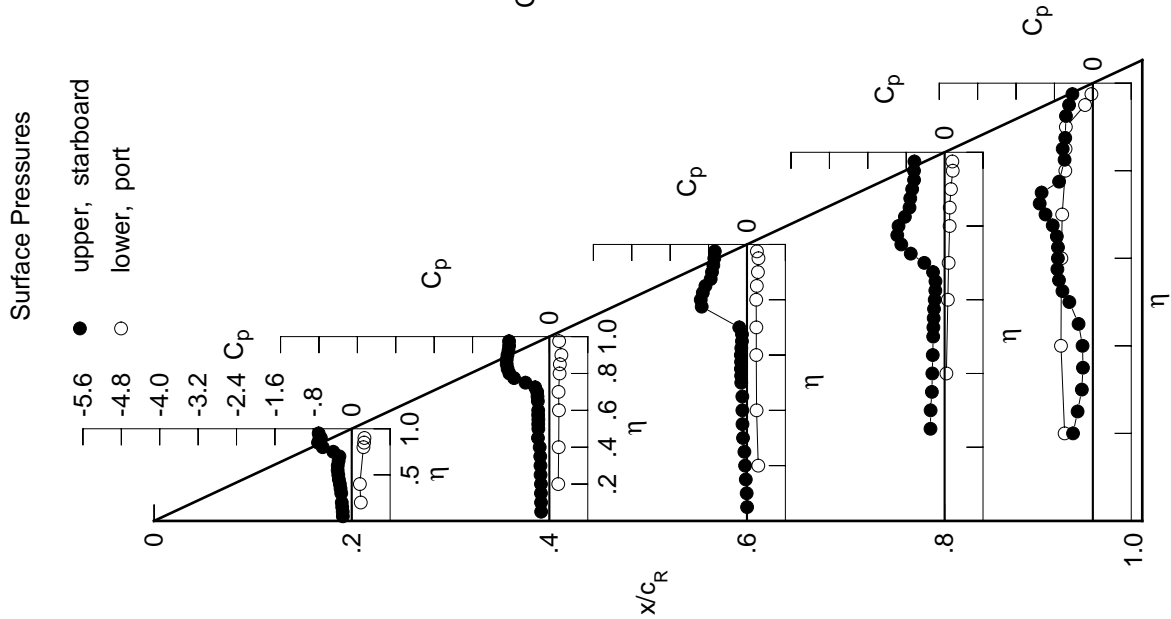

Table D5. Continued.

η	$x/c_R = .2$		$x/c_R = .4$		$x/c_R = .6$		$x/c_R = .8$		$x/c_R = .95$	
	$C_{p,u}$	$C_{p,l}$	$C_{p,u}$	$C_{p,l}$	$C_{p,u}$	$C_{p,l}$	$C_{p,u}$	$C_{p,l}$	$C_{p,u}$	$C_{p,l}$
0.050	-0.2071	-0.1964	-0.0188	*****	*****	*****	*****	*****	*****	*****
0.100	-0.2136	-0.2031	-0.0286	*****	*****	*****	*****	*****	*****	*****
0.150	-0.2206	-0.2007	-0.0459	*****	*****	*****	*****	*****	*****	*****
0.200	-0.2300	-0.2018	-0.0600	*****	*****	*****	*****	*****	*****	*****
0.250	*****	-0.2105	-0.0708	-0.3185	-0.2717	*****	*****	*****	*****	*****
0.300	-0.2391	-0.2108	-0.0907	-0.3103	-0.2607	*****	*****	*****	*****	*****
0.350	-0.2534	-0.2161	-0.1183	-0.2880	-0.2504	*****	*****	*****	*****	*****
0.400	-0.2667	-0.2164	-0.1149	-0.2745	-0.2905	*****	*****	*****	*****	*****
0.450	-0.2849	-0.2548	-0.1179	-0.2665	-0.4540	*****	*****	*****	*****	*****
0.500	-0.2940	-0.2714	-0.1370	-0.2532	-0.6709	*****	*****	*****	*****	*****
0.525	*****	-0.2667	-0.1360	-0.2506	-0.7076	*****	*****	*****	*****	*****
0.550	-0.3031	-0.2622	-0.1339	-0.2400	-0.7047	*****	*****	*****	*****	*****
0.575	*****	-0.2612	-0.1268	-0.2329	-0.7070	*****	*****	*****	*****	*****
0.600	-0.3003	-0.2491	-0.1255	-0.2299	-0.7097	*****	*****	*****	*****	*****
0.625	*****	*****	-0.1166	-0.2422	-0.7493	*****	*****	*****	*****	*****
0.650	-0.2796	-0.2152	-0.1396	-0.3135	-0.8434	*****	*****	*****	*****	*****
0.675	*****	-0.2219	-0.2824	-0.4945	-0.9726	*****	*****	*****	*****	*****
0.700	-0.3801	-0.4221	-0.6022	-0.7446	-1.0988	*****	*****	*****	*****	*****
0.725	*****	-0.7534	*****	-0.9550	-1.0322	*****	*****	*****	*****	*****
0.750	-0.6486	-0.9145	*****	-1.0651	-0.6792	*****	*****	*****	*****	*****
0.775	*****	-0.9734	-1.0523	-1.0158	-0.5907	*****	*****	*****	*****	*****
0.800	-0.7729	-0.9771	-1.0441	-0.8042	*****	*****	*****	*****	*****	*****
0.825	*****	-0.9585	-0.9770	-0.7302	-0.5536	*****	*****	*****	*****	*****
0.850	-0.7906	-0.9493	-0.8744	-0.7357	-0.5790	*****	*****	*****	*****	*****
0.875	*****	-0.9268	-0.7701	-0.7452	-0.5393	*****	*****	*****	*****	*****
0.900	-0.7169	-0.9025	-0.7546	-0.6887	*****	*****	*****	*****	*****	*****
0.925	*****	-0.8814	-0.7206	-0.6863	-0.5038	*****	*****	*****	*****	*****
0.950	-0.7933	-0.8703	-0.6938	-0.6925	-0.4307	*****	*****	*****	*****	*****
0.975	*****	-0.8701	-0.6823	-0.6831	-0.3803	*****	*****	*****	*****	*****
-0.200	$C_{p,l}$	0.2132	0.2090	0.2508	*****	*****	*****	*****	*****	*****
-0.400	$C_{p,l}$	0.1985	0.2125	0.2189	0.0481	-0.6650	*****	*****	*****	*****
-0.600	$C_{p,l}$	*****	0.2255	0.2115	0.0810	-0.6491	*****	*****	*****	*****
-0.700	$C_{p,l}$	*****	0.2165	0.2125	0.0953	-0.6283	*****	*****	*****	*****
-0.800	$C_{p,l}$	0.2702	0.2383	0.2115	0.1198	-0.5649	*****	*****	*****	*****
-0.850	$C_{p,l}$	0.2772	0.2413	0.2245	0.1231	-0.5552	*****	*****	*****	*****
-0.900	$C_{p,l}$	0.2796	0.2679	0.2461	0.1463	-0.5396	*****	*****	*****	*****
-0.950	$C_{p,l}$	*****	*****	0.2411	0.1754	-0.1521	*****	*****	*****	*****
-0.975	$C_{p,l}$	*****	0.1977	0.2031	0.1543	-0.0263	*****	*****	*****	*****

Sharp Radius L.E.

Run No. = 89, Point No. = 1971

$C_N = 0.478$, $C_m = -0.0851$

$\alpha = 10.4^\circ$, $M_\infty = 0.871$

$R_{mac} = 6.0 \times 10^6$

Surface Pressures Near Leading Edge

● / ◆ upper, starboard/port
○ / ◇ lower, starboard/port

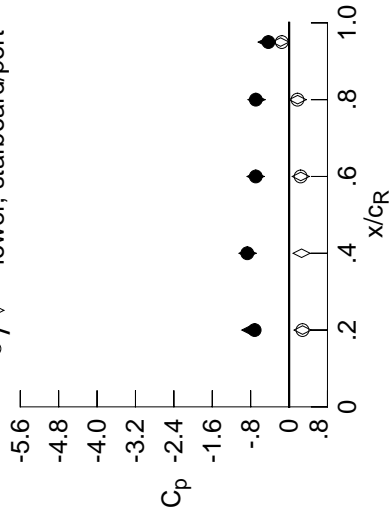

x/cR	η	$C_{p,u}$ starb'd	$C_{p,u}$ port	$C_{p,l}$ starb'd	$C_{p,l}$ port
0.20	0.90	-0.7169	-0.8081	0.2818	0.2796
0.40	0.95	-0.8703	-0.8658	0.2605	*****
0.60	0.95	-0.6938	-0.6975	0.2441	0.2411
0.80	0.95	-0.6925	-0.6792	0.1781	0.1754
0.95	0.95	-0.4307	-0.4664	-0.1776	-0.1521

Table D5. Continued.

η	$x/c_R = .2$		$x/c_R = .4$		$x/c_R = .6$		$x/c_R = .8$		$x/c_R = .95$	
	$C_{p,u}$	$C_{p,l}$	$C_{p,u}$	$C_{p,l}$	$C_{p,u}$	$C_{p,l}$	$C_{p,u}$	$C_{p,l}$	$C_{p,u}$	$C_{p,l}$
0.050	-0.2279	-0.2271	-0.0371	*****	*****	*****	*****	*****	*****	*****
0.100	-0.2322	-0.2284	-0.0470	*****	*****	*****	*****	*****	*****	*****
0.150	-0.2439	-0.2310	-0.0601	*****	*****	*****	*****	*****	*****	*****
0.200	-0.2515	-0.2287	-0.0739	*****	*****	*****	*****	*****	*****	*****
0.250	*****	-0.2366	-0.0870	-0.3369	-0.2167	*****	*****	*****	*****	*****
0.300	-0.2617	-0.2361	-0.1020	-0.3228	-0.3064	*****	*****	*****	*****	*****
0.350	-0.2776	-0.2357	-0.1259	-0.3096	-0.3814	*****	*****	*****	*****	*****
0.400	-0.2898	-0.2372	-0.1341	-0.2963	-0.5590	*****	*****	*****	*****	*****
0.450	-0.3129	-0.2562	-0.1323	-0.2847	-0.7047	*****	*****	*****	*****	*****
0.500	-0.3327	-0.2844	-0.1426	-0.2729	-0.7060	*****	*****	*****	*****	*****
0.525	*****	-0.2801	-0.1438	-0.2680	-0.7003	*****	*****	*****	*****	*****
0.550	-0.3394	-0.2766	-0.1376	-0.2686	-0.7051	*****	*****	*****	*****	*****
0.575	*****	-0.2684	-0.1330	-0.2732	-0.7363	*****	*****	*****	*****	*****
0.600	-0.2949	-0.2512	-0.1498	-0.3079	-0.7910	*****	*****	*****	*****	*****
0.625	*****	*****	-0.1997	-0.3848	-0.8907	*****	*****	*****	*****	*****
0.650	-0.2981	-0.3366	-0.3759	-0.5448	-1.0178	*****	*****	*****	*****	*****
0.675	*****	-0.6355	-0.6801	-0.7650	-1.1187	*****	*****	*****	*****	*****
0.700	-0.6533	-0.9203	-0.9611	-0.9757	-0.9333	*****	*****	*****	*****	*****
0.725	*****	-1.0464	*****	-1.1253	-0.6457	*****	*****	*****	*****	*****
0.750	-0.8499	-1.0690	*****	-0.9437	-0.5745	*****	*****	*****	*****	*****
0.775	*****	-1.0548	-1.1310	-0.7811	-0.5374	*****	*****	*****	*****	*****
0.800	-0.8794	-1.0345	-1.0680	-0.7516	*****	*****	*****	*****	*****	*****
0.825	*****	-1.0045	-0.9140	-0.7560	-0.5201	*****	*****	*****	*****	*****
0.850	-0.8600	-0.9756	-0.8435	-0.7649	-0.5356	*****	*****	*****	*****	*****
0.875	*****	-0.9418	-0.7938	-0.7424	-0.4948	*****	*****	*****	*****	*****
0.900	-0.7864	-0.9160	-0.7910	-0.7322	*****	*****	*****	*****	*****	*****
0.925	*****	-0.8945	-0.7471	-0.7505	-0.4426	*****	*****	*****	*****	*****
0.950	-0.8719	-0.8816	-0.7149	-0.7513	-0.3814	*****	*****	*****	*****	*****
0.975	*****	-0.8854	-0.7035	-0.7366	-0.3525	*****	*****	*****	*****	*****
-0.200	$C_{p,l}$	0.2410	0.2309	0.2676	*****	*****	*****	*****	*****	*****
-0.400	$C_{p,l}$	0.2275	0.2376	0.2355	0.0630	-0.6573	*****	*****	*****	*****
-0.600	$C_{p,l}$	*****	0.2465	0.2288	0.0967	-0.6419	*****	*****	*****	*****
-0.700	$C_{p,l}$	*****	0.2423	0.2331	0.1083	-0.6181	*****	*****	*****	*****
-0.800	$C_{p,l}$	0.2946	0.2591	0.2302	0.1366	-0.5528	*****	*****	*****	*****
-0.850	$C_{p,l}$	0.2982	0.2628	0.2444	0.1390	-0.5392	*****	*****	*****	*****
-0.900	$C_{p,l}$	0.2946	0.2860	0.2608	0.1603	-0.5181	*****	*****	*****	*****
-0.950	$C_{p,l}$	*****	*****	0.2511	0.1825	-0.1434	*****	*****	*****	*****
-0.975	$C_{p,l}$	*****	0.1940	0.1971	0.1513	-0.0250	*****	*****	*****	*****

Sharp Radius L.E.
 Run No. = 89, Point No. = 1972
 $C_N = 0.533$, $C_m = -0.0949$
 $\alpha = 11.4^\circ$, $M_\infty = 0.871$
 $R_{mac} = 6.0 \times 10^6$

Surface Pressures Near Leading Edge

● / ◆ upper, starboard/port
 ○ / ◇ lower, starboard/port

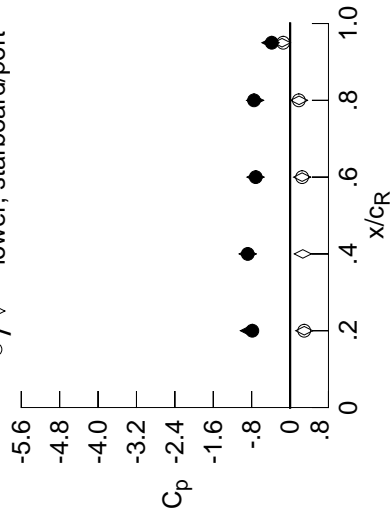

x/c_R	η	starb'd	port	starb'd	port
		$C_{p,u}$	$C_{p,l}$	$C_{p,u}$	$C_{p,l}$
0.20	0.90	-0.7864	-0.8584	0.2951	0.2946
0.40	0.95	-0.8816	-0.8844	0.2655	*****
0.60	0.95	-0.7149	-0.7216	0.2511	0.2511
0.80	0.95	-0.7513	-0.7282	0.1874	0.1825
0.95	0.95	-0.3814	-0.4093	-0.1672	-0.1434

Surface Pressures

● upper, starboard
 ○ lower, port

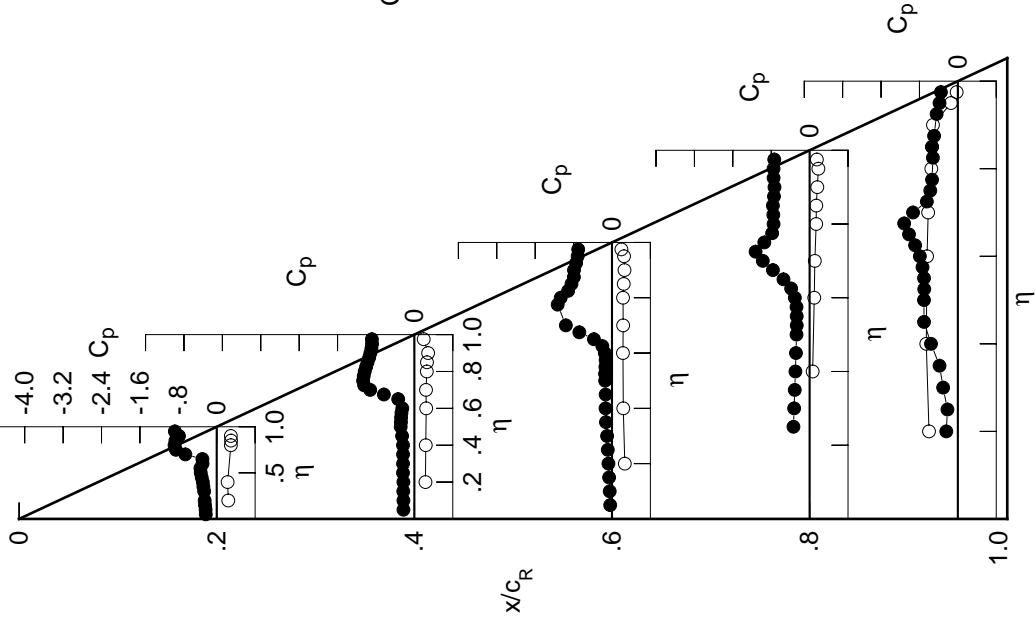

Table D5. Continued.

η	$x/c_R = .2$		$x/c_R = .4$		$x/c_R = .6$		$x/c_R = .8$		$x/c_R = .95$	
	$C_{p,u}$	$C_{p,l}$	$C_{p,u}$	$C_{p,l}$	$C_{p,u}$	$C_{p,l}$	$C_{p,u}$	$C_{p,l}$	$C_{p,u}$	$C_{p,l}$
0.050	-0.2530	-0.2549	-0.0565	*****	*****	*****	*****	*****	*****	*****
0.100	-0.2595	-0.2592	-0.0667	*****	*****	*****	*****	*****	*****	*****
0.150	-0.2687	-0.2588	-0.0777	*****	*****	*****	*****	*****	*****	*****
0.200	-0.2804	-0.2599	-0.0909	*****	*****	*****	*****	*****	*****	*****
0.250	*****	-0.2651	-0.1050	-0.3575	-0.2096	*****	*****	*****	*****	*****
0.300	-0.3037	-0.2654	-0.1200	-0.3405	-0.3092	*****	*****	*****	*****	*****
0.350	-0.3284	-0.2664	-0.1329	-0.3263	-0.4296	*****	*****	*****	*****	*****
0.400	-0.3467	-0.2635	-0.1437	-0.3144	-0.6332	*****	*****	*****	*****	*****
0.450	-0.3639	-0.2599	-0.1404	-0.3017	-0.7013	*****	*****	*****	*****	*****
0.500	-0.3600	-0.2760	-0.1514	-0.2937	-0.6989	*****	*****	*****	*****	*****
0.525	*****	-0.2838	-0.1510	-0.2997	-0.7095	*****	*****	*****	*****	*****
0.550	-0.3294	-0.2857	-0.1561	-0.3134	-0.7334	*****	*****	*****	*****	*****
0.575	*****	-0.2924	-0.1751	-0.3520	-0.7978	*****	*****	*****	*****	*****
0.600	-0.2442	-0.3303	-0.2739	-0.4305	-0.8840	*****	*****	*****	*****	*****
0.625	*****	*****	-0.4486	-0.5681	-1.0067	*****	*****	*****	*****	*****
0.650	-0.4954	-0.7872	-0.7577	-0.7607	-1.1299	*****	*****	*****	*****	*****
0.675	*****	-1.0163	-1.0310	-0.9654	-0.8693	*****	*****	*****	*****	*****
0.700	-0.8919	-1.1209	-1.2004	-1.1365	-0.6595	*****	*****	*****	*****	*****
0.725	*****	-1.1439	*****	-0.9869	-0.5696	*****	*****	*****	*****	*****
0.750	-0.9761	-1.1257	*****	-0.8155	-0.5348	*****	*****	*****	*****	*****
0.775	*****	-1.0916	-1.1027	-0.7969	-0.5185	*****	*****	*****	*****	*****
0.800	-0.9657	-1.0558	-0.9704	-0.8030	*****	*****	*****	*****	*****	*****
0.825	*****	-1.0163	-0.8785	-0.8230	-0.4980	*****	*****	*****	*****	*****
0.850	-0.9255	-0.9813	-0.8529	-0.8192	-0.5038	*****	*****	*****	*****	*****
0.875	*****	-0.9503	-0.8300	-0.7812	-0.4731	*****	*****	*****	*****	*****
0.900	-0.8528	-0.9291	-0.8364	-0.7714	*****	*****	*****	*****	*****	*****
0.925	*****	-0.9078	-0.7682	-0.7898	-0.4125	*****	*****	*****	*****	*****
0.950	-0.9374	-0.9051	-0.7405	-0.7865	-0.3629	*****	*****	*****	*****	*****
0.975	*****	-0.9086	-0.7314	-0.7760	-0.3400	*****	*****	*****	*****	*****

η	$x/c_R = .2$		$x/c_R = .4$		$x/c_R = .6$		$x/c_R = .8$		$x/c_R = .95$	
	$C_{p,u}$	$C_{p,l}$	$C_{p,u}$	$C_{p,l}$	$C_{p,u}$	$C_{p,l}$	$C_{p,u}$	$C_{p,l}$	$C_{p,u}$	$C_{p,l}$
-0.200	0.2708	0.2536	0.2837	*****	*****	*****	*****	*****	*****	*****
-0.400	0.2564	0.2622	0.2543	0.0795	-0.6520	*****	*****	*****	*****	*****
-0.600	*****	0.2706	0.2467	0.1115	-0.6311	*****	*****	*****	*****	*****
-0.700	*****	0.2675	0.2530	0.1262	-0.6073	*****	*****	*****	*****	*****
-0.800	0.3171	0.2823	0.2500	0.1519	-0.5406	*****	*****	*****	*****	*****
-0.850	0.3179	0.2827	0.2607	0.1549	-0.5261	*****	*****	*****	*****	*****
-0.900	0.3086	0.3001	0.2744	0.1740	-0.4980	*****	*****	*****	*****	*****
-0.950	*****	*****	0.2557	0.1863	-0.1371	*****	*****	*****	*****	*****
-0.975	*****	0.1886	0.1895	0.1435	-0.0249	*****	*****	*****	*****	*****

Sharp Radius L.E.
 Run No. = 89, Point No. = 1973
 $C_N = 0.584$, $C_m = -0.1003$
 $\alpha = 12.4^\circ$, $M_\infty = 0.871$
 $R_{mac} = 6.0 \times 10^6$

Surface Pressures Near Leading Edge

● / ◆ upper, starboard/port
 ○ / ◇ lower, starboard/port

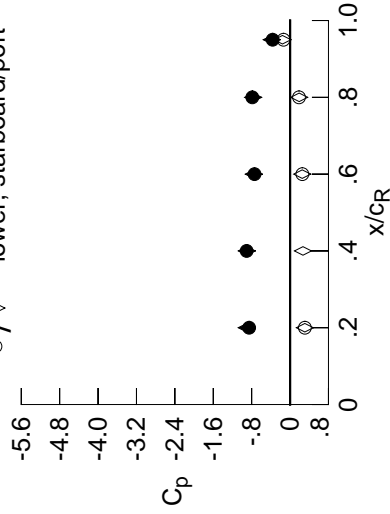

x/c_R	η	starb'd	port	starb'd	port
x/c_R	η	$C_{p,u}$	$C_{p,l}$	$C_{p,u}$	$C_{p,l}$
0.20	0.90	-0.8528	-0.9030	0.3082	0.3086
0.40	0.95	-0.9051	-0.9016	0.2691	*****
0.60	0.95	-0.7405	-0.7561	0.2536	0.2557
0.80	0.95	-0.7865	-0.7692	0.1892	0.1863
0.95	0.95	-0.3629	-0.3826	-0.1581	-0.1371

Table D5. Continued.

η	$x/c_R = .2$		$x/c_R = .4$		$x/c_R = .6$		$x/c_R = .8$		$x/c_R = .95$	
	$C_{p,u}$	$C_{p,u}$	$C_{p,u}$	$C_{p,u}$	$C_{p,u}$	$C_{p,u}$	$C_{p,u}$	$C_{p,u}$	$C_{p,u}$	$C_{p,u}$
0.050	-0.2795	-0.2923	-0.0740	*****	*****	*****	*****	*****	*****	*****
0.100	-0.2821	-0.2943	-0.0836	*****	*****	*****	*****	*****	*****	*****
0.150	-0.2940	-0.2949	-0.0968	*****	*****	*****	*****	*****	*****	*****
0.200	-0.3063	-0.2920	-0.1103	*****	*****	*****	*****	*****	*****	*****
0.250	*****	-0.3004	-0.1213	-0.3811	-0.2286	*****	*****	*****	*****	*****
0.300	-0.3364	-0.2968	-0.1373	-0.3638	-0.3132	*****	*****	*****	*****	*****
0.350	-0.3641	-0.2991	-0.1488	-0.3489	-0.4592	*****	*****	*****	*****	*****
0.400	-0.3915	-0.2998	-0.1536	-0.3353	-0.6383	*****	*****	*****	*****	*****
0.450	-0.4166	-0.2936	-0.1514	-0.3258	-0.6819	*****	*****	*****	*****	*****
0.500	-0.4016	-0.2822	-0.1675	-0.3298	-0.6982	*****	*****	*****	*****	*****
0.525	*****	-0.2894	-0.1837	-0.3503	-0.7231	*****	*****	*****	*****	*****
0.550	-0.3332	-0.3055	-0.2207	-0.3902	-0.7740	*****	*****	*****	*****	*****
0.575	*****	-0.3740	-0.3095	-0.4654	-0.8614	*****	*****	*****	*****	*****
0.600	-0.2429	-0.5409	-0.5180	-0.5871	-0.9651	*****	*****	*****	*****	*****
0.625	*****	*****	-0.7669	-0.7548	-1.0936	*****	*****	*****	*****	*****
0.650	-0.7318	-1.0568	-1.0316	-0.9445	-0.9823	*****	*****	*****	*****	*****
0.675	*****	-1.1861	-1.2100	-1.1209	-0.6664	*****	*****	*****	*****	*****
0.700	-1.0540	-1.2272	-1.3021	-1.1100	-0.5677	*****	*****	*****	*****	*****
0.725	*****	-1.2240	*****	-0.8552	-0.5296	*****	*****	*****	*****	*****
0.750	-1.1035	-1.1921	*****	-0.8313	-0.5164	*****	*****	*****	*****	*****
0.775	*****	-1.1534	-1.0281	-0.8318	-0.5054	*****	*****	*****	*****	*****
0.800	-1.0351	-1.1094	-0.9449	-0.8477	*****	*****	*****	*****	*****	*****
0.825	*****	-1.0602	-0.9113	-0.8617	-0.4855	*****	*****	*****	*****	*****
0.850	-0.9858	-1.0158	-0.9062	-0.8614	-0.4853	*****	*****	*****	*****	*****
0.875	*****	-0.9851	-0.8999	-0.8272	-0.4602	*****	*****	*****	*****	*****
0.900	-0.9112	-0.9631	-0.8779	-0.8117	*****	*****	*****	*****	*****	*****
0.925	*****	-0.9421	-0.8022	-0.8324	-0.3907	*****	*****	*****	*****	*****
0.950	-0.9919	-0.9331	-0.7830	-0.8396	-0.3532	*****	*****	*****	*****	*****
0.975	*****	-0.9339	-0.7730	-0.8294	-0.3328	*****	*****	*****	*****	*****
-0.200	$C_{p,l}$	0.2987	0.2791	0.3020	*****	*****	*****	*****	*****	*****
-0.400	$C_{p,l}$	0.2847	0.2859	0.2733	0.0927	-0.6467	*****	*****	*****	*****
-0.600	*****	0.2960	0.2641	0.1261	-0.6210	*****	*****	*****	*****	*****
-0.700	*****	0.2910	0.2685	0.1407	-0.5978	*****	*****	*****	*****	*****
-0.800	$C_{p,l}$	0.3404	0.3044	0.2667	0.1664	-0.5276	*****	*****	*****	*****
-0.850	$C_{p,l}$	0.3361	0.3025	0.2781	0.1685	-0.5130	*****	*****	*****	*****
-0.900	$C_{p,l}$	0.3199	0.3136	0.2867	0.1856	-0.4787	*****	*****	*****	*****
-0.950	*****	*****	*****	0.2556	0.1870	-0.1292	*****	*****	*****	*****
-0.975	*****	0.1827	0.1787	0.1326	-0.0268	*****	*****	*****	*****	*****

Sharp Radius L.E.
 Run No. = 89, Point No. = 1974
 $C_N = 0.636$, $C_m = -0.1070$
 $\alpha = 13.5^\circ$, $M_\infty = 0.871$
 $R_{mac} = 6.0 \times 10^6$

Surface Pressures Near Leading Edge

● / ◆ upper, starboard/port
 ○ / ◇ lower, starboard/port

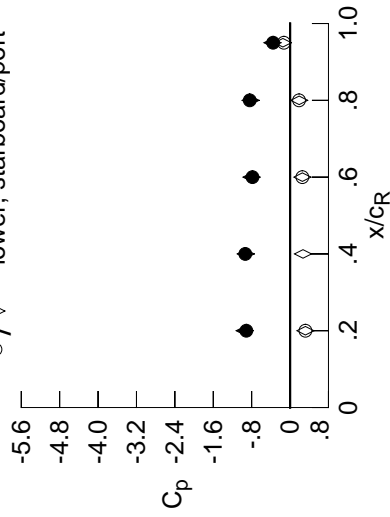

x/c_R	η	starb'd	port	starb'd	port
0.20	0.90	-0.9112	-0.9464	0.3202	0.3199
0.40	0.95	-0.9331	-0.9235	0.2700	*****
0.60	0.95	-0.7830	-0.8038	0.2566	0.2556
0.80	0.95	-0.8396	-0.8224	0.1895	0.1870
0.95	0.95	-0.3532	-0.3681	-0.1497	-0.1292

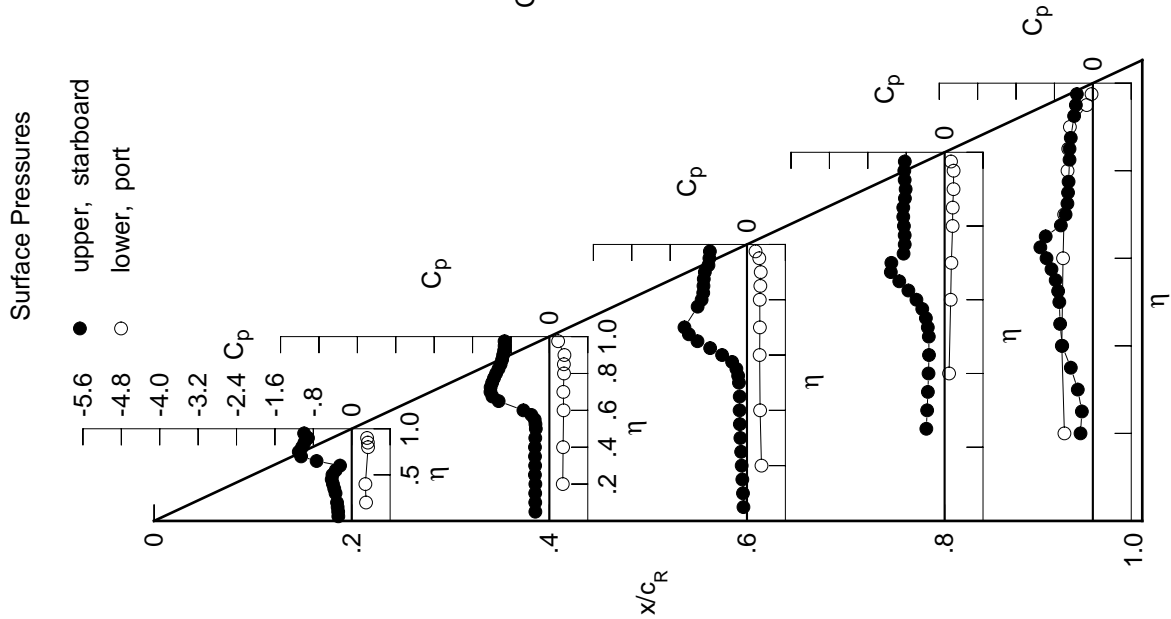

Table D5. Continued.

η	$x/c_R = .2$		$x/c_R = .4$		$x/c_R = .6$		$x/c_R = .8$		$x/c_R = .95$	
	$C_{p,u}$	$C_{p,l}$	$C_{p,u}$	$C_{p,l}$	$C_{p,u}$	$C_{p,l}$	$C_{p,u}$	$C_{p,l}$	$C_{p,u}$	$C_{p,l}$
0.050	-0.2984	-0.3266	-0.0917	*****	*****	*****	*****	*****	*****	*****
0.100	-0.3001	-0.3291	-0.1021	*****	*****	*****	*****	*****	*****	*****
0.150	-0.3123	-0.3291	-0.1140	*****	*****	*****	*****	*****	*****	*****
0.200	-0.3219	-0.3278	-0.1287	*****	*****	*****	*****	*****	*****	*****
0.250	*****	-0.3348	-0.1407	-0.4077	-0.2456	*****	*****	*****	*****	*****
0.300	-0.3444	-0.3350	-0.1553	-0.3883	-0.3239	*****	*****	*****	*****	*****
0.350	-0.3664	-0.3348	-0.1664	-0.3729	-0.4649	*****	*****	*****	*****	*****
0.400	-0.3878	-0.3335	-0.1752	-0.3626	-0.6119	*****	*****	*****	*****	*****
0.450	-0.4129	-0.3276	-0.1764	-0.3615	-0.6580	*****	*****	*****	*****	*****
0.500	-0.4123	-0.3244	-0.2218	-0.3867	-0.6917	*****	*****	*****	*****	*****
0.525	*****	-0.3456	-0.2709	-0.4282	-0.7362	*****	*****	*****	*****	*****
0.550	-0.3691	-0.3961	-0.3645	-0.4978	-0.8073	*****	*****	*****	*****	*****
0.575	*****	-0.5307	-0.5229	-0.6067	-0.9157	*****	*****	*****	*****	*****
0.600	-0.5337	-0.7493	-0.7665	-0.7493	-1.0301	*****	*****	*****	*****	*****
0.625	*****	*****	-0.9805	-0.9183	-1.1393	*****	*****	*****	*****	*****
0.650	-1.0834	-1.2043	-1.1728	-1.0836	-0.7053	*****	*****	*****	*****	*****
0.675	*****	-1.3059	-1.2975	-1.2179	-0.5902	*****	*****	*****	*****	*****
0.700	-1.0586	-1.3242	-1.3670	-0.9312	-0.5476	*****	*****	*****	*****	*****
0.725	*****	-1.2964	*****	-0.8754	-0.5277	*****	*****	*****	*****	*****
0.750	-1.1216	-1.2815	*****	-0.8663	-0.5195	*****	*****	*****	*****	*****
0.775	*****	-1.2421	-1.0174	-0.8713	-0.5010	*****	*****	*****	*****	*****
0.800	-1.1230	-1.1803	-0.9896	-0.8878	*****	*****	*****	*****	*****	*****
0.825	*****	-1.1103	-0.9734	-0.9059	-0.4775	*****	*****	*****	*****	*****
0.850	-1.0603	-1.0561	-0.9779	-0.9058	-0.4705	*****	*****	*****	*****	*****
0.875	*****	-1.0222	-0.9530	-0.8624	-0.4530	*****	*****	*****	*****	*****
0.900	-0.9685	-0.9951	-0.9056	-0.8396	*****	*****	*****	*****	*****	*****
0.925	*****	-0.9652	-0.8413	-0.8645	-0.3848	*****	*****	*****	*****	*****
0.950	-1.0338	-0.9509	-0.8322	-0.8741	-0.3514	*****	*****	*****	*****	*****
0.975	*****	-0.9451	-0.8223	-0.8679	-0.3320	*****	*****	*****	*****	*****

η	$x/c_R = .2$		$x/c_R = .4$		$x/c_R = .6$		$x/c_R = .8$		$x/c_R = .95$	
	$C_{p,u}$	$C_{p,l}$	$C_{p,u}$	$C_{p,l}$	$C_{p,u}$	$C_{p,l}$	$C_{p,u}$	$C_{p,l}$	$C_{p,u}$	$C_{p,l}$
-0.200	0.3268	0.3022	0.3206	*****	-0.5832	*****	*****	*****	*****	*****
-0.400	0.3154	0.3106	0.2889	0.1081	-0.6362	*****	*****	*****	*****	*****
-0.600	*****	0.3198	0.2840	0.1402	-0.6121	*****	*****	*****	*****	*****
-0.700	*****	0.3162	0.2875	0.1564	-0.5888	*****	*****	*****	*****	*****
-0.800	0.3616	0.3271	0.2849	0.1781	-0.5174	*****	*****	*****	*****	*****
-0.850	0.3540	0.3214	0.2940	0.1819	-0.4990	*****	*****	*****	*****	*****
-0.900	0.3327	0.3270	0.2967	0.1973	-0.4604	*****	*****	*****	*****	*****
-0.950	*****	*****	0.2553	0.1881	-0.1228	*****	*****	*****	*****	*****
-0.975	*****	0.1767	0.1682	0.1239	-0.0289	*****	*****	*****	*****	*****

Sharp Radius L.E.
 Run No. = 89, Point No. = 1975
 $C_N = 0.689$, $C_m = -0.1144$
 $\alpha = 14.5^\circ$, $M_\infty = 0.871$
 $R_{mac} = 6.0 \times 10^6$

Surface Pressures Near Leading Edge

● / ◆ upper, starboard/port
 ○ / ◇ lower, starboard/port

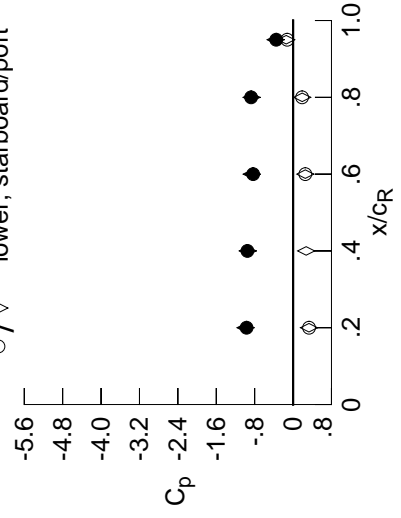

x/c_R	η	starb'd	port	starb'd	port
		$C_{p,u}$	$C_{p,l}$	$C_{p,u}$	$C_{p,l}$
0.20	0.90	-0.9685	-0.9912	0.3308	0.3327
0.40	0.95	-0.9509	-0.9447	0.2730	*****
0.60	0.95	-0.8322	-0.8623	0.2551	0.2553
0.80	0.95	-0.8741	-0.8647	0.1905	0.1881
0.95	0.95	-0.3514	-0.3640	-0.1430	-0.1228

Table D5. Continued.

η	$x/c_R = .2$		$x/c_R = .4$		$x/c_R = .6$		$x/c_R = .8$		$x/c_R = .95$	
	$C_{p,u}$	$C_{p,l}$	$C_{p,u}$	$C_{p,l}$	$C_{p,u}$	$C_{p,l}$	$C_{p,u}$	$C_{p,l}$	$C_{p,u}$	$C_{p,l}$
0.050	-0.3148	-0.3531	-0.1067	*****	*****	*****	*****	*****	*****	*****
0.100	-0.3162	-0.3546	-0.1167	*****	*****	*****	*****	*****	*****	*****
0.150	-0.3252	-0.3544	-0.1316	*****	*****	*****	*****	*****	*****	*****
0.200	-0.3339	-0.3540	-0.1467	*****	*****	*****	*****	*****	*****	*****
0.250	*****	-0.3620	-0.1616	-0.4323	-0.2635	*****	*****	*****	*****	*****
0.300	-0.3440	-0.3592	-0.1772	-0.4147	-0.3384	*****	*****	*****	*****	*****
0.350	-0.3592	-0.3605	-0.1919	-0.4012	-0.4599	*****	*****	*****	*****	*****
0.400	-0.3711	-0.3613	-0.2081	-0.3939	-0.5807	*****	*****	*****	*****	*****
0.450	-0.3829	-0.3567	-0.2290	-0.4065	-0.6346	*****	*****	*****	*****	*****
0.500	-0.3681	-0.3769	-0.3208	-0.4609	-0.6977	*****	*****	*****	*****	*****
0.525	*****	-0.4274	-0.4137	-0.5241	-0.7580	*****	*****	*****	*****	*****
0.550	-0.3743	-0.5292	-0.5568	-0.6217	-0.8450	*****	*****	*****	*****	*****
0.575	*****	-0.7150	-0.7397	-0.7542	-0.9671	*****	*****	*****	*****	*****
0.600	-0.8669	-0.9397	-0.9606	-0.9008	-1.0884	*****	*****	*****	*****	*****
0.625	*****	*****	-1.1309	-1.0583	-0.8963	*****	*****	*****	*****	*****
0.650	-1.2563	-1.3194	-1.2827	-1.2012	-0.6195	*****	*****	*****	*****	*****
0.675	*****	-1.4049	-1.3825	-1.1085	-0.5685	*****	*****	*****	*****	*****
0.700	-1.2895	-1.4255	-1.3216	-0.9230	-0.5535	*****	*****	*****	*****	*****
0.725	*****	-1.3656	*****	-0.9091	-0.5381	*****	*****	*****	*****	*****
0.750	-1.1968	-1.3281	*****	-0.9052	-0.5334	*****	*****	*****	*****	*****
0.775	*****	-1.2949	-1.0604	-0.9157	-0.5084	*****	*****	*****	*****	*****
0.800	-1.1442	-1.2079	-1.0593	-0.9388	*****	*****	*****	*****	*****	*****
0.825	*****	-1.1278	-1.0649	-0.9563	-0.4696	*****	*****	*****	*****	*****
0.850	-1.0918	-1.0850	-1.0795	-0.9432	-0.4565	*****	*****	*****	*****	*****
0.875	*****	-1.0531	-0.9929	-0.8882	-0.4384	*****	*****	*****	*****	*****
0.900	-1.0150	-1.0272	-0.9330	-0.8605	*****	*****	*****	*****	*****	*****
0.925	*****	-0.9911	-0.8867	-0.8843	-0.3818	*****	*****	*****	*****	*****
0.950	-1.0650	-0.9677	-0.8774	-0.8941	-0.3497	*****	*****	*****	*****	*****
0.975	*****	-0.9576	-0.8698	-0.8873	-0.3304	*****	*****	*****	*****	*****
-0.200	0.3566	0.3279	0.3402	*****	-0.5713	*****	*****	*****	*****	*****
-0.400	0.3452	0.3360	0.3101	0.1266	-0.6233	*****	*****	*****	*****	*****
-0.600	*****	0.3453	0.3041	0.1585	-0.5984	*****	*****	*****	*****	*****
-0.700	*****	0.3396	0.3084	0.1724	-0.5749	*****	*****	*****	*****	*****
-0.800	0.3849	0.3491	0.3035	0.1965	-0.5022	*****	*****	*****	*****	*****
-0.850	0.3727	0.3387	0.3104	0.1985	-0.4844	*****	*****	*****	*****	*****
-0.900	0.3449	0.3402	0.3068	0.2100	-0.4419	*****	*****	*****	*****	*****
-0.950	*****	*****	0.2567	0.1924	-0.1170	*****	*****	*****	*****	*****
-0.975	*****	0.1723	0.1590	0.1173	-0.0299	*****	*****	*****	*****	*****

Sharp Radius L.E.
 Run No. = 89, Point No. = 1976
 $C_N = 0.751$, $C_m = -0.1277$
 $\alpha = 15.5^\circ$, $M_\infty = 0.871$
 $R_{mac} = 6.0 \times 10^6$

Surface Pressures Near Leading Edge

● / ◆ upper, starboard/port
 ○ / ◇ lower, starboard/port

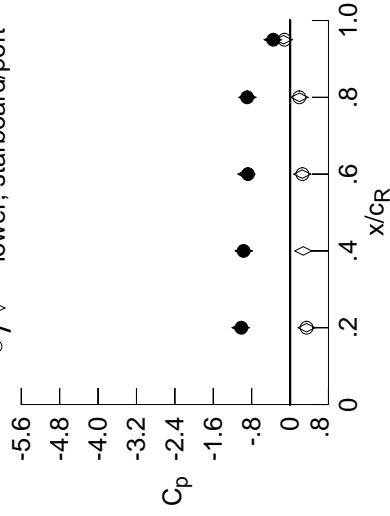

x/c_R	η	starb'd	port	starb'd	port
		$C_{p,u}$	$C_{p,l}$	$C_{p,u}$	$C_{p,l}$
0.20	0.90	-1.0150	-1.0312	0.3427	0.3449
0.40	0.95	-0.9677	-0.9661	0.2753	*****
0.60	0.95	-0.8774	-0.9113	0.2536	0.2567
0.80	0.95	-0.8941	-0.8904	0.1956	0.1924
0.95	0.95	-0.3497	-0.3615	-0.1365	-0.1170

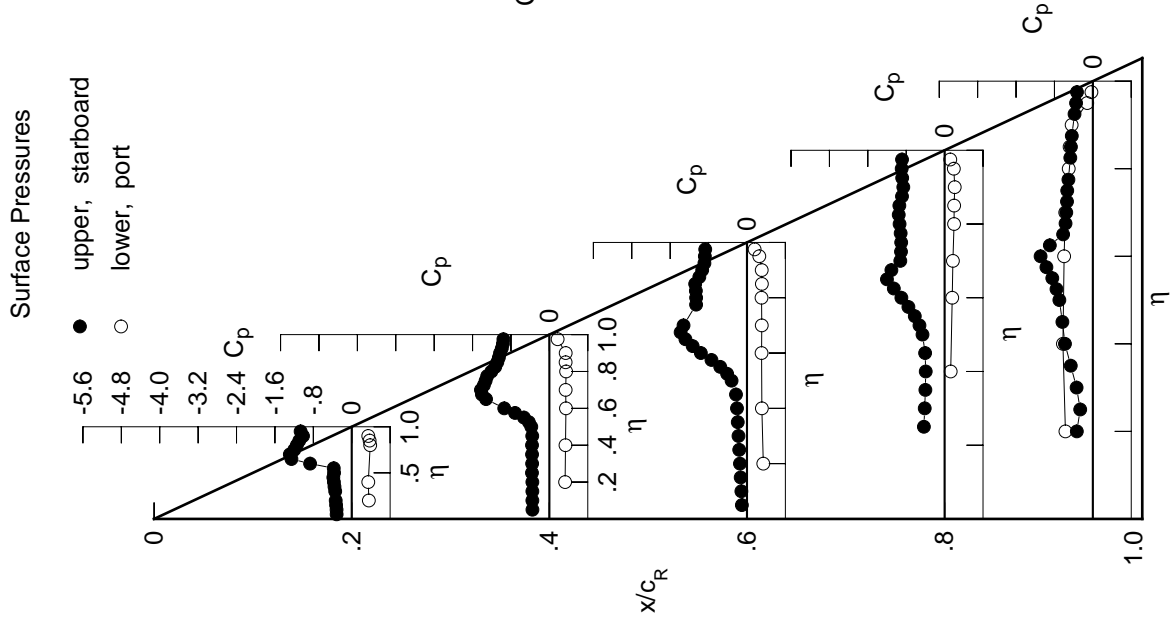

Table D5. Continued.

η	$x/c_R = .2$		$x/c_R = .4$		$x/c_R = .6$		$x/c_R = .8$		$x/c_R = .95$	
	$C_{p,u}$	$C_{p,u}$	$C_{p,u}$	$C_{p,u}$	$C_{p,u}$	$C_{p,u}$	$C_{p,u}$	$C_{p,u}$	$C_{p,u}$	$C_{p,u}$
0.050	-0.3403	-0.3824	-0.1377	*****	*****	*****	*****	*****	*****	*****
0.100	-0.3411	-0.3811	-0.1474	*****	*****	*****	*****	*****	*****	*****
0.150	-0.3541	-0.3841	-0.1651	*****	*****	*****	*****	*****	*****	*****
0.200	-0.3590	-0.3828	-0.1821	*****	*****	*****	*****	*****	*****	*****
0.250	*****	-0.3876	-0.2029	-0.4599	-0.3328	*****	*****	*****	*****	*****
0.300	-0.3676	-0.3853	-0.2217	-0.4457	-0.3860	*****	*****	*****	*****	*****
0.350	-0.3773	-0.3871	-0.2471	-0.4353	-0.4679	*****	*****	*****	*****	*****
0.400	-0.3761	-0.3899	-0.2783	-0.4385	-0.5476	*****	*****	*****	*****	*****
0.450	-0.3676	-0.3973	-0.3287	-0.4705	-0.6049	*****	*****	*****	*****	*****
0.500	-0.3435	-0.4560	-0.4789	-0.5682	-0.6935	*****	*****	*****	*****	*****
0.525	*****	-0.5473	-0.6035	-0.6562	-0.7728	*****	*****	*****	*****	*****
0.550	-0.5005	-0.6947	-0.7644	-0.7710	-0.8783	*****	*****	*****	*****	*****
0.575	*****	-0.9006	-0.9400	-0.9088	-1.0164	*****	*****	*****	*****	*****
0.600	-1.1064	-1.1050	-1.1281	-1.0463	-1.1090	*****	*****	*****	*****	*****
0.625	*****	*****	-1.2656	-1.1825	-0.6863	*****	*****	*****	*****	*****
0.650	-1.3261	-1.4184	-1.3854	-1.3001	-0.6265	*****	*****	*****	*****	*****
0.675	*****	-1.4878	-1.2953	-1.0454	-0.6176	*****	*****	*****	*****	*****
0.700	-1.3927	-1.5152	-1.1285	-0.9918	-0.6159	*****	*****	*****	*****	*****
0.725	*****	-1.4252	*****	-0.9865	-0.6088	*****	*****	*****	*****	*****
0.750	-1.2761	-1.3368	*****	-0.9872	-0.5901	*****	*****	*****	*****	*****
0.775	*****	-1.2748	-1.1115	-1.0009	-0.5361	*****	*****	*****	*****	*****
0.800	-1.2082	-1.1964	-1.1331	-1.0238	*****	*****	*****	*****	*****	*****
0.825	*****	-1.1420	-1.1753	-1.0374	-0.4740	*****	*****	*****	*****	*****
0.850	-1.1197	-1.1124	-1.1616	-1.0269	-0.4525	*****	*****	*****	*****	*****
0.875	*****	-1.0931	-1.0137	-0.9430	-0.4570	*****	*****	*****	*****	*****
0.900	-1.0554	-1.0670	-0.9746	-0.8773	*****	*****	*****	*****	*****	*****
0.925	*****	-1.0212	-0.9621	-0.8862	-0.4198	*****	*****	*****	*****	*****
0.950	-1.0949	-0.9964	-0.9621	-0.8995	-0.3767	*****	*****	*****	*****	*****
0.975	*****	-0.9851	-0.9511	-0.8982	-0.3591	*****	*****	*****	*****	*****
-0.200	0.3860	0.3498	0.3579	*****	-0.5580	*****	*****	*****	*****	*****
-0.400	0.3743	0.3521	0.3279	0.1413	-0.6123	*****	*****	*****	*****	*****
-0.600	*****	0.3661	0.3198	0.1750	-0.5917	*****	*****	*****	*****	*****
-0.700	*****	0.3590	0.3237	0.1853	-0.5637	*****	*****	*****	*****	*****
-0.800	0.4052	0.3687	0.3198	0.2118	-0.4917	*****	*****	*****	*****	*****
-0.850	0.3877	0.3526	0.3245	0.2129	-0.4720	*****	*****	*****	*****	*****
-0.900	0.3560	0.3492	0.3163	0.2210	-0.4263	*****	*****	*****	*****	*****
-0.950	*****	*****	0.2528	0.1926	-0.1161	*****	*****	*****	*****	*****
-0.975	*****	0.1650	0.1452	0.1089	-0.0396	*****	*****	*****	*****	*****

Sharp Radius L.E.
 Run No. = 89, Point No. = 1977
 $C_N = 0.813$, $C_m = -0.1411$
 $\alpha = 16.5^\circ$, $M_\infty = 0.871$
 $R_{mac} = 6.0 \times 10^6$

Surface Pressures Near Leading Edge

● / ◆ upper, starboard/port
 ○ / ◇ lower, starboard/port

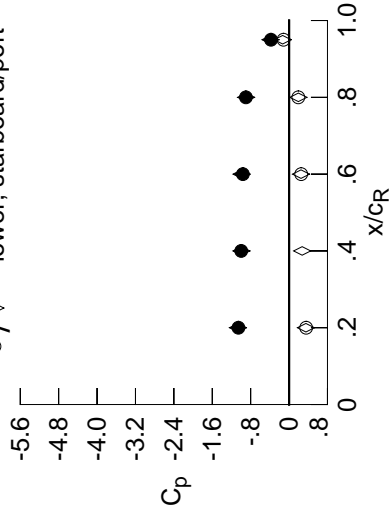

x/c_R	η	starb'd	port	starb'd	port
		$C_{p,u}$	$C_{p,l}$	$C_{p,u}$	$C_{p,l}$
0.20	0.90	-1.0554	-1.0654	0.3515	0.3560
0.40	0.95	-0.9964	-0.9927	0.2727	*****
0.60	0.95	-0.9621	-0.9901	0.2489	0.2528
0.80	0.95	-0.8995	-0.8952	0.1936	0.1926
0.95	0.95	-0.3767	-0.3876	-0.1339	-0.1161

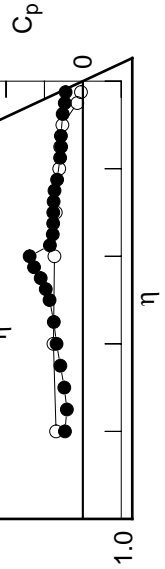

Table D5. Continued.

η	$x/c_R = .2$		$x/c_R = .4$		$x/c_R = .6$		$x/c_R = .8$		$x/c_R = .95$	
	$C_{p,u}$	$C_{p,l}$	$C_{p,u}$	$C_{p,l}$	$C_{p,u}$	$C_{p,l}$	$C_{p,u}$	$C_{p,l}$	$C_{p,u}$	$C_{p,l}$
0.050	-0.3692	-0.4050	-0.2059	*****	*****	*****	*****	*****	*****	*****
0.100	-0.3706	-0.4052	-0.2206	*****	*****	*****	*****	*****	*****	*****
0.150	-0.3800	-0.4048	-0.2420	*****	*****	*****	*****	*****	*****	*****
0.200	-0.3872	-0.4056	-0.2683	*****	*****	*****	*****	*****	*****	*****
0.250	*****	-0.4112	-0.2981	-0.4827	-0.3597	*****	*****	*****	*****	*****
0.300	-0.3969	-0.4089	-0.3291	-0.4670	-0.4062	*****	*****	*****	*****	*****
0.350	-0.4047	-0.4139	-0.3667	-0.4653	-0.4738	*****	*****	*****	*****	*****
0.400	-0.3978	-0.4235	-0.4075	-0.4809	-0.5369	*****	*****	*****	*****	*****
0.450	-0.3818	-0.4570	-0.4844	-0.5401	-0.6017	*****	*****	*****	*****	*****
0.500	-0.3988	-0.5705	-0.6662	-0.6777	-0.7206	*****	*****	*****	*****	*****
0.525	*****	-0.7019	-0.8029	-0.7822	-0.8142	*****	*****	*****	*****	*****
0.550	-0.7828	-0.8744	-0.9579	-0.9110	-0.9338	*****	*****	*****	*****	*****
0.575	*****	-1.0743	-1.1174	-1.0399	-1.0714	*****	*****	*****	*****	*****
0.600	-1.2813	-1.2449	-1.2693	-1.1626	-0.9703	*****	*****	*****	*****	*****
0.625	*****	*****	-1.3796	-1.2783	-0.6954	*****	*****	*****	*****	*****
0.650	-1.3811	-1.5122	-1.3784	-1.3287	-0.6826	*****	*****	*****	*****	*****
0.675	*****	-1.5660	-1.1736	-1.0555	-0.6817	*****	*****	*****	*****	*****
0.700	-1.4156	-1.5351	-1.1520	-1.0404	-0.6846	*****	*****	*****	*****	*****
0.725	*****	-1.3914	*****	-1.0431	-0.6874	*****	*****	*****	*****	*****
0.750	-1.3216	-1.3317	*****	-1.0566	-0.6655	*****	*****	*****	*****	*****
0.775	*****	-1.2793	-1.1658	-1.0676	-0.5895	*****	*****	*****	*****	*****
0.800	-1.2557	-1.2286	-1.2076	-1.0753	*****	*****	*****	*****	*****	*****
0.825	*****	-1.1842	-1.2488	-1.0643	-0.4965	*****	*****	*****	*****	*****
0.850	-1.1506	-1.1578	-1.1852	-1.0494	-0.4621	*****	*****	*****	*****	*****
0.875	*****	-1.1341	-1.0441	-0.9847	-0.4869	*****	*****	*****	*****	*****
0.900	-1.0926	-1.1035	-1.0517	-0.9131	*****	*****	*****	*****	*****	*****
0.925	*****	-1.0603	-1.0607	-0.9109	-0.4583	*****	*****	*****	*****	*****
0.950	-1.1285	-1.0352	-1.0619	-0.9214	-0.4065	*****	*****	*****	*****	*****
0.975	*****	-1.0244	-1.0540	-0.9250	-0.3869	*****	*****	*****	*****	*****
-0.200	0.4139	0.3730	0.3755	*****	*****	*****	*****	*****	*****	*****
-0.400	0.4042	0.3753	0.3462	0.1568	-0.6053	*****	*****	*****	*****	*****
-0.600	*****	0.3884	0.3389	0.1877	-0.5818	*****	*****	*****	*****	*****
-0.700	*****	0.3806	0.3402	0.2035	-0.5556	*****	*****	*****	*****	*****
-0.800	0.4245	0.3876	0.3358	0.2234	-0.4802	*****	*****	*****	*****	*****
-0.850	0.4041	0.3674	0.3378	0.2249	-0.4616	*****	*****	*****	*****	*****
-0.900	0.3646	0.3577	0.3245	0.2282	-0.4144	*****	*****	*****	*****	*****
-0.950	*****	*****	0.2480	0.1916	-0.1172	*****	*****	*****	*****	*****
-0.975	*****	0.1571	0.1320	0.1000	-0.0508	*****	*****	*****	*****	*****

Sharp Radius L.E.
 Run No. = 89 , Point No. = 1978
 $C_N = 0.875$, $C_m = -0.1550$
 $\alpha = 17.5^\circ$, $M_\infty = 0.870$
 $R_{mac} = 6.0 \times 10^6$

Surface Pressures Near Leading Edge

● / ◆ upper, starboard/port
 ○ / ◇ lower, starboard/port

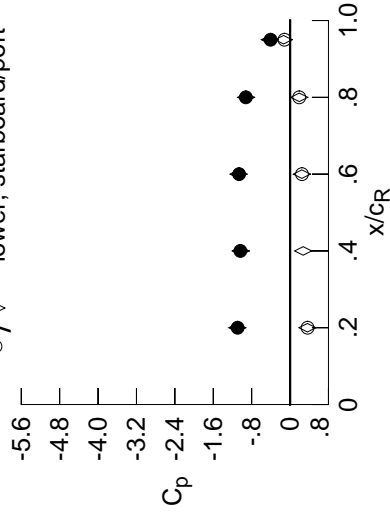

x/c_R	η	starb'd	port	starb'd	port
		$C_{p,u}$	$C_{p,l}$	$C_{p,u}$	$C_{p,l}$
0.20	0.90	-1.0926	-1.1002	0.3616	0.3646
0.40	0.95	-1.0352	-1.0282	0.2730	*****
0.60	0.95	-1.0619	-1.0739	0.2458	0.2480
0.80	0.95	-0.9214	-0.9148	0.1922	0.1916
0.95	0.95	-0.4065	-0.4211	-0.1352	-0.1172

Surface Pressures

● upper, starboard
 ○ lower, port

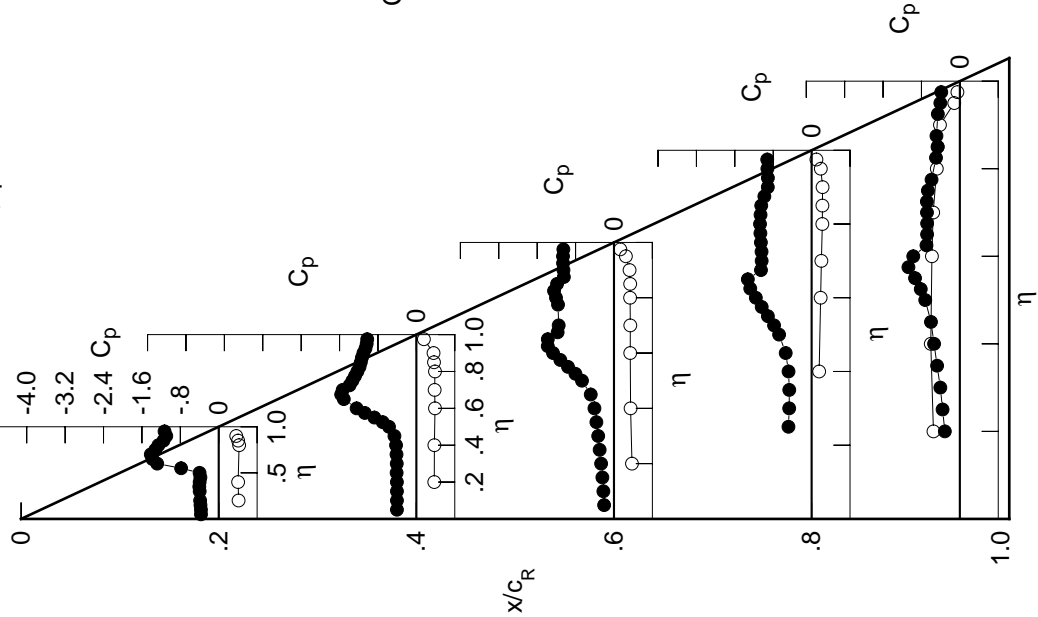

Table D5. Continued.

η	$x/c_R = .2$		$x/c_R = .4$		$x/c_R = .6$		$x/c_R = .8$		$x/c_R = .95$	
	$C_{p,u}$	$C_{p,l}$	$C_{p,u}$	$C_{p,l}$	$C_{p,u}$	$C_{p,l}$	$C_{p,u}$	$C_{p,l}$	$C_{p,u}$	$C_{p,l}$
0.050	-0.4007	-0.4480	-0.3574	*****	*****	*****	*****	*****	*****	*****
0.100	-0.4008	-0.4478	-0.3701	*****	*****	*****	*****	*****	*****	*****
0.150	-0.4115	-0.4492	-0.3962	*****	*****	*****	*****	*****	*****	*****
0.200	-0.4153	-0.4496	-0.4207	*****	*****	*****	*****	*****	*****	*****
0.250	*****	-0.4565	-0.4450	-0.5146	-0.3346	*****	*****	*****	*****	*****
0.300	-0.4236	-0.4555	-0.4653	-0.5037	-0.3756	*****	*****	*****	*****	*****
0.350	-0.4293	-0.4642	-0.4876	-0.5049	-0.4335	*****	*****	*****	*****	*****
0.400	-0.4235	-0.4852	-0.5286	-0.5326	-0.5079	*****	*****	*****	*****	*****
0.450	-0.4281	-0.5517	-0.6214	-0.6197	-0.6037	*****	*****	*****	*****	*****
0.500	-0.5795	-0.7226	-0.8291	-0.7876	-0.7595	*****	*****	*****	*****	*****
0.525	*****	-0.8805	-0.9690	-0.9022	-0.8635	*****	*****	*****	*****	*****
0.550	-1.0633	-1.0509	-1.1115	-1.0220	-0.9866	*****	*****	*****	*****	*****
0.575	*****	-1.2237	-1.2458	-1.1422	-1.0335	*****	*****	*****	*****	*****
0.600	-1.4019	-1.3563	-1.3714	-1.2508	-0.7784	*****	*****	*****	*****	*****
0.625	*****	*****	-1.4576	-1.3491	-0.7283	*****	*****	*****	*****	*****
0.650	-1.4388	-1.5685	-1.2549	-1.3211	-0.7311	*****	*****	*****	*****	*****
0.675	*****	-1.5493	-1.2076	-1.0948	-0.7287	*****	*****	*****	*****	*****
0.700	-1.4181	-1.3988	-1.1986	-1.0851	-0.7285	*****	*****	*****	*****	*****
0.725	*****	-1.3501	*****	-1.0856	-0.7305	*****	*****	*****	*****	*****
0.750	-1.3263	-1.3463	*****	-1.0904	-0.7062	*****	*****	*****	*****	*****
0.775	*****	-1.3417	-1.2237	-1.0787	-0.6186	*****	*****	*****	*****	*****
0.800	-1.2438	-1.3246	-1.2774	-1.0605	*****	*****	*****	*****	*****	*****
0.825	*****	-1.2612	-1.2903	-1.0371	-0.5057	*****	*****	*****	*****	*****
0.850	-1.1745	-1.2034	-1.2138	-1.0275	-0.4677	*****	*****	*****	*****	*****
0.875	*****	-1.1709	-1.0856	-0.9806	-0.4941	*****	*****	*****	*****	*****
0.900	-1.1260	-1.1352	-1.1142	-0.9206	*****	*****	*****	*****	*****	*****
0.925	*****	-1.0978	-1.1254	-0.9235	-0.4675	*****	*****	*****	*****	*****
0.950	-1.1633	-1.0792	-1.1209	-0.9375	-0.4170	*****	*****	*****	*****	*****
0.975	*****	-1.0707	-1.1138	-0.9369	-0.3957	*****	*****	*****	*****	*****
-0.200	0.4415	0.3943	0.3930	*****	-0.5407	*****	*****	*****	*****	*****
-0.400	0.4328	0.3957	0.3643	0.1711	-0.5966	*****	*****	*****	*****	*****
-0.600	*****	0.4068	0.3572	0.2011	-0.5698	*****	*****	*****	*****	*****
-0.700	*****	0.4027	0.3577	0.2152	-0.5428	*****	*****	*****	*****	*****
-0.800	0.4429	0.4045	0.3505	0.2362	-0.4674	*****	*****	*****	*****	*****
-0.850	0.4175	0.3816	0.3496	0.2372	-0.4481	*****	*****	*****	*****	*****
-0.900	0.3740	0.3665	0.3321	0.2351	-0.3987	*****	*****	*****	*****	*****
-0.950	*****	*****	0.2439	0.1887	-0.1147	*****	*****	*****	*****	*****
-0.975	*****	0.1482	0.1218	0.0896	-0.0578	*****	*****	*****	*****	*****

Sharp Radius L.E.
 Run No. = 89, Point No. = 1979
 $C_N = 0.938$, $C_m = -0.1706$
 $\alpha = 18.6^\circ$, $M_\infty = 0.872$
 $R_{mac} = 6.0 \times 10^6$

Surface Pressures Near Leading Edge

● / ◆ upper, starboard/port
 ○ / ◇ lower, starboard/port

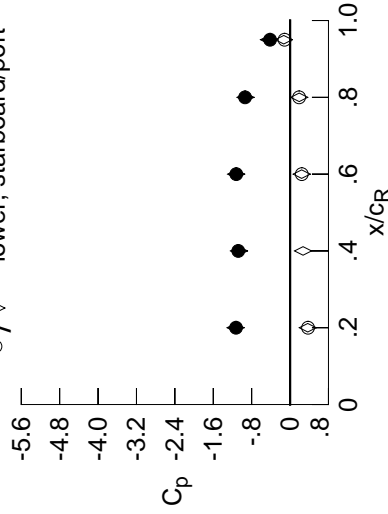

x/c_R	η	starb'd	port	starb'd	port
		$C_{p,u}$	$C_{p,l}$	$C_{p,u}$	$C_{p,l}$
0.20	0.90	-1.1260	-1.1356	0.3685	0.3740
0.40	0.95	-1.0792	-1.0637	0.2704	*****
0.60	0.95	-1.1209	-1.1233	0.2419	0.2439
0.80	0.95	-0.9375	-0.9288	0.1903	0.1887
0.95	0.95	-0.4170	-0.4381	-0.1312	-0.1147

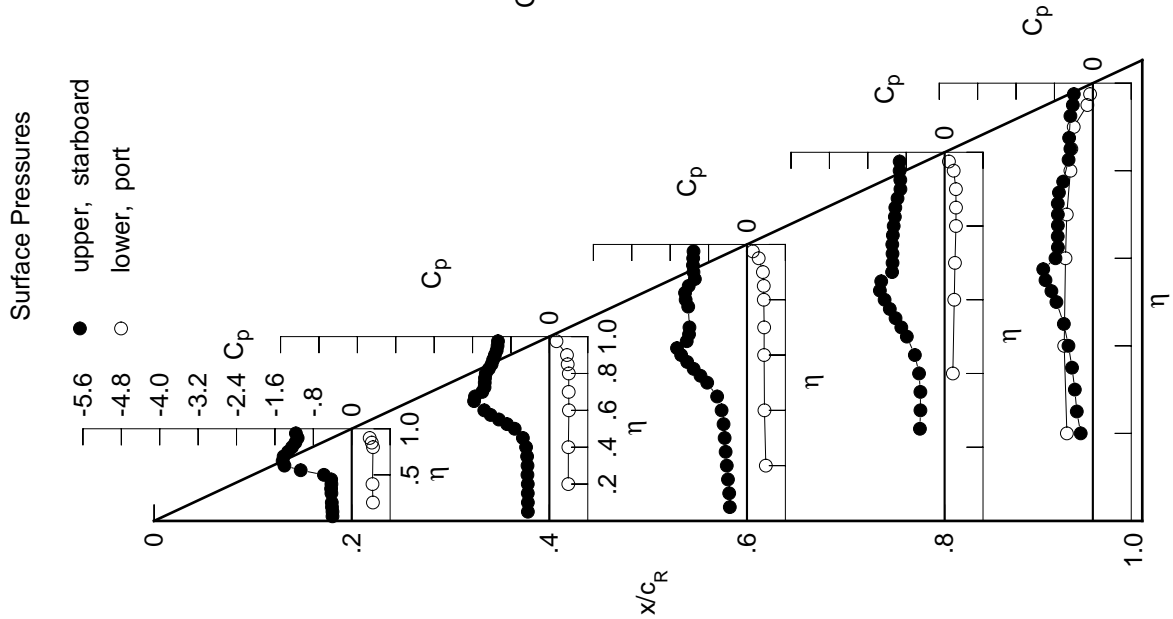

Table D5. Continued.

η	$x/c_R = .2$		$x/c_R = .4$		$x/c_R = .6$		$x/c_R = .8$		$x/c_R = .95$	
	$C_{p,u}$	$C_{p,l}$	$C_{p,u}$	$C_{p,l}$	$C_{p,u}$	$C_{p,l}$	$C_{p,u}$	$C_{p,l}$	$C_{p,u}$	$C_{p,l}$
0.050	-0.4317	-0.4857	-0.4630	*****	*****	*****	*****	*****	*****	*****
0.100	-0.4323	-0.4857	-0.4708	*****	*****	*****	*****	*****	*****	*****
0.150	-0.4412	-0.4880	-0.4816	*****	*****	*****	*****	*****	*****	*****
0.200	-0.4462	-0.4889	-0.4938	*****	*****	*****	*****	*****	*****	*****
0.250	*****	-0.4968	-0.5016	-0.5129	-0.3252	*****	*****	*****	*****	*****
0.300	-0.4535	-0.5015	-0.5181	-0.5148	-0.3838	*****	*****	*****	*****	*****
0.350	-0.4576	-0.5152	-0.5471	-0.5403	-0.4438	*****	*****	*****	*****	*****
0.400	-0.4611	-0.5573	-0.6101	-0.5934	-0.5243	*****	*****	*****	*****	*****
0.450	-0.5237	-0.6646	-0.7369	-0.7096	-0.6431	*****	*****	*****	*****	*****
0.500	-0.8138	-0.8906	-0.9708	-0.8948	-0.8237	*****	*****	*****	*****	*****
0.525	*****	-1.0494	-1.1059	-1.0075	-0.9308	*****	*****	*****	*****	*****
0.550	-1.2483	-1.2033	-1.2316	-1.1223	-1.0506	*****	*****	*****	*****	*****
0.575	*****	-1.3412	-1.3451	-1.2307	-1.0515	*****	*****	*****	*****	*****
0.600	-1.4787	-1.4446	-1.4434	-1.3255	-0.7975	*****	*****	*****	*****	*****
0.625	*****	*****	-1.4734	-1.4100	-0.7690	*****	*****	*****	*****	*****
0.650	-1.4711	-1.5573	-1.2682	-1.3106	-0.7805	*****	*****	*****	*****	*****
0.675	*****	-1.3654	-1.2508	-1.1552	-0.7643	*****	*****	*****	*****	*****
0.700	-1.4079	-1.3262	-1.2468	-1.1397	-0.7557	*****	*****	*****	*****	*****
0.725	*****	-1.3250	*****	-1.1331	-0.7384	*****	*****	*****	*****	*****
0.750	-1.2964	-1.3432	*****	-1.1251	-0.6604	*****	*****	*****	*****	*****
0.775	*****	-1.3715	-1.2641	-1.1066	-0.5673	*****	*****	*****	*****	*****
0.800	-1.2468	-1.3734	-1.3100	-1.0893	*****	*****	*****	*****	*****	*****
0.825	*****	-1.3238	-1.3115	-1.0770	-0.5040	*****	*****	*****	*****	*****
0.850	-1.2034	-1.2702	-1.2479	-1.0775	-0.4798	*****	*****	*****	*****	*****
0.875	*****	-1.2170	-1.1280	-1.0266	-0.5048	*****	*****	*****	*****	*****
0.900	-1.1627	-1.1749	-1.1554	-0.9437	*****	*****	*****	*****	*****	*****
0.925	*****	-1.1463	-1.1617	-0.9367	-0.4831	*****	*****	*****	*****	*****
0.950	-1.2084	-1.1338	-1.1576	-0.9500	-0.4311	*****	*****	*****	*****	*****
0.975	*****	-1.1288	-1.1495	-0.9524	-0.4039	*****	*****	*****	*****	*****
-0.200	0.4706	0.4179	0.4098	*****	-0.5304	*****	*****	*****	*****	*****
-0.400	0.4612	0.4238	0.3822	0.1910	-0.5833	*****	*****	*****	*****	*****
-0.600	*****	0.4308	0.3790	0.2196	-0.5582	*****	*****	*****	*****	*****
-0.700	*****	0.4249	0.3780	0.2317	-0.5322	*****	*****	*****	*****	*****
-0.800	0.4612	0.4229	0.3678	0.2502	-0.4549	*****	*****	*****	*****	*****
-0.850	0.4322	0.3963	0.3651	0.2491	-0.4354	*****	*****	*****	*****	*****
-0.900	0.3825	0.3735	0.3401	0.2450	-0.3838	*****	*****	*****	*****	*****
-0.950	*****	*****	0.2437	0.1885	-0.1102	*****	*****	*****	*****	*****
-0.975	*****	0.1397	0.1120	0.0805	-0.0616	*****	*****	*****	*****	*****

Sharp Radius L.E.
 Run No. = 89, Point No. = 1980
 $C_N = 1.001$, $C_m = -0.1861$
 $\alpha = 19.6^\circ$, $M_\infty = 0.871$
 $R_{mac} = 6.0 \times 10^6$

Surface Pressures Near Leading Edge

● / ◆ upper, starboard/port
 ○ / ◇ lower, starboard/port

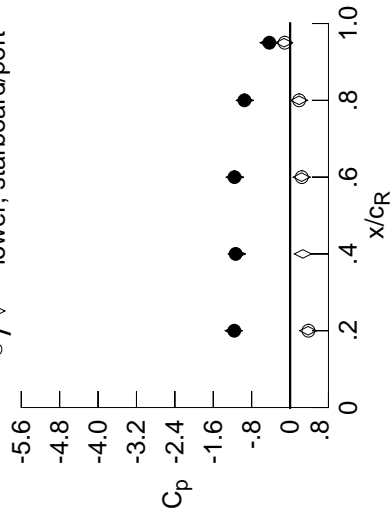

x/c_R	η	starb'd	port	$C_{p,u}$	starb'd	port	$C_{p,l}$
0.20	0.90	-1.1627	-1.1744	0.3762	0.3825	0.2667	*****
0.40	0.95	-1.1338	-1.1106	0.2397	0.2437	0.1884	0.1885
0.60	0.95	-1.1576	-1.1526	-0.4476	-0.1252	-0.1102	0.1885
0.80	0.95	-0.9500	-0.9449	0.1884	0.1885	-0.1102	0.1885
0.95	0.95	-0.4311	-0.4476	-0.1102	-0.1102	0.1885	-0.1102

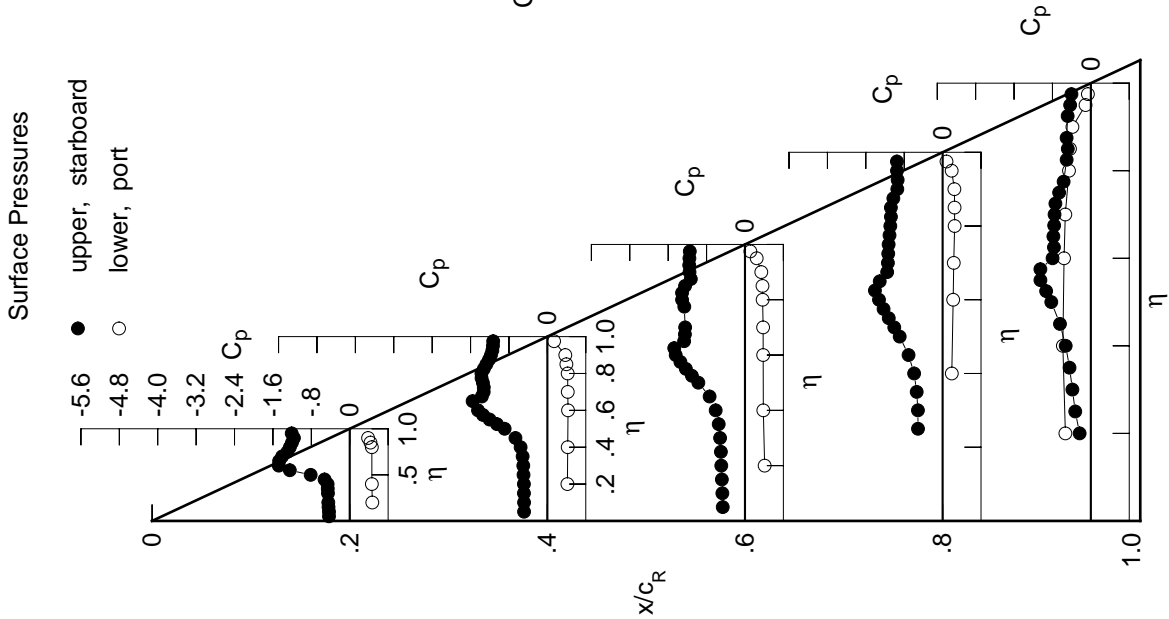

Table D5. Continued.

η	$x/c_R = .2$		$x/c_R = .4$		$x/c_R = .6$		$x/c_R = .8$		$x/c_R = .95$	
	$C_{p,u}$	$C_{p,l}$	$C_{p,u}$	$C_{p,l}$	$C_{p,u}$	$C_{p,l}$	$C_{p,u}$	$C_{p,l}$	$C_{p,u}$	$C_{p,l}$
0.050	-0.4654	-0.5208	-0.5242	*****	*****	*****	*****	*****	*****	*****
0.100	-0.4669	-0.5210	-0.5277	*****	*****	*****	*****	*****	*****	*****
0.150	-0.4770	-0.5250	-0.5328	*****	*****	*****	*****	*****	*****	*****
0.200	-0.4790	-0.5249	-0.5391	*****	*****	*****	*****	*****	*****	*****
0.250	*****	-0.5344	-0.5495	-0.4884	-0.4884	-0.4884	-0.4884	-0.4884	-0.4884	-0.4884
0.300	-0.4895	-0.5433	-0.5685	-0.4992	-0.4992	-0.4992	-0.4992	-0.4992	-0.4992	-0.4992
0.350	-0.5003	-0.5706	-0.6101	-0.5403	-0.5403	-0.5403	-0.5403	-0.5403	-0.5403	-0.5403
0.400	-0.5315	-0.6448	-0.7008	-0.6211	-0.6211	-0.6211	-0.6211	-0.6211	-0.6211	-0.6211
0.450	-0.6727	-0.8050	-0.8682	-0.7674	-0.7674	-0.7674	-0.7674	-0.7674	-0.7674	-0.7674
0.500	-1.0219	-1.0576	-1.1080	-0.9677	-0.9677	-0.9677	-0.9677	-0.9677	-0.9677	-0.9677
0.525	*****	-1.2042	-1.2293	-1.0813	-1.0813	-1.0813	-1.0813	-1.0813	-1.0813	-1.0813
0.550	-1.3663	-1.3270	-1.3329	-1.1893	-1.1893	-1.1893	-1.1893	-1.1893	-1.1893	-1.1893
0.575	*****	-1.4283	-1.4230	-1.2888	-1.2888	-1.2888	-1.2888	-1.2888	-1.2888	-1.2888
0.600	-1.4405	-1.5015	-1.5022	-1.3726	-1.3726	-1.3726	-1.3726	-1.3726	-1.3726	-1.3726
0.625	*****	*****	-1.4373	-1.4518	-1.4518	-1.4518	-1.4518	-1.4518	-1.4518	-1.4518
0.650	-1.4281	-1.3861	-1.3025	-1.2486	-1.2486	-1.2486	-1.2486	-1.2486	-1.2486	-1.2486
0.675	*****	-1.3095	-1.2942	-1.1804	-1.1804	-1.1804	-1.1804	-1.1804	-1.1804	-1.1804
0.700	-1.3627	-1.3043	-1.2904	-1.1659	-1.1659	-1.1659	-1.1659	-1.1659	-1.1659	-1.1659
0.725	*****	-1.2987	*****	-1.1592	-1.1592	-1.1592	-1.1592	-1.1592	-1.1592	-1.1592
0.750	-1.3308	-1.3115	*****	-1.1452	-1.1452	-1.1452	-1.1452	-1.1452	-1.1452	-1.1452
0.775	*****	-1.3355	-1.3023	-1.1356	-1.1356	-1.1356	-1.1356	-1.1356	-1.1356	-1.1356
0.800	-1.2911	-1.3491	-1.3389	-1.1390	-1.1390	-1.1390	-1.1390	-1.1390	-1.1390	-1.1390
0.825	*****	-1.3218	-1.3402	-1.1507	-1.1507	-1.1507	-1.1507	-1.1507	-1.1507	-1.1507
0.850	-1.2381	-1.2742	-1.2872	-1.1683	-1.1683	-1.1683	-1.1683	-1.1683	-1.1683	-1.1683
0.875	*****	-1.2332	-1.1613	-1.0951	-1.0951	-1.0951	-1.0951	-1.0951	-1.0951	-1.0951
0.900	-1.2022	-1.2218	-1.1872	-0.9739	-0.9739	-0.9739	-0.9739	-0.9739	-0.9739	-0.9739
0.925	*****	-1.2119	-1.1931	-0.9394	-0.9394	-0.9394	-0.9394	-0.9394	-0.9394	-0.9394
0.950	-1.2527	-1.2099	-1.1909	-0.9390	-0.9390	-0.9390	-0.9390	-0.9390	-0.9390	-0.9390
0.975	*****	-1.2060	-1.1856	-0.9336	-0.9336	-0.9336	-0.9336	-0.9336	-0.9336	-0.9336
-0.200	$C_{p,l}$	0.5040	0.4406	0.4303	*****	*****	*****	*****	*****	*****
-0.400	$C_{p,l}$	0.4903	0.4491	0.4016	0.2116	0.2116	0.2116	0.2116	0.2116	0.2116
-0.600	*****	0.4556	0.3982	0.2372	0.2372	0.2372	0.2372	0.2372	0.2372	0.2372
-0.700	*****	0.4483	0.3962	0.2494	0.2494	0.2494	0.2494	0.2494	0.2494	0.2494
-0.800	$C_{p,l}$	0.4807	0.4424	0.3853	0.2666	0.2666	0.2666	0.2666	0.2666	0.2666
-0.850	$C_{p,l}$	0.4471	0.4093	0.3762	0.2625	0.2625	0.2625	0.2625	0.2625	0.2625
-0.900	$C_{p,l}$	0.3920	0.3830	0.3452	0.2546	0.2546	0.2546	0.2546	0.2546	0.2546
-0.950	*****	*****	0.2418	0.1887	0.1887	0.1887	0.1887	0.1887	0.1887	0.1887
-0.975	*****	0.1339	0.1060	0.0740	0.0740	0.0740	0.0740	0.0740	0.0740	0.0740

Sharp Radius L.E.

Run No. = 89, Point No. = 1981

$C_N = 1.048$, $C_m = -0.1904$

$\alpha = 20.6^\circ$, $M_\infty = 0.871$

$R_{mac} = 6.0 \times 10^6$

Surface Pressures Near Leading Edge

● / ◆ upper, starboard/port
○ / ◇ lower, starboard/port

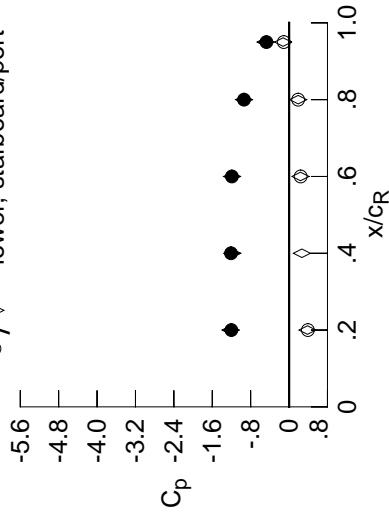

x/c_R	η	$C_{p,u}$ starb'd	$C_{p,u}$ port	$C_{p,l}$ starb'd	$C_{p,l}$ port
0.20	0.90	-1.2022	-1.2191	0.3843	0.3920
0.40	0.95	-1.2099	-1.1839	0.2669	*****
0.60	0.95	-1.1909	-1.1882	0.2373	0.2418
0.80	0.95	-0.9390	-0.9387	0.1892	0.1887
0.95	0.95	-0.4718	-0.4901	-0.1249	-0.1105

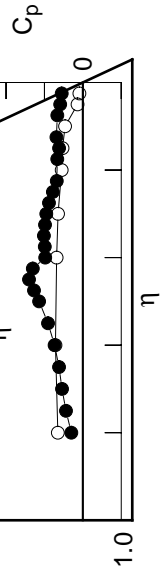

Table D5. Continued.

η	x/c_R .2	$C_{p,u}$	x/c_R .4	$C_{p,u}$	x/c_R .6	$C_{p,u}$	x/c_R .8	$C_{p,u}$	x/c_R .95	$C_{p,u}$
0.050		-0.5008	-0.5494	-0.5600	-0.5600	-0.5600	-0.5600	-0.5600	-0.5095	-0.5095
0.100		-0.5049	-0.5500	-0.5616	-0.5616	-0.5616	-0.5616	-0.5616	-0.5572	-0.5572
0.150		-0.5133	-0.5524	-0.5672	-0.5672	-0.5672	-0.5672	-0.5672	-0.5339	-0.5339
0.200		-0.5178	-0.5549	-0.5736	-0.5736	-0.5736	-0.5736	-0.5736	-0.5056	-0.5056
0.250		*****	-0.5659	-0.5872	-0.5088	-0.5088	-0.5088	-0.5088	-0.4250	-0.4250
0.300		-0.5340	-0.5833	-0.6168	-0.5339	-0.5339	-0.5339	-0.5339	-0.4100	-0.4100
0.350		-0.5595	-0.6293	-0.6768	-0.5892	-0.5892	-0.5892	-0.5892	-0.3586	-0.3586
0.400		-0.6273	-0.7398	-0.7935	-0.6864	-0.6864	-0.6864	-0.6864	-0.1103	-0.1103
0.450		-0.8290	-0.9392	-0.9708	-0.8416	-0.8416	-0.8416	-0.8416	0.0816	0.0816
0.500		-1.1692	-1.1868	-1.1964	-1.0426	-1.0426	-1.0426	-1.0426	0.0651	0.0651
0.525		*****	-1.3092	-1.3044	-1.1495	-1.0732	-1.0732	-1.0732	0.0651	0.0651
0.550		-1.4312	-1.4063	-1.3966	-1.2499	-1.2499	-1.2499	-1.2499	0.0651	0.0651
0.575		*****	-1.4887	-1.4754	-1.3428	-0.9649	-0.9649	-0.9649	0.0651	0.0651
0.600		-1.3966	-1.5426	-1.5452	-1.4179	-1.4179	-1.4179	-1.4179	0.0651	0.0651
0.625		*****	-1.4267	-1.4267	-1.4770	-0.8165	-0.8165	-0.8165	0.0651	0.0651
0.650		-1.4018	-1.3824	-1.3403	-1.2374	-1.2374	-1.2374	-1.2374	0.0651	0.0651
0.675		*****	-1.3451	-1.3310	-1.2101	-0.8165	-0.8165	-0.8165	0.0651	0.0651
0.700		-1.3830	-1.3301	-1.3246	-1.2106	-1.2106	-1.2106	-1.2106	0.0651	0.0651
0.725		*****	-1.3228	*****	-1.1970	-0.7810	-0.7810	-0.7810	0.0651	0.0651
0.750		-1.3956	-1.3338	*****	-1.1826	-0.7178	-0.7178	-0.7178	0.0651	0.0651
0.775		*****	-1.3619	-1.3307	-1.1745	-0.6247	-0.6247	-0.6247	0.0651	0.0651
0.800		-1.3529	-1.3820	-1.3817	-1.1855	*****	*****	*****	0.0651	0.0651
0.825		*****	-1.3505	-1.3912	-1.2113	-0.5363	-0.5363	-0.5363	0.0651	0.0651
0.850		-1.2786	-1.2996	-1.3233	-1.2365	-0.5070	-0.5070	-0.5070	0.0651	0.0651
0.875		*****	-1.2622	-1.1791	-1.1415	-0.5776	-0.5776	-0.5776	0.0651	0.0651
0.900		-1.2454	-1.2521	-1.2083	-1.0040	*****	*****	*****	0.0651	0.0651
0.925		*****	-1.2496	-1.2205	-0.9673	-0.5755	-0.5755	-0.5755	0.0651	0.0651
0.950		-1.2970	-1.2508	-1.2218	-0.9650	-0.4926	-0.4926	-0.4926	0.0651	0.0651
0.975		*****	-1.2503	-1.2170	-0.9553	-0.4659	-0.4659	-0.4659	0.0651	0.0651
-0.200		$C_{p,l}$	0.4655	0.4478	*****	-0.5095	-0.5095	-0.5095	0.0651	0.0651
-0.400		0.5192	0.4719	0.4241	0.2224	-0.5572	-0.5572	-0.5572	0.0651	0.0651
-0.600		*****	0.4796	0.4140	0.2543	-0.5339	-0.5339	-0.5339	0.0651	0.0651
-0.700		*****	0.4697	0.4156	0.2622	-0.5056	-0.5056	-0.5056	0.0651	0.0651
-0.800		0.4957	0.4600	0.3979	0.2810	-0.4250	-0.4250	-0.4250	0.0651	0.0651
-0.850		0.4591	0.4211	0.3866	0.2745	-0.4100	-0.4100	-0.4100	0.0651	0.0651
-0.900		0.3985	0.3896	0.3517	0.2620	-0.3586	-0.3586	-0.3586	0.0651	0.0651
-0.950		*****	*****	0.2350	0.1855	-0.1103	-0.1103	-0.1103	0.0651	0.0651
-0.975		*****	0.1255	0.0957	0.0651	-0.0816	-0.0816	-0.0816	0.0651	0.0651

Sharp Radius L.E.
 Run No. = 89 , Point No. = 1982
 $C_N = 1.101$, $C_m = -0.1994$
 $\alpha = 21.6^\circ$, $M_\infty = 0.870$
 $R_{mac} = 6.0 \times 10^6$

Surface Pressures Near Leading Edge

● / ◆ upper, starboard/port
 ○ / ◇ lower, starboard/port

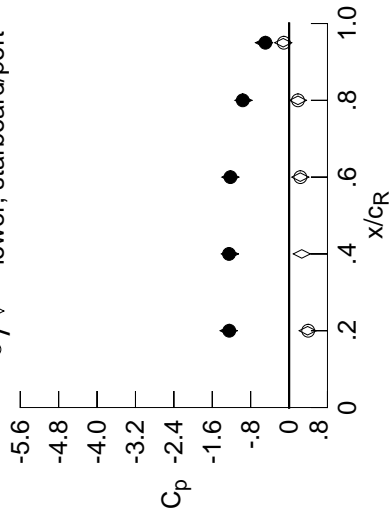

x/c_R	η	starb'd	port	$C_{p,u}$	starb'd	port	$C_{p,l}$
0.20	0.90	-1.2454	-1.2604	0.3874	0.3985	0.3874	0.3985
0.40	0.95	-1.2508	-1.2331	0.2646	0.2646	0.2646	0.2646
0.60	0.95	-1.2218	-1.2241	0.2336	0.2350	0.2336	0.2350
0.80	0.95	-0.9650	-0.9516	0.1858	0.1855	0.1858	0.1855
0.95	0.95	-0.4926	-0.5227	-0.1222	-0.1103	-0.1222	-0.1103

Surface Pressures

● upper, starboard
 ○ lower, port

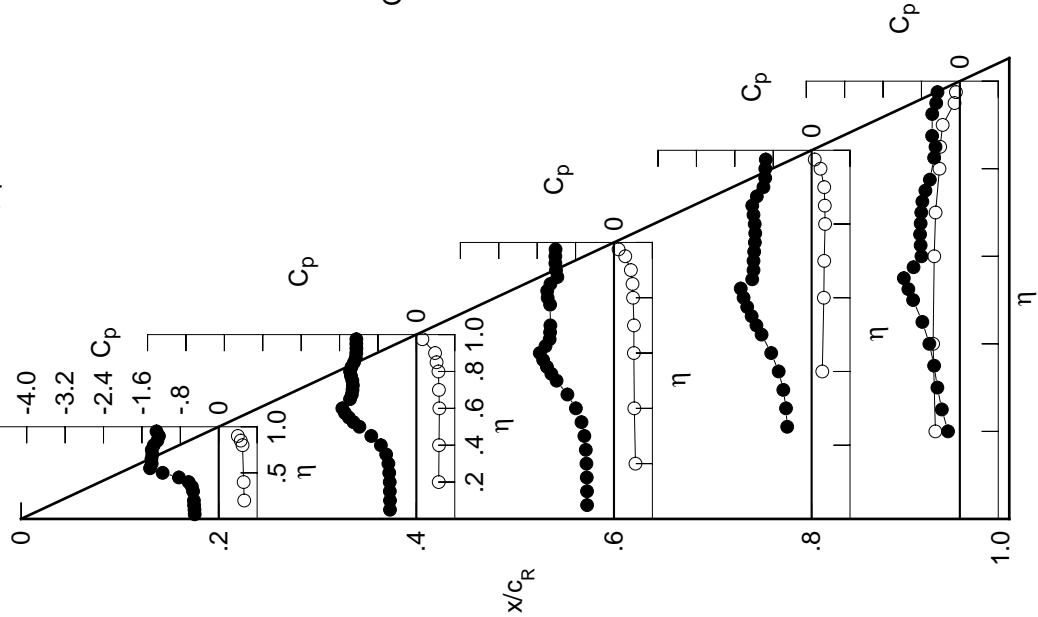

Table D5. Continued.

η	x/c_R .2	$C_{p,u}$	x/c_R .4	$C_{p,u}$	x/c_R .6	$C_{p,u}$	x/c_R .8	$C_{p,u}$	x/c_R .95	$C_{p,u}$
0.050		-0.5372		-0.5806		-0.5950		-0.5950		-0.5950
0.100		-0.5391		-0.5806		-0.5986		-0.5986		-0.5986
0.150		-0.5510		-0.5809		-0.6058		-0.6058		-0.6058
0.200		-0.5568		-0.5862		-0.6156		-0.6156		-0.6156
0.250		-0.6045		-0.6345		-0.5089		-0.5089		-0.5089
0.300		-0.5807		-0.6335		-0.6735		-0.5556		-0.5217
0.350		-0.6296		-0.6982		-0.7473		-0.6385		-0.6021
0.400		-0.7342		-0.8341		-0.8760		-0.7599		-0.7187
0.450		-0.9649		-1.0437		-1.0584		-0.9299		-0.8807
0.500		-1.2708		-1.2685		-1.2659		-1.1274		-1.0729
0.525		-1.3699		-1.3699		-1.3583		-1.2258		-1.1673
0.550		-1.4270		-1.4537		-1.4406		-1.3168		-1.1796
0.575		-1.5263		-1.5096		-1.4002		-1.4002		-0.8496
0.600		-1.4016		-1.5664		-1.5704		-1.4640		-0.7933
0.625		-1.4286		-1.4286		-1.4470		-0.8049		-0.8049
0.650		-1.4054		-1.3931		-1.3710		-1.2422		-0.8082
0.675		-1.3801		-1.3619		-1.2184		-0.7897		-0.7897
0.700		-1.4104		-1.3582		-1.3539		-1.2004		-0.7697
0.725		-1.3552		-1.3552		-1.1741		-0.7115		-0.7115
0.750		-1.4544		-1.3662		-1.1510		-0.6390		-0.6390
0.775		-1.3966		-1.3966		-1.3633		-1.1372		-0.5667
0.800		-1.3901		-1.4198		-1.4218		-1.1431		-0.5667
0.825		-1.3832		-1.4308		-1.1703		-0.5642		-0.5642
0.850		-1.3092		-1.3239		-1.3562		-1.2391		-0.5321
0.875		-1.2844		-1.2844		-1.2004		-1.1635		-0.6276
0.900		-1.2821		-1.2777		-1.2357		-1.0098		-0.6620
0.925		-1.2780		-1.2780		-1.2502		-0.9533		-0.6620
0.950		-1.3284		-1.2769		-1.2533		-0.9454		-0.5608
0.975		-1.2794		-1.2794		-1.2474		-0.9422		-0.5388
-0.200		0.5552		0.4883		0.4652		0.4652		-0.4974
-0.400		0.5461		0.4926		0.4399		0.2395		-0.5454
-0.600		0.5000		0.5000		0.4305		0.2665		-0.5210
-0.700		0.4881		0.4881		0.4317		0.2772		-0.4932
-0.800		0.5101		0.4752		0.4125		0.2906		-0.4171
-0.850		0.4694		0.4302		0.3982		0.2846		-0.3986
-0.900		0.4054		0.3941		0.3568		0.2680		-0.3485
-0.950		0.2313		0.2313		0.1841		0.1841		-0.1152
-0.975		0.1202		0.1202		0.0858		0.0567		-0.0974

Sharp Radius L.E.
 Run No. = 89 , Point No. = 1983
 $C_N = 1.143$, $C_m = -0.2027$
 $\alpha = 22.6^\circ$, $M_\infty = 0.871$
 $R_{mac} = 6.0 \times 10^6$

Surface Pressures Near Leading Edge

● / ◆ upper, starboard/port
 ○ / ◇ lower, starboard/port

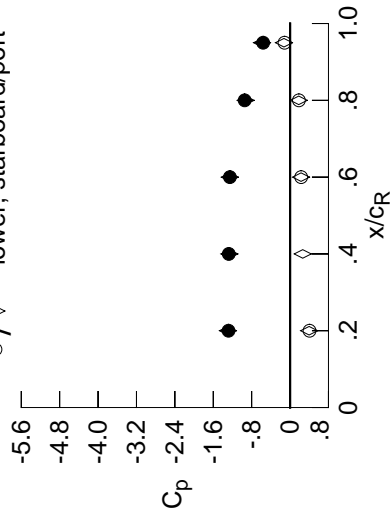

x/c_R	η	starb'd	port	starb'd	port
0.20	0.90	-1.2821	-1.2940	0.3965	0.4054
0.40	0.95	-1.2769	-1.2657	0.2637	0.2637
0.60	0.95	-1.2533	-1.2562	0.2288	0.2313
0.80	0.95	-0.9454	-0.9257	0.1805	0.1841
0.95	0.95	-0.5608	-0.5838	-0.1274	-0.1152

Surface Pressures

● upper, starboard
 ○ lower, port

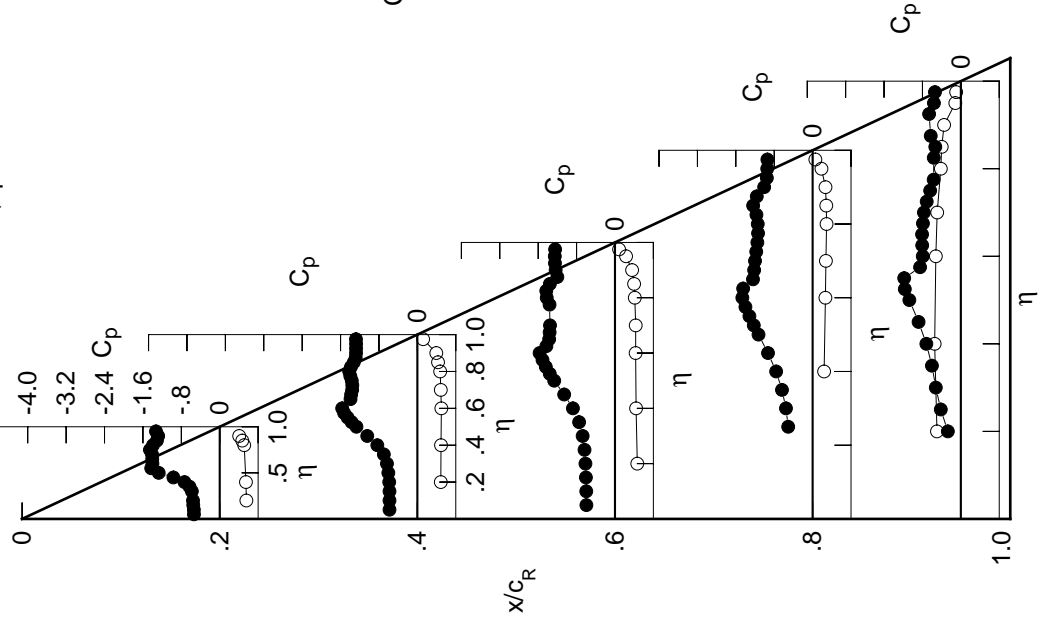

Table D5. Continued.

η	x/c_R .2	$C_{p,u}$	x/c_R .4	$C_{p,u}$	x/c_R .6	$C_{p,u}$	x/c_R .8	$C_{p,u}$	x/c_R .95	$C_{p,u}$
0.050		-0.5716	-0.6129	-0.6300	-0.6300	*****	*****	*****	*****	*****
0.100		-0.5763	-0.6127	-0.6347	-0.6347	*****	*****	*****	*****	*****
0.150		-0.5871	-0.6166	-0.6421	-0.6421	*****	*****	*****	*****	*****
0.200		-0.5964	-0.6243	-0.6564	-0.6564	*****	*****	*****	*****	*****
0.250		*****	-0.6507	-0.6785	-0.4789	-0.4589	*****	*****	-0.2914	*****
0.300		-0.6340	-0.6875	-0.7266	-0.5543	-0.5726	*****	*****	*****	*****
0.350		-0.7036	-0.7707	-0.8136	-0.6617	-0.6618	*****	*****	*****	*****
0.400		-0.8400	-0.9239	-0.9494	-0.8041	-0.7834	*****	*****	*****	*****
0.450		-1.0776	-1.1307	-1.1322	-0.9878	-0.9475	*****	*****	*****	*****
0.500		-1.3469	-1.3293	-1.3210	-1.1856	-1.1362	*****	*****	*****	*****
0.525		*****	-1.4200	-1.4079	-1.2773	-1.0263	*****	*****	*****	*****
0.550		-1.4343	-1.4953	-1.4780	-1.3634	-0.7487	*****	*****	*****	*****
0.575		*****	-1.5552	-1.5410	-1.4345	-0.7251	*****	*****	*****	*****
0.600		-1.4217	-1.5783	-1.5909	-1.4575	-0.7260	*****	*****	*****	*****
0.625		*****	*****	-1.4376	-1.2148	-0.7245	*****	*****	*****	*****
0.650		-1.4253	-1.4221	-1.3996	-1.1561	-0.7002	*****	*****	*****	*****
0.675		*****	-1.4087	-1.3932	-1.1398	-0.6566	*****	*****	*****	*****
0.700		-1.4370	-1.3892	-1.3852	-1.1152	-0.6188	*****	*****	*****	*****
0.725		*****	-1.3876	*****	-1.0898	-0.5871	*****	*****	*****	*****
0.750		-1.5017	-1.3991	*****	-1.0774	-0.5842	*****	*****	*****	*****
0.775		*****	-1.4285	-1.3970	-1.0713	-0.5886	*****	*****	*****	*****
0.800		-1.4022	-1.4502	-1.4538	-1.0635	*****	*****	*****	*****	*****
0.825		*****	-1.4094	-1.4701	-1.0521	-0.6269	*****	*****	*****	*****
0.850		-1.3333	-1.3530	-1.3955	-1.0954	-0.5761	*****	*****	*****	*****
0.875		*****	-1.3124	-1.2346	-1.0376	-0.6410	*****	*****	*****	*****
0.900		-1.3126	-1.3048	-1.2653	-0.9074	*****	*****	*****	*****	*****
0.925		*****	-1.3059	-1.2805	-0.8652	-0.6771	*****	*****	*****	*****
0.950		-1.3534	-1.3102	-1.2849	-0.8653	-0.5995	*****	*****	*****	*****
0.975		*****	-1.3122	-1.2808	-0.8305	-0.5856	*****	*****	*****	*****
-0.200		$C_{p,l}$	$C_{p,l}$	$C_{p,l}$	$C_{p,l}$	$C_{p,l}$	$C_{p,l}$	$C_{p,l}$	$C_{p,l}$	$C_{p,l}$
-0.400		0.5863	0.5133	0.4842	*****	-0.4834	*****	*****	*****	*****
-0.600		0.5750	0.5172	0.4594	0.2559	-0.5323	*****	*****	*****	*****
-0.700		*****	0.5234	0.4495	0.2856	-0.5078	*****	*****	*****	*****
-0.800		*****	0.5103	0.4497	0.2922	-0.4778	*****	*****	*****	*****
-0.850		0.5271	0.4923	0.4290	0.3064	-0.4036	*****	*****	*****	*****
-0.900		0.4839	0.4424	0.4111	0.2991	-0.3870	*****	*****	*****	*****
-0.950		0.4137	0.4018	0.3642	0.2783	-0.3388	*****	*****	*****	*****
-0.975		*****	*****	0.2309	0.1873	-0.1170	*****	*****	*****	*****
		*****	0.1098	0.0809	0.0574	-0.1093	*****	*****	*****	*****

Sharp Radius L.E.

Run No. = 89 , Point No. = 1984

$C_N = 1.116$, $C_m = -0.1895$

$\alpha = 23.7^\circ$, $M_\infty = 0.871$

$R_{mac} = 6.0 \times 10^6$

Surface Pressures Near Leading Edge

● / ◆ upper, starboard/port
○ / ◇ lower, starboard/port

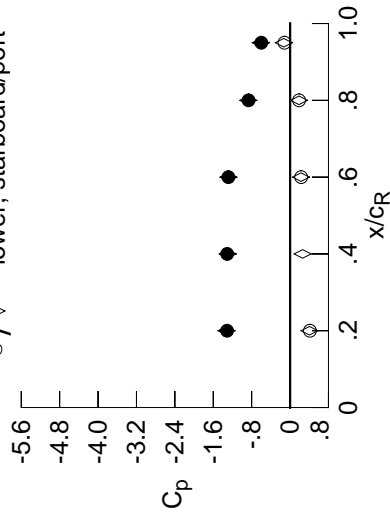

x/c_R	η	starb'd	port	starb'd	port
0.20	0.90	-1.3126	-1.3246	0.4041	0.4137
0.40	0.95	-1.3102	-1.2993	0.2614	*****
0.60	0.95	-1.2849	-1.2853	0.2266	0.2309
0.80	0.95	-0.8653	-0.8715	0.1853	0.1873
0.95	0.95	-0.5995	-0.6114	-0.1310	-0.1170

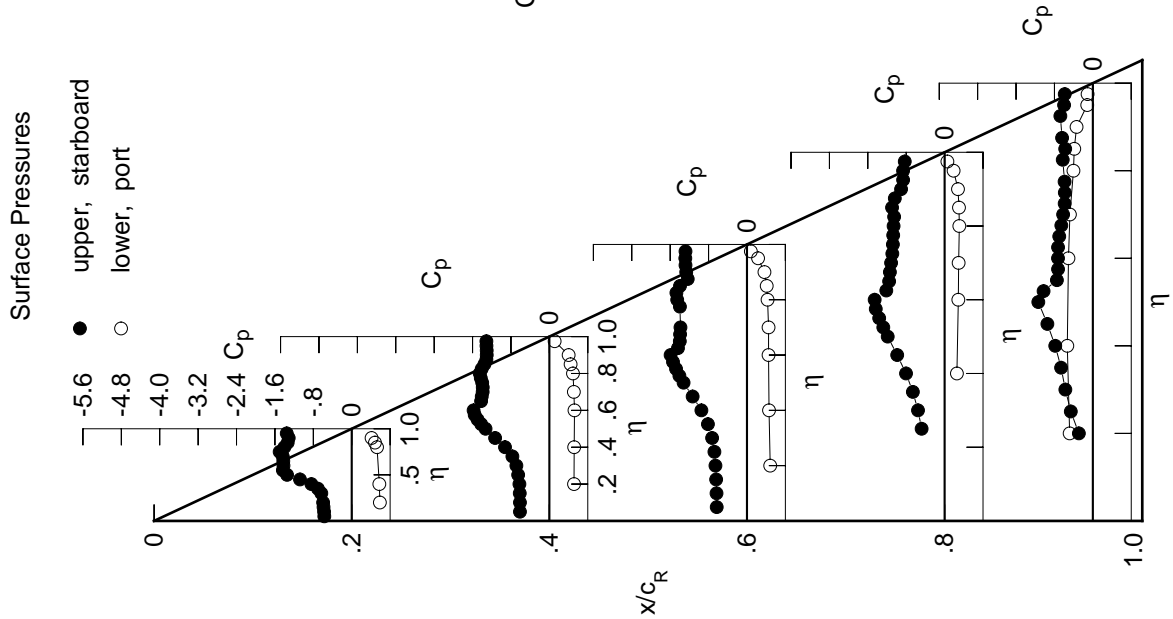

Table D5. Continued.

η	$x/c_R = .2$		$x/c_R = .4$		$x/c_R = .6$		$x/c_R = .8$		$x/c_R = .95$	
	$C_{p,u}$	$C_{p,l}$	$C_{p,u}$	$C_{p,l}$	$C_{p,u}$	$C_{p,l}$	$C_{p,u}$	$C_{p,l}$	$C_{p,u}$	$C_{p,l}$
0.050	-0.6070	-0.6398	-0.0127	*****	*****	*****	*****	*****	*****	*****
0.100	-0.6104	-0.6436	-0.0255	*****	*****	*****	*****	*****	*****	*****
0.150	-0.6216	-0.6493	-0.0464	*****	*****	*****	*****	*****	*****	*****
0.200	-0.6355	-0.6583	-0.0768	*****	*****	*****	*****	*****	*****	-0.6947
0.250	*****	-0.6886	-0.1225	-0.6651	-0.7284	*****	*****	*****	*****	-0.7284
0.300	-0.6876	-0.7381	-0.2049	-0.6751	-0.7663	*****	*****	*****	*****	-0.7663
0.350	-0.7766	-0.8304	-0.3329	-0.7312	-0.7896	*****	*****	*****	*****	-0.7896
0.400	-0.9300	-0.9871	-0.5291	-0.7553	-0.8221	*****	*****	*****	*****	-0.8221
0.450	-1.1633	-1.1830	-0.7600	-0.7959	-0.8231	*****	*****	*****	*****	-0.8231
0.500	-1.4024	-1.3678	-1.0277	-0.8283	-0.7929	*****	*****	*****	*****	-0.7929
0.525	*****	-1.4527	-1.1398	-0.8430	-0.7901	*****	*****	*****	*****	-0.7901
0.550	-1.5384	-1.5186	-1.2128	-0.8500	-0.7706	*****	*****	*****	*****	-0.7706
0.575	*****	-1.5761	-1.2506	-0.8512	-0.7794	*****	*****	*****	*****	-0.7794
0.600	-1.4565	-1.5819	-1.2049	-0.8532	-0.7695	*****	*****	*****	*****	-0.7695
0.625	*****	*****	-1.0959	-0.8527	-0.7712	*****	*****	*****	*****	-0.7712
0.650	-1.4297	-1.4457	-1.0226	-0.8545	-0.7673	*****	*****	*****	*****	-0.7673
0.675	*****	-1.4312	-0.9890	-0.8535	-0.7541	*****	*****	*****	*****	-0.7541
0.700	-1.4186	-1.4083	-0.9657	-0.8438	-0.7498	*****	*****	*****	*****	-0.7498
0.725	*****	-1.4048	*****	-0.8351	-0.7392	*****	*****	*****	*****	-0.7392
0.750	-1.4640	-1.4138	*****	-0.8122	-0.7300	*****	*****	*****	*****	-0.7300
0.775	*****	-1.4468	-0.9157	-0.8017	-0.7115	*****	*****	*****	*****	-0.7115
0.800	-1.4053	-1.4760	-0.9022	-0.7829	*****	*****	*****	*****	*****	*****
0.825	*****	-1.4390	-0.8832	-0.7717	-0.6803	*****	*****	*****	*****	-0.6803
0.850	-1.3533	-1.3751	-0.8652	-0.7656	-0.6397	*****	*****	*****	*****	-0.6397
0.875	*****	-1.3334	-0.7939	-0.7533	-0.6544	*****	*****	*****	*****	-0.6544
0.900	-1.3363	-1.3288	-0.7832	-0.7266	*****	*****	*****	*****	*****	*****
0.925	*****	-1.3296	-0.7674	-0.7206	-0.6240	*****	*****	*****	*****	-0.6240
0.950	-1.3706	-1.3321	-0.7547	-0.7085	-0.5778	*****	*****	*****	*****	-0.5778
0.975	*****	-1.3326	-0.7471	-0.6768	-0.5407	*****	*****	*****	*****	-0.5407
-0.200	0.6134	0.5394	0.5052	*****	-0.4970	*****	*****	*****	*****	-0.4970
-0.400	0.6023	0.5425	0.4805	0.2664	-0.5429	*****	*****	*****	*****	-0.5429
-0.600	*****	0.5472	0.4721	0.2915	-0.5165	*****	*****	*****	*****	-0.5165
-0.700	*****	0.5328	0.4731	0.3039	-0.4904	*****	*****	*****	*****	-0.4904
-0.800	0.5438	0.5097	0.4550	0.3154	-0.4175	*****	*****	*****	*****	-0.4175
-0.850	0.4970	0.4550	0.4362	0.3082	-0.4025	*****	*****	*****	*****	-0.4025
-0.900	0.4220	0.4114	0.3909	0.2902	-0.3528	*****	*****	*****	*****	-0.3528
-0.950	*****	*****	0.2636	0.2091	-0.1261	*****	*****	*****	*****	-0.1261
-0.975	*****	0.1190	0.1230	0.0923	-0.1110	*****	*****	*****	*****	-0.1110

Sharp Radius L.E.
 Run No. = 89 , Point No. = 1985
 $C_N = 1.084$, $C_m = -0.1754$
 $\alpha = 24.6^\circ$, $M_\infty = 0.870$
 $R_{mac} = 6.0 \times 10^6$

Surface Pressures Near Leading Edge

● / ◆ upper, starboard/port
 ○ / ◇ lower, starboard/port

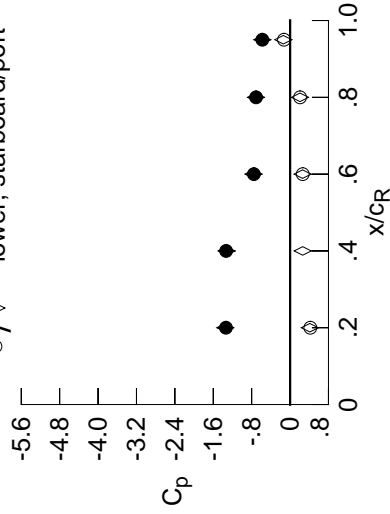

x/c_R	η	starb'd	port	starb'd	port
		$C_{p,u}$	$C_{p,l}$	$C_{p,u}$	$C_{p,l}$
0.20	0.90	-1.3363	-1.3505	0.4122	0.4220
0.40	0.95	-1.3321	-1.3232	0.2633	*****
0.60	0.95	-0.7547	-0.7631	0.2604	0.2636
0.80	0.95	-0.7085	-0.7115	0.2072	0.2091
0.95	0.95	-0.5778	-0.5795	-0.1407	-0.1261

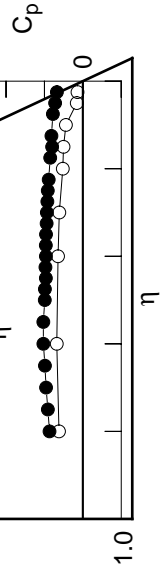

Table D5. Continued.

η	$x/c_R = .2$		$x/c_R = .4$		$x/c_R = .6$		$x/c_R = .8$		$x/c_R = .95$	
	$C_{p,u}$	$C_{p,u}$	$C_{p,u}$	$C_{p,u}$	$C_{p,u}$	$C_{p,u}$	$C_{p,u}$	$C_{p,u}$	$C_{p,u}$	$C_{p,u}$
0.050	-0.6448	-0.6662	-0.0247	*****	*****	*****	*****	*****	*****	*****
0.100	-0.6492	-0.6676	-0.0368	*****	*****	*****	*****	*****	*****	*****
0.150	-0.6639	-0.6797	-0.0565	*****	*****	*****	*****	*****	*****	*****
0.200	-0.6767	-0.6945	-0.0914	*****	*****	*****	*****	*****	*****	*****
0.250	*****	-0.7350	-0.1435	-0.8295	-0.7607	*****	*****	*****	*****	*****
0.300	-0.7506	-0.7971	-0.2329	-0.8317	-0.8175	*****	*****	*****	*****	*****
0.350	-0.8555	-0.9024	-0.3722	-0.8600	-0.8411	*****	*****	*****	*****	*****
0.400	-1.0185	-1.0634	-0.5705	-0.8515	-0.8478	*****	*****	*****	*****	*****
0.450	-1.2403	-1.2489	-0.7960	-0.8486	-0.8182	*****	*****	*****	*****	*****
0.500	-1.4526	-1.4137	-1.0432	-0.8496	-0.7806	*****	*****	*****	*****	*****
0.525	*****	-1.4870	-1.1422	-0.8572	-0.7845	*****	*****	*****	*****	*****
0.550	-1.5453	-1.5444	-1.1928	-0.8650	-0.7718	*****	*****	*****	*****	*****
0.575	*****	-1.5957	-1.2012	-0.8732	-0.7863	*****	*****	*****	*****	*****
0.600	-1.4588	-1.5983	-1.1476	-0.8830	-0.7790	*****	*****	*****	*****	*****
0.625	*****	*****	-1.0527	-0.8819	-0.7827	*****	*****	*****	*****	*****
0.650	-1.4532	-1.4713	-0.9897	-0.8826	-0.7824	*****	*****	*****	*****	*****
0.675	*****	-1.4567	-0.9630	-0.8821	-0.7720	*****	*****	*****	*****	*****
0.700	-1.4679	-1.4340	-0.9506	-0.8815	-0.7670	*****	*****	*****	*****	*****
0.725	*****	-1.4346	*****	-0.8751	-0.7541	*****	*****	*****	*****	*****
0.750	-1.5211	-1.4453	*****	-0.8539	-0.7483	*****	*****	*****	*****	*****
0.775	*****	-1.4762	-0.9045	-0.8413	-0.7265	*****	*****	*****	*****	*****
0.800	-1.4316	-1.5060	-0.8975	-0.8236	*****	*****	*****	*****	*****	*****
0.825	*****	-1.4670	-0.8788	-0.8173	-0.6929	*****	*****	*****	*****	*****
0.850	-1.3713	-1.4019	-0.8694	-0.8133	-0.6684	*****	*****	*****	*****	*****
0.875	*****	-1.3575	-0.8171	-0.7960	-0.6673	*****	*****	*****	*****	*****
0.900	-1.3534	-1.3539	-0.8189	-0.7697	*****	*****	*****	*****	*****	*****
0.925	*****	-1.3576	-0.8045	-0.7640	-0.6336	*****	*****	*****	*****	*****
0.950	-1.3908	-1.3586	-0.7984	-0.7519	-0.5901	*****	*****	*****	*****	*****
0.975	*****	-1.3583	-0.7936	-0.7129	-0.5550	*****	*****	*****	*****	*****
-0.200	*****	*****	*****	*****	*****	*****	*****	*****	*****	*****
-0.400	0.6405	0.5621	0.5232	*****	-0.4815	*****	*****	*****	*****	*****
-0.600	0.6276	0.5668	0.4969	0.2848	-0.5260	*****	*****	*****	*****	*****
-0.800	*****	0.5682	0.4905	0.3079	-0.5036	*****	*****	*****	*****	*****
-0.900	*****	0.5515	0.4867	0.3156	-0.4747	*****	*****	*****	*****	*****
-0.950	0.5585	0.5240	0.4672	0.3277	-0.4015	*****	*****	*****	*****	*****
-0.975	0.5074	0.4655	0.4474	0.3193	-0.3870	*****	*****	*****	*****	*****
-0.990	0.4288	0.4166	0.3937	0.2957	-0.3379	*****	*****	*****	*****	*****
-0.995	*****	*****	0.2585	0.2054	-0.1226	*****	*****	*****	*****	*****
-0.997	*****	0.1064	0.1113	0.0814	-0.1152	*****	*****	*****	*****	*****

Sharp Radius L.E.

Run No. = 89 , Point No. = 1986

$C_N = 1.122$, $C_m = -0.1784$

$\alpha = 25.6^\circ$, $M_\infty = 0.871$

$R_{mac} = 6.0 \times 10^6$

Surface Pressures Near Leading Edge

● / ◆ upper, starboard/port
○ / ◇ lower, starboard/port

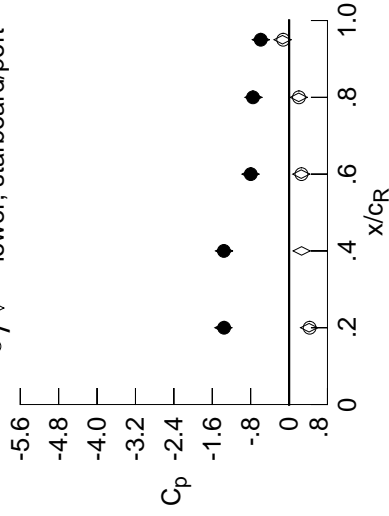

x/c_R	η	starb'd	port	starb'd	port
		$C_{p,u}$	$C_{p,u}$	$C_{p,l}$	$C_{p,l}$
0.20	0.90	-1.3534	-1.3698	0.4166	0.4288
0.40	0.95	-1.3586	-1.3552	0.2607	*****
0.60	0.95	-0.7984	-0.8048	0.2539	0.2585
0.80	0.95	-0.7519	-0.7430	0.2015	0.2054
0.95	0.95	-0.5901	-0.5893	-0.1367	-0.1226

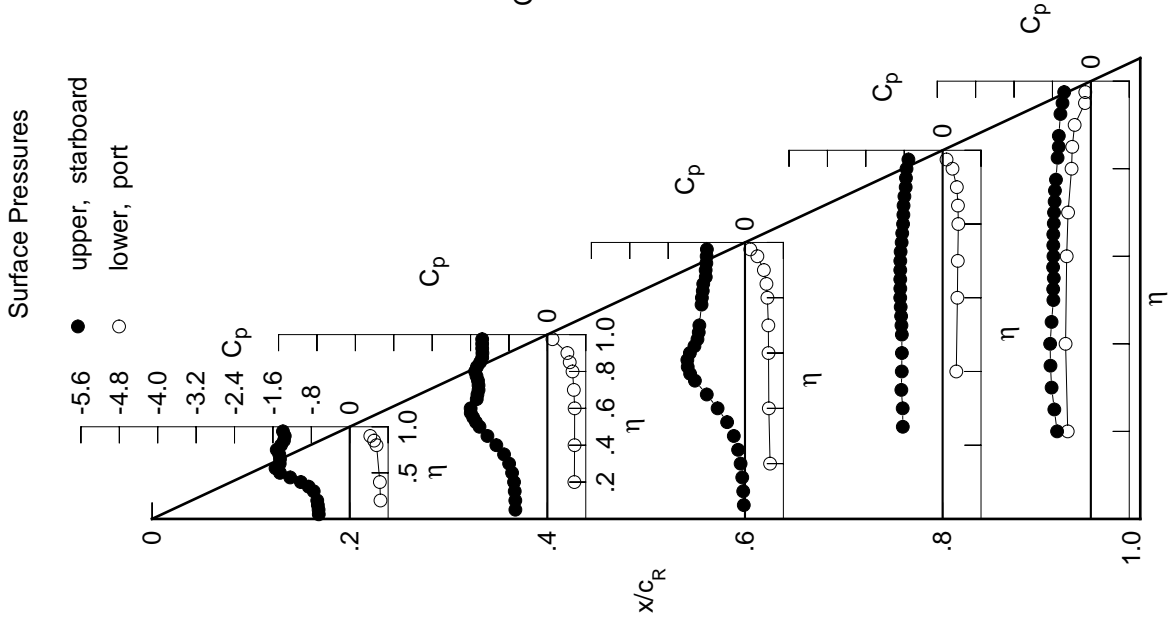

Table D5. Continued.

η	$x/c_R = .2$		$x/c_R = .4$		$x/c_R = .6$		$x/c_R = .8$		$x/c_R = .95$	
	$C_{p,u}$	$C_{p,l}$	$C_{p,u}$	$C_{p,l}$	$C_{p,u}$	$C_{p,l}$	$C_{p,u}$	$C_{p,l}$	$C_{p,u}$	$C_{p,l}$
0.050	-0.6844	-0.7006	-0.1358	*****	*****	*****	*****	*****	*****	*****
0.100	-0.6906	-0.7041	-0.1422	*****	*****	*****	*****	*****	*****	*****
0.150	-0.7090	-0.7169	-0.1524	*****	*****	*****	*****	*****	*****	*****
0.200	-0.7240	-0.7340	-0.1786	*****	*****	*****	*****	*****	*****	*****
0.250	*****	-0.7854	-0.2208	-0.9459	-0.8591	*****	*****	*****	*****	*****
0.300	-0.8148	-0.8557	-0.3018	-0.9120	-0.9080	*****	*****	*****	*****	*****
0.350	-0.9346	-0.9701	-0.4284	-0.8881	-0.8840	*****	*****	*****	*****	*****
0.400	-1.1010	-1.1283	-0.6083	-0.8363	-0.8318	*****	*****	*****	*****	*****
0.450	-1.3061	-1.3014	-0.8066	-0.8159	-0.7874	*****	*****	*****	*****	*****
0.500	-1.4923	-1.4493	-1.0226	-0.8285	-0.7659	*****	*****	*****	*****	*****
0.525	*****	-1.5154	-1.1119	-0.8473	-0.7749	*****	*****	*****	*****	*****
0.550	-1.5541	-1.5691	-1.1569	-0.8723	-0.7732	*****	*****	*****	*****	*****
0.575	*****	-1.6133	-1.1674	-0.8937	-0.7906	*****	*****	*****	*****	*****
0.600	-1.4794	-1.6133	-1.1019	-0.9100	-0.7903	*****	*****	*****	*****	*****
0.625	*****	*****	-0.9877	-0.9049	-0.7934	*****	*****	*****	*****	*****
0.650	-1.4748	-1.4966	-0.9344	-0.9034	-0.7920	*****	*****	*****	*****	*****
0.675	*****	-1.4776	-0.9248	-0.9069	-0.7801	*****	*****	*****	*****	*****
0.700	-1.4921	-1.4505	-0.9303	-0.9035	-0.7771	*****	*****	*****	*****	*****
0.725	*****	-1.4529	*****	-0.8979	-0.7673	*****	*****	*****	*****	*****
0.750	-1.5529	-1.4608	*****	-0.8806	-0.7628	*****	*****	*****	*****	*****
0.775	*****	-1.4952	-0.8956	-0.8747	-0.7412	*****	*****	*****	*****	*****
0.800	-1.4440	-1.5269	-0.8861	-0.8630	*****	*****	*****	*****	*****	*****
0.825	*****	-1.4875	-0.8661	-0.8574	-0.7054	*****	*****	*****	*****	*****
0.850	-1.3834	-1.4219	-0.8576	-0.8539	-0.6823	*****	*****	*****	*****	*****
0.875	*****	-1.3772	-0.8186	-0.8415	-0.6729	*****	*****	*****	*****	*****
0.900	-1.3733	-1.3758	-0.8320	-0.8130	*****	*****	*****	*****	*****	*****
0.925	*****	-1.3827	-0.8246	-0.8062	-0.6399	*****	*****	*****	*****	*****
0.950	-1.4100	-1.3848	-0.8115	-0.7963	-0.6014	*****	*****	*****	*****	*****
0.975	*****	-1.3823	-0.8065	-0.7613	-0.5682	*****	*****	*****	*****	*****

η	$x/c_R = .2$		$x/c_R = .4$		$x/c_R = .6$		$x/c_R = .8$		$x/c_R = .95$	
	$C_{p,u}$	$C_{p,l}$	$C_{p,u}$	$C_{p,l}$	$C_{p,u}$	$C_{p,l}$	$C_{p,u}$	$C_{p,l}$	$C_{p,u}$	$C_{p,l}$
-0.200	0.6668	0.5860	0.5426	*****	*****	*****	*****	*****	*****	*****
-0.400	0.6545	0.5887	0.5178	0.2996	-0.5124	*****	*****	*****	*****	*****
-0.600	*****	0.5891	0.5066	0.3241	-0.4884	*****	*****	*****	*****	*****
-0.700	*****	0.5716	0.5047	0.3308	-0.4591	*****	*****	*****	*****	*****
-0.800	0.5723	0.5397	0.4800	0.3414	-0.3892	*****	*****	*****	*****	*****
-0.850	0.5185	0.4780	0.4582	0.3289	-0.3740	*****	*****	*****	*****	*****
-0.900	0.4352	0.4230	0.3992	0.3007	-0.3236	*****	*****	*****	*****	*****
-0.950	*****	*****	0.2566	0.2004	-0.1181	*****	*****	*****	*****	*****
-0.975	*****	0.1066	0.1042	0.0680	-0.1191	*****	*****	*****	*****	*****

Sharp Radius L.E.
 Run No. = 89 , Point No. = 1987
 $C_N = 1.159$, $C_m = -0.1829$
 $\alpha = 26.7^\circ$, $M_\infty = 0.872$
 $R_{mac} = 6.0 \times 10^6$

Surface Pressures Near Leading Edge

● / ◆ upper, starboard/port
 ○ / ◇ lower, starboard/port

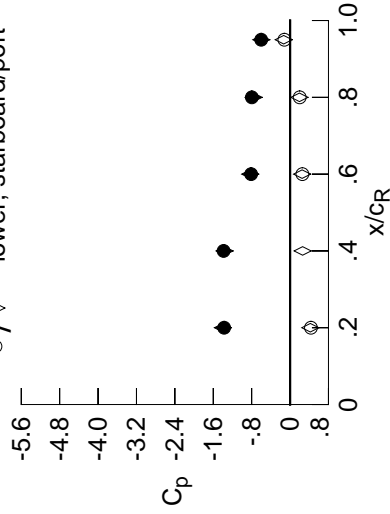

x/c_R	η	starb'd	port	starb'd	port
		$C_{p,u}$	$C_{p,l}$	$C_{p,u}$	$C_{p,l}$
0.20	0.90	-1.3733	-1.3994	0.4219	0.4352
0.40	0.95	-1.3848	-1.3651	0.2614	*****
0.60	0.95	-0.8115	-0.8307	0.2514	0.2566
0.80	0.95	-0.7963	-0.7596	0.1951	0.2004
0.95	0.95	-0.6014	-0.5992	-0.1332	-0.1181

Table D5. Concluded.

η	$x/c_R = .2$		$x/c_R = .4$		$x/c_R = .6$		$x/c_R = .8$		$x/c_R = .95$	
	$C_{p,u}$	$C_{p,l}$	$C_{p,u}$	$C_{p,l}$	$C_{p,u}$	$C_{p,l}$	$C_{p,u}$	$C_{p,l}$	$C_{p,u}$	$C_{p,l}$
0.050	-0.0090	-0.0004	0.1329	0.1329	0.1329	0.1329	0.1329	0.1329	0.1329	0.1329
0.100	-0.0053	0.0006	0.1222	0.1222	0.1222	0.1222	0.1222	0.1222	0.1222	0.1222
0.150	-0.0097	0.0016	0.1093	0.1093	0.1093	0.1093	0.1093	0.1093	0.1093	0.1093
0.200	-0.0169	-0.0010	0.0968	0.0968	0.0968	0.0968	0.0968	0.0968	0.0968	0.0968
0.250	*****	-0.0018	0.0850	-0.1359	0.0850	-0.1359	0.0850	-0.1359	0.0850	-0.1359
0.300	-0.0385	-0.0003	0.0728	-0.1188	0.0728	-0.1188	0.0728	-0.1188	0.0728	-0.1188
0.350	-0.0482	-0.0007	0.0620	-0.1103	0.0620	-0.1103	0.0620	-0.1103	0.0620	-0.1103
0.400	-0.0583	-0.0056	0.0527	-0.0998	0.0527	-0.0998	0.0527	-0.0998	0.0527	-0.0998
0.450	-0.0668	-0.0045	0.0512	-0.0957	0.0512	-0.0957	0.0512	-0.0957	0.0512	-0.0957
0.500	-0.0705	-0.0135	0.0348	-0.0849	0.0348	-0.0849	0.0348	-0.0849	0.0348	-0.0849
0.525	*****	-0.0117	0.0316	-0.0848	0.0316	-0.0848	0.0316	-0.0848	0.0316	-0.0848
0.550	-0.0717	-0.0171	0.0296	-0.0798	0.0296	-0.0798	0.0296	-0.0798	0.0296	-0.0798
0.575	*****	-0.0216	0.0307	-0.0793	0.0307	-0.0793	0.0307	-0.0793	0.0307	-0.0793
0.600	-0.0546	-0.0227	0.0217	-0.0800	0.0217	-0.0800	0.0217	-0.0800	0.0217	-0.0800
0.625	*****	*****	0.0208	-0.0766	0.0208	-0.0766	0.0208	-0.0766	0.0208	-0.0766
0.650	-0.0455	-0.0244	0.0136	-0.0764	0.0136	-0.0764	0.0136	-0.0764	0.0136	-0.0764
0.675	*****	-0.0370	0.0088	-0.0773	0.0088	-0.0773	0.0088	-0.0773	0.0088	-0.0773
0.700	-0.0374	-0.0579	0.0056	-0.0783	0.0056	-0.0783	0.0056	-0.0783	0.0056	-0.0783
0.725	*****	-0.0723	*****	-0.0765	*****	-0.0765	*****	-0.0765	*****	-0.0765
0.750	-0.0216	-0.0776	*****	-0.0815	*****	-0.0815	*****	-0.0815	*****	-0.0815
0.775	*****	-0.0829	-0.0154	-0.0846	-0.0829	-0.0154	-0.0846	-0.0829	-0.0154	-0.0846
0.800	-0.0043	-0.0822	-0.0405	-0.0870	-0.0043	-0.0822	-0.0405	-0.0870	-0.0043	-0.0822
0.825	*****	-0.0741	-0.0632	-0.0895	-0.0741	-0.0632	-0.0895	-0.0741	-0.0632	-0.0895
0.850	0.0224	-0.0624	-0.0605	-0.1168	0.0224	-0.0624	-0.0605	-0.1168	0.0224	-0.0624
0.875	*****	-0.0477	-0.0607	-0.1403	*****	-0.0477	-0.0607	-0.1403	*****	-0.0477
0.900	0.0621	-0.0256	-0.0480	-0.1349	0.0621	-0.0256	-0.0480	-0.1349	0.0621	-0.0256
0.925	*****	0.0086	-0.0268	-0.1019	*****	0.0086	-0.0268	-0.1019	*****	0.0086
0.950	0.1076	0.0503	0.0145	-0.0709	0.1076	0.0503	0.0145	-0.0709	0.1076	0.0503
0.975	*****	0.1013	0.0777	0.0055	*****	0.1013	0.0777	0.0055	*****	0.1013
-0.200	-0.0373	-0.0017	0.0923	0.0923	-0.0373	-0.0017	0.0923	0.0923	-0.0373	-0.0017
-0.400	-0.0564	-0.0044	0.0474	-0.1021	-0.0564	-0.0044	0.0474	-0.1021	-0.0564	-0.0044
-0.600	*****	-0.0170	0.0180	-0.0861	*****	-0.0170	0.0180	-0.0861	*****	-0.0170
-0.700	*****	-0.0530	-0.0021	-0.0826	*****	-0.0530	-0.0021	-0.0826	*****	-0.0530
-0.800	-0.0237	-0.0841	-0.0526	-0.0879	-0.0237	-0.0841	-0.0526	-0.0879	-0.0237	-0.0841
-0.850	0.0085	-0.0677	-0.0735	-0.1289	0.0085	-0.0677	-0.0735	-0.1289	0.0085	-0.0677
-0.900	0.0461	-0.0353	-0.0726	-0.1506	0.0461	-0.0353	-0.0726	-0.1506	0.0461	-0.0353
-0.950	*****	*****	-0.0007	-0.0971	*****	*****	-0.0007	-0.0971	*****	*****
-0.975	*****	0.0888	0.0538	-0.0228	*****	0.0888	0.0538	-0.0228	*****	0.0888

Sharp Radius L.E.

Run No. = 89 , Point No. = 1988

$C_N = -0.024$, $C_m = 0.0102$

$\alpha = 0.0^\circ$, $M_\infty = 0.871$

$R_{mac} = 6.0 \times 10^6$

Surface Pressures Near Leading Edge

● / ◆ upper, starboard/port
○ / ◇ lower, starboard/port

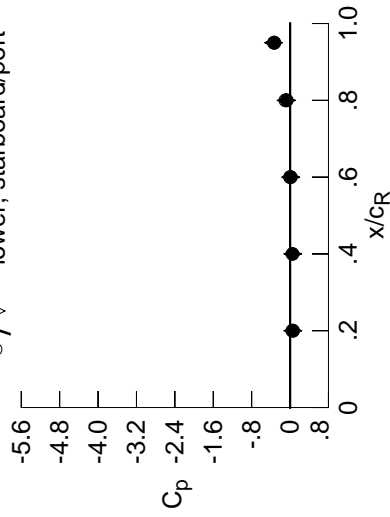

x/c_R	η	starb'd	port	starb'd	port
		$C_{p,u}$	$C_{p,l}$	$C_{p,u}$	$C_{p,l}$
0.20	0.90	0.0621	0.0630	0.0505	0.0461
0.40	0.95	0.0503	0.0568	0.0495	*****
0.60	0.95	0.0145	0.0193	0.0036	-0.0007
0.80	0.95	-0.0709	-0.0660	-0.0895	-0.0971
0.95	0.95	-0.3272	-0.3429	-0.3508	-0.3358

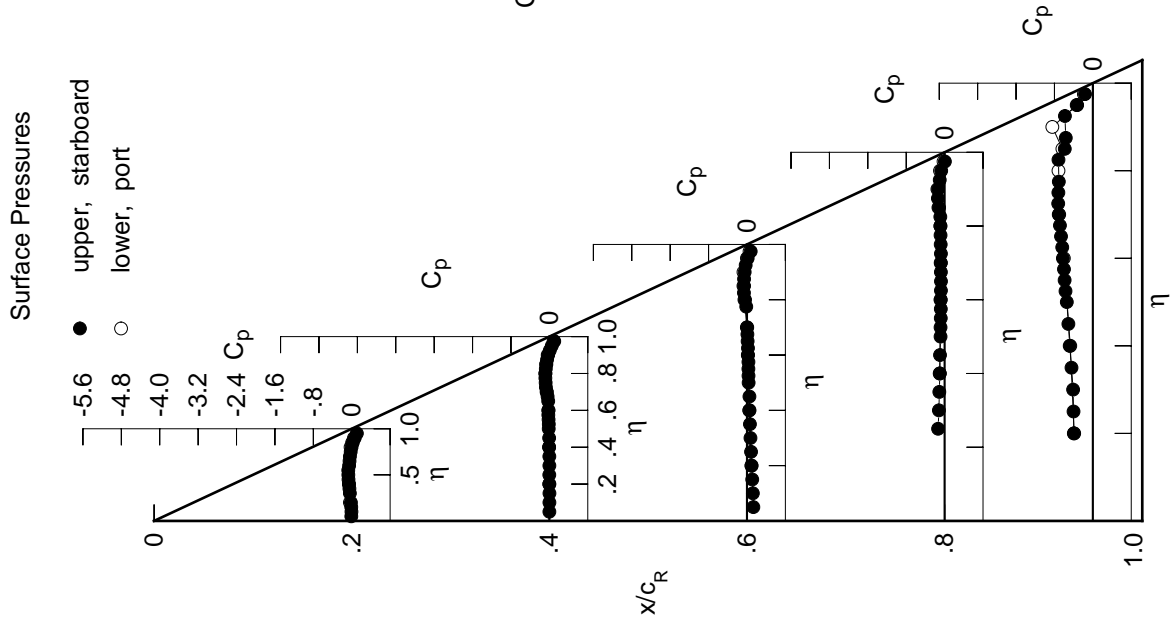

Table D6. Tabulations and Plots of Surface Pressure Coefficients.

η	$x/c_R = .2$		$x/c_R = .4$		$x/c_R = .6$		$x/c_R = .8$		$x/c_R = .95$	
	$C_{p,u}$	$C_{p,l}$	$C_{p,u}$	$C_{p,l}$	$C_{p,u}$	$C_{p,l}$	$C_{p,u}$	$C_{p,l}$	$C_{p,u}$	$C_{p,l}$
0.050	-0.0006	0.0098	0.0098	0.1482	0.1482	0.1482	0.1482	0.1482	0.1482	0.1482
0.100	0.0044	0.0101	0.0101	0.1362	0.1362	0.1362	0.1362	0.1362	0.1362	0.1362
0.150	0.0036	0.0087	0.0087	0.1238	0.1238	0.1238	0.1238	0.1238	0.1238	0.1238
0.200	-0.0039	0.0109	0.0109	0.1123	0.1123	0.1123	0.1123	0.1123	0.1123	0.1123
0.250	*****	0.0091	0.0091	0.0988	0.0988	-0.1280	-0.6123	0.0988	0.0988	0.0988
0.300	-0.0260	0.0114	0.0114	0.0879	0.0879	-0.1114	-0.6051	0.0879	0.0879	0.0879
0.350	-0.0341	0.0080	0.0080	0.0776	0.0776	-0.1014	-0.6158	0.0776	0.0776	0.0776
0.400	-0.0424	0.0055	0.0055	0.0697	0.0697	-0.0911	-0.6355	0.0697	0.0697	0.0697
0.450	-0.0530	0.0038	0.0038	0.0662	0.0662	-0.0821	-0.6511	0.0662	0.0662	0.0662
0.500	-0.0568	0.0010	0.0010	0.0532	0.0532	-0.0768	-0.6653	0.0532	0.0532	0.0532
0.525	*****	-0.0008	-0.0008	0.0466	0.0466	-0.0736	-0.6744	0.0466	0.0466	0.0466
0.550	-0.0553	-0.0051	-0.0051	0.0459	0.0459	-0.0707	-0.6789	0.0459	0.0459	0.0459
0.575	*****	-0.0082	-0.0082	0.0452	0.0452	-0.0700	-0.6879	0.0452	0.0452	0.0452
0.600	-0.0385	-0.0123	-0.0123	0.0385	0.0385	-0.0684	-0.6895	0.0385	0.0385	0.0385
0.625	*****	*****	0.0359	0.0359	-0.0652	-0.6897	0.0359	0.0359	0.0359	0.0359
0.650	-0.0288	-0.0148	-0.0148	0.0309	0.0309	-0.0635	-0.6887	0.0309	0.0309	0.0309
0.675	*****	-0.0229	-0.0229	0.0247	0.0247	-0.0660	-0.6850	0.0247	0.0247	0.0247
0.700	-0.0197	-0.0352	-0.0352	0.0218	0.0218	-0.0680	-0.6883	0.0218	0.0218	0.0218
0.725	*****	-0.0472	-0.0472	*****	-0.0644	-0.6852	0.0218	0.0218	0.0218	0.0218
0.750	-0.0065	-0.0527	-0.0527	*****	-0.0670	-0.6766	0.0218	0.0218	0.0218	0.0218
0.775	*****	-0.0621	-0.0621	0.0054	-0.0689	-0.6613	0.0218	0.0218	0.0218	0.0218
0.800	0.0147	-0.0590	-0.0590	-0.0157	-0.0741	*****	0.0218	0.0218	0.0218	0.0218
0.825	*****	-0.0505	-0.0505	-0.0267	-0.0755	-0.6836	0.0218	0.0218	0.0218	0.0218
0.850	0.0421	-0.0404	-0.0404	-0.0319	-0.0937	-0.5464	0.0218	0.0218	0.0218	0.0218
0.875	*****	-0.0243	-0.0243	-0.0322	-0.1085	-0.5900	0.0218	0.0218	0.0218	0.0218
0.900	0.0813	0.0005	0.0005	-0.0169	-0.1085	*****	0.0218	0.0218	0.0218	0.0218
0.925	*****	0.0333	0.0333	0.0038	-0.0741	-0.5518	0.0218	0.0218	0.0218	0.0218
0.950	0.1268	0.0746	0.0746	0.0450	-0.0387	-0.2912	0.0218	0.0218	0.0218	0.0218
0.975	*****	0.1231	0.1055	0.0347	-0.1358	0.0218	0.0218	0.0218	0.0218	0.0218

η	$x/c_R = .2$		$x/c_R = .4$		$x/c_R = .6$		$x/c_R = .8$		$x/c_R = .95$	
	$C_{p,u}$	$C_{p,l}$	$C_{p,u}$	$C_{p,l}$	$C_{p,u}$	$C_{p,l}$	$C_{p,u}$	$C_{p,l}$	$C_{p,u}$	$C_{p,l}$
-0.200	-0.0475	-0.0071	0.0949	*****	-0.5813	0.0949	0.0949	0.0949	0.0949	0.0949
-0.400	-0.0709	-0.0100	0.0494	-0.1062	-0.6067	0.0494	0.0494	0.0494	0.0494	0.0494
-0.600	*****	-0.0189	0.0183	-0.0904	-0.6963	0.0183	0.0183	0.0183	0.0183	0.0183
-0.700	*****	-0.0705	-0.0026	-0.0862	-0.7041	-0.0026	-0.0862	-0.0862	-0.0862	-0.0862
-0.800	-0.0393	-0.1041	-0.0667	-0.0890	-0.6803	-0.0667	-0.0890	-0.0890	-0.0890	-0.0890
-0.850	-0.0068	-0.0852	-0.0875	-0.1407	-0.5849	-0.0875	-0.1407	-0.1407	-0.1407	-0.1407
-0.900	0.0305	-0.0570	-0.0905	-0.1682	-0.7721	-0.0905	-0.1682	-0.1682	-0.1682	-0.1682
-0.950	*****	*****	-0.0216	-0.1208	-0.3360	-0.0216	-0.1208	-0.1208	-0.1208	-0.1208
-0.975	*****	0.0680	0.0340	-0.0481	-0.2000	0.0680	0.0340	-0.0481	-0.2000	0.0680

Sharp Radius L.E.
 Run No. = 90 , Point No. = 1989
 $C_N = -0.043$, $C_m = 0.0149$
 $\alpha = -0.4^\circ$, $M_\infty = 0.900$
 $R_{mac} = 6.0 \times 10^6$

Surface Pressures Near Leading Edge

● / ◆ upper, starboard/port
 ○ / ◇ lower, starboard/port

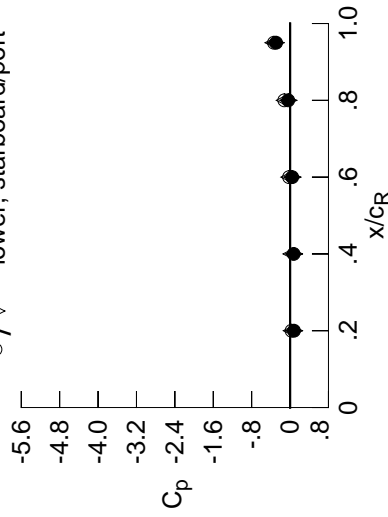

x/c_R	η	starb'd	port	starb'd	port
x/c_R	η	$C_{p,u}$	$C_{p,l}$	$C_{p,u}$	$C_{p,l}$
0.20	0.90	0.0813	0.0828	0.0360	0.0305
0.40	0.95	0.0746	0.0815	0.0292	*****
0.60	0.95	0.0450	0.0472	-0.0145	-0.0216
0.80	0.95	-0.0387	-0.0369	-0.1096	-0.1208
0.95	0.95	-0.2912	-0.3029	-0.3456	-0.3360

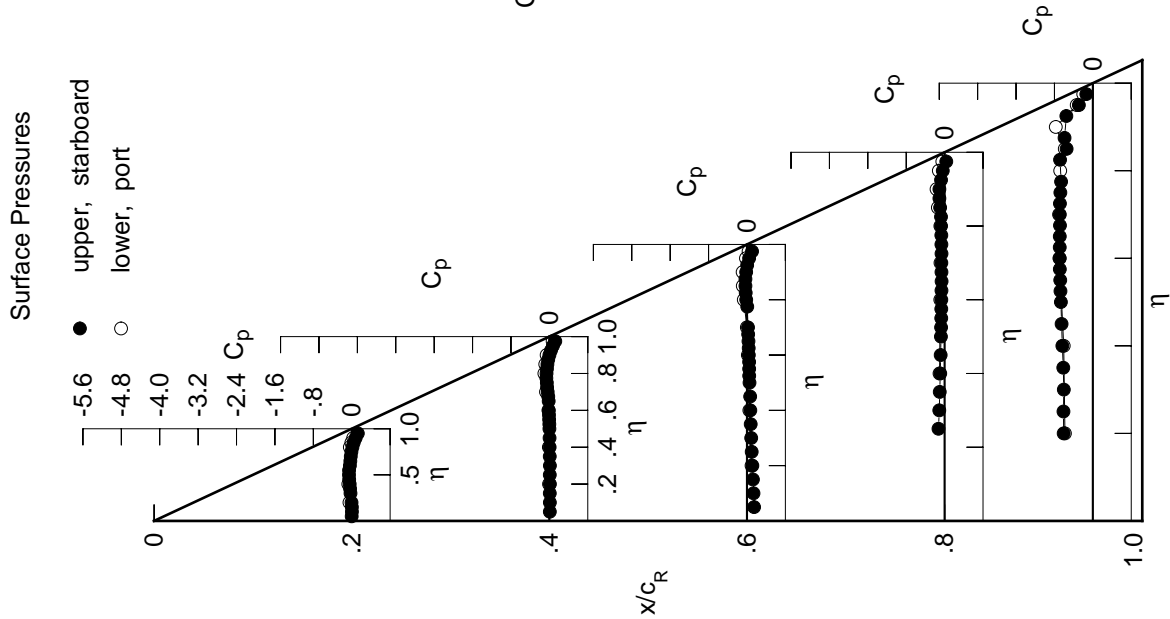

Table D6. Continued.

η	$x/c_R = .2$		$x/c_R = .4$		$x/c_R = .6$		$x/c_R = .8$		$x/c_R = .95$	
	$C_{p,u}$	$C_{p,l}$	$C_{p,u}$	$C_{p,l}$	$C_{p,u}$	$C_{p,l}$	$C_{p,u}$	$C_{p,l}$	$C_{p,u}$	$C_{p,l}$
0.050	-0.0100	-0.0001	0.1402	0.1402	0.1402	0.1402	0.1402	0.1402	0.1402	0.1402
0.100	-0.0057	0.0011	0.1289	0.1289	0.1289	0.1289	0.1289	0.1289	0.1289	0.1289
0.150	-0.0098	0.0003	0.1182	0.1182	0.1182	0.1182	0.1182	0.1182	0.1182	0.1182
0.200	-0.0182	-0.0021	0.1056	0.1056	0.1056	0.1056	0.1056	0.1056	0.1056	0.1056
0.250	*****	-0.0021	0.0930	-0.1366	0.0930	-0.1366	0.0930	-0.1366	0.0930	-0.1366
0.300	-0.0403	0.0019	0.0798	-0.1208	0.0798	-0.1208	0.0798	-0.1208	0.0798	-0.1208
0.350	-0.0485	-0.0016	0.0689	-0.1103	0.0689	-0.1103	0.0689	-0.1103	0.0689	-0.1103
0.400	-0.0574	-0.0041	0.0615	-0.0992	0.0615	-0.0992	0.0615	-0.0992	0.0615	-0.0992
0.450	-0.0665	-0.0070	0.0584	-0.0917	0.0584	-0.0917	0.0584	-0.0917	0.0584	-0.0917
0.500	-0.0695	-0.0120	0.0433	-0.0836	0.0433	-0.0836	0.0433	-0.0836	0.0433	-0.0836
0.525	*****	-0.0120	0.0407	-0.0827	0.0407	-0.0827	0.0407	-0.0827	0.0407	-0.0827
0.550	-0.0702	-0.0150	0.0360	-0.0806	0.0360	-0.0806	0.0360	-0.0806	0.0360	-0.0806
0.575	*****	-0.0203	0.0377	-0.0781	0.0377	-0.0781	0.0377	-0.0781	0.0377	-0.0781
0.600	-0.0542	-0.0224	0.0303	-0.0789	0.0303	-0.0789	0.0303	-0.0789	0.0303	-0.0789
0.625	*****	*****	0.0264	-0.0744	0.0264	-0.0744	0.0264	-0.0744	0.0264	-0.0744
0.650	-0.0434	-0.0266	0.0203	-0.0740	0.0203	-0.0740	0.0203	-0.0740	0.0203	-0.0740
0.675	*****	-0.0346	0.0150	-0.0757	0.0150	-0.0757	0.0150	-0.0757	0.0150	-0.0757
0.700	-0.0361	-0.0544	0.0118	-0.0755	0.0118	-0.0755	0.0118	-0.0755	0.0118	-0.0755
0.725	*****	-0.0711	*****	-0.0748	*****	-0.0748	*****	-0.0748	*****	-0.0748
0.750	-0.0194	-0.0757	*****	-0.0793	*****	-0.0793	*****	-0.0793	*****	-0.0793
0.775	*****	-0.0824	-0.0077	-0.0822	-0.0077	-0.0822	-0.0077	-0.0822	-0.0077	-0.0822
0.800	-0.0027	-0.0816	-0.0315	-0.0856	-0.0315	-0.0856	-0.0315	-0.0856	-0.0315	-0.0856
0.825	*****	-0.0724	-0.0552	-0.0848	-0.0552	-0.0848	-0.0552	-0.0848	-0.0552	-0.0848
0.850	0.0236	-0.0631	-0.0528	-0.1129	-0.0528	-0.1129	-0.0528	-0.1129	-0.0528	-0.1129
0.875	*****	-0.0471	-0.0568	-0.1341	-0.0568	-0.1341	-0.0568	-0.1341	-0.0568	-0.1341
0.900	0.0641	-0.0229	-0.0391	-0.1311	-0.0391	-0.1311	-0.0391	-0.1311	-0.0391	-0.1311
0.925	*****	0.0114	-0.0212	-0.0993	-0.0212	-0.0993	-0.0212	-0.0993	-0.0212	-0.0993
0.950	0.1096	0.0527	0.0202	-0.0668	0.0202	-0.0668	0.0202	-0.0668	0.0202	-0.0668
0.975	*****	0.1024	0.0825	0.0073	0.0825	0.0073	0.0825	0.0073	0.0825	0.0073
-0.200	-0.0401	0.0010	0.0994	0.0994	0.0994	0.0994	0.0994	0.0994	0.0994	0.0994
-0.400	-0.0558	-0.0042	0.0552	-0.1016	0.0552	-0.1016	0.0552	-0.1016	0.0552	-0.1016
-0.600	*****	-0.0167	0.0241	-0.0835	0.0241	-0.0835	0.0241	-0.0835	0.0241	-0.0835
-0.700	*****	-0.0510	0.0063	-0.0796	0.0063	-0.0796	0.0063	-0.0796	0.0063	-0.0796
-0.800	-0.0233	-0.0838	-0.0443	-0.0841	-0.0443	-0.0841	-0.0443	-0.0841	-0.0443	-0.0841
-0.850	0.0102	-0.0659	-0.0663	-0.1239	-0.0663	-0.1239	-0.0663	-0.1239	-0.0663	-0.1239
-0.900	0.0478	-0.0344	-0.0655	-0.1524	-0.0655	-0.1524	-0.0655	-0.1524	-0.0655	-0.1524
-0.950	*****	*****	0.0064	-0.0921	0.0064	-0.0921	0.0064	-0.0921	0.0064	-0.0921
-0.975	*****	0.0904	0.0611	-0.0182	0.0611	-0.0182	0.0611	-0.0182	0.0611	-0.0182

Sharp Radius L.E.

Run No. = 90 , Point No. = 1990

$C_N = -0.026$, $C_m = 0.0124$

$\alpha = 0.0^\circ$, $M_\infty = 0.900$

$R_{mac} = 6.0 \times 10^6$

Surface Pressures Near Leading Edge

● / ◆ upper, starboard/port
○ / ◇ lower, starboard/port

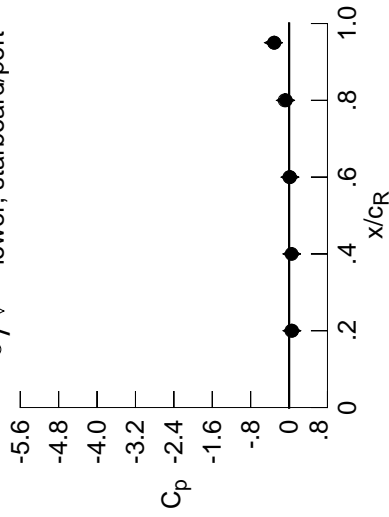

x/c_R	η	starb'd	port	starb'd	port
		$C_{p,u}$	$C_{p,l}$	$C_{p,u}$	$C_{p,l}$
0.20	0.90	0.0641	0.0647	0.0527	0.0478
0.40	0.95	0.0527	0.0583	0.0527	*****
0.60	0.95	0.0202	0.0236	0.0121	0.0064
0.80	0.95	-0.0668	-0.0641	-0.0850	-0.0921
0.95	0.95	-0.3066	-0.3187	-0.3318	-0.3139

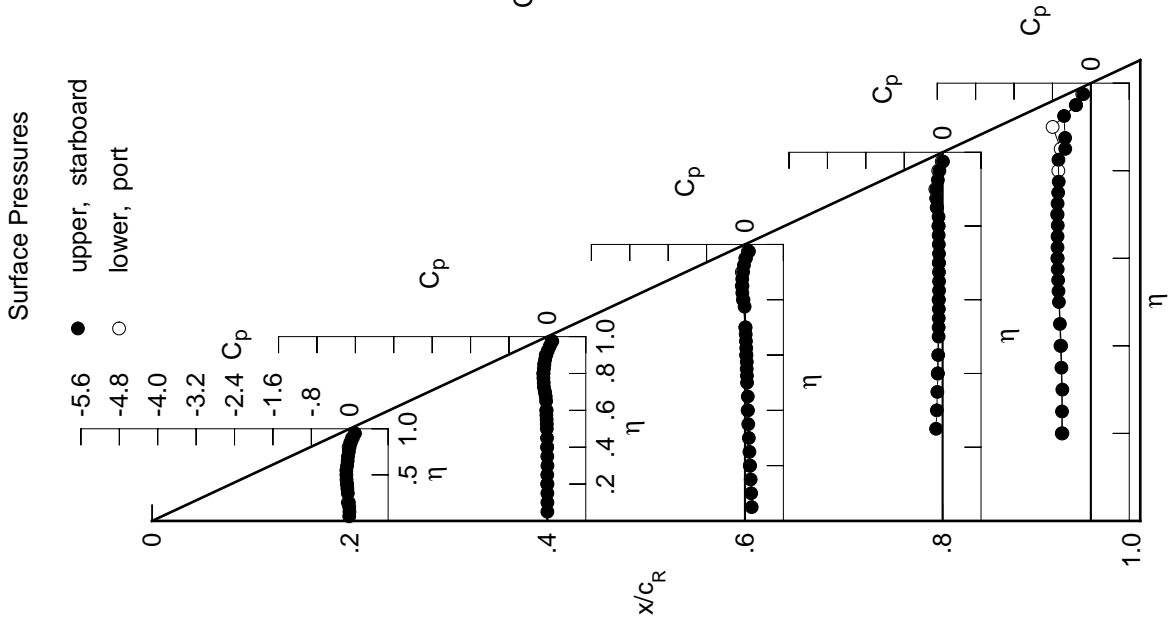

Table D6. Continued.

η	$x/c_R = .2$		$x/c_R = .4$		$x/c_R = .6$		$x/c_R = .8$		$x/c_R = .95$	
	$C_{p,u}$	$C_{p,l}$	$C_{p,u}$	$C_{p,l}$	$C_{p,u}$	$C_{p,l}$	$C_{p,u}$	$C_{p,l}$	$C_{p,u}$	$C_{p,l}$
0.050	-0.0280	-0.0172	0.1297	0.1297	0.1297	0.1297	0.1297	0.1297	0.1297	0.1297
0.100	-0.0273	-0.0153	0.1179	0.1179	0.1179	0.1179	0.1179	0.1179	0.1179	0.1179
0.150	-0.0303	-0.0171	0.1031	0.1031	0.1031	0.1031	0.1031	0.1031	0.1031	0.1031
0.200	-0.0422	-0.0165	0.0941	0.0941	0.0941	0.0941	0.0941	0.0941	0.0941	0.0941
0.250	*****	-0.0204	0.0777	-0.1504	0.0777	-0.1504	0.0777	-0.1504	0.0777	-0.1504
0.300	-0.0607	-0.0164	0.0668	-0.1356	0.0668	-0.1356	0.0668	-0.1356	0.0668	-0.1356
0.350	-0.0712	-0.0215	0.0551	-0.1214	0.0551	-0.1214	0.0551	-0.1214	0.0551	-0.1214
0.400	-0.0779	-0.0218	0.0462	-0.1154	0.0462	-0.1154	0.0462	-0.1154	0.0462	-0.1154
0.450	-0.0863	-0.0251	0.0401	-0.1072	0.0401	-0.1072	0.0401	-0.1072	0.0401	-0.1072
0.500	-0.0923	-0.0312	0.0275	-0.0994	0.0275	-0.0994	0.0275	-0.0994	0.0275	-0.0994
0.525	*****	-0.0336	0.0217	-0.0988	0.0217	-0.0988	0.0217	-0.0988	0.0217	-0.0988
0.550	-0.0964	-0.0383	0.0177	-0.0959	0.0177	-0.0959	0.0177	-0.0959	0.0177	-0.0959
0.575	*****	-0.0457	0.0186	-0.0953	0.0186	-0.0953	0.0186	-0.0953	0.0186	-0.0953
0.600	-0.0835	-0.0488	0.0103	-0.0971	0.0103	-0.0971	0.0103	-0.0971	0.0103	-0.0971
0.625	*****	*****	0.0055	-0.0943	0.0055	-0.0943	0.0055	-0.0943	0.0055	-0.0943
0.650	-0.0745	-0.0559	-0.0030	-0.0934	-0.0030	-0.0934	-0.0030	-0.0934	-0.0030	-0.0934
0.675	*****	-0.0674	-0.0090	-0.0958	-0.0090	-0.0958	-0.0090	-0.0958	-0.0090	-0.0958
0.700	-0.0678	-0.0831	-0.0145	-0.0971	-0.0145	-0.0971	-0.0145	-0.0971	-0.0145	-0.0971
0.725	*****	-0.0991	*****	-0.0986	-0.0986	-0.0986	-0.0986	-0.0986	-0.0986	-0.0986
0.750	-0.0546	-0.1026	*****	-0.1024	-0.1024	-0.1024	-0.1024	-0.1024	-0.1024	-0.1024
0.775	*****	-0.1195	-0.0426	-0.1085	-0.1085	-0.1085	-0.1085	-0.1085	-0.1085	-0.1085
0.800	-0.0393	-0.1225	-0.0682	-0.1144	-0.0682	-0.1144	-0.0682	-0.1144	-0.0682	-0.1144
0.825	*****	-0.1155	-0.0878	-0.1189	-0.1189	-0.1189	-0.1189	-0.1189	-0.1189	-0.1189
0.850	-0.0133	-0.1080	-0.0998	-0.1499	-0.1499	-0.1499	-0.1499	-0.1499	-0.1499	-0.1499
0.875	*****	-0.0959	-0.1002	-0.1783	-0.1783	-0.1783	-0.1783	-0.1783	-0.1783	-0.1783
0.900	0.0254	-0.0736	-0.0921	-0.1803	-0.1803	-0.1803	-0.1803	-0.1803	-0.1803	-0.1803
0.925	*****	-0.0415	-0.0747	-0.1548	-0.1548	-0.1548	-0.1548	-0.1548	-0.1548	-0.1548
0.950	0.0705	-0.0011	-0.0359	-0.1288	-0.1288	-0.1288	-0.1288	-0.1288	-0.1288	-0.1288
0.975	*****	0.0458	0.0219	-0.0593	-0.0593	-0.0593	-0.0593	-0.0593	-0.0593	-0.0593

Sharp Radius L.E.
 Run No. = 90, Point No. = 1991
 $C_N = 0.019$, $C_m = 0.0031$
 $\alpha = 1.1^\circ$, $M_\infty = 0.900$
 $R_{mac} = 6.0 \times 10^6$

Surface Pressures Near Leading Edge

● / ◆ upper, starboard/port
 ○ / ◇ lower, starboard/port

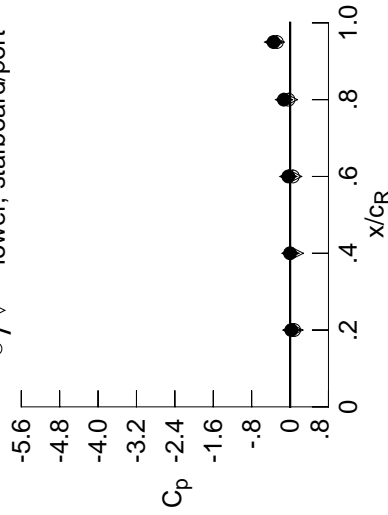

x/c_R	η	starb'd	port	starb'd	port
		$C_{p,u}$	$C_{p,l}$	$C_{p,u}$	$C_{p,l}$
0.20	0.90	0.0254	0.0275	0.0896	0.0854
0.40	0.95	-0.0011	0.0068	0.0993	*****
0.60	0.95	-0.0359	-0.0365	0.0646	0.0592
0.80	0.95	-0.1288	-0.1257	-0.0240	-0.0337
0.95	0.95	-0.3444	-0.3538	-0.3008	-0.2756

Surface Pressures

● upper, starboard
 ○ lower, port

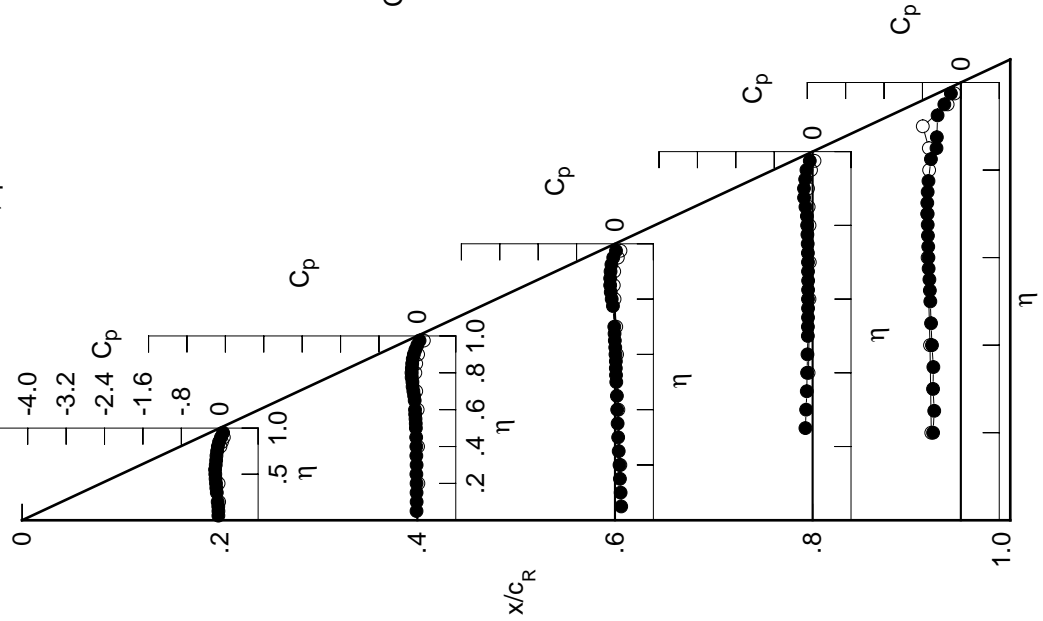

Table D6. Continued.

η	$x/c_R = .2$		$x/c_R = .4$		$x/c_R = .6$		$x/c_R = .8$		$x/c_R = .95$	
	$C_{p,u}$	$C_{p,u}$	$C_{p,u}$	$C_{p,u}$	$C_{p,u}$	$C_{p,u}$	$C_{p,u}$	$C_{p,u}$	$C_{p,u}$	$C_{p,u}$
0.050	-0.0404	-0.0321	0.1139	0.1139	0.1139	0.1139	0.1139	0.1139	0.1139	0.1139
0.100	-0.0395	-0.0371	0.1047	0.1047	0.1047	0.1047	0.1047	0.1047	0.1047	0.1047
0.150	-0.0414	-0.0336	0.0908	0.0908	0.0908	0.0908	0.0908	0.0908	0.0908	0.0908
0.200	-0.0495	-0.0360	0.0766	0.0766	0.0766	0.0766	0.0766	0.0766	0.0766	0.0766
0.250	*****	-0.0366	0.0660	0.0660	-0.1678	-0.5438	0.0660	0.0660	-0.1678	-0.5438
0.300	-0.0686	-0.0402	0.0504	0.0504	-0.1490	-0.5279	0.0504	0.0504	-0.1490	-0.5279
0.350	-0.0776	-0.0395	0.0402	0.0402	-0.1423	-0.5282	0.0402	0.0402	-0.1423	-0.5282
0.400	-0.0897	-0.0455	0.0284	0.0284	-0.1300	-0.5580	0.0284	0.0284	-0.1300	-0.5580
0.450	-0.1071	-0.0479	0.0251	0.0251	-0.1255	-0.5834	0.0251	0.0251	-0.1255	-0.5834
0.500	-0.1133	-0.0560	0.0081	0.0081	-0.1164	-0.6026	0.0081	0.0081	-0.1164	-0.6026
0.525	*****	-0.0601	0.0030	0.0030	-0.1168	-0.6088	0.0030	0.0030	-0.1168	-0.6088
0.550	-0.1204	-0.0647	-0.0019	-0.0019	-0.1153	-0.6256	-0.0019	-0.0019	-0.1153	-0.6256
0.575	*****	-0.0714	-0.0022	-0.0022	-0.1146	-0.6397	-0.0022	-0.0022	-0.1146	-0.6397
0.600	-0.1137	-0.0768	-0.0110	-0.0110	-0.1163	-0.6469	-0.0110	-0.0110	-0.1163	-0.6469
0.625	*****	*****	-0.0183	-0.0183	-0.1138	-0.6464	-0.0183	-0.0183	-0.1138	-0.6464
0.650	-0.1080	-0.0864	-0.0233	-0.0233	-0.1149	-0.6525	-0.0233	-0.0233	-0.1149	-0.6525
0.675	*****	-0.0985	-0.0330	-0.0330	-0.1201	-0.6583	-0.0330	-0.0330	-0.1201	-0.6583
0.700	-0.1007	-0.1135	-0.0397	-0.0397	-0.1229	-0.6695	-0.0397	-0.0397	-0.1229	-0.6695
0.725	*****	-0.1329	*****	*****	-0.1250	-0.6829	*****	*****	-0.1250	-0.6829
0.750	-0.0883	-0.1397	*****	*****	-0.1329	-0.6858	*****	*****	-0.1329	-0.6858
0.775	*****	-0.1562	-0.0774	-0.0774	-0.1376	-0.6915	-0.0774	-0.0774	-0.1376	-0.6915
0.800	-0.0753	-0.1614	-0.1025	-0.1025	-0.1492	*****	-0.1025	-0.1025	-0.1492	*****
0.825	*****	-0.1550	-0.1284	-0.1284	-0.1582	-0.6985	-0.1284	-0.1284	-0.1582	-0.6985
0.850	-0.0495	-0.1553	-0.1430	-0.1430	-0.1877	-0.5259	-0.1430	-0.1430	-0.1877	-0.5259
0.875	*****	-0.1440	-0.1516	-0.1516	-0.2183	-0.5171	-0.1516	-0.1516	-0.2183	-0.5171
0.900	-0.0134	-0.1248	-0.1491	-0.1491	-0.2253	*****	-0.1491	-0.1491	-0.2253	*****
0.925	*****	-0.0967	-0.1407	-0.1407	-0.2169	-0.6751	-0.1407	-0.1407	-0.2169	-0.6751
0.950	0.0266	-0.0560	-0.1018	-0.1018	-0.1970	-0.3931	-0.1018	-0.1018	-0.1970	-0.3931
0.975	*****	-0.0085	-0.0433	-0.0433	-0.1283	-0.2685	-0.0433	-0.0433	-0.1283	-0.2685
-0.200	0.0188	0.0351	0.1256	0.1256	0.1256	0.6247	0.1256	0.1256	0.1256	0.6247
-0.400	0.0015	0.0328	0.0851	0.0851	-0.0723	-0.6541	0.0851	0.0851	-0.0723	-0.6541
-0.600	*****	0.0284	0.0576	0.0576	-0.0475	-0.6893	0.0576	0.0576	-0.0475	-0.6893
-0.700	*****	0.0044	0.0485	0.0485	-0.0432	-0.6840	0.0485	0.0485	-0.0432	-0.6840
-0.800	0.0482	-0.0009	0.0212	0.0212	-0.0415	-0.6481	0.0212	0.0212	-0.0415	-0.6481
-0.850	0.0802	0.0162	0.0140	0.0140	-0.0525	-0.6492	0.0140	0.0140	-0.0525	-0.6492
-0.900	0.1170	0.0578	0.0297	0.0297	-0.0508	-0.7940	0.0297	0.0297	-0.0508	-0.7940
-0.950	*****	*****	0.1033	0.1033	0.0156	-0.2461	0.1033	0.1033	0.0156	-0.2461
-0.975	*****	0.1679	0.1513	0.1513	0.0825	-0.0980	0.1513	0.1513	0.0825	-0.0980

Sharp Radius L.E.
 Run No. = 90 , Point No. = 1992
 $C_N = 0.064$, $C_m = -0.0069$
 $\alpha = 2.1^\circ$, $M_\infty = 0.900$
 $R_{mac} = 6.0 \times 10^6$

Surface Pressures Near Leading Edge

● / ◆ upper, starboard/port
 ○ / ◇ lower, starboard/port

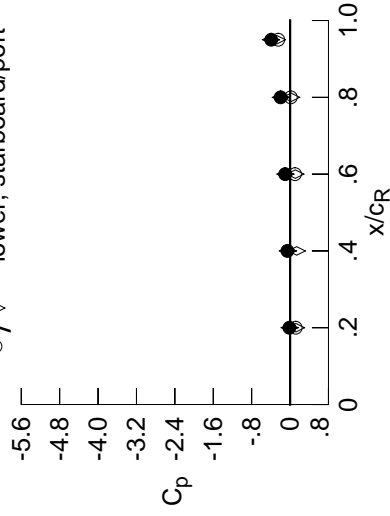

x/c_R	η	starb'd	port	starb'd	port
x/c_R	η	$C_{p,u}$	$C_{p,u}$	$C_{p,l}$	$C_{p,l}$
0.20	0.90	-0.0134	-0.0090	0.1230	0.1170
0.40	0.95	-0.0560	-0.0472	0.1385	*****
0.60	0.95	-0.1018	-0.0988	0.1098	0.1033
0.80	0.95	-0.1970	-0.1907	0.0221	0.0156
0.95	0.95	-0.3931	-0.3972	-0.2762	-0.2461

Surface Pressures

● upper, starboard
 ○ lower, port

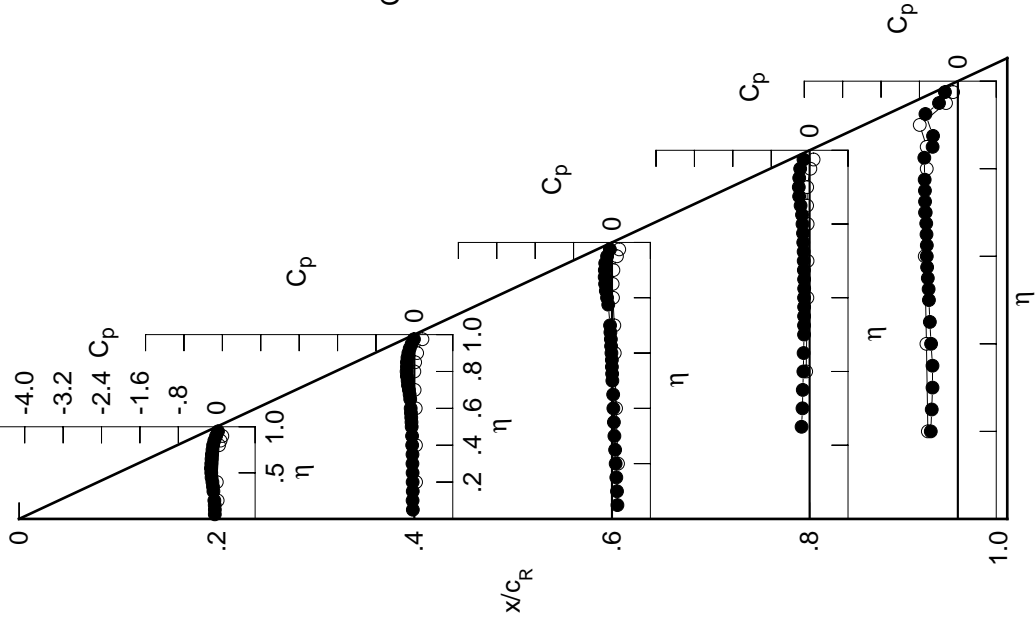

Table D6. Continued.

η	$x/c_R = .2$		$x/c_R = .4$		$x/c_R = .6$		$x/c_R = .8$		$x/c_R = .95$	
	$C_{p,u}$	$C_{p,l}$	$C_{p,u}$	$C_{p,l}$	$C_{p,u}$	$C_{p,l}$	$C_{p,u}$	$C_{p,l}$	$C_{p,u}$	$C_{p,l}$
0.050	-0.0669	-0.0532	0.1020	0.1020	0.1020	0.1020	0.1020	0.1020	0.1020	0.1020
0.100	-0.0679	-0.0539	0.0915	0.0915	0.0915	0.0915	0.0915	0.0915	0.0915	0.0915
0.150	-0.0761	-0.0540	0.0775	0.0775	0.0775	0.0775	0.0775	0.0775	0.0775	0.0775
0.200	-0.0845	-0.0541	0.0660	0.0660	0.0660	0.0660	0.0660	0.0660	0.0660	0.0660
0.250	*****	-0.0570	0.0515	-0.1824	0.0515	-0.1824	0.0515	-0.1824	0.0515	-0.1824
0.300	-0.0955	-0.0587	0.0386	-0.1664	0.0386	-0.1664	0.0386	-0.1664	0.0386	-0.1664
0.350	-0.1035	-0.0592	0.0259	-0.1552	0.0259	-0.1552	0.0259	-0.1552	0.0259	-0.1552
0.400	-0.1160	-0.0663	0.0137	-0.1476	0.0137	-0.1476	0.0137	-0.1476	0.0137	-0.1476
0.450	-0.1300	-0.0698	0.0102	-0.1412	0.0102	-0.1412	0.0102	-0.1412	0.0102	-0.1412
0.500	-0.1387	-0.0787	-0.0103	-0.1344	-0.0103	-0.1344	-0.0103	-0.1344	-0.0103	-0.1344
0.525	*****	-0.0816	-0.0130	-0.1339	-0.0130	-0.1339	-0.0130	-0.1339	-0.0130	-0.1339
0.550	-0.1467	-0.0888	-0.0179	-0.1332	-0.0179	-0.1332	-0.0179	-0.1332	-0.0179	-0.1332
0.575	*****	-0.0959	-0.0232	-0.1306	-0.0232	-0.1306	-0.0232	-0.1306	-0.0232	-0.1306
0.600	-0.1476	-0.1017	-0.0331	-0.1368	-0.0331	-0.1368	-0.0331	-0.1368	-0.0331	-0.1368
0.625	*****	*****	-0.0377	-0.1349	-0.0377	-0.1349	-0.0377	-0.1349	-0.0377	-0.1349
0.650	-0.1417	-0.1125	-0.0482	-0.1376	-0.0482	-0.1376	-0.0482	-0.1376	-0.0482	-0.1376
0.675	*****	-0.1268	-0.0577	-0.1423	-0.0577	-0.1423	-0.0577	-0.1423	-0.0577	-0.1423
0.700	-0.1368	-0.1469	-0.0654	-0.1472	-0.0654	-0.1472	-0.0654	-0.1472	-0.0654	-0.1472
0.725	*****	-0.1681	*****	-0.1487	-0.1487	-0.1487	-0.1487	-0.1487	-0.1487	-0.1487
0.750	-0.1263	-0.1773	*****	-0.1605	-0.1605	-0.1605	-0.1605	-0.1605	-0.1605	-0.1605
0.775	*****	-0.1962	-0.1070	-0.1674	-0.1674	-0.1674	-0.1674	-0.1674	-0.1674	-0.1674
0.800	-0.1155	-0.2039	-0.1381	-0.1798	-0.1381	-0.1798	-0.1381	-0.1798	-0.1381	-0.1798
0.825	*****	-0.2034	-0.1664	-0.1889	-0.1889	-0.1889	-0.1889	-0.1889	-0.1889	-0.1889
0.850	-0.0921	-0.2030	-0.1889	-0.2232	-0.1889	-0.2232	-0.1889	-0.2232	-0.1889	-0.2232
0.875	*****	-0.1980	-0.1985	-0.2564	-0.1985	-0.2564	-0.1985	-0.2564	-0.1985	-0.2564
0.900	-0.0560	-0.1787	-0.2020	-0.2715	-0.2020	-0.2715	-0.2020	-0.2715	-0.2020	-0.2715
0.925	*****	-0.1494	-0.1944	-0.2811	-0.1944	-0.2811	-0.1944	-0.2811	-0.1944	-0.2811
0.950	-0.0218	-0.1029	-0.1517	-0.2631	-0.1517	-0.2631	-0.1517	-0.2631	-0.1517	-0.2631
0.975	*****	-0.1567	-0.1934	-0.2045	-0.1934	-0.2045	-0.1934	-0.2045	-0.1934	-0.2045

η	$x/c_R = .2$		$x/c_R = .4$		$x/c_R = .6$		$x/c_R = .8$		$x/c_R = .95$	
	$C_{p,u}$	$C_{p,l}$	$C_{p,u}$	$C_{p,l}$	$C_{p,u}$	$C_{p,l}$	$C_{p,u}$	$C_{p,l}$	$C_{p,u}$	$C_{p,l}$
-0.200	0.0420	0.0533	0.1373	0.1373	0.1373	0.1373	0.1373	0.1373	0.1373	0.1373
-0.400	0.0243	0.0523	0.0992	-0.0580	0.0992	-0.0580	0.0992	-0.0580	0.0992	-0.0580
-0.600	*****	0.0503	0.0772	-0.0341	0.0772	-0.0341	0.0772	-0.0341	0.0772	-0.0341
-0.700	*****	0.0308	0.0675	-0.0227	0.0675	-0.0227	0.0675	-0.0227	0.0675	-0.0227
-0.800	0.0810	0.0351	0.0471	-0.0184	0.0471	-0.0184	0.0471	-0.0184	0.0471	-0.0184
-0.850	0.1122	0.0511	0.0487	-0.0234	0.0487	-0.0234	0.0487	-0.0234	0.0487	-0.0234
-0.900	0.1460	0.0946	0.0689	-0.0125	0.0689	-0.0125	0.0689	-0.0125	0.0689	-0.0125
-0.950	*****	*****	0.1379	0.0522	0.1379	0.0522	0.1379	0.0522	0.1379	0.0522
-0.975	*****	0.1896	0.1776	0.1118	0.1776	0.1118	0.1776	0.1118	0.1776	0.1118

Sharp Radius L.E.
 Run No. = 90 , Point No. = 1993
 $C_N = 0.112$, $C_m = -0.0181$
 $\alpha = 3.2^\circ$, $M_\infty = 0.900$
 $R_{mac} = 6.0 \times 10^6$

Surface Pressures Near Leading Edge

● / ◆ upper, starboard/port
 ○ / ◇ lower, starboard/port

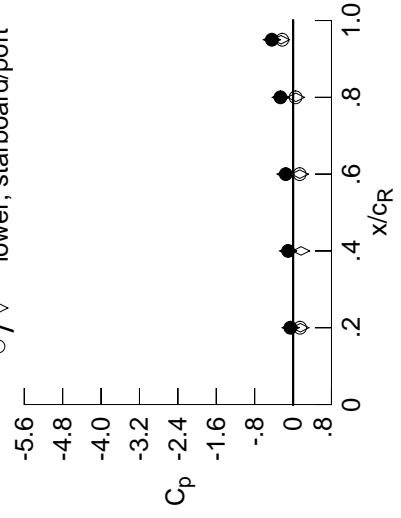

x/c_R	η	starb'd	port	starb'd	port
		$C_{p,u}$	$C_{p,l}$	$C_{p,u}$	$C_{p,l}$
0.20	0.90	-0.0560	-0.0521	0.1508	0.1460
0.40	0.95	-0.1029	-0.1029	0.1667	*****
0.60	0.95	-0.1517	-0.1575	0.1407	0.1379
0.80	0.95	-0.2631	-0.2576	0.0596	0.0522
0.95	0.95	-0.4424	-0.4409	-0.2520	-0.2253

Table D6. Continued.

η	$x/c_R = .2$		$x/c_R = .4$		$x/c_R = .6$		$x/c_R = .8$		$x/c_R = .95$	
	$C_{p,u}$	$C_{p,u}$	$C_{p,u}$	$C_{p,u}$	$C_{p,u}$	$C_{p,u}$	$C_{p,u}$	$C_{p,u}$	$C_{p,u}$	$C_{p,u}$
0.050	-0.0902	-0.0695	0.0890	0.0890	0.0890	0.0890	0.0890	0.0890	0.0890	0.0890
0.100	-0.0917	-0.0713	0.0797	0.0797	0.0797	0.0797	0.0797	0.0797	0.0797	0.0797
0.150	-0.0989	-0.0703	0.0664	0.0664	0.0664	0.0664	0.0664	0.0664	0.0664	0.0664
0.200	-0.1076	-0.0736	0.0522	0.0522	0.0522	0.0522	0.0522	0.0522	0.0522	0.0522
0.250	*****	-0.0752	0.0396	0.0396	-0.1976	-0.1976	-0.4634	-0.4634	-0.5604	-0.5604
0.300	-0.1170	-0.0765	0.0227	0.0227	-0.1834	-0.1834	-0.4347	-0.4347	-0.5279	-0.5279
0.350	-0.1278	-0.0809	0.0117	0.0117	-0.1722	-0.1722	-0.4925	-0.4925	-0.5859	-0.5859
0.400	-0.1401	-0.0869	-0.0015	-0.0015	-0.1648	-0.1648	-0.5279	-0.5279	-0.6000	-0.6000
0.450	-0.1553	-0.0937	-0.0049	-0.0049	-0.1562	-0.1562	-0.5111	-0.5111	-0.6118	-0.6118
0.500	-0.1654	-0.1022	-0.0282	-0.0282	-0.1526	-0.1526	-0.5634	-0.5634	-0.6455	-0.6455
0.525	*****	-0.1088	-0.0312	-0.0312	-0.1556	-0.1556	-0.6000	-0.6000	-0.6558	-0.6558
0.550	-0.1739	-0.1130	-0.0390	-0.0390	-0.1529	-0.1529	-0.5877	-0.5877	-0.6685	-0.6685
0.575	*****	-0.1227	-0.0428	-0.0428	-0.1535	-0.1535	-0.5859	-0.5859	-0.6870	-0.6870
0.600	-0.1770	-0.1284	-0.0551	-0.0551	-0.1568	-0.1568	-0.5838	-0.5838	-0.6982	-0.6982
0.625	*****	*****	-0.0608	-0.0608	-0.1597	-0.1597	-0.6118	-0.6118	-0.7150	-0.7150
0.650	-0.1751	-0.1420	-0.0704	-0.0704	-0.1612	-0.1612	-0.6455	-0.6455	-0.7257	-0.7257
0.675	*****	-0.1591	-0.0837	-0.0837	-0.1654	-0.1654	-0.6558	-0.6558	-0.7332	-0.7332
0.700	-0.1713	-0.1788	-0.0905	-0.0905	-0.1697	-0.1697	-0.6685	-0.6685	-0.7415	-0.7415
0.725	*****	-0.2040	*****	*****	-0.1748	-0.1748	-0.6854	-0.6854	-0.7469	-0.7469
0.750	-0.1637	-0.2165	*****	*****	-0.1868	-0.1868	-0.6870	-0.6870	-0.7517	-0.7517
0.775	*****	-0.2354	-0.1390	-0.1390	-0.2002	-0.2002	-0.6982	-0.6982	-0.7569	-0.7569
0.800	-0.1566	-0.2469	-0.1701	-0.1701	-0.2098	-0.2098	*****	*****	-0.7617	-0.7617
0.825	*****	-0.2500	-0.2011	-0.2011	-0.2257	-0.2257	-0.6771	-0.6771	-0.7669	-0.7669
0.850	-0.1330	-0.2512	-0.2259	-0.2259	-0.2600	-0.2600	-0.5532	-0.5532	-0.7717	-0.7717
0.875	*****	-0.2415	-0.2351	-0.2351	-0.3005	-0.3005	-0.5165	-0.5165	-0.7769	-0.7769
0.900	-0.0959	-0.2195	-0.2433	-0.2433	-0.3177	-0.3177	*****	*****	-0.7817	-0.7817
0.925	*****	-0.1870	-0.2238	-0.2238	-0.3220	-0.3220	-0.7150	-0.7150	-0.7869	-0.7869
0.950	-0.0732	-0.2541	-0.3016	-0.3016	-0.3294	-0.3294	-0.4769	-0.4769	-0.7917	-0.7917
0.975	*****	-0.3895	-0.4562	-0.4562	-0.4860	-0.4860	-0.5217	-0.5217	-0.7969	-0.7969
-0.200	0.0630	0.0753	0.1542	0.1542	0.1542	0.1542	0.1542	0.1542	0.1542	0.1542
-0.400	0.0497	0.0741	0.1177	0.1177	-0.0416	-0.0416	-0.6727	-0.6727	-0.6385	-0.6385
-0.600	*****	0.0759	0.0952	0.0952	-0.0167	-0.0167	-0.6725	-0.6725	-0.6385	-0.6385
-0.700	*****	0.0595	0.0912	0.0912	-0.0030	-0.0030	-0.6642	-0.6642	-0.6385	-0.6385
-0.800	0.1124	0.0687	0.0775	0.0775	0.0071	0.0071	-0.6171	-0.6171	-0.6385	-0.6385
-0.850	0.1413	0.0844	0.0819	0.0819	0.0043	0.0043	-0.6130	-0.6130	-0.6385	-0.6385
-0.900	0.1724	0.1288	0.1046	0.1046	0.0201	0.0201	-0.6969	-0.6969	-0.6385	-0.6385
-0.950	*****	*****	0.1663	0.1663	0.0857	0.0857	-0.2069	-0.2069	-0.6385	-0.6385
-0.975	*****	0.2029	0.1956	0.1956	0.1344	0.1344	-0.0633	-0.0633	-0.6385	-0.6385

Sharp Radius L.E.

Run No. = 90 , Point No. = 1994

$C_N = 0.158$, $C_m = -0.0264$

$\alpha = 4.2^\circ$, $M_\infty = 0.900$

$R_{mac} = 6.0 \times 10^6$

Surface Pressures Near Leading Edge

● / ◆ upper, starboard/port
○ / ◇ lower, starboard/port

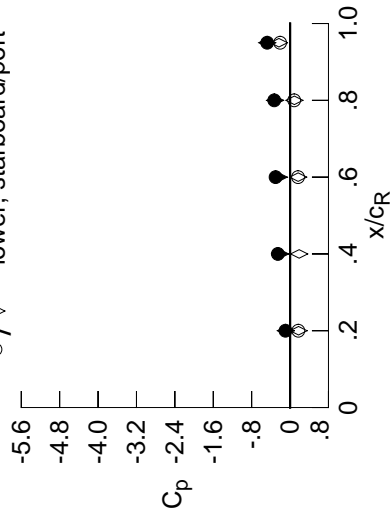

x/c_R	η	starb'd	port	starb'd	port
		$C_{p,u}$	$C_{p,l}$	$C_{p,u}$	$C_{p,l}$
0.20	0.90	-0.0959	-0.0891	0.1769	0.1724
0.40	0.95	-0.2541	-0.2076	0.1894	*****
0.60	0.95	-0.3016	-0.2368	0.1690	0.1663
0.80	0.95	-0.3294	-0.3120	0.0899	0.0857
0.95	0.95	-0.4769	-0.4759	-0.2320	-0.2069

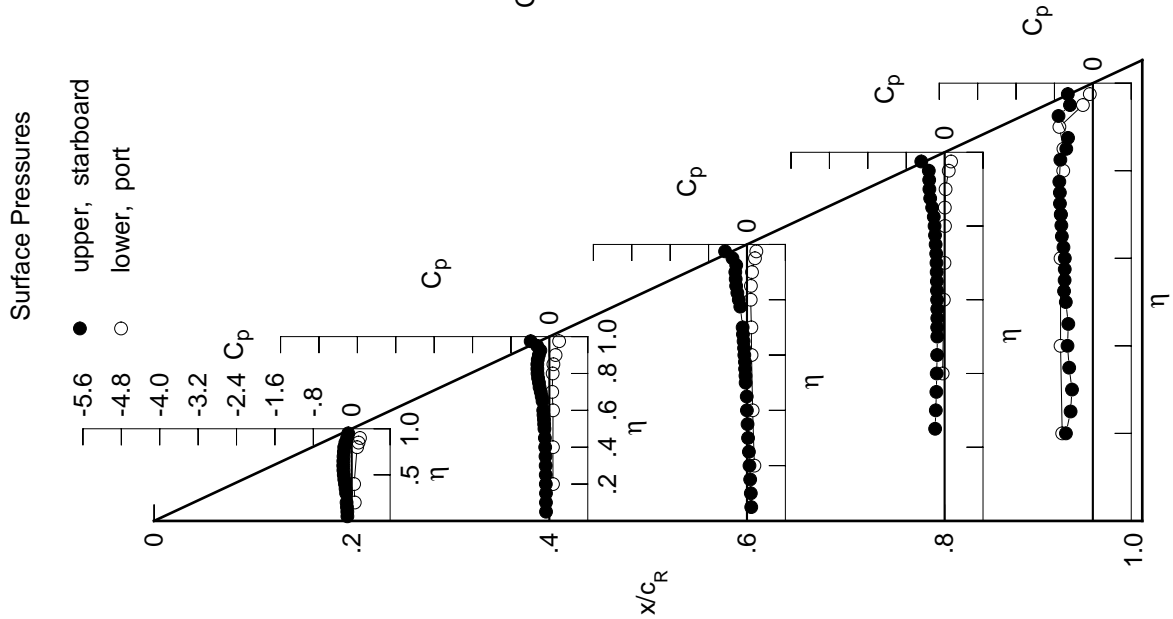

Table D6. Continued.

η	$x/c_R = .2$		$x/c_R = .4$		$x/c_R = .6$		$x/c_R = .8$		$x/c_R = .95$	
	$C_{p,u}$	$C_{p,l}$	$C_{p,u}$	$C_{p,l}$	$C_{p,u}$	$C_{p,l}$	$C_{p,u}$	$C_{p,l}$	$C_{p,u}$	$C_{p,l}$
0.050	-0.1078	-0.0887	0.0812	0.0812	0.0812	0.0812	0.0812	0.0812	0.0812	0.0812
0.100	-0.1088	-0.0857	0.0671	0.0671	0.0671	0.0671	0.0671	0.0671	0.0671	0.0671
0.150	-0.1178	-0.0930	0.0553	0.0553	0.0553	0.0553	0.0553	0.0553	0.0553	0.0553
0.200	-0.1242	-0.0891	0.0396	0.0396	0.0396	0.0396	0.0396	0.0396	0.0396	0.0396
0.250	*****	-0.0954	0.0265	0.0265	-0.2140	-0.4780	0.0265	0.0265	0.0265	0.0265
0.300	-0.1369	-0.0934	0.0096	-0.1968	-0.3739	0.0096	0.0096	0.0096	0.0096	0.0096
0.350	-0.1487	-0.1013	-0.0044	-0.1905	-0.4430	-0.1013	-0.1013	-0.1013	-0.1013	-0.1013
0.400	-0.1616	-0.1093	-0.0133	-0.1778	-0.4825	-0.1093	-0.1093	-0.1093	-0.1093	-0.1093
0.450	-0.1774	-0.1137	-0.0236	-0.1762	-0.4866	-0.1137	-0.1137	-0.1137	-0.1137	-0.1137
0.500	-0.1887	-0.1265	-0.0419	-0.1716	-0.4866	-0.1265	-0.1265	-0.1265	-0.1265	-0.1265
0.525	*****	-0.1290	-0.0522	-0.1733	-0.5283	-0.1290	-0.1290	-0.1290	-0.1290	-0.1290
0.550	-0.1995	-0.1373	-0.0546	-0.1715	-0.5314	-0.1373	-0.1373	-0.1373	-0.1373	-0.1373
0.575	*****	-0.1441	-0.0639	-0.1717	-0.5348	-0.1441	-0.1441	-0.1441	-0.1441	-0.1441
0.600	-0.2017	-0.1565	-0.0727	-0.1786	-0.5458	-0.1565	-0.1565	-0.1565	-0.1565	-0.1565
0.625	*****	*****	-0.0819	-0.1793	-0.6082	-0.0819	-0.0819	-0.0819	-0.0819	-0.0819
0.650	-0.2045	-0.1675	-0.0918	-0.1803	-0.6862	-0.1675	-0.1675	-0.1675	-0.1675	-0.1675
0.675	*****	-0.1882	-0.1038	-0.1889	-0.7124	-0.1882	-0.1882	-0.1882	-0.1882	-0.1882
0.700	-0.2006	-0.2071	-0.1110	-0.1899	-0.7270	-0.2071	-0.2071	-0.2071	-0.2071	-0.2071
0.725	*****	-0.2315	*****	-0.1943	-0.7364	-0.2315	-0.2315	-0.2315	-0.2315	-0.2315
0.750	-0.1970	-0.2498	*****	-0.2058	-0.7384	-0.2498	-0.2498	-0.2498	-0.2498	-0.2498
0.775	*****	-0.2714	-0.1641	-0.2286	-0.7328	-0.2714	-0.2714	-0.2714	-0.2714	-0.2714
0.800	-0.1887	-0.2806	-0.2000	-0.2493	*****	-0.2806	-0.2806	-0.2806	-0.2806	-0.2806
0.825	*****	-0.2878	-0.2276	-0.2590	-0.7625	-0.2878	-0.2878	-0.2878	-0.2878	-0.2878
0.850	-0.1625	-0.2868	-0.2432	-0.3037	-0.6415	-0.2868	-0.2868	-0.2868	-0.2868	-0.2868
0.875	*****	-0.2666	-0.2550	-0.3458	-0.8025	-0.2666	-0.2666	-0.2666	-0.2666	-0.2666
0.900	-0.1443	-0.2727	-0.3168	-0.3814	*****	-0.2727	-0.2727	-0.2727	-0.2727	-0.2727
0.925	*****	-0.3777	-0.4454	-0.4794	-0.8182	-0.3777	-0.3777	-0.3777	-0.3777	-0.3777
0.950	-0.1237	-0.5061	-0.5647	-0.5743	-0.5860	-0.5061	-0.5061	-0.5061	-0.5061	-0.5061
0.975	*****	-0.4939	-0.5554	-0.6094	-0.4650	-0.4939	-0.4939	-0.4939	-0.4939	-0.4939

Sharp Radius L.E.
 Run No. = 90 , Point No. = 1995
 $C_N = 0.209$, $C_m = -0.0377$
 $\alpha = 5.2^\circ$, $M_\infty = 0.900$
 $R_{mac} = 6.0 \times 10^6$

Surface Pressures Near Leading Edge

● / ◆ upper, starboard/port
 ○ / ◇ lower, starboard/port

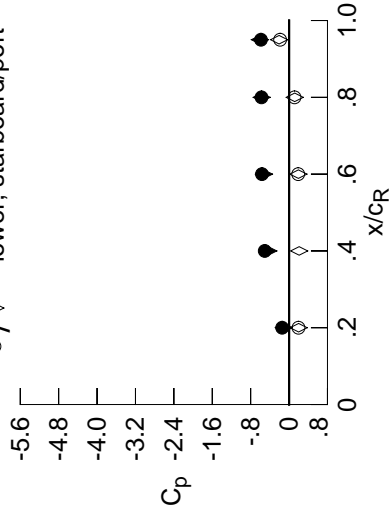

x/c_R	η	starb'd	port	$C_{p,u}$	starb'd	port	$C_{p,l}$
0.20	0.90	-0.1443	-0.1096	0.1994	0.1957	0.1994	0.1957
0.40	0.95	-0.5061	-0.4326	0.2102	*****	0.2102	*****
0.60	0.95	-0.5647	-0.5222	0.1943	0.1907	0.1943	0.1907
0.80	0.95	-0.5743	-0.5713	0.1173	0.1134	0.1173	0.1134
0.95	0.95	-0.5860	-0.6089	-0.2082	-0.1867	-0.2082	-0.1867

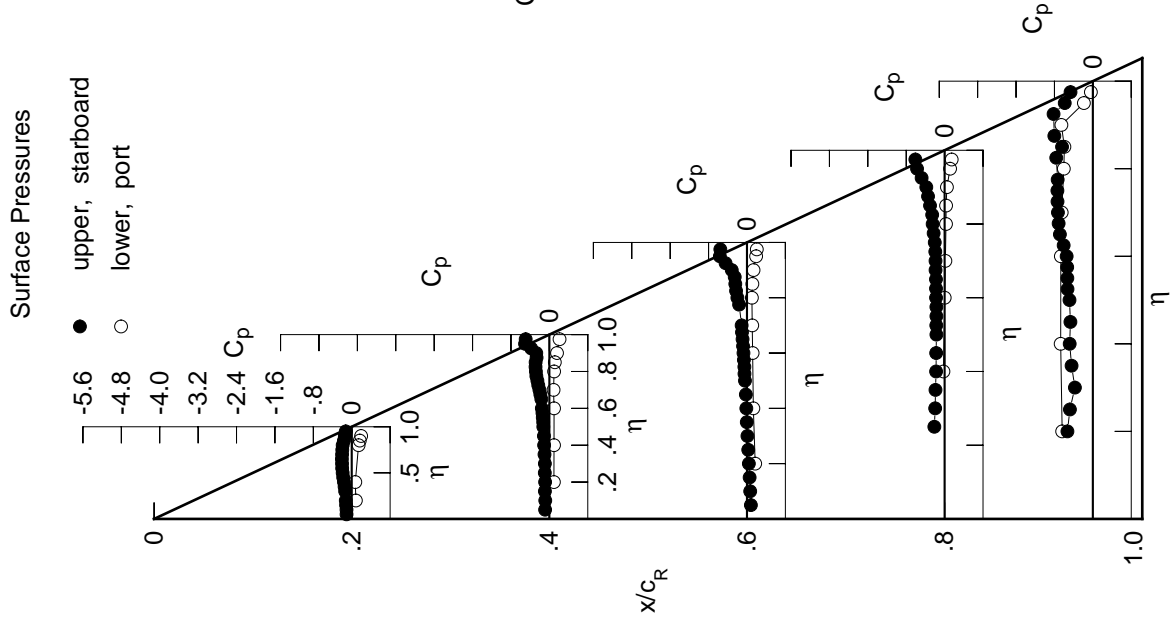

η	$C_{p,l}$	$C_{p,l}$	$C_{p,l}$	$C_{p,l}$	$C_{p,l}$	$C_{p,l}$
-0.200	0.0861	0.0945	0.1714	*****	-0.6391	0.0861
-0.400	0.0745	0.0970	0.1326	-0.0248	-0.6701	0.0745
-0.600	*****	0.0977	0.1180	0.0018	-0.6667	0.0977
-0.700	*****	0.0872	0.1094	0.0157	-0.6491	0.0872
-0.800	0.1429	0.0987	0.1027	0.0286	-0.6046	0.1429
-0.850	0.1683	0.1137	0.1124	0.0301	-0.5930	0.1683
-0.900	0.1957	0.1591	0.1364	0.0481	-0.6555	0.1957
-0.950	*****	*****	0.1907	0.1134	-0.1867	*****
-0.975	*****	0.2118	0.2045	0.1472	-0.0411	*****

Table D6. Continued.

η	$x/c_R = .2$		$x/c_R = .4$		$x/c_R = .6$		$x/c_R = .8$		$x/c_R = .95$	
	$C_{p,u}$	$C_{p,l}$	$C_{p,u}$	$C_{p,l}$	$C_{p,u}$	$C_{p,l}$	$C_{p,u}$	$C_{p,l}$	$C_{p,u}$	$C_{p,l}$
0.050	-0.1239	-0.1087	0.0671	*****	*****	*****	*****	*****	*****	*****
0.100	-0.1284	-0.1059	0.0550	*****	*****	*****	*****	*****	*****	*****
0.150	-0.1390	-0.1106	0.0451	*****	*****	*****	*****	*****	*****	*****
0.200	-0.1435	-0.1084	0.0260	*****	*****	*****	*****	*****	*****	*****
0.250	*****	-0.1163	0.0124	-0.2365	-0.4413	*****	*****	*****	*****	*****
0.300	-0.1587	-0.1170	-0.0083	-0.2196	-0.3344	*****	*****	*****	*****	*****
0.350	-0.1710	-0.1226	-0.0215	-0.2119	-0.3526	*****	*****	*****	*****	*****
0.400	-0.1819	-0.1357	-0.0309	-0.2015	-0.3777	*****	*****	*****	*****	*****
0.450	-0.1993	-0.1391	-0.0417	-0.1993	-0.3586	*****	*****	*****	*****	*****
0.500	-0.2111	-0.1508	-0.0603	-0.1959	-0.3809	*****	*****	*****	*****	*****
0.525	*****	-0.1535	-0.0710	-0.1959	-0.4233	*****	*****	*****	*****	*****
0.550	-0.2209	-0.1642	-0.0756	-0.1935	-0.4677	*****	*****	*****	*****	*****
0.575	*****	-0.1728	-0.0802	-0.1918	-0.5567	*****	*****	*****	*****	*****
0.600	-0.2237	-0.1808	-0.0928	-0.1973	-0.6237	*****	*****	*****	*****	*****
0.625	*****	*****	-0.1018	-0.1935	-0.6822	*****	*****	*****	*****	*****
0.650	-0.2281	-0.1970	-0.1094	-0.1919	-0.7242	*****	*****	*****	*****	*****
0.675	*****	-0.2190	-0.1194	-0.1943	-0.7278	*****	*****	*****	*****	*****
0.700	-0.2256	-0.2363	-0.1321	-0.1935	-0.7240	*****	*****	*****	*****	*****
0.725	*****	-0.2647	*****	-0.1832	-0.7048	*****	*****	*****	*****	*****
0.750	-0.2179	-0.2782	*****	-0.1680	-0.7349	*****	*****	*****	*****	*****
0.775	*****	-0.3015	-0.1700	-0.2128	-0.8387	*****	*****	*****	*****	*****
0.800	-0.2048	-0.3072	-0.2070	-0.3914	*****	*****	*****	*****	*****	*****
0.825	*****	-0.3061	-0.2577	-0.5064	-0.9366	*****	*****	*****	*****	*****
0.850	-0.1837	-0.3171	-0.3773	-0.5760	-0.7669	*****	*****	*****	*****	*****
0.875	*****	-0.3792	-0.5185	-0.5947	-0.7766	*****	*****	*****	*****	*****
0.900	-0.3367	-0.5254	-0.6125	-0.5934	*****	*****	*****	*****	*****	*****
0.925	*****	-0.6098	-0.6460	-0.5887	-0.5939	*****	*****	*****	*****	*****
0.950	-0.2363	-0.6275	-0.6283	-0.5782	-0.4899	*****	*****	*****	*****	*****
0.975	*****	-0.6039	-0.6070	-0.5756	-0.4258	*****	*****	*****	*****	*****
-0.200	$C_{p,l}$	0.1089	0.1133	0.1855	*****	-0.6332	*****	*****	*****	*****
-0.400	$C_{p,l}$	0.0993	0.1179	0.1472	-0.0107	-0.6641	*****	*****	*****	*****
-0.600	$C_{p,l}$	*****	0.1216	0.1347	0.0181	-0.6572	*****	*****	*****	*****
-0.700	$C_{p,l}$	*****	0.1130	0.1308	0.0317	-0.6398	*****	*****	*****	*****
-0.800	$C_{p,l}$	0.1691	0.1270	0.1265	0.0491	-0.5930	*****	*****	*****	*****
-0.850	$C_{p,l}$	0.1920	0.1414	0.1399	0.0535	-0.5777	*****	*****	*****	*****
-0.900	$C_{p,l}$	0.2160	0.1858	0.1626	0.0743	-0.6223	*****	*****	*****	*****
-0.950	$C_{p,l}$	*****	*****	0.2069	0.1344	-0.1752	*****	*****	*****	*****
-0.975	$C_{p,l}$	*****	0.2130	0.2073	0.1549	-0.0375	*****	*****	*****	*****

Sharp Radius L.E.
 Run No. = 90 , Point No. = 1996
 $C_N = 0.260$, $C_m = -0.0468$
 $\alpha = 6.3^\circ$, $M_\infty = 0.900$
 $R_{mac} = 6.0 \times 10^6$

Surface Pressures Near Leading Edge

● / ◆ upper, starboard/port
 ○ / ◇ lower, starboard/port

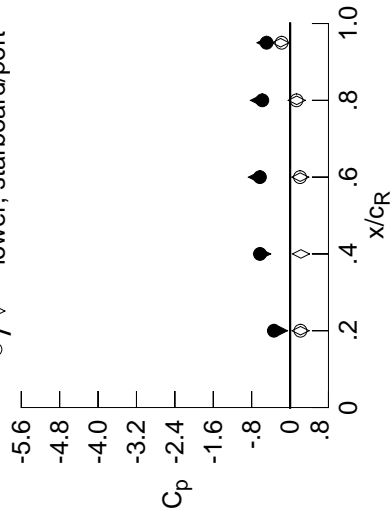

x/c_R	η	starb'd	port	starb'd	port
		$C_{p,u}$	$C_{p,l}$	$C_{p,u}$	$C_{p,l}$
0.20	0.90	-0.3367	-0.2311	0.2174	0.2160
0.40	0.95	-0.6275	-0.5822	0.2268	*****
0.60	0.95	-0.6283	-0.6907	0.2122	0.2069
0.80	0.95	-0.5782	-0.6465	0.1381	0.1344
0.95	0.95	-0.4899	-0.5122	-0.1973	-0.1752

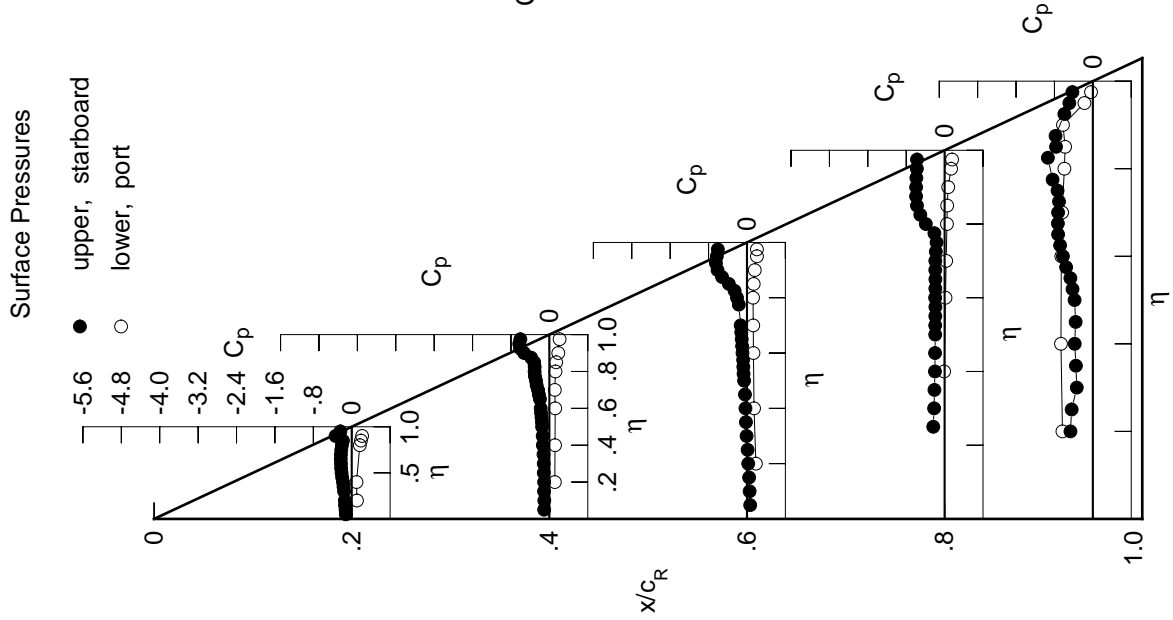

Table D6. Continued.

η	$x/c_R = .2$		$x/c_R = .4$		$x/c_R = .6$		$x/c_R = .8$		$x/c_R = .95$	
	$C_{p,u}$	$C_{p,l}$	$C_{p,u}$	$C_{p,l}$	$C_{p,u}$	$C_{p,l}$	$C_{p,u}$	$C_{p,l}$	$C_{p,u}$	$C_{p,l}$
0.050	-0.1447	-0.1277	0.0524	0.0524	0.0524	0.0524	0.0524	0.0524	0.0524	0.0524
0.100	-0.1457	-0.1247	0.0380	0.0380	0.0380	0.0380	0.0380	0.0380	0.0380	0.0380
0.150	-0.1584	-0.1331	0.0275	0.0275	0.0275	0.0275	0.0275	0.0275	0.0275	0.0275
0.200	-0.1634	-0.1286	0.0092	0.0092	0.0092	0.0092	0.0092	0.0092	0.0092	0.0092
0.250	*****	-0.1391	-0.0051	-0.2576	-0.2576	-0.2576	-0.2576	-0.2576	-0.2576	-0.2576
0.300	-0.1759	-0.1367	-0.0281	-0.2420	-0.2420	-0.2420	-0.2420	-0.2420	-0.2420	-0.2420
0.350	-0.1869	-0.1461	-0.0400	-0.2336	-0.2336	-0.2336	-0.2336	-0.2336	-0.2336	-0.2336
0.400	-0.1996	-0.1597	-0.0490	-0.2229	-0.2229	-0.2229	-0.2229	-0.2229	-0.2229	-0.2229
0.450	-0.2144	-0.1662	-0.0592	-0.2184	-0.2184	-0.2184	-0.2184	-0.2184	-0.2184	-0.2184
0.500	-0.2262	-0.1769	-0.0738	-0.2110	-0.2110	-0.2110	-0.2110	-0.2110	-0.2110	-0.2110
0.525	*****	-0.1749	-0.0849	-0.2098	-0.2098	-0.2098	-0.2098	-0.2098	-0.2098	-0.2098
0.550	-0.2355	-0.1873	-0.0880	-0.2058	-0.2058	-0.2058	-0.2058	-0.2058	-0.2058	-0.2058
0.575	*****	-0.1946	-0.0919	-0.2030	-0.2030	-0.2030	-0.2030	-0.2030	-0.2030	-0.2030
0.600	-0.2361	-0.2053	-0.1011	-0.2079	-0.2079	-0.2079	-0.2079	-0.2079	-0.2079	-0.2079
0.625	*****	*****	-0.1150	-0.1990	-0.1990	-0.1990	-0.1990	-0.1990	-0.1990	-0.1990
0.650	-0.2402	-0.2165	-0.1226	-0.1933	-0.1933	-0.1933	-0.1933	-0.1933	-0.1933	-0.1933
0.675	*****	-0.2414	-0.1243	-0.1865	-0.1865	-0.1865	-0.1865	-0.1865	-0.1865	-0.1865
0.700	-0.2321	-0.2586	-0.1224	-0.1663	-0.1663	-0.1663	-0.1663	-0.1663	-0.1663	-0.1663
0.725	*****	-0.2819	*****	-0.1436	-0.1436	-0.1436	-0.1436	-0.1436	-0.1436	-0.1436
0.750	-0.2330	-0.2922	*****	-0.2412	-0.2412	-0.2412	-0.2412	-0.2412	-0.2412	-0.2412
0.775	*****	-0.3041	-0.2114	-0.5788	-0.5788	-0.5788	-0.5788	-0.5788	-0.5788	-0.5788
0.800	-0.2313	-0.3210	-0.4938	-0.7363	-0.7363	-0.7363	-0.7363	-0.7363	-0.7363	-0.7363
0.825	*****	-0.4183	-0.6388	-0.7637	-0.7637	-0.7637	-0.7637	-0.7637	-0.7637	-0.7637
0.850	-0.3362	-0.5376	-0.6985	-0.7357	-0.7357	-0.7357	-0.7357	-0.7357	-0.7357	-0.7357
0.875	*****	-0.6478	-0.6890	-0.6740	-0.6376	-0.6376	-0.6376	-0.6376	-0.6376	-0.6376
0.900	-0.4943	-0.7153	-0.6888	-0.6110	*****	*****	*****	*****	*****	*****
0.925	*****	-0.7250	-0.6693	-0.5816	-0.6153	-0.6153	-0.6153	-0.6153	-0.6153	-0.6153
0.950	-0.3955	-0.7062	-0.6428	-0.5738	-0.5486	-0.5486	-0.5486	-0.5486	-0.5486	-0.5486
0.975	*****	-0.6925	-0.6313	-0.5719	-0.4667	-0.4667	-0.4667	-0.4667	-0.4667	-0.4667

η	$x/c_R = .2$		$x/c_R = .4$		$x/c_R = .6$		$x/c_R = .8$		$x/c_R = .95$	
	$C_{p,u}$	$C_{p,l}$	$C_{p,u}$	$C_{p,l}$	$C_{p,u}$	$C_{p,l}$	$C_{p,u}$	$C_{p,l}$	$C_{p,u}$	$C_{p,l}$
-0.200	0.1308	0.1365	0.2040	0.2040	0.2040	0.2040	0.2040	0.2040	0.2040	0.2040
-0.400	0.1203	0.1394	0.1668	0.1668	0.1668	0.1668	0.1668	0.1668	0.1668	0.1668
-0.600	*****	0.1460	0.1528	0.0319	0.0319	0.0319	0.0319	0.0319	0.0319	0.0319
-0.700	*****	0.1413	0.1518	0.0510	0.0510	0.0510	0.0510	0.0510	0.0510	0.0510
-0.800	0.1964	0.1553	0.1510	0.0690	0.0690	0.0690	0.0690	0.0690	0.0690	0.0690
-0.850	0.2161	0.1702	0.1659	0.0764	0.0764	0.0764	0.0764	0.0764	0.0764	0.0764
-0.900	0.2354	0.2107	0.1890	0.0999	0.0999	0.0999	0.0999	0.0999	0.0999	0.0999
-0.950	*****	*****	0.2224	0.1503	0.1503	0.1503	0.1503	0.1503	0.1503	0.1503
-0.975	*****	0.2145	0.2116	0.1621	0.1621	0.1621	0.1621	0.1621	0.1621	0.1621

Sharp Radius L.E.
 Run No. = 90, Point No. = 1997
 $C_N = 0.319$, $C_m = -0.0618$
 $\alpha = 7.3^\circ$, $M_\infty = 0.900$
 $R_{mac} = 6.0 \times 10^6$

Surface Pressures Near Leading Edge

● / ◆ upper, starboard/port
 ○ / ◇ lower, starboard/port

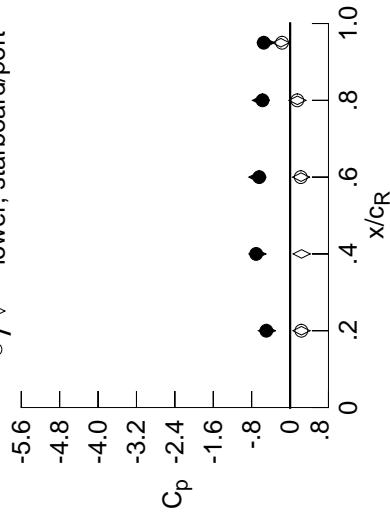

x/c_R	η	starb'd	port	starb'd	port
x/c_R	η	$C_{p,u}$	$C_{p,l}$	$C_{p,u}$	$C_{p,l}$
0.20	0.90	-0.4943	-0.4823	0.2370	0.2354
0.40	0.95	-0.7062	-0.6828	0.2403	*****
0.60	0.95	-0.6428	-0.6829	0.2288	0.2224
0.80	0.95	-0.5738	-0.6072	0.1524	0.1503
0.95	0.95	-0.5486	-0.5049	-0.1921	-0.1671

Table D6. Continued.

η	$x/c_R = .2$		$x/c_R = .4$		$x/c_R = .6$		$x/c_R = .8$		$x/c_R = .95$	
	$C_{p,u}$	$C_{p,l}$	$C_{p,u}$	$C_{p,l}$	$C_{p,u}$	$C_{p,l}$	$C_{p,u}$	$C_{p,l}$	$C_{p,u}$	$C_{p,l}$
0.050	-0.1614	-0.1482	0.0352	*****	*****	*****	*****	*****	*****	*****
0.100	-0.1665	-0.1499	0.0222	*****	*****	*****	*****	*****	*****	*****
0.150	-0.1709	-0.1519	0.0101	*****	*****	*****	*****	*****	*****	*****
0.200	-0.1835	-0.1536	-0.0084	*****	*****	*****	*****	*****	*****	*****
0.250	*****	-0.1603	-0.0216	-0.2763	-0.3822	*****	*****	*****	*****	*****
0.300	-0.1902	-0.1634	-0.0525	-0.2692	-0.2628	*****	*****	*****	*****	*****
0.350	-0.2007	-0.1690	-0.0578	-0.2523	-0.2300	*****	*****	*****	*****	*****
0.400	-0.2121	-0.1839	-0.0678	-0.2417	-0.2386	*****	*****	*****	*****	*****
0.450	-0.2282	-0.1979	-0.0710	-0.2339	-0.3105	*****	*****	*****	*****	*****
0.500	-0.2379	-0.2037	-0.0907	-0.2232	-0.4226	*****	*****	*****	*****	*****
0.525	*****	-0.2016	-0.0961	-0.2252	-0.5191	*****	*****	*****	*****	*****
0.550	-0.2491	-0.2073	-0.1024	-0.2168	-0.6027	*****	*****	*****	*****	*****
0.575	*****	-0.2156	-0.1020	-0.2153	-0.6858	*****	*****	*****	*****	*****
0.600	-0.2680	-0.2273	-0.1093	-0.2091	-0.7255	*****	*****	*****	*****	*****
0.625	*****	*****	-0.1079	-0.1977	-0.7299	*****	*****	*****	*****	*****
0.650	-0.2905	-0.2369	-0.1156	-0.1839	-0.7215	*****	*****	*****	*****	*****
0.675	*****	-0.2558	-0.1140	-0.1702	-0.7326	*****	*****	*****	*****	*****
0.700	-0.2881	-0.2725	-0.0892	-0.1873	-0.8379	*****	*****	*****	*****	*****
0.725	*****	-0.2784	*****	-0.3503	-1.0026	*****	*****	*****	*****	*****
0.750	-0.2703	-0.2775	*****	-0.6583	-1.1175	*****	*****	*****	*****	*****
0.775	*****	-0.3953	-0.7226	-0.8311	-1.1169	*****	*****	*****	*****	*****
0.800	-0.3697	-0.5556	-0.8230	-0.8692	*****	*****	*****	*****	*****	*****
0.825	*****	-0.6813	-0.8216	-0.8645	-0.6158	*****	*****	*****	*****	*****
0.850	-0.5504	-0.7587	-0.7941	-0.7761	-0.6924	*****	*****	*****	*****	*****
0.875	*****	-0.8013	-0.7232	-0.6739	-0.5618	*****	*****	*****	*****	*****
0.900	-0.5672	-0.8109	-0.6989	-0.6380	*****	*****	*****	*****	*****	*****
0.925	*****	-0.7935	-0.6743	-0.5989	-0.5747	*****	*****	*****	*****	*****
0.950	-0.5456	-0.7740	-0.6563	-0.5892	-0.5322	*****	*****	*****	*****	*****
0.975	*****	-0.7720	-0.6466	-0.5845	-0.4683	*****	*****	*****	*****	*****
-0.200	0.1565	0.1603	0.2169	*****	-0.6198	*****	*****	*****	*****	*****
-0.400	0.1427	0.1608	0.1850	0.0197	-0.6577	*****	*****	*****	*****	*****
-0.600	*****	0.1729	0.1753	0.0496	-0.6378	*****	*****	*****	*****	*****
-0.700	*****	0.1684	0.1751	0.0682	-0.6225	*****	*****	*****	*****	*****
-0.800	0.2225	0.1837	0.1757	0.0851	-0.5647	*****	*****	*****	*****	*****
-0.850	0.2385	0.1968	0.1895	0.0947	-0.5509	*****	*****	*****	*****	*****
-0.900	0.2520	0.2339	0.2122	0.1192	-0.5664	*****	*****	*****	*****	*****
-0.950	*****	*****	0.2357	0.1624	-0.1584	*****	*****	*****	*****	*****
-0.975	*****	0.2123	0.2150	0.1626	-0.0331	*****	*****	*****	*****	*****

Sharp Radius L.E.

Run No. = 90 , Point No. = 1998

$C_N = 0.371$, $C_m = -0.0690$

$\alpha = 8.3^\circ$, $M_\infty = 0.900$

$R_{mac} = 6.0 \times 10^6$

Surface Pressures Near Leading Edge

● / ◆ upper, starboard/port
○ / ◇ lower, starboard/port

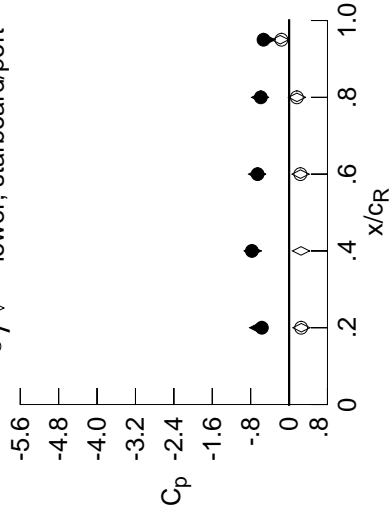

x/c_R	η	starb'd	port	starb'd	port
		$C_{p,u}$	$C_{p,l}$	$C_{p,u}$	$C_{p,l}$
0.20	0.90	-0.5672	-0.6446	0.2563	0.2520
0.40	0.95	-0.7740	-0.7584	0.2489	*****
0.60	0.95	-0.6563	-0.6668	0.2382	0.2357
0.80	0.95	-0.5892	-0.6040	0.1644	0.1624
0.95	0.95	-0.5322	-0.4707	-0.1850	-0.1584

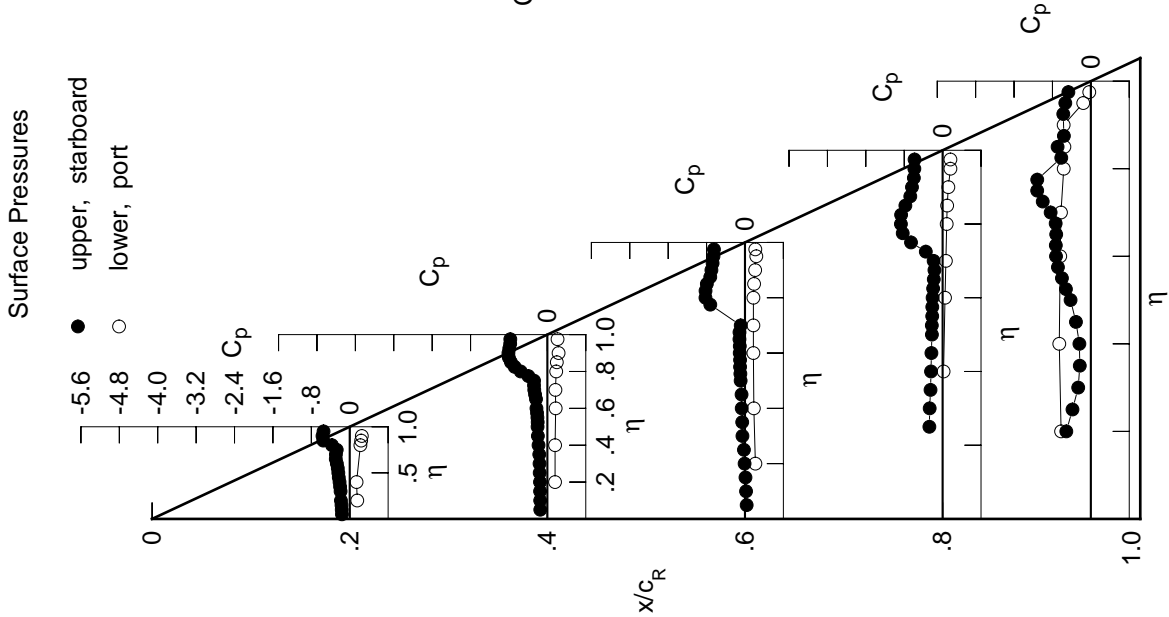

Table D6. Continued.

η	$x/c_R = .2$		$x/c_R = .4$		$x/c_R = .6$		$x/c_R = .8$		$x/c_R = .95$	
	$C_{p,u}$	$C_{p,l}$	$C_{p,u}$	$C_{p,l}$	$C_{p,u}$	$C_{p,l}$	$C_{p,u}$	$C_{p,l}$	$C_{p,u}$	$C_{p,l}$
0.050	-0.1810	-0.1709	0.0157	*****	*****	*****	*****	*****	*****	*****
0.100	-0.1843	-0.1715	0.0056	*****	*****	*****	*****	*****	*****	*****
0.150	-0.1917	-0.1771	-0.0079	*****	*****	*****	*****	*****	*****	*****
0.200	-0.2013	-0.1767	-0.0258	*****	*****	*****	*****	*****	*****	*****
0.250	*****	-0.1821	-0.0393	-0.2949	-0.3311	*****	*****	*****	*****	*****
0.300	-0.2107	-0.1831	-0.0687	-0.2880	-0.2541	*****	*****	*****	*****	*****
0.350	-0.2228	-0.1922	-0.0815	-0.2668	-0.2237	*****	*****	*****	*****	*****
0.400	-0.2361	-0.2025	-0.0826	-0.2545	-0.2196	*****	*****	*****	*****	*****
0.450	-0.2614	-0.2350	-0.0886	-0.2458	-0.2697	*****	*****	*****	*****	*****
0.500	-0.2865	-0.2303	-0.1071	-0.2348	-0.3977	*****	*****	*****	*****	*****
0.525	*****	-0.2308	-0.1114	-0.2310	-0.5356	*****	*****	*****	*****	*****
0.550	-0.3137	-0.2338	-0.1142	-0.2240	-0.6566	*****	*****	*****	*****	*****
0.575	*****	-0.2343	-0.1111	-0.2159	-0.7310	*****	*****	*****	*****	*****
0.600	-0.3230	-0.2383	-0.1148	-0.2081	-0.7382	*****	*****	*****	*****	*****
0.625	*****	*****	-0.1040	-0.1951	-0.7426	*****	*****	*****	*****	*****
0.650	-0.3132	-0.2444	-0.0965	-0.1948	-0.7800	*****	*****	*****	*****	*****
0.675	*****	-0.2612	-0.0926	-0.2455	-0.8817	*****	*****	*****	*****	*****
0.700	-0.2814	-0.2673	-0.1681	-0.4285	-1.0325	*****	*****	*****	*****	*****
0.725	*****	-0.2904	*****	-0.7062	-1.1544	*****	*****	*****	*****	*****
0.750	-0.3744	-0.4856	*****	-0.9015	-0.8184	*****	*****	*****	*****	*****
0.775	*****	-0.7375	-0.9215	-0.9694	-0.6951	*****	*****	*****	*****	*****
0.800	-0.5794	-0.8149	-0.9317	-0.9486	*****	*****	*****	*****	*****	*****
0.825	*****	-0.8518	-0.8957	-0.8081	-0.5873	*****	*****	*****	*****	*****
0.850	-0.6812	-0.8754	-0.8403	-0.7147	-0.6101	*****	*****	*****	*****	*****
0.875	*****	-0.8783	-0.7437	-0.7027	-0.5505	*****	*****	*****	*****	*****
0.900	-0.6270	-0.8621	-0.7158	-0.6652	*****	*****	*****	*****	*****	*****
0.925	*****	-0.8392	-0.6917	-0.6197	-0.5557	*****	*****	*****	*****	*****
0.950	-0.6706	-0.8260	-0.6705	-0.6239	-0.5015	*****	*****	*****	*****	*****
0.975	*****	-0.8260	-0.6581	-0.6207	-0.4315	*****	*****	*****	*****	*****

η	$x/c_R = .2$		$x/c_R = .4$		$x/c_R = .6$		$x/c_R = .8$		$x/c_R = .95$	
	$C_{p,u}$	$C_{p,l}$	$C_{p,u}$	$C_{p,l}$	$C_{p,u}$	$C_{p,l}$	$C_{p,u}$	$C_{p,l}$	$C_{p,u}$	$C_{p,l}$
-0.200	0.1851	0.1857	0.2363	*****	*****	*****	*****	*****	*****	*****
-0.400	0.1706	0.1887	0.2041	0.0376	-0.6491	*****	*****	*****	*****	*****
-0.600	*****	0.2003	0.1953	0.0675	-0.6274	*****	*****	*****	*****	*****
-0.700	*****	0.1956	0.1946	0.0853	-0.6125	*****	*****	*****	*****	*****
-0.800	0.2492	0.2176	0.1986	0.1035	-0.5532	*****	*****	*****	*****	*****
-0.850	0.2622	0.2223	0.2136	0.1148	-0.5390	*****	*****	*****	*****	*****
-0.900	0.2701	0.2549	0.2335	0.1391	-0.5387	*****	*****	*****	*****	*****
-0.950	*****	*****	0.2470	0.1758	-0.1542	*****	*****	*****	*****	*****
-0.975	*****	0.2120	0.2148	0.1658	-0.0341	*****	*****	*****	*****	*****

Sharp Radius L.E.
 Run No. = 90, Point No. = 1999
 $C_N = 0.428$, $C_m = -0.0805$
 $\alpha = 9.3^\circ$, $M_\infty = 0.899$
 $R_{mac} = 6.0 \times 10^6$

Surface Pressures Near Leading Edge

● / ◆ upper, starboard/port
 ○ / ◇ lower, starboard/port

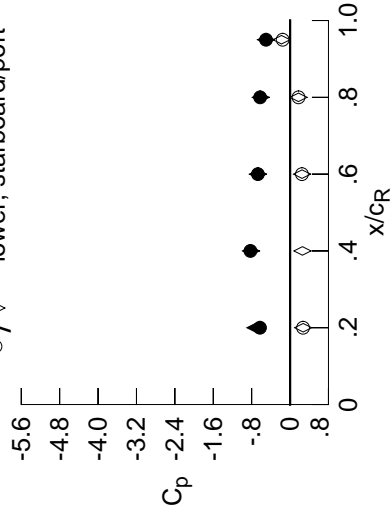

x/c_R	η	starb'd	port	starb'd	port
x/c_R	η	$C_{p,u}$	$C_{p,l}$	$C_{p,u}$	$C_{p,l}$
0.20	0.90	-0.6270	-0.7220	0.2725	0.2701
0.40	0.95	-0.8260	-0.8139	0.2577	*****
0.60	0.95	-0.6705	-0.6707	0.2492	0.2470
0.80	0.95	-0.6239	-0.6102	0.1754	0.1758
0.95	0.95	-0.5015	-0.5021	-0.1779	-0.1542

Table D6. Continued.

η	$x/c_R = .2$		$x/c_R = .4$		$x/c_R = .6$		$x/c_R = .8$		$x/c_R = .95$	
	$C_{p,u}$	$C_{p,l}$	$C_{p,u}$	$C_{p,l}$	$C_{p,u}$	$C_{p,l}$	$C_{p,u}$	$C_{p,l}$	$C_{p,u}$	$C_{p,l}$
0.050	-0.2060	-0.2003	-0.0049	*****	*****	*****	*****	*****	*****	*****
0.100	-0.2096	-0.1996	-0.0175	*****	*****	*****	*****	*****	*****	*****
0.150	-0.2192	-0.2059	-0.0287	*****	*****	*****	*****	*****	*****	*****
0.200	-0.2303	-0.2034	-0.0452	*****	*****	*****	*****	*****	*****	*****
0.250	*****	-0.2119	-0.0567	-0.3149	-0.3095	*****	*****	*****	*****	*****
0.300	-0.2485	-0.2088	-0.0762	-0.3051	-0.2422	*****	*****	*****	*****	*****
0.350	-0.2653	-0.2149	-0.1073	-0.2867	-0.2155	*****	*****	*****	*****	*****
0.400	-0.2837	-0.2163	-0.1049	-0.2712	-0.2237	*****	*****	*****	*****	*****
0.450	-0.3077	-0.2526	-0.1081	-0.2648	-0.3004	*****	*****	*****	*****	*****
0.500	-0.3212	-0.2732	-0.1191	-0.2491	-0.4874	*****	*****	*****	*****	*****
0.525	*****	-0.2646	-0.1248	-0.2449	-0.6434	*****	*****	*****	*****	*****
0.550	-0.3282	-0.2638	-0.1220	-0.2336	-0.7238	*****	*****	*****	*****	*****
0.575	*****	-0.2598	-0.1152	-0.2281	-0.7589	*****	*****	*****	*****	*****
0.600	-0.3154	-0.2552	-0.1106	-0.2291	-0.7790	*****	*****	*****	*****	*****
0.625	*****	*****	-0.1027	-0.2407	-0.8304	*****	*****	*****	*****	*****
0.650	-0.2869	-0.2132	-0.1350	-0.3101	-0.9356	*****	*****	*****	*****	*****
0.675	*****	-0.2242	-0.3018	-0.4921	-1.0628	*****	*****	*****	*****	*****
0.700	-0.3644	-0.4385	-0.6475	-0.7378	-1.1477	*****	*****	*****	*****	*****
0.725	*****	-0.7470	*****	-0.9486	-0.7637	*****	*****	*****	*****	*****
0.750	-0.6185	-0.8899	*****	-1.0570	-0.6989	*****	*****	*****	*****	*****
0.775	*****	-0.9459	-1.0156	-1.0070	-0.6116	*****	*****	*****	*****	*****
0.800	-0.7414	-0.9472	-1.0021	-0.7957	*****	*****	*****	*****	*****	*****
0.825	*****	-0.9320	-0.9392	-0.7195	-0.5576	*****	*****	*****	*****	*****
0.850	-0.7658	-0.9241	-0.8498	-0.7196	-0.5656	*****	*****	*****	*****	*****
0.875	*****	-0.9054	-0.7579	-0.7333	-0.5331	*****	*****	*****	*****	*****
0.900	-0.6962	-0.8860	-0.7369	-0.6725	*****	*****	*****	*****	*****	*****
0.925	*****	-0.8683	-0.7120	-0.6623	-0.5196	*****	*****	*****	*****	*****
0.950	-0.7719	-0.8570	-0.6850	-0.6727	-0.4527	*****	*****	*****	*****	*****
0.975	*****	-0.8510	-0.6703	-0.6689	-0.3974	*****	*****	*****	*****	*****
-0.200	$C_{p,l}$	0.2109	0.2072	0.2531	*****	*****	*****	*****	*****	*****
-0.400	*****	0.2001	0.2103	0.2208	0.0532	-0.6442	*****	*****	*****	*****
-0.600	*****	*****	0.2224	0.2135	0.0807	-0.6199	*****	*****	*****	*****
-0.700	*****	*****	0.2219	0.2116	0.1005	-0.6014	*****	*****	*****	*****
-0.800	*****	0.2749	0.2442	0.2199	0.1193	-0.5424	*****	*****	*****	*****
-0.850	*****	0.2826	0.2454	0.2331	0.1308	-0.5256	*****	*****	*****	*****
-0.900	*****	0.2851	0.2732	0.2516	0.1542	-0.5157	*****	*****	*****	*****
-0.950	*****	*****	*****	0.2531	0.1827	-0.1455	*****	*****	*****	*****
-0.975	*****	*****	0.2076	0.2107	0.1619	-0.0336	*****	*****	*****	*****

Sharp Radius L.E.
 Run No. = 90 , Point No. = 2000
 $C_N = 0.487$, $C_m = -0.0925$
 $\alpha = 10.4^\circ$, $M_\infty = 0.900$
 $R_{mac} = 6.0 \times 10^6$

Surface Pressures Near Leading Edge

● / ◆ upper, starboard/port
 ○ / ◇ lower, starboard/port

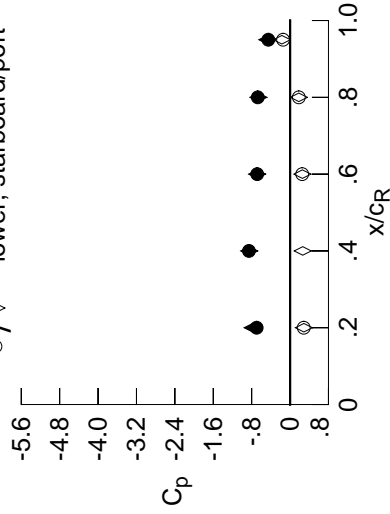

x/c_R	η	starb'd	port	starb'd	port
		$C_{p,u}$	$C_{p,l}$	$C_{p,u}$	$C_{p,l}$
0.20	0.90	-0.6962	-0.7804	0.2883	0.2851
0.40	0.95	-0.8570	-0.8512	0.2642	*****
0.60	0.95	-0.6850	-0.6864	0.2569	0.2531
0.80	0.95	-0.6727	-0.6601	0.1822	0.1827
0.95	0.95	-0.4527	-0.4746	-0.1701	-0.1455

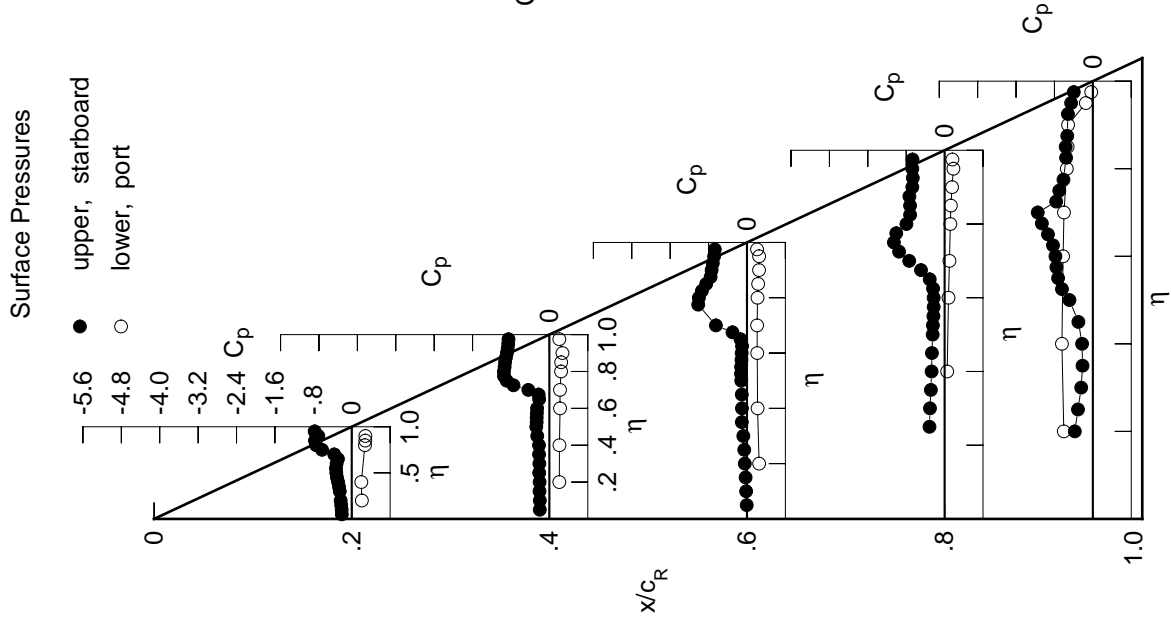

Table D6. Continued.

η	$x/c_R = .2$		$x/c_R = .4$		$x/c_R = .6$		$x/c_R = .8$		$x/c_R = .95$	
	$C_{p,u}$	$C_{p,l}$	$C_{p,u}$	$C_{p,l}$	$C_{p,u}$	$C_{p,l}$	$C_{p,u}$	$C_{p,l}$	$C_{p,u}$	$C_{p,l}$
0.050	-0.2272	-0.2246	-0.0226	*****	*****	*****	*****	*****	*****	*****
0.100	-0.2327	-0.2267	-0.0347	*****	*****	*****	*****	*****	*****	*****
0.150	-0.2435	-0.2289	-0.0445	*****	*****	*****	*****	*****	*****	*****
0.200	-0.2547	-0.2306	-0.0590	*****	*****	*****	*****	*****	*****	*****
0.250	*****	-0.2353	-0.0685	-0.3307	-0.2582	*****	*****	*****	*****	*****
0.300	-0.2779	-0.2356	-0.0839	-0.3137	-0.2904	*****	*****	*****	*****	*****
0.350	-0.2970	-0.2375	-0.1113	-0.3017	-0.3167	*****	*****	*****	*****	*****
0.400	-0.3112	-0.2359	-0.1215	-0.2894	-0.3801	*****	*****	*****	*****	*****
0.450	-0.3269	-0.2547	-0.1170	-0.2773	-0.5094	*****	*****	*****	*****	*****
0.500	-0.3291	-0.2901	-0.1275	-0.2609	-0.6754	*****	*****	*****	*****	*****
0.525	*****	-0.2879	-0.1244	-0.2566	-0.7416	*****	*****	*****	*****	*****
0.550	-0.3193	-0.2830	-0.1238	-0.2523	-0.7764	*****	*****	*****	*****	*****
0.575	*****	-0.2773	-0.1169	-0.2623	-0.8209	*****	*****	*****	*****	*****
0.600	-0.2741	-0.2611	-0.1410	-0.2939	-0.8774	*****	*****	*****	*****	*****
0.625	*****	*****	-0.2027	-0.3711	-0.9693	*****	*****	*****	*****	*****
0.650	-0.3079	-0.3476	-0.4197	-0.5308	-1.0742	*****	*****	*****	*****	*****
0.675	*****	-0.6449	-0.7380	-0.7550	-0.9917	*****	*****	*****	*****	*****
0.700	-0.6325	-0.9096	-0.9894	-0.9658	-0.7233	*****	*****	*****	*****	*****
0.725	*****	-1.1015	*****	-1.1093	-0.6412	*****	*****	*****	*****	*****
0.750	-0.8056	-1.0281	*****	-0.9339	-0.5775	*****	*****	*****	*****	*****
0.775	*****	-1.0185	-1.0756	-0.7779	-0.5499	*****	*****	*****	*****	*****
0.800	-0.8444	-0.9970	-1.0233	-0.7481	*****	*****	*****	*****	*****	*****
0.825	*****	-0.9761	-0.9028	-0.7501	-0.5305	*****	*****	*****	*****	*****
0.850	-0.8290	-0.9502	-0.8260	-0.7556	-0.5372	*****	*****	*****	*****	*****
0.875	*****	-0.9189	-0.7725	-0.7270	-0.5186	*****	*****	*****	*****	*****
0.900	-0.7593	-0.8950	-0.7739	-0.7116	*****	*****	*****	*****	*****	*****
0.925	*****	-0.8764	-0.7389	-0.7326	-0.4766	*****	*****	*****	*****	*****
0.950	-0.8441	-0.8651	-0.7133	-0.7338	-0.4167	*****	*****	*****	*****	*****
0.975	*****	-0.8620	-0.6976	-0.7246	-0.3787	*****	*****	*****	*****	*****
-0.200	$C_{p,l}$	0.2406	0.2301	0.2708	*****	*****	*****	*****	*****	*****
-0.400		0.2310	0.2349	0.2379	0.0661	0.0662	0.0661	0.0661	0.0661	0.0662
-0.600		*****	0.2484	0.2315	0.0964	0.6084	0.0964	0.0964	0.0964	0.6084
-0.700		*****	0.2485	0.2321	0.1145	-0.5932	0.1145	0.1145	0.1145	-0.5932
-0.800		0.2986	0.2642	0.2390	0.1345	-0.5309	0.1345	0.1345	0.1345	-0.5309
-0.850		0.3051	0.2661	0.2516	0.1463	-0.5123	0.1463	0.1463	0.1463	-0.5123
-0.900		0.3004	0.2908	0.2679	0.1682	-0.4946	0.1682	0.1682	0.1682	-0.4946
-0.950		*****	*****	0.2574	0.1877	-0.1380	0.1877	0.1877	0.1877	-0.1380
-0.975		*****	0.2043	0.2051	0.1557	-0.0330	0.1557	0.1557	0.1557	-0.0330

Sharp Radius L.E.

Run No. = 90, Point No. = 2001

$C_N = 0.545$, $C_m = -0.1031$

$\alpha = 11.4^\circ$, $M_\infty = 0.900$

$R_{mac} = 6.0 \times 10^6$

Surface Pressures Near Leading Edge

● / ◆ upper, starboard/port
○ / ◇ lower, starboard/port

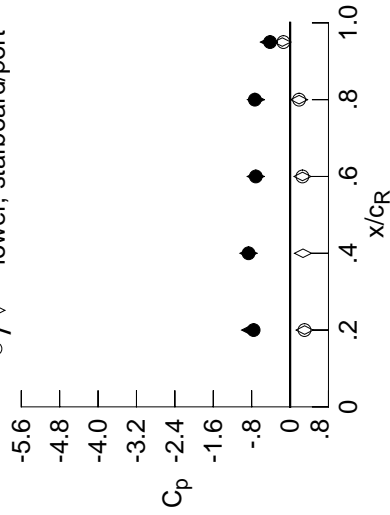

x/c_R	η	starb'd	port	starb'd	port
		$C_{p,u}$	$C_{p,l}$	$C_{p,u}$	$C_{p,l}$
0.20	0.90	-0.7593	-0.8323	0.3031	0.3004
0.40	0.95	-0.8651	-0.8674	0.2698	*****
0.60	0.95	-0.7133	-0.7151	0.2589	0.2574
0.80	0.95	-0.7338	-0.7118	0.1884	0.1877
0.95	0.95	-0.4167	-0.4402	-0.1616	-0.1380

Table D6. Continued.

η	$x/c_R = .2$		$x/c_R = .4$		$x/c_R = .6$		$x/c_R = .8$		$x/c_R = .95$	
	$C_{p,u}$	$C_{p,l}$	$C_{p,u}$	$C_{p,l}$	$C_{p,u}$	$C_{p,l}$	$C_{p,u}$	$C_{p,l}$	$C_{p,u}$	$C_{p,l}$
0.050	-0.2428	-0.2524	-0.0388	*****	*****	*****	*****	*****	*****	*****
0.100	-0.2475	-0.2560	-0.0507	*****	*****	*****	*****	*****	*****	*****
0.150	-0.2586	-0.2578	-0.0587	*****	*****	*****	*****	*****	*****	*****
0.200	-0.2648	-0.2587	-0.0705	*****	*****	*****	*****	*****	*****	*****
0.250	*****	-0.2630	-0.0829	-0.3505	-0.2461	*****	*****	*****	*****	*****
0.300	-0.2956	-0.2617	-0.1007	-0.3307	-0.2584	*****	*****	*****	*****	*****
0.350	-0.3204	-0.2625	-0.1115	-0.3169	-0.3082	*****	*****	*****	*****	*****
0.400	-0.3456	-0.2622	-0.1279	-0.3054	-0.4153	*****	*****	*****	*****	*****
0.450	-0.3652	-0.2548	-0.1255	-0.2939	-0.6372	*****	*****	*****	*****	*****
0.500	-0.3459	-0.2755	-0.1351	-0.2797	-0.7697	*****	*****	*****	*****	*****
0.525	*****	-0.2906	-0.1353	-0.2839	-0.8035	*****	*****	*****	*****	*****
0.550	-0.3046	-0.2953	-0.1448	-0.2948	-0.8340	*****	*****	*****	*****	*****
0.575	*****	-0.3062	-0.1760	-0.3344	-0.8897	*****	*****	*****	*****	*****
0.600	-0.2260	-0.3521	-0.3056	-0.4192	-0.9554	*****	*****	*****	*****	*****
0.625	*****	*****	-0.5243	-0.5585	-1.0419	*****	*****	*****	*****	*****
0.650	-0.5238	-0.7926	-0.8380	-0.7557	-0.8771	*****	*****	*****	*****	*****
0.675	*****	-0.9965	-1.0667	-0.9607	-0.6936	*****	*****	*****	*****	*****
0.700	-0.8518	-1.0848	-1.1860	-1.1212	-0.6427	*****	*****	*****	*****	*****
0.725	*****	-1.1004	*****	-0.9855	-0.5774	*****	*****	*****	*****	*****
0.750	-0.9249	-1.0748	*****	-0.8231	-0.5450	*****	*****	*****	*****	*****
0.775	*****	-1.0452	-1.0437	-0.8103	-0.5269	*****	*****	*****	*****	*****
0.800	-0.9272	-1.0108	-0.9581	-0.8161	*****	*****	*****	*****	*****	*****
0.825	*****	-0.9766	-0.8713	-0.8335	-0.5235	*****	*****	*****	*****	*****
0.850	-0.8887	-0.9501	-0.8407	-0.8279	-0.5288	*****	*****	*****	*****	*****
0.875	*****	-0.9201	-0.8225	-0.7697	-0.5348	*****	*****	*****	*****	*****
0.900	-0.8206	-0.9011	-0.8291	-0.7466	*****	*****	*****	*****	*****	*****
0.925	*****	-0.8883	-0.7679	-0.7667	-0.4646	*****	*****	*****	*****	*****
0.950	-0.9064	-0.8794	-0.7407	-0.7702	-0.4055	*****	*****	*****	*****	*****
0.975	*****	-0.8802	-0.7257	-0.7614	-0.3756	*****	*****	*****	*****	*****
-0.200	$C_{p,l}$	0.2672	0.2541	0.2877	*****	*****	*****	*****	*****	*****
-0.400	$C_{p,l}$	0.2595	0.2575	0.2567	0.0821	-0.6256	*****	*****	*****	*****
-0.600	$C_{p,l}$	*****	0.2733	0.2495	0.1140	-0.5993	*****	*****	*****	*****
-0.700	$C_{p,l}$	*****	0.2731	0.2517	0.1292	-0.5800	*****	*****	*****	*****
-0.800	$C_{p,l}$	0.3245	0.2880	0.2587	0.1519	-0.5176	*****	*****	*****	*****
-0.850	$C_{p,l}$	0.3245	0.2875	0.2691	0.1621	-0.4996	*****	*****	*****	*****
-0.900	$C_{p,l}$	0.3154	0.3057	0.2814	0.1824	-0.4761	*****	*****	*****	*****
-0.950	$C_{p,l}$	*****	*****	0.2615	0.1915	-0.1302	*****	*****	*****	*****
-0.975	$C_{p,l}$	*****	0.2014	0.1964	0.1495	-0.0341	*****	*****	*****	*****

Sharp Radius L.E.
 Run No. = 90, Point No. = 2002
 $C_N = 0.601$, $C_m = -0.1133$
 $\alpha = 12.4^\circ$, $M_\infty = 0.900$
 $R_{mac} = 6.0 \times 10^6$

Surface Pressures Near Leading Edge

● / ◆ upper, starboard/port
 ○ / ◇ lower, starboard/port

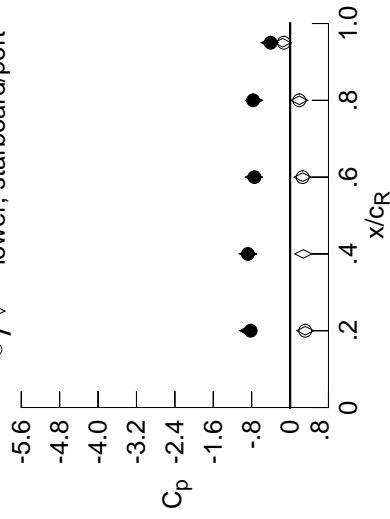

x/c_R	η	starb'd	port	starb'd	port
		$C_{p,u}$	$C_{p,l}$	$C_{p,u}$	$C_{p,l}$
0.20	0.90	-0.8206	-0.8734	0.3160	0.3154
0.40	0.95	-0.8794	-0.8803	0.2758	*****
0.60	0.95	-0.7407	-0.7558	0.2626	0.2615
0.80	0.95	-0.7702	-0.7512	0.1914	0.1915
0.95	0.95	-0.4055	-0.4279	-0.1551	-0.1302

Surface Pressures

● upper, starboard
 ○ lower, port

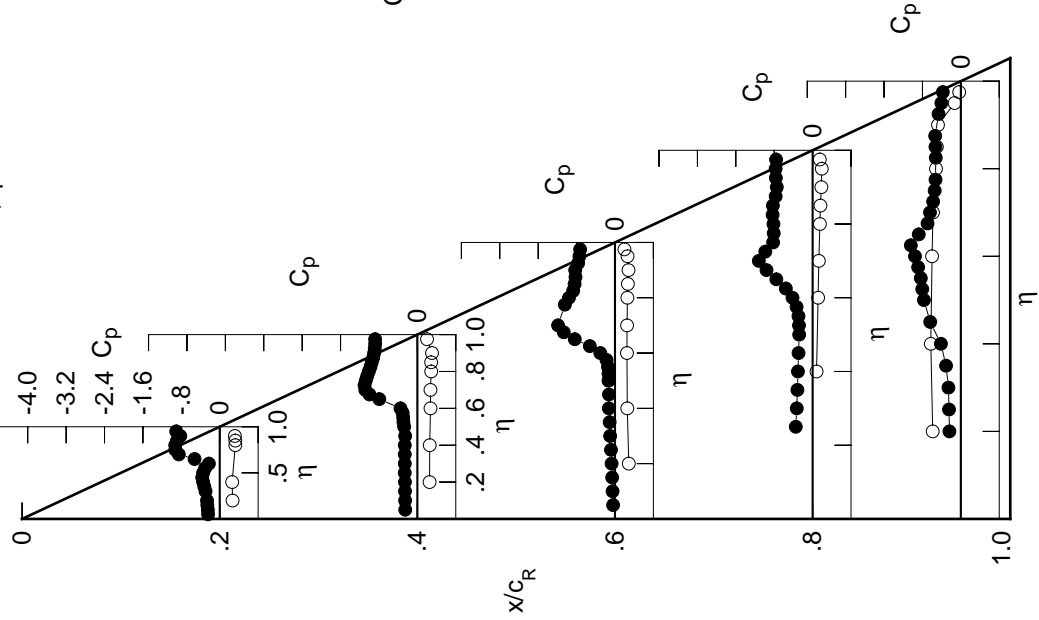

Table D6. Continued.

η	$x/c_R = .2$		$x/c_R = .4$		$x/c_R = .6$		$x/c_R = .8$		$x/c_R = .95$	
	$C_{p,u}$	$C_{p,l}$	$C_{p,u}$	$C_{p,l}$	$C_{p,u}$	$C_{p,l}$	$C_{p,u}$	$C_{p,l}$	$C_{p,u}$	$C_{p,l}$
0.050	-0.2536	-0.2818	-0.0623	*****	*****	*****	*****	*****	*****	*****
0.100	-0.2541	-0.2822	-0.0721	*****	*****	*****	*****	*****	*****	*****
0.150	-0.2675	-0.2844	-0.0852	*****	*****	*****	*****	*****	*****	*****
0.200	-0.2725	-0.2877	-0.0950	*****	*****	*****	*****	*****	*****	*****
0.250	*****	-0.2876	-0.1120	-0.3733	-0.2547	*****	*****	*****	*****	*****
0.300	-0.3017	-0.2907	-0.1275	-0.3501	-0.2278	*****	*****	*****	*****	*****
0.350	-0.3273	-0.2895	-0.1463	-0.3372	-0.2625	*****	*****	*****	*****	*****
0.400	-0.3571	-0.2902	-0.1597	-0.3241	-0.3457	*****	*****	*****	*****	*****
0.450	-0.3926	-0.2782	-0.1607	-0.3132	-0.5271	*****	*****	*****	*****	*****
0.500	-0.4049	-0.2743	-0.1904	-0.3158	-0.7331	*****	*****	*****	*****	*****
0.525	*****	-0.2748	-0.2114	-0.3330	-0.7967	*****	*****	*****	*****	*****
0.550	-0.3415	-0.3001	-0.2685	-0.3755	-0.8426	*****	*****	*****	*****	*****
0.575	*****	-0.3783	-0.3795	-0.4545	-0.8980	*****	*****	*****	*****	*****
0.600	-0.2539	-0.5618	-0.6222	-0.5872	-0.9674	*****	*****	*****	*****	*****
0.625	*****	*****	-0.8613	-0.7553	-0.8064	*****	*****	*****	*****	*****
0.650	-0.7086	-1.0550	-1.0881	-0.9383	-0.6417	*****	*****	*****	*****	*****
0.675	*****	-1.1607	-1.2131	-1.1029	-0.6288	*****	*****	*****	*****	*****
0.700	-0.9862	-1.1791	-1.2741	-1.1524	-0.5916	*****	*****	*****	*****	*****
0.725	*****	-1.1700	*****	-0.8732	-0.5471	*****	*****	*****	*****	*****
0.750	-1.0446	-1.1344	*****	-0.8556	-0.5305	*****	*****	*****	*****	*****
0.775	*****	-1.1001	-0.9899	-0.8457	-0.5143	*****	*****	*****	*****	*****
0.800	-1.0089	-1.0619	-0.9286	-0.8589	*****	*****	*****	*****	*****	*****
0.825	*****	-1.0177	-0.9069	-0.8800	-0.5207	*****	*****	*****	*****	*****
0.850	-0.9426	-0.9782	-0.9056	-0.9016	-0.5384	*****	*****	*****	*****	*****
0.875	*****	-0.9506	-0.8960	-0.8251	-0.5544	*****	*****	*****	*****	*****
0.900	-0.8755	-0.9279	-0.8706	-0.7704	*****	*****	*****	*****	*****	*****
0.925	*****	-0.9127	-0.8052	-0.7841	-0.4596	*****	*****	*****	*****	*****
0.950	-0.9599	-0.9006	-0.7949	-0.7927	-0.4136	*****	*****	*****	*****	*****
0.975	*****	-0.9017	-0.7837	-0.7938	-0.3846	*****	*****	*****	*****	*****
-0.200	$C_{p,l}$	0.3019	0.2780	0.3085	*****	*****	*****	*****	*****	*****
-0.400	0.2905	0.2882	0.2778	0.0986	-0.6117	*****	*****	*****	*****	*****
-0.600	*****	0.2989	0.2681	0.1321	0.5897	*****	*****	*****	*****	*****
-0.700	*****	0.2993	0.2717	0.1438	-0.5671	*****	*****	*****	*****	*****
-0.800	0.3488	0.3137	0.2744	0.1708	-0.5062	*****	*****	*****	*****	*****
-0.850	0.3456	0.3086	0.2857	0.1786	-0.4860	*****	*****	*****	*****	*****
-0.900	0.3297	0.3227	0.2938	0.1944	-0.4575	*****	*****	*****	*****	*****
-0.950	*****	*****	0.2649	0.1956	-0.1231	*****	*****	*****	*****	*****
-0.975	*****	0.1977	0.1871	0.1429	-0.0365	*****	*****	*****	*****	*****

Sharp Radius L.E.
 Run No. = 90, Point No. = 2003
 $C_N = 0.658$, $C_m = -0.1229$
 $\alpha = 13.5^\circ$, $M_\infty = 0.900$
 $R_{mac} = 6.0 \times 10^6$

Surface Pressures Near Leading Edge

● / ◆ upper, starboard/port
 ○ / ◇ lower, starboard/port

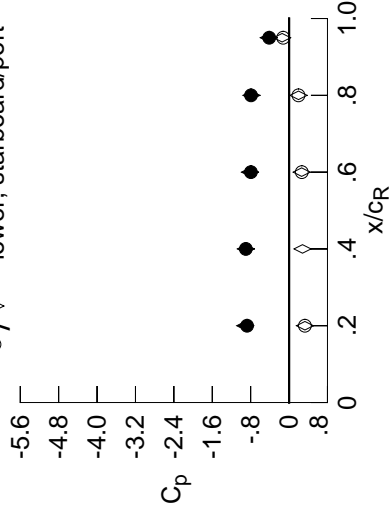

x/c_R	η	starb'd	port	starb'd	port
		$C_{p,u}$	$C_{p,l}$	$C_{p,u}$	$C_{p,l}$
0.20	0.90	-0.8755	-0.9134	0.3306	0.3297
0.40	0.95	-0.9006	-0.9001	0.2804	*****
0.60	0.95	-0.7949	-0.8143	0.2622	0.2649
0.80	0.95	-0.7927	-0.7842	0.1965	0.1956
0.95	0.95	-0.4136	-0.4233	-0.1447	-0.1231

Surface Pressures

● upper, starboard
 ○ lower, port

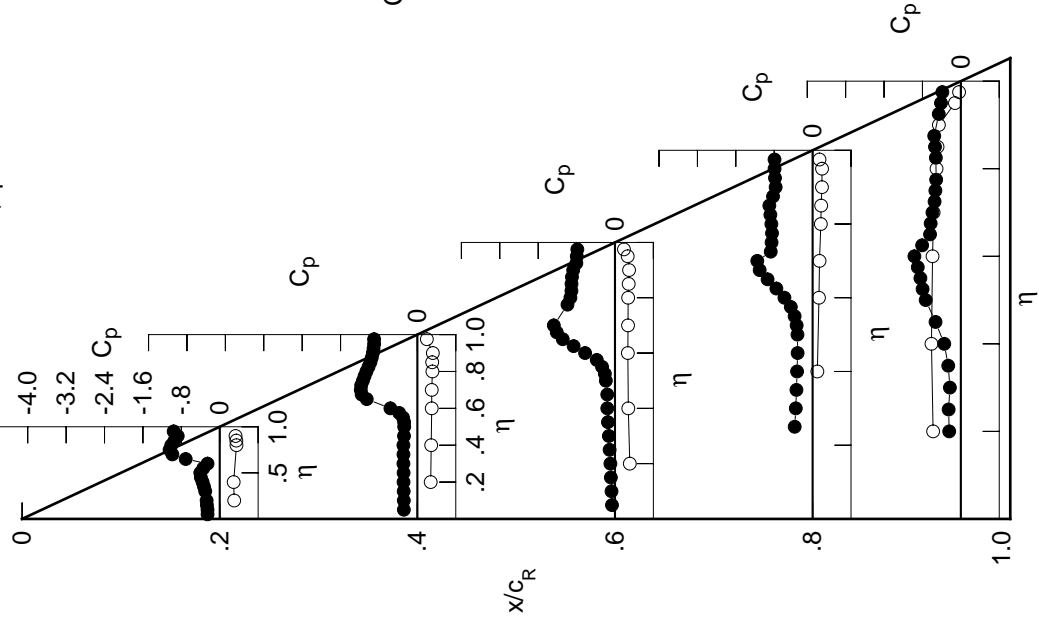

Table D6. Continued.

η	$x/c_R = .2$		$x/c_R = .4$		$x/c_R = .6$		$x/c_R = .8$		$x/c_R = .95$	
	$C_{p,u}$	$C_{p,u}$	$C_{p,u}$	$C_{p,u}$	$C_{p,u}$	$C_{p,u}$	$C_{p,u}$	$C_{p,u}$	$C_{p,u}$	$C_{p,u}$
0.050	-0.2737	-0.3044	-0.1060	*****	*****	*****	*****	*****	*****	*****
0.100	-0.2741	-0.3054	-0.1157	*****	*****	*****	*****	*****	*****	*****
0.150	-0.2823	-0.3086	-0.1299	*****	*****	*****	*****	*****	*****	*****
0.200	-0.2884	-0.3089	-0.1470	*****	*****	*****	*****	*****	*****	*****
0.250	*****	-0.3120	-0.1661	-0.3850	-0.2735	*****	*****	*****	*****	*****
0.300	-0.3033	-0.3111	-0.1920	-0.3669	-0.2436	*****	*****	*****	*****	*****
0.350	-0.3225	-0.3138	-0.2147	-0.3542	-0.2669	*****	*****	*****	*****	*****
0.400	-0.3446	-0.3109	-0.2385	-0.3414	-0.3397	*****	*****	*****	*****	*****
0.450	-0.3704	-0.3042	-0.2496	-0.3421	-0.4921	*****	*****	*****	*****	*****
0.500	-0.3768	-0.3041	-0.3066	-0.3660	-0.6887	*****	*****	*****	*****	*****
0.525	*****	-0.3260	-0.3632	-0.4094	-0.7729	*****	*****	*****	*****	*****
0.550	-0.3494	-0.3855	-0.4695	-0.4827	-0.8260	*****	*****	*****	*****	*****
0.575	*****	-0.5370	-0.6351	-0.5973	-0.8972	*****	*****	*****	*****	*****
0.600	-0.5854	-0.7614	-0.8655	-0.7457	-0.8555	*****	*****	*****	*****	*****
0.625	*****	*****	-1.0533	-0.9112	-0.6479	*****	*****	*****	*****	*****
0.650	-1.0767	-1.1812	-1.2111	-1.0667	-0.6394	*****	*****	*****	*****	*****
0.675	*****	-1.2612	-1.3070	-1.2013	-0.6314	*****	*****	*****	*****	*****
0.700	-1.0399	-1.2591	-1.3516	-0.9734	-0.5997	*****	*****	*****	*****	*****
0.725	*****	-1.2309	*****	-0.8982	-0.5678	*****	*****	*****	*****	*****
0.750	-1.0727	-1.2163	*****	-0.8874	-0.5485	*****	*****	*****	*****	*****
0.775	*****	-1.1796	-1.0229	-0.8926	-0.5165	*****	*****	*****	*****	*****
0.800	-1.0439	-1.1220	-0.9952	-0.9037	*****	*****	*****	*****	*****	*****
0.825	*****	-1.0601	-0.9836	-0.9381	-0.5105	*****	*****	*****	*****	*****
0.850	-1.0145	-1.0134	-0.9840	-0.9619	-0.5268	*****	*****	*****	*****	*****
0.875	*****	-0.9773	-0.9545	-0.8763	-0.5364	*****	*****	*****	*****	*****
0.900	-0.9299	-0.9498	-0.9111	-0.7906	*****	*****	*****	*****	*****	*****
0.925	*****	-0.9255	-0.8660	-0.7908	-0.4579	*****	*****	*****	*****	*****
0.950	-0.9990	-0.9104	-0.8580	-0.8059	-0.4057	*****	*****	*****	*****	*****
0.975	*****	-0.9062	-0.8536	-0.8075	-0.3784	*****	*****	*****	*****	*****
-0.200	$C_{p,l}$	0.3264	0.3029	0.3231	*****	*****	*****	*****	*****	*****
-0.400	$C_{p,l}$	0.3202	0.3079	0.2927	0.1133	-0.6068	*****	*****	*****	*****
-0.600	$C_{p,l}$	*****	0.3226	0.2866	0.1453	-0.5776	*****	*****	*****	*****
-0.700	$C_{p,l}$	*****	0.3233	0.2892	0.1617	-0.5605	*****	*****	*****	*****
-0.800	$C_{p,l}$	0.3701	0.3349	0.2924	0.1815	-0.4954	*****	*****	*****	*****
-0.850	$C_{p,l}$	0.3637	0.3269	0.3023	0.1923	-0.4748	*****	*****	*****	*****
-0.900	$C_{p,l}$	0.3415	0.3351	0.3032	0.2068	-0.4402	*****	*****	*****	*****
-0.950	$C_{p,l}$	*****	*****	0.2630	0.1972	-0.1210	*****	*****	*****	*****
-0.975	$C_{p,l}$	*****	0.1940	0.1763	0.1356	-0.0389	*****	*****	*****	*****

Sharp Radius L.E.
 Run No. = 90 , Point No. = 2004
 $C_N = 0.714$, $C_m = -0.1331$
 $\alpha = 14.5^\circ$, $M_\infty = 0.900$
 $R_{mac} = 6.0 \times 10^6$

Surface Pressures Near Leading Edge

● / ◆ upper, starboard/port
 ○ / ◇ lower, starboard/port

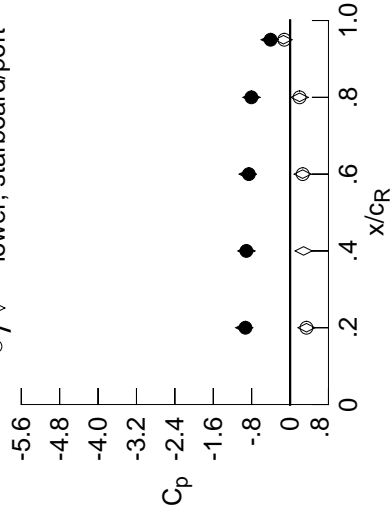

x/c_R	η	starb'd	port	starb'd	port
		$C_{p,u}$	$C_{p,l}$	$C_{p,u}$	$C_{p,l}$
0.20	0.90	-0.9299	-0.9549	0.3420	0.3415
0.40	0.95	-0.9104	-0.9105	0.2819	*****
0.60	0.95	-0.8580	-0.8840	0.2612	0.2630
0.80	0.95	-0.8059	-0.8045	0.1972	0.1972
0.95	0.95	-0.4057	-0.4257	-0.1385	-0.1210

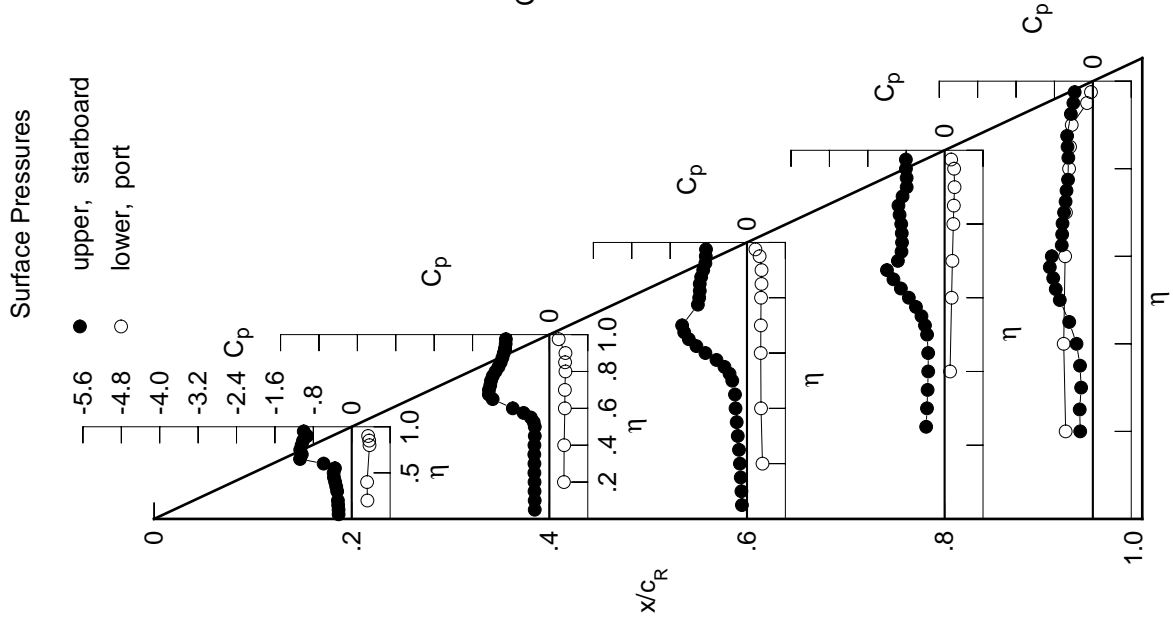

Table D6. Continued.

η	$x/c_R = .2$		$x/c_R = .4$		$x/c_R = .6$		$x/c_R = .8$		$x/c_R = .95$	
	$C_{p,u}$	$C_{p,l}$	$C_{p,u}$	$C_{p,l}$	$C_{p,u}$	$C_{p,l}$	$C_{p,u}$	$C_{p,l}$	$C_{p,u}$	$C_{p,l}$
0.050	-0.3005	-0.3301	-0.1906	*****	*****	*****	*****	*****	*****	*****
0.100	-0.2982	-0.3264	-0.2000	*****	*****	*****	*****	*****	*****	*****
0.150	-0.3079	-0.3337	-0.2209	*****	*****	*****	*****	*****	*****	*****
0.200	-0.3144	-0.3301	-0.2414	*****	*****	*****	*****	*****	*****	*****
0.250	*****	-0.3370	-0.2743	-0.4019	-0.3024	*****	*****	*****	*****	*****
0.300	-0.3254	-0.3331	-0.2990	-0.3837	-0.2644	*****	*****	*****	*****	*****
0.350	-0.3353	-0.3369	-0.3285	-0.3688	-0.2809	*****	*****	*****	*****	*****
0.400	-0.3441	-0.3330	-0.3444	-0.3648	-0.3536	*****	*****	*****	*****	*****
0.450	-0.3484	-0.3338	-0.3571	-0.3755	-0.4821	*****	*****	*****	*****	*****
0.500	-0.3308	-0.3612	-0.4445	-0.4387	-0.6560	*****	*****	*****	*****	*****
0.525	*****	-0.4161	-0.5324	-0.5039	-0.7482	*****	*****	*****	*****	*****
0.550	-0.3493	-0.5309	-0.6707	-0.6090	-0.8167	*****	*****	*****	*****	*****
0.575	*****	-0.7264	-0.8395	-0.7434	-0.8806	*****	*****	*****	*****	*****
0.600	-0.8823	-0.9473	-1.0350	-0.8915	-0.6699	*****	*****	*****	*****	*****
0.625	*****	*****	-1.1822	-1.0435	-0.6580	*****	*****	*****	*****	*****
0.650	-1.2104	-1.2856	-1.3071	-1.1751	-0.6541	*****	*****	*****	*****	*****
0.675	*****	-1.3525	-1.3832	-1.1825	-0.6464	*****	*****	*****	*****	*****
0.700	-1.2262	-1.3563	-1.2565	-0.9489	-0.6247	*****	*****	*****	*****	*****
0.725	*****	-1.2843	*****	-0.9324	-0.6070	*****	*****	*****	*****	*****
0.750	-1.1418	-1.2572	*****	-0.9355	-0.5798	*****	*****	*****	*****	*****
0.775	*****	-1.2261	-1.1011	-0.9509	-0.5295	*****	*****	*****	*****	*****
0.800	-1.0987	-1.1504	-1.1000	-0.9700	*****	*****	*****	*****	*****	*****
0.825	*****	-1.0821	-1.1065	-0.9873	-0.5023	*****	*****	*****	*****	*****
0.850	-1.0429	-1.0396	-1.1075	-0.9839	-0.5127	*****	*****	*****	*****	*****
0.875	*****	-1.0050	-1.0112	-0.8981	-0.5141	*****	*****	*****	*****	*****
0.900	-0.9749	-0.9807	-0.9628	-0.8184	*****	*****	*****	*****	*****	*****
0.925	*****	-0.9532	-0.9323	-0.8128	-0.4697	*****	*****	*****	*****	*****
0.950	-1.0310	-0.9325	-0.9317	-0.8220	-0.4117	*****	*****	*****	*****	*****
0.975	*****	-0.9232	-0.9205	-0.8242	-0.3825	*****	*****	*****	*****	*****

η	$x/c_R = .2$		$x/c_R = .4$		$x/c_R = .6$		$x/c_R = .8$		$x/c_R = .95$	
	$C_{p,u}$	$C_{p,l}$	$C_{p,u}$	$C_{p,l}$	$C_{p,u}$	$C_{p,l}$	$C_{p,u}$	$C_{p,l}$	$C_{p,u}$	$C_{p,l}$
-0.200	0.3531	0.3258	0.3393	*****	*****	*****	*****	*****	*****	*****
-0.400	0.3490	0.3280	0.3108	0.1303	-0.5988	*****	*****	*****	*****	*****
-0.600	*****	0.3455	0.3019	0.1575	-0.5684	*****	*****	*****	*****	*****
-0.700	*****	0.3457	0.3026	0.1754	-0.5503	*****	*****	*****	*****	*****
-0.800	0.3910	0.3547	0.3083	0.1943	-0.4866	*****	*****	*****	*****	*****
-0.850	0.3804	0.3442	0.3160	0.2062	-0.4628	*****	*****	*****	*****	*****
-0.900	0.3539	0.3461	0.3127	0.2193	-0.4250	*****	*****	*****	*****	*****
-0.950	*****	*****	0.2624	0.1986	-0.1179	*****	*****	*****	*****	*****
-0.975	*****	0.1877	0.1649	0.1274	-0.0440	*****	*****	*****	*****	*****

Sharp Radius L.E.
 Run No. = 90, Point No. = 2005
 $C_N = 0.769$, $C_m = -0.1414$
 $\alpha = 15.5^\circ$, $M_\infty = 0.900$
 $R_{mac} = 6.0 \times 10^6$

Surface Pressures Near Leading Edge

● / ◆ upper, starboard/port
 ○ / ◇ lower, starboard/port

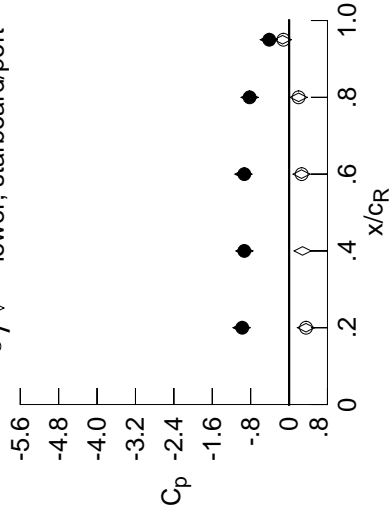

x/c_R	η	starb'd	port	starb'd	port
		$C_{p,u}$	$C_{p,l}$	$C_{p,u}$	$C_{p,l}$
0.20	0.90	-0.9749	-0.9912	0.3520	0.3539
0.40	0.95	-0.9325	-0.9318	0.2814	*****
0.60	0.95	-0.9317	-0.9516	0.2595	0.2624
0.80	0.95	-0.8220	-0.8235	0.1993	0.1986
0.95	0.95	-0.4117	-0.4223	-0.1355	-0.1179

Table D6. Continued.

η	$x/c_R = .2$		$x/c_R = .4$		$x/c_R = .6$		$x/c_R = .8$		$x/c_R = .95$	
	$C_{p,u}$	$C_{p,l}$	$C_{p,u}$	$C_{p,l}$	$C_{p,u}$	$C_{p,l}$	$C_{p,u}$	$C_{p,l}$	$C_{p,u}$	$C_{p,l}$
0.050	-0.3253	-0.3609	-0.3039	*****	*****	*****	*****	*****	*****	*****
0.100	-0.3230	-0.3616	-0.3102	*****	*****	*****	*****	*****	*****	*****
0.150	-0.3332	-0.3645	-0.3283	*****	*****	*****	*****	*****	*****	*****
0.200	-0.3420	-0.3661	-0.3500	*****	*****	*****	*****	*****	*****	*****
0.250	*****	-0.3673	-0.3713	-0.4156	-0.3154	*****	*****	*****	*****	*****
0.300	-0.3514	-0.3679	-0.3872	-0.4021	-0.2871	*****	*****	*****	*****	*****
0.350	-0.3622	-0.3702	-0.3986	-0.3959	-0.3040	*****	*****	*****	*****	*****
0.400	-0.3602	-0.3743	-0.4126	-0.4022	-0.3712	*****	*****	*****	*****	*****
0.450	-0.3434	-0.3856	-0.4413	-0.4385	-0.4930	*****	*****	*****	*****	*****
0.500	-0.3121	-0.4534	-0.5733	-0.5381	-0.6535	*****	*****	*****	*****	*****
0.525	*****	-0.5545	-0.6886	-0.6328	-0.7473	*****	*****	*****	*****	*****
0.550	-0.5032	-0.7092	-0.8377	-0.7488	-0.8290	*****	*****	*****	*****	*****
0.575	*****	-0.9138	-0.9985	-0.8867	-0.7387	*****	*****	*****	*****	*****
0.600	-1.0876	-1.1042	-1.1599	-1.0197	-0.6804	*****	*****	*****	*****	*****
0.625	*****	*****	-1.2826	-1.1467	-0.6785	*****	*****	*****	*****	*****
0.650	-1.2541	-1.3859	-1.3796	-1.2550	-0.6850	*****	*****	*****	*****	*****
0.675	*****	-1.4358	-1.2474	-1.0580	-0.6843	*****	*****	*****	*****	*****
0.700	-1.3108	-1.4393	-1.1532	-0.9829	-0.6786	*****	*****	*****	*****	*****
0.725	*****	-1.3302	*****	-0.9777	-0.6696	*****	*****	*****	*****	*****
0.750	-1.2086	-1.2624	*****	-0.9840	-0.6448	*****	*****	*****	*****	*****
0.775	*****	-1.2117	-1.1537	-0.9901	-0.5792	*****	*****	*****	*****	*****
0.800	-1.1561	-1.1445	-1.1798	-0.9960	*****	*****	*****	*****	*****	*****
0.825	*****	-1.0946	-1.2158	-0.9927	-0.5058	*****	*****	*****	*****	*****
0.850	-1.0751	-1.0660	-1.1834	-0.9758	-0.4962	*****	*****	*****	*****	*****
0.875	*****	-1.0462	-1.0319	-0.9096	-0.5141	*****	*****	*****	*****	*****
0.900	-1.0124	-1.0215	-0.9926	-0.8362	*****	*****	*****	*****	*****	*****
0.925	*****	-0.9862	-0.9805	-0.8257	-0.4996	*****	*****	*****	*****	*****
0.950	-1.0585	-0.9631	-0.9787	-0.8300	-0.4463	*****	*****	*****	*****	*****
0.975	*****	-0.9495	-0.9710	-0.8285	-0.4105	*****	*****	*****	*****	*****
-0.200	0.3877	0.3524	0.3623	*****	-0.5411	*****	*****	*****	*****	*****
-0.400	0.3803	0.3516	0.3328	0.1462	-0.5854	*****	*****	*****	*****	*****
-0.600	*****	0.3716	0.3255	0.1791	-0.5576	*****	*****	*****	*****	*****
-0.700	*****	0.3692	0.3261	0.1938	-0.5356	*****	*****	*****	*****	*****
-0.800	0.4156	0.3799	0.3289	0.2142	-0.4683	*****	*****	*****	*****	*****
-0.850	0.3999	0.3607	0.3332	0.2223	-0.4485	*****	*****	*****	*****	*****
-0.900	0.3676	0.3609	0.3247	0.2300	-0.4085	*****	*****	*****	*****	*****
-0.950	*****	*****	0.2637	0.2019	-0.1137	*****	*****	*****	*****	*****
-0.975	*****	0.1843	0.1590	0.1222	-0.0509	*****	*****	*****	*****	*****

Sharp Radius L.E.
 Run No. = 90 , Point No. = 2006
 $C_N = 0.825$, $C_m = -0.1518$
 $\alpha = 16.5^\circ$, $M_\infty = 0.900$
 $R_{mac} = 6.0 \times 10^6$

Surface Pressures Near Leading Edge

● / ◆ upper, starboard/port
 ○ / ◇ lower, starboard/port

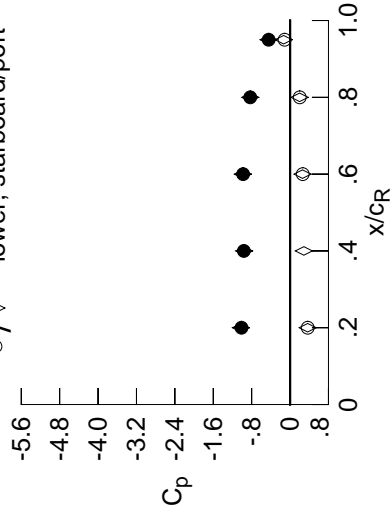

x/c_R	η	starb'd	port	starb'd	port
		$C_{p,u}$	$C_{p,l}$	$C_{p,u}$	$C_{p,l}$
0.20	0.90	-1.0124	-1.0236	0.3661	0.3676
0.40	0.95	-0.9631	-0.9578	0.2870	*****
0.60	0.95	-0.9787	-0.9839	0.2589	0.2637
0.80	0.95	-0.8300	-0.8297	0.1994	0.2019
0.95	0.95	-0.4463	-0.4500	-0.1342	-0.1137

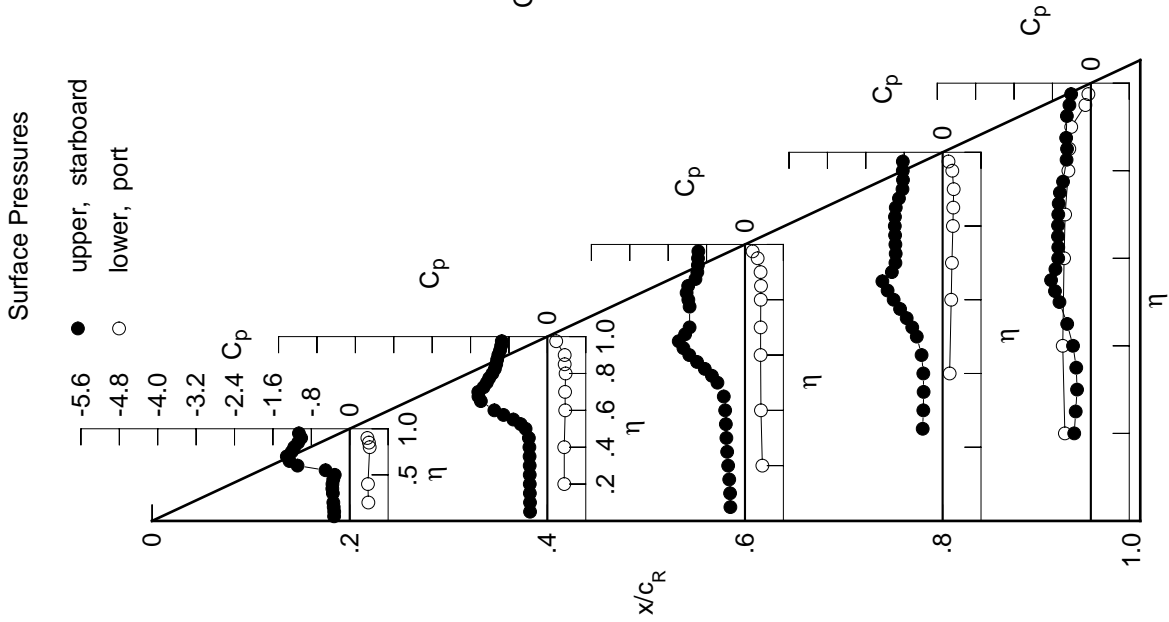

Table D6. Continued.

η	$x/c_R = .2$		$x/c_R = .4$		$x/c_R = .6$		$x/c_R = .8$		$x/c_R = .95$	
	$C_{p,u}$	$C_{p,l}$	$C_{p,u}$	$C_{p,l}$	$C_{p,u}$	$C_{p,l}$	$C_{p,u}$	$C_{p,l}$	$C_{p,u}$	$C_{p,l}$
0.050	-0.3502	-0.3979	-0.3966	*****	*****	*****	*****	*****	*****	*****
0.100	-0.3509	-0.3964	-0.4013	*****	*****	*****	*****	*****	*****	*****
0.150	-0.3595	-0.4013	-0.4119	*****	*****	*****	*****	*****	*****	*****
0.200	-0.3648	-0.4013	-0.4228	*****	*****	*****	*****	*****	*****	*****
0.250	*****	-0.4048	-0.4306	-0.4185	-0.3255	*****	*****	*****	*****	*****
0.300	-0.3759	-0.4032	-0.4381	-0.4139	-0.2974	*****	*****	*****	*****	*****
0.350	-0.3848	-0.4075	-0.4496	-0.4215	-0.3103	*****	*****	*****	*****	*****
0.400	-0.3823	-0.4168	-0.4728	-0.4507	-0.3729	*****	*****	*****	*****	*****
0.450	-0.3691	-0.4522	-0.5296	-0.5204	-0.4791	*****	*****	*****	*****	*****
0.500	-0.3938	-0.5750	-0.7040	-0.6667	-0.6395	*****	*****	*****	*****	*****
0.525	*****	-0.7125	-0.8346	-0.7735	-0.7394	*****	*****	*****	*****	*****
0.550	-0.7994	-0.8841	-0.9822	-0.8947	-0.8305	*****	*****	*****	*****	*****
0.575	*****	-1.0743	-1.1259	-1.0199	-0.7279	*****	*****	*****	*****	*****
0.600	-1.2389	-1.2270	-1.2590	-1.1364	-0.7225	*****	*****	*****	*****	*****
0.625	*****	*****	-1.3550	-1.2403	-0.7253	*****	*****	*****	*****	*****
0.650	-1.3075	-1.4555	-1.3056	-1.3180	-0.7249	*****	*****	*****	*****	*****
0.675	*****	-1.4997	-1.1655	-1.0698	-0.7152	*****	*****	*****	*****	*****
0.700	-1.3278	-1.4438	-1.1540	-1.0403	-0.7088	*****	*****	*****	*****	*****
0.725	*****	-1.3220	*****	-1.0315	-0.7034	*****	*****	*****	*****	*****
0.750	-1.2435	-1.2676	*****	-1.0274	-0.6588	*****	*****	*****	*****	*****
0.775	*****	-1.2157	-1.1715	-1.0103	-0.5870	*****	*****	*****	*****	*****
0.800	-1.1928	-1.1675	-1.2178	-1.0009	*****	*****	*****	*****	*****	*****
0.825	*****	-1.1308	-1.2509	-1.0000	-0.5109	*****	*****	*****	*****	*****
0.850	-1.1037	-1.1068	-1.1731	-0.9942	-0.4946	*****	*****	*****	*****	*****
0.875	*****	-1.0831	-1.0251	-0.9366	-0.5145	*****	*****	*****	*****	*****
0.900	-1.0477	-1.0577	-1.0311	-0.8670	*****	*****	*****	*****	*****	*****
0.925	*****	-1.0211	-1.0409	-0.8515	-0.5027	*****	*****	*****	*****	*****
0.950	-1.0860	-0.9992	-1.0421	-0.8540	-0.4507	*****	*****	*****	*****	*****
0.975	*****	-0.9884	-1.0326	-0.8529	-0.4210	*****	*****	*****	*****	*****

Sharp Radius L.E.
 Run No. = 90 , Point No. = 2007
 $C_N = 0.885$, $C_m = -0.1651$
 $\alpha = 17.5^\circ$, $M_\infty = 0.900$
 $R_{mac} = 6.0 \times 10^6$

Surface Pressures Near Leading Edge

● / ◆ upper, starboard/port
 ○ / ◇ lower, starboard/port

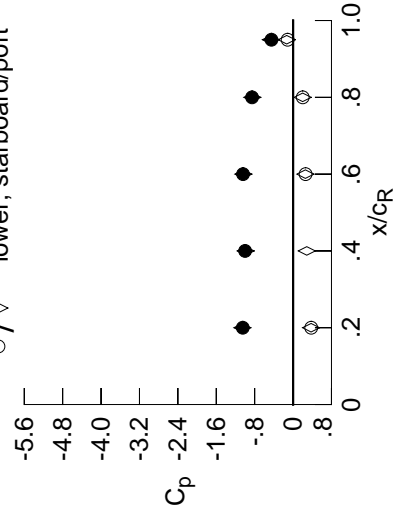

x/c_R	η	starb'd	port	$C_{p,u}$	starb'd	port	$C_{p,l}$
0.20	0.90	-1.0477	-1.0565	0.3755	0.3781	*****	*****
0.40	0.95	-0.9992	-0.9878	0.2853	*****	*****	*****
0.60	0.95	-1.0421	-1.0358	0.2571	0.2611	*****	*****
0.80	0.95	-0.8540	-0.8496	0.1998	0.2018	*****	*****
0.95	0.95	-0.4507	-0.4628	-0.1317	-0.1132	*****	*****

Surface Pressures

● upper, starboard
 ○ lower, port

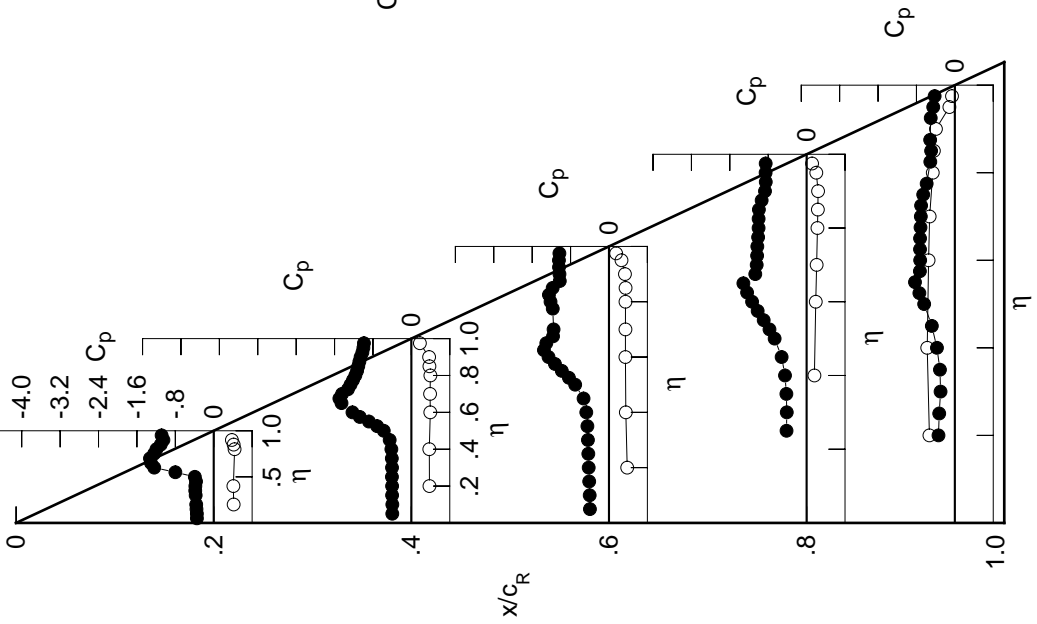

η	$C_{p,l}$	$C_{p,l}$	$C_{p,l}$	$C_{p,l}$	$C_{p,l}$	$C_{p,l}$
-0.200	0.4151	0.3766	0.3800	*****	-0.5300	*****
-0.400	0.4096	0.3736	0.3510	0.1621	-0.5755	*****
-0.600	*****	0.3943	0.3427	0.1903	-0.5471	*****
-0.700	*****	0.3897	0.3429	0.2088	-0.5252	*****
-0.800	0.4346	0.3957	0.3440	0.2255	-0.4598	*****
-0.850	0.4156	0.3763	0.3453	0.2346	-0.4366	*****
-0.900	0.3781	0.3694	0.3329	0.2383	-0.3940	*****
-0.950	*****	*****	0.2611	0.2018	-0.1132	*****
-0.975	*****	0.1775	0.1491	0.1133	-0.0592	*****

Table D6. Continued.

η	$x/c_R = .2$		$x/c_R = .4$		$x/c_R = .6$		$x/c_R = .8$		$x/c_R = .95$	
	$C_{p,u}$	$C_{p,l}$	$C_{p,u}$	$C_{p,l}$	$C_{p,u}$	$C_{p,l}$	$C_{p,u}$	$C_{p,l}$	$C_{p,u}$	$C_{p,l}$
0.050	-0.3807	-0.4362	-0.4560	-0.4560	-0.4560	-0.4560	-0.4560	-0.4560	-0.4560	-0.4560
0.100	-0.3802	-0.4351	-0.4566	-0.4566	-0.4566	-0.4566	-0.4566	-0.4566	-0.4566	-0.4566
0.150	-0.3895	-0.4386	-0.4619	-0.4619	-0.4619	-0.4619	-0.4619	-0.4619	-0.4619	-0.4619
0.200	-0.3950	-0.4386	-0.4673	-0.4673	-0.4673	-0.4673	-0.4673	-0.4673	-0.4673	-0.4673
0.250	-0.4052	-0.4446	-0.4723	-0.4345	-0.4345	-0.4345	-0.4345	-0.4345	-0.4345	-0.4345
0.300	-0.4097	-0.4529	-0.4982	-0.4564	-0.4564	-0.4564	-0.4564	-0.4564	-0.4564	-0.4564
0.350	-0.4046	-0.4739	-0.5372	-0.5035	-0.5035	-0.5035	-0.5035	-0.5035	-0.5035	-0.5035
0.400	-0.4152	-0.5414	-0.6297	-0.6063	-0.6063	-0.6063	-0.6063	-0.6063	-0.6063	-0.6063
0.450	-0.5862	-0.7232	-0.8365	-0.7872	-0.7872	-0.7872	-0.7872	-0.7872	-0.7872	-0.7872
0.500	-0.8788	-0.9728	-0.9006	-0.7699	-0.7699	-0.7699	-0.7699	-0.7699	-0.7699	-0.7699
0.525	-1.0610	-1.0453	-1.1075	-1.0198	-1.0198	-1.0198	-1.0198	-1.0198	-1.0198	-1.0198
0.550	-1.2039	-1.2039	-1.2277	-1.1294	-1.1294	-1.1294	-1.1294	-1.1294	-1.1294	-1.1294
0.575	-1.3463	-1.3236	-1.3342	-1.2304	-1.2304	-1.2304	-1.2304	-1.2304	-1.2304	-1.2304
0.600	-1.4014	-1.4014	-1.3160	-0.7711	-0.7711	-0.7711	-0.7711	-0.7711	-0.7711	-0.7711
0.625	-1.4987	-1.2082	-1.2586	-0.7662	-0.7662	-0.7662	-0.7662	-0.7662	-0.7662	-0.7662
0.650	-1.4559	-1.1796	-1.0976	-0.7498	-0.7498	-0.7498	-0.7498	-0.7498	-0.7498	-0.7498
0.675	-1.3280	-1.1750	-1.0823	-0.7477	-0.7477	-0.7477	-0.7477	-0.7477	-0.7477	-0.7477
0.700	-1.2992	-1.0734	-0.7322	-0.7322	-0.7322	-0.7322	-0.7322	-0.7322	-0.7322	-0.7322
0.725	-1.2528	-1.2888	-1.0637	-0.6569	-0.6569	-0.6569	-0.6569	-0.6569	-0.6569	-0.6569
0.750	-1.2840	-1.1951	-1.0480	-0.5806	-0.5806	-0.5806	-0.5806	-0.5806	-0.5806	-0.5806
0.775	-1.1834	-1.2578	-1.2460	-1.0448	-1.0448	-1.0448	-1.0448	-1.0448	-1.0448	-1.0448
0.800	-1.1881	-1.2498	-1.0493	-0.5163	-0.5163	-0.5163	-0.5163	-0.5163	-0.5163	-0.5163
0.825	-1.1215	-1.1395	-1.1692	-1.0506	-1.0506	-1.0506	-1.0506	-1.0506	-1.0506	-1.0506
0.850	-1.1166	-1.1166	-1.0467	-0.9846	-0.9846	-0.9846	-0.9846	-0.9846	-0.9846	-0.9846
0.875	-1.0766	-1.0877	-1.0771	-0.9070	-0.9070	-0.9070	-0.9070	-0.9070	-0.9070	-0.9070
0.900	-1.0538	-1.0911	-0.8925	-0.5106	-0.5106	-0.5106	-0.5106	-0.5106	-0.5106	-0.5106
0.925	-1.1191	-1.0372	-1.0893	-0.8874	-0.8874	-0.8874	-0.8874	-0.8874	-0.8874	-0.8874
0.950	-1.0283	-1.0790	-0.8860	-0.4236	-0.4236	-0.4236	-0.4236	-0.4236	-0.4236	-0.4236
0.975	0.4459	0.3981	0.3966	-0.5182	-0.5182	-0.5182	-0.5182	-0.5182	-0.5182	-0.5182
-0.200	0.4397	0.3978	0.3706	0.1781	0.1781	0.1781	0.1781	0.1781	0.1781	0.1781
-0.400	0.4133	0.3589	0.2090	-0.5360	-0.5360	-0.5360	-0.5360	-0.5360	-0.5360	-0.5360
-0.600	0.4135	0.3614	0.2225	-0.5152	-0.5152	-0.5152	-0.5152	-0.5152	-0.5152	-0.5152
-0.800	0.4543	0.4168	0.3610	0.2385	0.2385	0.2385	0.2385	0.2385	0.2385	0.2385
-0.850	0.4313	0.3924	0.3603	0.2482	0.2482	0.2482	0.2482	0.2482	0.2482	0.2482
-0.900	0.3889	0.3803	0.3423	0.2483	0.2483	0.2483	0.2483	0.2483	0.2483	0.2483
-0.950	0.2601	0.2601	0.2601	0.2003	0.2003	0.2003	0.2003	0.2003	0.2003	0.2003
-0.975	0.1719	0.1398	0.1041	-0.0637	-0.0637	-0.0637	-0.0637	-0.0637	-0.0637	-0.0637

Sharp Radius L.E.
 Run No. = 90 , Point No. = 2008
 $C_N = 0.943$, $C_m = -0.1758$
 $\alpha = 18.6^\circ$, $M_\infty = 0.900$
 $R_{mac} = 6.0 \times 10^6$

Surface Pressures Near Leading Edge

● / ◆ upper, starboard/port
 ○ / ◇ lower, starboard/port

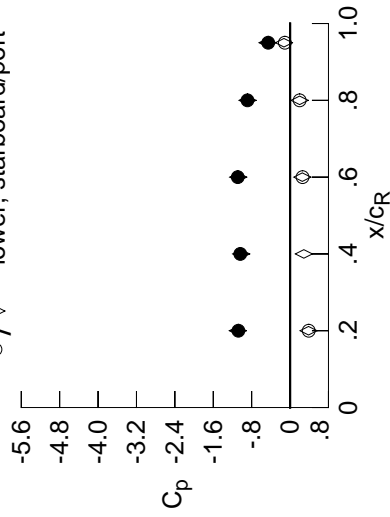

x/c_R	η	starb'd	port	$C_{p,u}$	starb'd	port	$C_{p,l}$
0.20	0.90	-1.0766	-1.0886	0.3847	0.3889	0.3889	0.3889
0.40	0.95	-1.0372	-1.0182	0.2873	0.2873	0.2873	0.2873
0.60	0.95	-1.0893	-1.0808	0.2552	0.2601	0.2601	0.2601
0.80	0.95	-0.8874	-0.8862	0.1992	0.2003	0.2003	0.2003
0.95	0.95	-0.4556	-0.4695	-0.1275	-0.1088	-0.1088	-0.1088

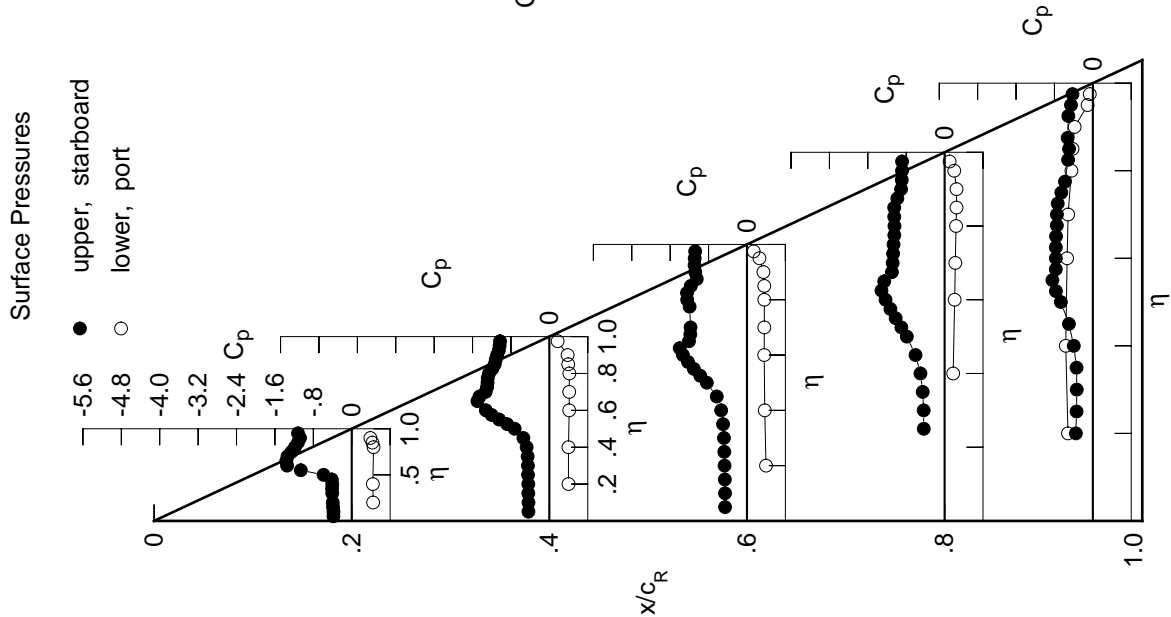

Table D6. Continued.

η	$x/c_R = .2$		$x/c_R = .4$		$x/c_R = .6$		$x/c_R = .8$		$x/c_R = .95$	
	$C_{p,u}$	$C_{p,l}$	$C_{p,u}$	$C_{p,l}$	$C_{p,u}$	$C_{p,l}$	$C_{p,u}$	$C_{p,l}$	$C_{p,u}$	$C_{p,l}$
0.050	-0.4135	-0.4680	-0.4872	*****	*****	*****	*****	*****	*****	*****
0.100	-0.4123	-0.4696	-0.4897	*****	*****	*****	*****	*****	*****	*****
0.150	-0.4204	-0.4727	-0.4933	*****	*****	*****	*****	*****	*****	*****
0.200	-0.4262	-0.4748	-0.4971	*****	*****	*****	*****	*****	*****	*****
0.250	*****	-0.4774	-0.5022	-0.4782	-0.4782	-0.4782	-0.4782	-0.4782	-0.4782	-0.4782
0.300	-0.4352	-0.4826	-0.5161	-0.4866	-0.4866	-0.4866	-0.4866	-0.4866	-0.4866	-0.4866
0.350	-0.4386	-0.4975	-0.5431	-0.5206	-0.5206	-0.5206	-0.5206	-0.5206	-0.5206	-0.5206
0.400	-0.4430	-0.5389	-0.6106	-0.5924	-0.5924	-0.5924	-0.5924	-0.5924	-0.5924	-0.5924
0.450	-0.5095	-0.6496	-0.7379	-0.7204	-0.7204	-0.7204	-0.7204	-0.7204	-0.7204	-0.7204
0.500	-0.8105	-0.8778	-0.9670	-0.9135	-0.9135	-0.9135	-0.9135	-0.9135	-0.9135	-0.9135
0.525	*****	-1.0323	-1.0907	-1.0217	-1.0217	-1.0217	-1.0217	-1.0217	-1.0217	-1.0217
0.550	-1.2147	-1.1749	-1.2072	-1.1251	-1.1251	-1.1251	-1.1251	-1.1251	-1.1251	-1.1251
0.575	*****	-1.3007	-1.3013	-1.2230	-1.2230	-1.2230	-1.2230	-1.2230	-1.2230	-1.2230
0.600	-1.4052	-1.3904	-1.3893	-1.3045	-1.3045	-1.3045	-1.3045	-1.3045	-1.3045	-1.3045
0.625	*****	*****	-1.3659	-1.3771	-1.3771	-1.3771	-1.3771	-1.3771	-1.3771	-1.3771
0.650	-1.3925	-1.4664	-1.2143	-1.1892	-1.1892	-1.1892	-1.1892	-1.1892	-1.1892	-1.1892
0.675	*****	-1.2958	-1.2043	-1.1354	-1.1354	-1.1354	-1.1354	-1.1354	-1.1354	-1.1354
0.700	-1.3352	-1.2721	-1.2015	-1.1331	-1.1331	-1.1331	-1.1331	-1.1331	-1.1331	-1.1331
0.725	*****	-1.2777	*****	-1.1237	-1.1237	-1.1237	-1.1237	-1.1237	-1.1237	-1.1237
0.750	-1.2306	-1.2942	*****	-1.1141	-1.1141	-1.1141	-1.1141	-1.1141	-1.1141	-1.1141
0.775	*****	-1.3153	-1.2234	-1.1020	-1.1020	-1.1020	-1.1020	-1.1020	-1.1020	-1.1020
0.800	-1.1860	-1.3058	-1.2655	-1.1019	-1.1019	-1.1019	-1.1019	-1.1019	-1.1019	-1.1019
0.825	*****	-1.2528	-1.2555	-1.1078	-1.1078	-1.1078	-1.1078	-1.1078	-1.1078	-1.1078
0.850	-1.1464	-1.2035	-1.1927	-1.1110	-1.1110	-1.1110	-1.1110	-1.1110	-1.1110	-1.1110
0.875	*****	-1.1544	-1.0830	-1.0419	-1.0419	-1.0419	-1.0419	-1.0419	-1.0419	-1.0419
0.900	-1.1076	-1.1134	-1.1188	-0.9561	-0.9561	-0.9561	-0.9561	-0.9561	-0.9561	-0.9561
0.925	*****	-1.0899	-1.1272	-0.9380	-0.9380	-0.9380	-0.9380	-0.9380	-0.9380	-0.9380
0.950	-1.1521	-1.0794	-1.1253	-0.9299	-0.9299	-0.9299	-0.9299	-0.9299	-0.9299	-0.9299
0.975	*****	-1.0726	-1.1174	-0.9239	-0.9239	-0.9239	-0.9239	-0.9239	-0.9239	-0.9239

η	$C_{p,i}$		$C_{p,l}$		$C_{p,i}$		$C_{p,l}$	
	port	starb'd	port	starb'd	port	starb'd	port	starb'd
-0.200	0.4766	0.4258	0.4187	*****	*****	*****	-0.5037	*****
-0.400	0.4711	0.4243	0.3912	0.2008	0.2008	0.2008	-0.5518	*****
-0.600	*****	0.4372	0.3822	0.2251	0.2251	0.2251	-0.5226	*****
-0.700	*****	0.4380	0.3813	0.2410	0.2410	0.2410	-0.5036	*****
-0.800	0.4748	0.4366	0.3805	0.2539	0.2539	0.2539	-0.4317	*****
-0.850	0.4483	0.4089	0.3784	0.2619	0.2619	0.2619	-0.4099	*****
-0.900	0.4003	0.3906	0.3518	0.2579	0.2579	0.2579	-0.3627	*****
-0.950	*****	*****	0.2613	0.2002	0.2002	0.2002	-0.1043	*****
-0.975	*****	0.1680	0.1340	0.0951	0.0951	0.0951	-0.0673	*****

Sharp Radius L.E.
 Run No. = 90 , Point No. = 2009
 $C_N = 1.003$, $C_m = -0.1885$
 $\alpha = 19.6^\circ$, $M_\infty = 0.900$
 $R_{mac} = 6.0 \times 10^6$

Surface Pressures Near Leading Edge

● / ◆ upper, starboard/port
 ○ / ◇ lower, starboard/port

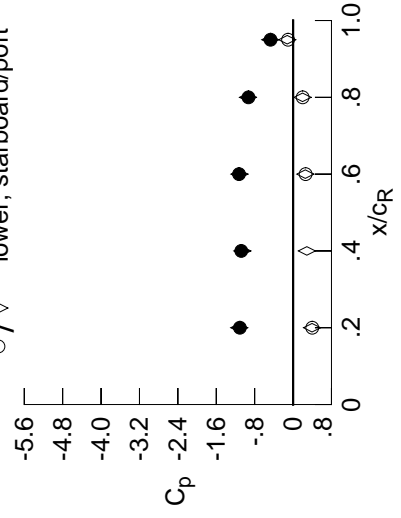

x/c_R	η	starb'd	port	starb'd	port
0.20	0.90	-1.1076	-1.1216	0.3955	0.4003
0.40	0.95	-1.0794	-1.0573	0.2876	*****
0.60	0.95	-1.1253	-1.1173	0.2552	0.2613
0.80	0.95	-0.9299	-0.9388	0.1979	0.2002
0.95	0.95	-0.4693	-0.4749	-0.1214	-0.1043

Table D6. Continued.

η	$x/c_R = 0.2$		$x/c_R = 0.4$		$x/c_R = 0.6$		$x/c_R = 0.8$		$x/c_R = 0.95$	
	$C_{p,u}$	$C_{p,u}$	$C_{p,u}$	$C_{p,u}$	$C_{p,u}$	$C_{p,u}$	$C_{p,u}$	$C_{p,u}$	$C_{p,u}$	$C_{p,u}$
0.050	-0.4442	-0.4991	-0.5223	*****	*****	*****	*****	*****	*****	*****
0.100	-0.4447	-0.5000	-0.5229	*****	*****	*****	*****	*****	*****	*****
0.150	-0.4520	-0.5035	-0.5260	*****	*****	*****	*****	*****	*****	*****
0.200	-0.4574	-0.5034	-0.5291	*****	*****	*****	*****	*****	*****	*****
0.250	*****	-0.5096	-0.5391	-0.5218	-0.3584	*****	*****	*****	*****	*****
0.300	-0.4668	-0.5195	-0.5585	-0.5458	-0.4459	*****	*****	*****	*****	*****
0.350	-0.4777	-0.5483	-0.6070	-0.5935	-0.5013	*****	*****	*****	*****	*****
0.400	-0.5108	-0.6201	-0.7029	-0.6841	-0.5804	*****	*****	*****	*****	*****
0.450	-0.6559	-0.7850	-0.8661	-0.8236	-0.6945	*****	*****	*****	*****	*****
0.500	-1.0005	-1.0320	-1.0909	-1.0146	-0.8684	*****	*****	*****	*****	*****
0.525	*****	-1.1662	-1.1978	-1.1126	-0.9351	*****	*****	*****	*****	*****
0.550	-1.3119	-1.2775	-1.2917	-1.2067	-0.8498	*****	*****	*****	*****	*****
0.575	*****	-1.3697	-1.3669	-1.2926	-0.8479	*****	*****	*****	*****	*****
0.600	-1.3630	-1.4323	-1.4348	-1.3617	-0.8584	*****	*****	*****	*****	*****
0.625	*****	*****	-1.3367	-1.4091	-0.8566	*****	*****	*****	*****	*****
0.650	-1.3568	-1.3105	-1.2483	-1.2035	-0.8488	*****	*****	*****	*****	*****
0.675	*****	-1.2472	-1.2414	-1.1840	-0.8392	*****	*****	*****	*****	*****
0.700	-1.3057	-1.2450	-1.2387	-1.1839	-0.8344	*****	*****	*****	*****	*****
0.725	*****	-1.2421	*****	-1.1752	-0.8220	*****	*****	*****	*****	*****
0.750	-1.2634	-1.2477	*****	-1.1727	-0.7571	*****	*****	*****	*****	*****
0.775	*****	-1.2692	-1.2457	-1.1678	-0.6660	*****	*****	*****	*****	*****
0.800	-1.2225	-1.2831	-1.2802	-1.1716	*****	*****	*****	*****	*****	*****
0.825	*****	-1.2525	-1.2803	-1.1821	-0.5616	*****	*****	*****	*****	*****
0.850	-1.1767	-1.2069	-1.2219	-1.1850	-0.5154	*****	*****	*****	*****	*****
0.875	*****	-1.1707	-1.1086	-1.0921	-0.5574	*****	*****	*****	*****	*****
0.900	-1.1443	-1.1591	-1.1413	-0.9828	*****	*****	*****	*****	*****	*****
0.925	*****	-1.1565	-1.1502	-0.9646	-0.5554	*****	*****	*****	*****	*****
0.950	-1.1939	-1.1532	-1.1512	-0.9609	-0.4869	*****	*****	*****	*****	*****
0.975	*****	-1.1510	-1.1429	-0.9554	-0.4548	*****	*****	*****	*****	*****
-0.200	$C_{p,l}$	0.5025	0.4472	0.4326	*****	*****	*****	*****	*****	*****
-0.400	$C_{p,l}$	0.4989	0.4453	0.4087	0.2151	-0.5430	*****	*****	*****	*****
-0.600	$C_{p,l}$	*****	0.4592	0.3998	0.2421	-0.5133	*****	*****	*****	*****
-0.700	$C_{p,l}$	*****	0.4592	0.4006	0.2533	-0.4917	*****	*****	*****	*****
-0.800	$C_{p,l}$	0.4919	0.4547	0.3952	0.2662	-0.4206	*****	*****	*****	*****
-0.850	$C_{p,l}$	0.4619	0.4240	0.3876	0.2719	-0.3978	*****	*****	*****	*****
-0.900	$C_{p,l}$	0.4088	0.3967	0.3583	0.2637	-0.3446	*****	*****	*****	*****
-0.950	$C_{p,l}$	*****	*****	0.2577	0.1978	-0.1029	*****	*****	*****	*****
-0.975	$C_{p,l}$	*****	0.1594	0.1276	0.0856	-0.0746	*****	*****	*****	*****

Sharp Radius L.E.
 Run No. = 90 , Point No. = 2010
 $C_N = 1.058$, $C_m = -0.1989$
 $\alpha = 20.6^\circ$, $M_\infty = 0.901$
 $R_{mac} = 6.0 \times 10^6$

Surface Pressures Near Leading Edge

● / ◆ upper, starboard/port
 ○ / ◇ lower, starboard/port

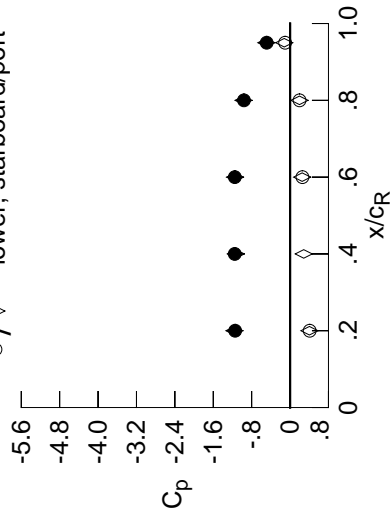

x/c_R	η	starb'd	port	starb'd	port
		$C_{p,u}$	$C_{p,l}$	$C_{p,u}$	$C_{p,l}$
0.20	0.90	-1.1443	-1.1589	0.4032	0.4088
0.40	0.95	-1.1532	-1.1294	0.2847	*****
0.60	0.95	-1.1512	-1.1465	0.2520	0.2577
0.80	0.95	-0.9609	-0.9697	0.1961	0.1978
0.95	0.95	-0.4869	-0.4946	-0.1214	-0.1029

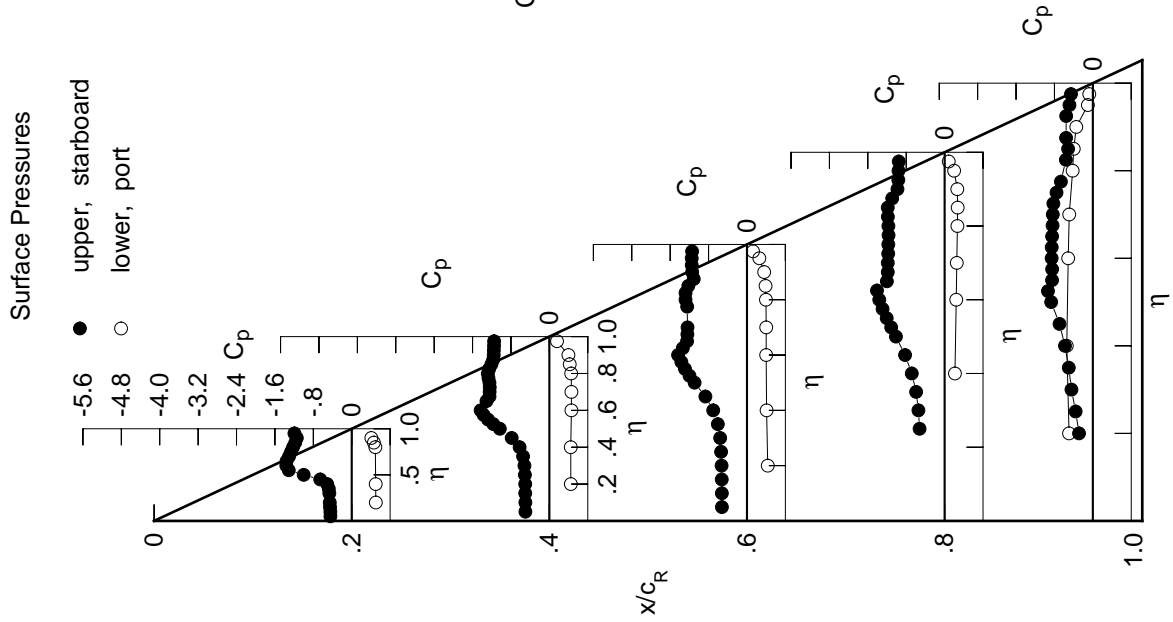

Table D6. Continued.

η	$x/c_R = .2$		$x/c_R = .4$		$x/c_R = .6$		$x/c_R = .8$		$x/c_R = .95$	
	$C_{p,u}$	$C_{p,l}$	$C_{p,u}$	$C_{p,l}$	$C_{p,u}$	$C_{p,l}$	$C_{p,u}$	$C_{p,l}$	$C_{p,u}$	$C_{p,l}$
0.050	-0.4768	-0.5241	-0.5536	*****	*****	*****	*****	*****	*****	*****
0.100	-0.4780	-0.5266	-0.5547	*****	*****	*****	*****	*****	*****	*****
0.150	-0.4868	-0.5266	-0.5597	*****	*****	*****	*****	*****	*****	*****
0.200	-0.4918	-0.5305	-0.5645	*****	*****	*****	*****	*****	*****	*****
0.250	*****	-0.5398	-0.5789	-0.5502	-0.5248	*****	*****	*****	*****	*****
0.300	-0.5091	-0.5571	-0.6082	-0.5852	-0.4044	*****	*****	*****	*****	*****
0.350	-0.5353	-0.6062	-0.6689	-0.6508	-0.4629	*****	*****	*****	*****	*****
0.400	-0.6072	-0.7171	-0.7858	-0.7574	-0.5756	*****	*****	*****	*****	*****
0.450	-0.8083	-0.9150	-0.9578	-0.9083	-0.7287	*****	*****	*****	*****	*****
0.500	-1.1309	-1.1477	-1.1671	-1.0915	-0.9365	*****	*****	*****	*****	*****
0.525	*****	-1.2582	-1.2622	-1.1832	-1.0086	*****	*****	*****	*****	*****
0.550	-1.3542	-1.3458	-1.3447	-1.2691	-0.9793	*****	*****	*****	*****	*****
0.575	*****	-1.4209	-1.4104	-1.3427	-0.8593	*****	*****	*****	*****	*****
0.600	-1.3183	-1.4646	-1.4696	-1.4053	-0.7998	*****	*****	*****	*****	*****
0.625	*****	*****	-1.3370	-1.3667	-0.8186	*****	*****	*****	*****	*****
0.650	-1.3309	-1.3064	-1.2833	-1.2204	-0.8234	*****	*****	*****	*****	*****
0.675	*****	-1.2826	-1.2763	-1.2069	-0.8155	*****	*****	*****	*****	*****
0.700	-1.3202	-1.2681	-1.2687	-1.1989	-0.8071	*****	*****	*****	*****	*****
0.725	*****	-1.2642	*****	-1.1894	-0.7702	*****	*****	*****	*****	*****
0.750	-1.3261	-1.2684	*****	-1.1751	-0.6793	*****	*****	*****	*****	*****
0.775	*****	-1.2938	-1.2796	-1.1611	-0.5903	*****	*****	*****	*****	*****
0.800	-1.2806	-1.3136	-1.3313	-1.1769	*****	*****	*****	*****	*****	*****
0.825	*****	-1.2788	-1.3320	-1.2130	-0.5228	*****	*****	*****	*****	*****
0.850	-1.2145	-1.2292	-1.2548	-1.2441	-0.5182	*****	*****	*****	*****	*****
0.875	*****	-1.1928	-1.1185	-1.1432	-0.5746	*****	*****	*****	*****	*****
0.900	-1.1859	-1.1852	-1.1560	-1.0265	*****	*****	*****	*****	*****	*****
0.925	*****	-1.1887	-1.1736	-1.0023	-0.6119	*****	*****	*****	*****	*****
0.950	-1.2331	-1.1858	-1.1747	-0.9970	-0.5203	*****	*****	*****	*****	*****
0.975	*****	-1.1865	-1.1687	-0.9855	-0.4928	*****	*****	*****	*****	*****

Sharp Radius L.E.
 Run No. = 90, Point No. = 2011
 $C_N = 1.105$, $C_m = -0.2060$
 $\alpha = 21.6^\circ$, $M_\infty = 0.900$
 $R_{mac} = 6.0 \times 10^6$

Surface Pressures Near Leading Edge

● / ◆ upper, starboard/port
 ○ / ◇ lower, starboard/port

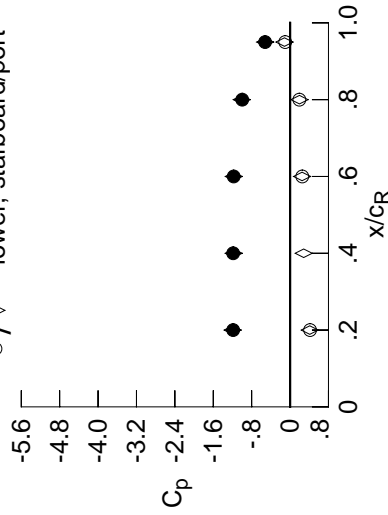

x/c_R	η	starb'd	port	starb'd	port
		$C_{p,u}$	$C_{p,l}$	$C_{p,u}$	$C_{p,l}$
0.20	0.90	-1.1859	-1.1970	0.4106	0.4165
0.40	0.95	-1.1858	-1.1754	0.2840	*****
0.60	0.95	-1.1747	-1.1727	0.2504	0.2546
0.80	0.95	-0.9970	-1.0074	0.1962	0.1938
0.95	0.95	-0.5203	-0.5193	-0.1171	-0.1018

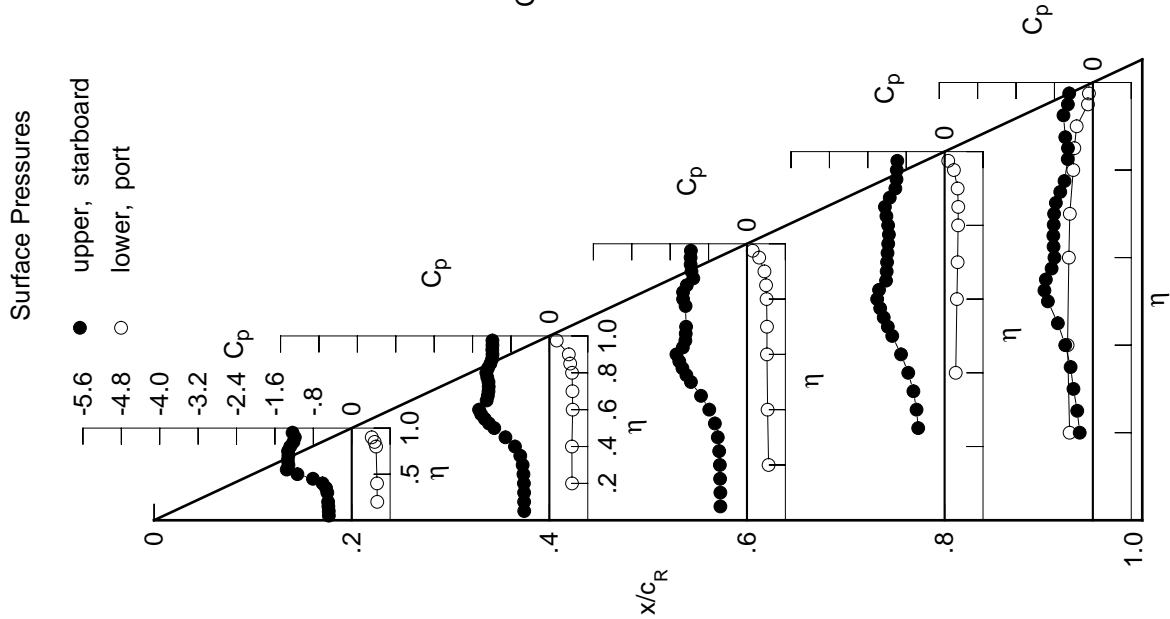

Table D6. Continued.

η	$x/c_R = .2$		$x/c_R = .4$		$x/c_R = .6$		$x/c_R = .8$		$x/c_R = .95$	
	$C_{p,u}$	$C_{p,l}$	$C_{p,u}$	$C_{p,l}$	$C_{p,u}$	$C_{p,l}$	$C_{p,u}$	$C_{p,l}$	$C_{p,u}$	$C_{p,l}$
0.050	-0.5083	-0.5458	-0.4938	*****	*****	*****	*****	*****	*****	*****
0.100	-0.5098	-0.5466	-0.4975	*****	*****	*****	*****	*****	*****	*****
0.150	-0.5182	-0.5538	-0.5007	*****	*****	*****	*****	*****	*****	*****
0.200	-0.5266	-0.5567	-0.5185	*****	*****	*****	*****	*****	*****	*****
0.250	*****	-0.5721	-0.5358	-0.4377	-0.7533	*****	*****	*****	*****	*****
0.300	-0.5517	-0.6017	-0.5740	-0.4538	-0.7583	*****	*****	*****	*****	*****
0.350	-0.5986	-0.6666	-0.6453	-0.5282	-0.7611	*****	*****	*****	*****	*****
0.400	-0.7049	-0.8008	-0.7781	-0.5831	-0.7876	*****	*****	*****	*****	*****
0.450	-0.9313	-1.0070	-0.9627	-0.6606	-0.7861	*****	*****	*****	*****	*****
0.500	-1.2188	-1.2165	-1.1736	-0.7210	-0.7572	*****	*****	*****	*****	*****
0.525	*****	-1.3112	-1.2465	-0.7415	-0.7490	*****	*****	*****	*****	*****
0.550	-1.3418	-1.3892	-1.1742	-0.7495	-0.7291	*****	*****	*****	*****	*****
0.575	*****	-1.4497	-1.0808	-0.7445	-0.7353	*****	*****	*****	*****	*****
0.600	-1.3265	-1.4840	-1.0629	-0.7540	-0.7275	*****	*****	*****	*****	*****
0.625	*****	*****	-1.0644	-0.7483	-0.7241	*****	*****	*****	*****	*****
0.650	-1.3336	-1.3251	-1.0652	-0.7551	-0.7179	*****	*****	*****	*****	*****
0.675	*****	-1.3117	-1.0562	-0.7586	-0.7060	*****	*****	*****	*****	*****
0.700	-1.3387	-1.2943	-1.0476	-0.7552	-0.6932	*****	*****	*****	*****	*****
0.725	*****	-1.2952	*****	-0.7453	-0.6890	*****	*****	*****	*****	*****
0.750	-1.3819	-1.2970	*****	-0.7331	-0.6777	*****	*****	*****	*****	*****
0.775	*****	-1.3262	-1.0256	-0.7168	-0.6628	*****	*****	*****	*****	*****
0.800	-1.3069	-1.3465	-1.0109	-0.7002	*****	*****	*****	*****	*****	*****
0.825	*****	-1.3056	-0.9943	-0.6814	-0.6380	*****	*****	*****	*****	*****
0.850	-1.2393	-1.2481	-0.9652	-0.6669	-0.5812	*****	*****	*****	*****	*****
0.875	*****	-1.2114	-0.8556	-0.6458	-0.6150	*****	*****	*****	*****	*****
0.900	-1.2156	-1.2077	-0.8307	-0.6131	*****	*****	*****	*****	*****	*****
0.925	*****	-1.2111	-0.8214	-0.5940	-0.5961	*****	*****	*****	*****	*****
0.950	-1.2578	-1.2072	-0.8048	-0.5849	-0.5605	*****	*****	*****	*****	*****
0.975	*****	-1.2070	-0.7856	-0.5456	-0.5267	*****	*****	*****	*****	*****
-0.200	*****	0.5592	0.4940	0.4687	*****	*****	*****	*****	*****	*****
-0.400	*****	0.5547	0.4933	0.4469	0.2454	-0.5237	*****	*****	*****	*****
-0.600	*****	*****	0.5079	0.4353	0.2698	-0.4950	*****	*****	*****	*****
-0.700	*****	*****	0.5010	0.4346	0.2844	-0.4729	*****	*****	*****	*****
-0.800	*****	0.5250	0.4884	0.4229	0.2913	-0.4030	*****	*****	*****	*****
-0.850	*****	0.4875	0.4459	0.4113	0.2940	-0.3789	*****	*****	*****	*****
-0.900	*****	0.4256	0.4132	0.3718	0.2786	-0.3290	*****	*****	*****	*****
-0.950	*****	*****	*****	0.2544	0.2006	-0.0992	*****	*****	*****	*****
-0.975	*****	*****	0.1531	0.1153	0.0799	-0.0792	*****	*****	*****	*****

Sharp Radius L.E.

Run No. = 90 , Point No. = 2012

$C_N = 1.049$, $C_m = -0.1751$

$\alpha = 22.6^\circ$, $M_\infty = 0.900$

$R_{mac} = 6.0 \times 10^6$

Surface Pressures Near Leading Edge

● / ◆ upper, starboard/port
○ / ◇ lower, starboard/port

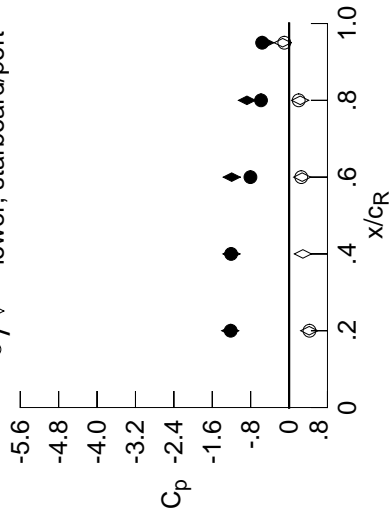

x/c_R	η	starb'd	port	starb'd	port
		$C_{p,u}$	$C_{p,l}$	$C_{p,u}$	$C_{p,l}$
0.20	0.90	-1.2156	-1.2266	0.4196	0.4256
0.40	0.95	-1.2072	-1.2011	0.2876	*****
0.60	0.95	-0.8048	-1.1948	0.2738	0.2544
0.80	0.95	-0.5849	-0.8772	0.2323	0.2006
0.95	0.95	-0.5605	-0.4948	-0.1329	-0.0992

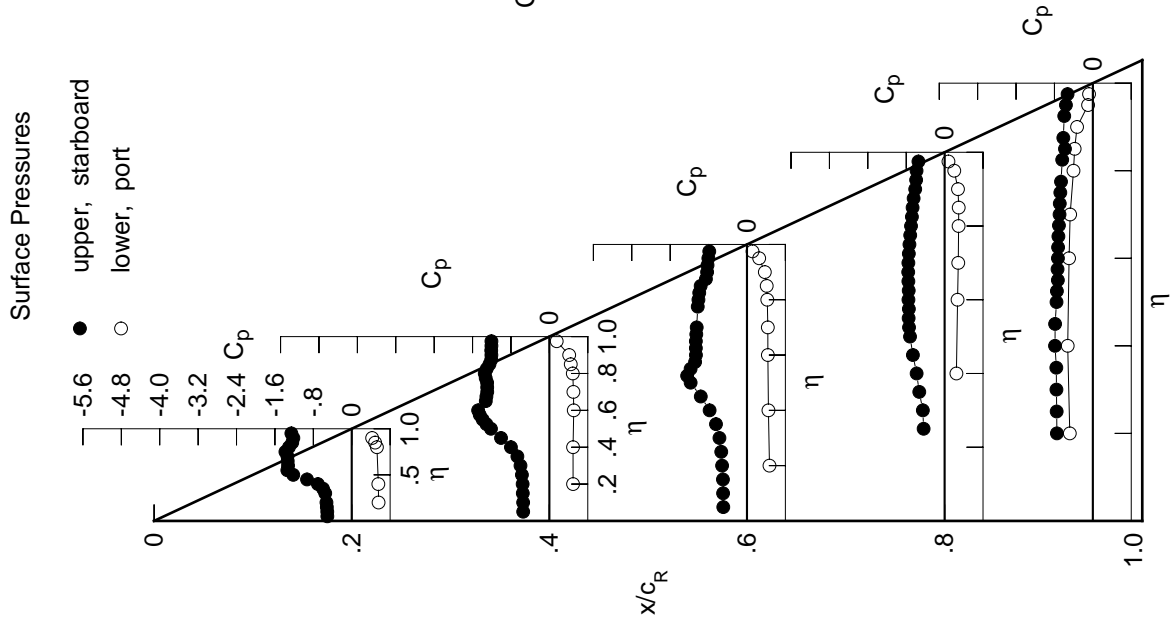

Table D6. Continued.

η	$x/c_R = .2$		$x/c_R = .4$		$x/c_R = .6$		$x/c_R = .8$		$x/c_R = .95$	
	$C_{p,u}$	$C_{p,l}$	$C_{p,u}$	$C_{p,l}$	$C_{p,u}$	$C_{p,l}$	$C_{p,u}$	$C_{p,l}$	$C_{p,u}$	$C_{p,l}$
0.050	-0.5390	-0.5746	-0.1587	*****	*****	*****	*****	*****	*****	*****
0.100	-0.5416	-0.5780	-0.1772	*****	*****	*****	*****	*****	*****	*****
0.150	-0.5523	-0.5834	-0.2042	*****	*****	*****	*****	*****	*****	*****
0.200	-0.5631	-0.5882	-0.2474	*****	*****	*****	*****	*****	*****	*****
0.250	*****	-0.6125	-0.2994	-0.4251	-0.8274	*****	*****	*****	*****	*****
0.300	-0.6014	-0.6503	-0.3827	-0.4408	-0.8175	*****	*****	*****	*****	*****
0.350	-0.6683	-0.7351	-0.5042	-0.5090	-0.8062	*****	*****	*****	*****	*****
0.400	-0.8009	-0.8830	-0.6848	-0.5629	-0.8256	*****	*****	*****	*****	*****
0.450	-1.0307	-1.0816	-0.8892	-0.6488	-0.8339	*****	*****	*****	*****	*****
0.500	-1.2828	-1.2687	-1.1230	-0.7239	-0.8180	*****	*****	*****	*****	*****
0.525	*****	-1.3526	-1.1820	-0.7531	-0.8150	*****	*****	*****	*****	*****
0.550	-1.3480	-1.4185	-1.1389	-0.7713	-0.7885	*****	*****	*****	*****	*****
0.575	*****	-1.4752	-1.0866	-0.7790	-0.7881	*****	*****	*****	*****	*****
0.600	-1.3411	-1.4901	-1.0721	-0.7737	-0.7735	*****	*****	*****	*****	*****
0.625	*****	*****	-1.0647	-0.7537	-0.7682	*****	*****	*****	*****	*****
0.650	-1.3499	-1.3528	-1.0611	-0.7627	-0.7651	*****	*****	*****	*****	*****
0.675	*****	-1.3368	-1.0523	-0.7741	-0.7538	*****	*****	*****	*****	*****
0.700	-1.3607	-1.3211	-1.0433	-0.7691	-0.7463	*****	*****	*****	*****	*****
0.725	*****	-1.3191	*****	-0.7518	-0.7435	*****	*****	*****	*****	*****
0.750	-1.4200	-1.3239	*****	-0.7270	-0.7348	*****	*****	*****	*****	*****
0.775	*****	-1.3535	-1.0199	-0.7147	-0.7197	*****	*****	*****	*****	*****
0.800	-1.3141	-1.3706	-1.0032	-0.6973	*****	*****	*****	*****	*****	*****
0.825	*****	-1.3306	-0.9767	-0.6771	-0.6909	*****	*****	*****	*****	*****
0.850	-1.2578	-1.2741	-0.9406	-0.6656	-0.6438	*****	*****	*****	*****	*****
0.875	*****	-1.2374	-0.8478	-0.6433	-0.6635	*****	*****	*****	*****	*****
0.900	-1.2402	-1.2313	-0.8281	-0.6145	*****	*****	*****	*****	*****	*****
0.925	*****	-1.2341	-0.8145	-0.6017	-0.6455	*****	*****	*****	*****	*****
0.950	-1.2774	-1.2324	-0.8003	-0.5861	-0.6016	*****	*****	*****	*****	*****
0.975	*****	-1.2355	-0.7865	-0.5490	-0.5623	*****	*****	*****	*****	*****

η	$x/c_R = .2$		$x/c_R = .4$		$x/c_R = .6$		$x/c_R = .8$		$x/c_R = .95$	
	$C_{p,u}$	$C_{p,l}$	$C_{p,u}$	$C_{p,l}$	$C_{p,u}$	$C_{p,l}$	$C_{p,u}$	$C_{p,l}$	$C_{p,u}$	$C_{p,l}$
-0.200	0.5882	0.5181	0.4895	*****	*****	*****	*****	*****	*****	*****
-0.400	0.5819	0.5176	0.4686	0.2599	-0.5149	*****	*****	*****	*****	*****
-0.600	*****	0.5277	0.4576	0.2861	-0.4889	*****	*****	*****	*****	*****
-0.700	*****	0.5243	0.4563	0.3011	-0.4666	*****	*****	*****	*****	*****
-0.800	0.5421	0.5071	0.4481	0.3114	-0.4005	*****	*****	*****	*****	*****
-0.850	0.5018	0.4589	0.4344	0.3155	-0.3801	*****	*****	*****	*****	*****
-0.900	0.4340	0.4219	0.3935	0.3026	-0.3358	*****	*****	*****	*****	*****
-0.950	*****	*****	0.2760	0.2331	-0.1129	*****	*****	*****	*****	*****
-0.975	*****	0.1478	0.1406	0.1291	-0.1003	*****	*****	*****	*****	*****

Sharp Radius L.E.
 Run No. = 90 , Point No. = 2013
 $C_N = 1.032$, $C_m = -0.1657$
 $\alpha = 23.6^\circ$, $M_\infty = 0.900$
 $R_{mac} = 6.0 \times 10^6$

Surface Pressures Near Leading Edge

● / ◆ upper, starboard/port
 ○ / ◇ lower, starboard/port

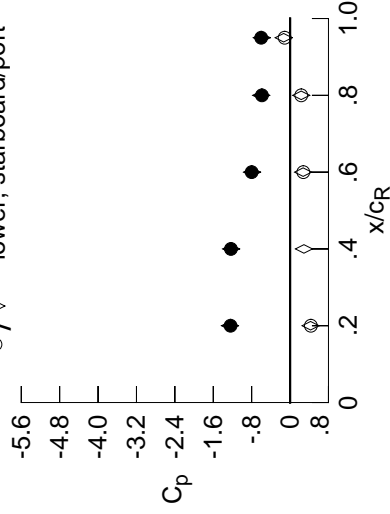

x/c_R	η	starb'd	port	starb'd	port
		$C_{p,u}$	$C_{p,l}$	$C_{p,u}$	$C_{p,l}$
0.20	0.90	-1.2402	-1.2519	0.4270	0.4340
0.40	0.95	-1.2324	-1.2284	0.2890	*****
0.60	0.95	-0.8003	-0.7916	0.2719	0.2760
0.80	0.95	-0.5861	-0.6020	0.2324	0.2331
0.95	0.95	-0.6016	-0.5893	-0.1339	-0.1129

Table D6. Continued.

η	x/c_R .2	$C_{p,u}$	x/c_R .4	$C_{p,u}$	x/c_R .6	$C_{p,u}$	x/c_R .8	$C_{p,u}$	x/c_R .95	$C_{p,u}$
0.050		-0.5386	-0.5747	-0.1889	*****	*****	*****	*****	*****	*****
0.100		-0.5405	-0.5761	-0.2119	*****	*****	*****	*****	*****	*****
0.150		-0.5514	-0.5832	-0.2364	*****	*****	*****	*****	*****	*****
0.200		-0.5607	-0.5881	-0.2782	*****	*****	*****	*****	*****	-0.8246
0.250		*****	-0.6100	-0.3272	-0.4132	-0.8238	-0.8144	-0.8026	-0.8223	-0.8281
0.300		-0.6013	-0.6504	-0.4066	-0.4284	-0.8144	-0.8026	-0.8223	-0.8281	-0.8123
0.350		-0.6682	-0.7350	-0.5241	-0.5011	-0.8026	-0.8223	-0.8281	-0.8123	-0.8078
0.400		-0.8013	-0.8836	-0.6991	-0.5546	-0.8223	-0.8281	-0.8123	-0.8078	-0.7865
0.450		-1.0324	-1.0820	-0.8952	-0.6453	-0.8281	-0.8123	-0.8078	-0.7865	-0.7851
0.500		-1.2840	-1.2688	-1.1273	-0.7221	-0.8123	-0.8078	-0.7865	-0.7851	-0.7720
0.525		*****	-1.3523	-1.1841	-0.7545	-0.8078	-0.7865	-0.7851	-0.7720	-0.7655
0.550		-1.3483	-1.4192	-1.1422	-0.7745	-0.7865	-0.7851	-0.7720	-0.7655	-0.7620
0.575		*****	-1.4740	-1.0880	-0.7805	-0.7851	-0.7720	-0.7655	-0.7620	-0.7498
0.600		-1.3421	-1.4911	-1.0725	-0.7728	-0.7720	-0.7655	-0.7620	-0.7498	-0.7406
0.625		*****	*****	-1.0637	-0.7531	-0.7655	-0.7620	-0.7498	-0.7406	-0.7374
0.650		-1.3472	-1.3525	-1.0626	-0.7676	-0.7620	-0.7498	-0.7406	-0.7374	-0.7288
0.675		*****	-1.3373	-1.0525	-0.7800	-0.7498	-0.7406	-0.7374	-0.7288	-0.7115
0.700		-1.3599	-1.3207	-1.0463	-0.7702	-0.7406	-0.7374	-0.7288	-0.7115	*****
0.725		*****	-1.3211	*****	-0.7500	-0.7374	-0.7288	-0.7115	*****	*****
0.750		-1.4208	-1.3244	*****	-0.7305	-0.7288	-0.7115	*****	*****	*****
0.775		*****	-1.3550	-1.0201	-0.7162	-0.7115	*****	*****	*****	*****
0.800		-1.3136	-1.3706	-1.0050	-0.6993	*****	*****	*****	*****	*****
0.825		*****	-1.3316	-0.9774	-0.6810	-0.6866	-0.6725	-0.6586	-0.6586	-0.6586
0.850		-1.2586	-1.2728	-0.9431	-0.6670	-0.6725	-0.6586	-0.6586	-0.6586	-0.6586
0.875		*****	-1.2370	-0.8492	-0.6432	-0.6586	-0.6586	-0.6586	-0.6586	-0.6586
0.900		-1.2399	-1.2332	-0.8283	-0.6121	*****	*****	*****	*****	*****
0.925		*****	-1.2349	-0.8163	-0.6000	-0.6395	-0.6395	-0.6395	-0.6395	-0.6395
0.950		-1.2783	-1.2335	-0.8039	-0.5840	-0.5962	-0.5962	-0.5962	-0.5962	-0.5962
0.975		*****	-1.2329	-0.7885	-0.5482	-0.5565	-0.5565	-0.5565	-0.5565	-0.5565
-0.200		$C_{p,l}$	$C_{p,l}$	$C_{p,l}$	$C_{p,l}$	$C_{p,l}$	$C_{p,l}$	$C_{p,l}$	$C_{p,l}$	$C_{p,l}$
-0.400		0.5898	0.5189	0.4908	*****	-0.4724	-0.4724	-0.4724	-0.4724	-0.4724
-0.600		0.5824	0.5195	0.4672	0.2618	-0.5133	-0.5133	-0.5133	-0.5133	-0.5133
-0.700		*****	0.5290	0.4591	0.2883	-0.4900	-0.4900	-0.4900	-0.4900	-0.4900
-0.800		0.5430	0.5072	0.4477	0.3013	-0.4660	-0.4660	-0.4660	-0.4660	-0.4660
-0.850		0.5030	0.4585	0.4336	0.3158	-0.3796	-0.3796	-0.3796	-0.3796	-0.3796
-0.900		0.4358	0.4216	0.3919	0.3029	-0.3354	-0.3354	-0.3354	-0.3354	-0.3354
-0.950		*****	*****	0.2741	0.2332	-0.1116	-0.1116	-0.1116	-0.1116	-0.1116
-0.975		*****	0.1476	0.1378	0.1269	-0.0994	-0.0994	-0.0994	-0.0994	-0.0994

Sharp Radius L.E.
 Run No. = 90 , Point No. = 2014
 $C_N = 1.033$, $C_m = -0.1679$
 $\alpha = 23.6^\circ$, $M_\infty = 0.900$
 $R_{mac} = 6.0 \times 10^6$

Surface Pressures Near Leading Edge

● / ◆ upper, starboard/port
 ○ / ◇ lower, starboard/port

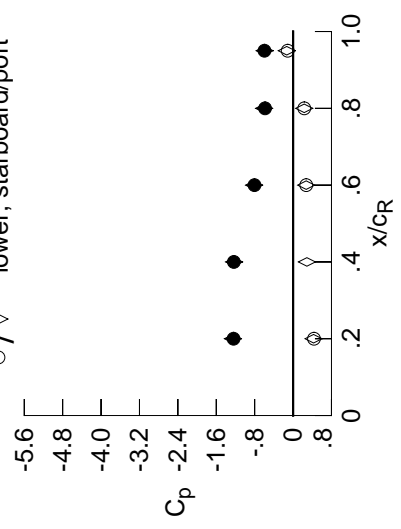

x/c_R	η	starb'd	port	starb'd	port
0.20	0.90	-1.2399	-1.2525	0.4269	0.4358
0.40	0.95	-1.2335	-1.2291	0.2883	*****
0.60	0.95	-0.8039	-0.8123	0.2734	0.2741
0.80	0.95	-0.5840	-0.6031	0.2322	0.2332
0.95	0.95	-0.5962	-0.5918	-0.1312	-0.1116

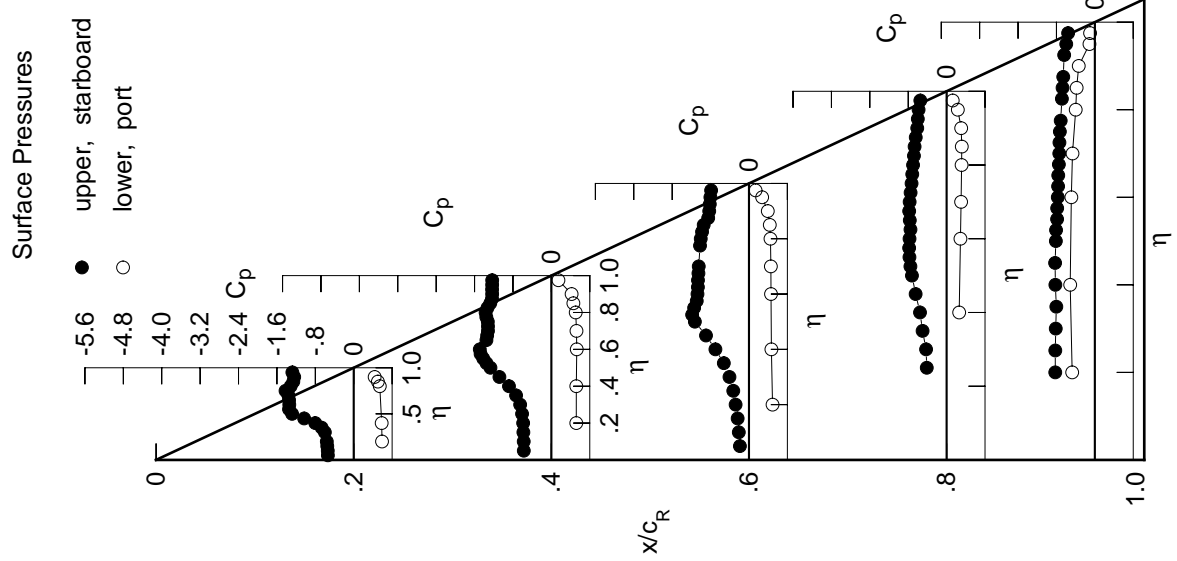

Table D6. Continued.

η	$x/c_R = .2$		$x/c_R = .4$		$x/c_R = .6$		$x/c_R = .8$		$x/c_R = .95$	
	$C_{p,u}$	$C_{p,l}$	$C_{p,u}$	$C_{p,l}$	$C_{p,u}$	$C_{p,l}$	$C_{p,u}$	$C_{p,l}$	$C_{p,u}$	$C_{p,l}$
0.050	-0.6106	-0.6444	-0.0323	*****	*****	*****	*****	*****	*****	*****
0.100	-0.6139	-0.6478	-0.0488	*****	*****	*****	*****	*****	*****	*****
0.150	-0.6299	-0.6554	-0.0692	*****	*****	*****	*****	*****	*****	*****
0.200	-0.6447	-0.6717	-0.1098	*****	*****	*****	*****	*****	*****	*****
0.250	*****	-0.7091	-0.1663	-0.7896	-0.7708	*****	*****	*****	*****	*****
0.300	-0.7147	-0.7701	-0.2683	-0.7978	-0.8199	*****	*****	*****	*****	*****
0.350	-0.8192	-0.8765	-0.4137	-0.8306	-0.8467	*****	*****	*****	*****	*****
0.400	-0.9792	-1.0298	-0.6214	-0.8289	-0.8772	*****	*****	*****	*****	*****
0.450	-1.1881	-1.2006	-0.8338	-0.8245	-0.8581	*****	*****	*****	*****	*****
0.500	-1.3829	-1.3500	-1.0484	-0.8146	-0.8178	*****	*****	*****	*****	*****
0.525	*****	-1.4166	-1.0783	-0.8184	-0.8087	*****	*****	*****	*****	*****
0.550	-1.4457	-1.4678	-1.0712	-0.8239	-0.7884	*****	*****	*****	*****	*****
0.575	*****	-1.5143	-1.0589	-0.8335	-0.7935	*****	*****	*****	*****	*****
0.600	-1.3776	-1.5115	-1.0373	-0.8463	-0.7847	*****	*****	*****	*****	*****
0.625	*****	*****	-0.9963	-0.8410	-0.7837	*****	*****	*****	*****	*****
0.650	-1.3777	-1.4041	-0.9746	-0.8411	-0.7831	*****	*****	*****	*****	*****
0.675	*****	-1.3837	-0.9731	-0.8455	-0.7772	*****	*****	*****	*****	*****
0.700	-1.3895	-1.3625	-0.9652	-0.8467	-0.7685	*****	*****	*****	*****	*****
0.725	*****	-1.3667	*****	-0.8392	-0.7667	*****	*****	*****	*****	*****
0.750	-1.4368	-1.3709	*****	-0.8268	-0.7600	*****	*****	*****	*****	*****
0.775	*****	-1.4018	-0.9228	-0.8158	-0.7436	*****	*****	*****	*****	*****
0.800	-1.3431	-1.4238	-0.9129	-0.7983	*****	*****	*****	*****	*****	*****
0.825	*****	-1.3834	-0.8943	-0.7853	-0.7134	*****	*****	*****	*****	*****
0.850	-1.2925	-1.3215	-0.8748	-0.7719	-0.7076	*****	*****	*****	*****	*****
0.875	*****	-1.2837	-0.8251	-0.7510	-0.6836	*****	*****	*****	*****	*****
0.900	-1.2759	-1.2823	-0.8305	-0.7236	*****	*****	*****	*****	*****	*****
0.925	*****	-1.2892	-0.8187	-0.7174	-0.6525	*****	*****	*****	*****	*****
0.950	-1.3152	-1.2867	-0.8127	-0.7018	-0.6134	*****	*****	*****	*****	*****
0.975	*****	-1.2836	-0.8077	-0.6567	-0.5764	*****	*****	*****	*****	*****

Sharp Radius L.E.
 Run No. = 90 , Point No. = 2015
 $C_N = 1.115$, $C_m = -0.1803$
 $\alpha = 25.7^\circ$, $M_\infty = 0.900$
 $R_{mac} = 6.0 \times 10^6$

Surface Pressures Near Leading Edge

● / ◆ upper, starboard/port
 ○ / ◇ lower, starboard/port

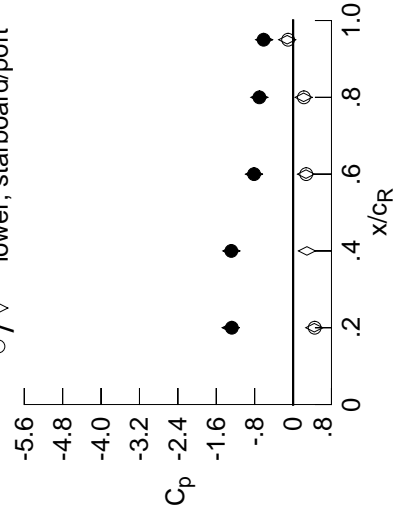

x/c_R	η	starb'd	port	starb'd	port
		$C_{p,u}$	$C_{p,l}$	$C_{p,u}$	$C_{p,l}$
0.20	0.90	-1.2759	-1.3011	0.4414	0.4502
0.40	0.95	-1.2867	-1.2861	0.2890	*****
0.60	0.95	-0.8127	-0.8147	0.2698	0.2748
0.80	0.95	-0.7018	-0.7035	0.2202	0.2255
0.95	0.95	-0.6134	-0.6022	-0.1220	-0.1030

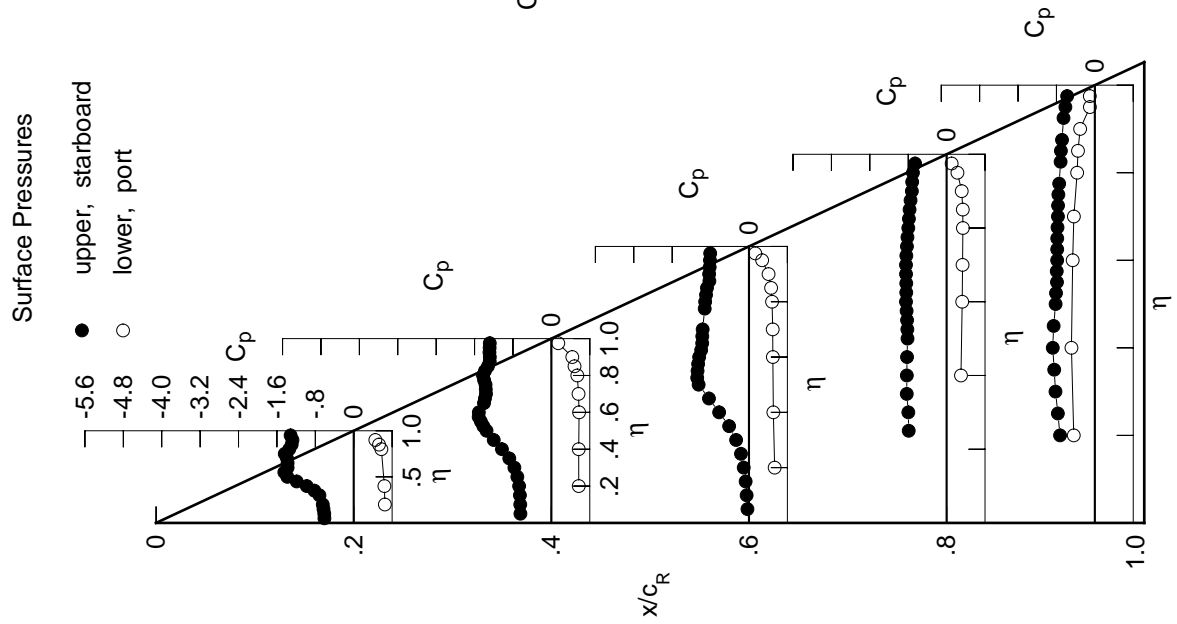

η	$C_{p,l}$	$C_{p,l}$	$C_{p,l}$	$C_{p,l}$	$C_{p,l}$
-0.200	0.6491	0.5704	0.5350	*****	-0.4393
-0.400	0.6390	0.5694	0.5077	0.2989	-0.4875
-0.600	*****	0.5775	0.4973	0.3246	-0.4619
-0.700	*****	0.5665	0.4945	0.3320	-0.4372
-0.800	0.5759	0.5406	0.4807	0.3389	-0.3686
-0.850	0.5275	0.4822	0.4605	0.3367	-0.3509
-0.900	0.4502	0.4362	0.4080	0.3144	-0.3064
-0.950	*****	*****	0.2748	0.2255	-0.1030
-0.975	*****	0.1443	0.1304	0.1048	-0.1046

Table D6. Continued.

η	$x/c_R = 0.2$		$x/c_R = 0.4$		$x/c_R = 0.6$		$x/c_R = 0.8$		$x/c_R = 0.95$	
	$C_{p,u}$	$C_{p,d}$	$C_{p,u}$	$C_{p,d}$	$C_{p,u}$	$C_{p,d}$	$C_{p,u}$	$C_{p,d}$	$C_{p,u}$	$C_{p,d}$
0.050	-0.6511	-0.6784	-0.1315	*****	*****	*****	*****	*****	*****	*****
0.100	-0.6535	-0.6762	-0.1391	*****	*****	*****	*****	*****	*****	*****
0.150	-0.6697	-0.6922	-0.1425	*****	*****	*****	*****	*****	*****	*****
0.200	-0.6869	-0.7088	-0.1705	*****	*****	*****	*****	*****	*****	*****
0.250	*****	-0.7565	-0.2126	-0.8948	-0.8322	*****	*****	*****	*****	*****
0.300	-0.7760	-0.8266	-0.2995	-0.8691	-0.8907	*****	*****	*****	*****	*****
0.350	-0.8921	-0.9409	-0.4267	-0.8568	-0.8999	*****	*****	*****	*****	*****
0.400	-1.0533	-1.0898	-0.6098	-0.8103	-0.8779	*****	*****	*****	*****	*****
0.450	-1.2468	-1.2489	-0.7938	-0.7893	-0.8305	*****	*****	*****	*****	*****
0.500	-1.4173	-1.3835	-0.9890	-0.7934	-0.7878	*****	*****	*****	*****	*****
0.525	*****	-1.4417	-1.0485	-0.8144	-0.7961	*****	*****	*****	*****	*****
0.550	-1.4537	-1.4901	-1.0695	-0.8287	-0.7846	*****	*****	*****	*****	*****
0.575	*****	-1.5268	-1.0569	-0.8462	-0.8007	*****	*****	*****	*****	*****
0.600	-1.3945	-1.5241	-0.9991	-0.8600	-0.7943	*****	*****	*****	*****	*****
0.625	*****	*****	-0.9228	-0.8543	-0.7941	*****	*****	*****	*****	*****
0.650	-1.3975	-1.4259	-0.9020	-0.8548	-0.7968	*****	*****	*****	*****	*****
0.675	*****	-1.4042	-0.9081	-0.8663	-0.7849	*****	*****	*****	*****	*****
0.700	-1.4137	-1.3811	-0.9177	-0.8638	-0.7814	*****	*****	*****	*****	*****
0.725	*****	-1.3802	*****	-0.8632	-0.7725	*****	*****	*****	*****	*****
0.750	-1.4619	-1.3872	*****	-0.8480	-0.7725	*****	*****	*****	*****	*****
0.775	*****	-1.4164	-0.8770	-0.8435	-0.7491	*****	*****	*****	*****	*****
0.800	-1.3513	-1.4383	-0.8655	-0.8265	*****	*****	*****	*****	*****	*****
0.825	*****	-1.4053	-0.8512	-0.8244	-0.7209	*****	*****	*****	*****	*****
0.850	-1.3046	-1.3408	-0.8370	-0.8151	-0.7061	*****	*****	*****	*****	*****
0.875	*****	-1.2986	-0.8019	-0.8042	-0.6898	*****	*****	*****	*****	*****
0.900	-1.2977	-1.3002	-0.8153	-0.7757	*****	*****	*****	*****	*****	*****
0.925	*****	-1.3082	-0.8091	-0.7664	-0.6556	*****	*****	*****	*****	*****
0.950	-1.3333	-1.3139	-0.7952	-0.7586	-0.6188	*****	*****	*****	*****	*****
0.975	*****	-1.3075	-0.7869	-0.7225	-0.5895	*****	*****	*****	*****	*****
-0.200	*****	*****	*****	*****	*****	*****	*****	*****	*****	*****
-0.400	0.6734	0.5977	0.5550	0.5550	0.5550	0.5550	0.5550	0.5550	0.5550	0.5550
-0.600	0.6670	0.5944	0.5279	0.3182	0.3182	0.3182	0.3182	0.3182	0.3182	0.3182
-0.800	*****	0.5992	0.5210	0.3347	0.3347	0.3347	0.3347	0.3347	0.3347	0.3347
-0.900	*****	0.5888	0.5128	0.3472	0.3472	0.3472	0.3472	0.3472	0.3472	0.3472
-0.950	0.5929	0.5578	0.4958	0.3505	0.3505	0.3505	0.3505	0.3505	0.3505	0.3505
-0.975	0.5402	0.4972	0.4750	0.3457	0.3457	0.3457	0.3457	0.3457	0.3457	0.3457
-0.990	0.4606	0.4455	0.4167	0.3179	0.3179	0.3179	0.3179	0.3179	0.3179	0.3179
-0.995	*****	*****	0.2772	0.2199	0.2199	0.2199	0.2199	0.2199	0.2199	0.2199
-0.997	*****	0.1374	0.1277	0.0901	0.0901	0.0901	0.0901	0.0901	0.0901	0.0901

Sharp Radius L.E.
 Run No. = 90 , Point No. = 2016
 $C_N = 1.146$, $C_m = -0.1812$
 $\alpha = 26.7^\circ$, $M_\infty = 0.900$
 $R_{mac} = 6.0 \times 10^6$

Surface Pressures Near Leading Edge

● / ◆ upper, starboard/port
 ○ / ◇ lower, starboard/port

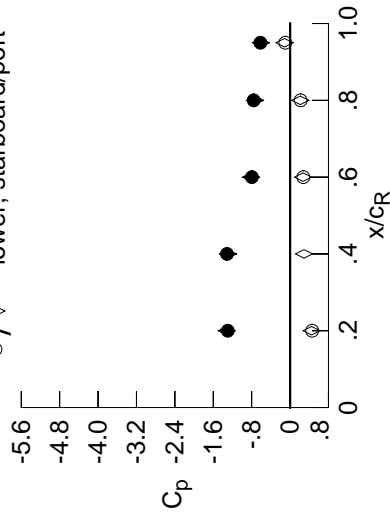

x/c_R	η	starb'd	port	starb'd	port
		$C_{p,u}$	$C_{p,d}$	$C_{p,u}$	$C_{p,d}$
0.20	0.90	-1.2977	-1.3219	0.4486	0.4606
0.40	0.95	-1.3139	-1.2942	0.2906	*****
0.60	0.95	-0.7952	-0.8159	0.2708	0.2772
0.80	0.95	-0.7586	-0.7297	0.2134	0.2199
0.95	0.95	-0.6188	-0.6092	-0.1149	-0.0999

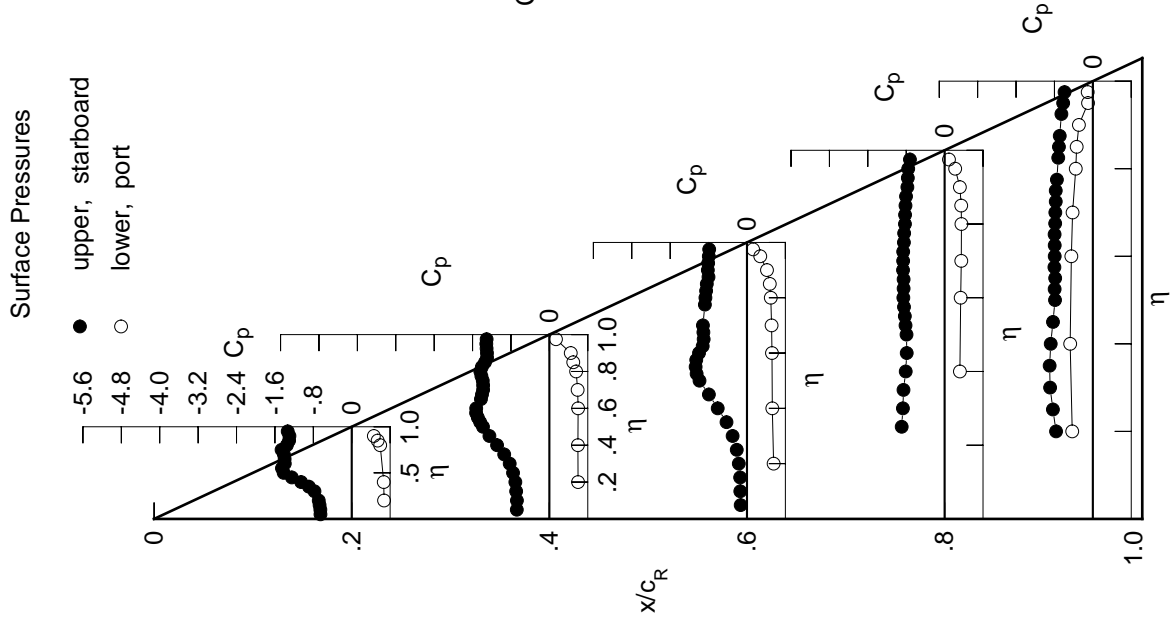

Table D6. Concluded.

η	$x/c_R = .2$		$x/c_R = .4$		$x/c_R = .6$		$x/c_R = .8$		$x/c_R = .95$	
	$C_{p,u}$	$C_{p,u}$	$C_{p,u}$	$C_{p,u}$	$C_{p,u}$	$C_{p,u}$	$C_{p,u}$	$C_{p,u}$	$C_{p,u}$	$C_{p,u}$
0.050	-0.0081	0.0005	0.1407	0.1310	0.1310	0.1310	0.1310	0.1310	0.1310	0.1310
0.100	-0.0045	0.0015	0.1310	0.1198	0.1198	0.1198	0.1198	0.1198	0.1198	0.1198
0.150	-0.0123	0.0010	0.1198	0.1075	0.1075	0.1075	0.1075	0.1075	0.1075	0.1075
0.200	-0.0185	0.0013	0.1075	0.0944	0.0944	0.0944	0.0944	0.0944	0.0944	0.0944
0.250	*****	-0.0006	0.0944	0.0814	0.0814	0.0814	0.0814	0.0814	0.0814	0.0814
0.300	-0.0374	0.0015	0.0814	0.0715	0.0715	0.0715	0.0715	0.0715	0.0715	0.0715
0.350	-0.0463	0.0011	0.0715	0.0624	0.0624	0.0624	0.0624	0.0624	0.0624	0.0624
0.400	-0.0534	0.0045	0.0624	0.0603	0.0603	0.0603	0.0603	0.0603	0.0603	0.0603
0.450	-0.0631	0.0042	0.0603	0.0429	0.0429	0.0429	0.0429	0.0429	0.0429	0.0429
0.500	-0.0668	0.0089	0.0429	0.0410	0.0410	0.0410	0.0410	0.0410	0.0410	0.0410
0.525	*****	-0.0110	0.0410	0.0375	0.0375	0.0375	0.0375	0.0375	0.0375	0.0375
0.550	-0.0690	0.0156	0.0375	0.0385	0.0385	0.0385	0.0385	0.0385	0.0385	0.0385
0.575	*****	-0.0185	0.0385	0.0312	0.0312	0.0312	0.0312	0.0312	0.0312	0.0312
0.600	-0.0519	0.0212	0.0312	0.0285	0.0285	0.0285	0.0285	0.0285	0.0285	0.0285
0.625	*****	*****	0.0285	0.0211	0.0211	0.0211	0.0211	0.0211	0.0211	0.0211
0.650	-0.0433	0.0223	0.0211	0.0170	0.0170	0.0170	0.0170	0.0170	0.0170	0.0170
0.675	*****	-0.0354	0.0170	0.0138	0.0138	0.0138	0.0138	0.0138	0.0138	0.0138
0.700	-0.0345	0.0541	0.0138	0.0704	0.0704	0.0704	0.0704	0.0704	0.0704	0.0704
0.725	*****	-0.0704	0.0704	0.0746	0.0746	0.0746	0.0746	0.0746	0.0746	0.0746
0.750	-0.0186	0.0746	0.0746	0.0803	0.0803	0.0803	0.0803	0.0803	0.0803	0.0803
0.775	*****	-0.0803	0.0803	0.0805	0.0805	0.0805	0.0805	0.0805	0.0805	0.0805
0.800	-0.0015	0.0805	0.0805	0.0711	0.0711	0.0711	0.0711	0.0711	0.0711	0.0711
0.825	*****	-0.0711	0.0711	0.0527	0.0527	0.0527	0.0527	0.0527	0.0527	0.0527
0.850	0.0271	0.0617	0.0525	0.0525	0.0525	0.0525	0.0525	0.0525	0.0525	0.0525
0.875	*****	-0.0455	0.0545	0.0455	0.0455	0.0455	0.0455	0.0455	0.0455	0.0455
0.900	0.0678	0.0215	0.0381	0.0215	0.0215	0.0215	0.0215	0.0215	0.0215	0.0215
0.925	*****	0.0127	0.0197	0.0197	0.0197	0.0197	0.0197	0.0197	0.0197	0.0197
0.950	0.1119	0.0541	0.0217	0.0634	0.0634	0.0634	0.0634	0.0634	0.0634	0.0634
0.975	*****	0.1023	0.0857	0.0111	0.0111	0.0111	0.0111	0.0111	0.0111	0.0111
-0.200	-0.0319	0.0070	0.1071	0.0630	0.0630	0.0630	0.0630	0.0630	0.0630	0.0630
-0.400	-0.0547	0.0019	0.0630	0.0296	0.0296	0.0296	0.0296	0.0296	0.0296	0.0296
-0.600	*****	-0.0102	0.0296	0.0122	0.0122	0.0122	0.0122	0.0122	0.0122	0.0122
-0.700	*****	-0.0485	0.0122	0.0442	0.0442	0.0442	0.0442	0.0442	0.0442	0.0442
-0.800	-0.0201	0.0822	0.0442	0.0650	0.0650	0.0650	0.0650	0.0650	0.0650	0.0650
-0.850	0.0125	0.0639	0.0650	0.1233	0.1233	0.1233	0.1233	0.1233	0.1233	0.1233
-0.900	0.0507	0.0312	0.0629	0.1464	0.1464	0.1464	0.1464	0.1464	0.1464	0.1464
-0.950	*****	*****	0.0076	0.0896	0.0896	0.0896	0.0896	0.0896	0.0896	0.0896
-0.975	*****	0.0923	0.0628	0.0166	0.0166	0.0166	0.0166	0.0166	0.0166	0.0166

Sharp Radius L.E.
 Run No. = 90 , Point No. = 2017
 $C_N = -0.022$, $C_m = 0.0085$
 $\alpha = 0.0^\circ$, $M_\infty = 0.901$
 $R_{mac} = 6.0 \times 10^6$

Surface Pressures Near Leading Edge

● / ◆ upper, starboard/port
 ○ / ◇ lower, starboard/port

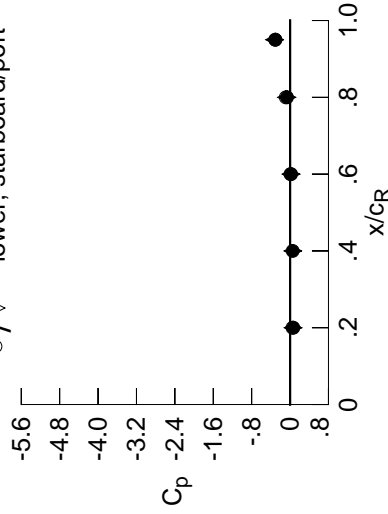

x/c_R	η	starb'd	port	starb'd	port
		$C_{p,u}$	$C_{p,u}$	$C_{p,l}$	$C_{p,l}$
0.20	0.90	0.0678	0.0674	0.0557	0.0507
0.40	0.95	0.0541	0.0615	0.0554	*****
0.60	0.95	0.0217	0.0265	0.0128	0.0076
0.80	0.95	-0.0634	-0.0604	-0.0819	-0.0896
0.95	0.95	-0.3041	-0.3153	-0.3303	-0.3104

