

1N-07
027262

Evaluation of an Ejector Ramjet Based Propulsion System for Air-Breathing Hypersonic Flight

Scott R. Thomas, H. Douglas Perkins, and Charles J. Trefny
Lewis Research Center
Cleveland, Ohio

Prepared for the
89th Symposium
sponsored by the Propulsion and Energetics Panel of the NATO
Advisory Group for Aerospace Research and Development
Palaiseau, France, April 14–17, 1997



National Aeronautics and
Space Administration

EVALUATION OF AN EJECTOR RAMJET BASED PROPULSION SYSTEM FOR AIR-BREATHING HYPERSONIC FLIGHT

Scott R. Thomas, H. Douglas Perkins, and Charles J. Trefny
National Aeronautics and Space Administration
Lewis Research Center
Cleveland, Ohio

1. ABSTRACT

A Rocket Based Combined Cycle (RBCC) engine system is designed to combine the high thrust to weight ratio of a rocket along with the high specific impulse of a ramjet in a single, integrated propulsion system. This integrated, combined cycle propulsion system is designed to provide higher vehicle performance than that achievable with a separate rocket and ramjet. The RBCC engine system studied in the current program is the Aerojet strutjet engine concept, which is being developed jointly by a government-industry team as part of the Air Force HyTech program pre-PRDA activity. The strutjet is an ejector-ramjet engine in which small rocket chambers are embedded into the trailing edges of the inlet compression struts. The engine operates as an ejector-ramjet from take-off to slightly above Mach 3. Above Mach 3 the engine operates as a ramjet and transitions to a scramjet at high Mach numbers. For space launch applications the rockets would be re-ignited at a Mach number or altitude beyond which air-breathing propulsion alone becomes impractical. The focus of the present study is to develop and demonstrate a strutjet flowpath using hydrocarbon fuel at up to Mach 7 conditions.

Freejet tests of a candidate flowpath for this RBCC engine were conducted at the NASA Lewis Research Center's Hypersonic Tunnel Facility between July and September 1996. This paper describes the engine flowpath and installation, outlines the primary objectives of the program, and describes the overall results of this activity. Through this program 15 full duration tests, including 13 fueled tests were made. The first major achievement was the further demonstration of the HTF capability. The facility operated at conditions up to 1950 K and 7.34 MPa, simulating approximately Mach 6.6 flight. The initial tests were unfueled and focused on verifying both facility and engine starting. During these runs additional aerodynamic appliances were incorporated onto the facility diffuser to enhance starting. Both facility and engine starting were achieved. Further, the static pressure distributions compared well with the results previously obtained in a 40% subscale flowpath study conducted in the LeRC 1X1 supersonic wind tunnel (SWT), as well as the results of CFD analysis. Fueled performance results were obtained for the engine at both simulated Mach 6 (1670 K) and Mach 6.6 (1950 K) conditions. For all these tests the primary fuel was liquid JP-10 with gaseous silane (a mixture of 20% SiH₄ and 80% H₂ by volume) as an ignitor/pilot. These tests verified performance of this engine flowpath in a freejet mode. High combustor pressures were reached and significant changes in axial force were achieved due to combustion. Future test plans

include redistributing the fuel to improve mixing, and consequently performance, at higher equivalence ratios.

2. INTRODUCTION

A Rocket Based Combined Cycle (RBCC) engine system is designed to combine the high thrust to weight ratio (T/W) of a rocket with the high specific impulse of a ramjet in a single, integrated propulsion system. This integrated, combined cycle propulsion system is designed to provide higher vehicle performance than that achievable with a separate rocket and ramjet. The potential performance advantages of RBCC engine systems for various applications such as space access or global transportation vehicles are outlined in Refs. 1 to 3. The potential benefit of air-breathing engine cycles over a rocket only system is shown in Fig. 1 (as presented in Ref. 1). Air-breathing engines, such as turbojet and ramjet engines, have much higher specific impulse. These systems add weight and system complexity, and it is necessary to incorporate a rocket system at high Mach numbers where air-breathing propulsion is no longer practical. As shown in Fig. 2, (presented in Ref. 2) combined cycle propulsion systems may require a significantly lower vehicle propellant mass fraction compared to an all rocket system. This will ultimately yield a much increased payload capacity for comparably sized vehicles.

The RBCC engine system studied in the current program incorporates the Aerojet strutjet engine concept, which is being developed jointly by a government-industry team. The features of the basic engine concept are presented in Refs. 1, 3, and 4, and shown in Fig. 3. The strutjet is an ejector-ramjet engine in which small rocket chambers are embedded into the trailing edges of the inlet compression struts. This engine is a compromise between the high Isp, low T/W all air-breathing options and the low Isp, high T/W of an all-rocket system. An advantage of the strutjet concept is that it transitions from an air augmented rocket to ramjet and finally to pure rocket with a minimum of variable geometry. The engine operates as an ejector-ramjet from take-off to slightly above Mach 3. Above Mach 3 the engine operates as a ramjet and transitions to a scramjet at high Mach numbers. For space launch applications the rockets would be re-ignited at a Mach number or altitude beyond which air-breathing propulsion alone becomes impractical. The focus of the present study is to develop and demonstrate a candidate strutjet flowpath. The primary application of consideration is a hydrocarbon fueled missile engine designed for up to Mach 8 cruise conditions. This report presents the freejet engine test results obtained at the HTF (Hypersonic Tunnel Facility) at Mach numbers up to 6.6. Details of this facility are

presented in Refs. 5 to 7. The HTF is a blowdown, nonvitiated, free-jet facility capable of testing large-scale propulsion systems at Mach numbers up to 7. Models typically up to 3 meters in length and 0.6 meters in diameter can be tested. Illustrations of the major HTF components are presented in Fig. 4. The energy source of the facility is the graphite core magnetic induction nitrogen heater which can supply nitrogen up to 59 kg/sec at conditions of 2800 K and 8.3 MPa. Ambient oxygen and nitrogen (if required) are mixed with this hot nitrogen downstream of the heater to produce a test flow with true temperature, composition, and altitude simulation. The HTF facility is one of the few operational freejet hypersonic propulsion test facilities in the United States. The HTF facility is unique because it combines the capabilities of large scale (107 cm nozzle diameter) and up to Mach 7 enthalpy clean air.

Prior to the present program, two other test activities were completed to provide information to maximize the efficiency and minimize the risk of this HTF testing. The first study, presented in Ref. 8, was the testing of a 40% scale model of the inlet used in the current RBCC engine. This study was conducted to explore the operability and performance of this inlet with three different inlet compression strut geometries. This established that the best performance and operability was achieved with the untapered strut design which was subsequently used in the RBCC model for the present study. A CFD analysis, presented in Ref. 9, complemented the test results and provided more detailed information on the RBCC inlet flow. The second experimental study was a direct connect combustor test discussed in Refs. 1, 3, and 4. In this activity the combustor configuration used in the freejet model was demonstrated. This program established a fueling scheme for this geometry and operating conditions (Mach numbers and simulated altitudes) which resulted in both successful ignition and piloting as well as high combustion efficiency. These two studies verified adequate inlet and combustor performance at the component level. The goal of the present study, therefore, was to demonstrate that this engine design would operate effectively as an integrated propulsion system.

3. APPARATUS AND PROCEDURES

3.1 RBCC Engine Geometry

The engine model is a fixed geometry, heat sink design shown in Fig. 5. The leading edges of the inlet are water cooled; the remainder of the engine is uncooled and constructed largely from 5.1 cm thick OFE copper plates. The inlet incorporates two identical struts which segment the inlet into three channels. This engine is a modular design which may utilize more channels in some applications. The center passage represents a full channel. The sidewalls are flat representing symmetry planes and the two side passages are approximately half the width of the center channel. The struts reach a maximum thickness at the cowl lip (inlet entrance). The net internal geometric cross-sectional area is constant from the cowl lip station to the base of the struts but the cross sectional geometry varies. Convergence between the cowl and the top wall is compensated for by a reduction in strut thickness. Since there is no internal contraction downstream of the cowl

leading edge, the inlet is able to self start at Mach numbers below approximately 4 (approaching the inlet). The last 27.3 cm of the struts are constant height and width such that the cross sections of all channels are rectangular and constant geometry.

The struts are assembled in sections and include the inlet compression and two fuel injection stations. The first section is entirely for the inlet compression process. The next two sections make up a constant geometry area of the model and incorporate fueling stations as shown in Fig. 6. The forward station includes normal fuel injection from both sides of each strut approximately 25 cm upstream of the base. The forward fueling scheme was normal injection of silane (a mixture of 20% SiH₄ and 80% H₂ by volume) coupled with normal injection of ambient liquid JP-10 1 cm downstream (and in line with) the silane injectors. The aft strut section is the region where the strut rockets are incorporated. In the present study the rockets were not used, therefore, a set of "dummy blocks" with the same dimensions were used which included the same fueling scheme as the rockets. Liquid JP-10 is injected into the base of the struts through trapezoidal shaped "shower heads" as shown.

Downstream of the base of the struts is the continuation of the combustor and the nozzle. The bottom plate (cowl) and side wall surfaces remain flat throughout the engine. In this combustor/nozzle region the top wall is made up of manually adjustable sections; including two 30.5 cm long sections and one 49.9 cm long section. These are adjustable using a set of jack screws located above the model. Throughout this test program the engine configuration remained constant and these three top wall sections were positioned with the geometry shown in Fig. 5.

3.2 Installation of Engine into HTF

The engine was installed into the Hypersonic Tunnel Facility as shown in the isometric drawing of Fig. 7(a) and the photograph of Fig. 7(b). The engine assembly was suspended from the overhead thrust stand using two I-beams. To protect the instrumentation and equipment immediately above the engine from the test flow this region is protected by shrouding with copper plate. A flat plate designed to simulate a representative vehicle forebody was mounted upstream of the inlet as shown; it is 71 cm long, 63 cm wide at the leading edge and tapers back to the engine inlet width of 23 cm. The plate is mounted at an 8° angle relative to the facility test flow direction, which matches the top wall angle of the inlet. During the present study the plate was positioned such that the bottom surface of this plate is flush with the top wall surface of the engine such that the engine ingests the boundary layer. It can also be mounted offset (2.5 cm) to the inlet top wall to divert the boundary layer although this was not done during the test program.

The HTF has three existing axisymmetric contoured nozzles with nominal exit Mach numbers of 5, 6, and 7, each with a 107 cm exit diameter. During the current study the Mach 5 nozzle was used for a few tests and the Mach 6 nozzle was used for the majority of the tests. Based on the nozzle calibrations as reported in Ref. 7, both of these facility nozzles have exit flow distributions with uniform

cores of approximately 76 cm diameter. In this installation, the leading edge of the cowl is 15.7 cm below the nozzle centerline, and the leading edge of the precompression plate is 15 cm above the nozzle centerline. The capture area of the plate and the engine inlet fit within this region of uniform flow. The precompression plate is mounted to a support structure which is not part of the thrust measurement system (non-metric), therefore, the loads measured by the thrust stand include only those of the engine. There is a gap of approximately 0.6 cm between the trailing edge of the precompression plate and the engine inlet top wall leading edge. This gap is sufficient to prevent interaction between these surfaces due to thermal growth or deflection of the thrust stand mounts; an interlocking, noncontacting seal was installed across this gap to prevent excessive flow spillage.

The engine instrumentation consists primarily of 82 static pressure taps located along the top and side walls of the engine and along the top surface of the precompression plate. Additional static pressure taps were included in the engine shrouding to determine approximate thrust loads for those surfaces. Other measurements included the engine thrust and 5 combustor wall temperatures. The HTF is equipped with 3 data systems serving 3 different applications. Overall facility data recording and display is accomplished using an ESCORT D system which scans a maximum of 527 channels at a rate of 1 Hz on all channels. A 64 channel high speed MassComp system was set up to sample the following research data at a rate of 20 times/sec: engine thrust, model wall temperatures, fuel system properties and flow rates, and facility stagnation conditions. There is also a 192 channel Electrically Scanned Pressure (ESP) unit which was used to sample engine static pressures at a rate of approximately 17 samples/sec.

3.3 Test Objectives and Sequence

The first test objective was to further demonstrate reliable operation of the HTF at conditions up to simulation of Mach 7 flight. These initial tests were unfueled and focused on verifying that both the facility and engine flow path started at all conditions. The unfueled data was also compared to the results of the 40% subscale flowpath study. Fueled engine performance tests were then conducted to demonstrate the free-jet performance of this engine flowpath in a ramjet/scramjet mode at both simulated Mach 6 and Mach 6.6 conditions. For all these tests the primary fuel was ambient temperature liquid JP-10 with gaseous silane as an ignitor. Although this engine flow path is designed to incorporate the strutjet system and operate as a Rocket Based Combined Cycle (RBCC) engine, the rocket system was not demonstrated in the current program. The fueled engine tests were, in part, an extension of the direct-connect combustor test activity discussed in Refs. 1, 3, and 4. This data base would, therefore, provide a comparison between the resultant performance and operability of the freejet engine relative to the direct-connect experiment. Achieving equivalent performance in the freejet configuration requires effectively managing the inlet flow, which is inherently less stable and has significant flow distortion at the exit (entering the combustor). It is also essential to establish

the proper fuel distribution in order to achieve ignition and flameholding, as well as efficient fuel/air mixing.

The HTF operation requires that the graphite heater be brought up to the required operating temperature and the supporting systems be energized prior to facility operation. The test total temperature is limited by the maximum temperatures to which the graphite blocks can be heated without exceeding any temperature limits within the heater. During the present study a facility total temperature of 1950 K was reached; this was limited by some high temperature readings observed in the heater insulation and support pedestal (not limitations in the blocks). Reaching full Mach 7 enthalpy (approximately 2200 K) with the HTF will require some facility modifications. During the operating sequence, the facility is ramped up to the required test condition, then a dwell time of approximately 3 sec is allowed for the pressure and temperature to settle before the engine operation is initiated. At that point a specified schedule of silane and liquid JP-10 fuel are injected into the model; the total fuel on run time for the engine was typically 15 to 20 sec. These total run times were limited by thermal constraints of the model and facility. In general, the silane/H₂ mixture was introduced about 1 sec prior to the JP-10 fuel to establish a pilot flame. Tests were conducted to establish the maximum forward station fuel flow. Subsequent tests were conducted where the forward fuel flows were set at near (75 to 80%) maximum to generate the greatest possible pilot flame. Fuel was then increased in 2.5 to 5 sec increments (based on test objectives) through the aft fuel station. The primary goal in these tests was to achieve maximum performance at both the Mach 6 and Mach 6.6 conditions by optimization of the fuel schedule.

4. RESULTS AND DISCUSSION

Through this activity 15 full duration tests were made; 10 were at Mach 6 conditions and 5 were at Mach 6.6 conditions; 13 of the runs were fueled. The facility conditions and test configuration for this test series is outlined in Table I. Fueled performance results were obtained at both simulated Mach 6 (1670 K) and Mach 6.6 (1950 K).

4.1 Inlet Operability and Performance

The initial tests were unfueled and focused on verifying that both the facility and engine flow path started at all conditions. An unfueled test was conducted for each Mach number and unfueled static pressure profiles were obtained at the first increment of each test prior to fuel incrementing. The subscale inlet flowpath study of Ref. 8 was conducted prior to the HTF test program. In this experiment the model shown in Fig. 8, which is a 40% scale of the inlet used in the current RBCC engine, was tested at the correct Mach numbers and Reynolds numbers to validate inlet operability and performance. The CFD analysis of Ref. 9 also complemented this study. Figures 9 and 10 compare the unfueled static pressure distributions achieved within the HTF RBCC flow path using both the Mach 5 and the Mach 6 facility nozzles with the equivalent results from the 40% scale 1X1 SWT tests. Corrected for scale, these profiles show that for facility exit Mach numbers of both 5 and 6 the subscale test results provided an accurate assessment of the full scale inlet performance. These

earlier studies along with supporting CFD analysis provided detailed information regarding inlet air mass capture and flow distortion.

4.2 Fueled Engine Performance

As previously described, the engine has three fueling stations and the focus of these engine tests was to achieve and quantify performance with different fuel schedules. The combustor configuration used in this study was previously demonstrated in the direct-connect experiment of Refs. 3 and 4. This established a fueling scheme for this geometry and operating conditions which resulted in both successful ignition and piloting as well as high combustion efficiency. The behavior of the inlet with backpressure in the combustor area was also characterized during the subscale 1X1 SWT flow path study. The results for this subscale study at Mach 6 are presented in Fig. 11; backpressure was achieved using the mechanical mass flow plug at the exit (Fig. 8(a)). These results indicate that significant combustor backpressure and, therefore, high engine performance is possible without inlet unstart.

A total of 13 fueled engine tests were conducted during the present program. The fueled engine test results are presented in Ref. 10. Figure 12 shows a representative pressure distribution along the length of the engine for a fueled case overlaid with a plot of a subscale inlet result. As shown, the subscale testing accurately modeled the pressure profile in the inlet/isolator region. Generally, at higher simulated Mach number, decreased combustor/inlet interaction and lower pressure ratio were observed, and higher forward fuel equivalence ratio was achieved without engine unstart. Future test plans with this engine include enhancing engine performance through the optimization of fuel distribution.

5. SUMMARY

This test program served to demonstrate the freejet ramjet operability and performance of a candidate engine flowpath for application as a Rocket Based Combined Cycle (RBCC) propulsion system at simulated Mach 6 and Mach 6.6 conditions. This engine is the strutjet concept which is designed to operate as an ejector-ramjet engine in which small rocket chambers are embedded into the struts. This activity was accomplished between July and September 1996, and 15 full duration tests were conducted. Ignition and piloting of the liquid hydrocarbon (JP-10) fuel was achieved using a gaseous pyrophoric mixture (20% SiH₄ and 80% H₂) as an ignitor. The results of this study also compared well with the results of previous studies including a 40% subscale (aerodynamic) flowpath test conducted in the LeRC 1X1 SWT, CFD analysis, and direct-connect tests of this combustor geometry.

6. CONCLUSIONS AND RECOMMENDATIONS

This test program provided a strong technical foundation by successfully demonstrating freejet performance of the engine flowpath studied. This engine system is a first generation design and several improvements could significantly enhance the performance. Optimization of the inlet is possible in order to improve the stability and reduce the distortion of the flow entering the combustor. Since subscale inlet test results were shown to accurately characterize the full scale inlet behavior, a parametric

inlet development program, including subscale testing and CFD analysis, would provide an improved inlet configuration. Optimization of the fuel distribution including both the axial stations (i.e. scheduling) and the vertical distribution of this fuel to match the air flow distribution would enhance performance. The RBCC model is relatively parametric and can be easily modified to change the inlet, struts, or combustor geometry. Additional fuel stations (manifolds) could be added within the struts or on the model side walls. Achieving good performance using liquid hydrocarbon fuels was a challenging technical objective. Obtaining comparative results with other fuels (for example, gaseous hydrocarbon or hydrogen) and/or other ignitor and piloting techniques would also be a valuable objective. The focus of these tests could be directly relevant to the current application (Mach 4 to 8 hydrocarbon fueled air-breathing missile) or could be more generic in nature providing data relative to the performance potential of candidate RBCC systems for broader applications such as space access or global transportation vehicles.

7. REFERENCES

1. Bulman, M., and Siebenhaar, A., "The Strutjet Engine: Exploding the Myths Surrounding High Speed Airbreathing Propulsion," AIAA-95-2475, July 1995.
2. Escher, W.J.D., Hyde, E.H., and Anderson, D.M., "A User's Primer for Comparative Assessments of All-Rocket and Rocket-Based Combined-Cycle Propulsion Systems for Advanced Earth-to-Orbit Space Transport Applications," AIAA-95-2474, July 1995.
3. Siebenhaar, A., and Bulman, M., "The Strutjet Engine—The Overlooked Option for Space Launch," AIAA-95-3124, July 1995.
4. Engers, R., Cresci, D., and Simonsen, R., "Test Facility Requirements for Combined Cycle Engines at Supersonic Flight Conditions," AIAA-94-2486, June 1994.
5. Thomas, S.R., Woike, M.R., and Pack, W.D., "Mach 6 Integrated Systems Tests of the NASA Lewis Research Center Hypersonic Tunnel Facility," NASA TM-107083, December 1995.
6. Thomas, S.R., Trefny, C.J., and Pack, W.D., "Operating Capability and Current Status of the Reactivated NASA Lewis Research Center Hypersonic Tunnel Facility," AIAA-95-6146, NASA TM-106808, April 1995.
7. Cullom, R.R., and Lezberg, E.A., "Calibration of Lewis Hypersonic Tunnel Facility at Mach 5, 6, and 7," NASA TN D-7100, 1972.
8. Fernandez, R., Trefny, C.J., Thomas, S.R., and Bulman, M., "Parametric Data from a Wind Tunnel Test on a Rocket Based Combined Cycle Engine Inlet," NASA TM-107181, July 1996.
9. DeBonis, J.R., and Yungster, S., "Rocket Based Combined Cycle Engine Technology Development Inlet CFD Validation and Application," AIAA-96-3145, NASA TM-107274, July 1996.
10. Thomas, S.R., Perkins, H.D., Trefny, C.J., and Bulman, M. "Mach 5 to 7 Performance Evaluation of a Rocket Based Combined Cycle Propulsion System at NASA LeRC HTF," NASA TM-107376, December 1996.

TABLE I.—FACILITY CONDITIONS SUMMARY

Run number	Data number	SiH ₄ /H ₂ flow, Y/N	FOR JP-10 flow, Y/N	AFT JP-10 flow, Y/N	Facility nozzle, Mach number	Average heater temperature, K	Nozzle mass flow, kg/s	Nozzle inlet total temperature, K	Nozzle inlet total pressure, MPa	Steady state test time, sec	Facility nozzle exit static pressure, MPa
1	8	N	N	N	5	2060	73	1360	2.52	9	0.0050
2	10	Y	Y	N	5	2250	86	1540	3.55	16	0.0049
3	14	Y	Y	N	6	2300	84	1640	7.34	20	0.0044
4	15	Y	Y	N	6	2270	84	1645	7.34	20	0.0044
5	17	Y	Y	Y	6	2270	86	1595	7.34	15	0.0043
6	18	Y	Y	Y	6	2290	84	1645	7.34	20	0.0044
7	25	Y	Y	N	6	2290	84	1645	7.34	17	0.0040
8	32	Y	Y	Y	6	2370	84	1680	7.34	18	0.0041
9	33	Y	Y	Y	6	2380	86	1585	7.34	18	0.0043
10	34	Y	Y	Y	6	2400	86	1615	7.34	23	0.0039
11	36	N	N	N	6	2610	75	1925	7.41	3	0.0038
12	38	Y	Y	N	6	2610	77	1945	7.34	15	0.0039
13	39	Y	Y	Y	6	2590	77	1915	7.34	15	0.0039
14	40	Y	Y	Y	6	2570	77	1930	7.34	17	0.0040
15	41	Y	Y	Y	6	2610	77	1945	7.34	15	0.0040

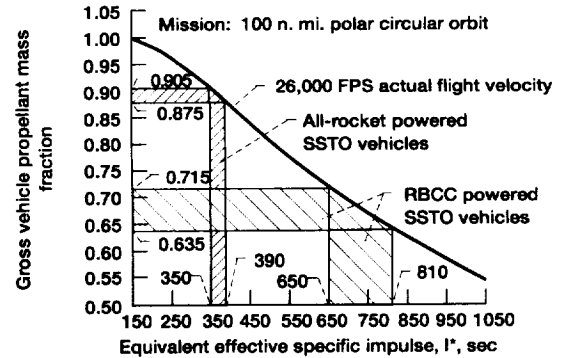
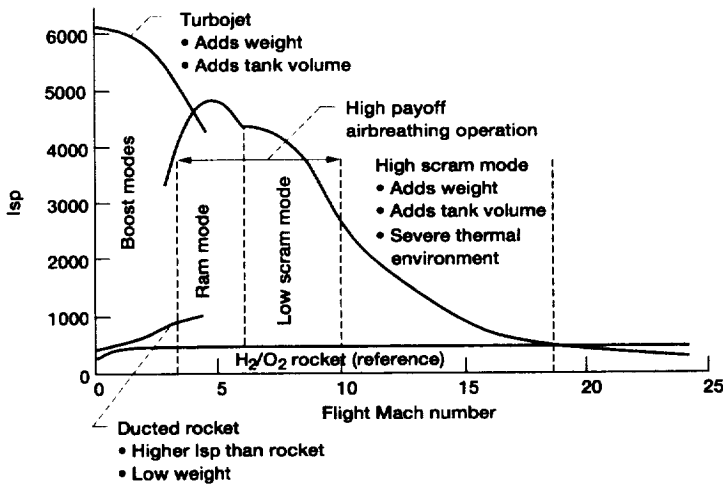

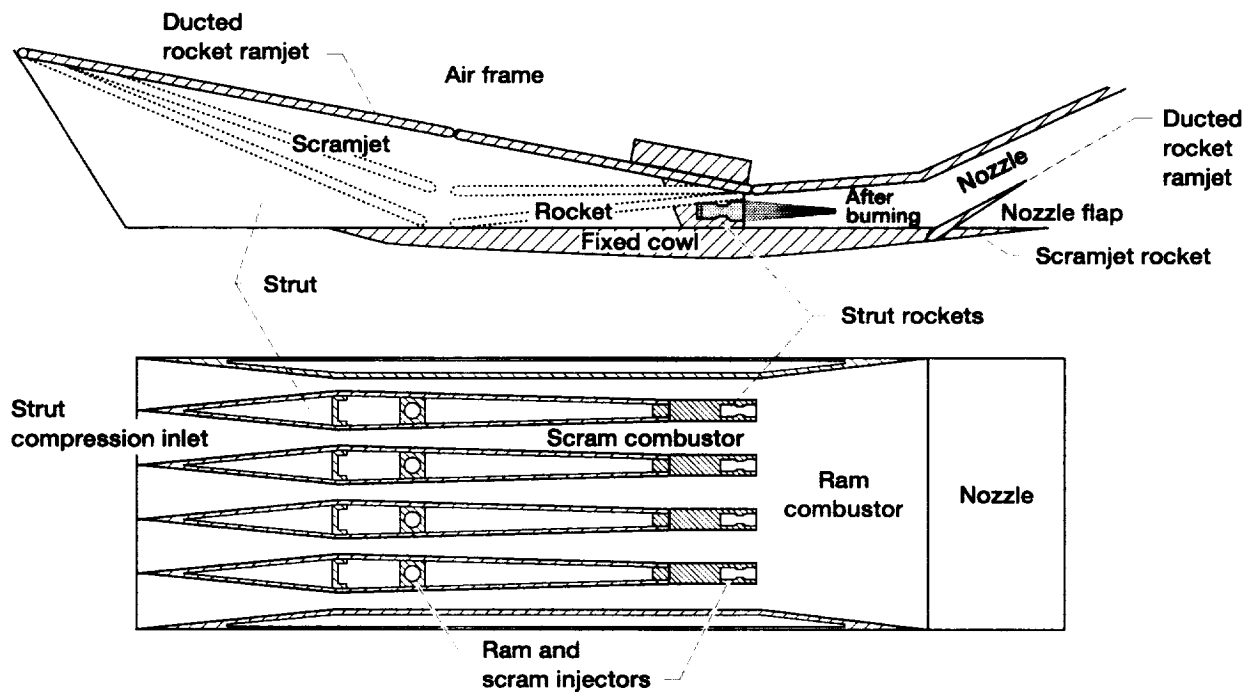

Figure 3.—Features of the strutjet engine which integrates a rocket into a ramjet propulsion system.

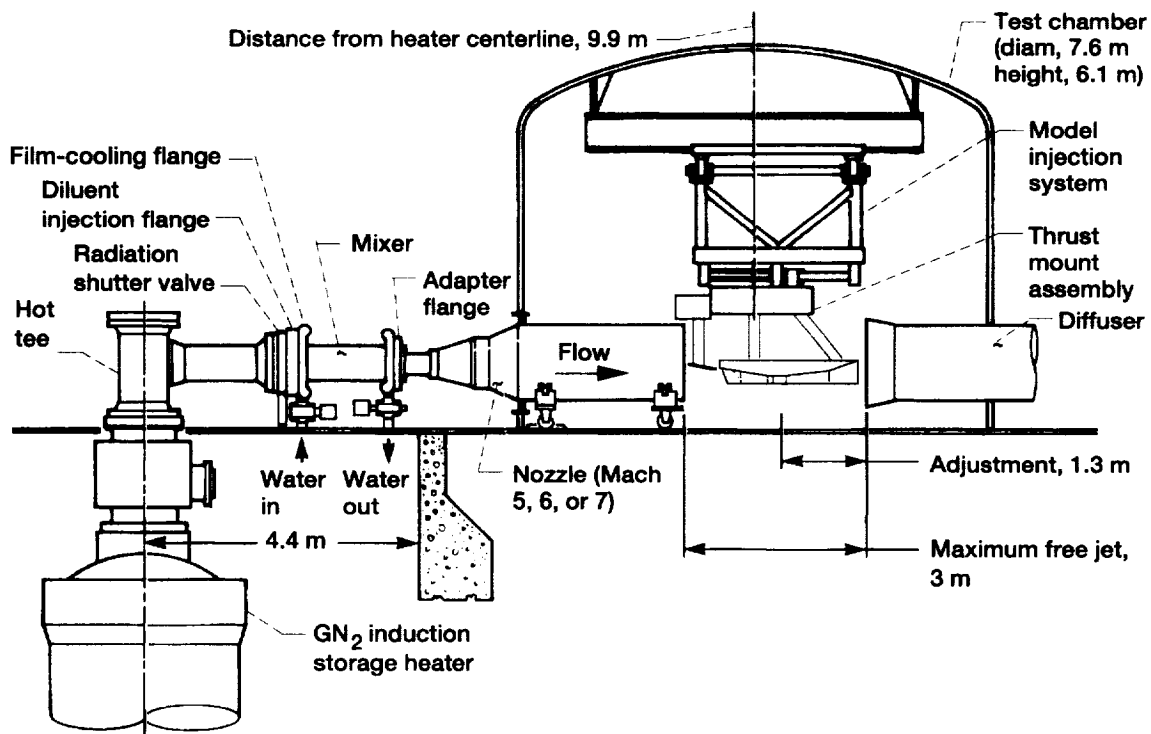

Figure 4.—Hypersonic tunnel facility (HTF) hot train and test chamber.

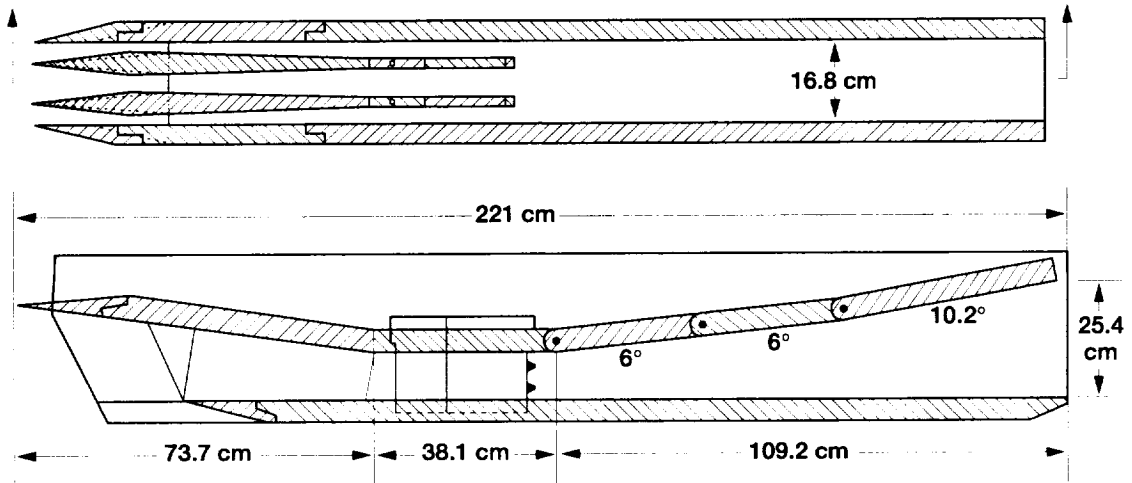

Figure 5.—RBCC engine geometry.

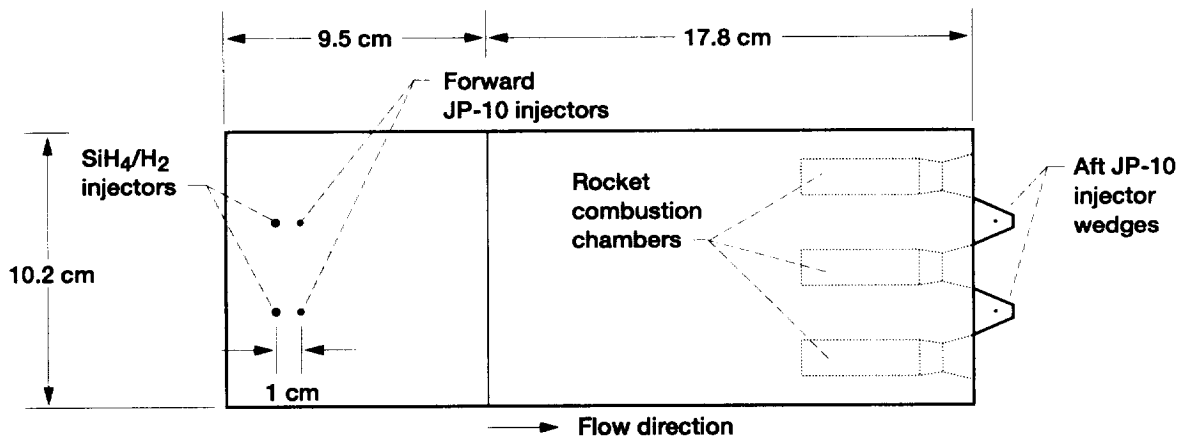

Figure 6.—Side view of forward and aft fuel injection blocks with rockets.

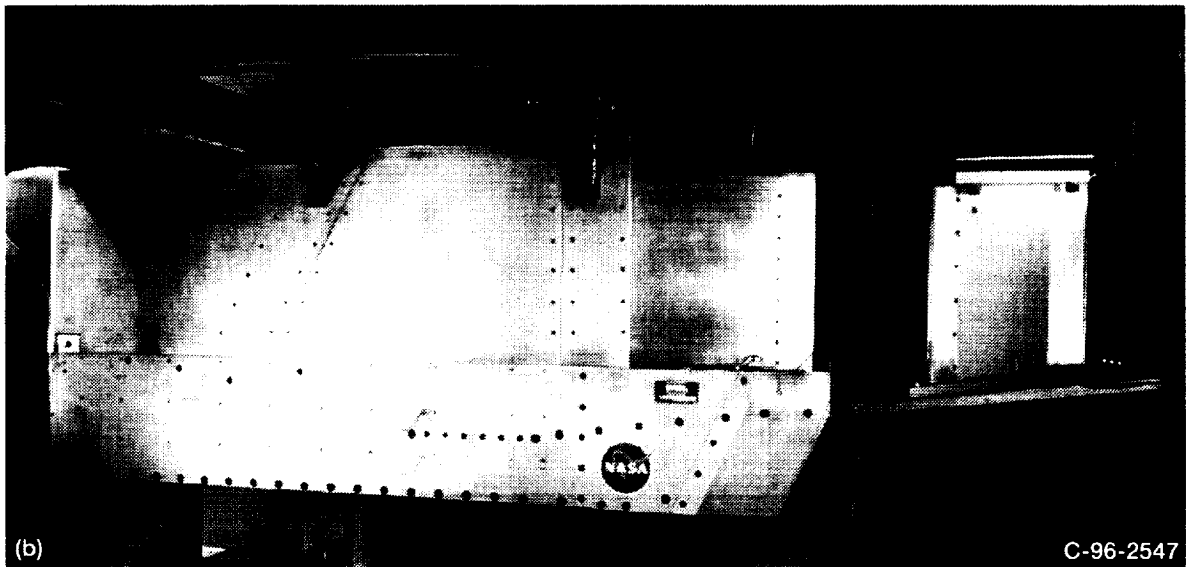
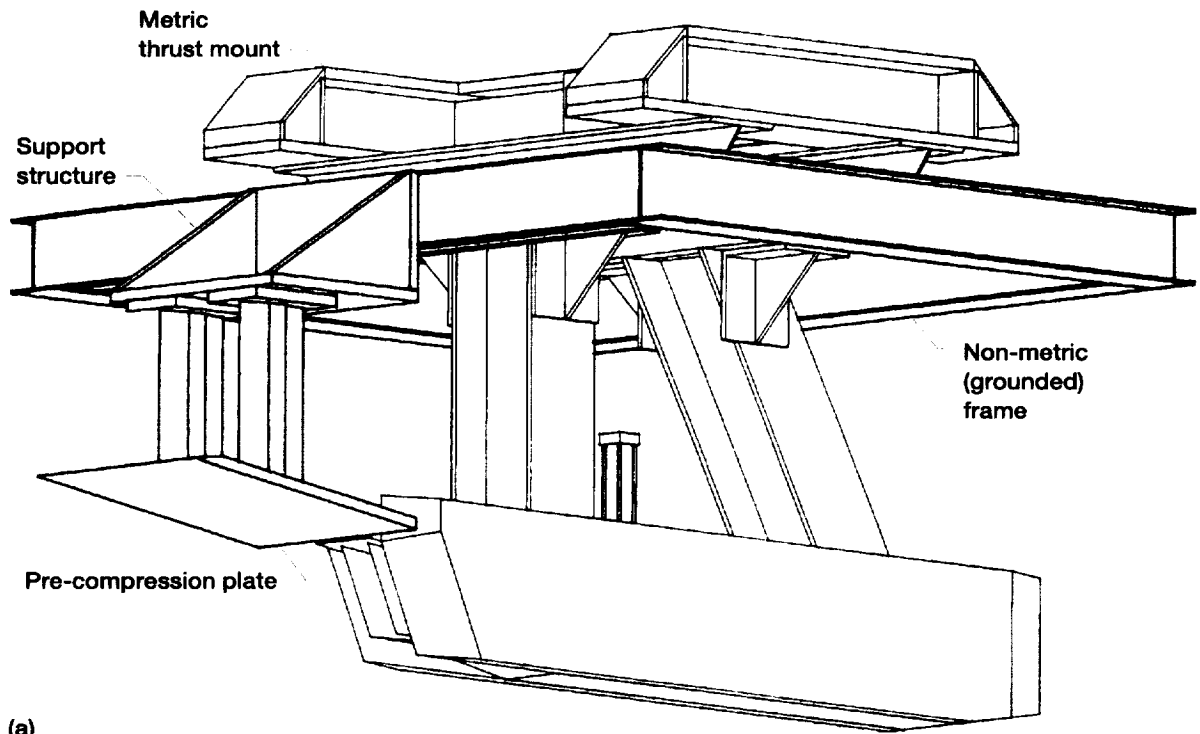

Figure 7.—Installation of RBCC engine and pre-compression plate into HTF. (a) Isometric view of model mounting. (b) Photograph of model.

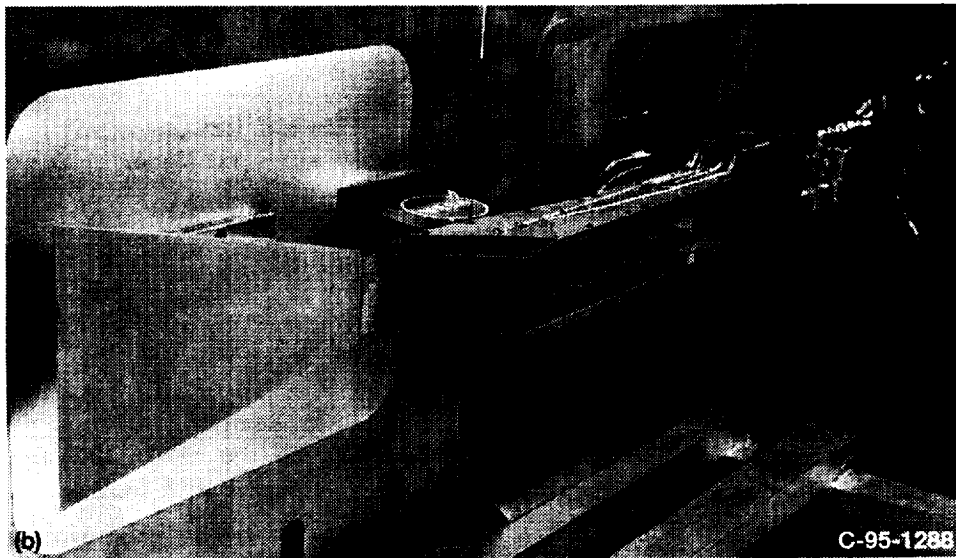
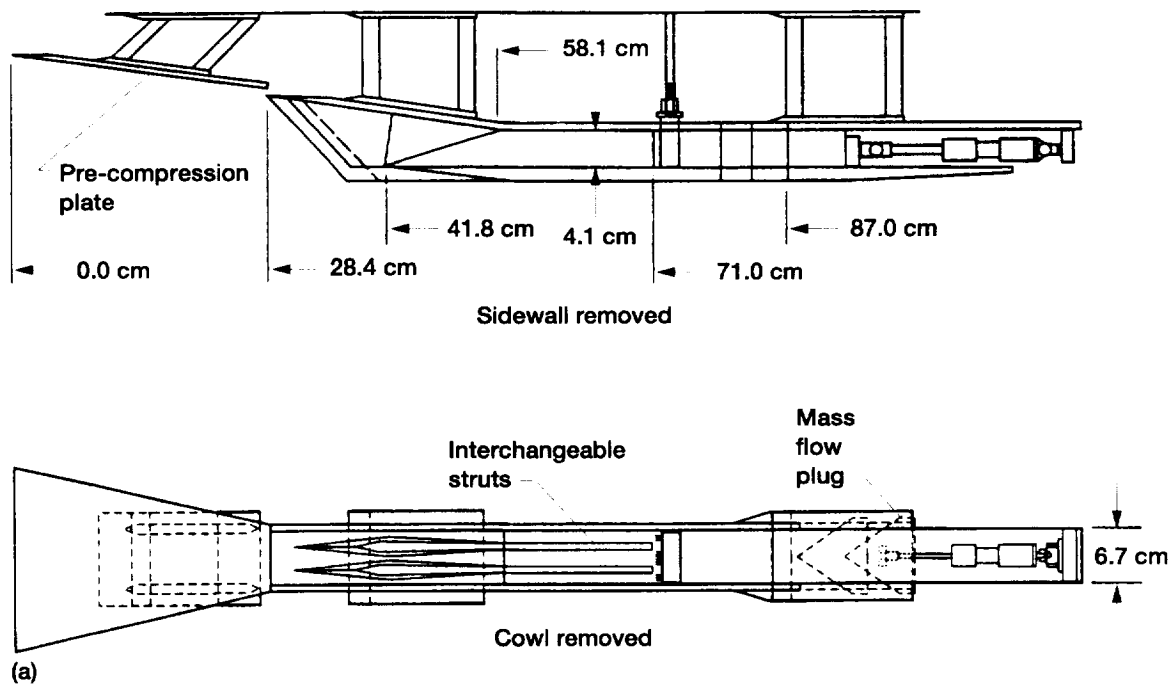

Figure 8.—Sub-scale RBCC inlet model. (a) Schematic of model flow path. (b) Photograph of model mounted on tunnel sidewall in 1x1 SWT.

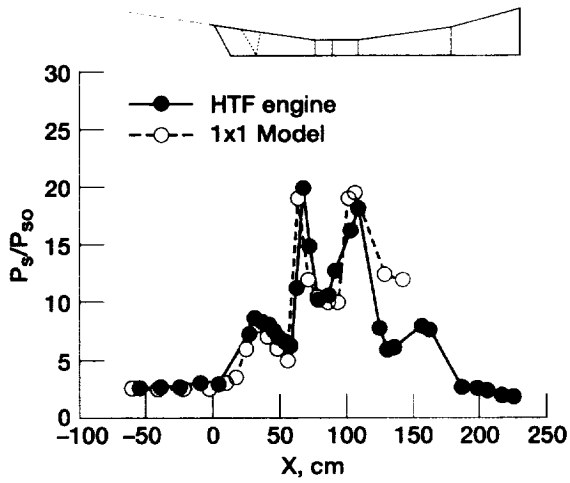

Figure 9.—Unfueled pressure distributions of HTF full scale engine and 1x1 sub-scale inlet model at Mach 5.

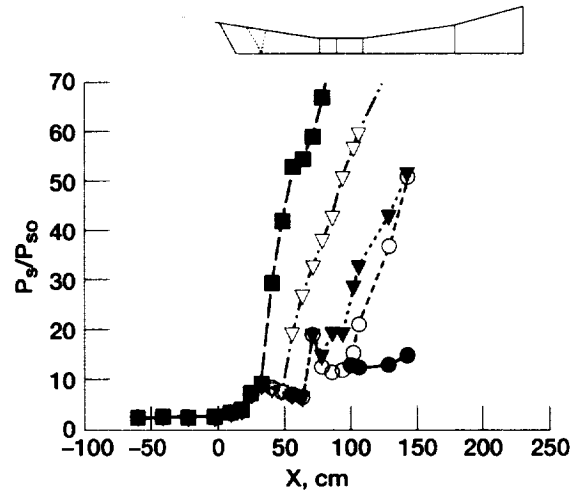

Figure 11.—Static pressure distributions for the sub-scale inlet model with increasing back-pressure at Mach 6.

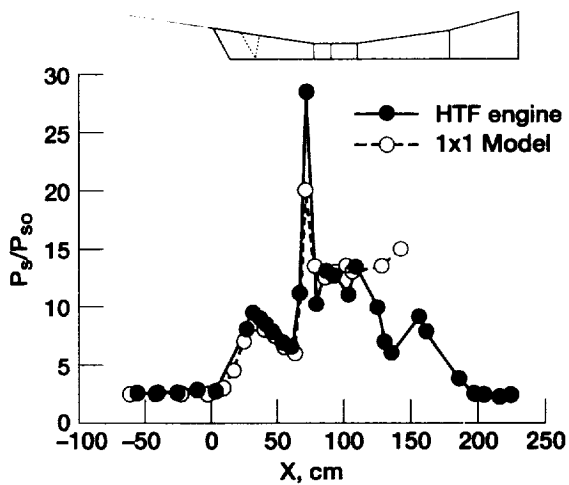

Figure 10.—Unfueled pressure distributions of HTF full scale engine and 1x1 sub-scale inlet model at Mach 6.

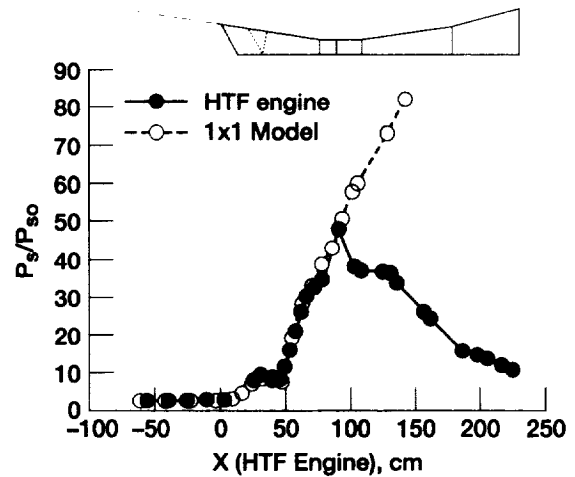

Figure 12.—Pressure distribution of fueled HTF full scale engine and mechanically backpressured 1x1 sub-scale inlet model.

REPORT DOCUMENTATION PAGE

Form Approved
OMB No. 0704-0188

Public reporting burden for this collection of information is estimated to average 1 hour per response, including the time for reviewing instructions, searching existing data sources, gathering and maintaining the data needed, and completing and reviewing the collection of information. Send comments regarding this burden estimate or any other aspect of this collection of information, including suggestions for reducing this burden, to Washington Headquarters Services, Directorate for Information Operations and Reports, 1215 Jefferson Davis Highway, Suite 1204, Arlington, VA 22202-4302, and to the Office of Management and Budget, Paperwork Reduction Project (0704-0188), Washington, DC 20503.

1. AGENCY USE ONLY (Leave blank)		2. REPORT DATE March 1997	3. REPORT TYPE AND DATES COVERED Technical Memorandum	
4. TITLE AND SUBTITLE Evaluation of an Ejector Ramjet Based Propulsion System for Air-Breathing Hypersonic Flight			5. FUNDING NUMBERS WU-523-61-13	
6. AUTHOR(S) Scott R. Thomas, H. Douglas Perkins, and Charles J. Trefny				
7. PERFORMING ORGANIZATION NAME(S) AND ADDRESS(ES) National Aeronautics and Space Administration Lewis Research Center Cleveland, Ohio 44135-3191			8. PERFORMING ORGANIZATION REPORT NUMBER E-10665	
9. SPONSORING/MONITORING AGENCY NAME(S) AND ADDRESS(ES) National Aeronautics and Space Administration Washington, DC 20546-0001			10. SPONSORING/MONITORING AGENCY REPORT NUMBER NASA TM-107422	
11. SUPPLEMENTARY NOTES Prepared for the 89th Symposium sponsored by the Propulsion and Energetics Panel of the NATO Advisory Group for Aerospace Research and Development, Palaiseau, France, April 14-17, 1997. Responsible person, Scott R. Thomas, organization code 0142, (216) 433-5880.				
12a. DISTRIBUTION/AVAILABILITY STATEMENT Unclassified - Unlimited Subject Categories 07 and 09 This publication is available from the NASA Center for AeroSpace Information, (301) 621-0390.			12b. DISTRIBUTION CODE	
13. ABSTRACT (Maximum 200 words) A Rocket Based Combined Cycle (RBCC) engine system is designed to combine the high thrust to weight ratio of a rocket along with the high specific impulse of a ramjet in a single, integrated propulsion system. This integrated, combined cycle propulsion system is designed to provide higher vehicle performance than that achievable with a separate rocket and ramjet. The RBCC engine system studied in the current program is the Aerojet strutjet engine concept, which is being developed jointly by a government-industry team as part of the Air Force HyTech program pre-PRDA activity. The strutjet is an ejector-ramjet engine in which small rocket chambers are embedded into the trailing edges of the inlet compression struts. The engine operates as an ejector-ramjet from take-off to slightly above Mach 3. Above Mach 3 the engine operates as a ramjet and transitions to a scramjet at high Mach numbers. For space launch applications the rockets would be re-ignited at a Mach number or altitude beyond which air-breathing propulsion alone becomes impractical. The focus of the present study is to develop and demonstrate a strutjet flowpath using hydrocarbon fuel at up to Mach 7 conditions. Freejet tests of a candidate flowpath for this RBCC engine were conducted at the NASA Lewis Research Center's Hypersonic Tunnel Facility between July and September 1996. This paper describes the engine flowpath and installation, outlines the primary objectives of the program, and describes the overall results of this activity. Through this program 15 full duration tests, including 13 fueled tests were made. The first major achievement was the further demonstration of the HTF capability. The facility operated at conditions up to 1950°K and 7.34 MPa, simulating approximately Mach 6.6 flight. The initial tests were unfueled and focused on verifying both facility and engine starting. During these runs additional aerodynamic appliances were incorporated onto the facility diffuser to enhance starting. Both facility and engine starting were achieved. Further, the static pressure distributions compared well with the results previously obtained in a 40% subscale flowpath study conducted in the LeRC 1×1 supersonic wind tunnel (SWT), as well as the results of CFD analysis. Fueled performance results were obtained for the engine at both simulated Mach 6 (1670 °K) and Mach 6.6 (1950 °K) conditions. For all these tests the primary fuel was liquid JP-10 with gaseous silane (a mixture of 20% SiH ₄ and 80% H ₂ by volume) as an ignitor/pilot. These tests verified performance of this engine flowpath in a freejet mode. High combustor pressures were reached and significant changes in axial force were achieved due to combustion. Future test plans include redistributing the fuel to improve mixing, and consequently performance, at higher equivalence ratios.				
14. SUBJECT TERMS Hypersonic propulsion; Combined cycle propulsion; Ramjet; Scramjet; Ejector ramjet			15. NUMBER OF PAGES 12	
			16. PRICE CODE A03	
17. SECURITY CLASSIFICATION OF REPORT Unclassified	18. SECURITY CLASSIFICATION OF THIS PAGE Unclassified	19. SECURITY CLASSIFICATION OF ABSTRACT Unclassified	20. LIMITATION OF ABSTRACT	