

---

# Predicted Performance of a Thrust-Enhanced SR-71 Aircraft with an External Payload

---

Timothy R. Conners  
*NASA Dryden Flight Research Center  
Edwards, California*

1997



National Aeronautics and  
Space Administration

Dryden Flight Research Center  
Edwards, California 93523-0273



# PREDICTED PERFORMANCE OF A THRUST-ENHANCED SR-71 AIRCRAFT WITH AN EXTERNAL PAYLOAD

Timothy R. Conners\*  
NASA Dryden Flight Research Center  
Edwards, California

## ABSTRACT

NASA Dryden Flight Research Center has completed a preliminary performance analysis of the SR-71 aircraft for use as a launch platform for high-speed research vehicles and for carrying captive experimental packages to high altitude and Mach number conditions. Externally mounted research platforms can significantly increase drag, limiting test time and, in extreme cases, prohibiting penetration through the high-drag, transonic flight regime.

To provide supplemental SR-71 acceleration, methods have been developed that could increase the thrust of the J58 turbojet engines. These methods include temperature and speed increases and augmentor nitrous oxide injection. The thrust-enhanced engines would allow the SR-71 aircraft to carry higher drag research platforms than it could without enhancement.

This paper presents predicted SR-71 performance with and without enhanced engines. A modified climb-dive technique is shown to reduce fuel consumption when flying through the transonic flight regime with a large external payload. Estimates are included of the maximum platform drag profiles with which the aircraft could still complete a high-speed research mission. In this case, enhancement was found to increase the SR-71 payload drag capability by 25 percent. The thrust enhancement techniques and performance prediction methodology are described.

## NOMENCLATURE

DAFICS	digital automatic flight and inlet control system
DPS	digital performance simulation
GHRV	generic hypersonic research vehicle
KEAS	equivalent airspeed, knots
N <sub>2</sub> O	nitrous oxide
TT5	turbine exhaust temperature, deg F
WFAB	augmentor fuel flow, lb/hr

---

\* Aerospace Engineer.

## INTRODUCTION

There are several high-supersonic experiment packages currently in design that call for flight test verification. These packages include advanced ramjet and rocket engine, inlet, and aerodynamic concepts for hypersonic vehicles,<sup>1</sup> as well as concepts that could benefit the high-speed commercial aviation research effort. The NASA Dryden Flight Research Center SR-71 aircraft (fig. 1) offer the capability to acquire long-duration flight test time at high altitudes and supersonic speeds in a captive-carry test environment. In cases where hypersonic Mach number data are required, the SR-71 aircraft can feasibly provide air-launch capability for large-scale hypersonic research vehicles (fig. 2).

A structurally modified SR-71 aircraft can carry external payloads weighing up to 20,000 lbm (9072 kg). This large weight limit permits flexibility in the configuration of a research package. However, within this weight limit, it is easy to design an external payload package whose additional drag exceeds the excess thrust capability of an SR-71 aircraft using unmodified J58 engines. This effect was seen during feasibility studies performed by Lockheed Advanced Development Company (Palmdale, California) and NASA for a generic hypersonic research vehicle (GHRV). The GHRV was to be air-launched from the SR-71 vehicle and accelerate under its own power to speeds greater than Mach 10. The vehicle was to be used primarily for investigating scramjet engine performance.

Performance simulations had indicated that without additional excess thrust, the SR-71/GHRV combination could not accelerate through the transonic drag rise. Therefore, in support of the GHRV effort, Pratt & Whitney (West Palm Beach, Florida) performed a feasibility study under subcontract to Lockheed to increase the thrust of the J58 engines.<sup>2</sup> The goal of the study was a 10 percent net thrust increase within the transonic Mach range. This increase was deemed capable of providing adequate margin to allow the vehicle to reach its cruise condition. The study concluded that the goal was achievable by using compressor rotor speed and turbine

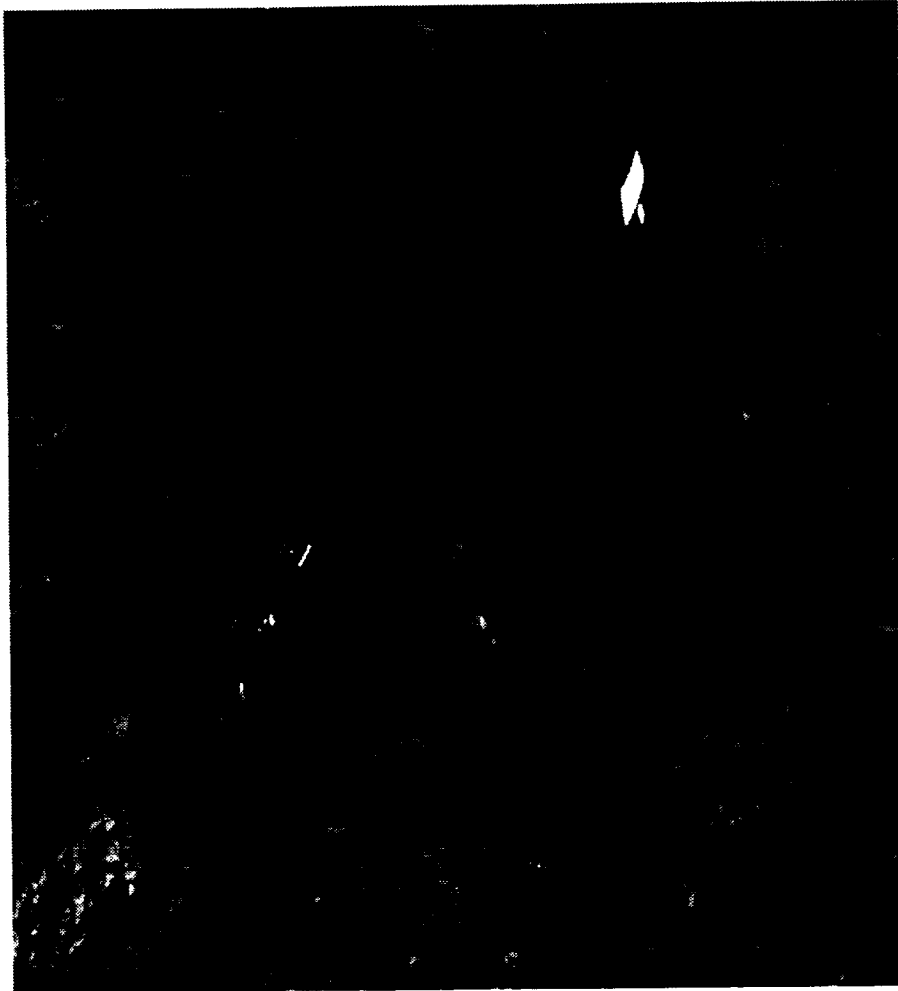

EC91-520-7

FIGURE 1. ONE OF THE THREE NASA DRYDEN SR-71 AIRCRAFT.

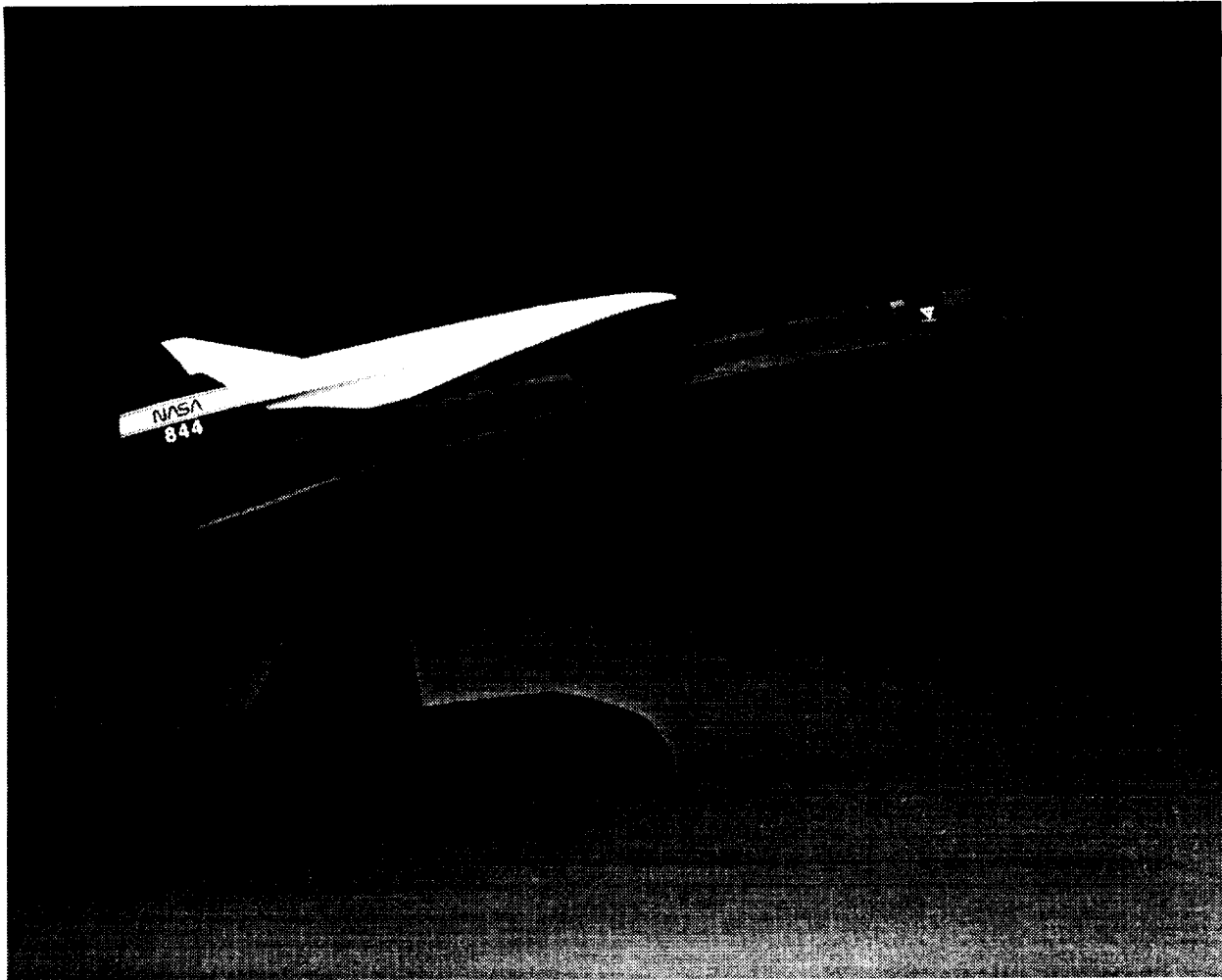

EC92-7241-3

FIGURE 2. MODEL OF THE SR-71 AIRCRAFT AND BACK-MOUNTED GENERIC HYPERSONIC RESEARCH VEHICLE.

exhaust temperature,  $TTS$ , increases along with nitrous oxide,  $N_2O$ , augmentor injection.

The GHRV program did not proceed beyond the study phase. However, the feasibility of the engine modifications has made the enhancement technique an option for any future external payload mission where SR-71 transonic acceleration capability is questionable or in which test time at high Mach conditions must be maximized.

This paper presents the results of a preliminary analysis and simulation study of SR-71 performance with additional drag from externally mounted payloads. Maximum payload drag profiles with which the SR-71 aircraft can complete a research mission to the target test condition of Mach 3 at an altitude of 70,000 ft (21,336 m) with and without the use of the J58 thrust enhancement techniques are compared. In addition, the benefits of using thrust enhancement are shown using the drag profile for an air-launched GHRV.

A fuel-saving climb technique is discussed. The thrust enhancement options, along with the simulation methodologies used for this study, are also described.

#### AIRCRAFT DESCRIPTION

The SR-71 aircraft, built by Lockheed, is a long-range, two-place, twin-engine airplane capable of cruising at speeds up to Mach 3.2 and altitudes up to 85,000 ft (25,908 m).<sup>3</sup> The aircraft is characterized by its black paint scheme; long, slender body; large delta wing; and prominent, spiked engine nacelles located midway out on each wing (fig. 3). Inboard and outboard elevons provide longitudinal and lateral control while twin, inboard-canted, all-moving rudders mounted on top of the nacelles provide directional control. The fuselage flares outboard along each side of the aircraft from the wing to the nose to form the chine. Within the nose

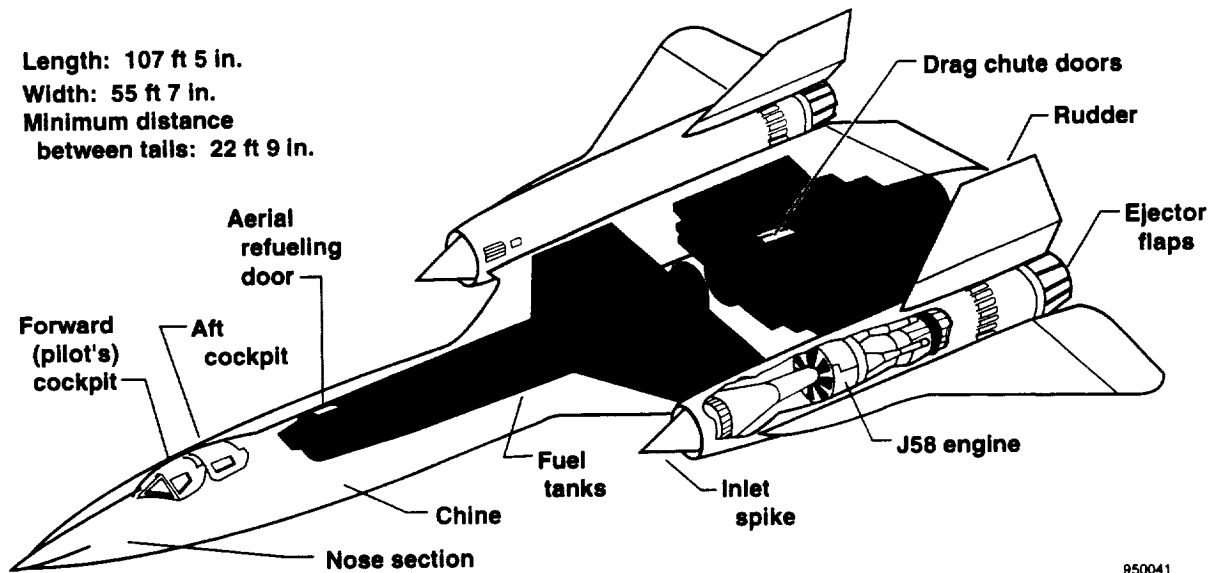

FIGURE 3. GENERAL ARRANGEMENT OF THE SR-71 AIRCRAFT.

and chine are several payload storage bays accessible from underneath the aircraft. The SR-71 aircraft would be structurally modified to carry large external payloads.

NASA Dryden currently has possession of two SR-71A vehicles and one B model.<sup>4</sup> The SR-71A models were previously used for military reconnaissance, whereas the SR-71B model was used for training. Except for its elevated second cockpit and nacelle ventral fins, the B model is similar to the A model in appearance and performance.

### PROPULSION SYSTEM DESCRIPTION

The propulsion system of the SR-71 aircraft has three primary components. These components are axisymmetric mixed compression inlets, Pratt & Whitney J58 turbojet engines, and airframe-mounted, convergent-divergent blow-in door ejector nozzles.<sup>5</sup>

The inlet spike (fig. 4) translates longitudinally, depending on Mach number, and controls the throat area. The spike provides efficient and stable inlet shock structure throughout the Mach range. At the design cruise speed, most of the net propulsive force derives from flow compression pressure on the forward facing surfaces of the spike. Besides the spike, other inlet controls include the forward and aft bypass doors, used to maintain terminal shock position and to remove excess air from the inlet; and cowl and spike bleeds, used to control boundary layer growth.

The SR-71 aircraft is powered by two 34,000 lbf (151,240 N) thrust-class J58 afterburning turbojet engines (fig. 5). Each engine contains a nine-stage compressor driven by a two-stage turbine. The main burner uses an eight-can combustor. The afterburner is fully modulating. The primary nozzle area is variable. Above Mach 2.2, some of the airflow is bled from the fourth stage of the compressor and dumped into the augmentor inlet through six bleed-bypass tubes, circumventing the core of the engine and

transitioning the propulsive cycle from a pure turbojet to a turbo-ramjet. The engine is hydromechanically controlled and burns a special low volatility jet fuel mixture known as JP7.

The inlet bleed and aft bypass flow mix with engine exhaust flow just forward of the airframe-mounted ejector nozzle. Blow-in doors on the ejector nozzle remain open at low speeds and entrain additional mass flow into the exhaust stream. At high speeds, the doors close and the airframe nozzle ejector flaps reposition to form a convergent-divergent geometry. The blow-in doors and ejector flaps are positioned by aerodynamic forces.

The engine spikes and forward bypass doors are positioned by commands from the digital automatic flight and inlet control system (DAFICS). The DAFICS provides precise control of the terminal shock position. The DAFICS has significantly improved vehicle performance and range and has virtually eliminated inlet unstart, compared to the older analog control system.

### THRUST ENHANCEMENT DESCRIPTION

Several options for increasing the thrust of the J58 engine have been analytically evaluated.<sup>2</sup> These options included increasing *TT5*; increasing compressor rotor speed; modifying the compressor bleed and inlet guide vane schedules; and increasing the augmentor fuel flow, *WFAB*, combined with oxidizer injection.

### Engine Control Modifications

NASA Dryden desired that thrust enhancements allow for a minimum 50-hr engine life (time between overhaul). In response, Pratt & Whitney estimated that a combination of 150 RPM rotor speed increase and 75 °F (297 °K) *TT5* increase would reduce the engine life to this 50-hr limit (fig. 6) while increasing net thrust an average of 5 percent throughout the Mach range of the vehicle (fig. 7). The second-stage turbine would be the life-limited component.

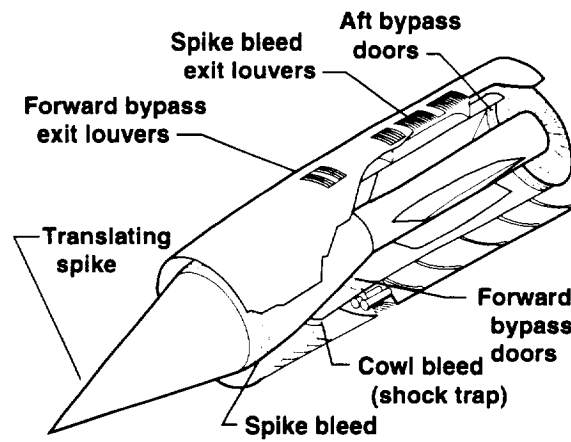
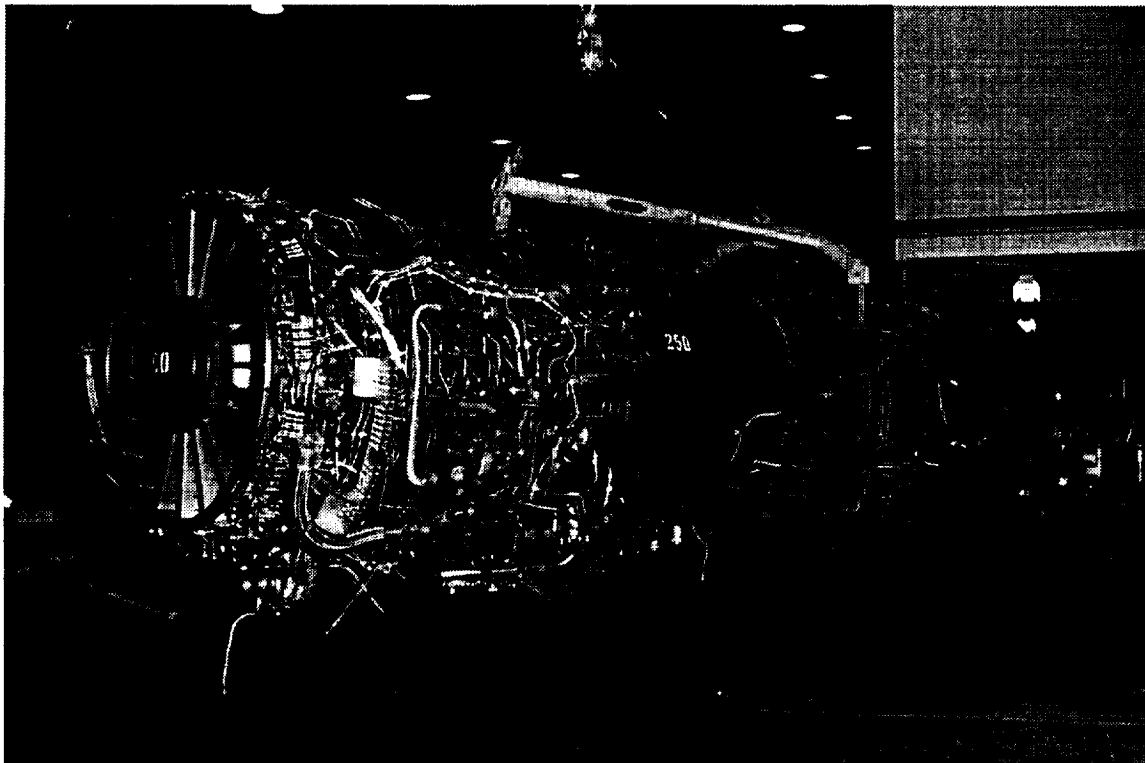

FIGURE 4. INLET CUTAWAY VIEW WITH FEATURES.



E-25901

FIGURE 5. THE J58 TURBOJET ENGINE.

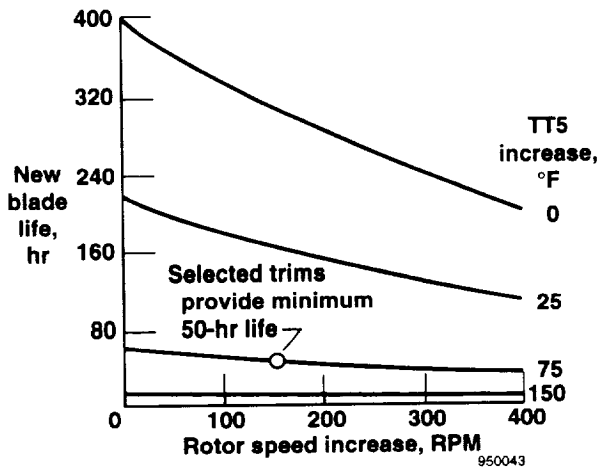

FIGURE 6. SECOND STAGE TURBINE BLADE LIFE LOSS AS A FUNCTION OF INCREASING ROTOR SPEED AND TURBINE EXHAUST TEMPERATURE.

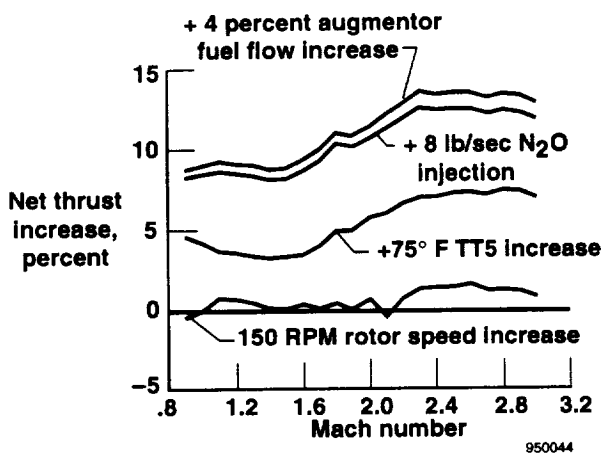

FIGURE 7. CUMULATIVE NET THRUST INCREASES FROM INDIVIDUAL THRUST ENHANCEMENT OPTIONS FOR 500 KEAS.

Increasing *TT5* and rotor speed would involve relatively simple mechanical adjustments to the main fuel control that could be done in the field.

The augmentor fuel control would also require a mechanical adjustment that would increase *WFAB* by approximately 4 percent throughout the Mach range. This extra fuel flow would take advantage of the oxidizer available from the  $N_2O$  injection, providing additional thrust.

The previous study did not recommend changing the bleed or inlet guide vane schedules without further analysis because of potential engine stability problems.

## Nitrous Oxide Injection System

The previous study also concluded that augmentor oxidizer injection was feasible and recommended  $N_2O$  as the oxidizer.<sup>2</sup> The  $N_2O$  was suitable because of its ease in handling, nonvolatility, and lack of toxicity. Other oxidizers, including hydrogen peroxide, were ruled out primarily because of operational safety concerns or the need for extensive cryogenic handling procedures. The  $N_2O$  injection, combined with a simultaneous *WFAB* increase, was predicted to provide at least an additional 5 percent net thrust increase throughout the SR-71 Mach range (fig. 7).

The study recommended that the  $N_2O$  delivery system use four close-coupled spray rings, one residing within each aft-facing notch of the four standard flameholders.<sup>2</sup> Figure 8 shows a cut-away view of the forward augmentor duct along with the installation locations of the oxidizer spray rings. Quarter-inch, high-temperature flexline tubing comprising the spray rings would contain a total of 358 orifices, each 0.025 in. (0.635 mm) in diameter. The orifices would spray the  $N_2O$  onto the inside surfaces of the flameholders.

Based on ground test results, this type of arrangement should provide good mixing with the turbine exhaust air and effective decomposition of the oxidizer without causing thermal damage to the flameholders. Combustion efficiency is expected to remain as high as it is in a standard augmentor.

The previous study considered only the  $N_2O$  delivery system. NASA Dryden developed a preliminary concept for storing the oxidizer within the vehicle. This application used portions of an SR-71 payload bay hydrogen storage concept developed for a proposed transonic drag reduction experiment in support of hypersonic vehicle research.<sup>6</sup> Storage tank volumes, weights, dimensions, and arrangements from that study were used to estimate a feasible payload bay  $N_2O$  capacity range for the present application.

Additional oxidizer storage volume could also be traded for existing JP7 fuselage fuel tank capacity, but not without the very large expense required for such a major airframe conversion. This option was not thought to be feasible, so only the payload bay volume was considered for  $N_2O$  storage.

Using data from the hydrogen storage design, it was estimated that a total volume of approximately 43 ft<sup>3</sup> (1.22 m<sup>3</sup>) using 13 in-line high-pressure cylinders would be available for  $N_2O$  storage. Figure 9 shows the proposed oxidizer tank arrangement in the SR-71 aircraft. A gaseous nitrogen purge system, along with connection and pressure regulation hardware, would fit comfortably in the remaining storage space. This system would provide a total liquid  $N_2O$  mass capacity of approximately 2700 lbm (1225 kg) at a storage temperature of 0 °F (255.4 °K) using a system pressure of less than 800 psia (5,516,000 N/m<sup>2</sup>). The payload bays are all supplied with cooling air from the environmental control system. The cooling air would be used to limit the temperature rise of the oxidizer before it is used. The total empty weight of the  $N_2O$  storage and delivery system was estimated to be less than 2000 lb (907 kg).

The previous study suggested a metered  $N_2O$  rate of 8 lb/sec (3.6 kg/sec) for each engine. With an on-board capacity of 2700 lb (1225 kg), the selected flow rate gives a total possible oxidizer delivery time of 169 sec. Higher flow rates are achievable, but not without risk of thermally choking the J58 nozzle. Regardless, the



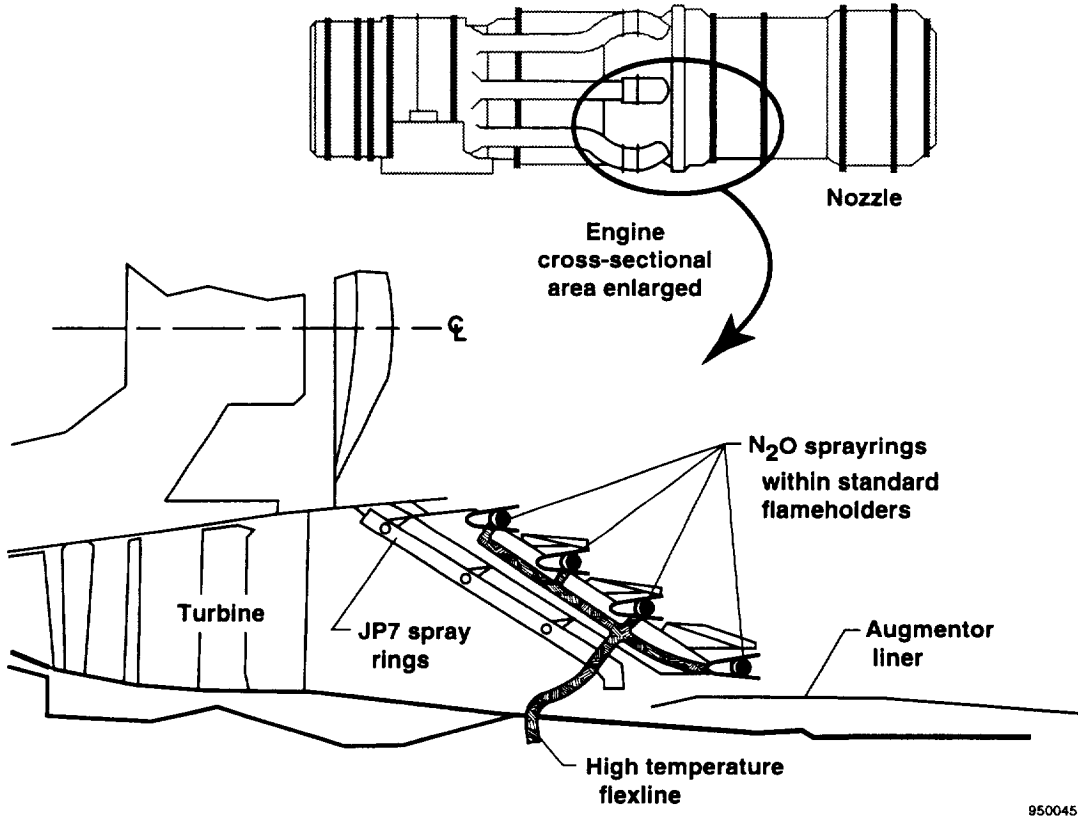

950045

FIGURE 8. AUGMENTOR CUTAWAY SHOWING PROPOSED N<sub>2</sub>O SPRAY RING LOCATION.

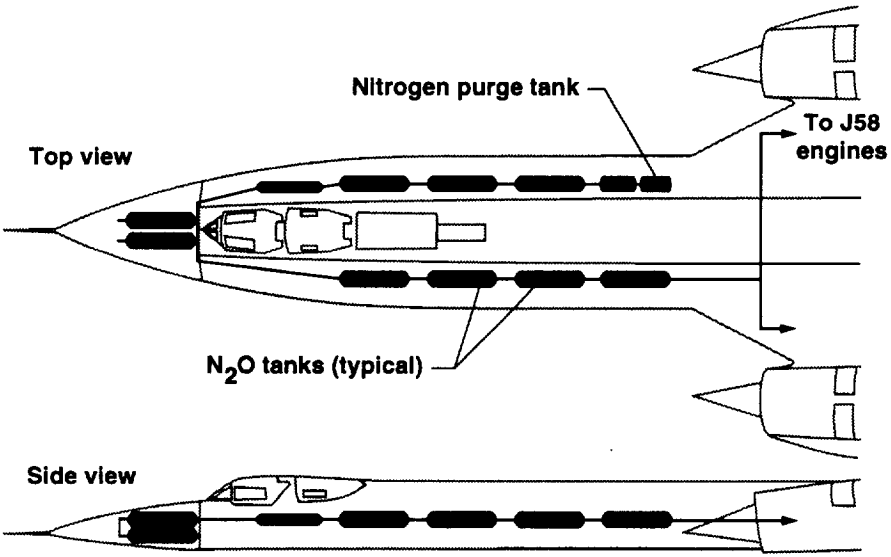

950046

FIGURE 9. N<sub>2</sub>O TANK ARRANGEMENT IN NOSE AND CHINE PAYLOAD BAYS.

increased thrust from extra flow would be offset by the disadvantage of decreased delivery time.

In combination, the engine control modifications and N<sub>2</sub>O injection were predicted to provide at least the 10 percent net thrust increase goal throughout most of the Mach range. The increase would be slightly less transonically.

## DIGITAL PERFORMANCE SIMULATION DESCRIPTION

NASA Dryden has developed a simplified aircraft performance simulation program that models many of its primary flight test vehicles.<sup>7</sup> This FORTRAN program, known as the digital performance simulation (DPS), consists of a main routine containing the aircraft equations of motion and several subroutines. The subroutines include one for each of the modeled aircraft and contain the lift, drag, thrust, and fuel flow data unique to that aircraft. A front-end subroutine creates an interactive interface from which the user can select the desired aircraft and then select which type of maneuver is to be modeled. Maneuver options include constant Mach and airspeed climbs, level accelerations, and constant *g* pushovers or pull-ups. The user is asked for initial and ending conditions. After execution, the DPS displays the output of the aircraft states and performance as a function of time.

The DPS equations of motion use four assumptions that simplify the program while maintaining its fidelity for most maneuvers and applications: point-mass modeling, nonturbulent atmosphere, zero side forces, and a nonrotating Earth. The primary advantages of using the DPS over a piloted real-time simulator are that it is much easier to modify the aerodynamic and propulsion data tables, and the DPS easily allows back-to-back comparisons of vehicle performance using a maneuver flown exactly the same in each case despite a varying vehicle configuration. Also, the DPS computes aircraft performance in compressed time, allowing much faster viewing of the results than if the maneuvers were flown in real-time on a piloted simulator.

An SR-71 DPS module was developed specifically for this study to predict vehicle performance with and without the drag and weight corresponding to the external payload and the additional thrust and fuel flow associated with the enhanced J58 engines. The aircraft aerodynamic and propulsion data used to build the baseline SR-71 model were supplied by Lockheed.<sup>8</sup> The thrust increase and fuel flow data for the engine enhancement options were supplied by Pratt & Whitney. Isolated hypersonic vehicle drag data were provided by the NASA Ames Research Center and were based on a derivative of the original GHRV. Lockheed supplied estimates of the payload interference drag. The thrust enhancement data and payload drag data were then added to the DPS code as separate arrays and available as increments to the baseline data for use in the performance computations.

Once developed, the baseline DPS SR-71 option was verified against flight data from the pilot's flight manual.<sup>9</sup> Different climb schedules were analyzed at standard day conditions. The resulting predicted elapsed time, fuel usage, and range data were compared to the values in the manual. The predictions compared closely to the actual flight data. It was believed the DPS model could be confidently used for estimating vehicle performance with additional payload drag and the thrust enhancement options.

## RESULTS AND DISCUSSION

This section presents a fuel-saving climb technique for use with a heavy payload during the ascent to the target test condition of Mach 3 at an altitude of 70,000 ft (21,336 m). Specific time and fuel savings using thrust enhancement with a high-drag payload mounted to the SR-71 aircraft are shown. The maximum external payload drag capability of the SR-71 aircraft using thrust enhancement is also presented.

### Optimal Climb Schedule Selection

An early goal of this study was to determine the most fuel-efficient climb schedule for the SR-71 aircraft so that test time at the target test condition or the payload drag that could be accommodated to that condition would be maximized. This optimal schedule analysis focused on the transonic and higher speed range because the vehicle would be refueled at Mach 0.75 and an altitude of 25,000 ft (7620 m) soon after takeoff.

After refueling, the SR-71 aircraft is normally piloted along a constant Mach 0.9 climb to approximately 33,000 ft (10,058 m), pushed over at a 3000 ft/min (914 m/min) descent to approximately 30,000 ft (9144 m), and pulled out in a level acceleration to 450 KEAS (Mach 1.25). This transonic penetration procedure is known as the climb-dive technique. At 450 KEAS, the vehicle initiates a constant equivalent airspeed climb to Mach 2.6. At this Mach number, equivalent airspeed is slowly reduced until the vehicle reaches the design cruise condition (3.2 maximum Mach number and 85,000 ft (25,908 m) maximum altitude). The climb-dive technique was discovered by Redin in the early 1970s to use less fuel than level transonic acceleration at 25,000 ft (7620 m) uses.<sup>10</sup>

Using high payload drag increments, the climb-dive technique was reevaluated using different pushover and pull-out altitudes to see if another combination gave greater fuel savings than were realized without payload drag in Redin's research. High pushover altitudes up to 37,000 ft (11,278 m) offered large fuel savings. However, altitudes greater than 33,000 ft (10,058 m) were not used because, subsonically, the SR-71 aircraft can approach uncontrollable pitch-up conditions there. Pull-out altitudes below 28,000 ft (8534 m) offered slightly greater benefits than those above 28,000 ft (8534 m), but were avoided because focused sonic boom effects on the population become an issue.

The most feasible combination was a pushover altitude of 33,000 ft (10,058 m) combined with a pull-out altitude of 28,000 ft (8534 m). Also used was an increased descent rate of 6000 ft/min (1829 m/min) previously found by Redin to still offer a manageable piloting task. The selected schedule used approximately 2800 lbm (1270 kg) less of JP7 than level transonic acceleration at 25,000 ft (7620 m) would have used. This fuel savings for the high-drag configuration was substantially higher than that previously predicted by Redin for a clean (no additional external drag) vehicle.

In the GHRV feasibility report, Lockheed recommended that the traditional 450 KEAS supersonic climb schedule be replaced with a 500 KEAS profile. The benefit of the higher KEAS schedule is an increase in excess thrust and the corresponding ability to handle higher payload drag than the 450 KEAS schedule can handle. This equivalent airspeed currently represents the right-hand edge of the conventional envelope and would require a very precise piloting technique to avoid overspeeding the aircraft. Otherwise,

Lockheed did not foresee any operability problems flying at this equivalent airspeed.

Figure 10 shows that, using the above selected transonic climb-dive technique, the time required to reach the target test condition after refueling is reduced by 4.1 min (22 percent) using the 500 KEAS schedule compared to the 450 KEAS profile (no external payload drag in either case). A 3200 lbm (1451 kg) savings in JP7 was also seen. These data, as with all data in the results section, are presented for standard day atmospheric conditions.

The 33,000/28,000 ft (10,058/8534 m) transonic climb-dive technique and the 500 KEAS supersonic climb schedule were thus selected as offering the most fuel savings within the feasible operational limitations of the SR-71 aircraft. Figure 11 shows the resulting combined profile superimposed on the flight envelope and the maneuver sequences flown in the DPS to obtain this profile.

### Thrust Enhancement Benefits

With the climb schedule thus defined, the benefits of the thrust enhancement options were quantified using an example external payload drag profile. The example profile was patterned after the GHRV. The modeled research vehicle was 47.2 ft (14.4 m) long and 17.1 ft (5.2 m) wide. The vehicle had a belly-mounted scramjet engine, one RL-10 liquid hydrogen rocket engine for boost, a cross-sectional area of 25.8 ft<sup>2</sup> (2.4 m<sup>2</sup>), and a total fueled weight of 13,700 lbm (6214 kg). The vehicle was intended to be pylon-mounted on the back of the SR-71 aircraft between the vertical tails.

The maximum allowable weight of the SR-71 aircraft is approximately 140,000 lbm (63,503 kg). The 13,700 lbm (6214 kg) of external payload, 500 lbm (227 kg) (estimated) of pylon structure weight, 2000 lbm (907 kg) of oxidizer support hardware, and 60,000 lbm (27,216 kg) of nominal dry vehicle weight leaves a total weight margin of approximately 64,000 lbm (29,030 kg) available for JP7 and N<sub>2</sub>O. After the external payload is air-launched at the target test condition, approximately 18,000 lbm (8165 kg) of JP7 is required to safely land the aircraft. This value includes reserves if a postlaunch refueling attempt fails. The fuel control adjustments would not be selectable in flight and would provide thrust enhancement during the entire mission. The N<sub>2</sub>O injection initiation would be controlled from the cockpit. Using these constraints, the benefits of using the thrust enhancement options were quantified by means of the DPS.

Figure 12 shows the two primary parameters used for judging mission feasibility: the N<sub>2</sub>O expended, and the JP7 remaining at the target test condition, both as a function of the N<sub>2</sub>O cutoff Mach number. An unlimited N<sub>2</sub>O load capacity within the maximum weight limit of the vehicle is assumed. The in-flight refueling condition of Mach 0.75 at an altitude of 25,000 ft (7620 m) is used as the starting point. The N<sub>2</sub>O injection is initiated at Mach 1. This speed marks the beginning of the sharp drop in transonic excess thrust. Through analysis, it was shown that initiating oxidizer injection sooner in the acceleration offers little benefit in terms of overall fuel and time saved to reach the target test condition for launch.

Figure 12(a) shows that the N<sub>2</sub>O can be injected until approximately Mach 1.23 before the supply is exhausted, assuming the maximum 2700 lbm (1225 kg) load. However, figure 12(b) shows

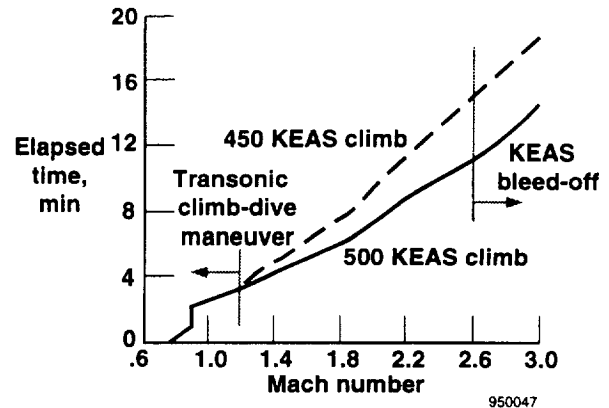

FIGURE 10. ELAPSED TIME TO ACCELERATE TO MACH 3 AND AN ALTITUDE OF 70,000 FT (21,336 M) USING TWO DIFFERENT CLIMB SCHEDULES; NO ENHANCEMENT AND NO PAYLOAD USED.

that the JP7 remaining at the target test condition would be maximized with an N<sub>2</sub>O cutoff Mach number of 1.37. This cutoff Mach number is not achievable; however, there is only a slight penalty when comparing the JP7 remaining using a Mach 1.23 cutoff. Oxidizer injection produces thrust less efficiently than the standard engine, so the fuel-saving benefits of the N<sub>2</sub>O injection reverse once the vehicle pushes through the transonic drag rise and the excess thrust of the J58 engines rapidly increases.

The fuel remaining at the target test condition is approximately 21,400 lbm (9707 kg) using the Mach 1.23 N<sub>2</sub>O cutoff. This cutoff Mach number was found to provide a total possible test time of nearly 4 min before the 18,000 lbm (8165 kg) JP7 return-to-base limit is reached and the payload must be launched so that the SR-71 aircraft can begin its descent. Figure 12(b) also shows that using fuel control enhancements only (no injection—that is, an N<sub>2</sub>O cutoff of Mach 1), the SR-71 aircraft could not achieve the target test condition before reaching its return-to-base fuel value.

Figure 13 shows the time taken to reach the target test condition, after the completion of the in-flight refueling, as a function of the N<sub>2</sub>O cutoff Mach number. Figure 13 shows that much of the time-savings benefit comes early in the acceleration using oxidizer injection. In fact, the most benefit is obtained by expending the N<sub>2</sub>O within the transonic drag rise as opposed to delaying N<sub>2</sub>O delivery until later in the acceleration.

Figure 14 shows comparisons of elapsed time as a function of Mach number for the SR-71 climb with and without the thrust enhancement and payload drag increments. For each case, the vehicle begins the acceleration at the maximum allowable vehicle weight of 140,000 lbm (63,503 kg). Curve 1 shows the baseline characteristics of the clean vehicle with no thrust enhancement. Curve 2 represents the vehicle with the additional payload drag and with both fuel control and oxidizer thrust enhancements active. The N<sub>2</sub>O was initiated at Mach 1 and used until fully expended. Despite the extra propulsive force from thrust enhancement, the vehicle still takes an

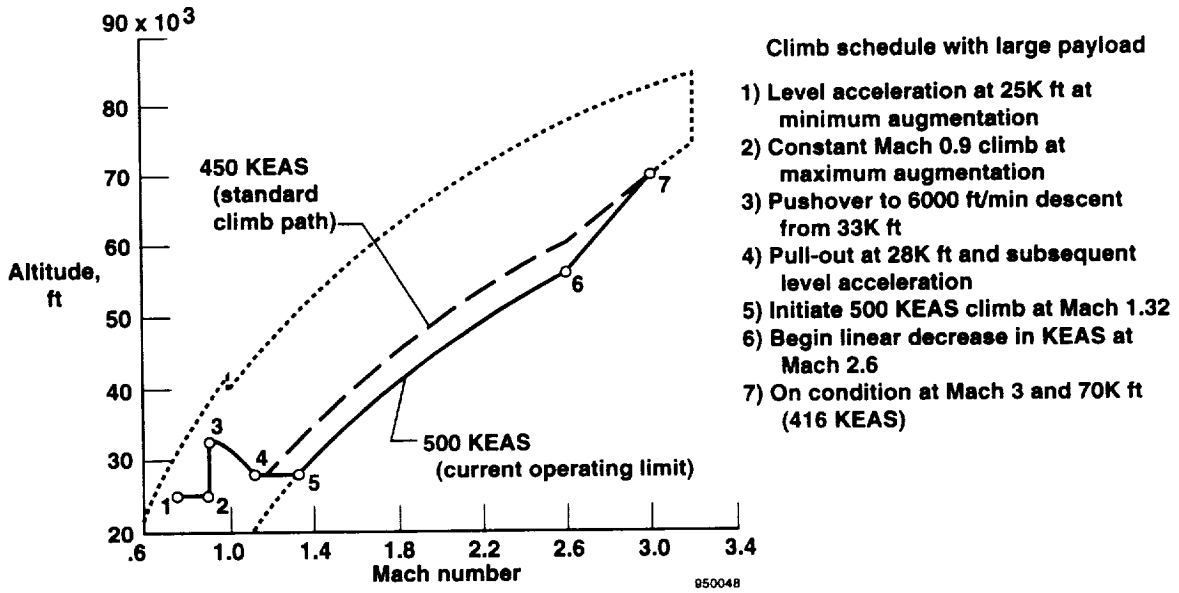
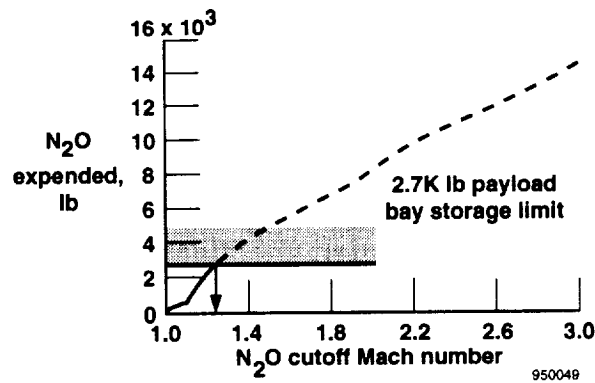
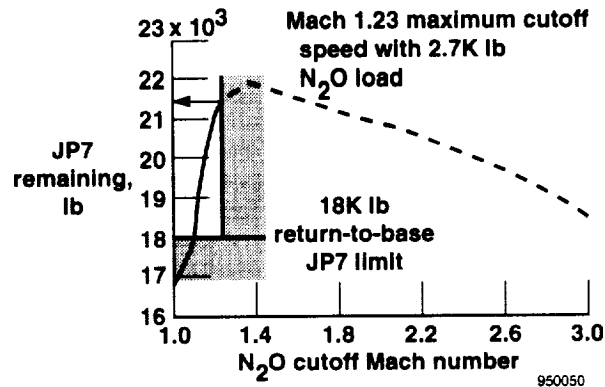

FIGURE 11. THE SR-71 FLIGHT ENVELOPE WITH RECOMMENDED 500 KEAS CLIMB SCHEDULE PROCEDURE.



(A) N<sub>2</sub>O EXPENDED AT MACH 3 AND AN ALTITUDE OF 70,000 FT (21,336 M).



(B) JP7 REMAINING AT MACH 3 AND AN ALTITUDE OF 70,000 FT (21,336 M).

FIGURE 12. N<sub>2</sub>O EXPENDED AND JP7 REMAINING AT MACH 3 AND AN ALTITUDE OF 70,000 FT (21,336 M) AS A FUNCTION OF N<sub>2</sub>O CUTOFF MACH NUMBER; N<sub>2</sub>O INJECTION INITIATED AT MACH 1; 500 KEAS CLIMB SCHEDULE AND PAYLOAD USED.

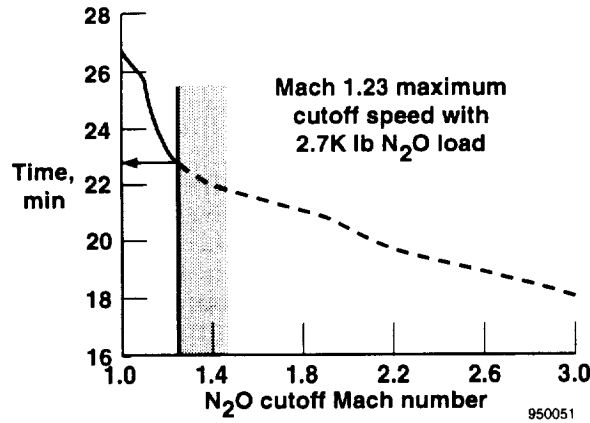

FIGURE 13. TIME TO REACH MACH 3 AND AN ALTITUDE OF 70,000 FT (21,336 M) FROM MACH 0.75 AND AN ALTITUDE OF 25,000 FT (7620 M) AS A FUNCTION OF N<sub>2</sub>O CUTOFF MACH NUMBER; 500 KEAS CLIMB SCHEDULE AND PAYLOAD USED.

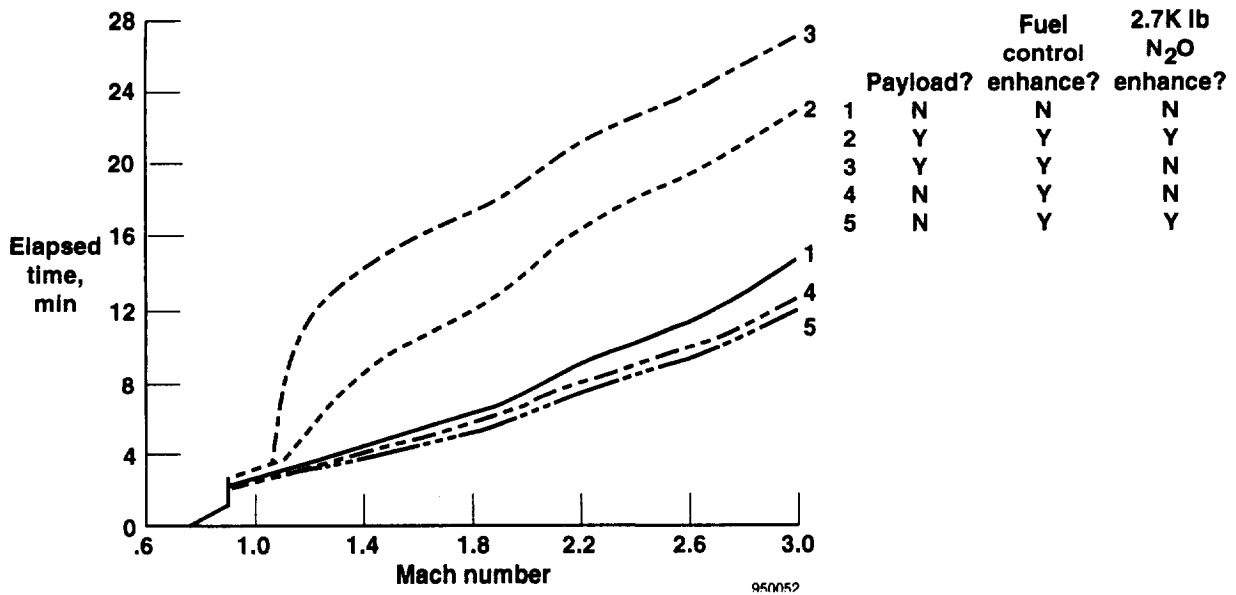

FIGURE 14. ELAPSED TIME TO ACCELERATE TO MACH 3 AND AN ALTITUDE OF 70,000 FT (21,336 M) USING VARIOUS PAYLOAD AND ENHANCEMENT OPTIONS; 500 KEAS CLIMB SCHEDULE USED.

extra 8.2 min (56 percent longer) to reach the target test condition because of the payload. Using fuel control enhancements only, in addition to the payload, the vehicle barely accelerates through the drag rise, taking 84 percent longer (curve 3) than in the baseline case. The SR-71/payload combination could not penetrate the drag rise at all with all thrust enhancements disabled, so the resulting curve is not shown.

Figure 14 also shows the results using thrust enhancement with no extra payload drag. Curve 4 shows that, using fuel control enhancement only, acceleration time is reduced 14 percent, whereas if the N<sub>2</sub>O injection is also used, acceleration time is reduced by

19 percent (curve 5). These last two curves show that for little or no additional payload drag, only small benefit can be gained from the thrust enhancement techniques. However, curves 2 and 3 indicate that for large additional payload drag, thrust enhancement is essential.

**Maximum External Payload Drag Capability**

Figure 15 shows representative maximum vehicle/payload drag profiles that the SR-71 aircraft can accommodate with and without using thrust enhancement. Using these drag profiles, the vehicle

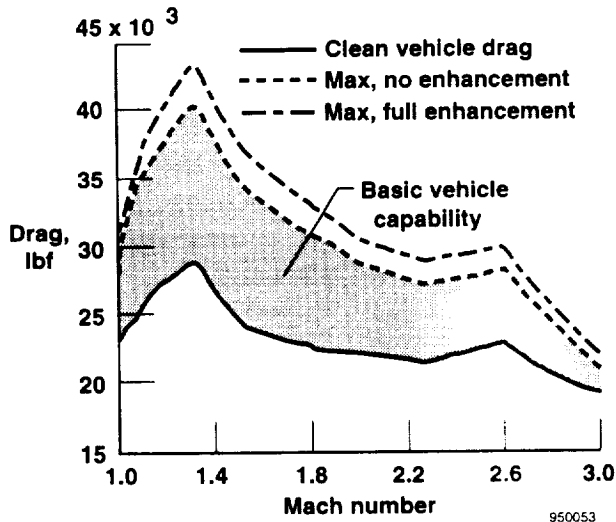

FIGURE 15. MAXIMUM TOLERABLE PAYLOAD DRAG PROFILES, WITH AND WITHOUT THRUST ENHANCEMENT, 4 MIN CRUISE AT MACH 3; 500 KEAS CLIMB SCHEDULE USED.

would have nearly 4 min of fuel remaining at the target test condition of Mach 3 at an altitude of 70,000 ft (21,336 m) before having to initiate a return to base. This time value represents an arbitrary test-point duration.

Figure 15 shows that the maximum tolerable drag profile using thrust enhancement equates to an increase in drag capability of approximately 25 percent over the capability using no enhancement, both relative to the clean SR-71 drag profile (also shown). Once through the transonic drag rise, the absolute drag decreases as the vehicle gains altitude.

It was previously shown that the SR-71 aircraft, using thrust enhancement, would be able to complete the same approximate 4-min mission window with the additional drag from the hypersonic research vehicle.

### Recommendations

If an external payload package idea is carried beyond the design phase and becomes a serious candidate for mounting on the SR-71 aircraft, empirical data on the drag characteristics of the SR-71/payload combination should be obtained before development commences, particularly if the payload is large or is a high-drag design. The empirical data would most likely be obtained in wind-tunnel testing because a large subscale test model of the SR-71 aircraft is available. The transonic drag rise traits would be of particular interest in such an analysis.

The empirical drag data would then be implemented in the high-fidelity SR-71 piloted simulator at NASA Dryden to verify that the vehicle could accommodate the payload on the desired mission from a performance standpoint. Other payload effects, particularly stability and control characteristics, would need to be

evaluated simultaneously. If the vehicle could not adequately complete the desired mission, it would then be necessary to implement the thrust enhancement techniques.

These techniques also would have to be evaluated empirically. A probable scenario is that one J58 engine would be modified and evaluated in ground testing to verify predicted performance increases. Then the modifications would be evaluated in flight, using a short-duration  $N_2O$  injection sequence. The actual engine performance data would then be included in the piloted simulation and the mission reevaluated for feasibility. If engine operability and performance are as predicted and aircraft performance is acceptable, the second engine would be modified and the full set of  $N_2O$  hardware installed.

### CONCLUDING REMARKS

The NASA Dryden Flight Research Center evaluated SR-71 performance for the ability to accommodate large external payload drag profiles with and without the use of engine thrust-enhancement techniques. The evaluation was performed using a simplified aircraft performance simulation.

A previous study concluded that fuel control modifications and nitrous oxide injection into the augmentor can feasibly increase the net thrust of the J58 turbojet engine by an average of 10 percent throughout the transonic and supersonic Mach range. The most cost-effective oxidizer storage scenario would use the nose and chine payload bays of the vehicle for a maximum capacity of 2700 lbm (1225 kg) of nitrous oxide stored at 0 °F (255.4 °K). The extra thrust produced by the control modifications and transonic oxidizer injection would allow for an increase in external payload drag capability of approximately 25 percent.

The SR-71 flight profile was evaluated to determine an optimal climb sequence for use with a high-drag payload. Of particular interest was the transonic speed range and associated drag rise. The most feasible profile used a maximum power, Mach 0.9 climb from an altitude of 25,000 ft (7620 m) to an altitude of 33,000 ft (10,058 m); a pushover and subsequent 6000 ft/min (1829 m/min) descent to an altitude of 28,000 ft (8534 m); a level acceleration to 500 KEAS; and then a constant 500 KEAS climb to the high Mach number target test condition of Mach 3 and an altitude of 70,000 ft (21,336 m). This maneuver was found to save nearly 6000 lbm (2721 kg) of jet fuel over the more conservative transonic level acceleration and 450 KEAS climb schedule.

The performance of the SR-71 aircraft was evaluated using a payload drag profile example representative of a large hypersonic research vehicle designed for high-speed air-launch. Without the use of thrust enhancement, the vehicle could not accelerate through the transonic range. Using fuel control modifications only, the vehicle was able to accelerate through the transonic range but was unable to reach the target test condition before reaching the return-to-base jet fuel limit. Using nitrous oxide injection from Mach 1 to Mach 1.23, which fully depleted the 2700 lbm (1225 kg) load, the vehicle was able to reach the target test condition with approximately 4 min of cruise time available before having to return to base.

The results show that the SR-71 aircraft has a large payload drag capability even without the use of thrust enhancement. However,

for voluminous payloads or payloads that approach the 20,000 lbm (9072 kg) external load capacity of the vehicle, it is possible that the payload drag will exceed the performance capability unless the thrust enhancement techniques are used.

## REFERENCES

<sup>1</sup>Hicks, John W., *Flight Testing of Airbreathing Hypersonic Vehicles*, NASA TM-4524, 1993.

<sup>2</sup>United Technologies Pratt & Whitney, Government Engines and Space Propulsion Division, *J58 Thrust Upgrade Study for Hypersonic Air Launch Option Concept*, FR 22741-1, Mar. 1993.

<sup>3</sup>Miller, Jay, *Lockheed SR-71 (A-12/YF-12/D-21)*, Aerofax, Inc., Arlington, Texas, 1985.

<sup>4</sup>Lockheed Advanced Development Company, *Lockheed SR-71 Supersonic/Hypersonic Research Facility: Researcher's Handbook; Volume II: Technical Description*, 1992.

<sup>5</sup>Burcham, Frank W., Jr., Montoya, Earl J., and Lutschg, Phillip J., *Description of YF-12C Airplane, Propulsion System, and Instrumentation for Propulsion Research Flight Tests*, NASA TM-X-3099, 1974.

<sup>6</sup>Hicks, John W., "Development of a Hydrogen External Burning Flight Test Experiment on the NASA Dryden SR-71A Aircraft," SAE-92-0997, Apr. 1992.

<sup>7</sup>Orme, John S., *Digital Performance Simulation Models of the F-15, F-16XL, F-18, F-104, TACT F-111, X-29 and Hypersonic Research Vehicle*, NASA TM-104244, 1992.

<sup>8</sup>Meyer, J.E., McMaster, J.R., and Moody, R.L., *Handling Qualities of the SR-71* (Revised), Lockheed Aircraft Corporation SP-508, Sep. 1978.

<sup>9</sup>Lockheed Aeronautical Systems Company, *SR-71A Flight Manual*, SR-71A-1, Issue E, Change 2, Jul. 1989.

<sup>10</sup>Redin, Paul C., *Optimization of Transonic Acceleration Performance for the YF-12C Airplane Using the Climb-Dive Maneuver*, TM-X-2694, 1973.

# REPORT DOCUMENTATION PAGE

Form Approved  
OMB No. 0704-0188

Public reporting burden for this collection of information is estimated to average 1 hour per response, including the time for reviewing instructions, searching existing data sources, gathering and maintaining the data needed, and completing and reviewing the collection of information. Send comments regarding this burden estimate or any other aspect of this collection of information, including suggestions for reducing this burden, to Washington Headquarters Services, Directorate for Information Operations and Reports, 1215 Jefferson Davis Highway, Suite 1204, Arlington, VA 22202-4302, and to the Office of Management and Budget, Paperwork Reduction Project (0704-0188), Washington, DC 20503.

<b>1. AGENCY USE ONLY (Leave blank)</b>		<b>2. REPORT DATE</b> June 1997	<b>3. REPORT TYPE AND DATES COVERED</b> Technical Memorandum	
<b>4. TITLE AND SUBTITLE</b> Predicted Performance of a Thrust-Enhanced SR-71 Aircraft with an External Payload			<b>5. FUNDING NUMBERS</b>  WU 242 33 02 00 23 00 T15	
<b>6. AUTHOR(S)</b>  Timothy R. Conners				
<b>7. PERFORMING ORGANIZATION NAME(S) AND ADDRESS(ES)</b>  NASA Dryden Flight Research Center P.O. Box 273 Edwards, California 93523-0273			<b>8. PERFORMING ORGANIZATION REPORT NUMBER</b>  H-2179	
<b>9. SPONSORING/MONITORING AGENCY NAME(S) AND ADDRESS(ES)</b>  National Aeronautics and Space Administration Washington, DC 20546-0001			<b>10. SPONSORING/MONITORING AGENCY REPORT NUMBER</b>  NASA TM-104330	
<b>11. SUPPLEMENTARY NOTES</b>  Presented at the International Gas Turbine and Aeroengine Congress and Exposition, Houston, Texas, June 5-8, 1995.				
<b>12a. DISTRIBUTION/AVAILABILITY STATEMENT</b>  Unclassified—Unlimited Subject Category 05			<b>12b. DISTRIBUTION CODE</b>	
<b>13. ABSTRACT (Maximum 200 words)</b>  <p>NASA Dryden Flight Research Center has completed a preliminary performance analysis of the SR-71 aircraft for use as a launch platform for high-speed research vehicles and for carrying captive experimental packages to high altitude and Mach number conditions. Externally mounted research platforms can significantly increase drag, limiting test time and, in extreme cases, prohibiting penetration through the high-drag, transonic flight regime.</p> <p>To provide supplemental SR-71 acceleration, methods have been developed that could increase the thrust of the J58 turbojet engines. These methods include temperature and speed increases and augmentor nitrous oxide injection. The thrust-enhanced engines would allow the SR-71 aircraft to carry higher drag research platforms than it could without enhancement.</p> <p>This paper presents predicted SR-71 performance with and without enhanced engines. A modified climb-dive technique is shown to reduce fuel consumption when flying through the transonic flight regime with a large external payload. Estimates are included of the maximum platform drag profiles with which the aircraft could still complete a high-speed research mission. In this case, enhancement was found to increase the SR-71 payload drag capability by 25 percent. The thrust enhancement techniques and performance prediction methodology are described.</p>				
<b>14. SUBJECT TERMS</b>  Aircraft performance, J58 turbojet engine, Optimal flight profile, SR-71 aircraft, Thrust enhancement, Transonic drag rise			<b>15. NUMBER OF PAGES</b> 17	
			<b>16. PRICE CODE</b> AO3	
<b>17. SECURITY CLASSIFICATION OF REPORT</b> Unclassified	<b>18. SECURITY CLASSIFICATION OF THIS PAGE</b> Unclassified	<b>19. SECURITY CLASSIFICATION OF ABSTRACT</b> Unclassified	<b>20. LIMITATION OF ABSTRACT</b> Unlimited	