



Minority University-SPace Interdisciplinary Network

Conference Proceedings

of the

Seventh Annual Users' Conference

on

October 8-10, 1997

held at

**City College of New York
New York, NY**

*"Increased Relevance and the
150th Celebration of City College of New York"*



Sponsored by the National Science Foundation and the National Aeronautics and Space Administration



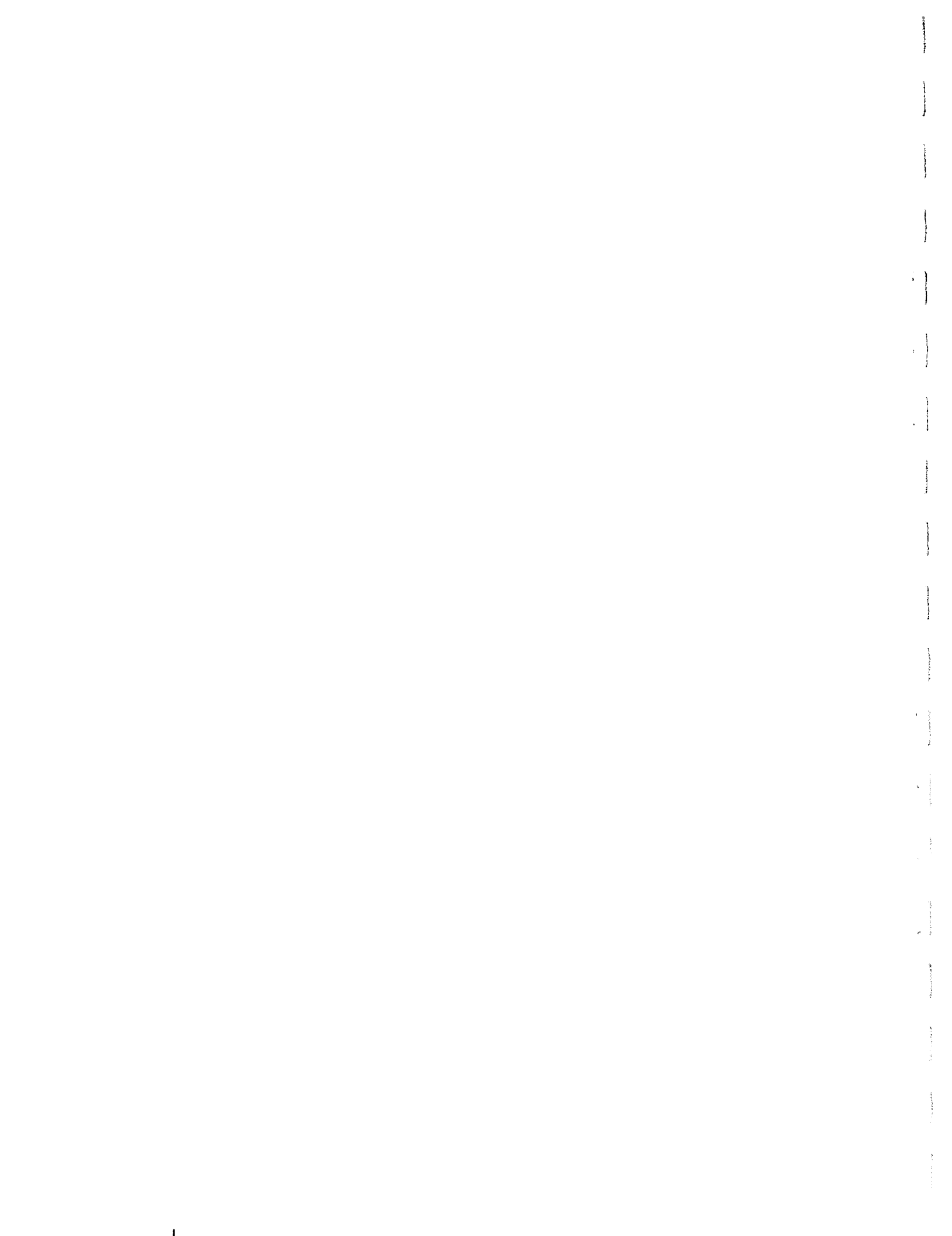



**Materials Presented at the MU-SPIN Seventh
Annual Users' Conference**

Held at

City College of New York & Fort Lee Hilton

on

October 8-10, 1997

Prepared by:

Mr. James L. Harrington, Jr. NASA/GSFC

Ms. Robin L. Brown, MU-SPIN/ADNET

Ms. Pooja Shukla, MU-SPIN/ADNET

This material is based upon activities partially supported by the National Science Foundation Agreement No. CDA-9726118

Any opinion, findings and conclusions or recommendations expressed in this publication are those of the author(s) and do not necessarily reflect the view of the National Science Foundation

Available from:

NASA Center for AeroSpace Information
7121 Standard Drive
Hanover, MD 21076-1320
Price Code: A17

National Technical Information Service
5285 Port Royal Road
Springfield, VA 22161
Price Code: A10



Table Of Contents

Conference Summary.....	1
Agenda.....	3
List of Attendees.....	7
Welcome.....	17
Opening Remarks.....	21
MU-SPIN Update.....	35
NRTS Presentations.....	71
NASA Mission to Planet Earth (MTPE).....	143
NASA Office of Space Science (OSS).....	163
National Science Foundation.....	195
Minority University Research & Education Division (MURED).....	211
Remote Sensing/GIS Break-out Session.....	231
Robotics Break-out Session.....	239
Multimedia Break-out Session (Day 1).....	255
Networking Break-out Session (Day 1).....	285
Pre-College MSET Education Programs Break-out Session (Day 1).....	303
MU-SPIN Consultants.....	331
Call for Participation Presentations.....	369

Advanced Networking & Technology.....	417
Multimedia Break-out Session (Day 2).....	435
Networking Break-out Session (Day 2).....	459
Pre-College MSET Education Programs Break-out Session (Day 2).....	487
Institutional SEM Development & Proposal Writing Break-out Session.....	523
Distance Learning Break-out Session.....	539

Conference Summary

This year's conference was special for two reasons. First, it coincided with the 150th anniversary of the host institution, the City College of New York; and second, it marked the beginning of a transition period for the project towards self-sufficiency through heightened activities and expenditures relevant to mainstream NASA programs and commercialization.

The conference began with a heartfelt, prideful welcome message from Dr. Yolanda Moses, President of City College. That was followed with an encouraging and challenging message from Dr. Milton Halem, City College alumnus and Chief of the Earth and Space Data Computing Division of NASA's Goddard Space Flight Center (GSFC). Dr. Halem showcased the new and exciting horizons that the agency was embarking on and stated that the future couldn't be brighter for minority community participation. I followed with a "MU-SPIN Update".

I began by providing the audience with examples of accomplishments made towards advancing the goals of our "Expert Institute" concepts and with statistics of training and infrastructure impact, while paying special notice to the large part of our community that still is lacking in basic technology infrastructure, and therefore characterized my speech as "A Tale of Two Projects". While we are positioning ourselves to be partners in NASA's New Millennium programs, we cannot forget those of us who continue to struggle to provide the basics that many parts of our society take for granted. I closed by stating that we must push hard to prepare ourselves for showcasing our abilities to compete effectively, while we concurrently uplift those partners who are at the very beginning of understanding how technology fits into educational and institutional goals for science and math.

Day 1 concluded with presentations from the Principal Investigators of the Network Resources and Training Sites (NRTS). These presentations were characterized by accomplishments and impacts of the MU-SPIN program in the minority educational community last year. The presentations were augmented with strong testimonials from faculty, principals, teachers and students of partnering schools.

Day 2 began with presentations from NASA's Mission to Planet Earth Office and the Office of Space Science on how our schools' activities can be more relevant to NASA's missions. Then the rest of day 2 was spent collaborating in special break-out sessions on MU-SPIN activities designed to promote collaboration and science.

The final day hosted our call for participation's which highlighted current NASA relevant science in our institutions and concluded with further break-outs on special MU-SPIN activities.

The attendance this year set an all time record of 191. That will be difficult to match next year when we head to the southwest, however, the quality that has always characterized our annual conference will remain. See you next year!



James L. Harrington Jr.
MU-SPIN Project Manager



MU-SPIN Seventh Annual Users' Conference

City College of New York
and the
Ft. Lee Hilton

October 8-10, 1997

Wednesday, October 8, 1997

- | | |
|--------------------|---|
| 8:30 - 10:00 a.m. | Registration
<i>Ft. Lee Hilton</i> |
| 10:00 - 10:30 a.m. | Welcome
<i>Dr. Yolanda Moses, President of City College</i> |
| 10:30 - 11:00 a.m. | Opening Remarks
<i>Dr. Milton Halem, Chief, Earth and Space Data Computing Division
NASA Goddard Space Flight Center and CCNY Alumnus</i> |
| 11:00 - 11:45 a.m. | MU-SPIN Update
<i>Mr. James Harrington, MU-SPIN Project Manager</i> |
| 12:00 - 12:45 p.m. | Lunch |
| 1:00 - 2:30 p.m. | NRTS Presentations
<i>Dr. Shermane Austin, City College of New York
Dr. Linda Hayden, Elizabeth City State University
Dr. Michael Kolitsky, University of Texas at El Paso
Dr. William Lupton, Morgan State University</i> |
| 2:30 - 2:45 p.m. | Break |
| 2:45 - 3:45 p.m. | NRTS Presentations - continued
<i>Dr. Willard Smith, Tennessee State University
Dr. Donald Walter, South Carolina State University
Dr. John Williams, Prairie View A&M University</i> |
| 3:45 - 4:00 p.m. | Closing Remarks
<i>Mr. James Harrington, MU-SPIN Project Manager</i> |
| 4:00 p.m. | Adjourn |
| 6:00 p.m. | Poster Session/Reception |

Thursday, October 9, 1997

- 7:00 - 8:00 a.m. **Breakfast**
- 8:00 a.m. **Buses Leave for City College**
- 8:30 - 9:15 a.m. **Opening Remarks**
Mr. James Harrington, MU-SPIN Project Manager
- 9:15 - 9:45 a.m. **Mission to Planet Earth (MTPE)**
Mr. James R. Greaves, NASA Goddard Space Flight Center
- 9:45 - 10:15 a.m. **Office of Space Science (OSS)**
Mr. Paul Hunter, NASA Goddard Space Flight Center
- 10:15 - 10:30 a.m. **Break**
- 10:30 - 11:15 a.m. **National Science Foundation**
Dr. David Staudt, National Science Foundation
- 11:15 - 11:45 a.m. **Minority University Research & Education Division**
Ms. Bettie White, NASA Headquarters
- 12:00 - 12:45 p.m. **Lunch/Campus Tour**
- 1:00 - 2:00 p.m. **Remote Sensing/GIS Break-out Session - Steinman Hall - Room T-428**
Dr. Ali Modarres, California State University at Los Angeles
- 1:00 - 3:00 p.m. **Robotics Break-out Session - Steinman Hall - Room T-619**
Dr. Shermane Austin, City College of New York
Dr. Chitta Bural, University of Texas at El Paso
Mr. Robert Cole, Gompers High School
- Multimedia Break-out Session - Steinman Hall - Room T-254**
Dr. Samuel Borenstein, York College
Dr. Bruce Naples, Queensboro Community College
Dr. Donald Walter, South Carolina State University
Dr. George Wolberg, City College of New York
- Networking Break-out Session - Steinman Hall - Room T-312**
Ms. Mona Absalon, Bowie State University
Mr. Darnley Archer, Elizabeth City State University
Mr. Carl Taylor, Prairie View A&M University
- Pre-College MSET Education Programs Break-out Session**
Steinman Hall - Room T-105
Dr. Marino Alvarez, Tennessee State University
Ms. Barbara Helland, Krell Institute
Dr. Beverly Lynds, University Corporation for Atmospheric Research
- 2:00 - 2:15 p.m. **Break**

Thursday, October 9, 1997 - continued

- 3:00 - 4:30 p.m. MU-SPIN Consultants
Dr. Ely Dorsey, Howard University
Mr. Maurice Foxworth and Ms. Cynthia Dinkins, Foxworth & Dinkins
Ms. Valerie Thomas, LaVal Corporation
- 4:30 p.m. Adjourn
- 4:45 p.m. Buses Leave for Ft. Lee Hilton
- 6:00 p.m. Reception
- 7:00 p.m. Awards Dinner

Friday, October 10, 1997

- 7:00 - 8:00 a.m. Breakfast
- 8:00 a.m. Buses Leave for City College
- 8:30 - 8:45 a.m. Opening Remarks
Mr. Reginald Eason, MU-SPIN Deputy Project Manager
- 8:45 - 10:30 a.m. Call for Participation Presentations
Dr. Nizar Al-Holou, University of Detroit Mercy
Dr. S. Raj Chaudhury, Norfolk State University
Mr. Brian Giza, University at Texas at Austin
- 10:30 - 10:45 a.m. Break
- 10:45 - 11:45 a.m. Call for Participation Presentations - continued
Dr. Katherine H. Price, Texas A&M University at Corpus Christi
Dr. Linda Hayden and Mr. Kurt E. Roberson, Elizabeth City State University
- 12:00 - 12:45 p.m. Lunch
- 1:00 - 3:00 p.m. Advanced Networking and Technology
Dr. Tarek Saaddawi, City College of New York
Ms. Bessie Whitaker, NASA Ames Research Center
- Multimedia Break-out Session
Dr. Michael Kolitsky, University of Texas at El Paso
Dr. William Lupton, Morgan State University
Dr. Mou-Liang Kung and Mr. Wallace Hendricks, Norfolk State University
- Networking Break-out Session
Mr. Kurt Roberson, Elizabeth City State University
Dr. Shermane Austin, City College of New York

Friday, October 10, 1997 - continued

- 1:00 - 3:00 p.m. Pre-College MSET Education Programs Break-out Session
Ms. Elaine Lewis, NASA Goddard Space Flight Center
Ms. Carolyn Harris, NASA Goddard Institute of Space Studies
- Institutional SEM Development & Proposal Writing
 Break-out Session
Dr. Mildred Boyd, NASA Goddard Space Flight Center
Dr. Nagi Wakim, Bowie State University
- Distance Learning Break-out Session
Dr. Henry Ingle, University of Texas at El Paso
Dr. John Williams, Prairie View A&M University
- 3:00 p.m. Adjourn
- 3:15 p.m. Buses Leave for Ft. Lee Hilton
- 6:15 p.m. Group Activity
Visiones Jazz Club

MU-SPIN Seventh Annual Users' Conference
City College of New York and the Fort Lee Hilton
October 8-10, 1997

List of Attendees

Mr. Kwajo Abeyie
Stony Brook University
600 North Loop Road
Roth Quad GE Room B04B
Stony Brook, NY 11790
kabeyie@ic.sunysb.edu

Mr. Jimmy Alcorn
Hempstead High School
PO Box 1007
Room 406
Hempstead, TX 77445
409-826-2278
pvamu@hhs.edu

Mr. Richard L. Ashe Jr.
Jet Propulsion Laboratory
Minority Science & Engineering Initiatives
Office
4800 Oak Grove Drive
Mail Stop 72-109
Pasadena, CA 91109
818-354-0122
818-393-4977
richard.l.ashe@jpl.nasa.gov

Ms. Mona Absalon
Bowie State University
Dept. of Computer Science
14000 Jericho Park Drive
Bowie, MD 20715
301-464-6082
301-464-7818
mabsalon@cs.bowiestate.edu

Dr. David S. Alijani
Southern University at New Orleans
Computer Science Dept.
6400 Press Drive
New Orleans, LA 70126
504-284-5423
504-284-5440
dalijani@ix.netcom.com

Mr. Perwaiz Aslam
Claflin College
Computer Center
400 College Avenue
128 JST
Orangeburg, SC 29115
803-535-5250
803-531-2860
paslam@claf1.clafin.edu

Dr. Nabil Adam
Rutgers University
CIMIC
180 University Avenue
Newark, NJ 07102
973-353-5239
973-353-5003
adam@adam.rutgers.edu

Dr. Marino C. Alvarez
Tennessee State University
Teaching & Learning Dept.
John Merritt Blvd.
Box 9561
Nashville, TN 37209
615-963-7328
615-963-7027
malvarez@coe.tnstate.edu

Ms. Danielle Athmore
MAST High School
207-01 116 Avenue Cambria Heights
Cambria Heights, NY 11411
718-978-1837
718-978-2003

Mr. Dennis O. Aguirre
City College of New York
Electrical Engineering Dept.
115 Franklin Avenue
Brooklyn, NY 11205
718-852-4939
aguirre@ees1s0.engr.cuny.cuny.edu

Ms. Carnell Ambrose
MAST High School
207-01 116th Avenue
Cambria Heights, NY 11411
718-978-1831
718-978-2063

Dr. Shermane Austin
City College of New York
Dept. of Computer Science and
Information Systems
138th Street and Convent Avenue
NAC 8/206
New York, NY 10031
212-650-6165
212-650-6093
saustin@cs-mail.engr.cuny.cuny.edu

Dr. Nizar Al-Holou
University of Detroit Mercy
Electrical Engineering Dept.
4001 W. McNichols Road
PO Box 19900
Detroit, MI 48219-0900
313-993-3384
313-993-1187
alholoun@udmercy.edu

Mr. Melvin Anderson
Elizabeth City State University
Math and Computer Science Dept.
1704 Weeksville Road
Campus Box 672
Elizabeth City, NC 27909
919-335-3696
919-335-3790
anderson@umfort.cs.ecsu.edu

Mr. Joseph Austin
Wiley College
Computer Science Dept.
711 Wiley Avenue
Science Bldg.
Marshall, TX 75670
903-927-3246
jaustin@e-tex.com

Mr. Jose Alburquerque
City College of New York
Computer Science Dept.
561 West 143rd Street
Apt. #55
New York, NY 10031
212-926-9480
212-694-1577
csjaa@csfaculty.engr.cuny.cuny.edu

Mr. Darnley Archer
Elizabeth City State University
Math and Computer Science Dept.
1700 Weeksville Road
113B Lester Hall
Elizabeth City, NC 27909
919-335-3696
919-335-3487
darcher@umfort.cs.ecsu.edu

Ms. Alice Baker
South Carolina State University
Center for Network Resources and
Training
300 College Street
Orangeburg, SC 29118
803-536-8797
803-536-8500
alice@eejust.scsu.edu

Ms. Sarah Baker
Jarvis Christian College
Instructional Technology
PO Box 1040
Hawkins, TX 75765
903-769-5814
903-769-5889
jhboo1@juno.com

Dr. Willie Brown
Jackson State University
Computer Science Dept.
1400 J. R. Lynch St.
PO Box 18839
Jackson, MS 39217
601-968-2105
601-968-2478
wbrown@ccaix.jsums.edu

Mr. Malcolm Cannon
MU-SPIN
NASA Goddard Space Flight Center
Code 933
Greenbelt, MD 20771
301-286-0549
301-286-1775
wombat@muspin.gsfc.nasa.gov

Dr. Chitta Baral
University of Texas at El Paso
Computer Science Dept.
500 West University Avenue
El Paso, TX 79968
915-747-6952
915-747-5030
chitta@cs.utep.edu

Ms. Robin Brown
MU-SPIN
NASA Goddard Space Flight Center
Code 933
Greenbelt, MD 20771
301-286-3409
301-286-1775
robin@muspin.gsfc.nasa.gov

Dr. S. Raj Chaudhury
Norfolk State University
B.E.S.T. Lab
Center for Materials Research
2401 Corprew Avenue
Norfolk, VA 23504
757-683-2241
757-683-9054
schaudhury@vger.nsu.edu

Mr. Jerome Bennett
NASA Goddard Space Flight Center
Code 933
Greenbelt, MD 20771
301-286-4655
301-286-1775
bennett@enforcer.gsfc.nasa.gov

Mr. Anthony Budhram
MAST High School
207-01 116 Avenue Cambria Heights
Cambria Heights, NY 11411
718-978-1837
718-978-2063

Mr. Ike Chimezie
City College of New York

Ms. Carol Boquist
NASA Goddard Space Flight Center
Code 933
Greenbelt, MD 20771
301-286-4274
301-286-1634
cboquist@pop900.gsfc.nasa.gov

Ms. Madeline Butler
NASA Goddard Space Flight Center
Code 510.1
Greenbelt, MD 20771
301-286-4806
301-286-1602
madeline.butler@gsfc.nasa.gov

Mr. Robert Cole
Samuel Gompers High School
Electronics/Data Dept.
455 South Blvd.
Bronx, NY 10455
718-665-0950
718-292-3164
bobcole@abest.com

Dr. Samuel Borenstein
York College
Dept. of Natural Sciences
94-20 Guy Brewer Blvd.
Jamaica, NY 11451
718-262-2590
212-678-5552
sborenstein@giss.nasa.gov

Mr. Jose C'de Baca
New Mexico Highlands University
American Indian Science Technology
Education Consortium
213 South Plaza
Las Vegas, NM 87701
505-454-3532
505-454-3011
jcdm@venus.nmhu.edu

Mr. Erik Colon
A. Philip Randolph High School
Science Dept.
132 No. Oxford Walk
Apt #3F
Brooklyn, NY 11205
718-246-7478
c1765@hotmail.com

Dr. Eddie Boyd Jr.
University of Maryland Eastern Shore
School of Business and Technology
Princess Anne, MD 21853
410-543-6430
410-651-7657
eboyd@mcs.umes.umd.edu

Mr. Darren Campbell
MAST High School
207-01 116th Avenue
Cambria Heights, NY 11411
718-978-1837
718-978-2063

Mr. Tolentino M. Correia
City College of New York
Electrical Engineering Dept.
32-37 85th Street
East Elmhurst, NY 11370
718-533-1208
correia@worldnet.att.net

Ms. Genevieve Bremby
Texas Association of Developing Colleges
1140 Empire Central
Suite 550
Dallas, TX 75247
214-630-2511
214-631-2030

Dr. Francine Campone
South Dakota School of Mines and
Technology
Dean of Students
501 East St. Joseph Street
Rapid City, SD 57701
605-394-2416
605-394-2914
fcampone@silver.sdsmt.edu

Mr. Donald Cotten
Queensborough Community College
Physics Dept.
Bayside, NY 11364
718-631-6366
516-628-8707

Mr. Greg Davis
South Dakota School of Mines and
Technology
High Plains Center
501 East St. Joseph Street
Rapid City, SD 57701
605-394-6732
605-394-3374
gdavis@mmailgw.sdsmt.edu

Ms. Libbie Eckroth
North Forest ISD
Technology Dept.
10726 Meas Drive
Houston, TX 77028
713-636-4334
713-636-4377

Mr. Mitchell Fox
The Bronx High School of Science
Physical Science Dept.
75 West 205th Street
Room 229P
Bronx, NY 10468
718-933-2637
718-733-7951
mfox@giss.nasa.gov

Dr. Eugene M. DeLoatch
Morgan State University
School of Engineering
5200 Perring Parkway
Room 118
Baltimore, MD 21251
410-319-3231
410-319-3843
deloatch@eng.morgan.edu

Mr. Hakeem P. Fahm
University of District of Columbia
Computer Center
4200 Connecticut Avenue
MB 4101
Washington, DC 20008
202-274-5986
202-274-6006
fahm@udcvm.udc.edu

Mr. Maurice Foxworth
Foxworth & Dinkins
312 Ninth Street SE
Washington, DC 20003
202-544-7669
202-596-2374
mofox@erols.com

Ms. Cynthia Dinkins
Foxworth & Dinkins
312 Ninth Street SE
Washington, DC 20003
202-546-7669
202-596-2374
cdink@erols.com

Mr. Curtis Felton
Elizabeth City State University
Math and Computer Science Dept.
1704 Weeksville Road
Campus Box 672
Elizabeth City, NC 27909
919-335-3696
919-335-3790
cfelton@umfort.cs.ecsu.edu

Mr. Edward Frasier-Davies
City College of New York
Computer Science Dept.
2101 Tiebout Avenue
Bronx, NY 10457
718-365-0668

Dr. Ely Dorsey
Howard University
School of Business
Dept. of Information Systems & Analysis
2600 Sixth Street NW
Washington, DC 20059
202-806-1603
202-797-6393
edorsey@bschool.howard.edu

Ms. Courtney Fields
Elizabeth City State University
Math and Computer Science Dept.
1704 Weeksville Road
Campus Box 672
Elizabeth City, NC 27909
919-335-3696
919-335-3790
cfields@umfort.cs.ecsu.edu

Mr. James Frost
LaGuardia Community College
Computer Information Systems
31-10 Thomson Ave
L220
Long Island City, NY 11101
212-249-9890
212-678-5552
jfrost@giss.nasa.gov

Mr. Peter Doucette
University of Maine
Spatial Information Engineering & Science
Dept.
Bordman Hall
Orono, ME 04469
207-581-2115
doucette@spatial.maine.edu

Mr. Mario Figueroa
City College of New York
Computer Science Dept.
138th Street & Convent Avenue
Room 7/309
New York, NY 10031
212-650-6155
figueroa@cs-mail.engr.cuny.cuny.edu

Ms. Henrietta Fullard
MAST High School
207-01 116 Avenue Cambria Heights
Cambria Heights, NY 11411
718-978-1837
718-978-2063

Ms. Mgali Dupuy
Louis Brandeis High School
Science Dept.
145 West 84th Street
New York, NY 10024
212-799-0300
mdupuy@juno.com

Mr. Tom Fitzgerald
MU-SPIN
NASA Goddard Space Flight Center
Code 933
Greenbelt, MD 20771
301-286-9514
301-286-1775
fitz@muspin.gsfc.nasa.gov

Ms. Dorothy Funches-Russell
Morgan State University
School of Engineering
5200 Perring Parkway
Room 205
Baltimore, MD 21251
410-319-3231
410-319-3843
russell@eng.morgan.edu

Mr. Reginald Eason
NASA Goddard Space Flight Center
Code 933
Greenbelt, MD 20771
301-286-4633
301-286-1775
reggie@muspin.gsfc.nasa.gov

Mr. Luis Floriano
University of Texas at El Paso
Computer Sciences Dept.
10117 Oko Drive
El Paso, TX 79922
915-859-2965
floriano@cs.utep.edu

Ms. Sangeeta Gad
University of Houston-Downtown
CCRDC
1 Main Street
S-722 (D)
Houston, TX 77002-1001
713-221-8432
713-226-5290
gad@dt.uh.edu

Mr. Charles Gatling
Elizabeth City State University
Math and Computer Science Dept.
1704 Weightsville Road
Campus Box 672
Elizabeth City, NC 27909
919-335-3696
919-335-3790
cgatling@umfort.cs.ecsu.edu

Mr. Ira Gelerater
NYC Department of Education
School Programs K-12
3000 East Tremount Avenue
B301
Bronx, NY 10461
718-828-2334
718-828-2038
igelera@musb.nycenet.edu

Mr. Ronald L. Gews
Brandeis High School
145 West 84th Street
New York, NY 10024
212-799-0300
youthbyte

Mr. Brian Giza
University of Texas at Austin
Texas Regional Collaboratives for
Excellence in Science
Science Education Dept.
SZB 356
Austin, TX 78712
512-471-9279
512-471-9244
bhgiza@tenet.edu

Mr. Christopher Gokey
Bowie State University
Computer Science Dept.
14000 Jericho Park
Bowie, MD 20715
301-464-7166
301-464-7163
cgokey@cs.bowiestate.edu

Mr. Jeffrey Goldberg
Washington Computer Services
155 6th Avenue
New York, NY 10013
212-741-2320
212-206-6759
washcomp@mindspring.com

Ms. Ellen Goldstein
City College of New York
NASA Regional Educator Resource Center
School of Education - Harris 109
Convent Ave. at 138th Street
New York, NY 10031
212-650-6798
212-650-6221
gold3100@con2.com

Mr. James R. Greaves
NASA Goddard Space Flight Center
Mission to Planet Earth
Code 170
Greenbelt, MD 20771
301-286-8691
301-286-1671
jgreaves@pop100.gsfc.nasa.gov

Mr. Robert Green
Bowie State University
3910 Bishopmill Drive
Upper Marlboro, MD 20772
301-574-0018
301-464-7818
rjgrnnyi@aol.com

Ms. Brenda Green

Mr. Vinesh Gupta
South Carolina State University
Center for Network Resources and
Training
300 College Street
Orangeburg, SC 29118
803.533.3965
803.536.8500
gupta@eejust.scsu.edu

Mr. Hal Haicken
George Washington High School
549 Audubon Avenue
New York, NY 10040
212-927-1841
212-923-4974
hsh465@ix.netcom.com

Dr. Milton Halem
NASA Goddard Space Flight Center
Earth and Space Data Computing Division
Code 930
Greenbelt, MD 20771
301-286-8834
301-286-1777
mhalem@pop900.gsfc.nasa.gov

Mr. Aaron Hardesty
University of Texas at El Paso
Computer Science Dept.
8306 Saturn
El Paso, TX 79904
915-751-0014
hardesty@cs.utep.edu

Mr. Dan Harkavy
Louis D. Brandeis High School
Science Dept.
145 West 84th Street
New York, NY 10024
212-799-0300 x438
danh@admin.con2.com

Mr. James Harrington
MU-SPIN
NASA Goddard Space Flight Center
Code 933
Greenbelt, MD 20771
301-286-4063
301-286-1775
james@muspin.gsfc.nasa.gov

Ms. Carolyn Harris
Goddard Institute for Space Studies
Institute on Climate and Planets
2880 Broadway
New York, NY 10027
212-678-5653
212-678-5552
charris@giss.nasa.gov

Mr. Regg Jason Hatcher Jr.
Morgan State University
Electrical Engineering Dept.
Cold Spring Lane and Hillen Road
Calloway Hall 218
Baltimore, MD 21251
410-655-6315
410-319-3963
rhatcher@morgan.edu

Mr. Roger Hathaway
NASA Langley Research Center
Education Dept.
1216 Langley Blvd.
Room 105
Hampton, VA 23681
757-864-4000
757-864-8835
r.a.hathaway@larc.nasa.gov

Dr. Bill Hawkins
Mathematical Association of America
1529 18th Street NW
Washington, DC 20036
202-387-5200
202-265-2384
bhawkins@maa.org

Mr. Warren H. Hawkins Jr.
Wiley College
711 Wiley Avenue
Suite 1020
Marshall, TX 75670
903-927-3237
903-938-8100
whawkins@wiley.edu

Ms. MaryAnn Hawthorne
Samuel Gompers High School
455 Southern Blvd.
Bronx, NY 10455
718-665-0950
718-292-3164

Mr. Wilbert Hope
Medgar Evers College
Physical Sciences & Computer Science
Dept.
1150 Carvill Street
Room C410
Brooklyn, NY 11225
718-270-6448
718-771-0418
wilbert@mec.cuny.edu

Mr. Ashok Jha
ADNET Systems Inc.
11345 Sunset Hills Road
Suite #103
Reston, VA 20190
703-709-7218
703-709-7219
jha@muspin.gsfc.nasa.gov

Dr. Linda Hayden
Elizabeth City State University
Math and Computer Science Dept.
1704 Weeksville Road
Campus Box 672
Elizabeth City, NC 27909
919-335-3645
919-335-3487
lhayden@ga.unc.edu

Mr. Che-Tsao Huang
York College/CUNY
Academic Computing
94-20 Guy Brewer Blvd.
Jamaica, NY 11451
718-262-2750
718-262-2114
huang@ycvax.york.cuny.edu

Mr. Leon P. Johnson
Medgar Evers College
Physical Sciences & Computer Science
1150 Carroll Street
Suite 417
Brooklyn, NY 11225
718-270-6462
212-243-5496
leonj@ocean.scht.mec.cuny.edu

Ms. Barbara Helland
Krell Institute
2401 Chamberlain
Second Floor
Ames, IA 50014
515-292-4103
515-292-3953
helland@krellinst.org

Mr. Tom Hughes
Kentucky State University
Computer Science Dept.
400 East Main
Frankfort, KY 40601
502-227-6385

Mr. Clyde Johnson
Medgar Evers College
Physical Sciences & Computer Science
1150 Carroll Street
C412
Brooklyn, NY 11225
718-270-6473

Mr. Wallace Hendricks
Norfolk State University
Computer Science Dept.
2401 Corprew Avenue
Norfolk, VA 23504
757-683-8650
757-683-9229
w_hendricks@vger.nsu.edu

Mr. Paul Hunter
NASA Goddard Space Flight Center
Office of Space Science Programs
Code 180
Greenbelt, MD 20771
301-286-3994
301-286-0235
paul.hunter@gsfc.nasa.gov

Ms. Joyce Jones
Texas Southern University
College of Education
Education Leadership & Counseling
3100 Cleburne Avenue
Houston, TX 77004
713-313-7437
jkjones@mail.coe.tsu.edu

Ms. Yolanda Hernandez
Aerospace Leadership Institute - JHS 99
410 East 100th Street
New York, NY 10029
212-860-6025
hern2900@mail.csd4.k12.ny.us

Dr. Henry Ingle
University of Texas at El Paso
Technology Planning & Distance Learning
Wiggins Road and University
Undergraduate Learning Center #316
El Paso, TX 79968
915-747-8901
915-747-8610
htingle@mail.utep.edu

Mr. Steve Kalin
Bronx High School of Science
Technology Dept.
75 West 205 Street
Bronx, NY 10468
718-817-7711
718-817-7780
kalins@bxscience.edu

Mr. David Hill
Texas College
Information Technology
2404 North Grand Avenue
Room 920
Tyler, TX 75202
903-593-8311
903-593-0588
dhill@texascollege.edu

Mr. Mark Irish
MU-SPIN
NASA Goddard Space Flight Center
Code 933
Greenbelt, MD 20771
301-286-0876
301-286-1775
mark@muspin.gsfc.nasa.gov

Ms. Latika Keegan
NASA Goodard Institute for Space Studies
2880 Broadway
New York, NY 10025
212-678-5520
212-678-5552
lkeegan@giss.nasa.gov

Dr. James Holloway
Tennessee State University
Computer Science Dept.
330 Tenth Avenue North
PO Box 139
Nashville, TN 37203-3401
615-963-7327
615-963-7027
holloway@coe.tnstate.edu

Mr. Sean Jacob
MAST High School
207-01 116 Avenue Cambria Heights
Cambria Heights, NY 11411
718-978-1837
718-978-2063

Mr. Jerome S. Kohn
Queensborough Community College
Administrative Affairs Office
Bayside, NY 11364-1497
718-631-6242
718-279-8295

Dr. Michael Kolitsky
University of Texas at El Paso
Multimedia Teaching and Learning Center
500 West University Avenue
Union West LL Room 14
El Paso, TX 79912
915-747-5058
915-747-5067
mkolitsky@utep.edu

Dr. Mildred Lockhart Boyd
NASA Goddard Space Flight Center
Office of University Programs
Code 160
Greenbelt, MD 20771
301-286-7820
301-286-1610
mboyd@pop100.gsfc.nasa.gov

Mr. Lyle Marecheau
City College of New York

Dr. Mou-Liang Kung
Norfolk State University
Computer Science Dept.
2401 Corprew Avenue
Norfolk, VA 23504
757-683-8650
757-683-9229
m_kung@vger.nsu.edu

Dr. Stephen Lucci
City College of New York
Computer Science Dept.
138th Street & Convent Avenue
New York, NY 10031
212-650-6156
212-650-6184
lucci@cs-mail.engr.cuny.cuny.edu

Ms. Nathalie McFarlane
A. Philip Randolph High School
138th Street & Convent Avenue
New York, NY 10804
212-926-0113
212-281-2726

Mr. Al Kuslikis
Navaho College
Farmington, NM 520-724-6805

Dr. William Lupton
Morgan State University
Dept. of Computer Science
Cold Spring Lane and Hillen Road
Baltimore, MD 21239
410-319-3962
410-319-3963
lupton@jewel.morgan.edu

Mr. Euclid Mejia
George Washington High School
549 Audubon Avenue
New York, NY 10040
212-927-1841
212-923-4974

Ms. Denee Lake
City College of New York
Electrical Engineering Dept.
114-63 226th Street
Cambria Heights, NY 11411
718-527-2883
dnae01@aol.com

Dr. Beverly Lynds
University Corporation for Atmospheric
Research
Unidata
3300 Mitchell Lane
Suite 170
Boulder, CO 80301
303-497-8654
303-497-8668
blynds@unidata.ucar.edu

Mr. Patrick Michaud
Texas A&M University - Corpus Christi
Computing & Mathematical Science
6300 Ocean Drive
CI 323
Corpus Christi, TX 78412
512-994-2751
512-994-2795
pmichaud@tamucc.edu

Ms. Lillybet Ledo
Florida International University
Hemispheric Center for Environmental
Technology
University Park
EAS 2100
Miami, FL 33199
305-348-1406
305-348-1852
lilly@eng.fiu.edu

Mr. Steve Macho
New Mexico Highlands University
Technology Education/HISTEC
TEC Bldg.
Las Vegas, NM 87701
505-454-3119
505-454-3384
smacho@nmhu.edu

Mr. Patrick Michel
City College of New York
Computer Science Dept.
477 West 140th Street
Apt. #21
New York, NY 10031
212-281-1564

Mr. David Lerner
Bronx Science High School
Technology Dept.
Bronx, NY 718-817-7700

Mr. John Malone
NASA Headquarters
Minority University Research and
Education Division
300 E Street SW
4Z59
Washington, DC 20546
202-358-0948
202-358-3745
john.malone@hq.nasa.gov

Dr. Ali Modarres
California State University at Los Angeles
Dept. of Geography and Urban Analysis
5151 State University Drive
Los Angeles, CA 90032
213-343-2223
213-343-6494
amodarr@calstatela.edu

Ms. Elaine Lewis
NASA Goddard Space Flight Center
Office of University Programs
Code 130.3
Greenbelt, MD 20771
301-286-7356
301-286-1655
elewis@pop100.gsfc.nasa.gov

Mr. Samir Maniar
South Carolina State University
Center for Network Resources and
Training
300 College Street NE
Hodge Hall Room 208
Orangeburg, SC 29117
803-533-3965
803-536-8500
smaniar@physics.scsu.edu

Mr. Angel Morales
Gompers High School
Technical Electronics
455 Southern Blvd.
Room 214
Bronx, NY 10473
718-665-0950
angel@ebsys.com

Mr. Marco Morazan
City College of New York
Computer Science Dept.
120 West 44th Street
Apt. #1611
New York, NY 10036
212-869-8604

Ms. Tricia Outar
MAST High School
207-01 116 Avenue Cambria Heights
Cambria Heights, NY 11411
718-978-1837
718-978-2063

Ms. Shauna Roach
City College of New York
Electrical Engineering Dept.
438 Rockaway Parkway
Brooklyn, NY 11212
718-342-0530
shauna@ee-mail.engr.cuny.cuny.edu

Mr. Barre Morris
Paul Quinn College
Academic Computing
3837 Simposon Stuart Road
Dallas, TX 75241
912-451-4554
214-302-3559
bmorris@pqcnrts.pqc.edu

Ms. Stephanie Parello
College of Staten Island
Astrophysical Observatory
Applied Sciences Dept.
2800 Victory Blvd.
Staten Island, NY 10314
718-982-3260

Mr. Kurt E. Roberson
Elizabeth City State University
Math and Computer Science Dept.
1704 Weeksville Road
Room 109
Elizabeth City, NC 27909
919-335-3645
919-335-3650
kurt@umfort.cs.ecsu.edu

Dr. Yolanda Moses
City College of New York
President's Office
138th Street and Convent Avenue
Room 300
New York, NY 10031
212-650-7285
212-650-7680
ytm@crow.admin.cuny.cuny.edu

Ms. Maxime Pinchinat
City College of New York

Mr. Kenneth Romney
MAST High School
207-01 116th Street
Cambria Heights, NY 11411
718-978-1831
718-978-2063

Mr. Felix Njeh
MU-SPIN
NASA Goddard Space Flight Center
Code 933
Greenbelt, MD 20771
301-286-7661
301-286-1775
felix@bedrock.gsfc.nasa.gov

Mr. Gary Pinizzotto
Charles Drew Academy
1910 West Little York
Houston, TX 77007
281-878-0360
gary-pinizzotto@pvamu.edu

Mr. Stephen Rudolph
MAST High School
207-01 116 Avenue Cambria Heights
Cambria Heights, NY 11411
718-978-1837
718-978-2063

Mr. Dmitri Norwood
Alabama A&M University
Academic Computerization-Education &
Information Technology
218 Carver Complex North
PO Box 1267
Normal, AL 35762
205-851-5993
205-851-5957
dnorwood@asnaam.aamu.edu

Dr. Katherine H. Price
Texas A&M University at Corpus Christi
Physical & Life Science Dept.
6300 Ocean Drive
CI-316
Corpus Christi, TX 78412
512-994-5721
512-994-2795
kprice@falcon.tamucc.edu

Ms. Stephanie Rusnak
South Carolina State University
Center for Network Resources and
Training
311 Hodge Hall
Orangeburg, SC 29117
803-533-3965
803-536-8500
rusnak@eejust.scsu.edu

Mr. Chris Ogunade
MAST High School
207-01 116 Avenue Cambria Heights
Cambria Heights, NY 11411
718-978-1837
718-978-2063

Mr. Ishram Ramberran
MAST High School
Math/Science Dept.
207-01 116th Ave
Cambria Heights, NY 11411
718-978-2053
718-978-2063
iramberr@cmhs.k12.ny.us

Ms. Annette Christy Saunders
Bowie State University
Math and Computer Science
14000 Jericho Park Road
Lanham, MD 20706
301-464-6127
301-464-7818
saunders.annette@bowiestate.edu

Mr. Fred Okoh
Morris Brown College
Chemistry Dept.
643 MLK Jr. Dr. N.W.
Atlanta, GA 30035
404-220-0178
404-220-3799
fiok@morrisbrown.edu

Dr. Eduardo Rivera - Porto
Inter American University of Puerto Rico
Division of Science & Technology
Graduate Program of Open Information
Systems
PO Box 191293
San Juan, PR 00919-1293
787-250-1912 x2144
787-250-8732
erporto@inter.edu

Mr. Harry Schulte
University of Texas at El Paso
Multimedia Teaching & Learning Center
500 W. University Ave.
Rm. 310
El Paso, TX 79902
915-747-5058
915-747-5350
hschulte@utep.edu

Ms. Jamilah M. Seifullah
New York City Alliance for Minority
Partnership in Science
Borough of Manhattan Community
College
Math Department
N520
New York, NY 10007
212-346-8530; 1-2-3-5
212-346-8550

Ms. Pooja Shukla
MU-SPIN
NASA Goddard Space Flight Center
Code 933
Greenbelt, MD 20771
301-286-5083
301-286-1775
pooja@muspin.gsfc.nasa.gov

Dr. Willard Smith
Tennessee State University
ISEM-COE
330 Tenth Avenue North
Suite 265
Nashville, TN 37203-3401
615-963-7089
615-963-7027
smith@coe.tnstate.edu

Mr. John Smith
Langston University
UDS Computer Center
PO Box 609
Langston, OK 73050
405-466-3215
405-466-3271
jlsmith@lunet.edu

Ms. Aail Sockabasih
University of Maine
Wakerali Center
5724 Dunn Hall
Orono, ME 04469
207-581-1417
207-581-4760
gails@maine.maine.edu

Ms. Nancy Sprave
MAST High School
105-31 171st Street
Jamaica, NY 11411
718-978-1831
718-978-2063

Mr. Mario St. John
MAST High School
207-01 116 Avenue Cambria Heights
Cambria Heights, NY 11411
718-978-1837
718-978-2068

Dr. David Staudt
National Science Foundation
Division of Networking and
Communications Research & Infrast
4201 Wilson Blvd.
Room 1175
Arlington, VA 22230
703-306-1949
703-306-0621
dstaudt@nsf.gov

Ms. Helen Stillinger
South Carolina State University
Center for Network Resources and
Training
300 College Street
Orangeburg, SC 29118
803-533-3965
803-536-8500
helen@eejust.scsu.edu

Dr. Vojislav Stojkovic
Morgan State University
Computer Science Dept.
Cold Spring Lane and Hillen Road
Calloway Hall 218
Baltimore, MD 21251
410-319-3962
410-319-3963
stojkovi@morgan.edu

Mr. Derrick Sutton
MAST High School
207-01 116 Avenue Cambria Heights
Cambria Heights, NY 11411
718-978-1837
718-978-2063

Mr. Carl Taylor
Prairie View A&M University
1A109A Hobart Taylor Sr. Hall
PO Box 2576
Prairie View, TX 77446
409-857-2595
409-857-4150
carl_taylor@pvamu.edu

Ms. Valerie Thomas
LaVal Corporation
2004 Clearwood Drive
Mitchellville, MD 20721
301-249-0580
301-249-0580
vthomas@erols.com

Mr. Chevell Thomas
LaVal Corporation
2004 Clearwood Drive
Mitchellville, MD 20721
301-249-0580
301-249-0580

Mr. Jamaal Turner
Elizabeth City State University
Math and Computer Science Dept.
1704 Weeksville Road
Campus Box 672
Elizabeth City, NC 27909
919-335-3696
919-335-3790
jturner@umfort.cs.ecsu.edu

Mr. Walter Vasilaky
Long Island University
Computer Science Dept.
1 University Plaza
Brooklyn, NY 11201
718-488-1073
718-780-4115
vasilaky@hornet.liunet.edu

Dr. John Vickers Jr.
Alabama A&M University
Academic Computerization-Education &
Information Technolgy
218 Carver Complex North
P. O. Box 1267
Normal, AL 35762
205-851-5993
205-851-5957
aamjov01@asnaam.aamu.edu

Dr. Nagi Wakim
Bowie State University
Academic Affairs / MIE
14000 Jericho Park Road
Marshall Library Suite 272
Bowie, MD 20715
301-464-7241
301-464-7818
nwakim@bowiestate.edu

Ms. Tracee Walker
Lincoln University
Physics Dept.
PO Box 120 SMR 1067
Lincoln University, PA 19352
610-932-1617
610-932-1054
wal30644@aux.lincoln.edu

Ms. Ardie Walser
City College of New York
Electrical Engineering Dept.
140th Street & Convent Avenue
New York, NY 10031
212-650-6619
212-650-8249
walser@ees1s0.engr.cuny.cuny.edu

Dr. Donald Walter
South Carolina State University
Physical Sciences Dept.
PO Box 7296
Orangeburg, SC 29117
803-533-3773
803-536-8500
dkw@physics.scsu.edu

Mr. Dwayne Walton
MAST High School
207-01 116 Avenue Cambria Heights
Cambria Heights, NY 11411
718-978-1837
718-978-2063

Dr. John Williams
Prairie View A&M University
Dept. of Chemistry
PO Box 2576
Prairie View, TX 77446
409-857-3910
409-857-2095
john_r_williams@pvamu.edu

Mr. Manuel Zevallos
City College of New York
Dept. of Physics and Electrical
Engineering
138th Street & Convent Avenue
New York, NY 10031
212-650-5531
212-650-5530
zeval@ees1s0.engr.cuny.cuny.edu

Dr. Charles Watkins
City Colleg of New York
Engineering Dept.
138th Street & Convent Ave.
New York, NY 10031

Ms. Laverne Williams
Elizabeth City State University
Math and Computer Science Dept.
1704 Weeksville Road
Campus Box 672
Elizabeth City, NC 27909
919-335-3696
919-335-3790
williams@umfort.cs.ecsu.edu

Mr. Joe Watts
New Mexico State University
University of Texas at El Paso - MmTLC
500 W. University Ave.
Rm.304
El Paso, TX 79905
915-747-5058
915-747-5350
joe@nmsu.edu

Mr. Vernon Willie
Dine' College
Dept. of Mathematics & Science
PO Box #580
Shiprock, NM 87420
505-368-3552
505-368-3519
vfwillie@shiprock.ncc.cc.nm.us

Mr. Charel Webb
MAST High School
207-01 116 Avenue Cambria Heights
Cambria Heights, NY 11411
718-978-1837
718-978-2063

Dr. George Wolberg
City College of New York
Dept. of Computer Science
138th Street and Convent Avenue
Room R8/206
New York, NY 10031
212-650-6160
212-650-6184
wolberg@cs-mail.engr.cuny.cuny.edu

Mr. Dennis Weiss
City College of New York
Division of Science
138th Street & Convent Avenue
New York, NY 10031
212-650-6850
212-650-7948
dennis@scisun.sci.cuny.cuny.edu

Mr. Charlie Wrenn
Tennessee State University
Center of Excellence - ISEM
330 Tenth Avenue North
Room 265
Nashville, TN 37203
615-963-7020
615-963-7027
wrenn@coe.tnstate.edu

Ms. Bessie Whitaker
NASA Ames Research Center
NREN
PO Box 9102
Huntsville, AL 35812
205-544-1498
205-544-2554
bwhitaker@mail.arc.nasa.gov

Mr. Eyad Youssef
Norfolk State University
Chemistry/CMR Dept.
2401 Corprew Avenue
117 Woods Science Bldg.
Norfolk, VA 23504
757-683-8730
757-683-9054
eyad@vigran.nsu.edu

Mr. Joshua Wilder
Brooklyn Polytechnic College
NASA/ GISS Institute for Climate and
Planets
2880 Broadway
Suite 344
New York, NY 10025
212-678- 5569
212-678- 5552
jwilder@giss.nasa.gov

Mr. Joseph Zahra
RJT/Samuel Gompers High School
Engineering Dept.
78 New Hyde Park Road
Franklin Square, NY 11010
516-563-8655
516-775-5164

Welcome

*Dr. Yolanda Moses
President, City College of New York*

Welcome

**Dr. Yolanda Moses
President
City College of New York
138th Street and Convent Avenue
New York, NY 10031
212-650-7285
212-650-7680
ytm@crow.admin.ccny.cuny.edu**

I am delighted to welcome you to the Seventh Annual Users' Conference of the Minority University-Space Interdisciplinary Network, also known as MU-SPIN.

City College is proud to be part of this important event, which is co-sponsored by the NASA Goddard Space Flight Center and the National Science Foundation. MU-SPIN is a comprehensive educational initiative for Historically Black Colleges and Universities, and other universities with large minority student enrollments. Its focus is on the transfer of advanced computer networking technologies to these institutions and their use for supporting multi-disciplinary research.

The MU-SPIN program offers many valuable and vitally needed services to the university community. This includes hands-on training for faculty and students in accessing resources over the Internet; hands-on training to technical staff in local area and campus network installation, management and user support; along with technical sessions and technical video lectures on network related issues, to name just a few.

I am happy to report that CCNY has a number of important connections with NASA. Foremost among these is the fact that NASA's Administrator, Mr. Daniel S. Goldin, is one of our most distinguished graduates, an alumnus of City College's Class of 1962.

For over a decade, CCNY has operated a regional NASA Teacher Resource Center, with support from NASA and other sources. The Center supplies New York City teachers with motivational aerospace educational materials and support services. One of its most important functions has been to make them better aware of the many ways that this material can be utilized in the classroom.

The Center has been quite successful in making aerospace education accessible to teachers and to curriculum designers. It also offers in-service instructional programs, including visits to NASA sites, for teacher groups.

We also had a recent aerospace connection with the National Science Foundation, through our Aerospace Science Leadership Institute, funded by the NSF. The Institute offered in-depth training on all aspects of aerospace science for 90 elementary and middle school teachers, preparing them to be "master teachers" of science and peer trainers.

During the past seven years, MU-SPIN has brought together over a thousand professionals, helping them to learn from each other's experiences, to identify new resources, and to find solutions to the issues and problems they face concerning advanced computer networking technologies.

This year's conference will continue to focus on the networking needs of minority schools. It will provide a national forum to showcase successful examples of computer networking, and in using computer technology to enhance faculty and student development in scientific and technical research for education.

City College is proud to be a conference host on the occasion of our 150th Anniversary celebration. The Sesquicentennial year has offered us the opportunity to celebrate the College's remarkable achievements. For example, CCNY ranks 9th nationally in alumni who have gone on to earn doctorates, and is among the top dozen schools in the number of alumni who have become leading executives in American business and industry.

It is especially appropriate for CCNY to take a leading role in MU-SPIN, in view of the fact that we also have one of the nation's largest contingents of minority students working toward Ph.D.'s in the sciences. I am also proud to inform you that CCNY is now the nation's leading source of African-American baccalaureate recipients, apart from the historically Black institutions.

Our Sesquicentennial is more than an opportunity to look back. It also offers us the chance to plan for the future. And our participation and support for conferences such as this one symbolize our commitment to build a college that prepares its students, including large numbers of minority students, to meet the challenges of the 21st Century.

I wish to thank you for attending, and I hope you enjoy your visit to our campus. I am confident that you will be successful in achieving the ambitious goals that have been set for this conference.

Opening Remarks

Dr. Milton Halem
Chief, Earth and Space Data Computing Division
NASA Goddard Space Flight Center and CCNY Alumnus



Goddard Space Flight Center

ESDCD

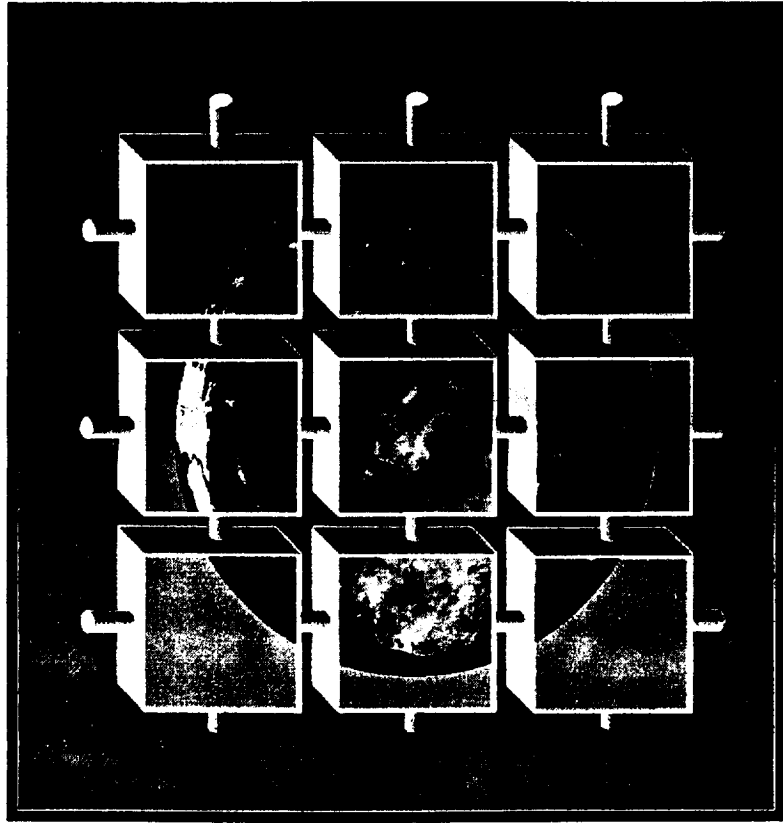

Earth and Space Data Computing Division

milton.halem@gssc.nasa.gov
<http://esdcd.gssc.nasa.gov>

Presentation at MU-SPIN
7th Annual Users Conference
City College of New York
October 8 -10, 1997

Service Area: Pacific Islands Region

- American Samoa - Am. Samoa Com College
- Australia - Radio Australia
- CNMI - (Rota) Northern Marianas Com College
- CNMI - (Saipan) Northern Marianas Com College
- CNMI - (Saipan) Public School System
- Cook Islands - Cook Island Fisheries
- Cook Islands - Ministry of Education
- Fiji - Fisheries Division - MAFF
- Fiji - South Pacific Applied Geoscience Commission
- Fiji - South Pacific Commission
- FSM - Chuuk - Department of Education
- FSM - COM - College of Micronesia FSM
- FSM - Kosrae - Department of Education
- FSM - Pohnpei - Micronesia Maritime
- Guam (2) - University of Guam
- Kiribati - Fisheries Department
- Marshall Islands - College of the Marshall Islands
- Marshall Islands - MI Marine Resources Authority
- Nauru - Fisheries Department
- New Caledonia - South Pacific Commission
- New Zealand - Marine Air Systems
- New Zealand - Wellington Polytechnic
- Niue - Dept. of Agriculture, Forestry and Fisheries
- Palau - Department of Education
- Palau - Fisheries Department
- PNG - Institute of Fisheries & Marine Resources
- PNG - University of Technology (Lae)
- Solomon Islands (2) - Forum Fisheries Agency
- Tokelau (3) Dept. of Telecom & Transportation
- Tonga - Department of Fisheries
- Tonga - Ministry of Education
- Tuvalu - Fisheries Department
- USA (2) - University of Hawaii
- Vanuatu - Fisheries Department
- Western Samoa - Department of Fisheries
- Western Samoa - National University of Samoa
- Western Samoa - University of the South Pacific



F

SELECTED NETWORK RESOURCES AND TRAINING SITES WITH TEAM MEMBERS FOR FY95

- Legend: M.S. - Middle School
- H.S. - High School
- E.S. - Elementary School
- S.D. - School District
- C.C. - Community College
- U. - University
- State of additional satellites
- State Not Effected
- State of NRTS Lead

Underlined institutions are located in neighboring states
 Institutions that are not part of the original team
 Institutions that are part of the lead NRTS region
 Institutions that are part of other NRTS regions

Note: Underlined institutions are located in neighboring states

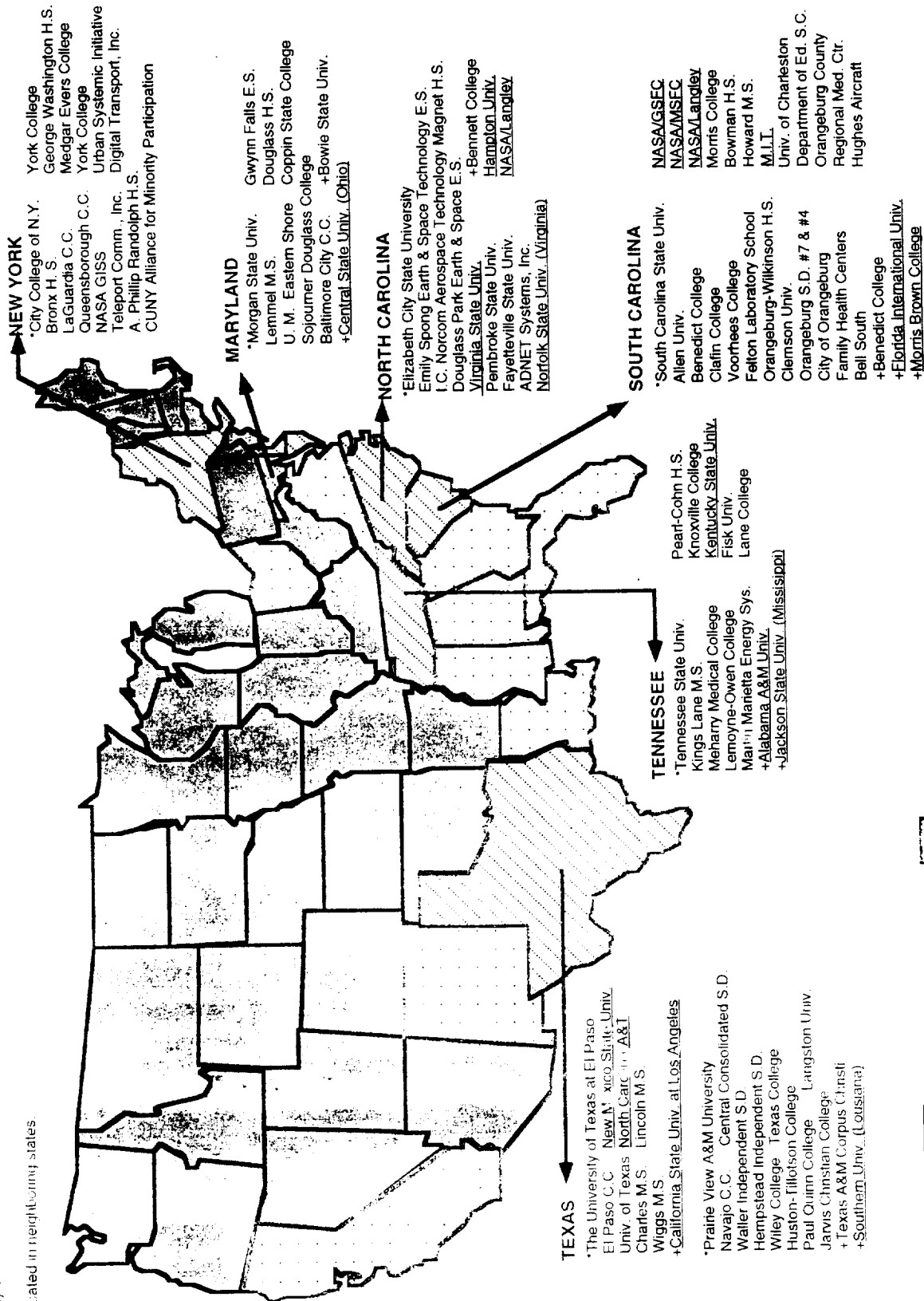

7/26/95
 INTERNET TR...
 179 SCHOOLS IMPROVED
 24 STATES
 State of NRTS Lead
 State Not Effected
 State of additional satellites

Example of USL Operational Concept

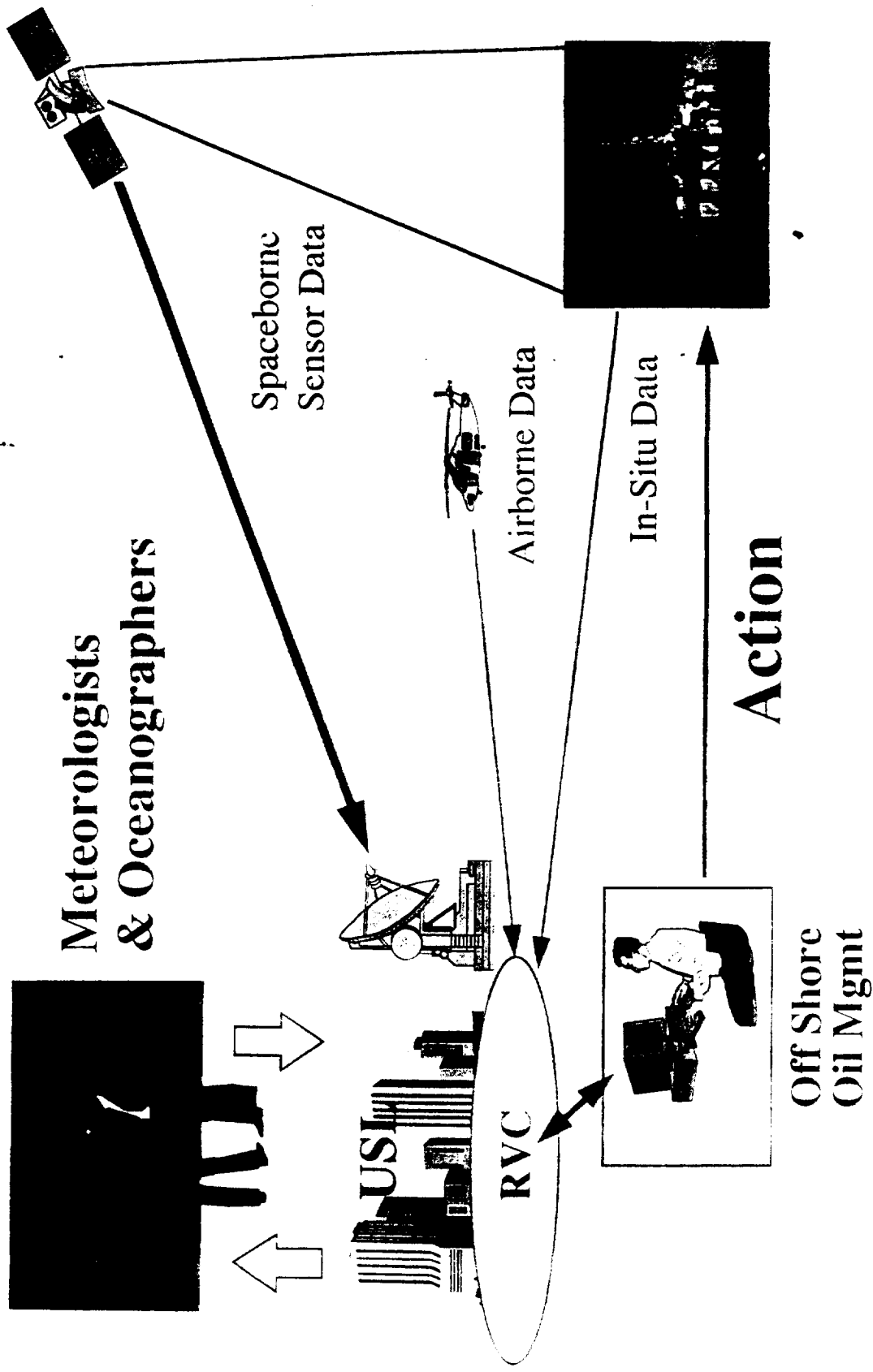

<http://esdcd.gsfc.nasa.gov>

Vegetation Index Image of Chesapeake Bay



Pacific Islands Region

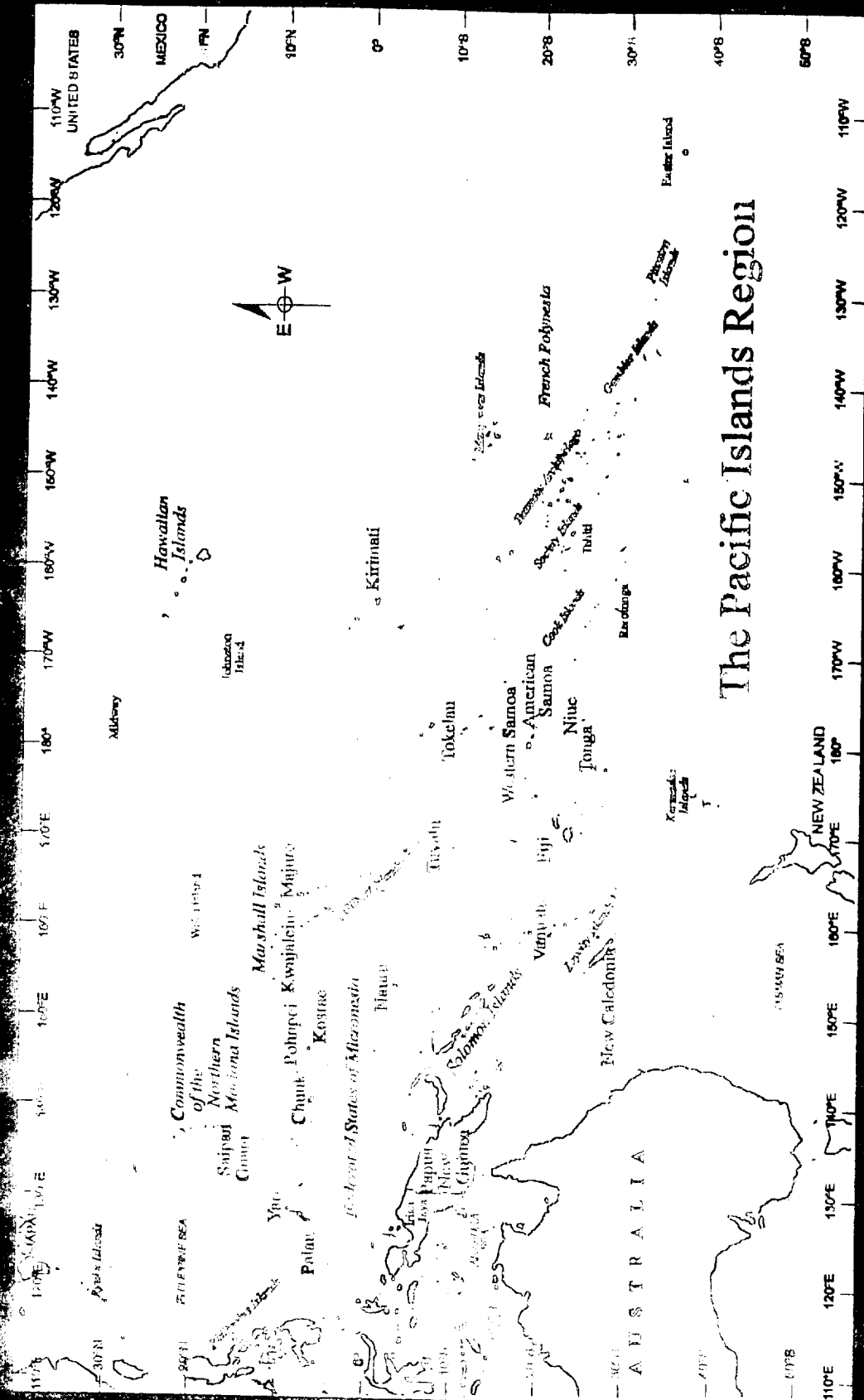

PEACESAT

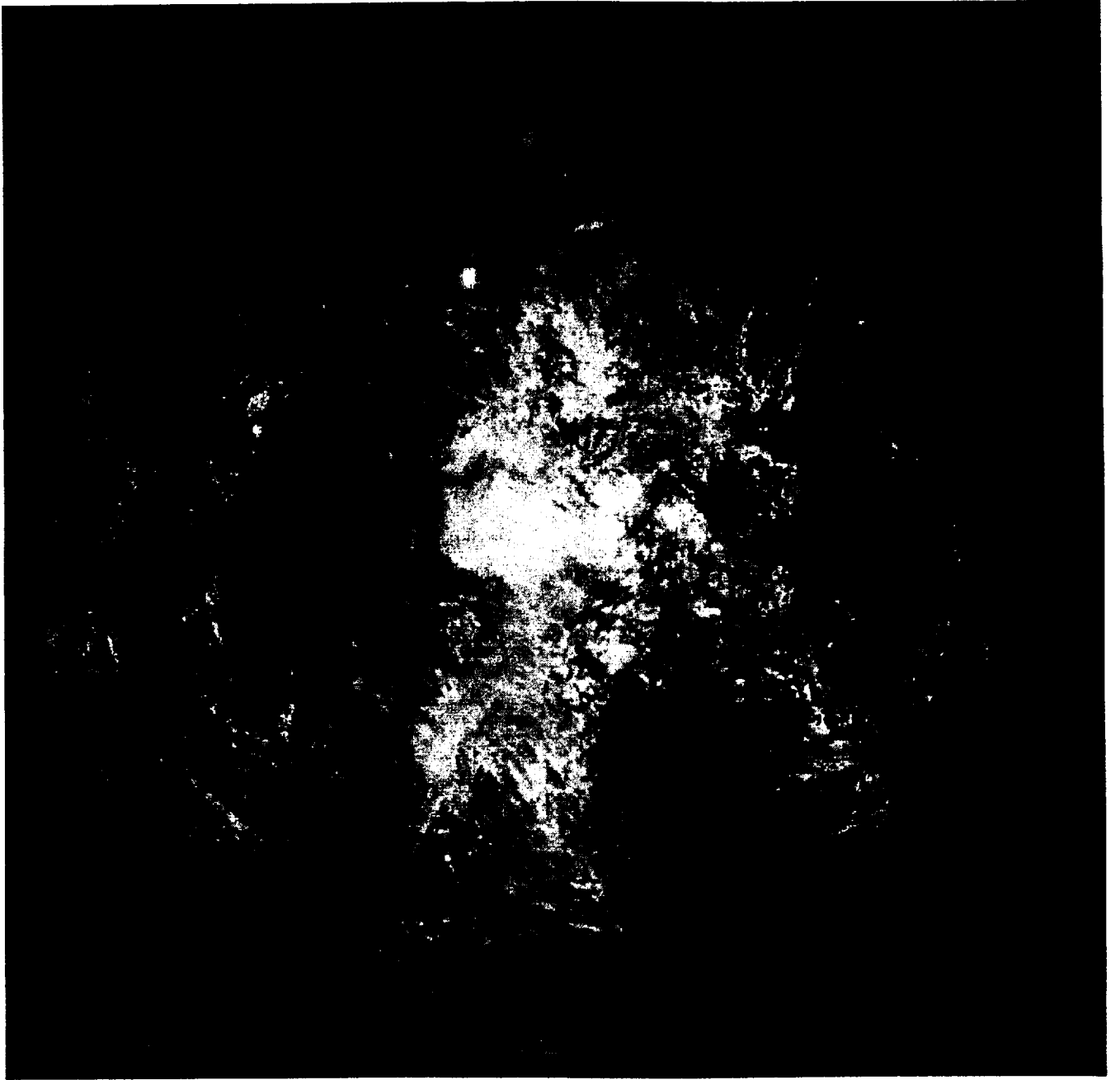

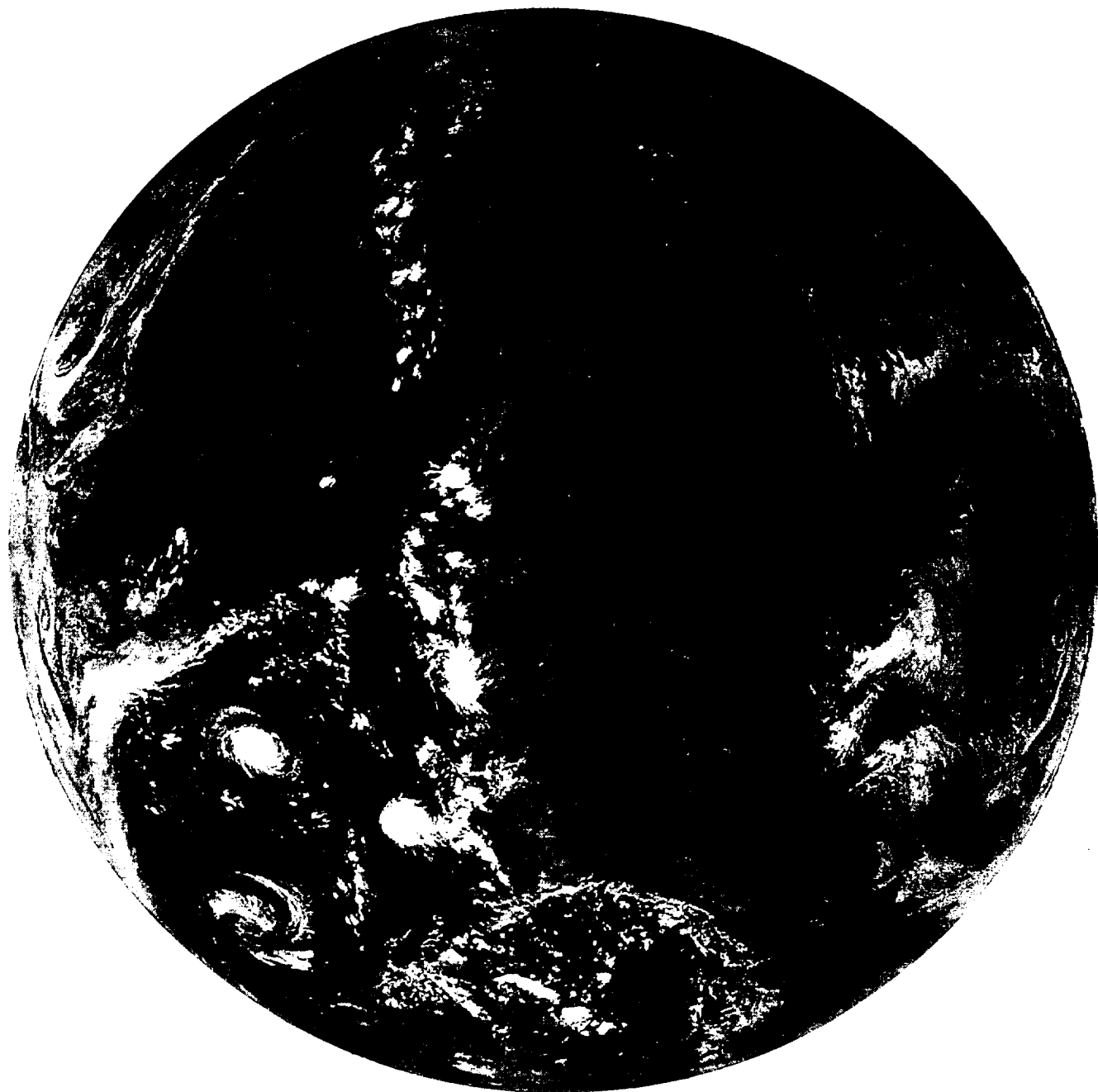





MU-SPIN Update

*Mr. James Harrington
Project Manager*

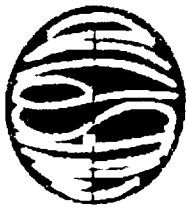

MU-SPIN PROJECT SEVENTH ANNUAL USERS CONFERENCE

Project Manager: James L. Harrington, Jr.

Deputy Project Manager: Reginald Eason

**Goddard Space Flight Center
Science Communications Technology Branch**

OCTOBER 8-10, 1997

<http://muspin.gsfc.nasa.gov>

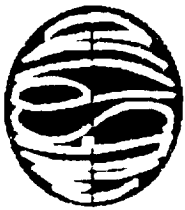

A TALE OF TWO PROJECTS

**A LOOK BACK AT LAST YEAR
LOOKING FORWARD TO NEXT YEAR**

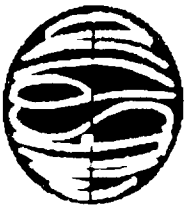

Contents



- **Expectations and Outcomes**
- **Meeting Expectations and Outcomes**
 - **New FY97-99 Strategic Plan**
 - **Current Status on New Initiatives**
 - » **Metrics**
 - » **Expert Institutes**
 - » **Multidisciplinary Workshops/Distance Learning Network**
 - » **Summer Program/Opportunities Outreach**
 - » **Technology Commercialization**
 - » **Change Management**
 - » **Research/Education Outreach**
- **Project Expansion**
 - » **NITI**
 - » **Pacific Islands**
- **Summary**

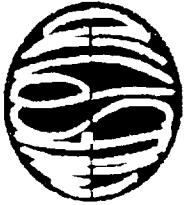

Expectations and Outcomes

- **Create a Strategic Plan**
 - **Responsive to Government Performance and Results Act of 1993 for strategic planning and performance measurement;**
 - **Responsive to the Agency's Strategic Plan, MUREP's Strategic Plan, GSFC's Strategic Plan and the Strategic Management Handbook;**
 - **Responsive to MUREP's outcomes to meet Federal mandates related to HBCUs, Hispanic and Tribal Colleges and Universities;**
 - **Responsive to the needs of the communities.**

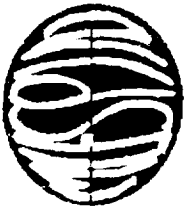

Expectations and Outcomes

- **Government Performance and Results Act of 1993 impact on Strategic Plan**
 - **Contribute to improvement of confidence of the American people in the capability of the Federal Government, by empowering and systemically changing the way our institutions educate and function;**
 - **Initiate project performance reform with strategic planning at the PI level and relevant reporting;**
 - **Improve project effectiveness and accountability by promoting a new focus on results, service quality, and customer satisfaction.**

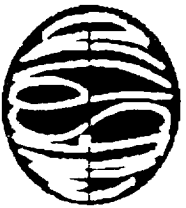

Expectations and Outcomes

- **NASA's Strategic Plans' Impacts on MU-SPIN Plan**
 - **Agency**
 - » **Technology Commercialization is now a mission as important to any in the agency;**
 - **MUREP**
 - » **Increased number of competitive selected and peer review awards;**
 - » **Increased focus on results;**
 - **GSFC**
 - » **To be an enabling entity for scientific research. Look for involvement in University community in Goddard Roles**

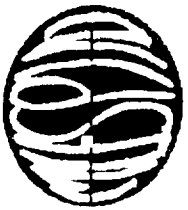

Expectations and Outcomes

- **MUREP Outcomes for MU-SPIN Plan**
 - Number of Institutions with connectivity
 - Number of Faculty and Students Impacted
 - Number of People Trained
 - Number of States Impacted
 - Funds leveraged

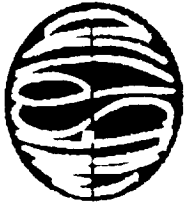

Expectations and Outcomes

- **MU-SPIN Contributions**
 - **MUREP Research Outcomes**
 - » **Number of students receiving degrees in NASA-related discipline areas;**
 - » **Patents applied for or awarded**
 - » **Commercial products developed**
 - **MUREP Education Outcomes**
 - » **Socially and economically disadvantaged, historically underrepresented in NASA-related disciplines;**
 - » **Increased enrollment in college from secondary programs and obtain degrees**

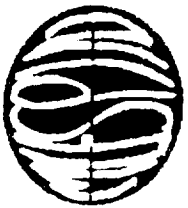

Expectations and Outcomes

- **Respond to Community Demand for Growth**
 - If an NRTS met its request this year from non-participating schools, it would double the size of the number of collaborating schools
 - Community is clamoring to bring more applications and address a wider range of education needs that networking affords but program is severely limited for new expansion of participants

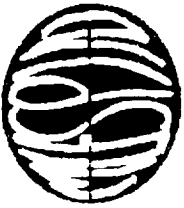

Meeting Expectations and Outcomes

- **Required New Strategic Planning**
 - Reshape MU-SPIN Project Office Organization Structure
 - Budget Enhancement to Support Additional Relevant Expertise
 - Focus NRTS expertise to NASA's crosscutting Enterprise processes
 - Increased focus of NRTS budget towards relevant outcomes
 - Increase the exposure of the project by generating and communicating knowledge

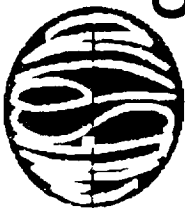

Comprehensive Overview of the NRTS's Responsibilities

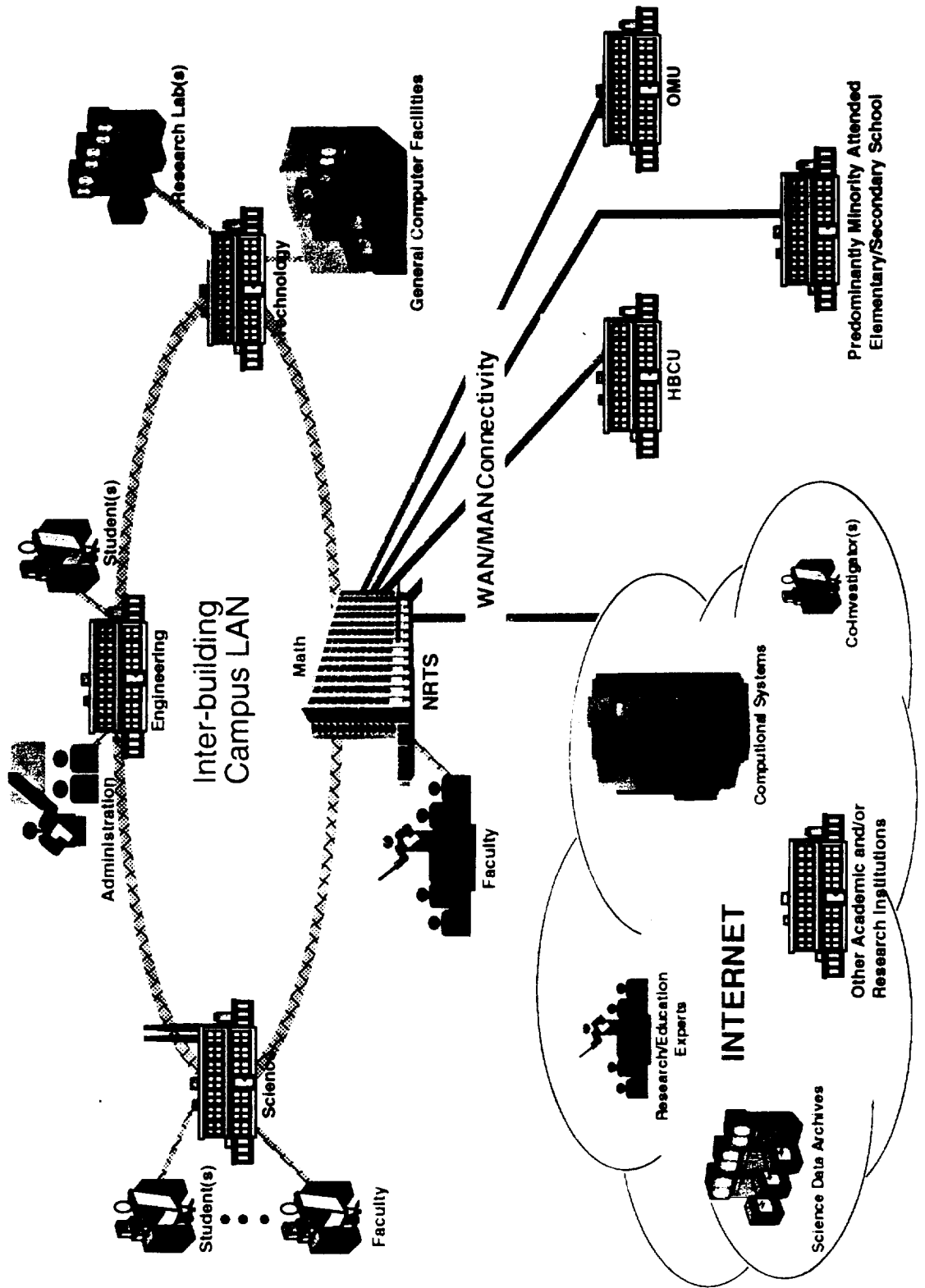



Minority University-Space Interdisciplinary Network

Strategic Plan

FY97-FY99



New Strategies for Relevancy

- **Creation of “Expert Institutes” within our NRTSS, to capitalize on the diverse capabilities that will attract research and funding resources from other entities**
- **Creation of multidisciplinary workshops to promote distance learning for research, education, and technology commercialization that will create new funding opportunities through digital collaboration**
- **Increase collaborations with other NASA Centers demonstrating projects building on expert institutes projects relevant for the enterprise missions**

Perspective

The NRTS/"Expert Institutes" creates immediate identification of research, education, technology transfer and commercialization opportunities which match the expertise of NRTS PIs and their institutions. This concept helps us define roles for our NRTSs so that we all may advance from the reduction in duplication of education activities and workshop materials along with emphasizing the technical competence in which the NRTS is in a position of preeminence. Nurturing this preeminence puts the NRTSs and their collaborating institutions in position to: more effectively use the resources accessible to them; compete more effectively for funding opportunities; and through commercial technology, enhance the economic growth of their communities.

Strategy

MU-SPIN cooperatively with the NRTS PIs will choose a technology or science label for the NRTS which will best represent the capabilities of the NRTS and the institution for achieving the goals of the "Expert Institute" concept.

Goals

- **Create synergism of broad purposes, technology requirements, skills, and facilities by streamlining the training and education production responsibilities of the NRTSs. This will free them from reproducing applications and researching opportunities that other NRTSs could provide, thereby septupling the available resources for the entire MU-SPIN community.**
- **Create a cross collaboration distance learning requirement for upgrading the wide area network bandwidth and procuring distance learning classroom infrastructure and thereby exploiting a federal funding focus of using the NII as a tool for education.**
- **Match "Expert Institute" capabilities to the NASA Enterprises science, education, research, technology transfer and commercialization components wherever possible.**
- **Match "Expert Institute" capabilities with research, education, technology transfer and commercialization efforts of other faculty and students from other institutions.**

Distance Learning Network

Perspective

Historically, the national laboratories and universities have used networking as a means to facilitate the geographical dispersion of collaborative science. Streamlining and consolidation are strategies which will be dependent on high-performance networking. Delegating and leveraging distant expertise eliminates redundancy and reduces costs. The ability to instantly tap resources far away without expensing travel will be key in delivering more benefits for less.

Strategy

The revolutionization of this project will be anchored by a high speed multidisciplinary distance learning network. It will be designed to create and foster a "virtual project" whereby the distance learning network uses the Internet to connect all the NRTSs, their collaborating institutions and the MU-SPIN Project Office with each other and the rest of the country. The distance learning network infrastructure and strategy will leverage Classroom of the Future (COTF) efforts funded by NASA and the Energy Sciences Network (ESnet) concepts funded by the U.S. Department of Energy Office of Energy Research.

Goals

- distance obstacles are.
- Provide a means for participating in attractive MU-SPIN/NRTS activities no matter what the collaborating universities, federal laboratories and industry sites.
 - Provide a means for obtaining multidisciplinary NRTS workshop components from a variety of student registrations and offer curriculum and programs locally. This is critical for universities in rural areas that cater to the local community but are not accredited or do not have qualified staff for certain kinds of education.
 - Exploit the goals of the federal administration's funding of NII applications for education and research, especially those projects which include underrepresented populations in MSET.



MU-SPIN Project Strategic Framework for Relevance & Collaboration FY97-FY99

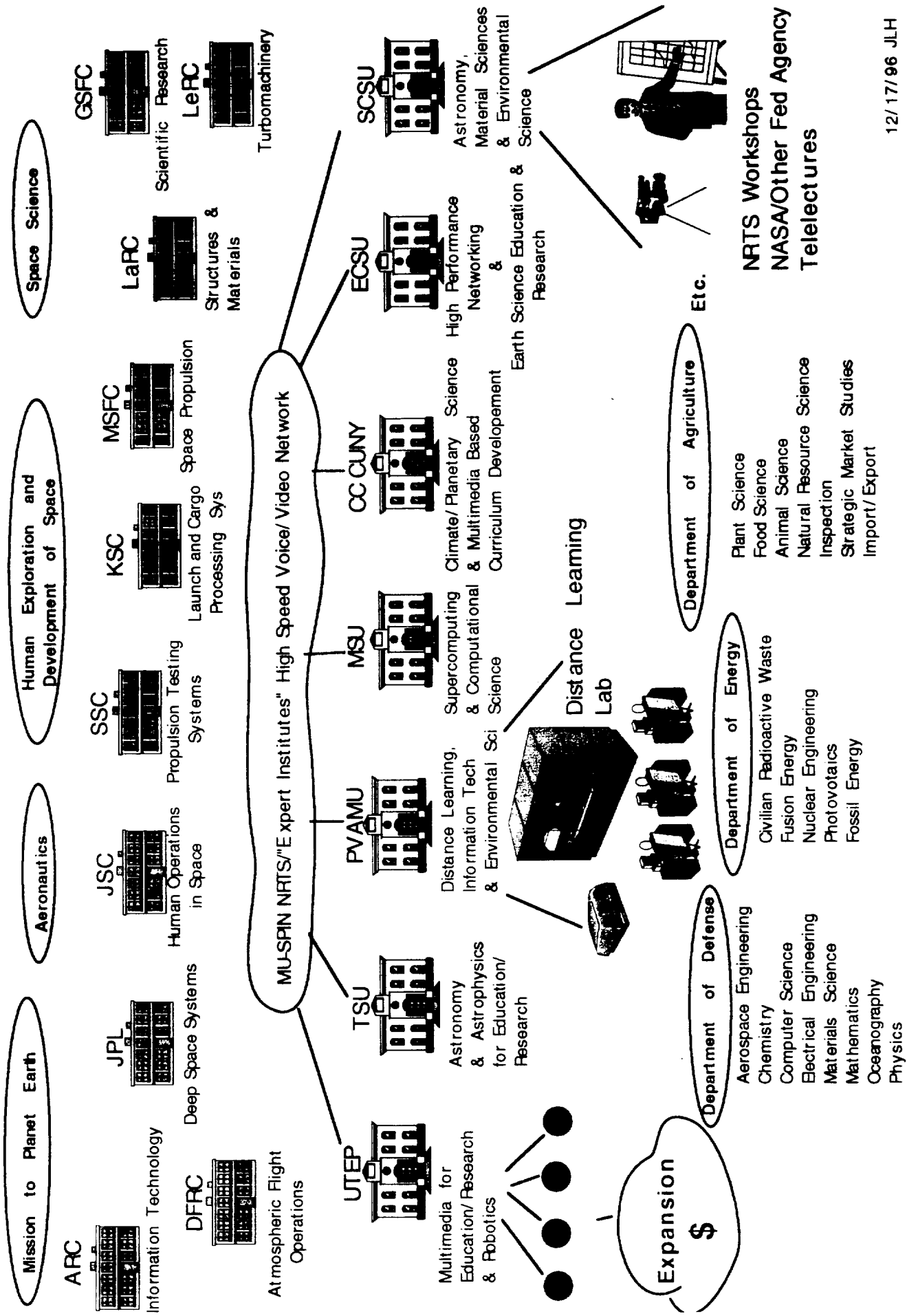

MU-SPIN Project
 Multi-Disciplinary Collaboration Network
 Geographical View Phase 1
 Strategic Framework for Relevancy and Outcomes FY97-FY99

"Expert Institute on Climate/Planetary Science"
 NRTS Spring Workshop
*"Integrating NASA Research into
 Math, Science, and Technology Curriculum"*

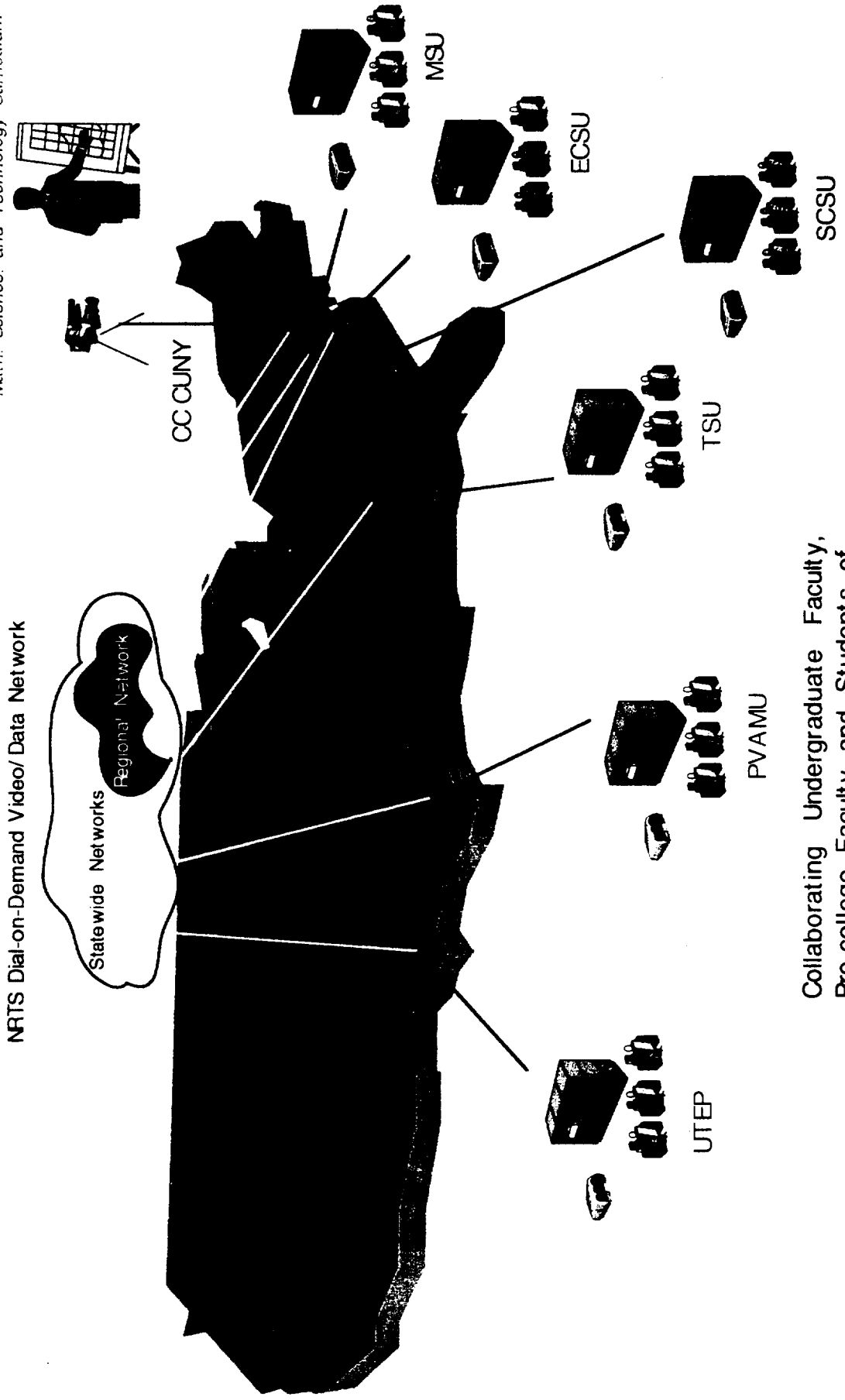

Collaborating Undergraduate Faculty,
 Pre-college Faculty and Students of
 entire NRTS Region

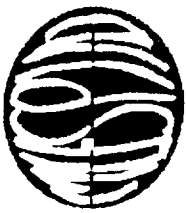

Additional New Strategies

- **Facilitation of NRTS role in participation of NASA Technology Commercialization Program**
- **Research on Change Management Intervention in our institutions which will identify obstacles to obtaining project goals and help us communicate non-traditional metrics of success**
- **Involve NRTSs in opportunities at NASA providing direct interaction with NASA scientists and creating an avenue for tracking student participation and career advancements**

Technology Transfer and Commercialization

Perspective

The national and NASA policy changes elevate the commercial technology mission to a fundamental NASA mission as important as any in the agency. In order to ensure national economic security impacts of NASA programs, NASA will pursue a commercial technology mission concurrent to its aerospace mission. The MU-SPIN technology transfer and commercialization mission will ensure that, where applicable, the program be carried out in a way that proactively involves the private sector from the onset, through a new way of doing business, to ensure that the technology developed will have maximum potential for sustaining itself.

Additionally, the MU-SPIN Project firmly believes that in order for MU-SPIN schools to truly become competitive in the mainstream with non-reliance on shrinking racial or ethnic based funding, technology transfer and commercialization must be viewed as a primary mission for the project, if not, the overall driving force. Transferring technology with commercial potential will drive the 21st Century requirements for education, research, collaboration, and infrastructure.

Strategy

The MU-SPIN Project will lead the community in the following areas:

- Capabilities Inventory - MU-SPIN will inventory and highlight technology capabilities within the MU-SPIN community
- Technology Investment - MU-SPIN will identify opportunities within NASA (10 to 20 percent of NASA's budget will devoted to commercialization) and other agencies for technology transfer and commercialization matches with our community capabilities
- Partnerships - A major new emphasis will be placed on the formation of partnerships between NASA, industry, other government agencies and academia
- Minority, Small and Disadvantaged Business/Equal Opportunity - MU-SPIN will partner with existing businesses in the MU-SPIN communities and will ultimately create new businesses with the technology transfer and commercialization mission

Goals

- Ensure that technology investment is sustained after NASA funding ends
- Increase the institution's capability to perform state-of-the-art research and developement and therefore making it more competitive in the mainstream
- Improve the fiscal requirements of the institution to compete effectively

Change Management

Perspective

With over eighty schools, colleges, and universities at the seven NRTSs, the task of implementing the requisite technology transfer and technology management oversight becomes a matter for effective project management and team cohesiveness. Although we are well intentioned, that is not enough to help our institutions with sociotechnical change. Direct intervention from our end, with the aid of our partners, would help to assist the institutions in supporting change in the affected MSET departments. We should focus on sociotechnical change as a separate component of the Project.

Strategy

Bring on board to the MU-SPIN team, a specialist in Change Management with the appropriate technical background to help us advance as a project office and assist our partners with difficult cultural and process problems.

Goals

- Revolutionize the way the MU-SPIN Project Office functions to more effectively support the growing number of MU-SPIN institutions' needs.
- Assist the NRTS leaderships to more effectively implement the goals of the MU-SPIN Project Office.
- Assist MU-SPIN, NASA, other federal agencies, state government organizations and industry in better understanding the comparison of institutions as Learning Organizations with more accurate comparative metrics.

Summer Student Programs

Perspective

NASA puts a significant emphasis on education. Its vision is simple, support of education shall enhance the Nation's level of scientific literacy and technological competence by sharing the knowledge and inspiration of space research and exploration with the public, educators, and students. NASA uses a profifera of programs to achieve this vision. Many of them are available during the summer when normal school year duties lighten. There were no MU-SPIN NRTS institution students at Goddard in FY96. That will not happen again for a long time.

Strategy

The MU-SPIN Project Office cooperatively with the NRTSs will fund a summer program at GSFC which will guarantee participation from our student bodies in the vast opportunities for hands-on/minds-on learning available here for precollege, undergraduate, and graduate students in MSET. Additionally, the MU-SPIN Project Office will dissect the education plans of all the NASA enterprises and ensure that any student or teacher in our community who has the ambition to attend any of these programs will have significant assistance in applying for participation.

Goals

- Ensure the inclusion of traditionally underrepresented racial or ethnic minorities in MSET in NASA's summer programs
- Inspire career interests and enhance the developement of future scientists and engineers through collaborative research relationships between NASA and MU-SPIN institutions
- Enhance teacher training and education by facilitating access to NASA research and technology activities and scientific results
- Amplify the impact of MU-SPIN partnerships and collaborations with NASA center programs and scientists



Research/Education Outreach

- LaVal Corporation joined Project 6/25/97
 - Assisted by Teacher Intern
- Developed a NRTS/NASA Enterprise Matrix
 - Match Expert Institute research focus with Enterprise/Center Activities
- Nurturing Partnerships
 - UTEP/GSFC Distance Learning
 - MSU/MD Space Grant Consortium EOL & DOE AIS
 - PVAMU/TADC
 - TSU/Nashville Metro Schools
- Developing Metrics for Research & Education Outreach
 - Number of classrooms using Internet
 - Number of Internet related programs impacting project
 - Number of Internet related collaborations, etc.

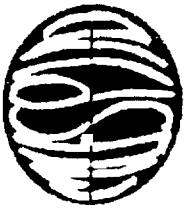

Research/Education Outreach

- **Developing Research/Education Tracking & Alert System**
- **Developing Research/Education Activity Web Pages**
- **Developing Strategic Plan for Summer Research Opps**
- **Nurturing Multi-Disciplinary Workshops for Distance Learning**
 - **Robotics & Multimedia/UTEP**
 - **Astronomy/SCSU & TSU**
 - **Earth Systems Science/ECSU**
 - **Climate & Planets/CCNY**
 - **Supercomputing/MSU**
 - **Information Technology/PVAMU**

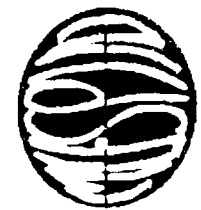

Technology Commercialization

- **Foxworth & Dinkins joined Project 6/25/97**
- **Written White Paper discussing new MU-SPIN strategy for facilitating technology commercialization**
- **Developing Strategic Plan for FY97 Impact**
 - **ECSU Atlas Technology**
 - **CCNY Internet Workshops & Multimedia Curriculum Development**
 - **PVAMU Information Technology**
- **Developed Commercialization Metrics**
 - **Institutions trained**
 - **Mechanisms communicating commercialization**
 - **Institutions with commercialization plans**
 - **Technologies Identified**

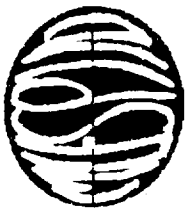

Technology Commercialization

- **Developed Commercialization Metrics con't**
 - **services that have potential commercialization**
 - **public and private sector partnerships**
 - **faculty commercialization activities**



Change Management

- **Focusing on four Consortiums**
 - **TSU, SCSU, CCNY, MSU**
- **Tremendous effort involved due to required high level of human interaction**
 - **Meetings**
 - **Planning**
- **Basic Research**
 - **No Metrics**
 - **Predicted Outcomes**
 - » **Improved team cohesiveness**
 - » **Improved reporting timeliness and content**
 - » **Increased collaboration**
 - » **Ensured goal and milestone achievement**
 - » **Increased participation and satisfaction**



MU-SPIN METRICS

- **Number of States Impacted**
 - Before NRTS - 9
 - Since Inception - 24
- **Number of Schools Impacted**
 - Before NRTS - 29
 - Since Inception - ~179
- **Number of Internet Connections**
 - Before NRTS - ~17
 - Since Inception - ~110
- **Number of Faculty, Student & Staff Trained**
 - Before NRTS - ~700
 - Since Inception - ~13,000 (4,000 Year 1/9,000 Year2)

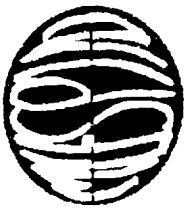

MU-SPIN METRICS, con't

- **Number of New or Enhanced computer Labs**
 - Before NRTS - 0
 - Since Inception- ~500 (200 Year 1/300 Year 2)
- **Funds Leveraged**
 - Before NRTS - 0
 - Since Inception - ~10M
- **Proposals Awarded**
 - UTEP Partnership with Goddard
 - Medgar Evers Partnership with Goddard
 - Voorhees GIS from NASA
 - SCSU HST Access from Space Telescope Science Institute
 - JSU DOD Infrastructure Award
 - TSU Center of Excellence for Astrophysics from NSF

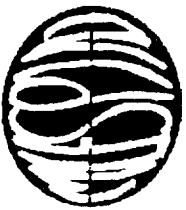

Multidisciplinary Workshops/Distance Learning Network

- **Every NRTS held dual track curriculum workshops this year**
 - **Science, Engineering, Math Curriculum Development**
 - **Internet Technology Infrastructure Development and Training**
- **Completed Basic Distance Learning R&D**
 - **UTEP Spring 96 Workshop to 2 High Schools**
 - **PVAMU has connected 6 HBCUs to TX Vidnet**
 - **MU-SPIN has produced Technology Proposal for Nationwide Network**
 - **Foxworth and Dinkins has made contacts with Interagency group and commercial vendors about collaboration**



A LOOK INTO THIS YEAR

- » **Strengthen the Multidisciplinary Workshops to promote New Exciting Opportunities to participate in MTPE, OSS, Aeronautics activities**
- » **Strengthen the Technology Infrastructure towards strategic relevant goals of NASA and collaborating MU-SPIN partners NOAA, Commerce, NIST, DOE, etc.**
- » **Strengthen the representation of classrooms using Technology and Science related curriculum i.e. SkyMath, EOL, Weather Satellites, AIS, Globe, etc.**
- » **Increase exposure of technical expertise of community and respond to competitive announcements of opportunity for collaborative research teams.**

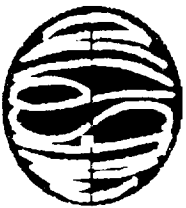

FUTURE INITIATIVES

- **Partnership with GSFC Laboratory for Terrestrial Physics to due Education and Outreach for a Mission to Mercury**
 - **Five finalist to launch in 2002**
 - **Leverage Nationwide MU-SPIN collaboration**
- **Expansion to Pacific Islands**
 - **Finalizing Proposal**
 - **Visiting Potential Partners**
- **Expanded Roles in NGI**

NRTS Presentations

*Dr. Shermane Austin
City College of New York*

*Dr. Linda Hayden
Elizabeth City State University*

*Dr. Michael Kolitsky
University of Texas at El Paso*

*Dr. William Lupton
Morgan State University*

*Dr. Willard Smith
Tennessee State University*

*Dr. Donald Walter
South Carolina State University*

*Dr. John Williams
Prairie View A&M University*

**THE
CITY COLLEGE**
OF THE CITY UNIVERSITY OF NEW YORK

The objective of the CCNY NRTS is to provide network connectivity for partner colleges and K-12 schools to support and facilitate participation in NASA-related research and/or education programs.

The CCNY NRTS is an outgrowth of the Institute for Climate and Planets sponsored by the Goddard Institute for Space Studies which provides research/ education opportunities in climatology, meteorology and planetary science for CUNY and NYC public school faculty and students. The NRTS functions as a technical wing of the ICP, providing the network infrastructure, Internet access, etc. to enable ICP partner campuses and schools to participate fully in ICP-related program.

As the NRTS has evolved, its role has expanded to provide and support more general MSET network connectivity and application requirements and for activities and programs among the partner schools.

The NRTS co-investigators are:

Prof. Shermane Austin, NRTS PI
Prof. Neville Parker, AMP Project Director
Dr. James Hansen, head, GISS



Regional Partners

CUNY colleges

LaGuardia Community College
Medgar Evers College
Queensborough Community College
York College

NYC High Schools

A. Philip Randolph HS
Louis Brandeis HS
Bronx HS of Science
Samuel Gompers HS
Math, Science and Technology HS
George Washington HS



Workshop Participants

Other Colleges

Baruch College
Borough of Manhattan Community College
Bronx Community College
Hunter College
La Guardia Community College
Lehman College
Medgar Evers College
New York City Technical College
Queens College
Queensborough Community College
York College

High Schools

A. Phillip Randolph High School
Aviation H.S.
Brandeis H.S.
Bronx High School of Science
Chelsea H.S.
Columbus H.S.
DeWitt Clinton H.S.
Evander Childs H.S.
Far Rockaway H.S.
International H.S.
Manhattan Center H.S.
Middle College High School
Park West H.S.
Samuel Gompers H.S.
John Jay H.S.
Kennedy H.S.
MAST H.S.
Jacqueline Kennedy Onassis H.S.
Roosevelt H.S.
Stuyvesant H.S.
Martin Van Buren H.S.
George Washington H.S.

K-8 Schools

IS 145Q
Dist.30
M.S. 143 X.
I.S. 90
IS 180
IS 181
IS 135
IS 189

Programs

CCNY STEM Program
MASTAP Program
Weather Watch Project
Upward Bound/Urban Scholars Program
Consortium for School Development
PRES Program
ICP Program
NASA Teachers Resource Center
CUNY Institute of Transportation
ETTAP
NYC Board of Education Staff Development

Others

Hilt Enterprises
Howard Stein-Hudson Associates, Inc.,
A.I.E. Associates
Doceny International
J & S International Inc.
Spread Information
D.H.A. Consulting
NYC Dept of Transportation
New York City Transit Authority
Butler Computer Services



about the network

College LAN Enhancements

LaGuardia Community College Backbone
 Network delivery platform based on High Performance Ethernet Switching and shared 1

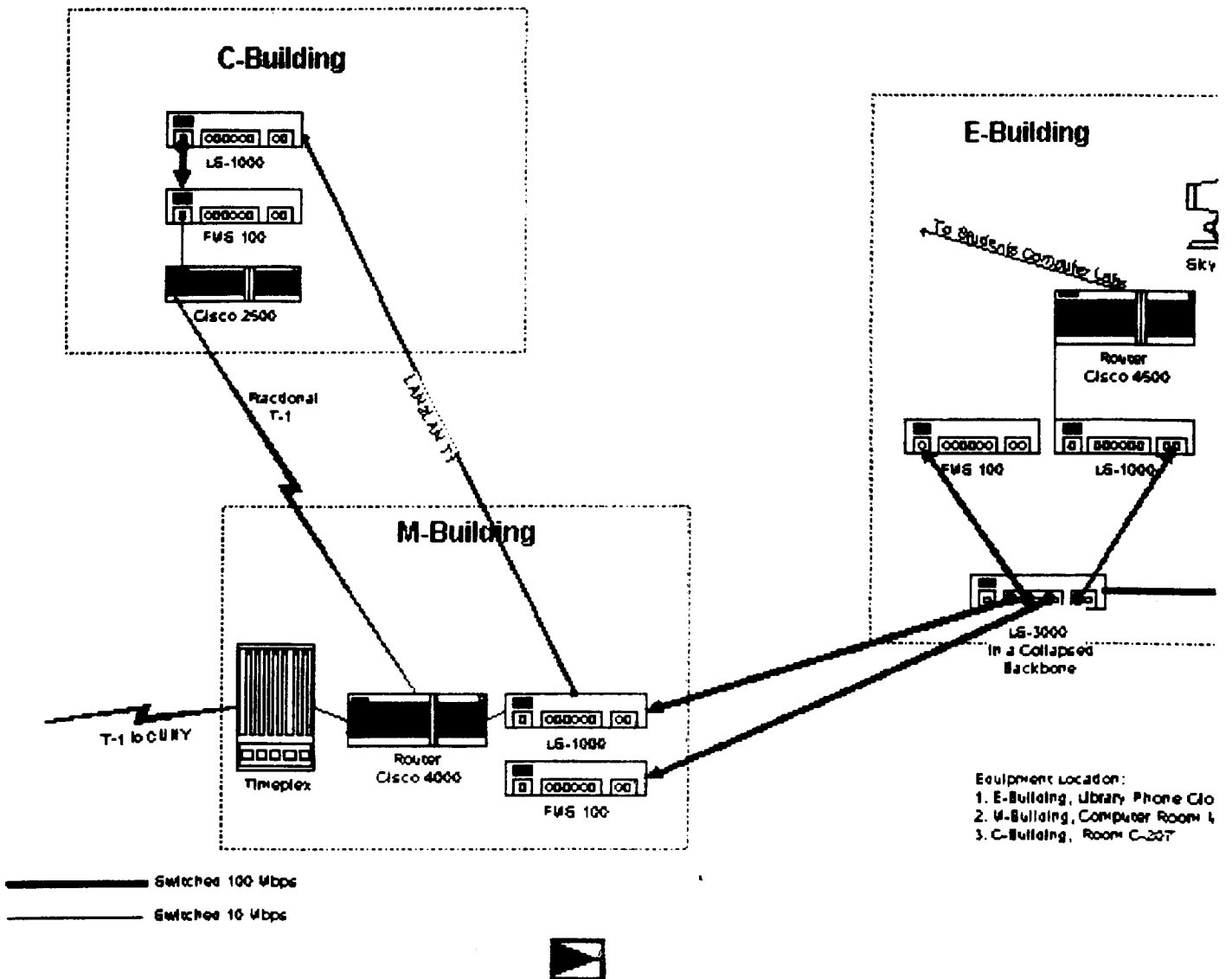



High School LANs

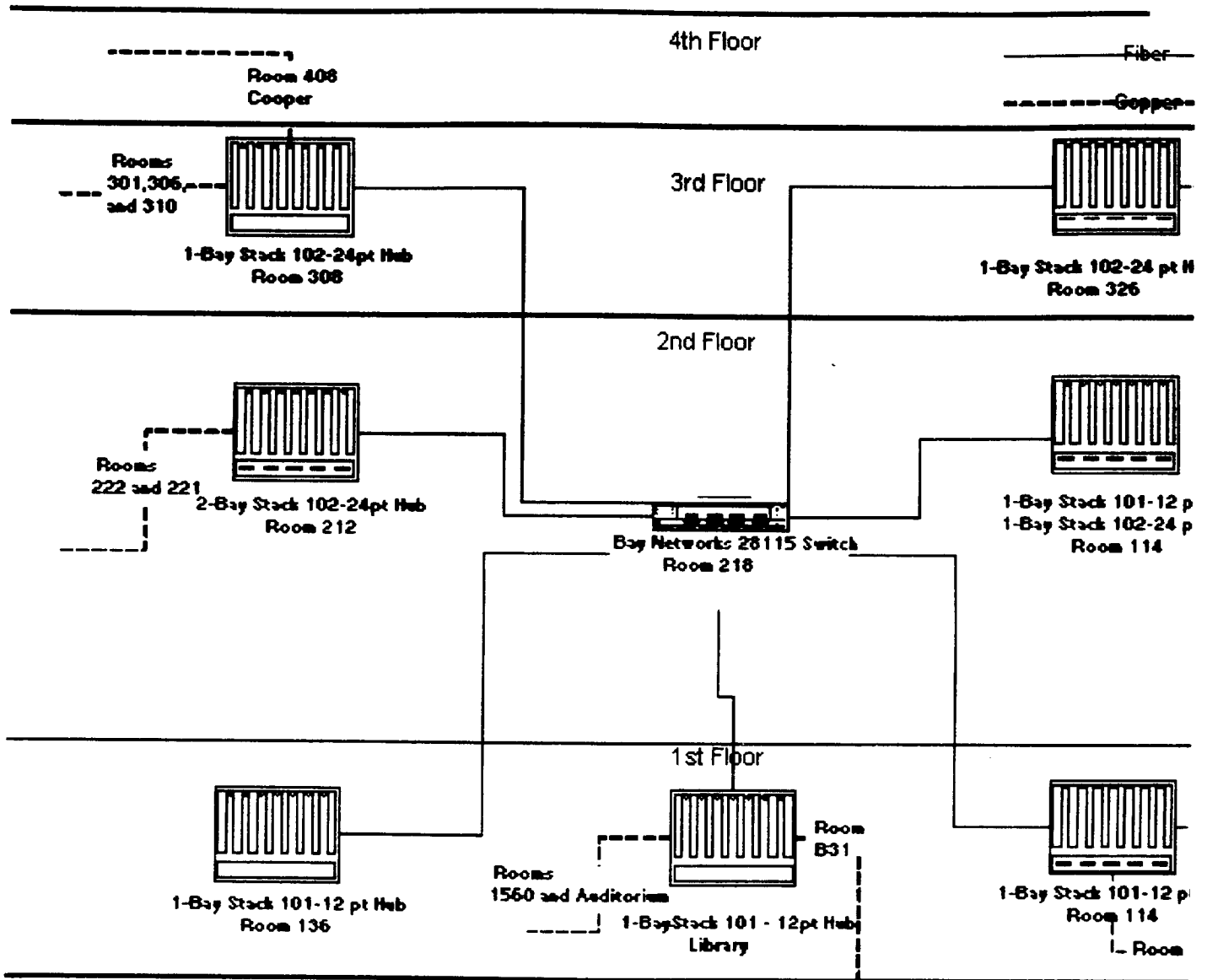

George Washington High School Design



Other Highlights

Net Day 97

NetDay

NetDay RollCall
Help Wire a School
What is NetDay?

Manhattan High School Superintendent's Office



MHS

Manhattan High Schools

Pilot Mouse

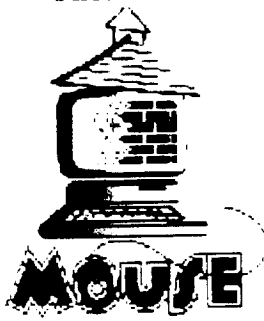

Internet Access via Cable TV

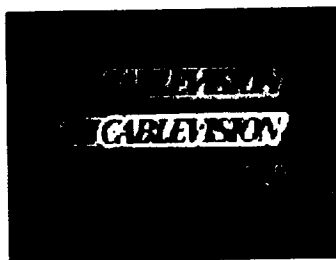

Pilot Project: Bronx H.S. of Science

Dr. Linda Bailey Hayden
Elizabeth City State University
P.O. Box 672
Elizabeth City, NC 27909
919-335-3617
919-335-3487
haydenl@mindspring.com

Introduction

Goals of the Network Resources and Training Site at Elizabeth City State University are to provide training and network connectivity support for HBCU/MI partners and targeted secondary school partners. This NRTS also serves as an expert site in Earth System Science and High Performance Networking.

All NRTS HBCU/MI partners have hosted training and/or received technical assistance site visits from the NRTS staff. In addition, a meeting of all NRTS HBCU/MI partners was conducted on the campus of Norfolk State University in the BEST Lab. Representatives from GSFC and LaRC also attended the partners meeting. Topics of discussion included consortium funding strategies and joint activities. The following are HBCU/MI Partners: Norfolk State University-HBCU, Hampton University-HBCU, Fayetteville State University-HBCU, Virginia State University-HBCU, University of North Carolina at Pembroke-MI, Bennett College-HBCU. The following are highlights of NRTS HBCU/MI collaborations.

1. Norfolk State University and ECSU submitted a proposal to the MTPE Working Prototype Earth System Science Partnership CAN97.
2. University of North Carolina at Pembroke and ECSU NRTS implemented an Eisenhower grant for Purnell Sweet Teacher Technology Training.
3. Fayetteville State University conducted a CU-SeeMe Videoconferencing Workshop during the summer of 1997 Educators 2-week training .
4. All HBCU/MI partners attended a planning meeting at Norfolk State University.
5. Four Hampton University Computer Science graduate students received fellowship money through the NRTS Graduate Success Award.
6. Virginia State University used the portable Macintosh training laboratory and NRTS trainers during its Jan. 1997 faculty workshops.
7. One Bennett College faculty and one administrator attended the 2-week summer training.

Measurable Results: Training Activities

The Network Resources and Training Site at Elizabeth City State University is funded by the Minority University Space Interdisciplinary Network (MUSPIN) Office of Goddard Space Flight Center. A ribbon-cutting ceremony to celebrate the new NRTS facility in Lester Hall was held in conjunction with the first MU-SPIN regional training workshop on November 1, 1995. Since that official opening the NRTS has conducted over 150 training workshops at its site and on the campuses of its HBCU/MI partners and its predominately minority attended secondary school partners. Well over 2000 educators, students and administrators have attended the training. Workshop topics range from Introduction to the World Wide

predominately minority attended secondary school partners. Well over 2000 educators, students and administrators have attended the training. Workshop topics range from Introduction to the World Wide Web to Using the Internet for Research and Advanced Networking Architecture. During the 1996-97 academic year alone, over 80 training workshops were conducted involving over 1400 participants. A portable training lab consisting of 15 Macintosh notebook computers and a caching server enhanced the NRTS ability to train at a variety of off-site locations.

Two major training events took place during the fall and spring semesters (Oct. 31 - Nov. 2, 1996 and April 17-19, 1997). The training events include both a technical track and an educators track. The technical track includes topics relevant to persons charged with setting up computer networks and maintaining them. Topics include LAN/WAN Planning Issues; LAN Software & Management; Perl Programming; and NASA's Atlas Model for Low Cost Connectivity. Training was conducted by NRTS staff and MUSPIN staff members.

An extended training workshop for educators was held during summer 1996. The secondary school summer training was designed to give educators intensive exposure to Internet and connectivity concepts. During the four week program, participants were exposed to many computer platforms including Sun, Silicon Graphics, PCs and Macintosh. Visiting lecturers which added a unique dimension to the program, represented an array of programs which NASA supports. Each visitor presented effective ways to integrate the internet into the curriculum and to bring the technology to secondary school classrooms. Participants learned not only to navigate the Internet but also to join in the effort to design the look and feel of Cyberspace as they aggressively joined their efforts to design Webpages for their schools which documented the individual school's mission, programs, student activities and lots more. A two-week training workshop for 12 educators took place during summer'97 at the NRTS site. A second two-week workshop for high school students was conducted in Portsmouth, VA.

Measurable Results: Network Connectivity

Netday training was hosted by the NRTS for all parent and community volunteers. Training included instructions in terminating cables, punch down boxes, ladder safety and cabling fundamentals. In addition, Netday grants were provided to secondary schools with which they could purchase cable and supplies for their Netday events. Representatives from the Coast Guard Base in Elizabeth City assisted the effort in North Carolina while Senator Charles Robb assisted with the Virginia Netday efforts.

At this time all secondary school partners are at Level 1 (entry level - training only) or Level 2 (training and connectivity). During summer97 we anticipate Douglass Park and Emily Spong Elementary Schools to move to Level 3 the highest level of secondary school participation. Both Emily Spong and Douglass Park were completely networked during NetDay and follow up visits by the NRTS engineers and network manager. At Level 3, the school is a full functioning training site independent of the ECSU-NRTS. At Level 3, the school has a fast & robust Internet connection; fully trained teachers and staff; one or more technology coordinators; projection equipment; and is capable of scheduling and conducting training events for other schools, parents and community members.

NRTS engineers and staff have made numerous visits to North Carolina schools to assist with their connectivity efforts. Presentations were made at a December meeting with the superintendents from all school systems in Roanoke River Valley.

The NRTS also hosted a meeting of RRVC educators and administrators including representatives from Langley Research Center. A concept paper to strengthen the partnership with LaRC, RRVC, Purnell Swett High, Camden County Schools and the NRTS was submitted but was not funded. The Warren County School superintendent has accepted the network infrastructure proposal to Warren County Public Schools and are starting the implementation of the network cabling, hubs, and Atlas Server.

Secondary school partners used their \$45000.00 to enhance connectivity. In addition to the \$45000.00 and NetDay funds, secondary schools were provided funds to cover registration fees for the WHRO -CII Technology conference in Norfolk, Va and the Virginia Society for Technology in Education Conference in Blacksburg, Va.

Measurable Results: Earth System Science and High Performance Networks

Dr. Hayden, NRTS Principal Investigator completed a Faculty ASEE Research Assignment at Langley Research Center which resulted in Memorandum of Agreement #368 and the technology transfer rights to serve a flagship role in bring the ATLAS caching server model to all NRTS. NASA policy elevates the commercial technology mission to a fundamental NASA mission as important as any in the agency. The NRTS at ECSU has committed to the commercialization of ATLAS technology model of connectivity through MOA#368 and NASA-LaRC announcement #97-019 released June 20, 1997. The NRTS at ECSU has partnered with ADNET, MUSPIN and Foxworth and Dinkens Inc. to ensure that the commercialization of ATLAS will be realized. Currently this team is pursuing a joint venture between ECSU-NRTS and URLabs to establish the NRTS as an authorized training site for the URLab ATLAS model caching server.

In addition to technology transfer, the NRTS at ECSU has been tasked with developing two additional areas of expertise which are High Performance Networking and Earth System Science Education. Earth System Science Education programs are administered by an advisory board which includes representatives from MTPE, EPA, The North Carolina Supercomputer Center, Langley Research Center, Goddard Space Flight Center and the ECSU Geology Department. A exciting two-day summer academy in Earth System Science was conducted on June 17-18, 1997 for high school students.

ECSU is currently pursuing partnership in the Distributed Image Spreadsheet Application (DISS) under NASA Research and Education Network project through Ames Research Laboratory. Mr. Jim Harris of Evans-Harris and Associates is assisting with the logistical arrangements while Foxworth and Dinkens, Inc is assisting with the drafting of an MOA between Ames, GSFC, ECSU and the University of Missouri. The goal will be to establish ECSU as a training site for the DISS user group while serving in flagship role to bring the NREN technology to the entire NRTS community.

A NRTS server usage report indicates that February 1997 was the month of highest usage while May'96 was the lowest. School closes during the first week of May and does not reopen for summer school until late May. The 2-3 weeks during May when the school is not in session account for the light usage. Between May'96 and April'97 the server was accessed 7577 times for a variety of purposes.

Measurable Results: STUDENT IMPACT

The NRTS provides \$50,000.00 annually in scholarships to selected ECSU students who major in mathematics, computer science or technology. In addition, the NRTS gives service awards to students who have given dedicated service to the NRTS center. Students who receive the scholarship, work with a faculty mentor in a structured setting to learn the fundamentals of science research. Two teams, The ATM Networking Team and The HTML/JAVA Team have presented their research findings at several regional and national conferences including National Association for Equal Opportunity Higher Education High Tech Expo (NAFEO), Seizing Opportunities for Advancing Research (SOAR) Undergraduate Research Conference, ADMI Symposium on Computing at Minority Institutions, and the National Conference for Undergraduate Research (NCUR). In addition, student researchers participated in the Undergraduate Poster Session during the MUSPIN Conference96.

NRTS Service Awards were presented during the university's Honors Day Program. The Service Award included a certificate and a check for \$100. Recipients of the Service Award had contributed significantly

to the NRTS operations and programs. The services included assisting with training sessions, assisting with secondary school and ECSU networking jobs.

Dr. Michael A. Kolitsky
University of Texas at El Paso

Multimedia Teaching and Learning Center

1996 - 97

Courseware Production

(Individual workstation
and CD-ROM - based)

Classroom Presentations

(Non-web applications)

1997 - 98

Courseware Production

(Individual workstation
and CD-ROM - based)

Classroom Presentations

(Focus on web-based
classroom presentations
and presentations software
that can be "webified")

Web-delivered Courseware

Early production of Web-
delivered courseware
models will begin.

1998 - 99

Classroom Presentations

Web-delivered Courseware

Web-delivered courseware
will be brought on-line and
evaluated.

304

■
UTEP

COMPUTER LAB
Funded by NASA







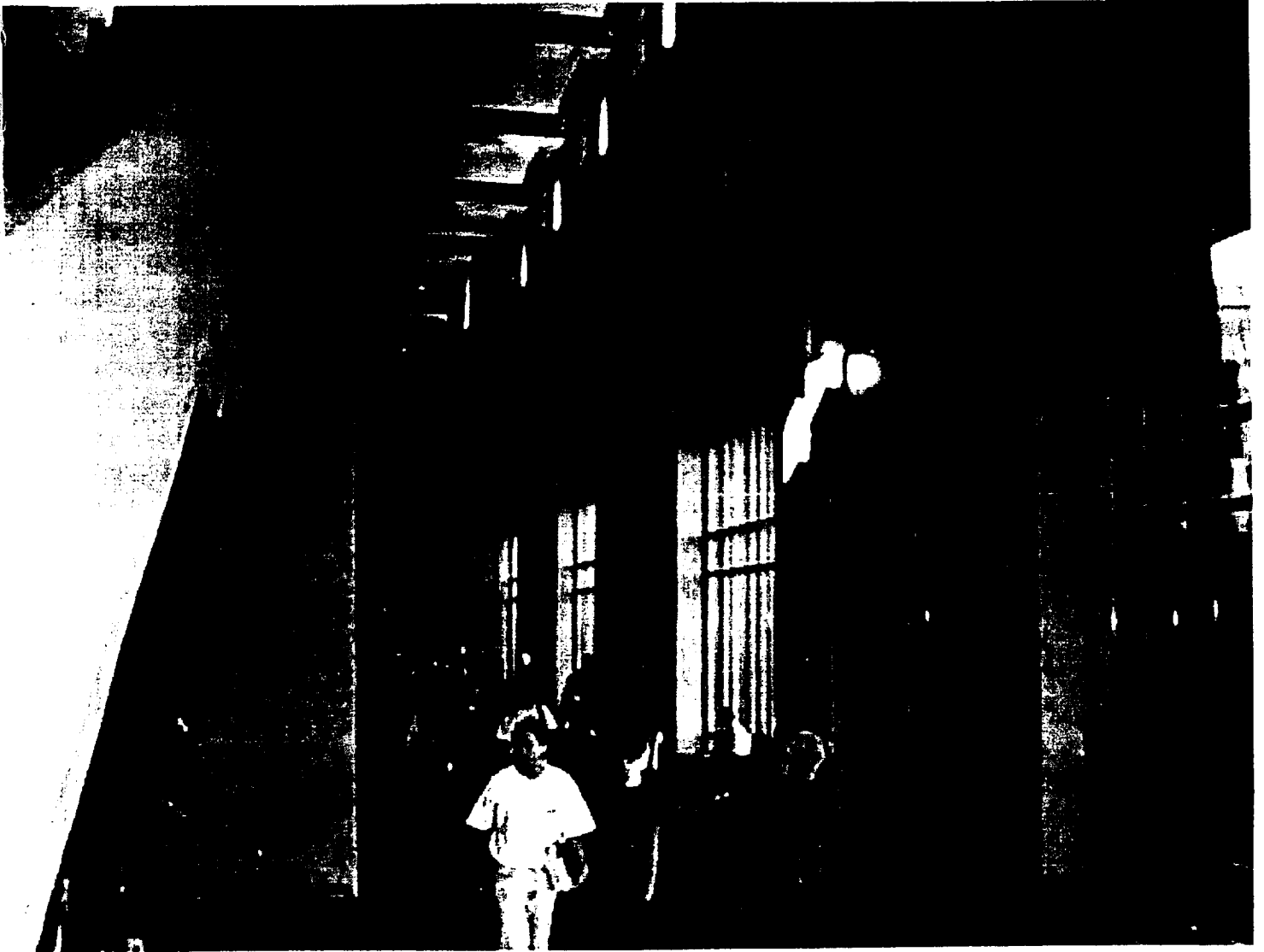

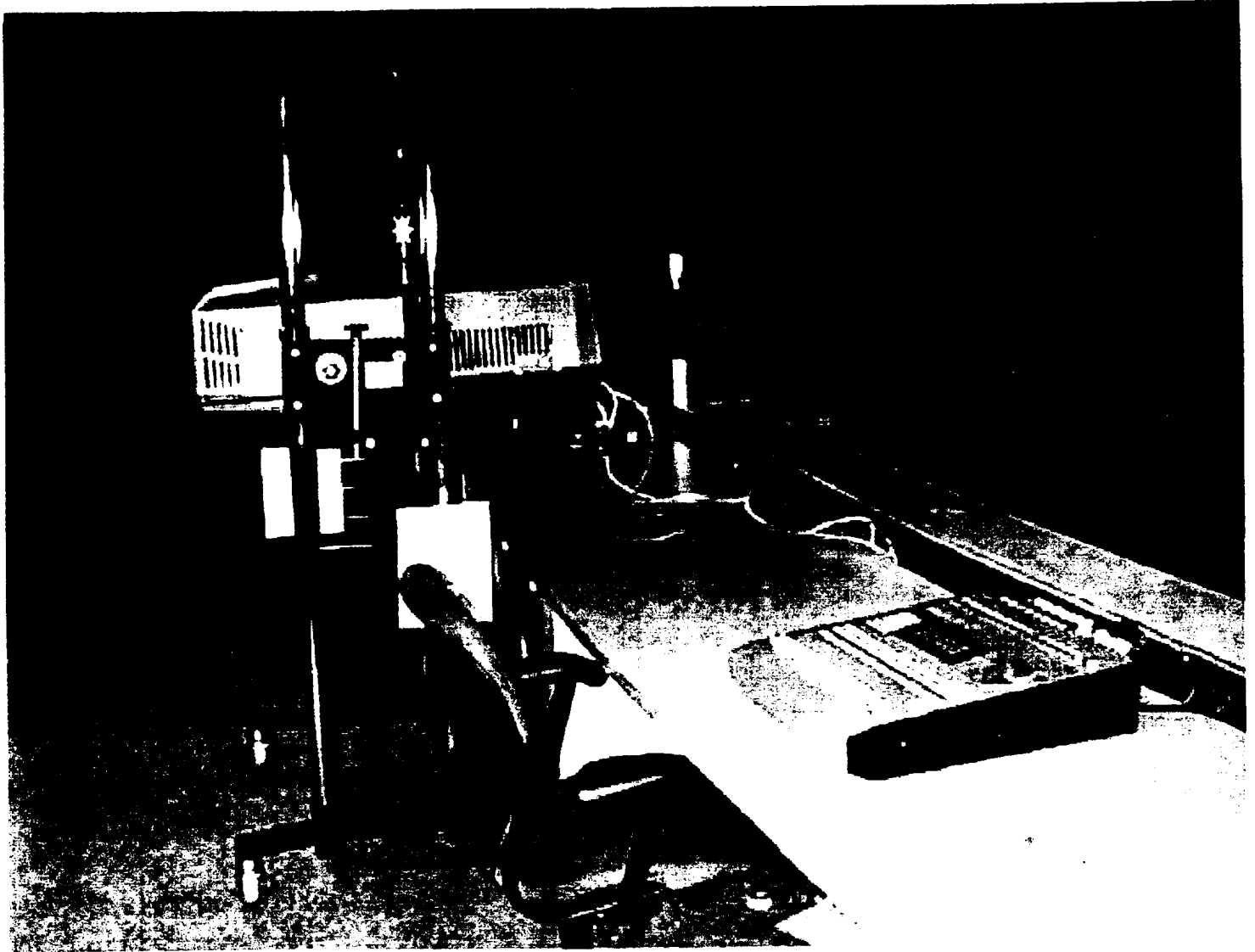









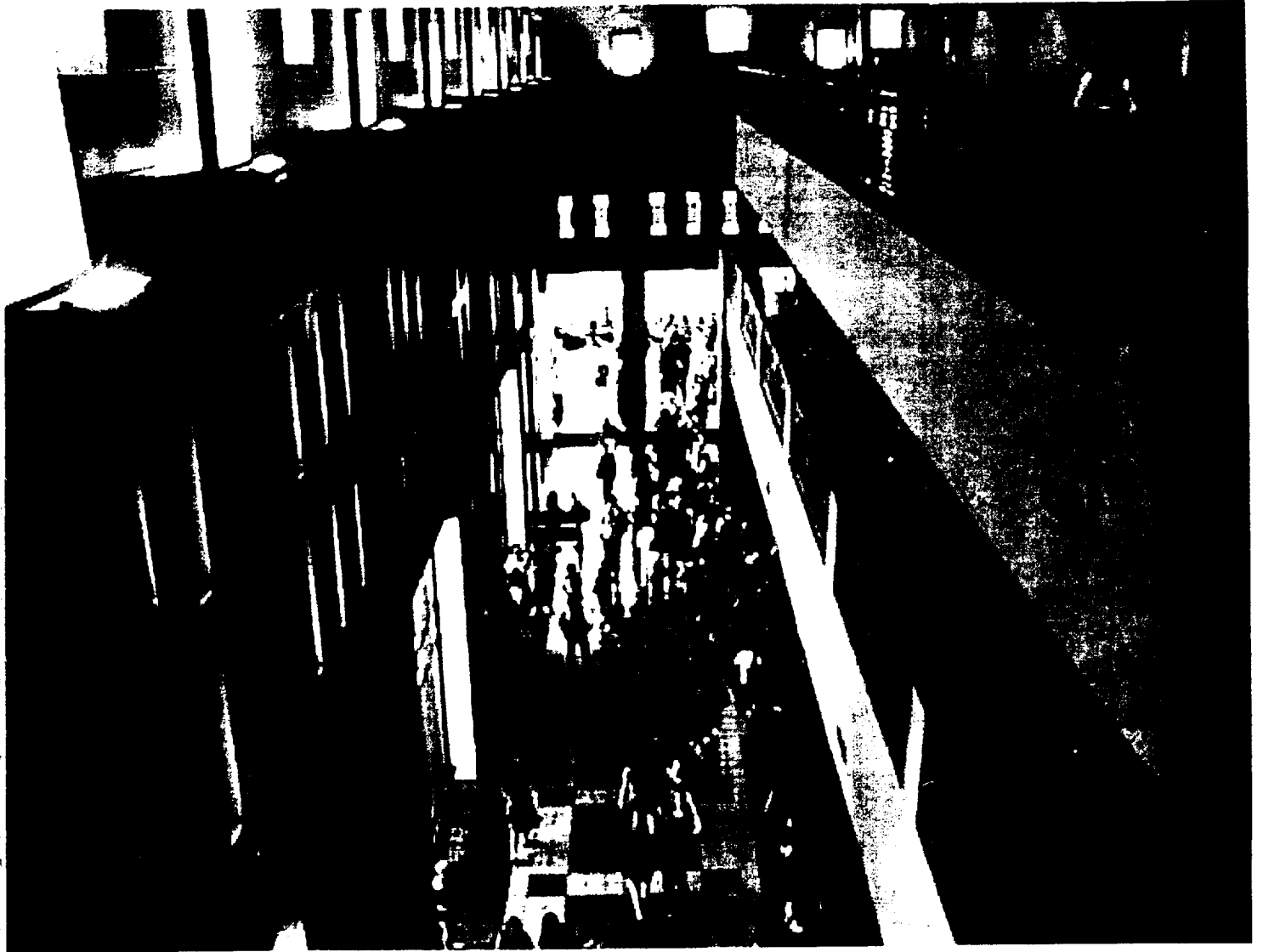





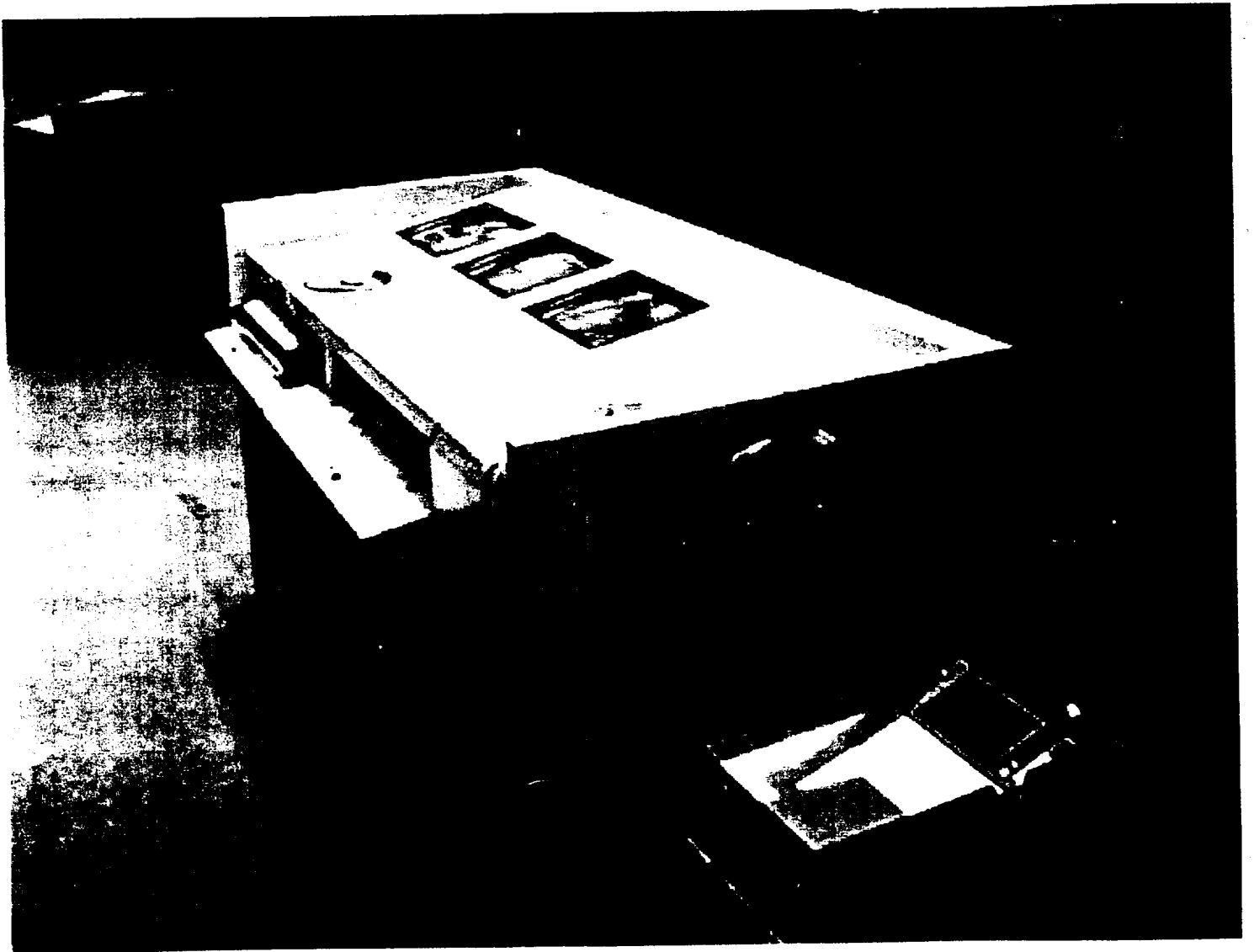

**Morgan State University
Network Research Training Site
High Performance Computing Partnerships**

A NASA Goddard Space Flight Center/MU-SPIN Program

**Dr. William L. Lupton
Chair, Computer Science Department**

Morgan State University

- ◆ Maryland's Urban University
- ◆ Heterogeneous student body of over 6,000
- ◆ Ranks 1st nationally among public colleges & universities (and 4th overall) whose science majors go on to earn Ph.D.'s
- ◆ Newly renovated science complex, new engineering facility, and engineering annex currently under construction

MSU - Research Infrastructure

- ◆ Cray J916 interconnects computing facilities of HBCUs and other minority universities with the NASA science network
- ◆ Campus totally connected via fiber cable
- ◆ 10 megabit SMDs
- ◆ Internet and computer resources
- ◆ Silicon Graphics Challenge & Indigo's
- ◆ PC and terminal labs

Network Resource Training Site

- ◆ High Performance Computational Science and Engineering
- ◆ Enhancement of research capabilities
- ◆ Graduate engineering curriculum
 - work experience requirement

Region II

◆ Maryland, Indiana, Ohio, West Virginia,
Delaware, and Pennsylvania

◆ Satellites

• Bowie State University

Dr. Nagi T. Wakim

• Central State University

Dr. Kamyar Dezhgosha

Foundation of Technical Plan

- ◆ University technological capabilities
- ◆ Outreach/teacher training to NRTS partners
 - elementary, middle, high schools and colleges
- ◆ Initial connectivity to the Internet
- ◆ In-house training

Morgan NRTS Impact

- ◆ 6 elementary schools
- ◆ 2 middle schools
- ◆ 2 high schools
- ◆ 7 colleges
- ◆ apprx. 24,930 pre-college & college students
- ◆ 1,700 pre-college & college teachers
- ◆ Waiting List

Summer Workshop

- ◆ Pre-College Teachers
- ◆ Creating a new paradigm
 - Access
 - Training

Summer Workshop (con't)

- ◆ College Level Teachers
 - Advanced search and access techniques
 - Overview of Internet mechanics
 - Variety of information resources
 - Download to hard copy
 - Discussion/user group

Collaborations with NAVO and Stennis Space Center

- ◆ Diversified cadre of well-trained scientists
and engineers
- ◆ Visiting scientists
- ◆ Course development

Collaborative Research At MSU

- ◆ Network Research Training Site (Computer Science)
 - The National Urban Technology Center
 - Multimedia educational software development
- ◆ Research Infrastructure for Minority Institutions (University)

Future Collaborations

- ◆ NASA Langley Research Center (Hampton, VA)
 - ◆ Minority Institutions of Higher Education Research Strategies and Funding Opportunities Workshop
- ◆ NASA Ames Research Center (Mountainview, CA)
 - NREN Project
 -

NASA/TSU Network Resources and Training Site Tennessee State University Second Annual Report

Dr. Willard A. Smith, NRTS Principal Investigator

INTRODUCTION

This report summarizes NASA/TSU NRTS activities for 1996-1997 and some of the planning for 1997-1998. Included are some of the discussions of the Regional Network Committee's work toward becoming an enterprise operation. This document also reflects some of the plans for Year Three, and in some cases beyond, for the NASA/TSU NRTS Enterprise.

MILESTONES AND DELIVERABLES

The Milestones and Deliverables for the Second Year of the NASA/TSU Network Resources and Training Site (NRTS), as specified in the Cooperative Agreement Number NCC 5-96, were accomplished by August 14, 1997. Several of the original goals for year two have been exceeded. Specific discussions of these accomplishments and related events are as follows:

- Metropolitan Area Network (MAN) connections to the Internet for all of the partners in the Metro area were in place. T1 lines are installed at all of the Universities except Fisk in the Metro area and at LeMoyné-Owen in Memphis and these connections are in process. The Metropolitan Nashville/Davidson County Schools are all connected with at least one ISDN line and plans for expansion of the bandwidth as use increases are under consideration.
- The Local Area Network (LAN) plans, as stated for year two, have been implemented for the MSET departments at the NASA/TSU NRTS campus and satellite sites. A significant addition not in the original plan is a Parallel Processing Lab implemented in the Math Department at TSU for collaborative research over the Internet with the University of Tennessee Knoxville and Oak Ridge National Laboratory. NRTS funds provided the wiring and a grant from DOE provided the high end workstations and the server.
- Baseline application servers were in place at all of the universities and in place or being installed at the elementary and secondary sites of the NASA/TSU NRTS project. The services vary with the needs of the site as shown in the following more detailed Partnership Reports.
- User Support and Network Operations Offices are functioning at the NRTS sites. The Universities have dedicated on site staff at all institutions. The elementary and secondary schools had limited on site staff, but a central support staff through the Technical and

Library Services Group was available through the Metropolitan Nashville/Davidson County School System. These schools and all the NRTS sites also had direct phone and on-line support from the NASA/TSU NRTS Help Desk at Tennessee State University.

- Remote network management procedures are under development. The interface with MU-SPIN seems effective, but presently not all of the satellite sites are using SNMP to allow the needed interfaces. Remote network management procedures and extended support and maintenance are topics for our next Regional Network Committee meeting.
- The Marshall Space Flight Center has been very helpful in analysis and planning for improvement of performance of the TSU Network. The suggestion to install a 10-Base-t campus isolation switch seems to be a very good solution to the slow performance of the system.
- The funds for the NASA/TSU NRTS Project continue to be leveraged to a considerable degree. The continued funding of the Metropolitan Nashville/Davidson County Schools, the work and funding at Knoxville college, Lane College and the in the departments of Math, Biology, Chemistry, Computer Science, and Agriculture at TSU has totaled well over \$600,000 in year two. Other funding with leveraging efforts are still pending as of this date. Several of the NRTS sites accomplished outstanding improvements and enhancements to the networks and services at there sites. These are discussed in detail in the Partnership Reports that follow.

PARTNERSHIP REPORT

All NASA/TSU NRTS partners have been involved in training at their sites and/or technical site visits to address the needs of each of the sites. The NASA/TSU NRTS Regional Network Committee (RNC) met regularly to discuss common interests. In the last three meetings we worked with Dr. Ely Dorsey, our NASA/TSU NRTS consultant. The goal of this work with Dr. Dorsey is to become an enterprise operation. These meetings have gone very well. The regional partners have cooperated in the development of the Electronic Flash?, a newsletter to share information and interest with the NRTS sites and GSFC. The design for revisions of NASA/TSU NRTS Home Page are another enterprise effort. These revisions are in progress. For Year Three of the Grant period the Regional Network Committee is preparing a joint design to develop a collaborative support and maintenance function for the consortium. This report was an enterprise wide report prepared with input, editing, and review of the full RNC.

Electronic Flash?: The first edition of the Newsletter was published in August 1997. Dr. John Vickers, Dr. Willie Brown, Ms. Marsha Williams, Dr. John Springer, Dr. James Holloway, and Dr. Willard Smith will serve as the editorial staff of the Paper. Dr. Thomas, one of 25 Physicists at Fisk University, worked in setting up a chat link for the committee to meet on-line in June to address the purposes of the newsletter established by the RNC. This did not

prove to be satisfactory. Communications by E-mail are much more effective. Difficulties in scheduling and in the different typing speeds and skills of the chat participants were major problems with this "chat room" effort. Additional work will be done to enhance communications on the Electronic Flash? and the other enterprise wide activities.

Support and Maintenance: This is a problem on every campus of the NASA/TSU NRTS cluster. The overall lack of funding, needed equipment that is not available, and trained personnel to support and maintain equipment and services, related to technology have been identified as problems. The goal of this effort is to develop a better way to address these problems as an enterprise wide operation. With a good plan and its implementation, we hope to find ways to fund the process, and use the strengths of equipment and personnel of each site, and share these scarce resources to make our services more helpful and functional to our Math, Science, Engineering, and Technology (MSET) clientele.

Year Three Cooperation: Preliminary Proposals for the year three efforts were received June 1997. These proposals will be shared and the RNC will direct the efforts and funds of the NASA/TSU NRTS toward the proposals, or components of proposals of most benefit or of greatest need.

HIGHLIGHTS AT NRTS PARTNERS

Alabama Agricultural and Mechanical University: Dr. John Vickers and the Academic Computerization group implemented an automatic E-mail system for every registered student at Alabama A&M. This is automatically updated with each registration. Complete documentation of the system is available to every user. This has resulted in all fifty-five hundred plus students learning the E-mail component of the Network systems. This system has resulted in all of the departments on campus cooperating in common E-mail systems and services. The E-mail system connects all labs and offices wired on the A&M campus.

Fisk University: Dr. John Springer has led Fisk in obtaining five of the recent challenge grants from the NASA regional sites. Work is underway with NASA at Ames to collaboratively upgrade the Internet connection to further enhance the research using the Internet. Upgrade of the Internet connection to T1 is in process as this paper is written and should be completed by the time of this meeting. This connection is arranged through The Tennessee Board of Regents (TBR) a partner of the NASA/TSU NRTS project. Through a leveraged agreement the Tennessee Board of Regents is able to provide these connections at a 60-+ Percentage reduction below the BBN Planet price, allows for a leveraged saving of ~\$85,000 per year for the Lines at Fisk, Lane, TSU, Meharry, and LeMoyne-Owen. There is a long term agreement to continue arrangement for T1 lines after completion of the current project. Fisk successfully hosted the Spring Hands on Sessions of the MU-SPIN Workshops.

Jackson State University: Dr. Willie Brown led in the development of a Department of Defense Modernization Grant for the University. Jackson State University and the Computer

Science Department will be involved in WEB-BASED training with connections to the University of Illinois' National Center for Super Computing. Dr. Brown also arranged for the transfer of sixteen computers from the Navy Meteorology Command at NASA Stennis Space Center to Blackburn Middle School, a Jackson State University partner school. The computer science department installed the computers, networked the computers, and provided Internet access through a modem connected to Jackson State. High speed lines will be installed with cooperation of the Mississippi State Department of Education state wide education network project. The University has contracted a firm to design and install a campus wide fiber backbone for the continued development of networking at Jackson State University.

Kentucky State University: Dr. Tom Hughes led in documenting the design of the first campus wide network plan for Kentucky State University. The NRTS grant funded released time for Dr. Hughes, from his duties at KSU, to allow him to coordinate the plan. With the help of the state and outside grant funds considerable progress was made toward implementing the plan. Plans to extend the network across US Highway 60 to the technology facilities of the Kentucky State University South Campus are in place for the coming year. KSU hosted training provided by the NASA/TSU NRTS Staff for the faculty and Staff of KSU. The training on the use of the Internet and related materials are now being used to do their own training.

Kings Lane Middle School: Mr. Bruce Howell led, in cooperation with the NASA/TSU NRTS staff, in planning and installing the network connections of the Kings Lane Middle School. Fifty-six connection drops were installed in the appropriate learning sites of the school. A new server and computers are being installed. The computers being placed at Kings Lane are a combination of computers purchased by NRTS and surplus computers from NASA Marshall Space Flight Center through the Stevenson Wydler Act. The recycled computers were tested and reconditioned by TSU students before installation at the school. The NRTS students at TSU have been a valuable asset to Kings Lane and to many of the Metro-Nashville/Davidson County Schools served by the "Help Desk"/on site services of the NASA/TSU NRTS center. As the public schools worked to meet the mandates of connecting all school buildings in Tennessee to the Internet via an ISDN line the shortage of staff in the Metro Schools in implementing this plan was acute. Several TSU students, on the NRTS Staff, and in the Computer Science Department, were very helpful and received valuable experiences in this huge effort.

Knoxville College: A new computer lab for the Math Department at Knoxville College was the result of G. Mosthafa Pathan attending an MU-SPIN TSU workshop in the spring of 1996 on "how to create a networked lab". Mosthafa determined he could do all of the wiring to create a lab. At that time Knoxville College had two small antiquated labs for word processing. Through Mosthafa's efforts Knoxville College acquired ~ \$150,000 of outside funding from the National Science Foundation in cooperation with The University of Tennessee, Knoxville, and the United States Air Force. He convinced the college to fund the remodeling of the classroom with college funds. A raised floor was put in the lab to allow for covering of all of the wiring. Through the leverage of the support of the NASA/TSU NRTS project he completed work in the remodeled classroom in the Science Building, installed the wiring, and computers for a 24-station

lab. NASA/TSU NRTS bought the necessary server for the lab. NASA/TSU NRTS working with the local phone company in Knoxville, Tennessee is in the process of connecting this lab to the campus T1 connection. Through an additional \$50,000 grant from the United States Navy, Mosthafa is completing a 16-station lab for Physics research. With the Knoxville College contributions these projects will exceed \$250,000 and provide two fully networked labs on a campus of ~ 400 students.

Lane College: Dr. Darlene Brooks has led in connection of the Science Lab to the Campus Fiber backbone. This was done through leveraging of Title Three funds and support of the NRTS Help Desk at Tennessee State University. A new server was installed and the NRTS project provided funding for the wiring for the new computer lab in the Academic building that is currently under construction. Efforts continue to extend full Internet connections to all campus work stations.

LeMoyne-Owen College: Mr. Gerald Flournoy had not been a regular attendee at the NRTS Workshops or at the Regional Network Committee. He has been replaced by Wilson Ojwang and a backup member. NT Server Licenses have been purchased by NASA/TSU NRTS for the Alpha Server at the college. LeMoyne-Owen College manages the web site for the Dr. Martin Luther King Museum and has a significant outreach to the low income housing area around the college. The residents use the computer labs in the evenings and on the weekends. The Internet connection at LeMoyne-Owen was upgraded to a T1 line in late September 1997, with the help of the above discussed TBR arrangement.

Meharry Medical College: Ms. Marsha Williams is currently involved in designing a network plan for the campus for the future. This is in cooperation with Bell South and will be completed in the near future. Meharry hosted the spring workshops for the NASA/TSU NRTS cluster in the Learning Resource Center on the Meharry Campus. NRTS has ordered a new Web server to enhance the presence of Meharry Medical College on the Internet. Further plans will be developed based on the Network Plan now being developed by Meharry and Bell South.

Pearl-Cohn Comprehensive High School: Mr. Hall has provided leadership in the networking of the full complex. This project was in cooperation with the State of Tennessee TECnet Project and the Metropolitan Nashville/Davidson County Public Schools. Pearl Cohn High School experienced a lightning strike in late August and/or early September 1996. NASA/TSU NRTS staff and several TSU Computer Science students spent several hundred hours troubleshooting, connecting or replacing equipment, and programming the equipment at Pearl-Cohn High School. This resulted in the first fully networked secondary public school in Nashville. This effort has involved 153 workstations at the eleven hundred plus student complex. This was a very valuable experience for the TSU students and a very good presence for TSU on the Pearl-Cohn Campus.

Tennessee State University: Dr. James Holloway guided the establishment of Tennessee State University Department of Computer Science as it became an independent

department of the University effective the fall of 1996. The NASA/TSU NRTS grant helped to leverage a \$70,000+ grant from the Microsoft Corporation to the Computer Science Department. After review of the strengths of NRTS and the Computer Science Department, the Department of Computer Science has been selected as a beta test site to work with Microsoft Software Development. The support of the NASA/TSU NRTS project resulted in a Grant from the United States Department of Agriculture for a new computer lab in Agriculture. This leveraging resulted in a \$250,000 benefit to the College of Agriculture. Two senior courses for computer science students were placed on the computer at TSU. These courses required extensive use of the Internet and collaboration with other web sites and students around the world. These courses involved 61 students. (See Table 1) Plans for expansion of courses of this type are in process.

Table 1
Students Effected by NRTS Oriented Classes
1996 - 1997

Student	Major	Degree	Date	GPA	NRTS Classes	Project	Future	
Al-Jassar, Nabeel	B.B.A.	B.B.A.	8-98	2.8	HTML	International Internet	Student	
Alroumi, Bura	B.B.A.	B.S.	5-98	2.31	HTML	Internet Security	Student	
Alsider, Fahed	CS	B.S.	12-97	3.0	HTML	Graphics on the Web Artificial Intelligence	Student	
Bryant Kendric	CS	B.S.	5-98	2.8	HTML	Windows Programming	Student	
Burrell II, Carl	CS	B.S.	8-97	2.8	HTML, JAVA	Internet Applications	Student	
Claybon, Joseph	CS	B.S.	5-97	2.5	HTML	Database Setup	No job yet	
Daliri, Mehrdad	CS	B.S.	5-98	3.2	HTML	Home Page for the Meter	Student	
Daniel, Carrandre	CS	B.S.	5-97	3.2	HTML	Web Site Development	IBM	
Gardner, Amber Lucent	CS	B.S.	5-97	3.287	PC Tech	Handheld PC's Technologies	No job yet	
Hattaway, Marvin	B.B.A.	B.B.A.	5-97	2.5	Networking	Network Design	No job yet	
Haynes, Louis	CS	B.S.	12-98	2.5	HTML	HTML Tutorial	Student	
Jackson, Andre	CS	B.S.	8-98	2.9	HTML	Video Game	Student	
Jarrett, Darrell	CS	B.S.	5-97	2.8	Networking	LAN	No job yet	
Johnson, Thomas U.S. Navy	CS	B.S.	8-97	2.6	HTML	Cryptology Artificial Neural Nets	No job yet	
Jones, Angela	CS	B.S.	5-97	3.045	Networking	Computer Viruses Object Oriented Progs.	No job yet	
Jones, Enoch Student	CS	B.S.	5-98	2.4	PC Tech	Memory Management		
Jones, Horace	CS	B.S.	5-97	2.7	Networking	LAN Management	No job yet	
Jones, Jesse	CS	B.S.	5-98	2.2	HTML	Home Page Bookstore	Student	
Kazmi, Hassan	CS	B.S.	5-98	2.94	HTML	Windows Programming Tutorial as Home Page	Student	
Kizer, Kesha	CS	B.S.	8-97	2.56	HTML	Computer Graphics and	No job yet	
Lauraence. Hope	CS	B.S.	5-97	3.5	HTML	CS Home Page	Lucent	
Ledbetter, William	CS	B.S.	5-98	2.57	HTML	Video Games in C++	Student	
Lockhart, Joi	CS	B.S.	5-97	3.0	HTML	Artificial Neural Network	Northern Telecom Norcross, GA Graduate Study Georgia Tech	
Magby, Frederick Student		CS	B.S.	12-97	2.786	HTML	Home Page Academic Computing	

Martin, Travis	CS	B.S.	8-97	2.6	HTML	Home Page Academic Intervention Center	No job yet
Patton, Clorissa	CS	B.S.	5-97	2.8	HTML	Interconnection Networks	No job yet
Qazait, Ammar	CS	B.S.	12-98	3.308	Networking	Computer Crime Student	
Rafferty, Arthur	CS	B.S.	5-97	4.0	HTML	Lexical Analysis	U.S. Post
Rawls, Cherita	CS	B.S.	8-97	3.186	HTML	Home Page Creation	No job yet
Scales, Jermaine	CS	B.S.	8-98	3.2	HTML	HTML Programming	Student
						Home Page for Academic Computing	
Shah, Avnni	CS	B.S.	12-97	2.85	Hardware	Hardware Interfaces	Student
Sims, Tomeko	CS	B.S.	5-97	3.7	HTML	Home Page for CS	Lucent
Taylor, Michael	CS	B.S.	5-97	2.48	LAN	LAN Information Systems	

The Department of Physics is placing the first web-based course on the TSU system. This introduction to college physics is to be a foundation for recruiting for the Physics program. This course was developed with NRTS support of the faculty member developing the course. The Math Department in collaboration with Oak Ridge National Lab and the University of Tennessee at Knoxville received funding for a Parallel Processing Lab to do collaborative research over the Internet. NRTS provided the wiring and the technical support for this lab. The LAN plans at TSU, as they existed for this year, have been implemented for the MSET departments.

The RNC has determined that a meeting dedicated to the definition of and the statement of the needs for Distance Learning will be held. This is an integral part of efforts at several of the sites and is a part of the NASA/TSU NRTS Expert Center for Astronomy discussed below.

Student Impact

The cooperation of the NASA/TSU NRTS project and the Nashville/Davidson County Metropolitan Public Schools involved 31 schools with more than 15,000 students in 1996-1997. This was a part of the effort to develop 21st Century Schools, Schools for Thought and the NRTS partner schools. This provides Internet access to this large group of K-12 students. This is a part of the total of 130 school buildings connected in Metro Nashville.

Tennessee State University, in pursuit of the goals of the Cooperative Agreement for NRTS, hired a full time training person permanently housed in Academic Computing. The training of more than fifteen hundred students and 200 faculty has greatly impacted the use of the Internet at TSU. This training commenced in late October and the spring statistics of the T1 connection reflect a 50% increase in use of the Internet at TSU.

The efforts of the students in assisting the personnel of the METRO schools have resulted in the technology transfer of the skills of managing and maintaining the network and network components at the schools involved. The presence of the TSU students and the staff in the schools was a great outreach for the university as a whole. The NRTS project was in more schools and provided more services to more schools than any other TSU project this year. These schools use the NRTS Help Desk as the first line for troubleshooting problems at their institutions. This desk is manned by students trained to aid the user. Many problems are

resolved on the phone. More difficult problems are recorded and logged to be staffed by the technical personnel of TSU and the Metropolitan Schools.

Table 1 above reflects the two classes targeted by Dr. Holloway and Dr. Smith to enhance the use of the Campus Network and the Internet in upper division Computer Science Courses. The table also reflects the training in the NRTS developed courses to aid in use of these resources. The online Physics class and a planned web-based course in Biology will further this effort this fall. The new classes in Networking in the Department of Computer Science this fall will work toward a Networking Emphasis in the Computer Science degree program.

Cooperative efforts in the Center of Excellence saw 42 students in the MSET departments working on research for NRTS, the Center for Automated Space Science, Center for Computational Mathematics, and the Tennessee Space Grants this past year. These projects ranged from analysis of astronomical data, to placing a camera for remote observation and trouble shooting at the robotic telescopes' site in Arizona from Nashville. With the addition of the Center for Systems Science Research the COE is employing a full time coordinator/mentor to work with the expanding number of students. NRTS students will fully participate in the learning opportunities of this program.

Training

The training sessions of the hands-on part of the MU-SPIN workshops have been continually over subscribed. This is resulting in researching the possibility of expanding the training lab of the NRTS site or looking to other facilities. This lab was provided by the university and is shared by Academic Computing. Academic Computing has hired a full time trainer and has conducted two to five workshops per week for faculty and students since October 1996. This is a permanent position funded by the University and several of the classes were developed in cooperation with NRTS. Dr. Holloway conducted workshops at KSU and has trained the trainer, Ms. Ollie Reshad. She uses the materials and handouts developed by Dr. Holloway.

The NASA/TSU NRTS staff was requested by the Tennessee Board of Regents to provide intensive one day workshops for the 26 Tennessee Technological Training Centers. (See Table 2) The Tennessee Board of Regents is one of the NRTS Partners and has been of great assistance, as discussed above in obtaining T1 lines for several of the NRTS sites. This training program was acclaimed, as being very successful, by the participants and the staff of the TBR. Work is now underway to develop some of this training on the NASA/TSU NRTS Web site.

Research: Expert Site for Astronomy

TSU is in the process of combining the needs of the NRTS Center for Astronomy, The Center for Automated Space Science, Explorers of the Universe, and the Center for Systems Science Research into an integrated program for a Center of Astronomy. The Information Systems Engineering and Management Center of Excellence (ISEM-COE) is recruiting an astronomer/educator to head this effort. Tennessee State University has reactivated five Astronomy courses that have been dormant for some years. The first of these was offered this

fall. A design for teaching in a "distance learning" mode is under development. This may be of the, CUCME, Internet based, a satellite delivered program, or some combination of these modes of presentation and transmission. A research design to evaluate the effectiveness of these various modes is under development.

The Center for Automated Space Science has the worlds largest group of robotically controlled telescopes. These instruments are available for research and remote learning for the Explorers of the Universe Program. In addition a large mound of data collected over the years, remains to be mined by students in classes working in this Expert Center.

One of the components needed in this effort is a quality Multi-Media Lab. The center is working to develop such a lab with the Department of Communications to assist in the delivery of these courses and to develop more utilization of multimedia on the campus as a whole. NRTS will be a major component in the partnership of this lab. The long range partners will likely be the Department of Communication and Computer Science.

Table 2
NASA/TSU NRTS INSTITUTIONS IMPACTED

Institution	Students	Faculty	Staff
Tennessee State University	8750	535	1000
Alabama A&M University	5300	400	875
Fisk University	812	72	88
Jackson State University	6500	450	300
Kentucky State University	2450	127	400
Knoxville College	475	46	40
Lane College	574	56	69
LeMoyne-Owen College	1075	86	125
Meharry Medical College	850	290	1150
Tennessee Technological Centers at:			
Athens	388	26	31
Covington	139	17	21
Crossville	625	34	43
Dickson	378	23	29
Elizabethton	270	24	29
Harriman	274	23	28
Hartsville	205	20	22
Hohenwald	515	30	38
Jacksboro	317	26	29
Jackson	713	36	43
Knoxville	599	32	41
Livingston	598	32	40
McKenzie	226	20	23
McMinnville	319	26	29

Memphis	685	37	41
Morristown	913	41	46
Murfreesboro	2826	87	105
Nashville	916	42	45
Newbern	215	19	21
Oneida	245	21	22
Paris	579	29	32
Pulaski	478	31	34
Ripley	148	13	18
Crump	439	27	31
Shelbyville	593	34	38
Whiteville	309	24	27
Chattonooga	912	41	46

The work of the NASA/TSU Network Resources and Training for the grant year of 1996-1997 resulted in another very successful year. The growth in the interaction of the participating partners is perhaps the most important result of this years work. The year saw direct benefits extended to all of the sites. The addition of a back up to each of the cooperating individuals had resulted in the in crease of talent and increase in interaction between the members of the consortium. As the enterprise component grows the success of the project will also grow.

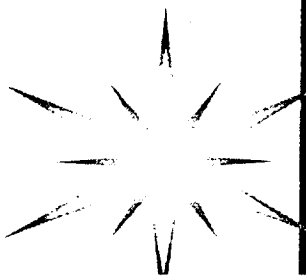

A NASA/MUSPIN Project



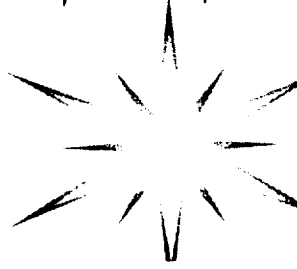

Y2: Expansion & Incorporation
Y3: Training & Collaboration

SCSU NRTS Staff

- Dr. Donald Walter, PI
- Ms. Alice Baker, Program Coordinator
- Mr. Vinesh Gupta, Systems Admin.
- Mr. Samir Maniar, Network Manager
- Ms. Stephanie Rusnak, Internet Trainer
- Ms. Helen Stillinger, Admin. Assistant

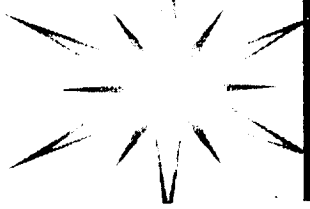

YEAR 2: Expansion

➤ Partner Schools

- 1 K-12 found separate funding
- 1 HBCU added to consortium

➤ Currently 12 Partner Schools

9 Colleges/Universities

3 K-12

Florida, Georgia, South Carolina

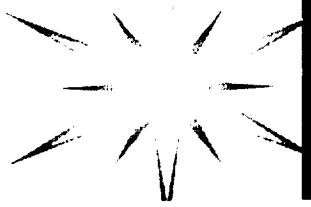

YEAR 2: Expansion

- Allen University
- Benedict College
- Bowman Mid/HS
- Claflin College
- Edward Waters Coll.
- Florida Inter. Univ.
- Howard Middle Sch.
- Morris College
- Morris Brown College
- Orangeburg-Wilk. HS
- South Carolina St. U.
- Voorhees College

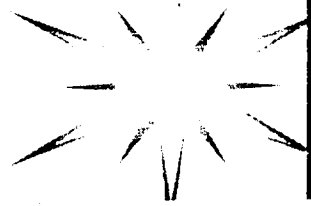

YEAR 2: Expansion

- **Sept 1996:** PI + 1.5 full time staff
- **Sept 1997:** PI + 5 full time staff
- **Business Partners:**
 - MUSPIN & Consultants
 - Information Tech. Solutions (VA)
 - ADNET Systems (MD)
 - Dr. Patrick Shopbell (Caltech)

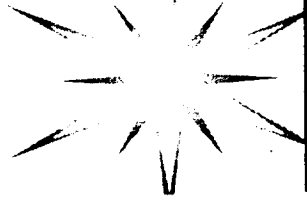

YEAR 2: Expansion

➤ Physical Infrastructure

- * Connectivity at 64 kbs or higher
- * First new hardware in years
- * Intra/Internet Servers
 - Benedict , FIU, Morris Brown
- * UNIX Web Servers at SCSU
(news, web, email, ftp)

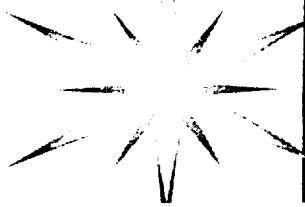

YEAR 2: Expansion

➤ Services & Applications

- * Faculty Travel Awards
- * USO (User Support Office)
- * Training - full time Trainer
- * Reliable Email Service
- * Web Master Assistance
- * UNIX, Perl, Animation, CGI, C++

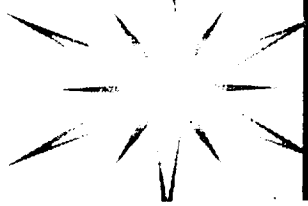

YEAR 2: Expansion

- **Increased Partnership Interaction**
- **Fall/Spring Workshops**
(90-100% attendance record)
- **1st Annual Retreat - 2 days in July**
- **Research Familiarization Talks**
- **Ongoing Programs (Ben., Voor., Claflin)**
- **Possible Collaborations (MB, SCSU, Voor.)**

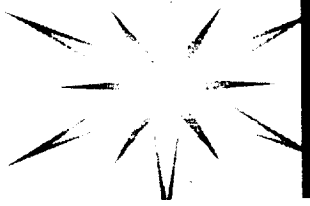

YEAR 2: Workshops

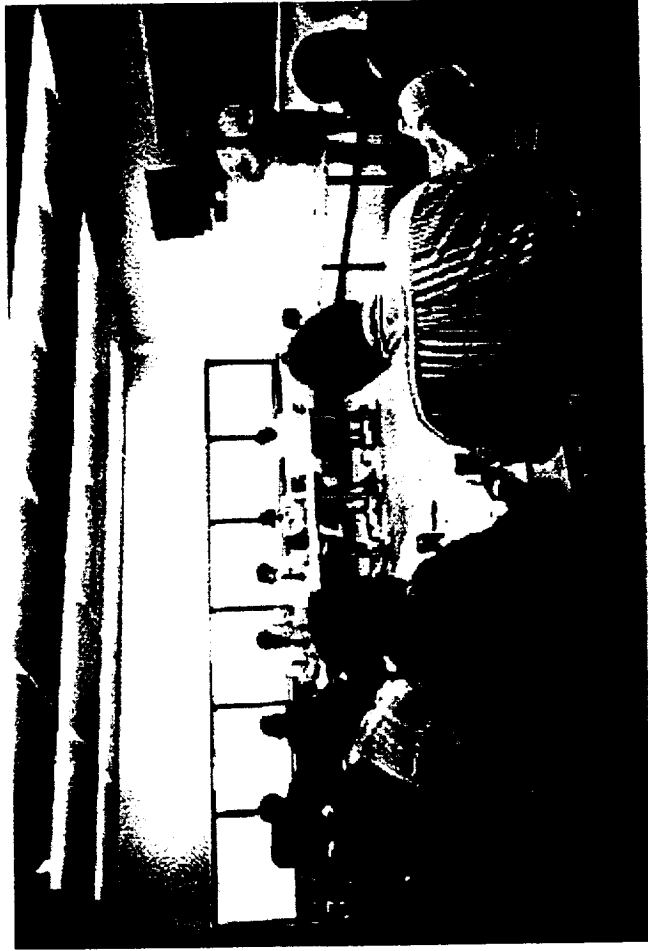

Dr. Dorsey's Interactive Sessions

YEAR 2: Expansion

- Astronomy
- NASA/HST
- Comet Hale-Bopp
- www.draco.scsu.edu
- Student Program
- Over \$45,000
- 23 Students

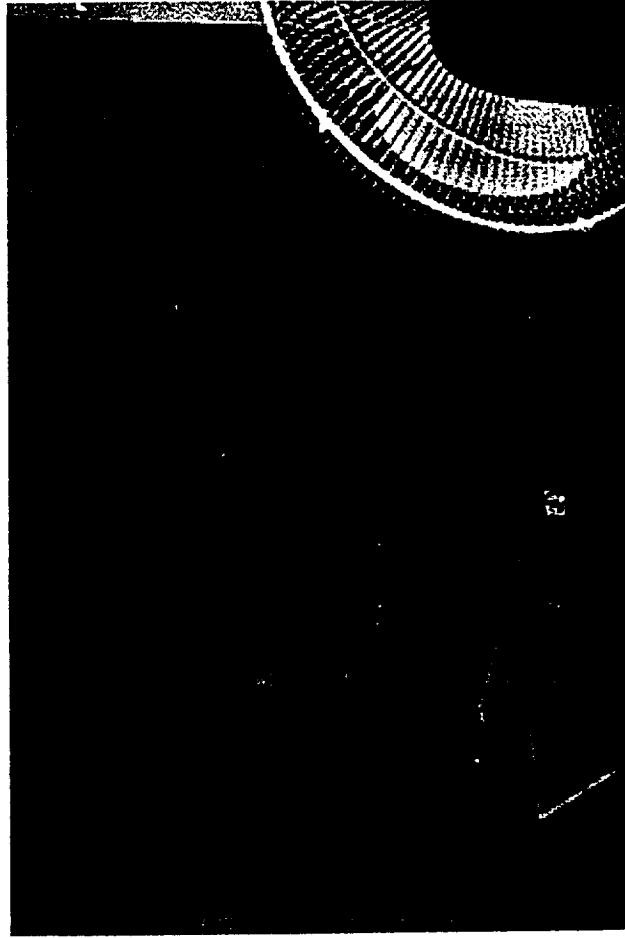

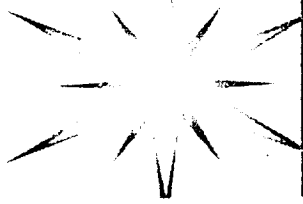

YEAR 2: Incorporation

- Training
- 157 sessions
- 3,671 people
- On-line Resources
- H.S. physics/calculus
- Univ. physics, chem.
- Training Materials
- Budget Submission



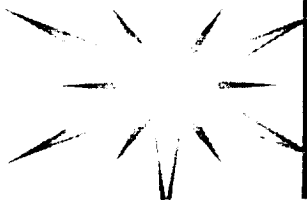

-YEAR 2: Success Stories

- Voorhees \$600,000 NASA-GIS
- SCSU \$400,000 Materials Character Lab
- Bowman HS \$93,000 for 2 Pentium Labs
- Claflin College \$80,000 for 2 Pentium Labs
- Morris Brown - New Web Server & Access
- Allen leveraged MUSPIN \$ to get fiber
- FIU + Benedict - Strong Outreach Programs
- New Distance Learning Labs at 4 Schools

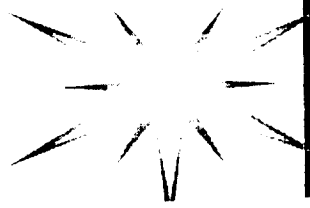

YEAR 3: Training Plans

- Training Lab at every Partner School
- Web Server at every Partner School
- 18 different workshop selections
- Live Help Desk at CNRT
- Monthly Photo & Scanning Sessions
- More Faculty Seminars & Student Talks
- Student Web Page Contests

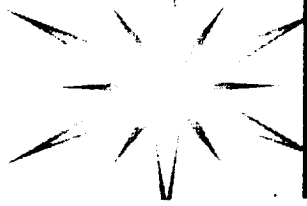

YEAR 3: Collaborations

- Partners Decide on \$63,500
- Faculty Travel to NASA-URC
- More travel to Fall/Spring Workshops
- FIU Supercomputing
- Tech Support Listserv - Dr. Dorsey idea
- Proposal submission among partners
- Proposal submission with other NRTS

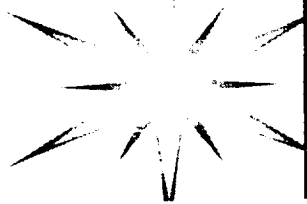

YEAR 3: Other Advances

- Extensive On-line reporting
 - Video conferencing & distance learning
 - Greater local tech support
 - Greater Research Efforts
- * Co-host Research Workshop - Nov 97
- * Material & Environmental Sciences

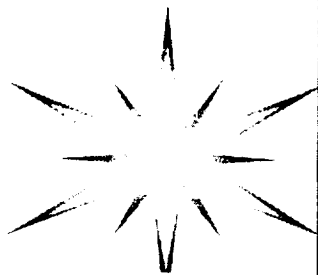

More Information

Main Server: www.cnrt.scsu.edu

Astro Server: www.draco.scsu.edu

Mission to Planet Earth (MTPE)

*Mr. James R. Greaves
NASA Goddard Space Flight Center*



Mission to Planet Earth

NASA'S Mission to Planet Earth Program

**Presented by
James Greaves
Head, Program Managers Group
Mission to Planet Earth**

October 9, 1997





Mission to Planet Earth

NASA “Strategic Enterprises”:

- Aeronautics
- Human Exploration and Development of Space
- Space Science
- **Mission to Planet Earth**





Mission to Planet Earth

Why Study Earth from Space:

- Human society is vulnerable to environmental change
- We are altering the Earth on a global scale
- We are uncertain how these changes will affect the Earth
- We need to understand these changes so that we can make informed and objective policy decisions affecting future generations

- **SPACE OFFERS AN OBJECTIVE VIEW OF THE ENTIRE PLANET**





Mission to Planet Earth

Mission

To develop understanding of the total Earth system, and the effects of natural and human-induced changes on the global environment.

Goals

- Expand scientific knowledge of the Earth system using NASA's unique capabilities from the vantage points of space, aircraft, and *in situ* platforms
- Disseminate information about the Earth system
- Enable the productive use of MTPÉ science and technology in the private sectors





Mission to Planet Earth

MTPE Science Themes: 1997-2002

- **Land Cover and Land Use Change Research**
 - What is the nature and extent of land cover and land use change and the consequences for sustained productivity?
- **Seasonal-to-Interannual Climate Variability and Prediction**
 - Can we enable regionally useful forecasts of precipitation and temperature on seasonal-to-interannual time frames?
- **Natural Hazards Research and Applications**
 - Can we learn to predict natural hazards and mitigate natural disasters?
- **Long-term Climate: Natural Variability & Change Research**
 - What are the causes and impacts of long-term climate variability, and can we distinguish natural from human-induced drivers?
- **Atmospheric Ozone Research**
 - How and why are concentrations and distributions of atmospheric ozone changing?





Mission to Planet Earth

Weather
Satellites
(NOAA)



EOS Platforms (24 measurements
15 year data)

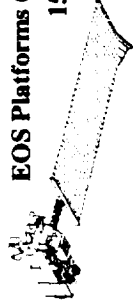

Earth System Science Pathfinders



New Millennium Missions

Research

Buoys
Data and
Information
Systems

Ground
Stations

Ships

Aircraft/
UAV

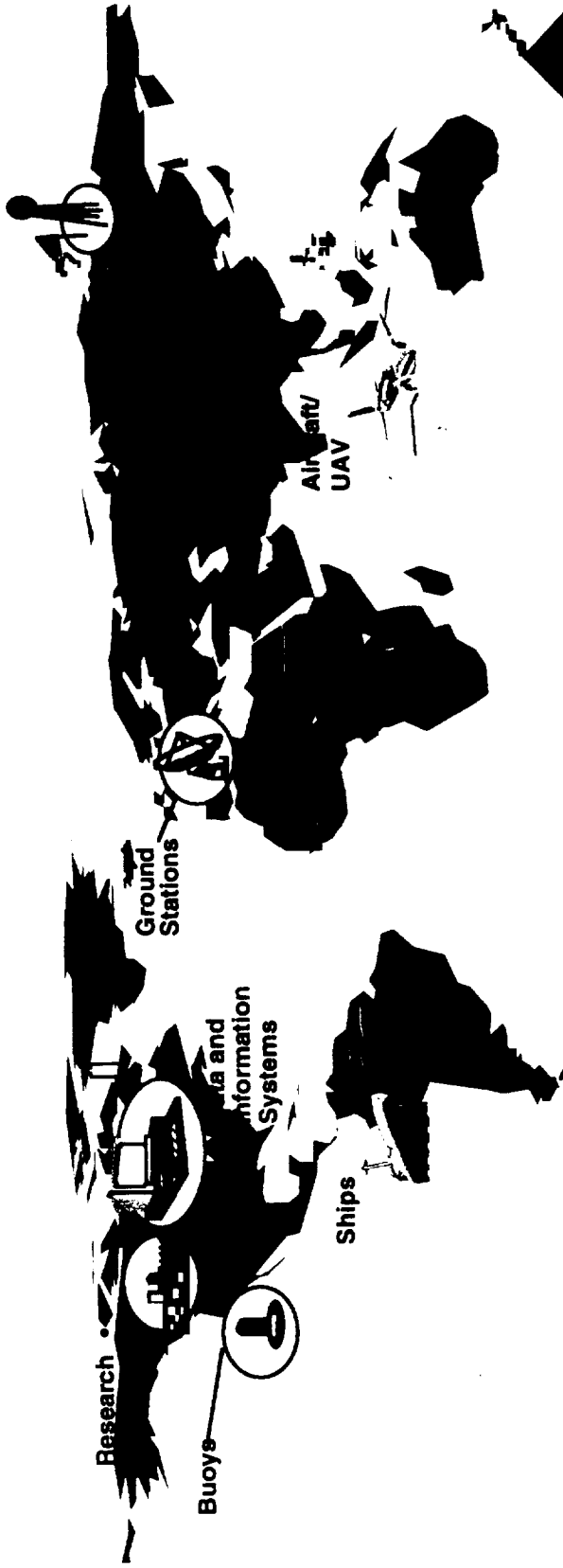



Mission to Planet Earth

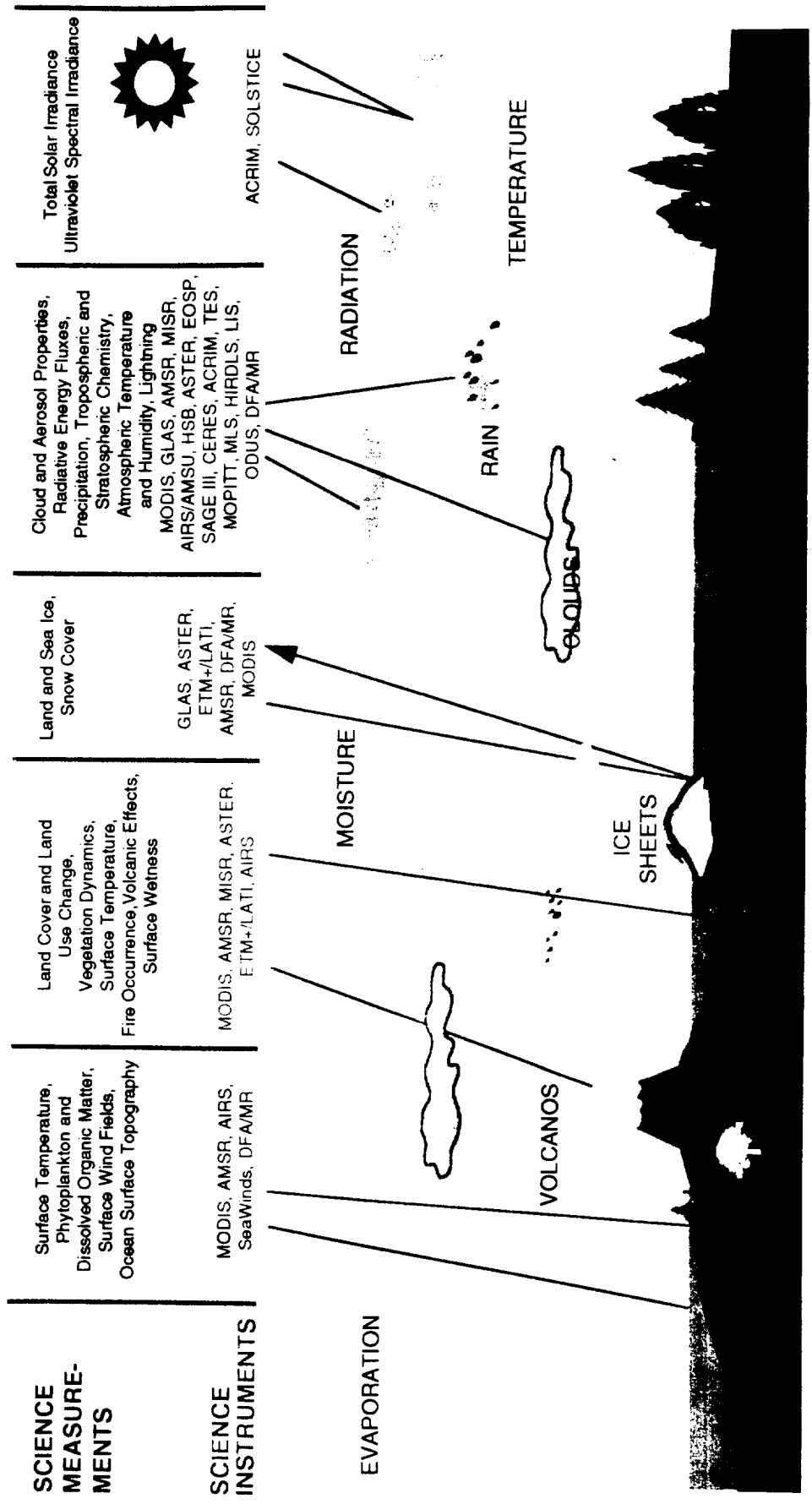

Seasonal to Interannual Climate Prediction

Decadal to Centennial Climate Variability

Atmospheric Chemistry

Terrestrial and Oceanic Ecosystems

Natural Hazards



Mission to Planet Earth

Original EOS Flight Implementation Model:

- Identify 24 measurements to be made over 15-year period.
- One-time solicitation of instruments to provide required measurements.
- Bulk of measurements to be provided by repeat flights of primary missions (AM series, PM series, Chem series).





Mission to Planet Earth

MTPE Biennial Review

- Conduct periodic reassessments of MTPE Program strategic direction in response to:
 - Improved scientific understanding
 - Evolving technology
 - New partnering opportunities in the commercial, international, and interagency arenas
 - Budget constraints





New Ways of Doing Business

- Move away from a strategy of replicating instruments over 15 years to one of regularly revisiting the science requirements
- Establish outreach process to increase partnering with commercial, interagency and international organizations
- Issue a series of solicitations addressing specific science requirements
- Move toward a larger number of smaller, more focussed missions which are PI-driven
- Implement new programs to infuse the latest technology and introduce new science





Mission to Planet Earth

- **New Millennium Program (NMP):
Technology Demonstration Missions**
 - Innovative activity to develop next generation technology
 - Lightweight, low-cost, improved performance
 - 1st mission to be Advanced Land Imager in 1998
 - 2nd mission to be selected fall 1997
- **Earth System Science Pathfinder (ESSP):
New Science Missions**
 - Small, low-cost, rapid development missions
 - Managed by Principal Investigator (PI) with limited government oversight
 - First two missions selected in spring 1997





Mission to Planet Earth

ESSP Objectives

- Provide periodic opportunity to accommodate new scientific priorities and infuse new scientific participation into the MTPE Program
- More effectively support university-based research by conducting missions on a time scale consistent with undergraduate and graduate student education





Mission to Planet Earth

ESSP Program Highlights

- Announcement of Opportunity (AO) peer reviewed science investigations
- Series of small, quick turnaround, low cost missions launched on a yearly basis
- PI responsible for science integrity and assembling team for complete mission implementation (PI-Mode)
 - PI accountable for mission success
 - University/industry/government/FFRDC and international teaming encouraged





Mission to Planet Earth

ESSP Program Status:

- Two primary and one alternate mission selected
March 1997
- Second ESSP AO expected to be released
spring 1998





Mission to Planet Earth

ESSP Primary Missions

- Land Cover Change and Global Productivity
 - **The Vegetation Canopy Lidar Mission (VCL)**
Dr. Ralph Dubayah
U. of MD, College Park
Partners: Omitron, GSFC, CTA, Fibertek
 - **Gravity Recovery and Climate Experiment (GRACE)**
Dr. Byron Tapley
U. of Texas, Austin
Partners: JPL, Space Sys/Loral, Domier Satellite Sys, DARA, DLR
- Long Term Climate Variability; Seasonal to Interannual Climate Variability





Mission to Planet Earth

Mission to Planet Earth (through 2002)

October 1, 1997 - For planning purposes only!

	JAN	FEB	MAR	APR	MAY	JUN	JUL	AUG	SEP	OCT	NOV	DEC
1992		JERS-1	ATLAS 1 (SSBUV)					TOPEX/POSEIDON		LAGEOS-2		
1993				ATLAS 2 (SSBUV)					ACTB		MeteorSat-6	
1994		GMS-6	SSBUV	SRL-1 GOES-8				DMSP-12 (SSM/I)	LITE SRL-2		ATLAS-2 (SSBUV)	NOAA-14
1995			DMSP-13 (SSM/I)	ERB-2 GOES-9 OTD							RADARSAT	
1996	SSBUV, SLA						TOMS EP	ADEOS (TOMS/NSCAT)				
1997				GOES-K DMSP-14 (SSM/I)		MAPS/MIR		BTB-95 LEWIS SEASAT-B			TRIMM STS-87 (SOLAR WIND)	
1998		NOAA-K	CLARK		SunSat	EOS-AM1	LANDSAT-7	METEOR-3M (SAGE-III)		DMSP-16 (SSM/I) Solarm-2		SIA-3 CAPL-3
1999		GOES-L			EO-1 SAC-C	ENVISAT 1	CHAMP	ADEOS-II (SeaWiFS)	SRTM	ACRIM		NOAA-L
2000		ESSP-1 (VCL) GOES-M			JASON-1		DMSP-16 (SSM/I)	METEOR 3M (TOMS)				EOS-PM1
2001				NOAA-M		EO-2	ALOS ESSP-2 JAM			METOP 1	RADARSAT-2	SCIBAT (TR)
2002	ISS SAGE-III		ESSP-3 (TR)	GOES-N CIMEX				ADEOS III (SeaWiFS II)				EOS-CHEM SAFE (SOLAR)

SHUTTLE
 ELV R&D
 ELV OPERATIONAL
 R&D OPERATIONAL
 FOREIGN MISSION R&D
 FOREIGN OPERATIONAL





Mission to Planet Earth

<http://www.hq.nasa.gov/office/mtpe/>



Office of Space Science (OSS)

*Mr. Paul Hunter
NASA Goddard Space Flight Center*

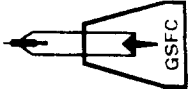

1997 MU-SPIN Conference
October 8-10, 1997

A horizontal banner with a dark, textured background. On the left, there is a circular graphic containing the word "Space" in a serif font. To the right of this graphic, the words "Science Update" are written in a large, elegant, white serif font.

Space Science Update

Paul Hunter
Office of Space Science Programs
Goddard Space Flight Center

Overview

- Synopsis of NASA's Space Science Enterprise
- Space Science Themes and Recent Highlights
- Research Opportunities
- Education and Outreach
- Further Information

Space Science Themes

MOLECULAR CLOUDS

STARS

GALAXIES

INTERSTELLAR GAS

BLACK HOLES

NEUTRON STARS

RADIO

INFRARED

VISIBLE

ULTRA-VIOLET

X-RAY

GAMMA-RAY

SOLAR SYSTEM

EARTH

Structure & Evolution of the Universe

GENERAL ASTRONOMY

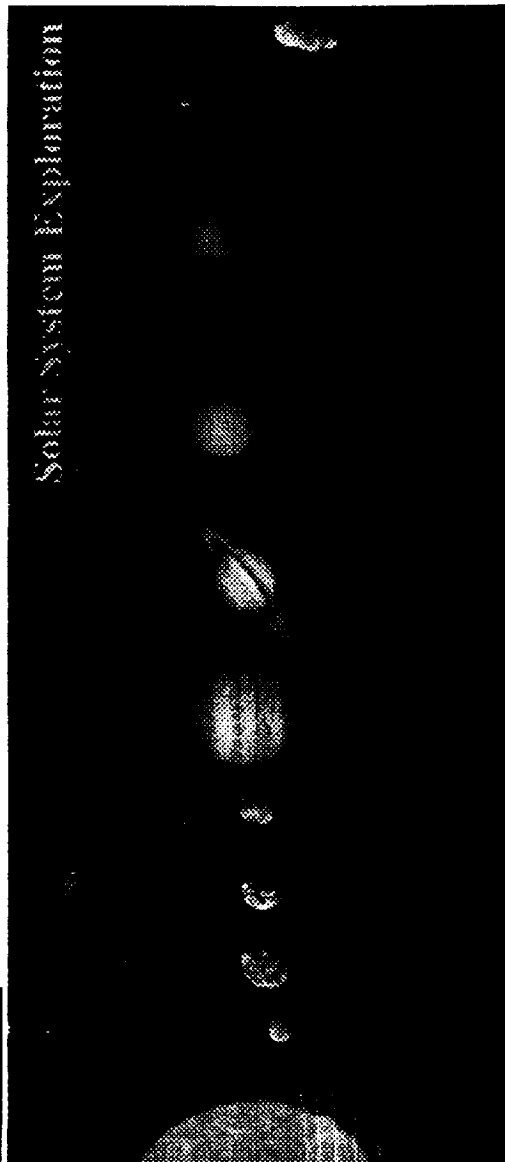
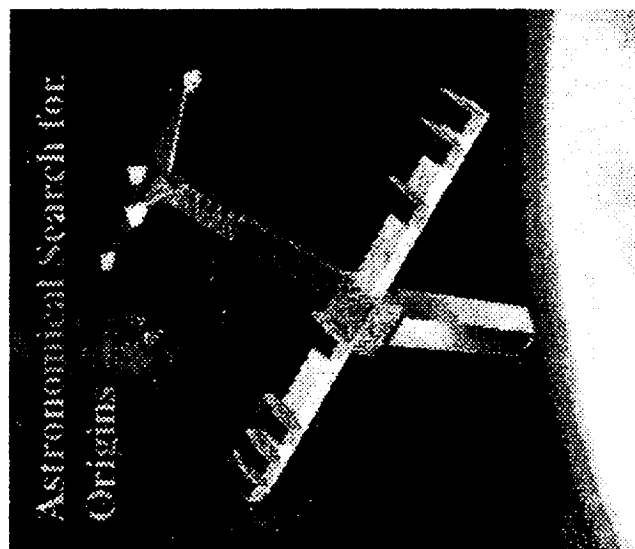
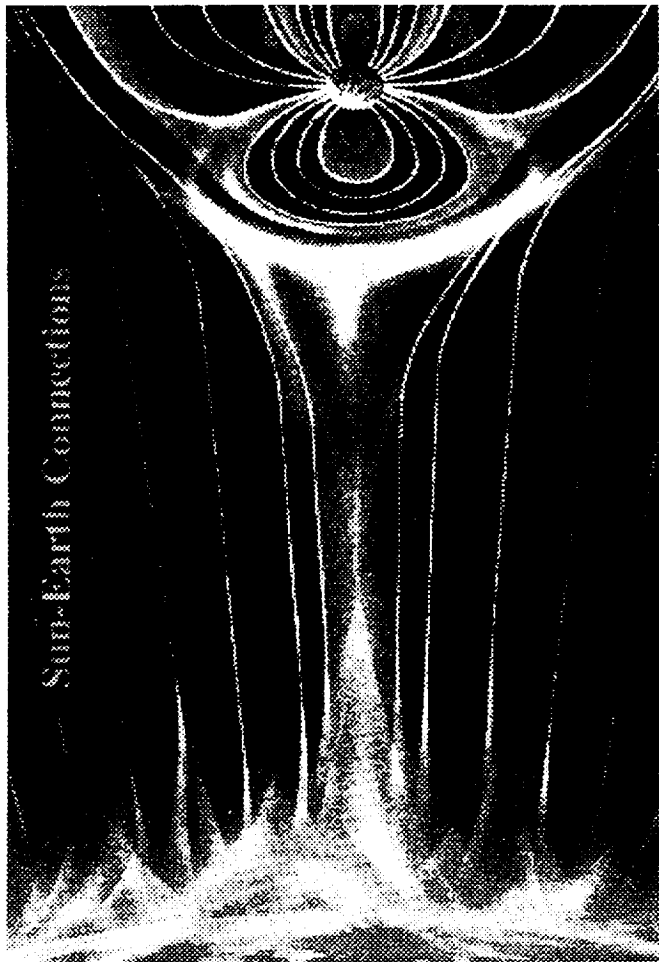

NASA's Space Science Enterprise (OSS)

- Seeking to:
 - Discover the mysteries of the Universe,
 - Explore the solar system,
 - Find planets around other stars, and
 - Search for life beyond Earth
- Budget: \$1.86B FY'97 appropriation, \$2.04 FY'98 request
- Approximately 14% of the overall NASA budget
- Latest OSS Strategic Plan* presents vision for next 20 Years

* A *URL* is included for underlined items

NASA Centers' Roles & Missions

Primary Centers:

Science Theme Lead

Primary Science Role

Primary Mission Role

GSFC	
Structure & Evolution of the Universe Sun-Earth Connections	
Astrophysics Space Physics	
Earth Orbiting Missions	

JPL	
Exploration of the Solar System Astron. Search for Origins & Planetary Systems	
Planetary Science & Exploration	
Deep Space Missions	

Supporting Centers:

Integrating Role/Theme

Supporting Science Role

No Flight Mission Role

MSFC	
Specific areas of Astrophysics & Space Physics supporting GSFC	

ARC	
Origin & Distribution of Life in the Universe	
Astrobiology Astrochemistry	

JSC	
HEDS-Space Science Integration	
Astromaterials & Human Exploration	

Sun-Earth Connections (SEC)



Quest 1: How and why does the Sun vary?

Quest 2: How do the Earth and the planets respond?

Quest 3: What are the implications for humanity?

Recent SEC Highlights

ISTP Sun-Earth Connections Event: January 6-11, 1997

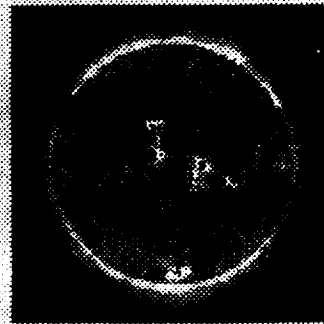

SOHO:
Initial Event Detection
Jan 6

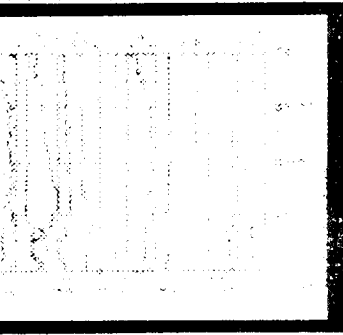

WIND and SOHO:
In-situ Event Observation
Jan 10-11

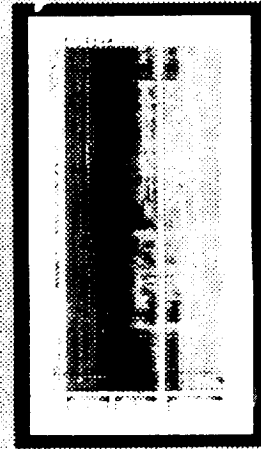

POLAR, GEOTAIL
and Ground-Based:
Magnetospheric and
Ground Response
Jan 10-11



Structure and Evolution of the Universe

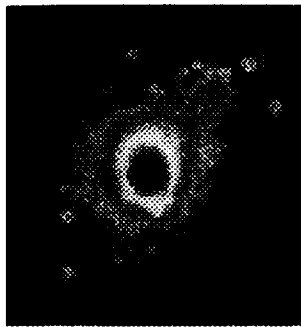

What is the nature of dark matter?

SEU Quests

Structure in the Universe and our Cosmic Destiny

Cycles of Matter and Energy in the Evolving Universe



How does strong gravity operate near black holes and in the Universe of the past?

Ultimate Limits of Gravity and Energy in the Universe

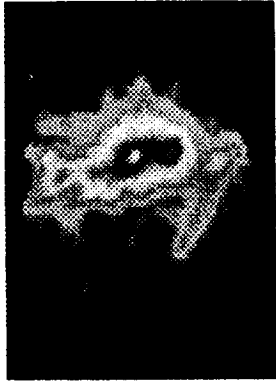

How do stars make chemical elements and distribute them through the galaxy?

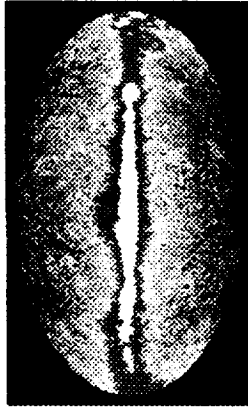

How are matter, energy, and magnetism exchanged between stars and their local environments?

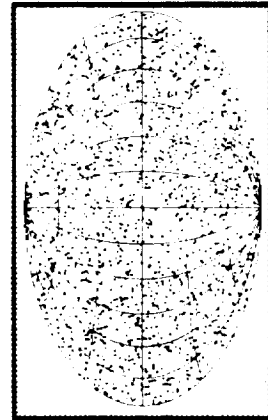

What are gamma ray bursts and how are the highest energy cosmic rays accelerated?

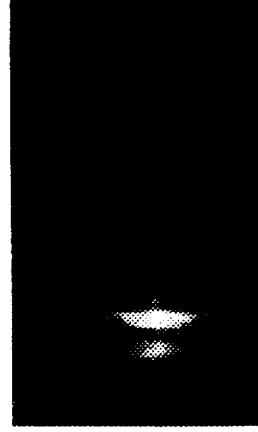

How are disks and jets formed in active galactic nuclei and X-ray binary stars?

Recent SEU Highlights

“Warped Disk” Black Hole NGC 6251

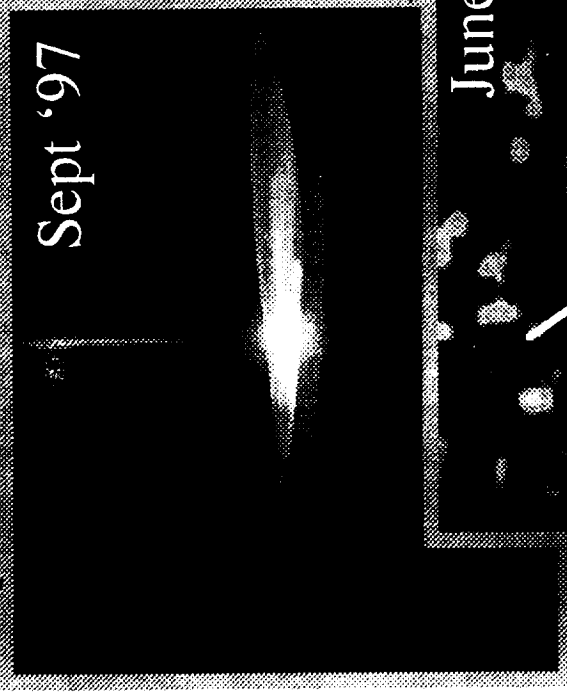

Visual Image of Neutron Star

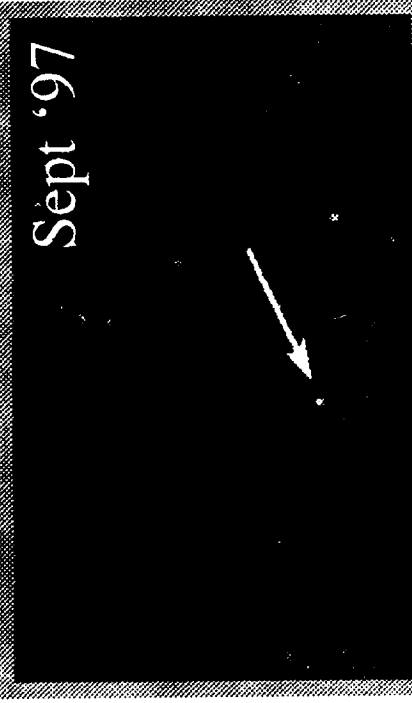

June '97

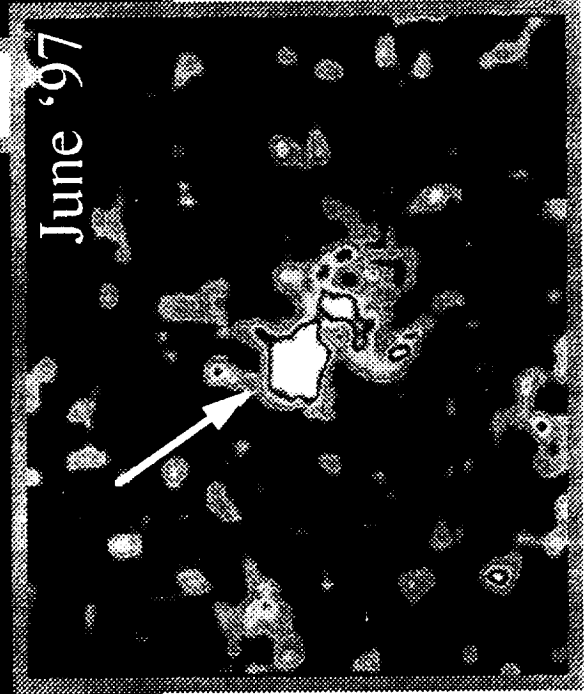

July '97

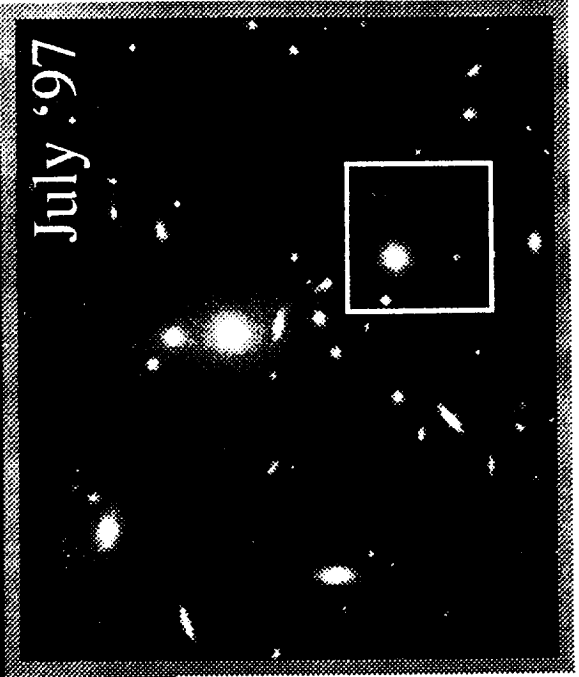

Solar System Exploration (SSE)

To seek the origin of life and its existence beyond the earth



prebiotic chemistry



liquid water: environments for life



organic inventory



evidence for past or present life

To chart our destiny in the solar system



Mars water

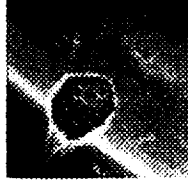

impact hazards



sites for human exploration



planetary climates



resources

To explain the formation and evolution of the solar system and the earth within it



ancient records

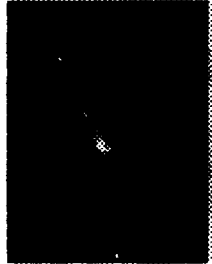

building blocks



evolution



current processes

Recent SSE Highlights

*Mars Global Surveyor
September, 1997*



*Galileo @ Europa
December, 1996*



*Sagan Memorial Station
July, 1997*



Astronomical Search for Origins (ASO)

How did galaxies form in the early universe and what role did they play in the appearance of planetary systems and life?

How do stars and planetary systems form and are there life sustaining planets around other stars?

How did life originate on Earth and did it begin (and does it still exist) elsewhere as well?

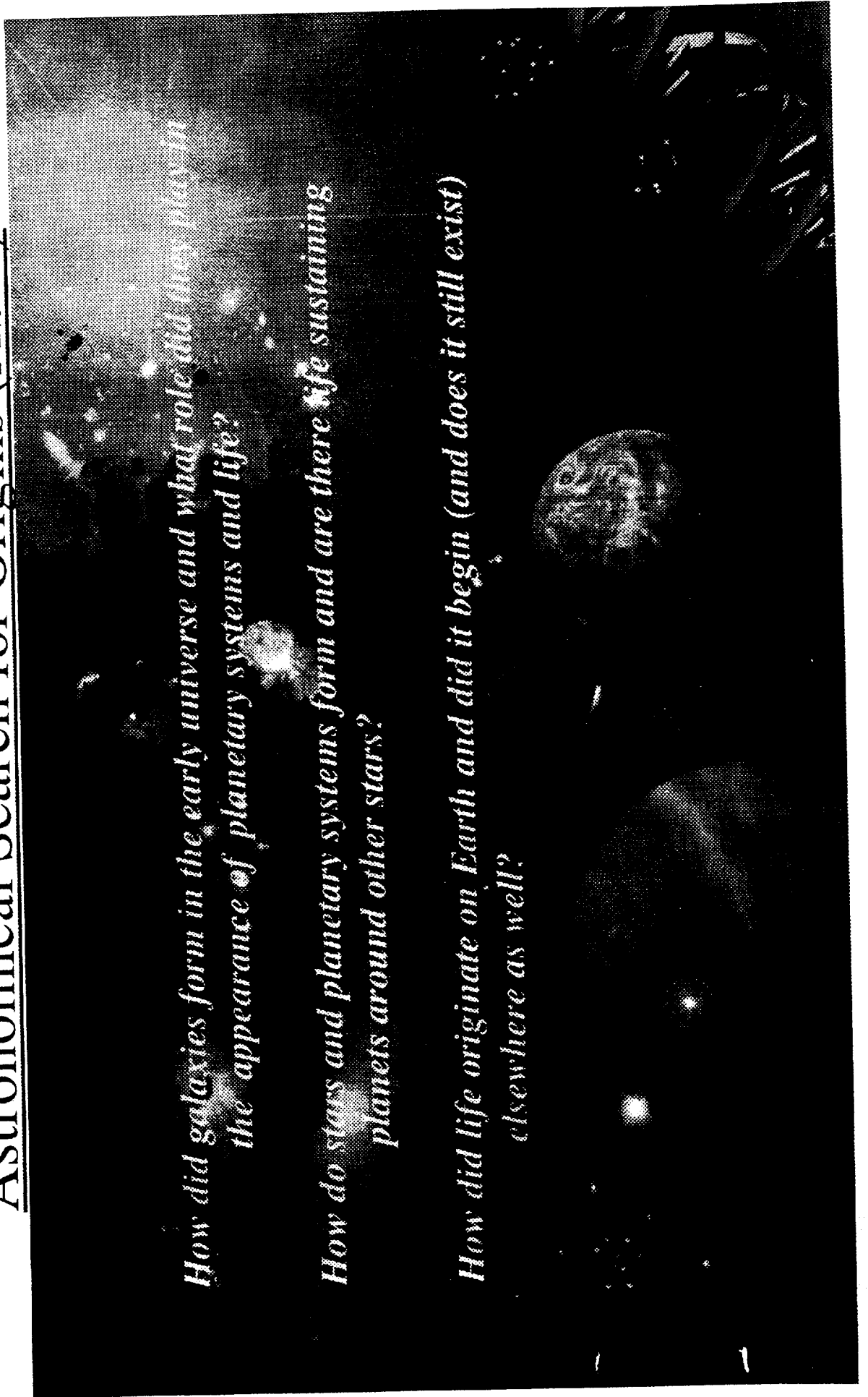

Recent ASO Highlights

PLANETS AROUND NORMAL STARS

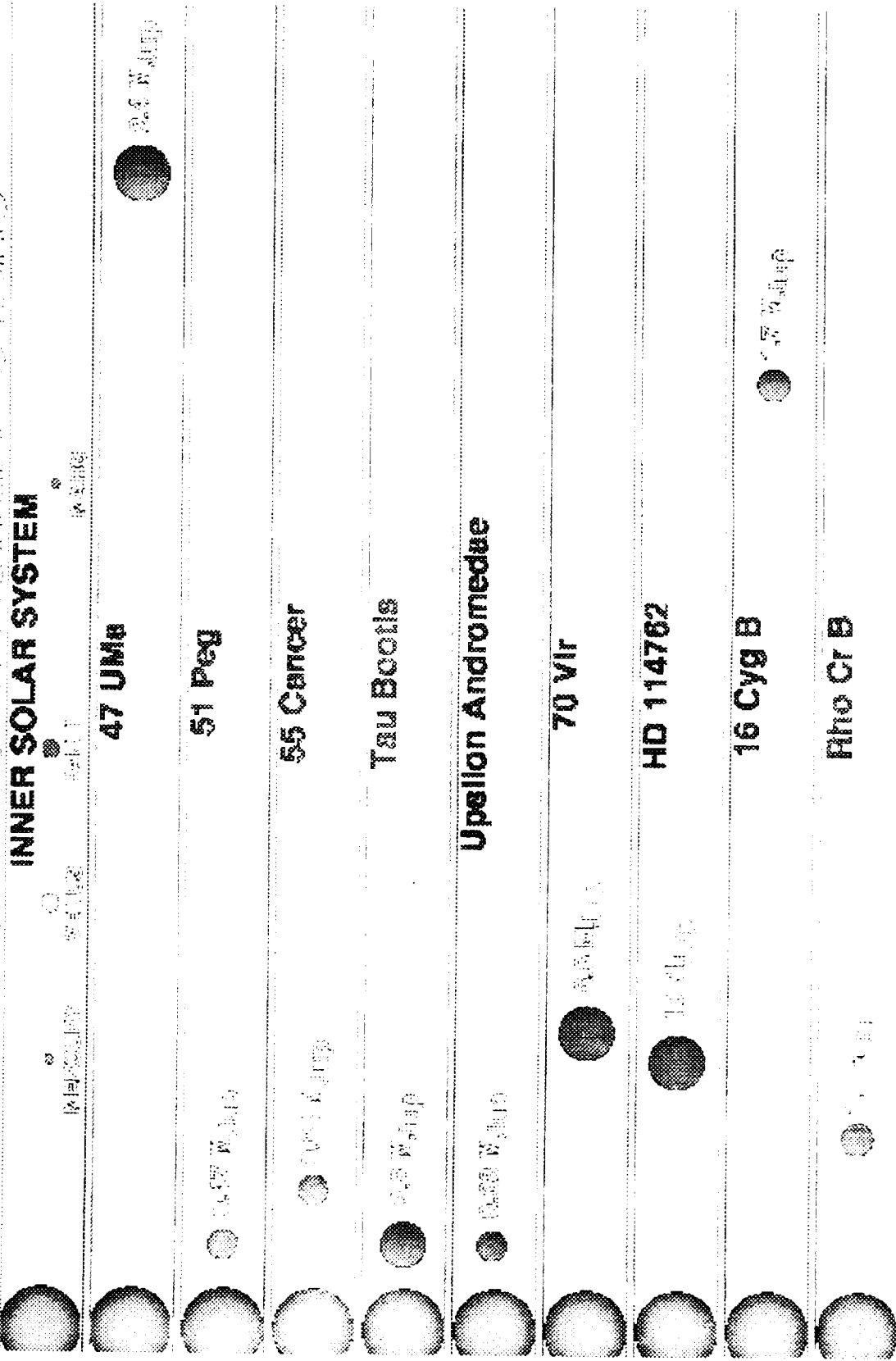

Research and Educational Opportunities

- Flight Programs
 - Competitively Selected Missions: Explorer, Discovery, Mars, ...
 - Observatories: HST, AXAF, SOFIA, ...
 - Sounding Rocket & Balloon Research Programs
- Research & Analysis
 - Space Science NRAs
 - Information Science NRAs
 - Unsolicited Proposals
- Education & Outreach
 - OSS Education Implementation Plan
 - IDEAS Program
 - Faculty & Student Programs

Open Research Opportunities

- STScI Announcement: "Initiative to Develop Education through Astronomy and Space Science (IDEAS) Research Grants"
 - Released: July 1997
 - Proposal Due Date: October 15, 1997
- NRA 97-OSS-13: "Detector Definition and Instrument Assessment for an Advanced Cosmic-ray Composition Experiment on the Space Station (ACCESS)"
 - Released: June 27, 1997
 - Proposal Due Date: September 29, 1997
- DRAFT AO: "Draft Announcement of Opportunity for the University-Class Explorer (UNEX) Program"
 - Released for Comment: August 29, 1997
 - Comments Due Date: September 19, 1997
- DRAFT CAN: "Draft Cooperative Agreement Notice for NASA's Astrobiology Institute"
 - Released for Comment: August 8, 1997
 - Comments Due: August 29, 1997

Planned Research Opportunities

- AO 97-OSS-XX: "Clementine 2 Science Team", Scheduled Release: September 1997
- AO 97-OSS-XX: "New Millennium Mars Microprobe Science Team", Scheduled Release: September 1997
- NRA 97-OSS-XX: "Astrophysics Data Program", Scheduled Release: September 1997
- CAN TBD: "NASA Astrobiology Institute", Scheduled Release: September 1997
- NRA 97-OSS-XX: "Solar Influences on Global Change Research and Analysis Program", Scheduled Release: October 1997
- NRA 97-OSS-XX: "Advanced X-Ray Astrophysics Facility Guest Observer Program Cycle 1", Scheduled Release: October 1997
- AO 97-OSS-XX: "Solar B Program", Scheduled Release: October 1997
- AO TBD: "Draft MIDEX", Scheduled Release: October 1997
- AO 97-OSS-XX: "University Explorers (UNEX)", Scheduled Release: November 1997
- NRA 97-OSS-XX: "Long-Term Space Astrophysics Program", Scheduled Release: December 1997

Explorers of Tomorrow

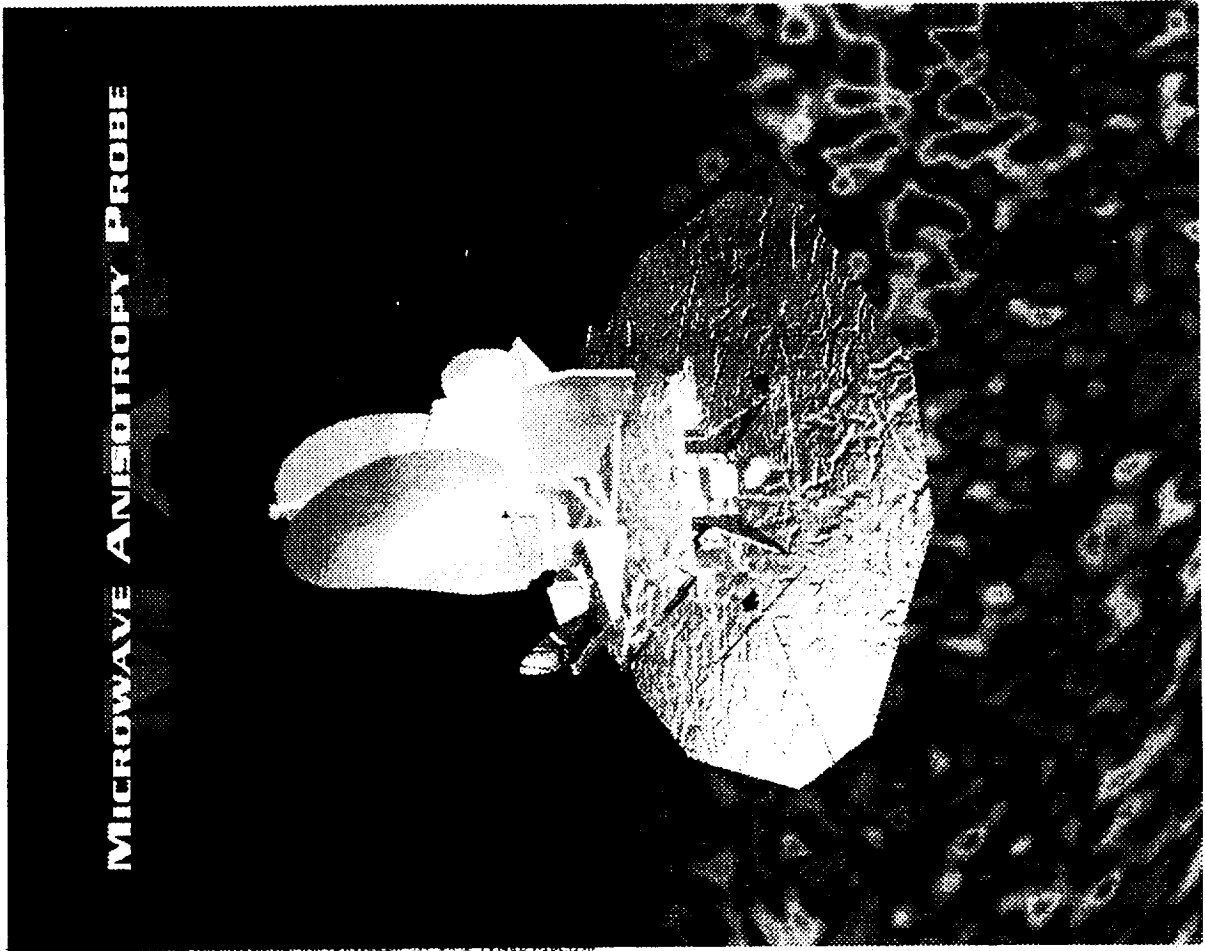
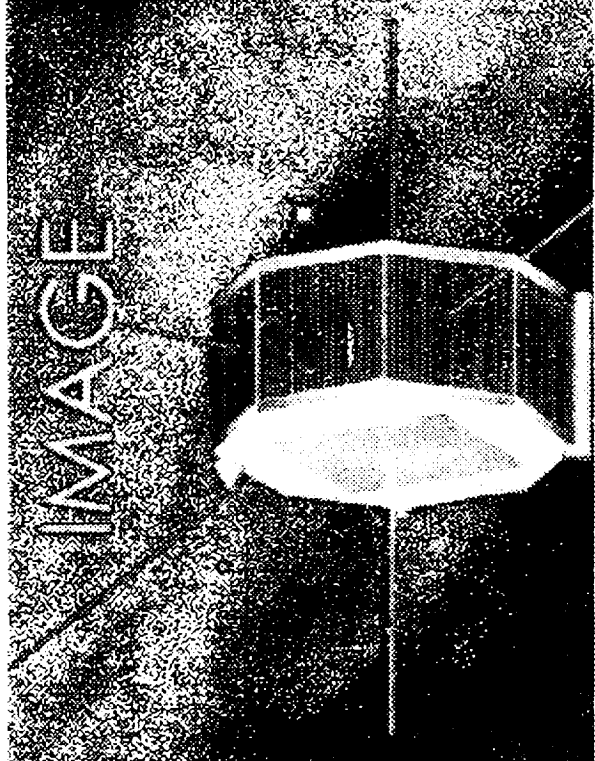

Explorers Program

- Peer reviewed and selected missions supporting all four OSS Science Themes
- Four Mission Classes
 - University-Class (UNEX) < \$13 M, 1 Launch/ year (initially, >1 Launch/year longer term)
 - Small Explorers (SMEX) < \$69M, 1 Launch/year
 - Medium Explorers (MIDEX) < \$138M, 1 Launch/year
 - Missions of Opportunity < \$20M, NASA Contribution to non-NASA space science mission
- Inclusion of HBCUs and OMUs is especially emphasized for UNEX missions with additional funding from Code E possible
- UNEX AO & Preproposal conference in Oct-Nov '97
- One way to learn the process is to volunteer to be a Peer Reviewer
- If interested, contact either Mark Saunders or Cindy Daniels @ NASA LaRC, 757-864-9850

Great Observatories

Next Generation Observatories

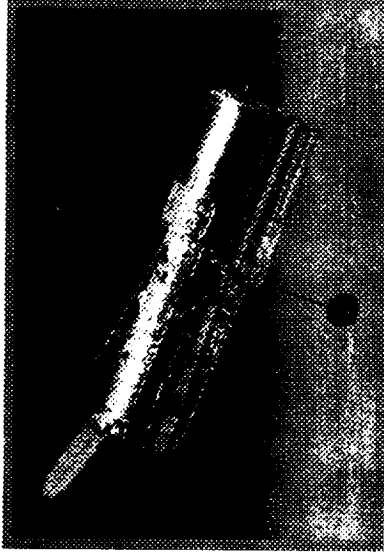

**Hubble
Space
Telescope**

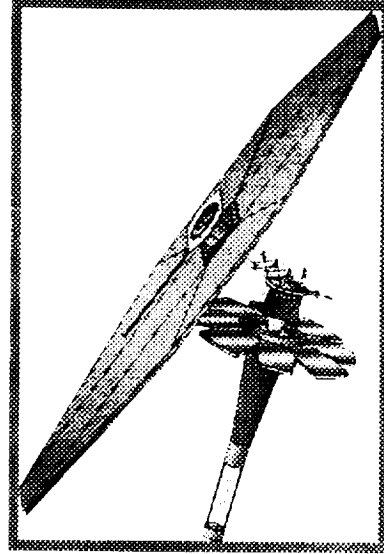

**Next
Generation
Space
Telescope**



**Compton
Gamma Ray
Observatory**

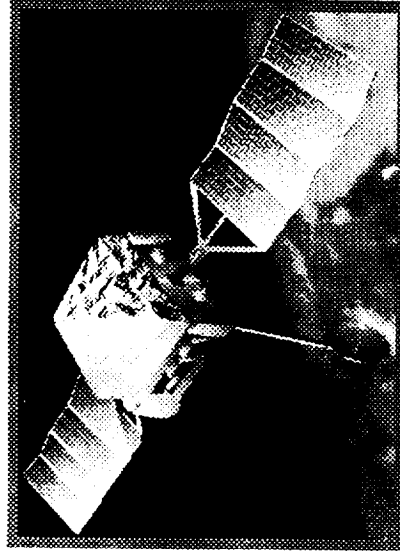

**Gamma-Ray
Large Area
Space
Telescope**

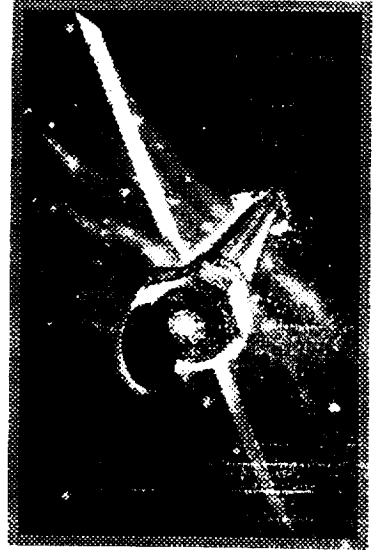

**Advanced
X-ray
Applications
Facility**

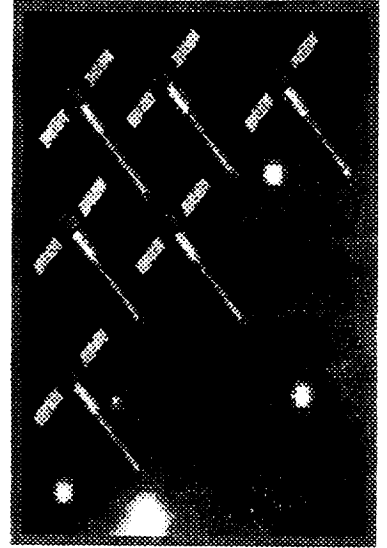

**High
Throughput
X-ray
Spectroscopy**

Observatory Programs

- Hubble Space Telescope (HST)
 - Observing and data-archive based research opportunities competed annually
 - Unfunded archive research over WWW. Extensive on-line Help facilities
 - Summer Student Program --> Deadline: February 28, 1997 (for Summer of 1997)
 - Graduate Student program --> Deadline: January 15, 1997 (for FY97 Program)
 - Hubble Postdoctoral Fellowship program: Deadline is November 17, 1997.
 - STScI Postdoctoral Fellowship program: Deadline December ??, 1997
 - Research Associate Opportunities --> See AAS Jobs Register Website
- Advanced X-Ray Applications Facility (AXAF)
 - FY 1998 Launch
 - AXAF Postdoctoral Fellowship deadline: November 14, 1997 (begin in Sept. 98)
 - Other opportunities as launch approaches
- Stratospheric Observatory For Infrared Radiation (SOFIA)
 - 2001 First flight
 - Watch for opportunities

Time lapse photograph of sounding rocket launch in an aurora above the Poker Flat Research Range in Alaska.

Auroral Research at Poker Flats

Balloon & Sounding Rocket Research

- Opportunities for sounding rocket and balloon flights are contained in annual science discipline NRAs
- Balloons: 2700 kg payloads up to 40 km for 1 to 23 days
 - Success rate: 93% flights, 84% science
- Sounding rockets: 1500 kg up to 1500 km for 5 to 20 minutes
 - Success rate: 97% flights, 89% science
- Student launch program
 - Support undergraduate student experiments to design, build, & fly simple experiments on surplus balloons and rockets from Wallops
 - Cosponsored by Space Science, Equal Opportunity, and Education programs in NASA.
 - Recently selected 6 projects for 1999-2000 Flights
 - Next solicitation in FY'99 or FY'00

Research & Analysis

- Science NASA Research Announcements (NRAs)
 - Most research areas issue annual calls for proposals
 - 16 NRAs & 4 observing time solicitations issued in FY97
 - Covers broad range of Space Science research topics
- Information Science/Technology Research
 - Focused on data management and analysis
 - Next NRA of Advanced Information Science Research Program will be around March, 1998
- Unsolicited Proposals
 - “NASA encourages the submission of unique and innovative unsolicited proposals which will further the Agency’s mission.”
 - Policy and guidance easily obtainable from WWW

OSS Education and Outreach Plan

- In FY 97, OSS began implementing the plan described in “Implementing the Office of Space Education/Public Outreach Strategy.”
- Integral to the plan is an “Ecosystem” or network of interconnected activities focused on high leverage, wide impact activities.
- Two key elements of the Ecosystem are Nationally focused “Education Forums” (one per OSS Science theme) and regional “Broker/Facilitators” to build connections in the network.
- The largest share of the funding for Education or Outreach activities will remain at the Scientist or Project level.

Education & Outreach

- Implementing the OSS Strategic Plan for Education
 - Contact the Broker/Facilitator for your region
 - Contact the OSS Education Forum closest to your research interests
 - Keeping watching the OSS Education Page for opportunities
- Initiative to Develop Education through Astronomy and Space Science (IDEAS)
 - Administered for NASA by Space Telescope Science Institute
 - Now supports all OSS themes (expanded scope AND budget)
 - Deadline 5:00 PM on October 15, 1997. Issued yearly.
- Faculty Programs
 - ASEE summer faculty fellowship. Deadline is January 15, 1998
 - Post Doctoral Fellowships.
- Graduate Student Researchers Program
 - Yearly opportunities. Information online in December.
 - New Application Deadline: Around Mid February, 1998

OSS Education Forums

- Space Telescope Science Institute (STScI):
Astronomical Search for Origins and Planetary Systems
- Smithsonian Astrophysical Observatory (SAO):
Structure and Evolution of the Universe
- Jet Propulsion Laboratory (JPL):
Solar System Exploration
- NASA Goddard Space Flight Center (GSFC) and UC Berkeley:
The Sun-Earth Connection

All four forums will have Websites shortly.

OSS Broker/Facilitators

On September 15, 1997, the following groups were selected as the OSS regional Education and Outreach Brokers/Facilitators:

- David Black/Lunar and Planetary Institute, Houston, TX -- "A Broker/Facilitator Team for Space Sciences Education and Outreach in the South Central Region"
- Mitchell Colgan/South Carolina Space Grant Consortium, Charleston, SC - "Southeastern OSS Space Grant Regional Education Coalition: Keys to Implementing NASA's Office of Space Science Education and Outreach Broker/Facilitator Program"
- Larry Cooper/Ohio Aerospace Institute, Cleveland, OH -- "OSS Education and Outreach Broker/Facilitator for Michigan, Illinois, Indiana, Ohio, Pennsylvania, and West Virginia"
- Cherylann Morrow/Space Science Institute, Boulder, CO -- "Outreach to Space Scientists: Facilitating Researcher Action in Major Educational Settings"
- Carolyn Narasimhan/Depaul University, Chicago, IL -- "The Depaul Space Science Education and Outreach Center"

Summary

- NASA's Space Science Enterprise is on a bold, exciting course to the future.
- There are a lot of ways to participate.
- Enormous amounts of information are quickly accessible via the World Wide Web.
- Plan for the long term & don't give up.

URLs for Further Information (<http://...>)

- [OSS Homepage](http://www.hq.nasa.gov/office/oss/osshome.htm) www.hq.nasa.gov/office/oss/osshome.htm
- [Open Announcements](http://www.hq.nasa.gov/office/oss/research.htm) www.hq.nasa.gov/office/oss/research.htm
- [Future Announcements](http://www.hq.nasa.gov/office/oss/research/future.htm) www.hq.nasa.gov/office/oss/research/future.htm
- [OSS Education Homepage](http://www.hq.nasa.gov/office/oss/education/index.htm) www.hq.nasa.gov/office/oss/education/index.htm
- [IDEAS Program](http://www.stsci.edu/pubinfo/edugroup/ideas-1997-rfp.html) www.stsci.edu/pubinfo/edugroup/ideas-1997-rfp.html
- [SEC Roadmap](http://espsun.space.swri.edu/~roadmap/index.html) espsun.space.swri.edu/~roadmap/index.html
- [ASO Roadmap](http://origins.jpl.nasa.gov) origins.jpl.nasa.gov
- [SEU Roadmap](http://www.srl.caltech.edu/seus/roadmap/) www.srl.caltech.edu/seus/roadmap/
- [SSE Roadmap](http://cis.jpl.nasa.gov/roadmap/site/forkintheroadmap.shtml) cis.jpl.nasa.gov/roadmap/site/forkintheroadmap.shtml
- [Explorer Program](http://www710.gsfc.nasa.gov/Projects/EXPLORER/index.html) www710.gsfc.nasa.gov/Projects/EXPLORER/index.html
- [Discovery Program](http://discovery.larc.nasa.gov/discovery/home.html) discovery.larc.nasa.gov/discovery/home.html
- [Hubble Space Telescope \(HST\)](http://marvel.stsci.edu/top.html) marvel.stsci.edu/top.html
- [Advanced XRay Applications Facility \(AXAF\)](http://asc.harvard.edu/AdvancedXRayApplicationsFacility(AXAF)) [asc.harvard.edu/](http://asc.harvard.edu/AdvancedXRayApplicationsFacility(AXAF))
- [Stratospheric Observatory For Infra-red Astronomy \(SOFIA\)](http://sofia.arc.nasa.gov/StratosphericObservatoryForInfra-redAstronomy(SOFIA)) [sofia.arc.nasa.gov/](http://sofia.arc.nasa.gov/StratosphericObservatoryForInfra-redAstronomy(SOFIA))
- [OSS Information Science](http://www.hq.nasa.gov/office/oss/sthome.htm) www.hq.nasa.gov/office/oss/sthome.htm
- [Proposal guidance](http://procure.msfc.nasa.gov/nasa_ref.html) procure.msfc.nasa.gov/nasa_ref.html
- [OSS Strategic Plan](http://www.hq.nasa.gov/office/oss/strategy/plan.htm) www.hq.nasa.gov/office/oss/strategy/plan.htm
- [Faculty programs](http://spacelink.nasa.gov/Educational.Services/Higher.Education/) spacelink.nasa.gov/Educational.Services/Higher.Education/
- [Graduate Student Research Program](http://ednet.gsfc.nasa.gov/gsrp/) ednet.gsfc.nasa.gov/gsrp/
- [American Astronomical Society Jobs Register](http://www.aas.org) www.aas.org



National Science Foundation

Dr. David Staudt
National Science Foundation

MU-SPIN Seventh Annual Conference

David A. Staudt
National Science Foundation
Internet Program

dstaudt@nsf.gov
703 306 1949

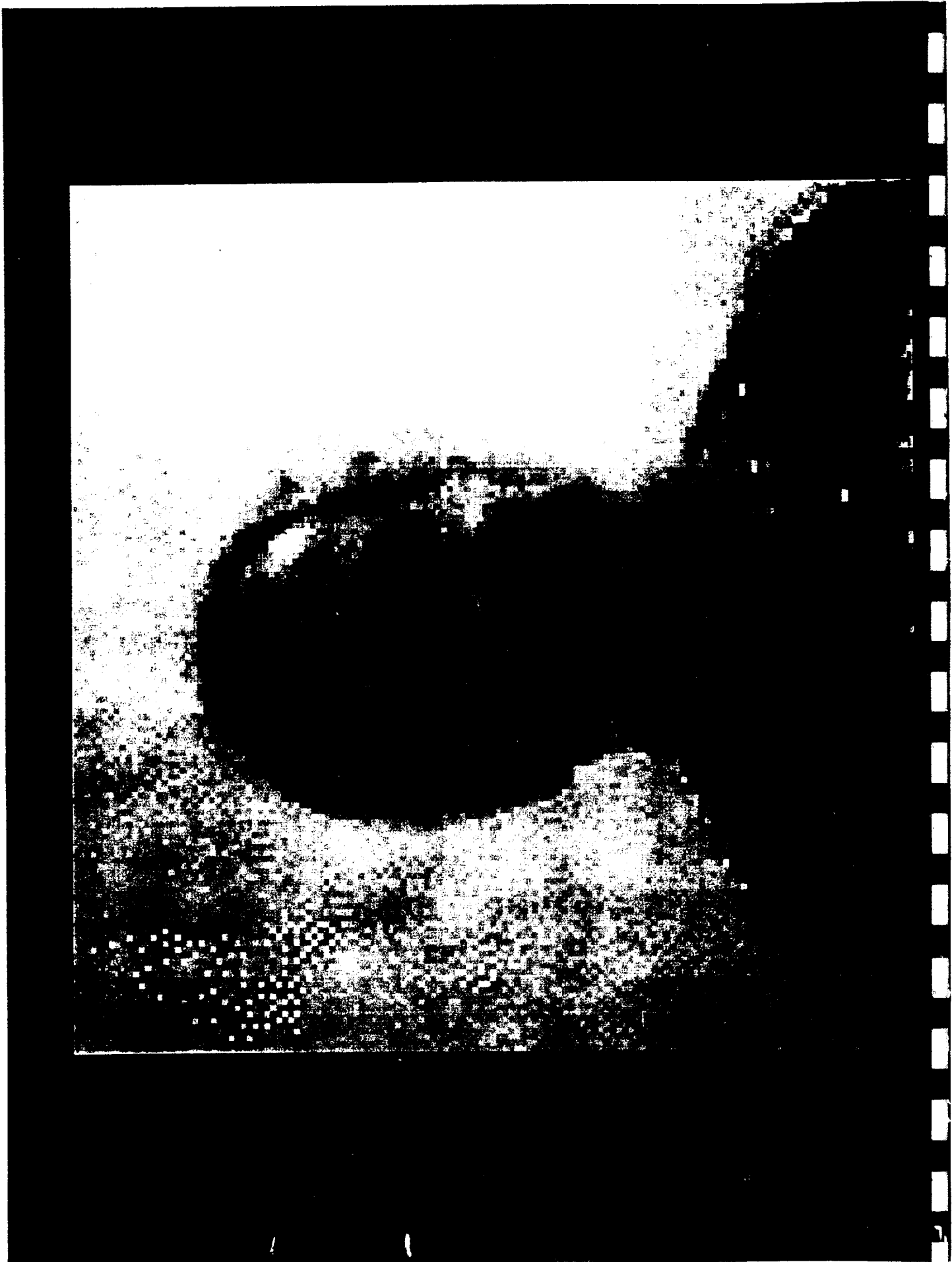

NSF Programs

Internet Connections

Underrepresented Populations Activities

Proposal Submission

College connections program

Up to \$20K per institution

Over 2600 institutions connected to date

- ◆ Most HBCUs
- ◆ Many minority-serving institutions
- ◆ New connections, not upgrades

Deadlines January 31 and July 31

Innovative Technologies

Up to \$15K per institution

“New” ways to connect to the Internet

Wireless, MMDS, ITFS, ---->

Not an infrastructure program

High Performance Connections

Research institutions with “meritorious applications”

\$350K per institution

Internet 2 (University Corporation for Advanced Internet Development)

Consortium proposals

Underrepresented Populations Activities

Women

Persons with disabilities

Minorities

**Targeted to students, faculty and
institutions**

Student Development Programs

Comprehensive Partnerships for Mathematics and Science Achievement (CPMSA)
Alliances for Minority Participation (AMP)
Research Assistantships for Minority High School Students

Student Development Programs (cont)

**Research Experiences for Undergraduates
(REU)**

**Minority Postdoctoral Research Fellowships
and Graduate Student Travel Awards in the
Biological, Social, Behavioral and Economic
Sciences**

**Doctoral Dissertation Research Improvement
NSF Postdoctoral Fellowships**

Faculty Programs

Minority Research Planning Grants (MRPG)

Minority Career Advancement Awards (MCAA)

Research Opportunity Awards (ROA)

Undergraduate Faculty Enhancement Program
(UFE)

Faculty Programs (cont)

Research in Undergraduate Institutions (RUI)
Collaborative Research at Undergraduate
Institutions (C-RUI)
Small Grants for Exploratory Research (SGIR)
Presidential Faculty Fellowships (PFF)

Institutional Programs

Alliances for Minority Participation (AMP)

Minority Research Improvement (MRI)

Instrumentation and Laboratory Improvement

Undergraduate Course and Curriculum

Development

Advanced Technological Education

NSF Collaboratives for Excellence in Teacher Preparation

Proposal submission

Moving to electronic proposals
Meeting with HBCU representatives

More Information

[http://www.nsf.gov/od/pa/news/publicat/nsf95138/
chap9.htm](http://www.nsf.gov/od/pa/news/publicat/nsf95138/chap9.htm)

Senior Staff Assoc for Cross-Directorate Programs
703 306 1603

Minority University Research & Education Division

Mr. John Malone

National Aeronautics and Space Administration



**OFFICE OF EQUAL OPPORTUNITY PROGRAMS
MINORITY UNIVERSITY RESEARCH AND EDUCATION PROGRAMS**



**MU-SPIN
ANNUAL USERS CONFERENCE**

**October 9, 1997
City College of New York**

**John E. Malone
University Programs Specialist
Minority University Research and Education Division**



**OFFICE OF EQUAL OPPORTUNITY PROGRAMS
MINORITY UNIVERSITY RESEARCH AND EDUCATION PROGRAMS**



Significance for NASA

- **NASA needs minority involvement:**
 - By 2030, “minorities” will comprise 50% of the U.S. elementary school-aged population.
- **Minority Institutions (MIs) are a major source of minority graduates in Science and Engineering (S&E):**
 - Historically Black Colleges and Universities (HBCUs) are 3% of all institutions, but award nearly 30% of all S&E degrees to African Americans in the U.S.
 - Hispanic Serving Institutions (HSIs) dominate the leading U.S. institutions in awarding S&E bachelor’s degrees to Hispanics.
- **Tribal College Issues:**
 - Most Tribal Colleges are 2-year requiring bridging for MSET fields.
 - Reservation high school students not prepared for MSET coursework.



**OFFICE OF EQUAL OPPORTUNITY PROGRAMS
MINORITY UNIVERSITY RESEARCH AND EDUCATION PROGRAMS**



Strategic Direction

- **Outlook:**

- ...achieve the full participation of Minority Institutions (MI's) in NASA-sponsored research and education...

- **Mission:**

- ...synergism between NASA's mission and the Federal mandates for MI's....
- ...equal opportunity in all NASA-sponsored research and education programs...
- ...strengthen the capacity of mathematics, science, engineering, and technology (MSET) at MI's...

- **Goals:**

- ...foster research and development activities...
- ...systemic and sustainable change through partnerships and programs...
- ...prepare faculty and students for competitive research and education process...
- ...increase the number of students prepared to enter college in MSET fields...



MURED Approach

TWO PROGRAMS:

- HBCUS
- OMUS
 - Hispanic-Serving
 - Tribal Colleges
 - Other Universities
Institutions

SEVEN COMPETITIVE

OPPORTUNITIES:

- Research
 - URC
 - IRA
 - Individual PI: FAR
- Education
 - Partnership *
 - » TCU & CC **
 - Pre-college Outreach: PACE
 - Teacher Enhancement: MASTAP
 - » * Research and/or Education
 - » ** New Partnership '98



**OFFICE OF EQUAL OPPORTUNITY PROGRAMS
MINORITY UNIVERSITY RESEARCH AND EDUCATION PROGRAMS**



Expected Outcomes

- Future space program workers:
 - NASA
 - Universities
 - Industry
- Minority participation in MSET areas.
- Minority institution and minority community benefit from and support of NASA activities.



Outcome Metrics

- Mr. Goldin has suggested the following outcome metrics for Minority Institutions :
 - Student Degrees Production
 - Refereed Publications
 - Commercialization
- MURED has developed outcome metrics for research and education awards



RESEARCH OUTCOMES

- **Metrics:**
 - Refereed Publications
 - » Break out: Published vs. accepted
 - Leveraged Funding
 - » Break outs:
 - NASA (non-MUREP) vs. non-NASA
 - Total vs. equipment
 - Patents
 - » Break out: Disclosures vs. Applications vs. Awards
 - Commercial products
 - » Break out: Entered Market vs. In Development
- **Benchmarking divisors**
 - per number of investigators
 - per dollars spent on research



STUDENT OUTCOMES

- **Metrics:**
 - Degrees awarded
 - Post-Degree plans
 - » Students continuing for next degree
 - » Students obtaining jobs in NASA-related fields
- **Break outs:**
 - Bachelors vs. Masters vs. Doctoral
 - All students vs. UMD's
- **Benchmarking divisors**
 - per number of investigators
 - per dollars spent on students



Mathematics and Science Awards for Teacher and Curriculum Enhancement Program (MASTAP)

- Objective: Increase the number and strengthen the technical skills and knowledge of socially and economically disadvantaged mathematics, science, and technology teachers and pre-service teachers in middle and high schools that have substantial enrollments of socially and economically disadvantaged students.



**OFFICE OF EQUAL OPPORTUNITY PROGRAMS
MINORITY UNIVERSITY RESEARCH AND EDUCATION PROGRAMS**



Institutional Research Award (IRA)

- **Research Objectives**
 - Strengthen the capacity of Minority Institutions to provide a quality learning and research environment for underrepresented students
 - Increase opportunities to participate in and benefit NASA and other Federal Agencies research and education programs.

- **Network Resources and Training Sites (NRTS) Objectives**
 - Improve the in-house capability of Minority Institutions to electronically access science data and computational resources
 - Develop mechanisms to support, sustain and evolve the network infrastructure of Minority Institutions
 - Make Minority Institutions more effective in the competitive process for NASA and Federally funded programs in Science, Engineering, and Technology



**OFFICE OF EQUAL OPPORTUNITY PROGRAMS
MINORITY UNIVERSITY RESEARCH AND EDUCATION PROGRAMS**



University Research Centers (URC) Goals & Objectives

- Achieve a broad-based, competitive aerospace research capability among the Nation's HBCUs and OMUs which will:
 - foster new science and technology concepts;
 - expand the Nation's base for aerospace research and development;
 - develop mechanisms for increased participation by faculty and students of HBCUs and OMUs in mainstream research;
 - increase the production of students who are U.S. citizens and who have historically been underrepresented, with advanced degrees in NASA-related fields.



**OFFICE OF EQUAL OPPORTUNITY PROGRAMS
MINORITY UNIVERSITY RESEARCH AND EDUCATION PROGRAMS**

Electronic Management System (EMS)

- Paperless Peer Review Processes and Programs Management System
 - Solicitation Distribution
 - Proposal Submission
 - Proposals Review and Evaluation
 - Data Collection
 - Performance Plans/Reports
 - » HBCU
 - » HSI
 - » TCU
 - Grants Management

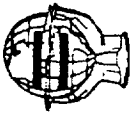

OFFICE OF EQUAL OPPORTUNITY PROGRAMS MINORITY UNIVERSITY RESEARCH AND EDUCATION DIVISION PEER REVIEW & SELECTION AND AWARD PROCESS

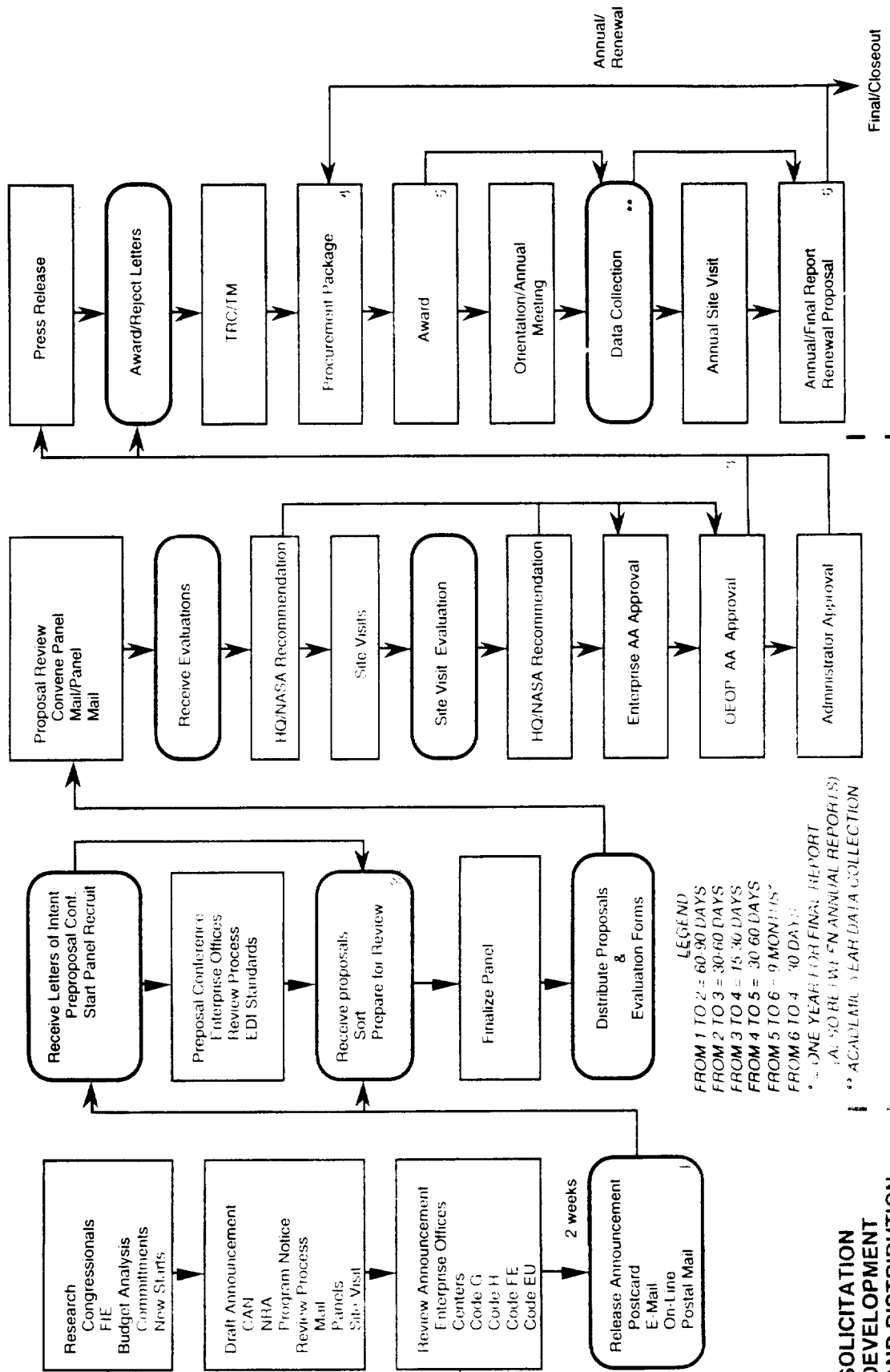

LEGEND
 FROM 1 TO 2 = 60-90 DAYS
 FROM 2 TO 3 = 30-60 DAYS
 FROM 3 TO 4 = 15-30 DAYS
 FROM 4 TO 5 = 30-60 DAYS
 FROM 5 TO 6 = 9 MONTHS
 FROM 6 TO 4 = 30 DAYS

* = ONE YEAR FOR FINAL REPORT
 ** = ACAD/MLR YEAR DATA COLLECTION

SOLICITATION AND DISTRIBUTION | **REVIEW AND SELECTION** | **POST SELECTION**



**OFFICE OF EQUAL OPPORTUNITY PROGRAMS
MINORITY UNIVERSITY RESEARCH AND EDUCATION PROGRAMS**



FEDIX

- <http://web.fie.com/fedix/>
 - “Your source of Federal Research and Education Opportunities”
 - MOLIS, RAMS-FIE
- <http://www.rams-fie.com/>
 - “Electronic solutions for the research community”
 - ERA Demonstration
- <http://web.fie.com/web/era/index.htm>
 - New ERA Demonstration Project
 - EDI (Electronic Data Interchange)
- <http://www.internet2.edu/>



**OFFICE OF EQUAL OPPORTUNITY PROGRAMS
MINORITY UNIVERSITY RESEARCH AND EDUCATION PROGRAMS**



Future Prospects

- Administrator is strongly committed to supporting MIs:
 - Maintaining MUREP budget
 - Meetings with MI Presidents
 - Attending Special Events at MI's
- Public pressure against set-aside programs is building:
 - Anti-affirmative action legislation
 - Court cases
- OEOP is committed to maintaining MUREP



**OFFICE OF EQUAL OPPORTUNITY PROGRAMS
MINORITY UNIVERSITY RESEARCH AND EDUCATION PROGRAMS**



FY 98/99 Funding Priorities

- Honor NASA commitments made through competitive review processes
- Build NASA-related institutional infrastructure at HBCUs and OMUs
- Focus on U.S. citizen faculty and students at MI's who are socially and economically disadvantaged and/or disabled



**OFFICE OF EQUAL OPPORTUNITY PROGRAMS
MINORITY UNIVERSITY RESEARCH AND EDUCATION PROGRAMS**



Summary

- NASA and the future space program requires minorities.
- Minority Institutions are a vital source of minority students entering technical fields.

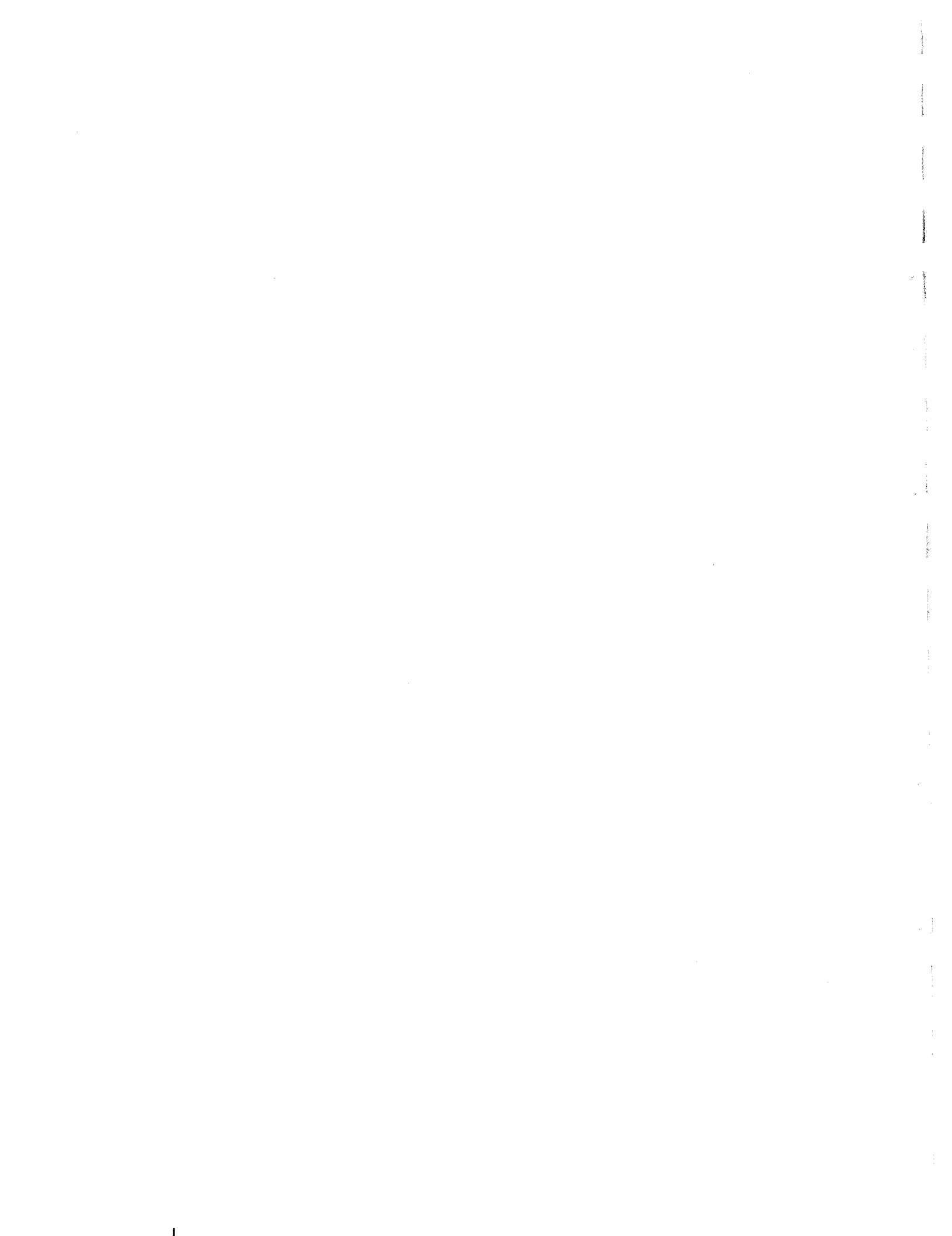

Remote Sensing/GIS Break-out Session

Dr. Ali Moddares
California State University at Los Angeles

Urban Environment Initiative

- What is UEI?
- The UEI Consortium
- The UEI Focus
- UEI Outreach, Products, and Services



The Urban Environment Initiative (UEI), has been established as part of a Cooperative Agreement with the National Aeronautics and Space Administration (NASA). The UEI is part of NASA's overall High Performance Computing and Communications (HPCC) and the Information Infrastructure Technology Applications (IITA) programs. The goal of the UEI is to provide public access to Earth Science information and promote its use with a focus on the environment of urban areas. This goal will be accomplished through collaborative efforts of the UEI team with both community-based and local/regional governmental organizations.



The UEI team is comprised of four organizations representing private industry, NASA, and universities: Prime Technologies Service Corporation, NASA's Minority University Space Interdisciplinary Network (MU-SPIN), California State University, at Los Angeles, and Central State University (Wilberforce OH).



"Urban Environment" refers to the web of environmental, economic, and social factors that combine to create the urban world in which we live. Examples of these factors are population distribution, neighborhood demographic profiles, economic resources, business activities, location and concentration of environmental hazards and various pollutants, proximity and level of urban services, which form the basis of the urban environment and ultimately affect our lives and experiences.

The environment, social concerns, and the economy must be considered as we work to address the issues and problems of our

Public Use of Remote Sensing Data
Center for Advanced Spatial Technology (CAST)
Listing of other GIS and Remote Sensing Servers



Top of Page

neighborhood and region. Effective solutions often require access to and use of a wide range of data and related analysis. To be understood clearly, this data is best visualized and presented in the form of maps and what are often referred to as spatial images. Geographic Information Systems (GIS) and remote sensing bring such information about our communities "to life" for everyone. These technologies allow us to collect, visualize, and analyze information about our urban environment. In so doing, they can answer a range of simple or complex questions important to planning and decision-making. These include the following example questions:

- How has development changed our community's land use pattern in the last ten years, and where are the changes occurring?
- Where are hazardous waste sites, generators, and storage facilities located in our community?
- What environmental pollutants exist in a specific area that affect the quality of urban life?
- What is the air quality in our community and how does it compare to other parts of the region?
- How might planned development or other changes alter traffic patterns or air quality in the community?
- What percentage of the land in our community is devoted to commercial uses, housing, open space, etc.?
- Is the urban vegetation changing and, if so, how?
- How is growth affecting the urban environment? How are specific habitats affected by this process?
- Where are public or private services located within the community and whom are they serving well or serving poorly?
- What types of businesses are located in a specific community?

In answering such questions, it may be important to either examine a single time period, such as one year, or look at changes which have occurred for much longer periods, such as over a ten year time span. The Urban Environment Initiative team is working cooperatively with various UEI Partner organizations to provide GIS and remote sensing information products and services so that they can carry out their own information gathering and analysis.



UEI Outreach, Products, and Services

The UEI products include dissemination of information on CD-ROM and via the Internet. In addition, the UEI team will conduct workshops and training sessions, in conjunction with its Partners, related to the GIS and remote sensing information and technologies we have available. These sessions are designed for both beginners and experienced computer users. They provide a "hands-on" opportunity for interested individuals to work with our "user-friendly" software and learn how we can assist your organization. In addition, it is an opportunity for you and others in your

organization to define your specific information needs and to work with us to determine how they can best be met with the UEI tools and support services.

UEI
Overview

UEI
Team

UEI
Partners

Thematic
Guides

Discussion
Forum

Areas of
Interest

Take a tour of Washington, D.C.

Order UEI Products and Services

Related WWW Sites

Understanding Queries

There are 4 types of queries

1. Comparing one parameter on the regional level
2. Compare the same parameter for 2 communities
3. Compare 2 different parameters within one community
4. Compare spatial distribution of population between the communities

Below you can find a description of each query to help you understand how to interpret the maps.

Comparing one parameter on the regional level

In the actual table of the population and housing parameters that was used to create this map, each census unit has an exact value of the parameter associated with it. However, it is impossible to display each value on the map using different shades of one or two colors - a human eye can not distinguish between more than 10-13 shades of the same color. In order to display a parameter on the map, it is first necessary to classify the values so that they fall within several intervals. This map was created using the quantile method of classification. A quantile classification divides the values into intervals in such a way that an equal number of census units falls within each interval. Six quantiles were used for the classification.

First examine the legend of the map. There are two colors used in the legend, with three shades of each color assigned to the six quantiles. Try to remember which color is associated with each interval of the parameter values. To answer the query, look at the map and compare the colors assigned to the census units within each community. If the colors are similar, it means these communities have similar values in the displayed parameter. For example, if most of the census units in both communities are assigned the darkest shades of blue, it means the communities have similar parameter values in the census table. However, if the census units of the first community are assigned the darkest shade of blue, while the census units of the second community are assigned the darkest shade of green, it means these communities have different parameter values. Use this method of comparison with all color schemes.

Community Level Queries

A. Compare the same parameter for 2 communities:

In the actual table of the population and housing parameters that was used to create this map, each census unit has an exact value of the parameter associated with it. However, it is impossible to display each value on the map using different shades of one or two colors - a human eye can not distinguish between more than 10-13 shades of the same color. In order to display a parameter on the map, it is first necessary to classify the values so that they fall within several intervals. This map was created using the quantile method of classification. A quantile classification divides the values into intervals in such a way that an equal number of census units falls within each interval. Six quantiles were used for the classification.

First examine the legend of the map. There are two colors used in the legend, with three shades of each color assigned to the six quantiles. Try to remember which color is associated with each interval of the parameter values. To answer the query, look at the map and compare the colors assigned to the census units within each community. If the colors are similar, it means these communities have similar values in the displayed parameter. For example, if most of the census units in both communities are assigned the darkest shades of blue, it means the communities have similar parameter values in the census table. However, if the census units of the first community are assigned the darkest shade of blue, while the census units of the second community are assigned the darkest shade of green, it means these communities have different parameter values. Use this method of comparison with all color schemes.

B. Compare 2 different parameters within one community:

In the actual table of the population and housing parameters that was used to create this map, each census unit has an exact value of the parameter associated with it. However, it is impossible to display each value on the map using different shades of one or two colors - a human eye can not distinguish between more than 10-13 shades of the same color. In order to display a parameter on the map, it is first necessary to classify the values so that they fall within several intervals. This map was created using the quantile method of classification. A quantile classification divides the values into intervals in such a way that an equal number of census units falls within each interval. Six quantiles were used for the classification.

*** Note: land use/land cover maps are the exception from the rule: in this case each category on the map is assigned a unique color. This can be done because land use/land cover classification consists of a limited number of unique categories (such as residential, wooded, water, etc.)***

There are two parameters displayed on the map, and each parameter has a legend (color scheme) associated with it. First examine the legends of the map. There are two colors used in each legend, with three shades of each color assigned to the six quantiles. Try to remember which color is associated with each interval of the parameter values. To answer the query, look at the map and compare the colors assigned to the census units in each parameter. Try to identify the corresponding census units on each map. If in both parameters the corresponding census units fall within the same interval of values (and as a result are assigned the colors at the same level of the two color schemes), it means there is a direct relationship between the displayed parameters within this community. However, if the corresponding census units fall within different intervals (and as a result are assigned the colors that are at the opposite ends of the color schemes), it indicates a reverse relationship between the parameters within the community.

C. Compare spatial distribution of population between the communities:

In the actual table of the population and housing parameters that was used to create this map, each census unit has an exact value of the parameter associated with it. However, it is impossible to display each value on the map using different shades of one or two colors - a human eye can not distinguish between more than 10-13 shades of the same color. In order to display a parameter on the map, it is first necessary to classify the values so that they fall within several intervals. This map was created using the quantile method of classification. A quantile classification divides the values into intervals in such a way that an equal number of census units falls within each interval. Six quantiles were used for the classification.

First examine the legend of the map. There are two colors used in the legend, with three shades of each color assigned to the six quantiles. Try to remember which color is associated with each interval of the parameter values. To answer the query, look at the map and compare the colors assigned to the census units within each community. If the colors are similar, it means these communities have similar values in the displayed parameter. For example, if most of the census units in both communities are assigned the darkest shades of blue, it means the communities have similar parameter values in the census table. However, if the census units of the first community are assigned the darkest shade of blue, while the census units of the second community are assigned the darkest shade of green, it means these communities have different parameter values. Use this method of comparison with all color schemes.

Los Angeles Locator Maps

Locator maps are used to show the boundary of a study area and its location relative to other communities and major highways.

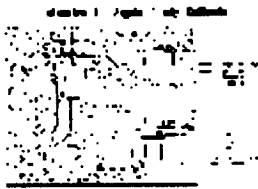

Alhambra

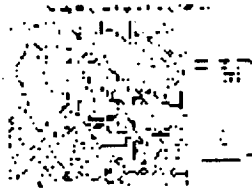

Burbank

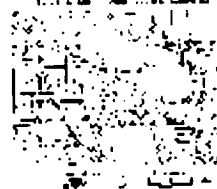

Beverly Hills



El Segundo

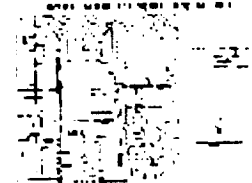

East L.A.



Florence-Graham

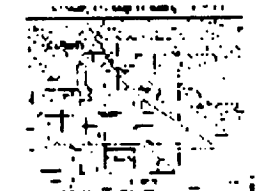

Norwalk

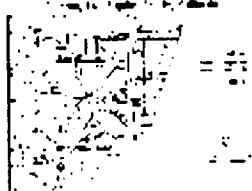

Pomona



Santa Monica

Robotics Break-out Session

*Dr. Shermane Austin
City College of New York*

*Dr. Chitta Bural
University of Texas at El Paso*

*Mr. Robert Coles
Gompers High School*

From theory to practice – The UTEP robot in the AAAI 96 robot contest

T. Son, D. Morales, C. Baral, M. Nogueira and L. Floriano
Department of Computer Sc.
Univ. of Texas at El Paso
El Paso, TX, 79968, USA
{tson,dmorales,chitta,monica.floriano}@cs.utep.edu
915-747-5596

Abstract

In this paper we describe the control aspects of Diablo, the UTEP mobile robot participant in event one of the AAAI 96 robot contest, where Diablo consistently scored 285¹ out of a total of 295 points. The main goal in this paper will be to show how the agent theories - based on action theories – developed at UTEP and by Saffioti et al. was used in the building of Diablo.

1 Introduction

We participated² in the AAAI 96 robot navigation contest [KNH97]. *Our team scored 285 points in all runs of the contest out of a total of 295 points and was placed third in the finals.* In this paper we relate theory of agents, particularly the one developed at UTEP, for higher level control, and the one by Saffioti et al. [SKR95] for low level control, to the design of our contest entry, Diablo. In the process we present a top-down description of the control architecture of our robot and show how each level closely followed the theory.

In the AAAI 96 robot navigation contest [KNH97] robots were required to achieve a particular navigational task around a office like environment, given the topological map of the environment. In particular, the robot was required³ to start from the directors office, find if conference room 1 was available (i.e., empty), if not then find if conference room 2 was empty, if either was empty then inform professor1, professor2 and the director about a meeting in that room, otherwise inform the professors and the director that the meeting would be at the directors office, and finally return to the directors office. Robots were required to do all this without hitting any obstacle, without changing the availability status of the conference rooms, and the robot was required to be back at the director's office.

The topological map of the office environment and our partitioning of it to landmarks is given in the following figure.

¹We gave up 10 points in having a canned program to get out of the initial room. Otherwise our robot was perfect.

²We were also assisted by Alfredo Gabaldon, Richard Watson, Dara Morganstein and Glen Hutton.

³To focus on the main point we have simplified the real requirement a little bit.

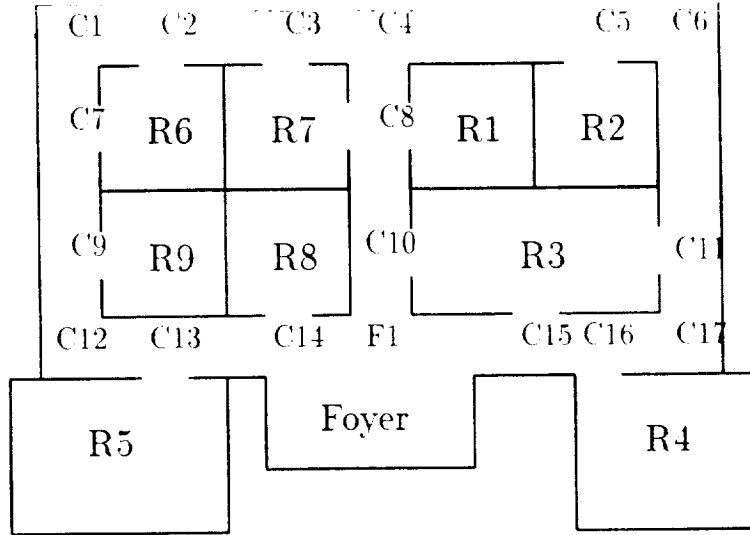

Figure 1: A Diagram Showing the Topological Map for Event 1 Participants at the AAAI 96 Robotics Competition.

2 Our theory of agents : a brief description

Our theory of agents is detailed in our earlier work [BS96, BS97a, BS97b]. In this theory we are concerned with the control of one agent in a dynamic environment, where exogenous events beyond the control of our agent may occur. Our agent has an action theory (such as a theory in the language [GL93, KL94, San94, BGP96]) where, actions and their effects are specified together with constraints and causal rules about the environment.

Our theory contains a formulation of correctness of a control module – a control module is a collection of control rules of the form

if p_1, \dots, p_n **then** a .

where, p_i 's are fluents whose value is obtained through sensing and a is an action

with respect to an action theory, a goal (could be achievement or maintenance goal), a set of plausible initial states, and a theory of occurrence about the exogenous events. The formulation of correctness is based on two steps:

(i) First we compute the set of plausible states, called the *closure*, based on a given set of initial states, the control module and a theory about what exogenous events are likely to occur. (ii) Then, for each state in the closure, we *unfold* the control module by assuming that no exogenous events occur and test if the resulting plan (which may be a conditional plan [Lev96], if the state is incomplete and the control module has sensing actions) achieves the goal.

Note that, since exogenous events are taken care of in step (i), they do not need to be considered in step (ii).

We also develop sufficiency conditions for correctness that allows us to prove the correctness of a class of control modules, and more importantly they (the sufficiency conditions) give us an algorithm that automatically constructs control modules, given a goal, a set of initial states, and a theory about the exogenous actions.

Our approach to control agents is to take a goal, and an action theory about the agents actions and the environment, and either verify correctness of control rules provided by a control design person, or automatically construct a control module correct with respect to a set of given plausible states, or a combination of both. *All this is supposed to happen off-line.* (Unlike, universal plans [Sch87], we only consider a subset of all states, which are carefully constructed from a given set of plausible

states based on what actions the agent is going to do and what exogenous events are highly likely. In [BS96], these set of states is referred to as the *closure*.) Our agent is supposed to be equipped with such a control module before it is on its own in the environment.

Once the agent is on-line, it is supposed to continuously sense and react based on its control module. In rare cases the agent may be in a state which was not accounted for off-line and there is no control rule prescribing what to do in such a case. If that happens, the agent deliberates, to reach one of the accounted for states. (Note that, since the set of accounted states is much larger than the set of states that satisfies the goal, it is much easier to make a plan to reach an accounted-for state.) From there the control module can tell the agent what to do. Note, that our use of both deliberation and reaction is different from the traditional hybrid architectures [Ark91] (also in many of the papers in [Mae91]), where lower level modules are reactive and higher level modules are deliberative. In our case, the agent is reactive at all levels for the set of plausible states for which it is prepared, and it becomes deliberative when it encounters a rare state that was not taken into account during off-line compilations.

Our approach differs from the formalization of correctness of complex plans in [LLL⁺94] in that we consider exogenous actions, and our control modules are reactive. Our work can be seen as strengthening the results in [Dru89, Sch87] in the sense that

- Schoppers in Section 6.1 of [Sch87] says, "Universal plans not only anticipate every possible situations in a domain but actually prescribe an action for every initial state: more over the prescribed action is *usually optimal*. In our formulation the prescribed action is *optimal*."
- Drummond in [Dru89] says, "sound SCRs guarantee that local execution choices always lead to *possible goal achievement*". In our formulation, local execution choices always lead to *goal achievement*."

Finally, we deflect criticisms of universal plans by having the control rules only with respect to a set of highly plausible states, not the set of all states. The later is often prohibitively large and unmanageable. Finally, we consider explicit sensing actions, and conditional plans, which to the best of our knowledge is not considered in any research on situation control rules or universal plans. It is considered in the language \mathcal{R} in [Lev96], but they do not allow exogenous actions, and plans in \mathcal{R} are not reactive and are not appropriate for dynamic domains where change may happen without the agents own actions.

In the previous paragraphs we talked about an agent being controlled by continuously executing a control module. The actions in the right hand side of control rule in a control module can itself be implemented by another control module, and so on.

In case of a mobile robot in an office environment (and most applications), there could be several hierarchies of such control modules. Although, our theory is appropriate for the higher level control module, because of high uncertainty in the lower levels of sensing and action in a mobile robot⁴, it is not appropriate for the lower levels, such as, for executing an action to straight until an intersecting corridor is detected.

For the lowest level, we did use control rules, but not exactly as mentioned in the earlier paragraphs. We used the rules and the formalism described in [SKR95] that has multi-valued logic and is geared to handle uncertainties. Especially, the formulation of blending of control modules [SKR95] was extremely useful in our robot, in providing smooth motion while blending the actions of following a corridor and avoiding an obstacle.

⁴This may not be the case for many other agents, such as an agent in the Internet environment. In that case our formulation will be applicable at all levels.

3 Top-down design of our robot

In this section we first describe our representation of the environment. We then describe the different levels of the robot control and relate the role of agent theories in that level. Finally, we put everything together and describe the overall architecture of the robot.

3.1 Representing the environment

We partitioned the topological map into several regions each labeled by a landmark name based on two criteria - (i) so that the landmarks can be recognized by the robot through sensing and memory about its past positions, and (ii) there were enough landmarks that the robot could achieve the required task and recover from any failures.

Based on the above criteria, we decided to designate areas of (approximately) constant corridor width within the navigation domain as landmarks. When a robot moves from one landmark to another, the corridor width changes abruptly (see Figure 2). If the landmark is a break in the wall, like a junction or door, it is designated as a landmark of type *junction*. If the landmark is a detected corridor, that is, it detects it is navigating within a hallway of a given width, it is designated as a landmark of type *corridor*. Entrances to rooms are designated as landmarks of type *door*.

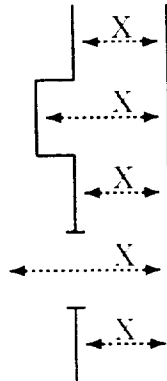

Figure 2: Areas marked X are landmarks.

We then stored adjacency information about landmarks and approximate distance between adjacent landmarks in a table. We further discuss this in a later section.

3.2 The top-level module and its correctness

Our top-level module was a control module of the kind described in the previous section. Its reactive structure was geared towards gracefully recovering from breakdowns which can be modeled as exogenous actions. Following was our top-level control module:

```
if  $\neg$ visit_conf_1 then go_to_conf(1)
if at_conf(1), u(avail(1)) then sense_avail(1)
if at_conf(1),  $\neg$ avail(1) then go_to_conf(2)
if at_conf(1), avail(1),  $\neg$ visit_prof(1) then go_to_prof(1)
if at_conf(2), u(avail(2)) then sense_avail(2)
if at_conf(2), avail(2),  $\neg$ visit_prof(1) then go_to_prof(1)
```

```

if at_conf(2),  $\neg$ avail(2),  $\neg$ visit_prof(1) then go_to_prof(1)
if at_prof(1),  $\neg$ visit_prof(2) then go_to_prof(2)
if at_prof(2),  $\neg$ back_to_director then go_to_director
if back_to_director then HALT

```

In the above control module the part between **if** and **then** is a list of fluents, whose value is determined by sensing. The function u is used to denote that the value of a particular fluent is unknown. We would like to reiterate that, to the best of our knowledge none of the previous work on control rules or universal plans, allow such a construct. Even in [SKR95], where multi-valued logic is used, the truth value of a fluent ranges from 0 to 1, and does not take into account that the fluents truth value may be unknown. Also, special sensing actions such as the action *sense_avail*(1) in the above module is not used in earlier work on control modules or universal plans. They have been used in the reasoning about actions [SL93, Lev96] and planning community [GW96] though, but there also not in any reactive framework. *We must say that we appreciate the organizers of the contest who foresaw this scientific advance when creating the contest problem.*

We constructed the above control module manually. *But we were able to use our agent theory described in the previous section to verify the correctness of our control module.* Note that the goal of this control module, can not be simply expressed as a collection of fluents (not even as a classical formula of fluents), as is normally required in most planning systems, but can only be expressed as a formula with temporal and knowledge operators. Here also, although goals with temporal operators have been considered in the agents community [Sin94], in the planning community it was only recently studied in [BK96]. But, the incorporation of both temporal and knowledge operators in a goal has never been formally studied, except in a preliminary attempt in [GW96].

We now give a declarative representation of our goal in an extension of the language FMITL (First-order metric interval temporal logic) [BK96]. Our extension allows specification of knowledge. The meaning of various operators and atoms in the following specifications are: Ka means a is known to be true; *avail*(1) means conference room 1 is available, *informedprof*1(1) means professor 1 has been informed that the meeting will be in conference room 1, $\Box f$ means always f is true, $\diamond f$ means eventually f is true, and *at*(*dir*) means the robot is at the directors office.

$$\begin{aligned}
& (Kavail(1) \vee K\neg avail(1)) \wedge \\
& (K\neg avail(1) \Rightarrow (Kavail(2) \vee K\neg avail(2))) \wedge \\
& (Kavail(1) \Rightarrow (informedprof1(1) \wedge \\
& \quad informedprof2(1) \wedge informeddirector(1))) \wedge \\
& ((Kavail(2) \wedge K\neg avail(1)) \Rightarrow (informedprof1(2) \wedge \\
& \quad informedprof2(2) \wedge informeddirector(2))) \wedge \\
& ((K\neg avail(1) \wedge K\neg avail(2)) \Rightarrow (informedprof1(dir) \wedge \\
& \quad informedprof2(dir) \wedge informeddirector(dir))) \wedge \\
& \forall X avail(X) \Rightarrow \Box avail(X) \wedge \\
& \Box clear_from_obstacle \wedge \diamond \Box at(dir)
\end{aligned}$$

We used our agent theory to verify the correctness of goals which are formulas with temporal and knowledge operator, by checking if the unfoldings of the control modules with respect to the various states, satisfied the goal. But, due to temporal operators in the goal the trajectory of the states became as important as the the final state and because of that our automatic construction algorithm was not able to construct control modules for such goals. *One of our future goals is to find algorithms to automatically generate control modules for complex goals with knowledge and temporal operators.*

Type of From Node	Type of To Node	Action
corridor	junction	<i>detect_break</i>
junction	corridor	<i>detect_corridor</i>
X	Y, Y=X	<i>go_forward</i>
junction	door	<i>go_to_door</i>
door	junction	<i>go_to_door</i>

Table 1: Some action rules for generation of navigation actions

3.3 Modules to take from one room to another room - automatic construction

The top level control module used two special sensing actions: *sense_avail(1)* and *sense_avail(2)*, and five non-sensing actions: *go_to_conf(1)*, *go_to_conf(2)*, *go_to_prof(1)*, *go_to_prof(2)*, and *go_to_director*. The two sensing actions were implemented using sonars that checked if there was any substantial movement in the room, and did not have a reactive structure. The non-sensing actions were abstracted as going from one landmark (or node) in the topological map to another. This was implemented using a control module. We now describe this control module, which we refer to as the navigation control module.

The navigation control module was basically a table with three columns: current node⁵, goal node, next adjacent node. An entry (5.3.4) in that table meant that if the robot is currently at node 5 and its ultimate goal is to reach node 3 then it should next go to the adjacent node 4. The actions in this module were actions that took the robot from any node to its specified adjacent node. *This control module was automatically generated and we used the approximate distance between adjacent nodes as the cost of the action that takes the robot from one of those nodes to the other.*

The actions that took the robot from one node to one of its specified adjacent node was also implemented by a control module. We now describe this control module.

3.4 Control module for going to an adjacent node - correctness

The actions used in this control module were of two types: turning actions, that changes the heading of the robot and navigational actions, that takes the robot from one kind of node to an adjacent node of another kind. The turning actions are listed in the third column of Table 2 and the navigation actions are listed in the third column of Table 1.

Following gives a flavor of how the effect of navigation and turning actions could be formally specified:

detect_corridor causes $at(X), \neg at(Y)$ if $at(Y), type(Y, junction), type(X, corridor),$
 $heading(dir), adj(X, Y, dir)$

turn_180 causes $heading(west), \neg heading(east)$ if $heading(east)$

In the above specification, $type(X, corridor)$ means that node X is of the type corridor. Similarly, $adj(X, Y, dir)$, means that the nodes X and Y are adjacent and to go from node X to node Y the robot's heading must be dir . We now give a simple map with five nodes and give a table that has the adjacency and heading information for the given map. Intuitively, the first row of Table 3 can be read as node 5 is of type corridor, node 4 is of type junction, node 5 and 4 are adjacent,

⁵We use the terms 'landmark' and 'node' interchangeably.

Current Heading	Need to be	Action
east	west	<i>turn_180</i>
east	south	<i>turn_right_90</i>
X	Y. Y=X	
east	north	<i>turn_left_90</i>
west	east	<i>turn_180</i>
west	south	<i>turn_left_90</i>
west	north	<i>turn_right_90</i>
north	west	<i>turn_left_90</i>
north	east	<i>turn_right_90</i>
north	south	<i>turn_180</i>
south	east	<i>turn_left_90</i>
south	west	<i>turn_right_90</i>
south	north	<i>turn_180</i>

Table 2: Action rules for generation of turning actions

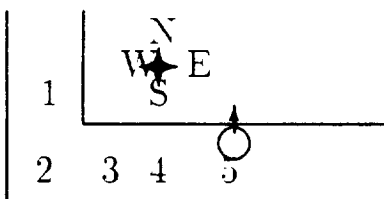

Figure 3: A sample map.

approximate distance between them is 150 units, and to go from node 5 to node 4 the robot's heading must be west.

Now let us get back to the control module that takes the robot from one node to a specified adjacent node. The condition part of each control rule in the control module checks if the robot's heading is appropriate (as specified in Table 3), and if not, the robot executes the turning action specified by the Table 2. If the heading is appropriate the robot executes the navigation action specified by Table 1. In other words, Tables (1 and 2) are compiled from the description of actions and describe which action to take given particular information about an initial state and a goal. *Tables (1 and 2) were generated manually and their correctness was verified using the theory of the paper. We*

N1	Type N1	N2	Type N2	Heading	Dst.
5	corridor	4	junction	west	150
4	junction	3	corridor	west	100
3	corridor	2	wall_break	west	150
2	wall_break	1	corridor	north	150

Table 3: An example showing adjacency records for the domain depicted by Figure 3.

Action Name	Effect
<i>go_forward</i>	Go forward for a given distance.
<i>detect_corridor</i>	Go forward until a corridor of a given width is detected.
<i>go_to_door</i>	Go forward some distance to enter a room.
<i>detect_break</i>	Follow a corridor of a given width until a change in the corridor width is detected.
<i>turn_left_90</i>	Turn left 90 degrees.
<i>turn_right_90</i>	Turn right 90 degrees.
<i>turn_180</i>	Turn 180 degrees.
<i>speak</i>	Transmit information.
<i>detect_occupied</i>	Sensing action to detect if a room is occupied.
<i>align</i>	Correct hardware uncertainty.

Table 4: Basic actions

could have automatically constructed them using our algorithm though.

3.5 Basic actions and Skills

We refer the actions in the previous control module (the actions in the third column of the tables 1 and 2) as the basic actions. They were implemented by *merging* several skills which were implemented using *control modules based on multi-valued logic*. At the lowest level, the uncertainty associated with the physical world makes it harder to implement low level tasks using control modules of the kind (where, fluents are 2-valued) described in this paper. We found the control modules of the kind described in [SKR95]⁶ that uses multi-valued logic to be more appropriate for that purpose. We also used the concept of ‘merging’ control described in [SKR95] for blending skills into basic actions. For example, the basic action of going forward means translating forward with a certain speed and at the same time avoiding obstacles, and avoiding a crash. I.e., the basic action *go_forward* involves the *blending* (or *normalization*) [SKR95] of many of the skills (not necessarily all) with respect to assumed associated skill priorities: *Avoid Crash*, *Control Steering*, *Control Speed*, *Facing Ahead*, *Avoid Obstacles*, *Search for Destination*. The tables (3.5 and 3.5) list the basic actions of our robot, the skills of our robots and their intuitive function. Table 3.5 also lists the weight of the various skills for implementing the action *detect_corridor*.

The concept of normalization of skills to define a basic action can be formally described as follows: Suppose, \mathcal{A} is the set of basic actions and \mathcal{B} is the set of skills, and for each $\beta \in \mathcal{B}$ there is an associated translation value t_β and rotation value r_β .

⁶Although, Saffioti et al [SKR95] have a notion of correctness for their control modules, they do not consider exogenous actions, and sensing actions. *One of our future goal is to extend our approach to the control modules in [SKR95] in defining correctness in presence of exogenous and sensing actions, as well as develop methods to automatically construct such control modules.*

Behavior β_i	Function	Weight $w_i^{detect_corridor}$
Translate_Forward	Always traverse forward.	10
Point_To_Opening	Find openings for the robot to traverse through.	15
Follow_Corridor	Follow a virtual corridor and look for a hallway of a given width.	15
Avoid_Close_Sonar	Avoid close sonar sensor readings.	20
Avoid_Close_InfraRed	Avoid close infra red sensor readings.	110
Stop_When_Touched	Stop when bumped.	1000
Avoid_Crashing	Stop if in danger of crashing into obstacles.	1000
Point_Forward	Keep robot from turning back.	1000

Table 5: Some of the skills of our robot and weights for *detect_corridor*

Then for each basic action $a \in \mathcal{A}$ which is the normalization of behaviors β_1, \dots, β_n we associate to a the weights w_1^a, \dots, w_n^a and compute the translation and rotation by the following formula:

$$t_a = \frac{\sum_{i=1}^n t_{\beta_i} \cdot w_i^a}{\sum_{i=1}^n w_i^a} \quad (1)$$

$$r_a = \frac{\sum_{i=1}^n r_{\beta_i} \cdot w_i^a}{\sum_{i=1}^n w_i^a} \quad (2)$$

The following example illustrates one such normalization.

Example 2.3 Suppose our robot wants to perform the action *detect_corridor* in the situation depicted by Figure 4 with current velocity of 150 mm/second and heading index of 0 (which corresponds to the robot heading directly North). The action *detect_corridor* is composed of the skills listed in Table 3.5.

Suppose the current sensor readings cause the corresponding behaviors to propose individual translations and rotations as follows:

- Translate_Forward proposes $t_{\beta_1} = 150; r_{\beta_1} = 0$;
- Point_To_Opening proposes $t_{\beta_2} = 90; r_{\beta_2} = 150$;
- Follow_Corridor proposes $t_{\beta_3} = 0; r_{\beta_3} = 0$;
- Avoid_Close_Sonar proposes $t_{\beta_4} = -100; r_{\beta_4} = 65$;
- Avoid_Close_InfraRed proposes $t_{\beta_5} = -100; r_{\beta_5} = 65$;
- Stop_When_Touched proposes $t_{\beta_6} = 0; r_{\beta_6} = 0$;
- Avoid_Crashing proposes $t_{\beta_7} = 0; r_{\beta_7} = 50$;

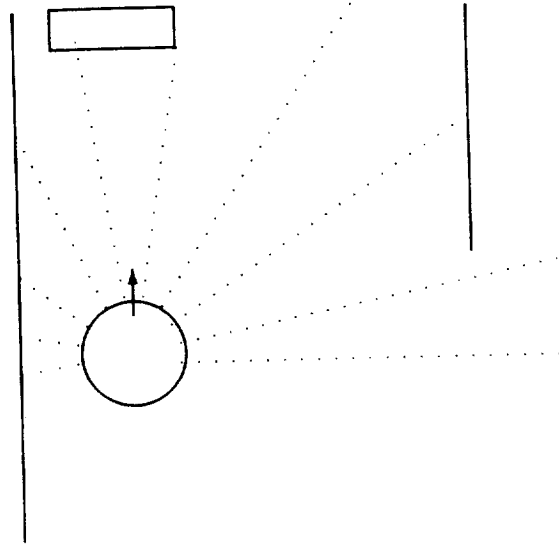

Figure 4: A diagram showing sonar emissions when avoiding an obstacle.

- Point_Forward proposes $t_{\beta_8} = 150; r_{\beta_8} = 0$:

The overall translation and rotation for the robot would be $t_{detect_corridor}=44.1$ and $r_{detect_corridor}=3.3$. Therefore the action *detect_corridor*, through its corresponding behaviors, causes the robot to slow down to 44 mm/sec and turn right 3.3 units (which corresponds to about 1 degree) to avoid the encountered obstacle.

3.6 The overall architecture

Figure 5 depicts the overall architecture of Diablo which is very much like the three tiered architecture in [BKMS95]. We now relate this architecture with the modules described in the previous sections and show the correspondence between them.

In Figure 5 the Task-list block corresponds to the top level module. The actions of that module are referred to as tasks, in our architecture; and also in [BKMS95]. The various tasks that we have are: *sense_avail(1)*, *sense_avail(2)*, *go_to_conf(1)*, *go_to_conf(2)*, *go_to_prof(1)*, *go_to_prof(2)*, and *go_to_director*. Execution of the last five tasks involved the *navigation control module* which would take the robot from one node to another. This corresponds to the shortest path generator block in the architecture. The control module that takes the robot from one node to an adjacent node corresponds to the action plan generator block in our architecture. The universal plan block in the architecture corresponds to the combination of the navigation control module and the control module that takes the robot from one node to its adjacent node. The Sequencer as a whole would take the appropriate task from the task list and use the universal plan to determine the sequence of basic actions to be executed. The reactive block in the architecture corresponds to the basic action and skills module.

The above correspondence gives an idea of the process behind going from a theoretical hierarchy of control modules to a control architecture. It suggests that merging of levels of control modules may be useful and necessary from the implementation point of view. In fact to maintain reactivity, we need to merge levels of control modules. We will further discuss this in the full paper.

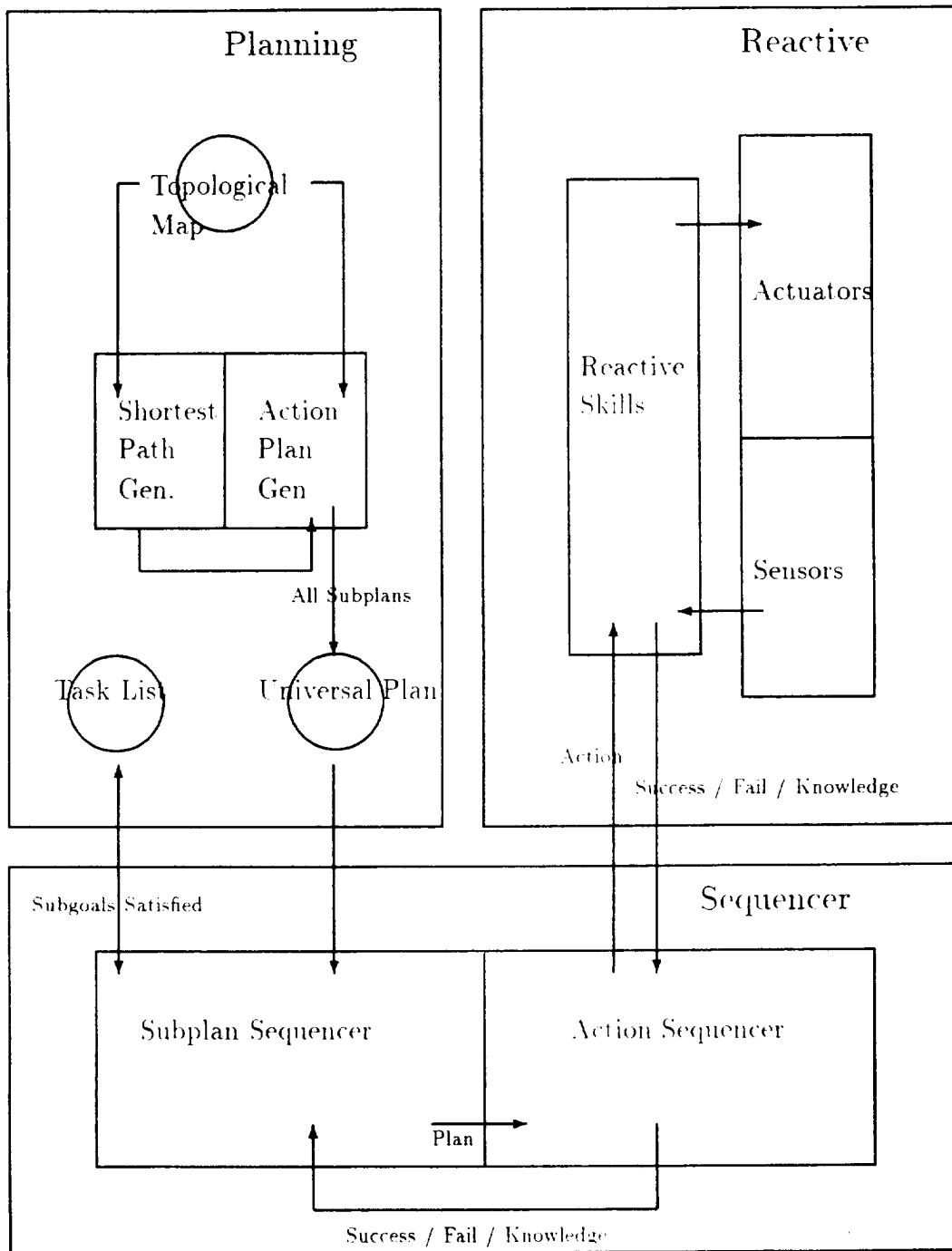

Figure 5: A depiction of UTEP3AI, the architecture used for the AAAI '96 Robot Competition.

References

- [Ark91] R. Arkin. Integrating behavioral, perceptual, and world knowledge in reactive navigation. In P. Maes, editor, *Designing Autonomous Agents*, pages 105-122. MIT Press, 1991.
- [BGP96] C. Baral, A. Gabaldon, and A. Proveti. Formalizing Narratives using nested circumscription. In *AAAI 96*, 1996.
- [BK96] F. Bacchus and F. Kabanza. Planning for temporally extended goals. In *AAAI 96*, pages 1215-1222, 1996.
- [BKMS95] R. Bonasso, D. Kortencamp, D. Miller, and M. Slack. Experiences with an architecture for intelligent, reactive agents. In M. Woolridge, J. Muller, and M. Tambe, editors, *Intelligent Agents - II*, pages 187-202. Springer, 1995.
- [BS96] C. Baral and T. Son. Relating theories of actions and reactive robot control. In *Proc. of AAAI 96 Workshop on Reasoning about actions, planning and robot control: bridging the gap.*, 1996.
- [BS97a] C. Baral and T. Son. Regular and special sensing in robot control - relation with action theories. In *Proc. of AAAI 97 Workshop on Robots, Softbots, and immobots - Theories of Action, Planning and Control (to appear)*, 1997.
- [BS97b] C. Baral and T. Son. Relating theories of actions and reactive control. Technical report, Dept of Computer Sc. University of Texas at El Paso (<http://cs.utep.edu/chitta/chitta.html>), 1997.
- [Dru89] M. Drummond. Situation control rules. In *KR 89*, pages 103-113, 1989.
- [GL93] M. Gelfond and V. Lifschitz. Representing actions and change by logic programs. *Journal of Logic Programming*, 17(2,3,4):301-323, 1993.
- [GW96] K. Golden and D. Weld. Representing sensing actions: the middle ground revisited. In *KR 96*, pages 174-185, 1996.
- [KL94] G. Kartha and V. Lifschitz. Actions with indirect effects: Preliminary report. In *KR 94*, pages 341-350, 1994.
- [KNH97] D. Kortenkamp, I. Nourbaksh, and D. Hinkle. The 1996 aai mobile robot competition and exhibition. *AI magazine*, pages 25-32, 1997.
- [Lev96] H. Levesque. What is planning in the presence of sensing? In *AAAI 96*, 1996.
- [LLL⁺94] Y. Lesperance, H. Levesque, F. Lin, D. Marcu, R. Reiter, and R. Scherl. A logical approach to high level robot programming - a progress report. In *Working notes of the 1994 AAAI fall symposium on Control of the Physical World by Intelligent Systems (to appear)*, New Orleans, LA, November 1994.
- [Mae91] P. Maes, editor. *Designing Autonomous Agents*. MIT/Elsevier, 1991.
- [San94] E. Sandewall. The range of applicability of some non-monotonic logics for strict inertia. *Journal of Logic and Computation*, 4(5):581-616, october 1994.

- [Sch87] M. Schoppers. Universal plans for reactive robots in unpredictable environments. In *IJCAI 87*, pages 1039–1046, 1987.
- [Sin94] M. Singh. *Multiagent systems - a theoretical framework for intentions, know-how, and communications*. Springer-Verlag, 1994.
- [SKR95] A. Saffioti, K. Konolige, and E. Ruspini. A multivalued logic approach to integrating planning and control. *Artificial Intelligence*, 1995.
- [SL93] R. Scherl and H. Levesque. The frame problem and knowledge producing actions. In *AAAI 93*, pages 689–695, 1993.

Multimedia Break-out Session - Day 1

*Dr. Samuel Borenstein
York College*

*Dr. Bruce Naples
Queensboro Community College*

*Dr. Donald Walter
South Carolina State University*

*Dr. George Wolberg
City College of New York*

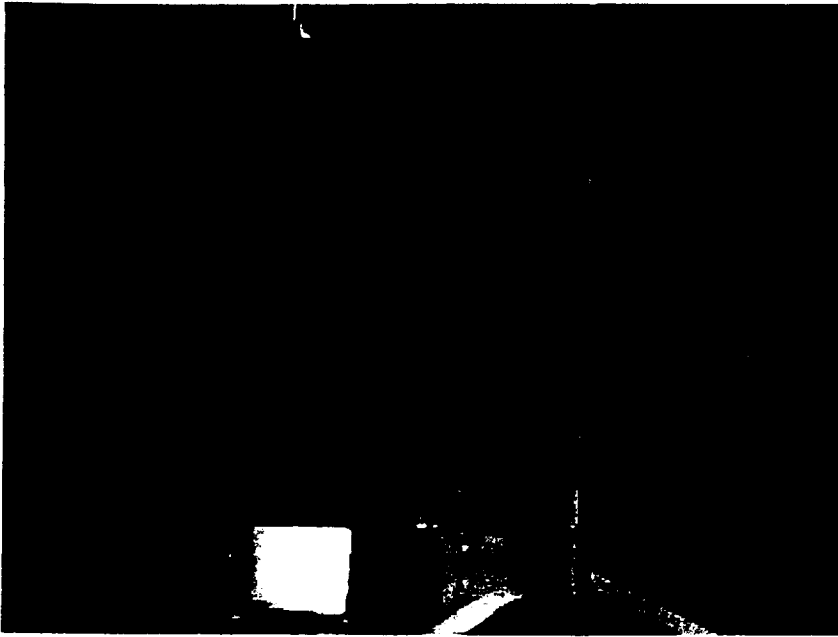

Samuel R. Borenstein, Physics Professor, Queensboro Community College.

WELCOME TO Sam Borenstein's activities with the Institute on Climates and Planets ICP at the Goddard Institute of Space Studies GISS. The ICP is a collaborative effort between GISS and a group of high schools and universities throughout New York City. The students and faculty participate in studies of climate modelling performed by the GISS scientists. The activity is multi-faceted.

- **Research:** students and faculty participate in state of the art climate research under the mentorship of GISS scientists.
- **Learning from GISS:** Students and faculty gain insight into the research experience by participation, by seminars and above all by one to one contact with the GISS scientists.
- **Learning from each other:** the high school and college faculty members act as facilitators between the scientists and the students, supplementing the materials discussed by the scientists. In addition, faculty members prepare and conduct workshops to help students understand the underlying principles.
- **Curriculum Development:** One of the main goals of this program is to bring back the fruits of this experience to the home campus, so that it can be enjoyed by a wider audience.

My own activities have involved each of the above categories.

- **Research:** We have been involved with the "Pinatubo" Group whose task is to use computer intensive techniques to study the Climate General Circulation Model GCM predictions and to compare them with observations, in order to evaluate, validate and improve the model. The results have been presented at the 7th annual conference on global warming held at the Vienna April 1996 GWIC conference. We have also embarked in an individual project involving a statistical study of Heating Degree Days throughout the US.
- **Learning/Teaching:** I have been active in preparing and leading workshops on various topics related to our research activities and the underlying scientific principles.
- **Curriculum Development:** I have been developing interactive computer software or courseware to allow students to work on an autotutorial basis to help to understand basic physics concepts as well

as some examples devoted to meteorology topics. This work has been done using the authoring program TOOLBOOK, and a number of modules have been developed.

Abstract:

Courseware for Physics and Meteorology Samuel R. Borenstein Abstract:

Using the commercial software "Multimedia Toolbook", Several interactive modules have been developed as auto-tutorial teaching tools to help students learn basic physical concepts as well as several meteorological applications. These modules fall into 3 categories:

1. Basic Physical Concepts: Vectors, Projectiles, Moments.
2. Physics Laboratory Simulations: The Atwood Machine: masses connected via Pulleys to calculate the value of "g" the gravitational constant. An oscillating spring to demonstrate Hooke's law and Simple Harmonic Motion.
3. The Ideal Gas Laws applied to air mass parcels in the atmosphere: An animated seascape scene is used to explain the monsoon effect: Afternoon warming of the land relative to the ocean produces a sea breeze, while evening cooling of the land relative to the ocean produces a land breeze.

1. Basic Physical Concepts:

a) Vectors

A vector is a quantity which has both size and direction.
At left the vector v_2 is represented by the red arrow,
whose size is represented by the length of the arrow,
and whose direction is represented by the angle θ .
The vector can also be represented by two components:
 $x_2 = v_2 \cdot \cos(\theta);$ $y_2 = v_2 \cdot \sin(\theta)$
 Click here to see the x component x_2
 Click here to see the y component y_2

You may now Click here to see a similar vector v_1
In order to add the vectors $v_1 + v_2$, the vector v_2 is moved
so that the tail of v_2 starts at the point of v_1
Click here to add v_2 to v_1 then HERE to see the resultant
To see the x and y components move: CLICK HERE
You may now repeat this demonstration
 or
You may manipulate the vector v_2

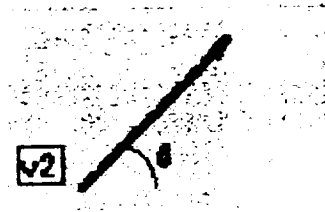

B

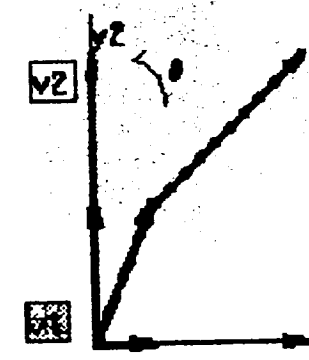

D

A
 By following the instructions in the yellow text, and clicking on the red "hypertext", the arrows representing the vector v_2 and its components move from their positions in frame B to add to the vector v_1 in frame D. A "ghost" of their initial position remains to remind the student of their

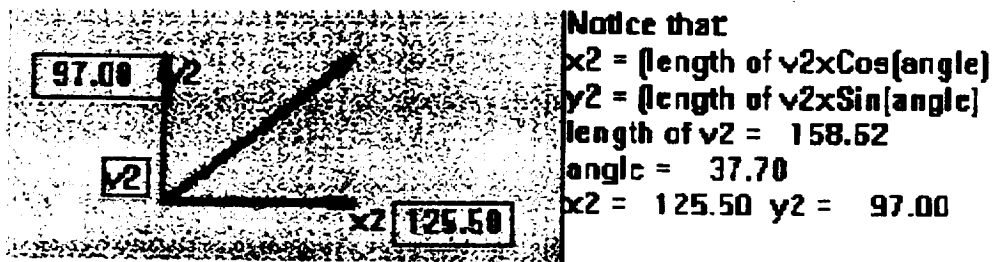

E

Frame E is a still from an animation continuously created by the student who manipulates the main vector with the mouse. The x and y components of the vector continually adjust themselves to the length and orientation of the main vector. The x and y coordinates are printed on the frame in "real time" as the vector changes its disposition. To the right of the frame, the equations governing this process, as well as all the numerical values are printed at

Figure 1.

Figure 1 shows a portion of the Toolbook session used to demonstrate the properties of a vector. The online instructions are contained in the yellow text box. The portion of the text in red (usually of the form "Click Here") is a series of hyperlinks which invokes the animation in which the vector's components are demonstrated. The three figures labelled B, C and D are stills from this animation.

A shows the vector, its direction and its X component. B shows the X and Y components of this vector in red, as well as a second vector shown in black. D shows the end of the animation, whereby the x and y components of the red vector have been added to those of the black vector. The very faint pink lines in figure D are the "ghosts of the original Red vector, so that the student can see where the vector came from. Finally, figure E is a still from an interactive session in which the student grabs the vector with the mouse, and as he manipulates it, the x and y components adapt themselves dynamically to the position of the mouse. The text on the right gives the trigonometric relationship by which the components are calculated.

With this package, the student is first led semi-passively, via hyperlinks through a demo of the decomposition of a vector into its x and y components, followed by a demo of the addition of the components of two vectors.

At the end of this demo, the student has the option to repeat the demo any number of times, or to go ahead with the next step, which is to manipulate the vector by grabbing it with the computer mouse, and observe the way the x and y components dynamically adjust themselves to the appropriate values, obeying the trigonometric laws that govern them.

Finally, the student is allowed to create two vectors of his own choice, and is guided through an exercise, whereby the components are calculated, visualized and added. At various points along the way, the student is asked to calculate the next step, and in this way can gauge his own progress.

b) Projectiles.

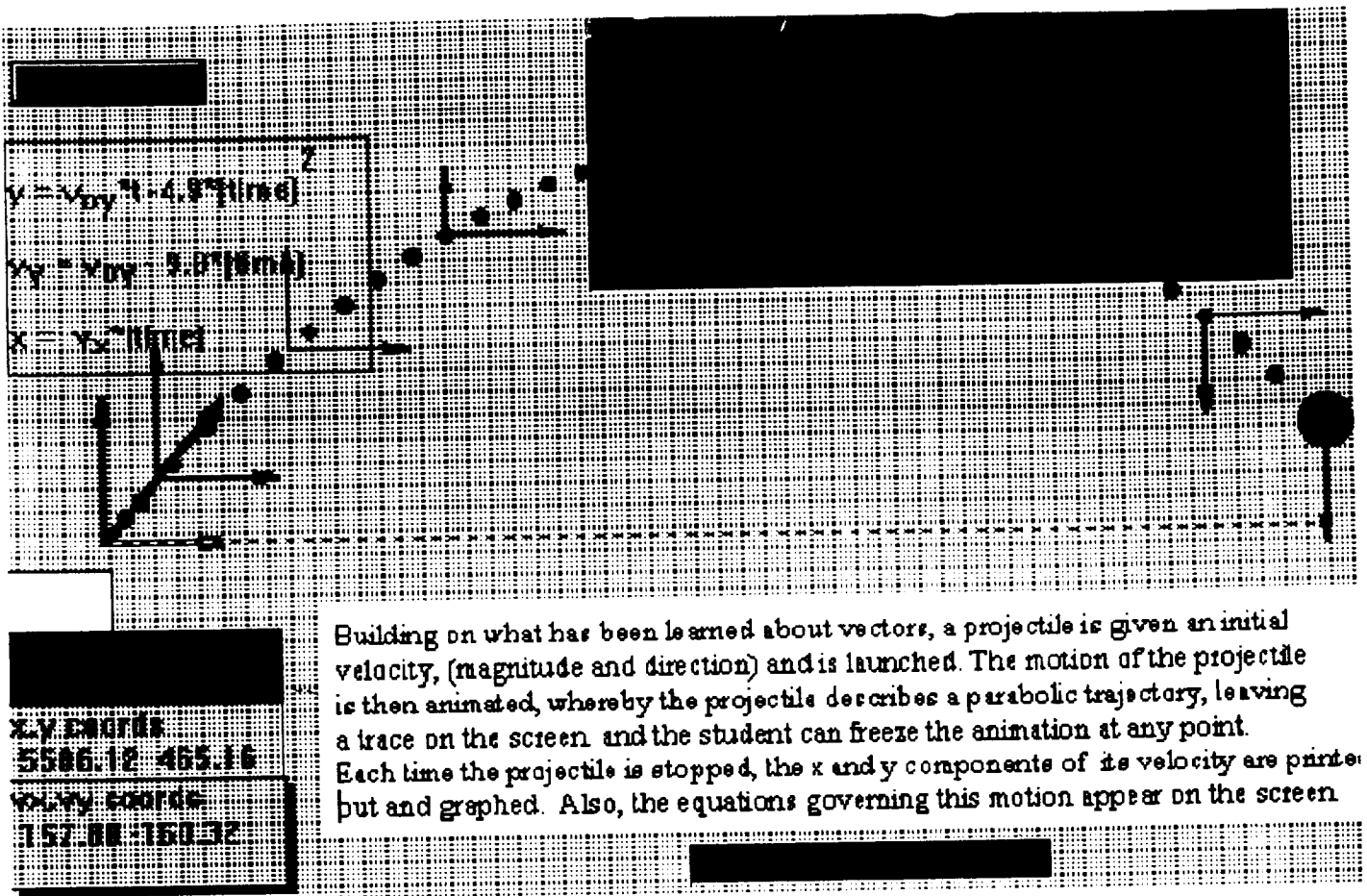

Figure 2.

Building on what has been learned about vectors, a projectile is given an initial velocity, (magnitude and direction) and is launched. The motion of the projectile is then animated, whereby the projectile describes a parabolic trajectory, leaving a trace on the screen, and the student can freeze the animation at any point. Each time the projectile is stopped, the x and y components of its velocity are printed out and graphed. Also, the equations governing this motion appear on the screen.

Figure 2 shows a composite of three frozen points of the animation.

When this animation is completed, the student is invited to play baseball. The ball is given an initial "x" component of velocity, and the student must calculate the necessary "y" component required to clear the fence and make a Home Run.

2. Laboratory Simulations:

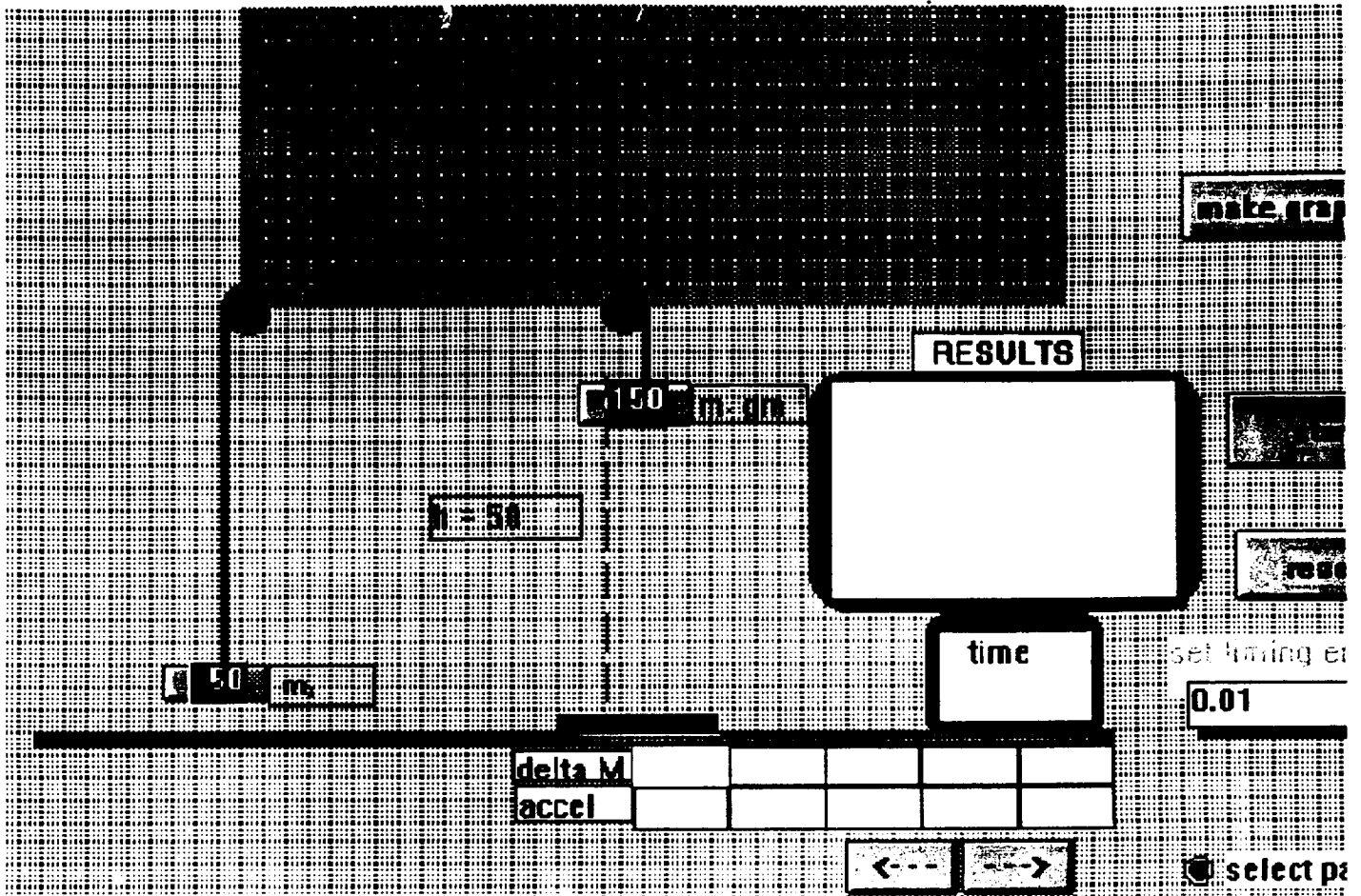

Figure 3a.

In Figure 3a above, we see the Atwood machine about to be released, when the student presses the "start" button, an animation starts, whereby the heavy weight falls and the light weight rises. Note that the data windows are empty.

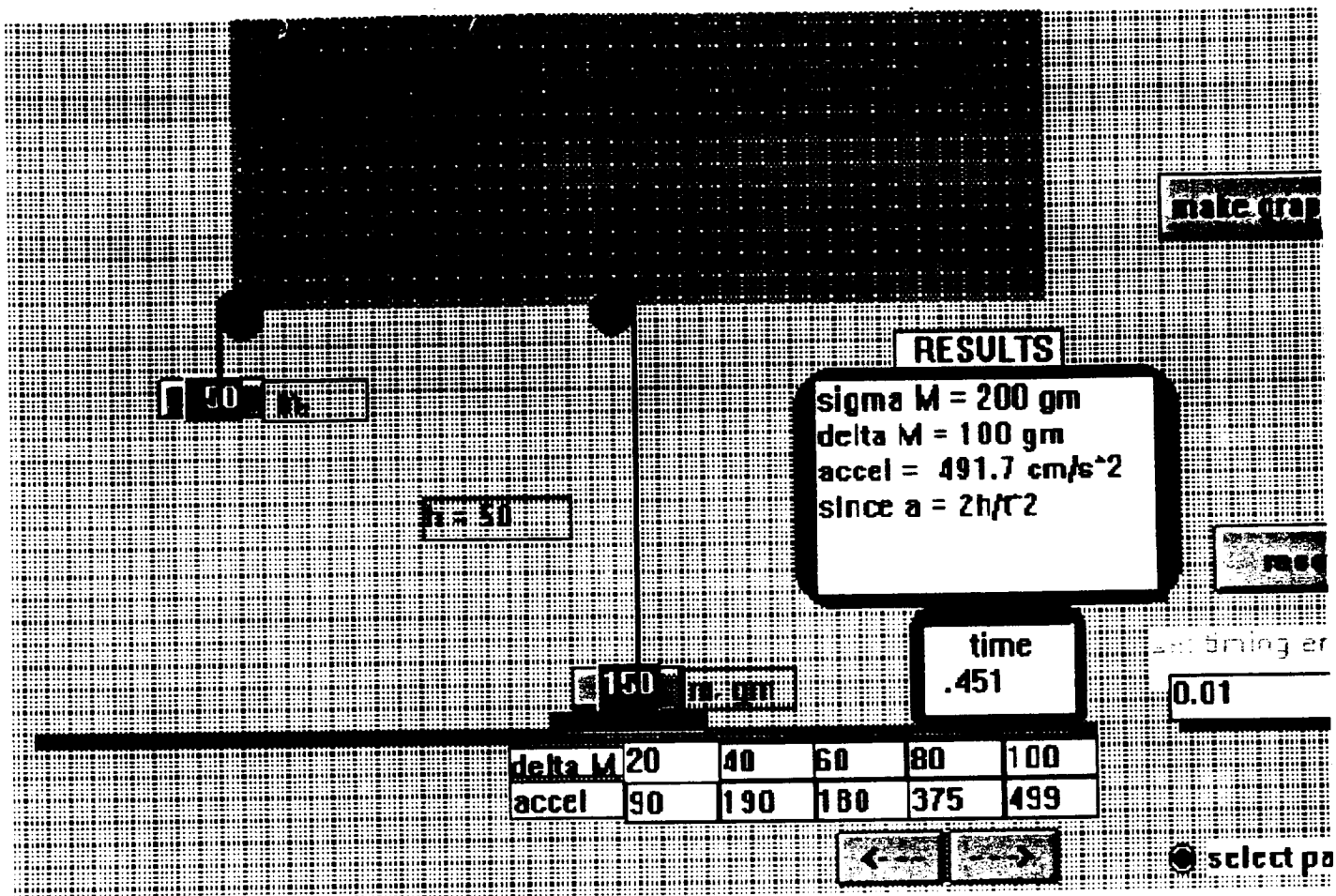

Figure 3b.

In Figure 3a above, we see the Atwood machine at the end of its stroke. The data windows now contain information pertaining to the elapsed time, as well as the calculated value of acceleration. A noteworthy feature is the ability of the student to introduce a random timing error, and thus to get differing (error laden) results each time he runs the experiment under ostensibly the same conditions.

3. Meteorology:

Cloud Formation

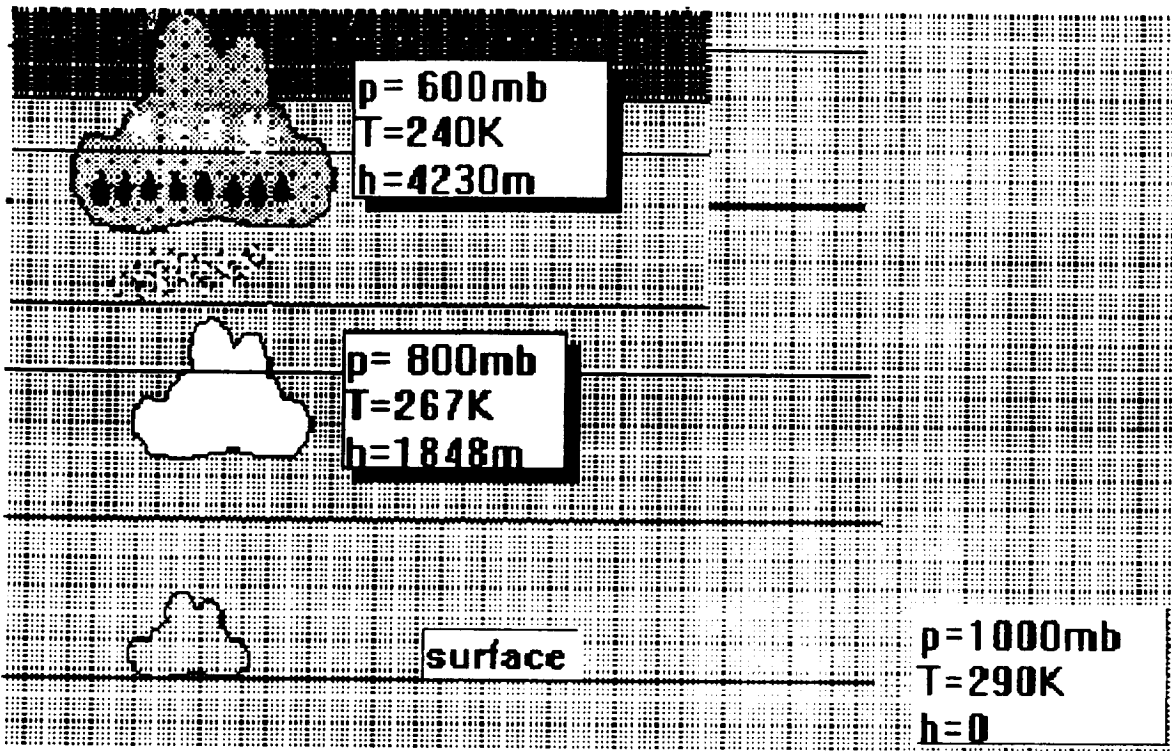

Figure 4.

Figure 3 shows a composite of three steps in an animation which demonstrates how an air mass expands and cools as it rises to a higher altitude and lower pressure level. The darkening of the air mass indicates the condensation of vapor to liquid, and finally precipitation is released as ice and water droplets form in the very dark cloud at the highest altitude.

Sea Breeze:

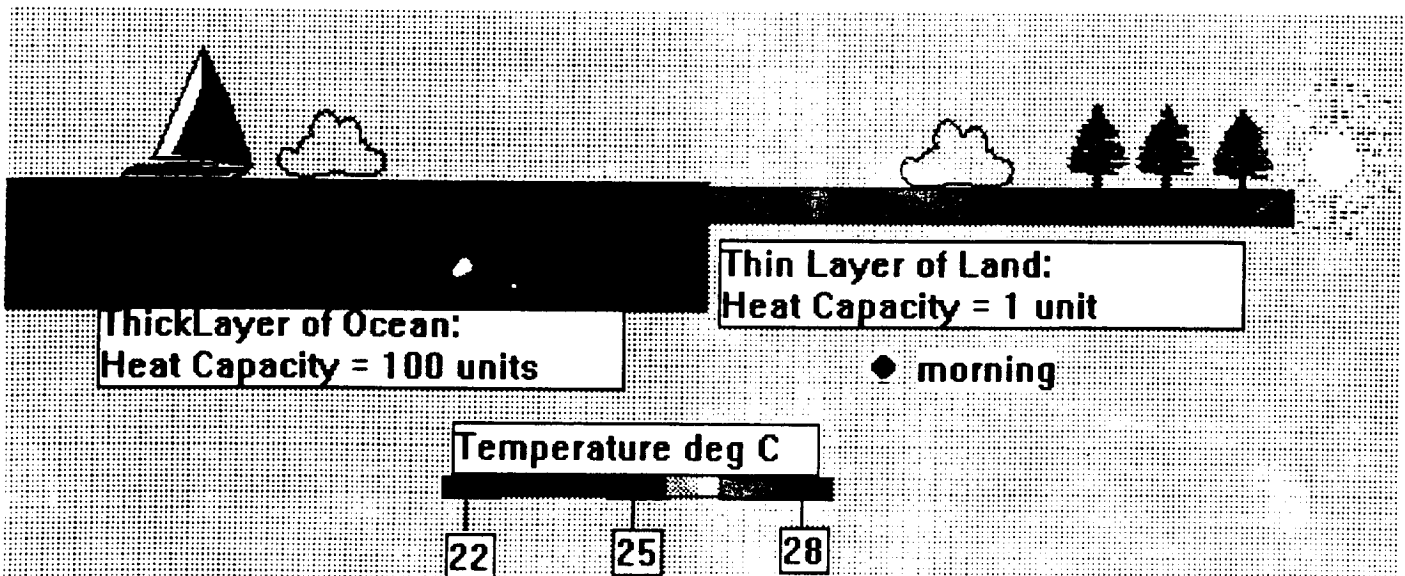

Figure 4.

Figure 4 shows a seascape, in which the temperature of the land and the water are each indicated by a color scale as indicated by the color bar near the bottom of the picture. The student is then invited to set the time of day to morning, where the sun is seen near the horizon on the right. At this particular point, the land and

the sea are all at the same temperature of 25C.

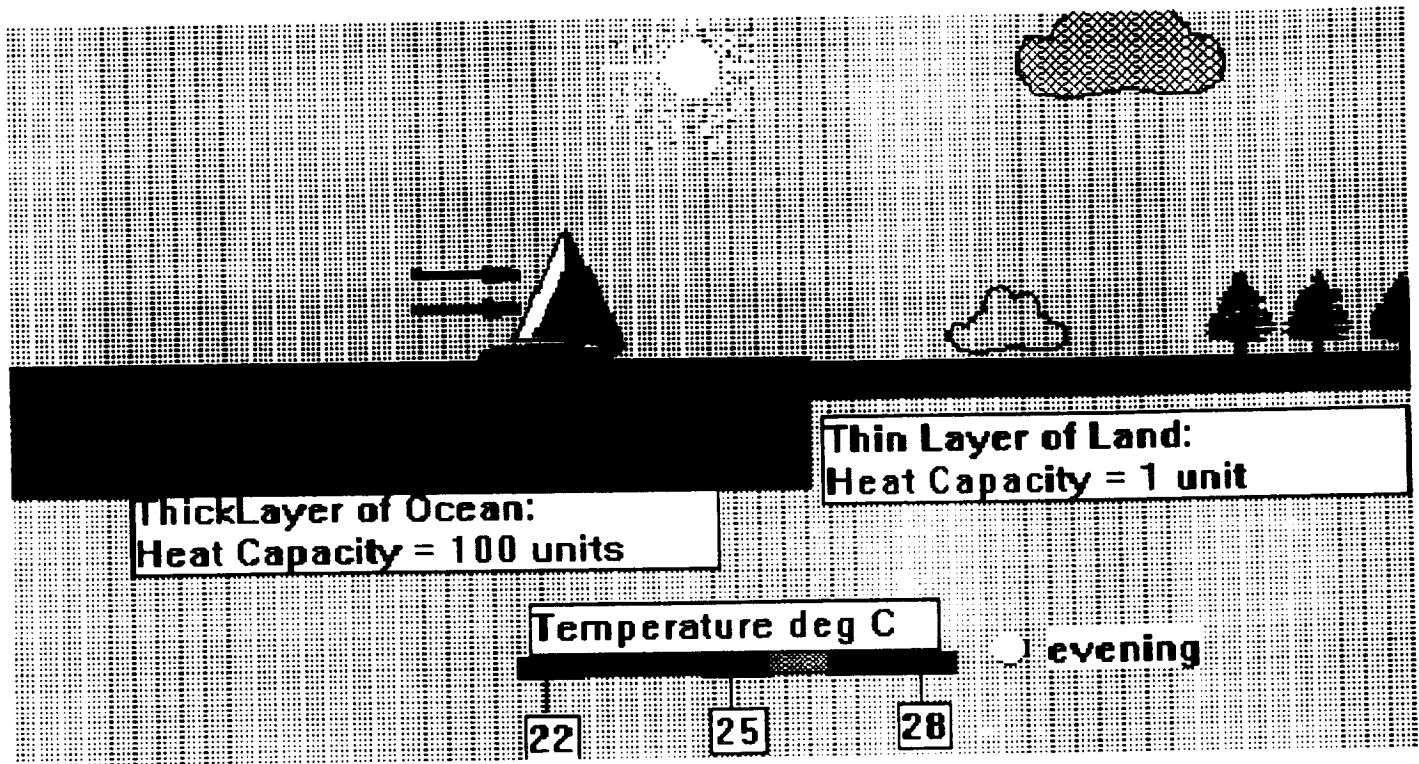

Figure 5.

The student is then invited to proceed to "afternoon", (figure 5) where an animation raises the sun in the sky, causes the land to warm, without any noticeable change to the water temperature. This is explained, as being due to the very different heat capacities of land and ocean.

As the land heats up, (Indicated by a changing color), the air above the land rises, and a monsoon type circulation pattern is initiated, whereby, a sea breeze results in wind blowing into the land from the ocean. This is further emphasized by the motion of the boat moving towards the land.

The student may then click on "evening", whereupon the sun moves across the sky to settle on the left horizon. As it does so, the land cools down, and the pattern described above reverses itself, resulting in a sinking of air over the land and an outward wind forming a land breeze. Once again the motion of the boat dramatizes this wind pattern.



[Return to the MU-SPIN Home Page](#)

**A NEW MODEL FOR THE DISSEMINATION OF
ONLINE TECHNICAL DOCUMENTATION AND
ITS IMPACT ON COURSEWARE**

George Wolberg

Department of Computer Science
City College of New York
New York, NY 10031
wolberg@cs-mail.engr.ccnyc.cuny.edu

OVERVIEW

- Project objectives
- Background
- Online technical documentation (OTD)
- New model for dissemination of OTD
- Markup languages: \LaTeX , HTML, troff, ...
- *i* \LaTeX
- Comparison of OTD tools
- Improc
- Discussion

PROJECT OBJECTIVES

- Integrate research results into courses and curricula
- Introduce interactive electronic notes
- Support hyperlinks, graphics, executable software
- Support all typesetting features of standard texts

PROPOSED WORK:

- Exploit rich text processing features of $\text{L}^{\text{A}}\text{T}_{\text{E}}\text{X}$
- Exploit hyperlinks, scripts, dynamic formatting, and plug-in features of Netscape
- Introduce *$\text{L}^{\text{A}}\text{T}_{\text{E}}\text{X}$* to merge both sets of features
- Demonstrate *$\text{L}^{\text{A}}\text{T}_{\text{E}}\text{X}$* as an effective authoring tool

BACKGROUND

- Introduction of Netscape's Navigator in 1995 played a major role in the explosive growth of the Internet.
- This effort was enhanced by earlier advent of HTML, a hypertext markup language that facilitates document-layout and hyperlink specification.
- Although the Internet was a product of the scientific community, the dissemination of technical documentation is not supported with the same robustness as non-technical documents.
- Current dissemination model: postscript/PDF files
- Cannot readily support applets, dynamic formatting, and user interaction

OTD TOOL REQUIREMENTS

Minimal OTD tools must support:

- formulas, tables, graphics
- user interaction and query processing
- simple run-time arithmetic/string processing
- applications on remote servers
- layout for multiple frames and arbitrary window sizes

OTD PRESENTATION

- HTML (under a browser)
- PDF (under Acrobat Reader)
- $i\text{L}^{\text{A}}\text{T}_{\text{E}}\text{X}$ (under $i\text{T}_{\text{E}}\text{X}$)
- other proprietary systems, e.g., AuthorWare, Interleaf

OTD PREPARATION

Markup languages:

- L^AT_EX
- troff

Word processors:

- MS Word
- Framemaker
- many others

WHY L^AT_EX IS THE PREFERRED PREPARATION LANGUAGE

- Majority of technical authors are familiar with L^AT_EX
- L^AT_EX is superior at typesetting mathematical formulas
- L^AT_EX is used more commonly than any other system
- L^AT_EX supports static (printed) documents
- L^AT_EX can be extended to support dynamic (interactive) documents
- L^AT_EX can be mapped into many presentation systems

WHAT IS L^AT_EX?

- L^AT_EX is a typesetting markup language
- L^AT_EX handles text justification, kerning, spacing, fonts
- L^AT_EX offers powerful equation and table formatting
- L^AT_EX consists of macros built on top of T_EX commands

```

\documentstyle[twocolumn,psfig]{ieeetran}

%-----
% LaTeX Document
%-----
\begin{document}

%-----
% Title
%-----
\title{Scattered Data Interpolation \linebreak With Multilevel B-Splines}

%-----
% Authors and Affiliations
%-----
\author{George Wolberg}
\maketitle

%-----
% Abstract
%-----
\begin{abstract}
This paper describes a fast algorithm for scattered data interpolation and
approximation. Multilevel B-splines are introduced to compute a  $C^2$ -
continuous surface through a set of irregularly spaced points. The algorithm
makes use of a coarse-to-fine hierarchy of control lattices to generate a
sequence of bicubic B-spline functions whose sum approaches the desired
interpolation function. Large performance gains are realized by using B-spline
refinement to reduce the sum of these functions into one equivalent B-spline
function. Experimental results demonstrate that high fidelity reconstruction is
possible from a selected set of sparse and irregular samples.
\end{abstract}

\section{INTRODUCTION}

Scattered data interpolation refers to the problem of fitting a smooth surface
through a scattered, or nonuniform, distribution of data samples. This subject
is of practical importance in many science and engineering fields, where data
is often measured or generated at sparse and irregular positions. The goal of
interpolation is to reconstruct an underlying function that may be evaluated
at any desired set of positions. This serves to smoothly propagate the
information associated with the scattered data onto all positions in the domain.

```

There are three principal sources of scattered data: measured values of physical quantities, experimental results, and computational values. They are found in diverse scientific and engineering applications. For example, nonuniform measurements of physical quantities are collected in geology, meteorology, oceanography, cartography, and mining; scattered experimental data is produced in chemistry, physics, and engineering; and nonuniformly spaced computational values arise in the output from finite element solutions of partial differential equations, and various applications in computer graphics and computer vision.

```
\section{B-SPLINE APPROXIMATION}
\label{sec:bsa}
```

Recently, a B-spline approximation technique has been proposed for image morphing \cite{lee95b,lee96b}. In this section, we elaborate on that technique in terms of scattered data interpolation and present the details of the algorithm.

```
\subsection{Basic Idea}
```

Let $\Omega = \{(x, y) \mid 0 \leq x < m, 0 \leq y < n\}$ be a rectangular domain in the xy -plane. Consider a set of scattered points $P = \{(x_c, y_c, z_c)\}$ in 3D space, where (x_c, y_c) is a point in Ω .

To approximate scattered data P , we formulate approximation function f as a uniform bicubic B-spline function, which is defined by a control lattice Φ overlaid on domain Ω . Without loss of generality, we assume that Φ is an $(m + 3) \times (n + 3)$ lattice which spans the integer grid in Ω (\Fig{lattice}). Later, we shall consider the effect of different lattice sizes on the approximation function.

```
\begin{figure}[htbp]
\centerline{\psfig{file=Fig1.eps}}
\caption{The configuration of control lattice  $\Phi$ .}
\label{fig:lattice}
\end{figure}
```

Let ϕ_{ij} be the value of the ij -th control point on lattice Φ , located at (i, j) for $i = -1, 0, \dots, (m+1)$ and $j = -1, 0, \dots, n+1$.

The approximation function f is defined in terms of these control points by

```
\begin{eqnarray}
f(x, y) &= & \sum_{k=0}^3 \sum_{l=0}^3 B_k(s) B_l(t) \phi_{(i+k)(j+l)},
\end{eqnarray}
\label{eq:bs}
```

```

\end{eqnarray}
where  $s_i = \lfloor x \rfloor - 1$ ,  $s_j = \lfloor y \rfloor - 1$ ,
 $s_s = x - \lfloor x \rfloor$ , and  $s_t = y - \lfloor y \rfloor$ .
 $B_k$  and  $B_l$  are uniform cubic B-spline basis functions
defined as

```

```

\begin{eqnarray*}
B_0(t) & = & (1 - t)^3 / 6, \\
B_1(t) & = & (3t^3 - 6t^2 + 4) / 6, \\
B_2(t) & = & (-3t^3 + 3t^2 + 3t + 1) / 6, \\
B_3(t) & = & t^3 / 6,

```

```

\end{eqnarray*}

```

where $0 \leq t < 1$.

They serve to weigh the contribution of each control point to $f(x, y)$ based on its distance to (x, y) .

With this formulation, the problem of deriving function f is reduced to solving for the control points in Φ that best approximate the scattered data in SP .

To determine the unknown control lattice Φ , we first consider one data point (x_c, y_c, z_c) in SP . From \Eq{bs}, we know that function value $f(x_c, y_c)$ relates to the sixteen control points in the neighborhood of (x_c, y_c) . Without loss of generality, we may assume that $1 \leq x_c, y_c < 2$. Then, control points ϕ_{kl} , for $k, l = 0, 1, 2, 3$, determine the value of f at (x_c, y_c) . For function f to take on the value z_c at (x_c, y_c) , the control points ϕ_{kl} must satisfy

```

\begin{eqnarray}
z_c & = & \sum_{k=0}^3 \sum_{l=0}^3 w_{kl} \phi_{kl}, \\
\label{eq:one}
\end{eqnarray}

```

```

\end{document}

```

Scattered Data Interpolation With Multilevel B-Splines

George Wolberg

Abstract—This paper describes a fast algorithm for scattered data interpolation and approximation. Multilevel B-splines are introduced to compute a C^2 -continuous surface through a set of irregularly spaced points. The algorithm makes use of a coarse-to-fine hierarchy of control lattices to generate a sequence of bicubic B-spline functions whose sum approaches the desired interpolation function. Large performance gains are realized by using B-spline refinement to reduce the sum of these functions into one equivalent B-spline function. Experimental results demonstrate that high fidelity reconstruction is possible from a selected set of sparse and irregular samples.

I. INTRODUCTION

Scattered data interpolation refers to the problem of fitting a smooth surface through a scattered, or nonuniform, distribution of data samples. This subject is of practical importance in many science and engineering fields, where data is often measured or generated at sparse and irregular positions. The goal of interpolation is to reconstruct an underlying function (e.g., surface) that may be evaluated at any desired set of positions. This serves to smoothly propagate the information associated with the scattered data onto all positions in the domain.

There are three principal sources of scattered data: measured values of physical quantities, experimental results, and computational values. They are found in diverse scientific and engineering applications. For example, nonuniform measurements of physical quantities are collected in geology, meteorology, oceanography, cartography, and mining; scattered experimental data is produced in chemistry, physics, and engineering; and nonuniformly spaced computational values arise in the output from finite element solutions of partial differential equations, and various applications in computer graphics and computer vision.

II. B-SPLINE APPROXIMATION

Recently, a B-spline approximation technique has been proposed for image morphing [?], [?]. In this section, we elaborate on that technique in terms of scattered data interpolation and present the details of the algorithm.

A. Basic Idea

Let $\Omega = \{(x, y) | 0 \leq x < m, 0 \leq y < n\}$ be a rectangular domain in the xy -plane. Consider a set of scattered points $P = \{(x_c, y_c, z_c)\}$ in 3D space, where (x_c, y_c) is a point in Ω . To approximate scattered data P , we formulate approximation function f as a uniform bicubic B-spline function, which is defined by a control lattice Φ overlaid on domain Ω . Without loss of generality, we assume that Φ is an $(m+3) \times (n+3)$ lattice which spans the integer grid in

Ω (Fig. 1). Later, we shall consider the effect of different lattice sizes on the approximation function.

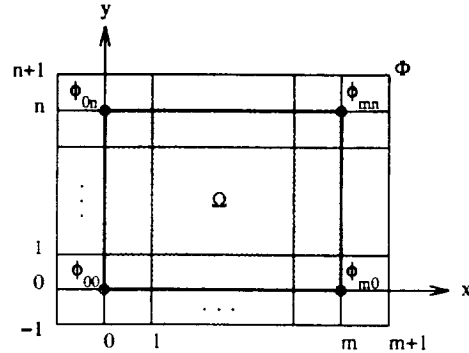

Fig. 1. The configuration of control lattice Φ .

Let ϕ_{ij} be the value of the ij -th control point on lattice Φ , located at (i, j) for $i = -1, 0, \dots, m+1$ and $j = -1, 0, \dots, n+1$. The approximation function f is defined in terms of these control points by

$$f(x, y) = \sum_{k=0}^3 \sum_{l=0}^3 B_k(s) B_l(t) \phi_{(i+k)(j+l)}, \quad (1)$$

where $i = \lfloor x \rfloor - 1$, $j = \lfloor y \rfloor - 1$, $s = x - \lfloor x \rfloor$, and $t = y - \lfloor y \rfloor$. B_k and B_l are uniform cubic B-spline basis functions defined as

$$\begin{aligned} B_0(t) &= (1-t)^3/6, \\ B_1(t) &= (3t^3 - 6t^2 + 4)/6, \\ B_2(t) &= (-3t^3 + 3t^2 + 3t + 1)/6, \\ B_3(t) &= t^3/6, \end{aligned}$$

where $0 \leq t < 1$. They serve to weigh the contribution of each control point to $f(x, y)$ based on its distance to (x, y) . With this formulation, the problem of deriving function f is reduced to solving for the control points in Φ that best approximate the scattered data in P .

To determine the unknown control lattice Φ , we first consider one data point (x_c, y_c, z_c) in P . From Eq. (1), we know that function value $f(x_c, y_c)$ relates to the sixteen control points in the neighborhood of (x_c, y_c) . Without loss of generality, we may assume that $1 \leq x_c, y_c < 2$. Then, control points ϕ_{kl} , for $k, l = 0, 1, 2, 3$, determine the value of f at (x_c, y_c) . For function f to take on the value z_c at (x_c, y_c) , the control points ϕ_{kl} must satisfy

$$z_c = \sum_{k=0}^3 \sum_{l=0}^3 w_{kl} \phi_{kl},$$

WHAT IS T_EX?

- T_EX is a document formatting system created by Donald Knuth (1979-1982)
- T_EX-3.0 (updated version) was released in 1990
- T_EX facilitates customized typesetting systems, e.g., formats, macro packages
- Common systems include:
 - Plain T_EX (D. Knuth)
 - L^AT_EX (L. Lamport)
 - AmS_T_EX (M. Spivak)

L^AT_EX is the most “structured” dialect of T_EX. It accounts for the majority of T_EX users.

$\text{L}^{\text{A}}\text{T}_{\text{E}}\text{X} \rightarrow \text{OTD PRESENTATION}$

- $\text{L}^{\text{A}}\text{T}_{\text{E}}\text{X}2\text{HTML}$ (Drakos) — perl Script.
- $\text{T}_{\text{E}}\text{X}$ pider (MicroPress) — modified $\text{T}_{\text{E}}\text{X}$ compiler.
- $\text{T}_{\text{E}}\text{X}$, DVIPS, followed by Distiller (Adobe).
- $\text{T}_{\text{E}}\text{X}$, followed by PDF driver (MicroPress).

WHAT ARE *i*TEX AND *i*LAT_EX?

The *i* in *i*TEX and *i*LAT_EX stands for “interactive.”

*i*TEX is a re-entrant version of TEX. In brief:

- TEX runs on a single document. *i*TEX is re-entrant, i.e., it can process multiple documents in sequence or in parallel.
- Unlike TEX which is just a batch processor, *i*TEX is an interactive browser, permitting immediate previewing of the document (just like NetScape).
- *i*TEX formats documents for previewing in arbitrary window sizes.
- TEX macro facilities enable more sophisticated formatting than HTML can achieve.

- $i\text{T}_{\text{E}}\text{X}$ supports interactive controls, including *user-defined controls*. $i\text{T}_{\text{E}}\text{X}$ can read the controls and act on them.

Presentation systems can be built on top of other $\text{T}_{\text{E}}\text{X}$ formats.

Due to the popularity of $\text{L}^{\text{A}}\text{T}_{\text{E}}\text{X}$ our assumption is that $i\text{L}^{\text{A}}\text{T}_{\text{E}}\text{X}$ will be the preferred format.

FEATURE COMPARISON

Feature	HTML	PDF	<i>i</i>TeX	Notes
Page formatting	DYNAMIC	STATIC	BOTH	(1)
Scripting language	YES	NO	YES	(2)
Formula preview	NO	YES	YES	(3)
Advanced formatting	NO	YES	YES	(4)
Graphics insertion	YES	YES	YES	
Extensibility	YES	LIMITED	YES	(5)
Interaction	YES	LIMITED	YES	(6)
Multi-frame	YES	LIMITED	YES	

FEATURE COMPARISON NOTES

1. Dynamic formatting is essential for displaying on small screens (≤ 15 in.), or in multi-frame layouts. *i*TeX supports static or dynamic (default) formatting
2. Scripting languages for HTML include Java and JavaScript. TeX can be used as a scripting language in *i*TeX. Eventually, Java code will be supported as well.
3. In HTML, formulas can be displayed as embedded graphics. This leads to low quality, massive data transfer, and bad formatting of in-line formulas.
4. The PDF formatting is only as good as the program that was used to create the PDF file. The HTML formatting is very rudimentary.
5. HTML extensibility comes from the NetScape plug-in facility. A similar facility will be developed for *i*TeX.
6. Interaction in PDF is effectively limited to annotation.

SUMMARY

The proposed work on *iL_AT_EX* will:

- Exploit rich text processing features of L_AT_EX
- Exploit hyperlinks, scripts, dynamic formatting, and plug-in features of Netscape
- Merge both sets of features
- Demonstrate *iL_AT_EX* as an effective authoring tool
- Furnish image processing courseware and *iL_AT_EX* browser

Networking Break-out Session - Day 1

*Ms. Mona Absalon
Bowie State University*

*Mr. Darnley Archer
Elizabeth City State University*

*Mr. Carl Taylor
Prairie View A&M University*

Mr. Darnley Archer

Elizabeth City State University
NRTS Network Manager

Affordable Technology for K-12 Schools: Caching Technology

Vision Statement

The purpose of this research is to come up with a way of reducing the network traffic while giving the K-12 arena an opportunity to have an affordable network solution.

Goal and Objective

- Give user a higher data transfer rate
- Reduce the overall Internet traffic
- Make the Internet affordable to our K-12 schools
- Recover lost search time in the classroom

Today's Situation

- Waiting a long time for data retrieval
- Most K-12 schools can not afford the network infrastructure needed to teach using the Internet in their classes
- Some K-12 schools with Internet access could spend entire class periods on one search

How Did We Get Here?

- In 1969, the federal government came out with the Internet, with sending the first electronic mail message.
- The government saw the Internet as a way of educating our society, by giving them educational, social and business information electronically.

How Did We Get Here?

- Electronic mail became the number one source of communication
- There is more than 100,000 networks with over 4,000,000 hosts in almost every country.

Available Options

- Put strict guide lines on Internet use
 - » Advantages
 - Reduce network traffic during peak times
 - Give the educational arena faster access
 - » Disadvantages
 - Unfair to home business or/and educators
 - No way of determining all business links

Available Options

- Government provide all schools with needed bandwidth
 - » Advantages
 - Faster data retrieval at the school level
 - Increase the speed for classroom searches
 - » Disadvantages
 - High cost to the government, cost to tax payers
 - Pipe for the Internet will have to be increased

Available Options

- **Caching**
 - » **Advantages**
 - Reduce overall network traffic
 - Faster data retrieval
 - Benefits all
 - Overall low cost

Available Options

- Caching
 - » Disadvantages
 - Slow performances
 - Not everything can be cached
 - Lack of caching knowledge

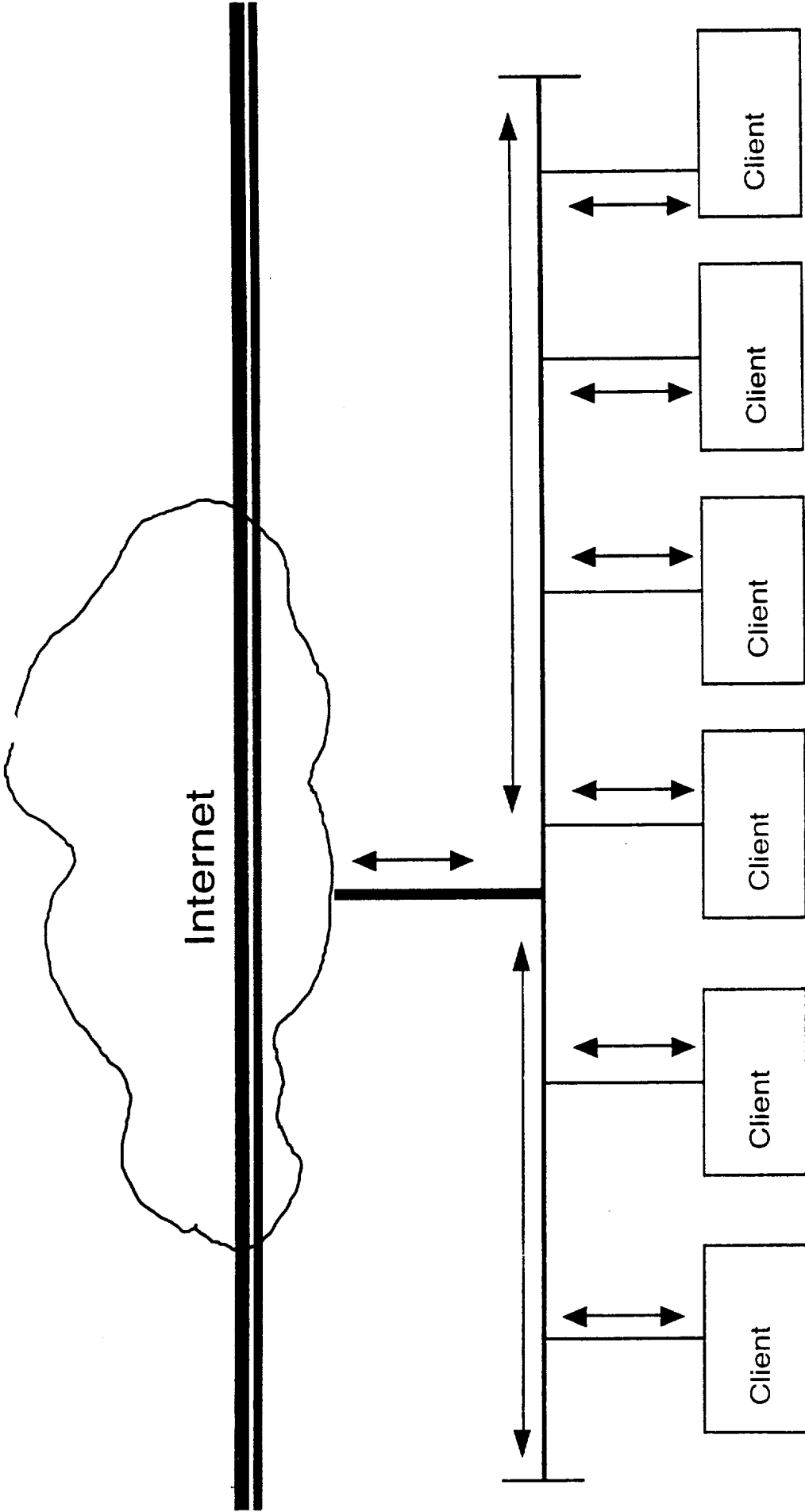

Existing in many areas

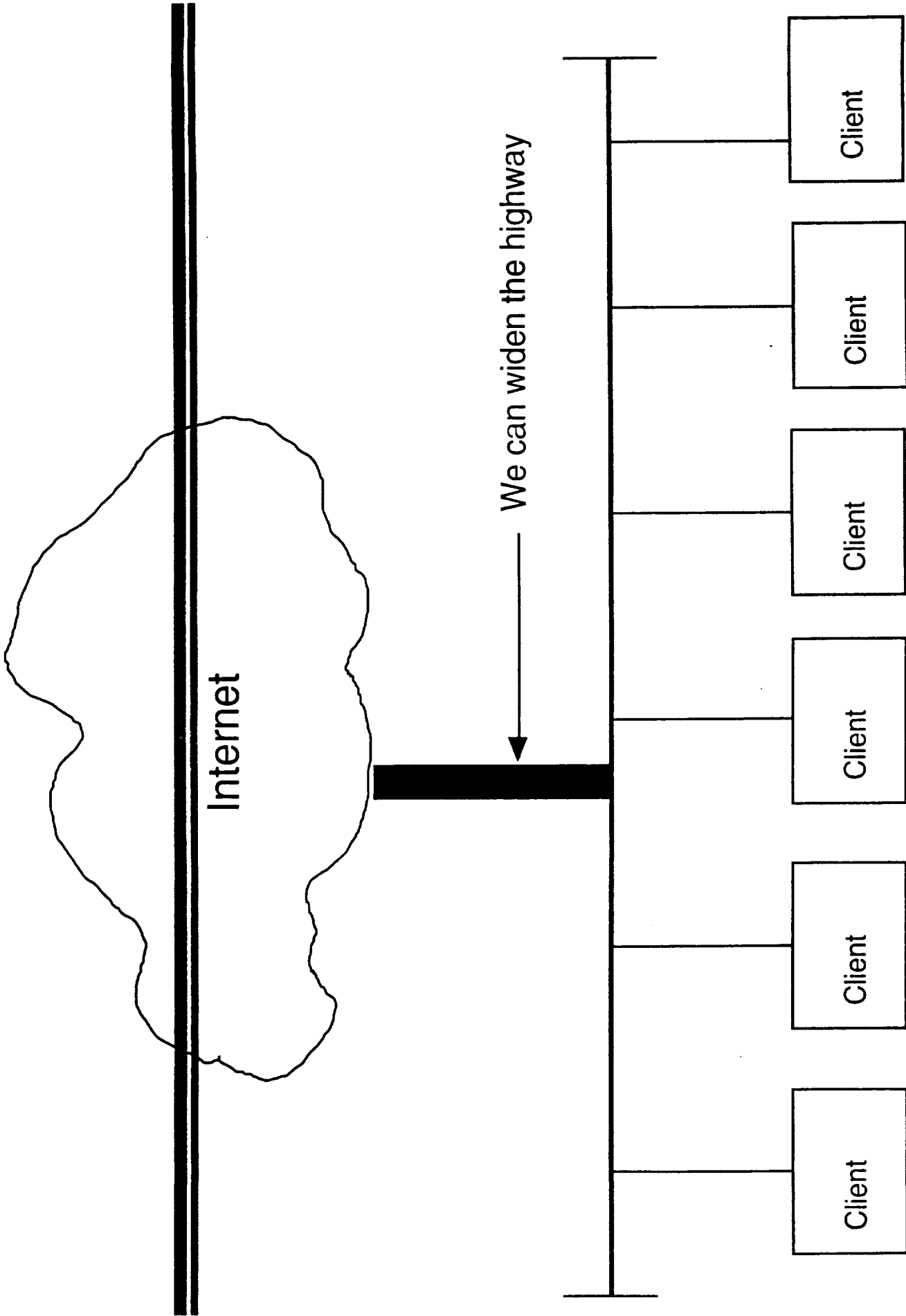

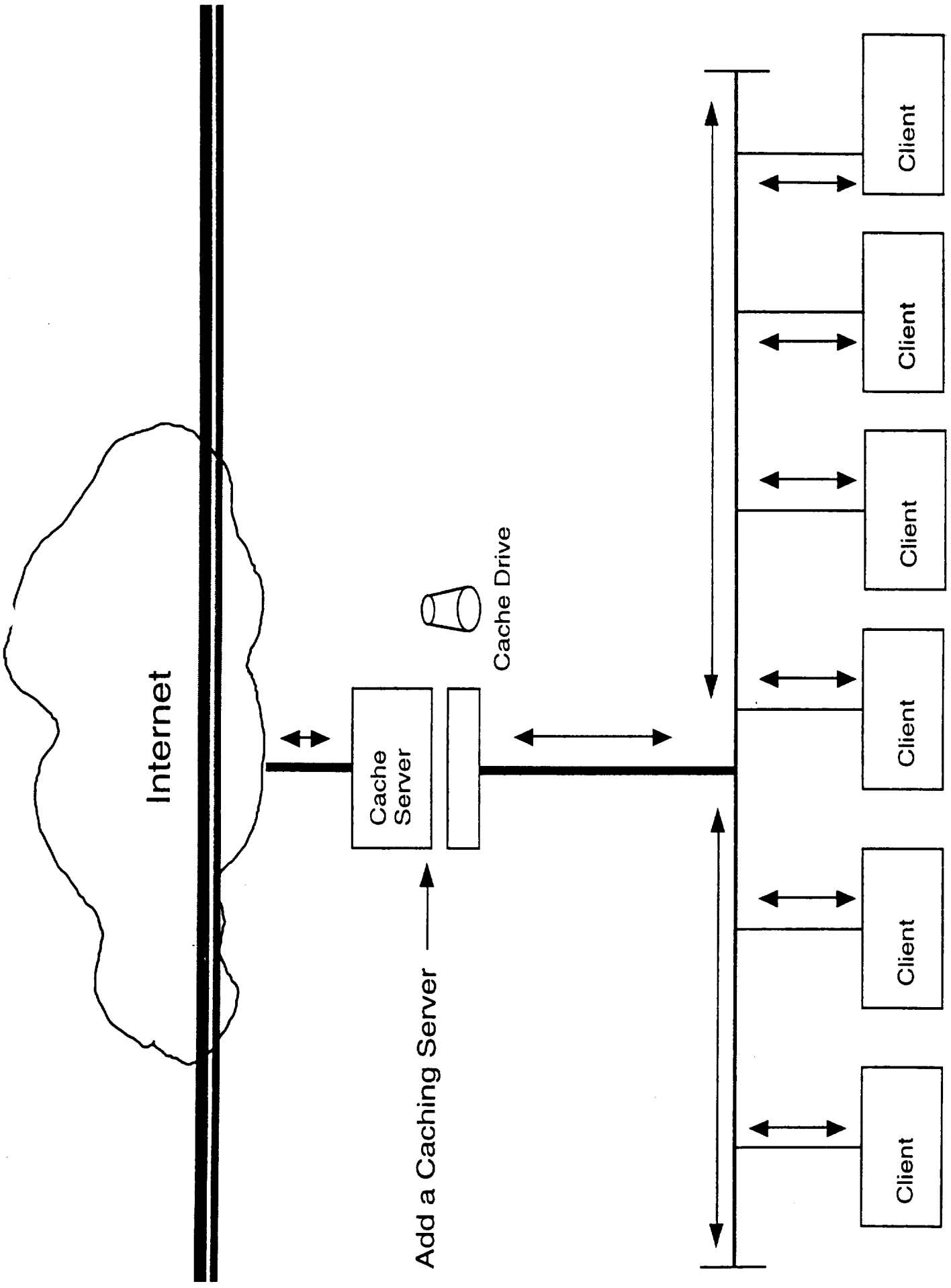

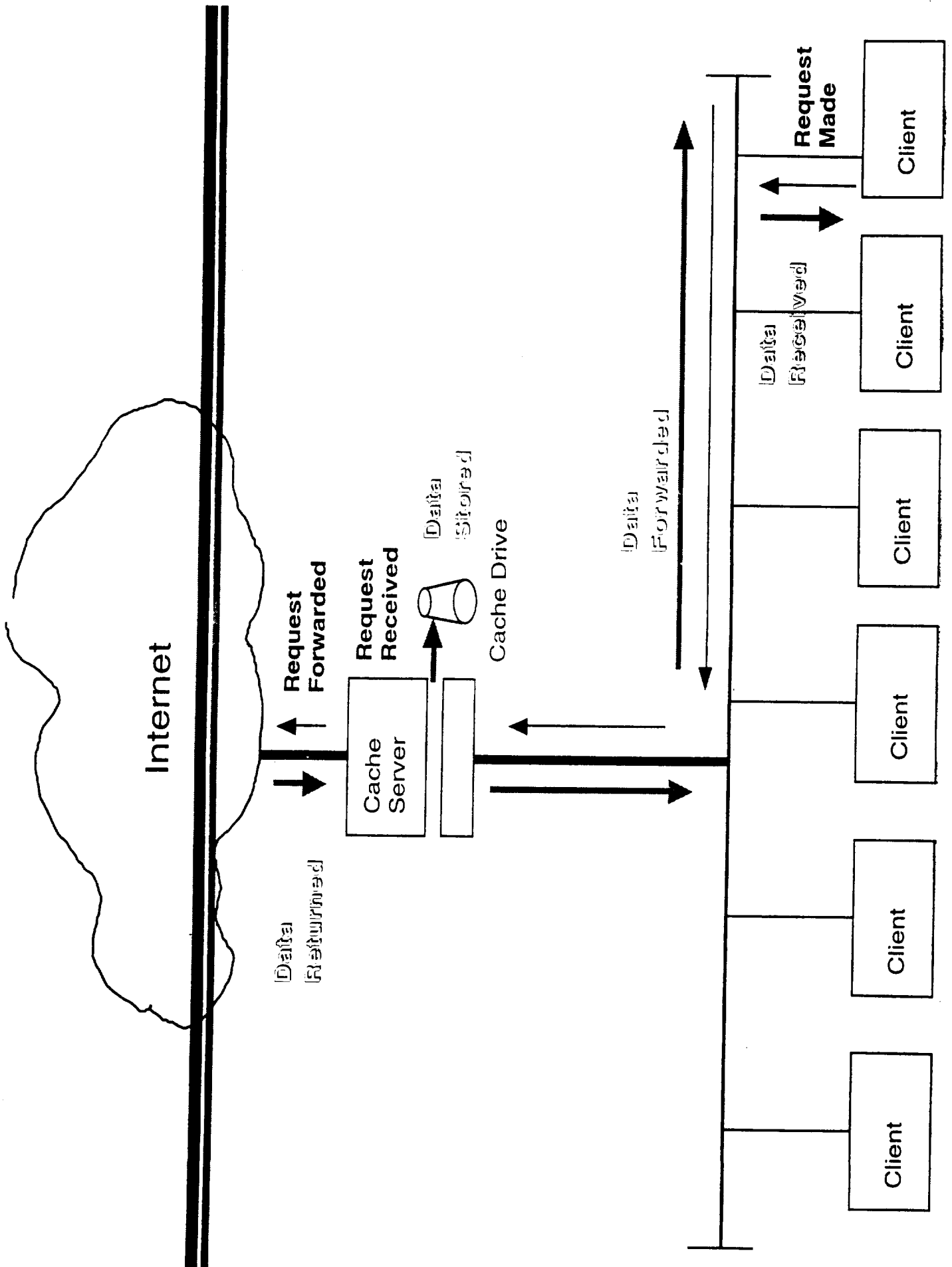

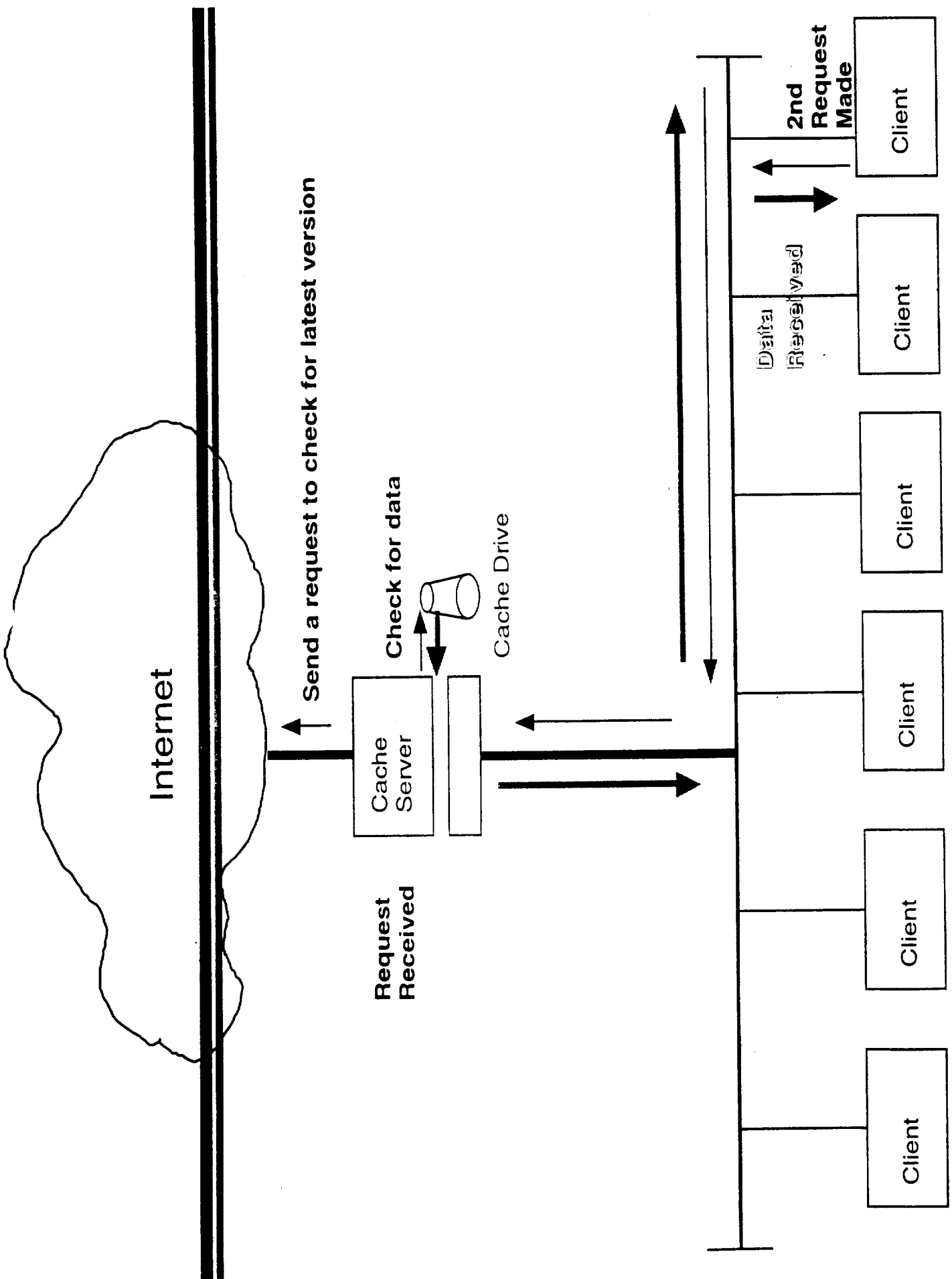

**Pre-College MSET Education Programs
Break-out Session - Day 1**

*Dr. Marino Alvarez
Tennessee State University*

*Ms. Barbara Helland
Krell Institute*

*Dr. Beverly Lynds
University Corporation for Atmospheric Research*

**Explorers of the Universe:
Metacognitive Tools for Learning Science Concepts**

Marino C. Alvarez
Tennessee State University

**Paper presented at the Minority University - Space Interdisciplinary Network (MU-SPIN)
Seventh Annual Users' Conference, City of New York, New York, New York, October, 1997.**

Explorers of the Universe: Metacognitive Tools for Learning Science Concepts

Much school learning consists of rote memorization of facts with little emphasis on meaningful interpretations. For example, students are often asked to solve scientific problems and conduct laboratory experiments in a rote rather than in a meaningful way (Novak, 1988, 1990). Often science knowledge is assumed to be absolute and students are viewed as passive recipients of information (Driver & Oldham, 1986). In such instances, reading assignments are given, lessons are reviewed, and question-answering is equated with producing "right" answers. Under these circumstances, knowledge construction is reduced to factual knowledge production with little regard for critical thinking, problem solving, or clarifying misconceptions.

Texts are often written to support acquisition of factual knowledge. The language of the textbook or laboratory manual is often vague with ill-defined concepts or with lists of facts that are not situated in a context that encourages students to relate new concepts to their prior knowledge. Seldom are these facts and ideas related to students' everyday experiences or to other disciplines (Donham, 1949; Erickson, 1984; Eylon & Linn, 1988; Sarason, 1990; Schwab, 1976). Further, Novak, Gowin, and Johansen (1983) show that students lack or misconstrue links between text concepts resulting in a failure to assimilate and accommodate new knowledge in their cognitive structure.

It seems that an important role of a middle and secondary teacher when teaching science is to aid students' ability to reflect upon what they know about a given topic and make available strategies that will enhance their conceptual understanding of text and science experiments. Developing metacognition, the ability to monitor one's own knowledge about a topic of study and to activate appropriate strategies, enhances students' learning when faced with reading, writing, and problem solving situations (see Baker & Brown, 1984). Two instructional strategies that can involve students in developing metacognitive awareness are hierarchical concept mapping (Novak & Gowin, 1984) and Vee diagrams (Gowin, 1981).

This paper describes the Explorers of the Universe Scientific/Literacy project and discusses the effectiveness of using hierarchical concept maps and Vee diagrams to aid students in comprehending and learning science concepts meaningfully. Concept maps enable students to organize their ideas and reveal visually these ideas to others. A Vee diagram is a structured, visual means of relating the methodological aspects of an activity to its underlying conceptual aspects in ways that aid learners in meaningful understanding of scientific investigations.

Explorers of the Universe

An interdisciplinary project that engages teachers and their students in thinking about learning using technology is the Explorers of the Universe Scientific/Literacy project (<http://coe2.tsuniv.edu/explorers>). This project is designed to encourage *communities of thinkers* to evolve due to the unique nature of the processes involved in analyzing and reporting data received from variable stars that teachers and students investigate by remotely controlled automatic photoelectric telescopes (Alvarez, 1995). These telescopes are housed at the Fairborn

Observatory in Washington Camp, Arizona and controlled by astronomers at Tennessee State University in Nashville via the Internet.

Students conduct self-directed case-based investigations that require them to utilize concept maps and vee diagrams to plan and carry out their research and findings. They also collaborate with students at other high schools and electronically communicate with astronomers and university educators. Students analyze data received from the automatic photoelectric telescopes and apply mathematic and scientific principles during this process of evaluation. During their investigation of the stars, students are encouraged to incorporate their research with related information from other subject disciplines. For example, several students have included literature into their case study and have researched how Greek and Arabic mythology were influenced from studying the stars. Once completed, students publish their findings on the Net and receive feedback from faceless and unknown persons throughout the world (Alvarez, 1996a).

Students are both consumers and producers of the Net in this project. During this process students access various Internet sites and critically analyze the reliability of the information and its source when formulating their case and writing their paper. As their paper takes form they also include links to other data sources on the Net and/or to related student papers of their classmates. Teachers and students in these projects are becoming communities of thinkers (see Alvarez 1996b, 1997). Communities in the sense that the school classroom becomes a place where ideas are shared through interactive learning environments in an atmosphere of coming to know through understanding and discussion.

In these kinds of learning environments, teachers think about their subject in ways to promote and invite students to participate by offering lessons and assignments that require critical thinking (thinking about thinking in ways to bring about change in one's experience) and imaginative thinking (exploring future possibilities with existing ideas) rather than emphasizing rote memorization of facts. Developing a community of thinkers focuses on the kinds of thought processes needed by the teacher and students to achieve learning outcomes. *Thinking of ways to achieve learning outcomes is different from focusing on ways that learning outcomes can be achieved* (Alvarez, 1996b). The former is process oriented; the latter product oriented. When teachers and administrators focus on ways that students need to achieve prescribed outcomes then the thought processes become product oriented. In contrast, when teachers and administrators focus on ways that students can learn this same type of product outcomes in ways that involve them to think about problem-oriented tasks and assignments that actively engage them in mutual discussions with the teacher, peers, and others, then the process becomes multifaceted, meaningful, and negotiable.

Vee Diagram

The Vee heuristic was developed by Gowin (1981) to enable students to understand the structure of knowledge (e.g., relational networks, hierarchies, combinations) and to understand the process of knowledge construction. Gowin's fundamental assumption is that knowledge is not absolute, but rather it is dependent upon the concepts, theories, and methodologies by which we view the world. To learn meaningfully, individuals must choose to relate new knowledge to

relevant concepts and propositions they already know. The Vee diagram aids students in this linking process by acting as a metacognitive tool that requires students to make explicit connections between previously learned and newly acquired information.¹

The Vee diagram separates theoretical/conceptual (thinking) on the left from the methodological (doing) elements of inquiry on the right. Both sides actively interact with each other through the use of the *focus or research question(s)* that directly relates to events and/or objects. Epistemic elements are arrayed around the Vee diagram, and represent units that form the structure of some segment or portion of knowledge required to construct a new meaning or piece of knowledge.

The conceptual side includes *philosophy, theory, principles/conceptual systems, and concepts* all of which are related to each other and to the *events and/or objects*. On the methodological side of the Vee, *records* of these events/objects are *transformed* into graphs, charts, tables, transcriptions of audio or videotapes, and so forth and become the basis for making *knowledge and value claims*.

The *Interactive Vee Diagram* has been developed to aid students and teachers affiliated with our project to plan, carry out, and finalize their research investigations. Teachers and students have restricted access to this Interactive Vee Diagram appearing on the Internet that allows each to have their own password. Confidentiality is important for both teachers and students during the course of their investigation. However, students can share their Vees with teachers, other students, university educators, and astronomers for feedback by giving their password to those persons whom they wish to interact. This collaborative process allows ideas to be shared and negotiated during the various phases of their inquiry. Revisions of the Vee are important for students to “think” and actively “participate” in their study. Information electronically submitted over the Internet on each Interactive Vee is captured on a data base for analysis at the Explorers of the Universe base of operations in the Center of Excellence in Information Systems at Tennessee State University.

Concept Maps

The hierarchical concept map enables learners to plan and share their ideas with their teacher and peers, and accompanies their vee diagram. The map serves as a visual tool to clarify ambiguities, resolve discrepancies, and engage in reflective thinking. It also serves as a template from which to write case reports. Members of the team use concept maps as a negotiation instrument with other interested members of the class or affiliated school. The teacher becomes aware of their approach to conceptual analysis by visually examining their conceptual and propositional relationships portrayed on the map. In so doing, the teacher is able to mediate the process and product of student engagement with the topic under study (see Alvarez & Alvarez, 1995).

¹See our website under the headings of either Overview or Index for Metacognitive Tools for examples of vee diagrams: <http://coe2.tsuniv.edu/explorers>.

Concept maps also aid students in reflecting and rethinking their ideas. For example, three students who were members of a team had several serious discussions on how the map should be arranged regarding the incorporation of astronomy and its role in literature. They revised their map several times to depict relationships between Algol and its interpretation in Greek and Arabic mythology. This map provided the conceptual framework to structure their thoughts and write their paper.

Using vee diagrams and concept maps to mediate learning paradigms between astronomers, teachers, university educators, and students serve to better inform the research practices in the variable star component of the Explorers of the Universe Project. These teachers are better informed about what practicing astronomers are observing and together with their students are communicating with these astronomers using e-mail, interactive video communication, and by sharing concept maps and vee diagrams of their investigative work.

Conclusion

Metacognitive tools such as hierarchical concept maps and vee diagrams actively engage students to think about what they are learning with print, electronic texts, and data gathered from automatic photoelectric telescopes. These tools provide students with a venue to display visually their ideas and serve as instruments to become involved in a forum that encourages self-reflection and rethinking of facts and ideas. Knowledge paradigms of scientists, teachers, and students are mediated through meaningful materials, metacognitive tools, and an emergent curriculum that encourages question-asking, question-seeking, introspection, and shared meanings in sociocultural contexts.

These metacognitive tools aid students in their research and the writing of their papers. Their published papers on the World Wide Web tell stories about the research they are doing and the ideas to be shared. They write their stories based on the facts and ideas that are being received from their study of the stars. Their experiences, both cognitive and affective, play an active role in this thinking/learning process. It is within their process of imaginative and critical thinking that moves them into the realm of meaningful learning. This environment is crucial in stimulating a desire within students to become self-empowered and in charge of their own well-being.

Social interactions are occurring among members of our project in communal ways that new information is incorporated (integrated and related to other knowledge sources in memory) rather than compartmentalized (isolated due to rote memorization). In this setting, teachers are thinking and learning more about their subject and encouraging critical and imaginative thinking by providing their students with problem-solving lessons in meaningful learning contexts. This notion is consistent with Ausubel's (1968) theory of learning, Gowin's (1981) theory of educating, Novak's (1977) theory of education and knowledge, and Gragg's (1940) warning that "wisdom can't be told."

Acknowledgements

This paper is supported by the Tennessee State University Center of Excellence in Information Systems - Astrophysics Component, and NASA through the Tennessee Space Grant Consortium NGT 5-40054.

References

- Alvarez, M.C. (1997). Communities of thinkers: Investigating interactive scientific literacy environments. In J. Willis, J.D. Price, S. McNeil, B. Robin, & D.A. Willis (Eds.), *Technology and Teacher Education Annual, 1977* (Vol. II, pp. 1236-123). Eighth International Conference of the Society for Information Technology and Teacher Education (SITE). Charlottesville, VA: Association for the Advancement of Computing in Education (AACE).
- Alvarez, M.C. (1996a). Explorers of the Universe: Students using the world wide web to improve their reading and writing. In B. Neate (Ed.), *Literacy saves lives* (pp. 140-145). Winchester, England: United Kingdom Reading Association.
- Alvarez, M.C. (1996b). A Community of thinkers: Literacy environments with Interactive technology. In K. Camperell, B.L. Hayes, & R. Telfer (Eds.), *Literacy: The information highway to success* (pp. 17-29). American Reading Forum, vol. 16. Logan, UT: Utah State University.
- Alvarez, M.C. (1995). Explorers of the universe: An action research scientific literacy project. In K. Camperell, B.L. Hayes, & R. Telfer (Eds.), *Linking literacy: Past, present, and future* (pp. 55-62). American Reading Forum, vol. 15.
- Alvarez, M.C., & Rodriguez, W.J. (1995). Explorers of the Universe: A pilot study. In W.M. Linek & E.G. Sturtevant (Eds.), *Generations of literacy* (pp. 221-236). College Reading Association.
- Ausubel, D.P. (1968). *Educational psychology: A cognitive view*. New York: Holt, Rinehart, and Winston.
- Baker, L., & Brown, A.L. (1984). Metacognitive skills and reading. In P.D. Pearson (Ed.), *Handbook of reading research* (pp. 353-394). New York: Longman.
- Donham, W.B. (1949). Why experiment? The case system in college teaching of science. *Journal of General Education*, 3, (January 1949), 145-156.
- Driver, R., & Oldham, V. (1986). A constructivist approach to curriculum development in science. *Studies in Science Education*, 13, 105-122.
- Erickson, F. (1984). School literacy, reasoning, and civility: An anthropologist's perspective. *Review of Educational Research*, 54, 525-546.

Eylon, B., & Linn, M.C. (1988). Learning and instruction: An examination of four research perspectives in science education. *Review of Educational Research*, 58, 251-301.

Gowin, D.B. (1981). *Educating*. Ithaca, NY: Cornell University Press.

Gragg, C.I. (1940). Because wisdom can't be told. *Harvard Alumni Bulletin*, 43, 78-84.

Novak, J.D. (1990). Concept maps and vee diagrams: Two metacognitive tools to facilitate meaningful learning. *Instructional Science*, 19, 29-52.

Novak, J.D. (1988). Learning science and the science of learning. *Studies in Science Education*, 15, 77-101.

Novak, J.D. (1977). *A theory of education*. Ithaca, NY: Cornell University Press.

Novak, J.D., & Gowin, D.B. (1984). *Learning how to learn*. New York: Cambridge University Press.

Novak, J.D., Gowin, D.B. & Johansen, G.T. (1983). The use of concept mapping and knowledge vee mapping with junior high school science students. *Science Education*, 67, 625-645.

Sarason, S.B. (1990). *The predictable failure of educational reform*. San Francisco: Jossey-Bass Publications.

Schwab, J.J. (1976). Education and the state: Learning community. In R.M. Hutchins & M.J. Adler (Eds.), *The great ideas today* (pp. 234-272). Chicago: Encyclopedia Britannica, Inc.

AiS

**Adventures in Supercomputing:
Integrating Mathematics, Science
and
Technology in Precollege
Classrooms**

**funded by the Department of
Energy**

<http://www.krellinst.org/AiS>

Goal



To foster and enhance the participation of diverse populations of high school students in mathematics, science, and computing.

AS

Host States



Alabama -- Carl Davis and Edna Gentry, University of
Alabama -- Huntsville

Colorado -- Dave Zachmann and Pat Burns, Colorado
State University

Iowa - Barbara Helland, Krell Institute

New Mexico -- Richard Allen, Sandia National
Laboratories--New Mexico

Tennessee -- Barbara Summers, Oak Ridge National
Laboratory

AS

Components

- 
- Ongoing Teacher Training -- Summer Institutes and follow up workshops for teacher education and curriculum development
 -
 - Technical Support -- Continued computing and networking support
 -
 - Colleges of Education -- Support of Colleges of Education for continuing education credits
 -
 - Assessment -- Ongoing assessment for dual purpose of evaluation and incorporation of improvements into the program

AS.

Curriculum



- Develops student's ability to work in teams
- Develops logical thinking skills
- Emphasizes oral and written communication
- Focus on "real world" problems
- Multi-disciplinary approach
- Learner centered
- Teacher teams function as facilitators

Example



Sample Problem (Joe Zachary, University of Utah)
<http://www.krellinst.org/UCES/archive/modules/>

World Population: The human population of the earth is large and increasing rapidly. According to the 1991 Rand McNally World Atlas, the population in 1900 was approximately 1.6 billion. This increased to 2.5 billion in 1950 and more than doubled over the next 40 years to exceed 5.2 billion in 1990. Are there already too many people in the world or can the earth comfortably absorb even larger numbers of humans?

AS

World Population Example(cont.)



Problem: Calculate number of square feet of earth's surface that every human would receive if the surface were divided evenly

Model: Find mathematical model assuming that the earth is a perfect sphere of radius 4000 miles and the earth's population is 5.5 billion people

Method: Devise computer method using formula for surface area of a sphere to calculate the earth's area and then divide by earth's population.

Implementation: Decide on appropriate method, paper and pencil, C program, Maple, etc.

Assessment: Does the answer make sense?

AS

Projects



Sample Expo Projects: Predicting Forest Fire Activity Through Component Analysis, Ozone Depletion, Waste Disposal and Landfill Growth, Optics in our School Gymnasium, Roller Coaster Physics, Aging Nuclear Weapons, Applications of Heat Transfer, Ecological Exploration into the Relationship between Cheetahs and Gazelles: Symbiotic or Parasitic, A numerical simulation of meteor encounters with planet Earth....

AS

Project Scoring Rubric



	1	2	3	4
Problem statement	Students clearly define the problem and present the background information necessary to understand the context of the problem.	Students do not clearly define the problem OR do not present the background information necessary to understand the context of the problem.	Students do not clearly define the problem AND do not present the background information necessary to understand the context of the problem.	Students vaguely identify a problem or do not define the problem at all.
Method of Solution	Students describe all parts of the mathematical and computational models and their relationship to the problem to be solved. The program code is well documented	Students describe the mathematical and computational models and their relationship to the problem, but the description is not complete. The program code may or may not be well documented.	Students describe the mathematical and computational models, but the description is not accurate. The program code may or may not be well documented.	Students do not refer to the mathematical or computational models of the project. The program code is not documented.
Results and Conclusions	Results and conclusions are clearly stated, are supported by visual representation of data, and address all parts of the stated problem	Results and conclusions are clearly stated, are supported by visual representation of data, but do not address all parts of the stated problem.	Results and conclusions are stated, but not supported by visual representation of data, and do not address all parts of the stated problem.	Results and conclusions are not stated.

AS

Rubric (continued)



	1	2	3	4
Technical writing	Writing is coherent and free from spelling and grammatical errors. Scientific terms are clearly defined. Graphs are clearly labeled.	Writing is coherent, but contains numerous spelling and grammatical errors. Scientific terms are not clearly defined. Graphs are not clearly labeled.	Writing is coherent, but contains numerous spelling and grammatical errors. Scientific terms are not clearly defined. Graphs are not clearly labeled.	Writing is not coherent and contains numerous spelling and grammatical errors.
Display	The display conveys the important aspects of the project and is visually pleasing.	The display does not display all the important aspects of the project OR is not visually pleasing.	The display does not display all of the important aspects of the project AND is not visually pleasing.	The display does not relate to the problem.
Interview	The team is highly knowledgeable of project content. They communicate understanding of both the math and computational models. They can also coherently describe their results and conclusions.	The team does not demonstrate a high degree of competence in one of the three areas: knowledge of project content, understanding of both the math and computational models, description of results and conclusions.	The team does not demonstrate a high degree of competence in two of the three areas: knowledge of project content, understanding of both the math and computational models, description of results and conclusions.	The team does not demonstrate a high degree of competence in any of the three areas: knowledge of project content, understanding of both the math and computational models, description of results and conclusions.

AS.

Today



- Continues to introduce technology into the classroom: compute servers provide compute cycles, cached web pages, e-mail accounts Servers could also host desktop video conferencing and electronic notebooks

- Teacher training (“Now that we have the technology, what do we do with it?”)
 - 20 new schools added including schools from the states of California, Hawaii, Texas and Wyoming
 - Formalized modules into online textbook

AS

<http://ais.cs.sandia.gov/AiS/textbook/textbook.html>

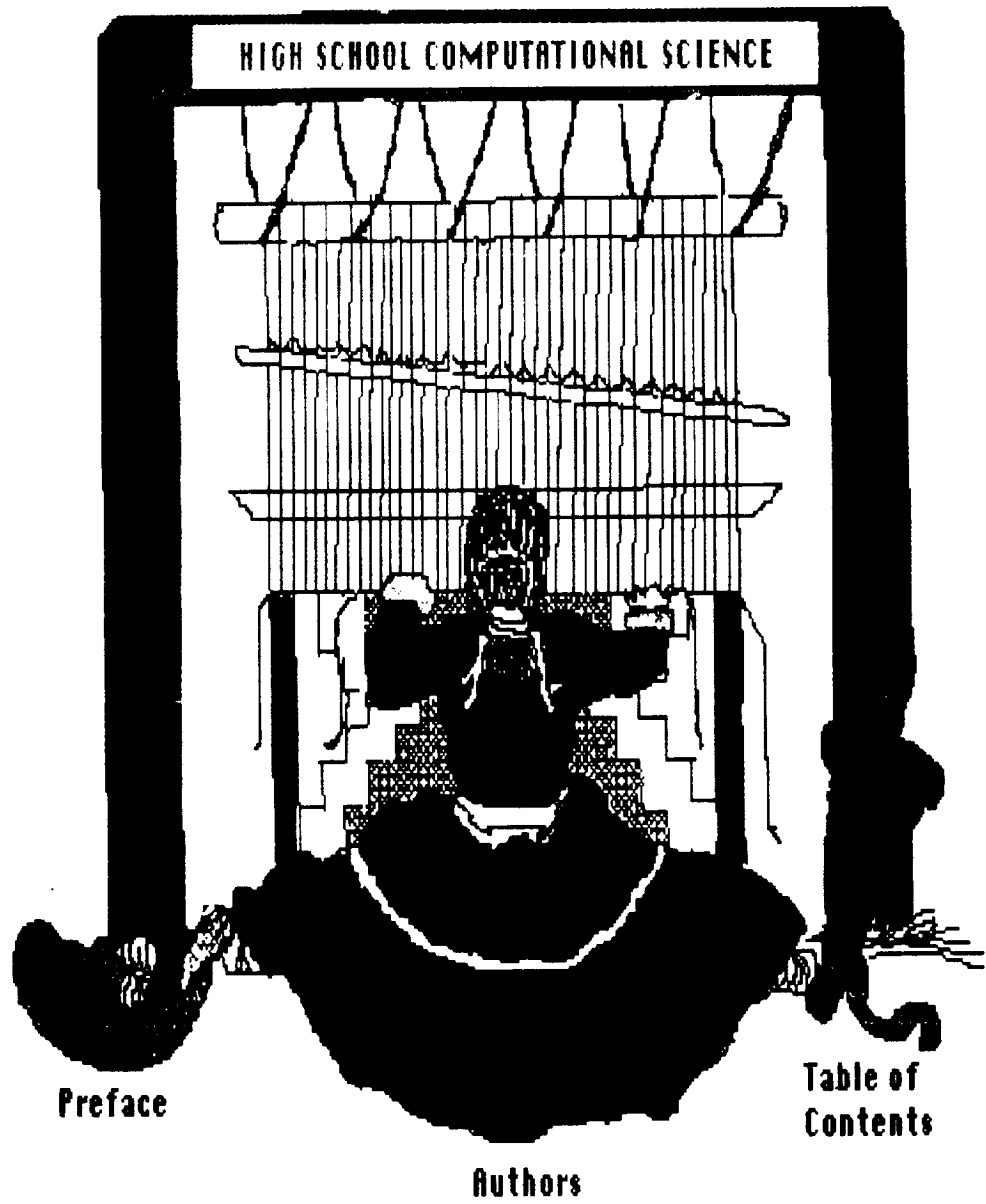

Table of Contents



Unit 1 Computational Science

1 Definition and Applications

Unit 2 Project Development

2.1 Overview of a Computational Science Project

2.2 Example Projects

2.3 Project Development

2.3.1 Topic Selection

2.3.2 Topic Research

2.3.3 Problem Definition

2.3.4 Background Information

2.3.5 Mathematical Modeling

2.3.6 Method of Solution

2.3.7 Results

2.3.8 Conclusions and Further Research

2.4 Project Presentation

2.4.1 Technical Paper

2.4.2 Oral Presentation

2.5 Mentors

Unit 3 Team Development

3.1 Team Development

3.2 Team Dynamics

Unit 4 Internet Resources

4.1 World Wide Web

4.1.1 Network Browsers

4.1.2 Research on the Internet

4.2 Pine Mail Utility

4.3 HTML Document Writing

4.4 Internet Etiquette and Ethics

Unit 5 UNIX and Text Editors

Unit 6 Introduction to Computing

Unit 7 FORTRAN 77

Unit 8 Fortran 90

Unit 9 C++

Appendix A: Tables of Units

Appendix B: Dimensional Analysis

Appendix C: Math Notes



Teachers

- 
- Organize and conduct Summer Institutes for new teachers
 - Serve on state AiS advisory committees
 - Often act as technology advisors for their schools
 - Conduct in-service training for teachers in their districts
 -
 - Switch schools and “take” AiS with them

AS

Students



- Often take AiS classes more than once
-
- Serve as mentors for new AiS students
-
- Serve as computer experts in their schools
-
- Develop “marketable” skills

AS

Implementing SkyMath

Beverly T. Lynds
University Corporation for Atmospheric Research
P.O. Box 3000
Boulder, Colorado 80307-3000
303-497-8654
303-497-8690
blynds@unidata.ucar.edu

The University Corporation for Atmospheric Research (UCAR) has developed a middle school mathematics module, Project SkyMath, that demonstrates that acquiring and using current environmental and real-time weather data in middle school classrooms promotes the teaching and learning of the significant mathematics that is the foundation of data analysis. The program is alligned with the Standards of the National Council of Teachers of Mathematics (NCTM) The SkyMath module, "Using the Science and Language of Patterns to Explore Temperature", develops mathematical concepts using temperature data. The classroom activities lead students to create methods of representing change: how temperature changes with time and with location. Students are challenged to measure, represent, and analyze these changes. The fifteen activities and an end-of-unit assessment tool are downloadable from the SkyMath homepage <http://www.unidata.ucar.edu/staff/blynds/Skymath.html>.

During the past year, several Mu-spin sites have assisted UCAR in the introduction of SkyMath into classrooms. We hope to share their experiences both successes and failures, with the '97 conference attendees.

The University of Texas at El Paso has assisted several middle schools in Internet connectivity and has encouraged math teachers to use the SkyMath module in their classrooms. The very enthusiastic responses by teachers and students to the module has helped UCAR demonstrate the effectiveness of the module. One of the UTEP schools provided Spanish translations for the SkyMath reproducible masters distributed to students. Elizabeth City State University identified one middle school interested in participating in the SkyMath activity, and Morgan State University hosted a conference that introduced SkyMath activities to their Urban Systemic Program.

NASA Langley Research Center supported four middle schools in their effort to test the SkyMath module by providing workshops and materials for the teachers.

MU-SPIN Consultants

*Dr. Ely Dorsey
Howard University*

*Mr. Maurice Foxworth & Ms. Cynthia Dinkins
Foxworth & Dinkins*

*Ms. Valerie Thomas
LaVal Corporation*

1. THE CHANGE MANAGEMENT INTERVENTION IN
MU- SPIN 1997

By Dr. Ely A. Dorsey, Director
The Institute for the Study of Industrial Ecology,
Environmental Justice and Cybernetic Systems

Howard University School of Business

2. CHANGE MANAGEMENT 1997

WE HAVE BEEN ENGAGED IN THE MU-SPIN PROJECT SINCE 1996, WHEN WE FIRST ANALYZED THE PROJECT FROM A SOCIOTECHNICAL PERSPECTIVE AS A NASA- ASEE SUMMER FELLOW. THE INSTITUTE IS NOW ENGAGED AS A CONTRACTOR TO FACILITATE CHANGE MANAGEMENT IN THE PROJECT. BEFORE WE GIVE OUR REPORT, WE WOULD LIKE TO REVISIT THE THINKING OF THE NEW VISION OF MU-SPIN.

THE VISION OF MU-SPIN IS THAT OF MU-SPIN, INC.. THIS MEANS THAT THE VARIOUS NRTS CLUSTERS ARE TO BE ENGAGED AS INTEGRATED PARTNERS IN AN ENTERPRISE CONSTRUCT MUTUALLY, COMMERCIALY EXPLOITING THEIR EXPERT INSTITUTE CAPACITIES IN INFORMATION AND NETWORK SYSTEMS KNOW-HOW FOR VARIOUS MATHEMATICAL, SCIENTIFIC, ENGINEERING AND TECHNICAL APPLICATIONS. FURTHERMORE, THE TRANSFER OF THIS CAPACITY TO COMMUNITIES AND EDUCATORS AT ALL LEVELS, PARTICULARLY, K-12, WILL BE A METRIC BY WHICH THE PROJECT SELF REFLECTS AND IS JUDGED BY THE CUSTOMERS IT SERVES.

3. CHANGE MANAGEMENT 1997

THIS NEW VISION CALLED FOR A COOPERATION AMONG PARTNERS THAT IS RADICAL AND DISRUPTIVE. CLEARLY, NASA MU-SPIN LEADERSHIP SEEING THAT THIS CALL WAS SOMEWHAT UNFAIR, PROVIDED A RESOURCE, NAMELY OUR INSTITUTE TO FACILITATE THIS TRANSFORMATION. FURTHERMORE, NASA MU- SPIN RECOGNIZED THAT THEY COULD NOT ASK THEIR NRTS PARTNERS TO UNDERTAKE A PARADIGM SHIFT WITHOUT ENGAGING IN THIS SHIFT THEMSELVES, HENCE PART OF THE CHANGE MANAGEMENT INTERVENTION CALLED FOR THE TRANSFORMATION OF PROJECT MANAGEMENT FROM THE LEAD OF THE PROJECT.

THE OBJECT OF THE CHANGE MANAGEMENT INTERVENTION AT THIS TIME IS TO PROVIDE ENOUGH EVIDENCE THAT SUCH A PARADIGM SHIFT IS

COMMUNICATION AND THE TYPE OF DATA THE ORGANIZATION HAS BEEN PRODUCING BEFORE THE BEHAVIORAL INFORMATION WAS PRESENTED BY AN OUTSIDE AGENCY. IN OTHER WORDS, THE ORGANIZATION CANNOT SEE NEW INFORMATION ABOUT ITSELF, THUS IT CONTINUES AS IF THE NEW INFORMATION IS PART OF THE OLD INFORMATION.

8. CHANGE MANAGEMENT 1997

METRICS THAT MEASURE CHANGE

FIRST ORDER CHANGE IS SELF SEALING CHANGE WHERE LEARNING IS ARTICULATED IN TERMS OF APPARENT SUCCESSES AND FAILURES. GROUPS DO NOT LEARN NEW PARADIGMS, INSTEAD THEY RELEARN WHAT THEY ARE FAMILIAR WITH. THE DELUSION IS COUCHED IN TERMS OF INCREASED EFFICIENCY OR THE LIKE. NEW EFFECTIVENESS TO NEW COMPLEXITY IS NOT CONSIDERED BECAUSE IT IS NOT RECOGNIZED AS A NEED. THE METRICS ARE AS FOLLOWS:

1. *DEFINE GOALS AND TRY TO ACHIEVE THEM.* THE ACTOR HERE DESIGNS AND MANAGES THE ENVIRONMENT UNILATERALLY.

2. *MAXIMIZE WINNING AND MINIMIZE LOSING.* THE ACTOR OWNS AND CONTROLS THE TASK. S/HE CLAIMS OWNERSHIP OF THE TASK AND IS GUARDIAN OF THE DEFINITION AND EXECUTION OF THE TASK.

3. *MINIMIZE GENERATING OR EXPRESSING NEGATIVE FEELINGS.* THE ACTOR UNILATERALLY PROTECTS HIM/HERSELF. S/HE SPEAKS WITH INFERRED CATEGORIES ACCOMPANIED BY LITTLE OR NO DIRECTLY OBSERVABLE BEHAVIOR THE ACTOR IS BLIND TO THE IMPACT ON OTHERS.

9. CHANGE MANAGEMENT 1997

CHANGE METRICS CONTINUED

THE ACTOR REDUCES INCONGRUITY BY DEFENSIVE ACTIONS SUCH AS BLAMING, STEREOTYPING, SUPPRESSING FEELINGS AND INTELLECTUALIZING. THERE IS LITTLE OR NO PUBLIC TESTING OF THEORIES IN USE. TESTING IS MOSTLY PRIVATE.

4. *BE RATIONAL.* THE ACTOR UNILATERALLY PROTECT OTHERS FROM BEING HURT. S/HE WITHHOLDS INFORMATION, CREATES RULES TO CENSOR INFORMATION AND BEHAVIOR, HOLDS PRIVATE MEETINGS. THE ACTOR INDUCES LOW FREEDOM OF CHOICE, INTERNAL COMMITMENT AND RISK TAKING.

10. CHANGE MANAGEMENT 1997

METRICS OF CHANGE

SECOND ORDER CHANGE. SECOND ORDER CHANGE IS THE CHANGE WE SEEK. IT IS BEING IN A LEARNING TO LEARN STATE. IT IS UNDERSTOOD IN TERMS OF EFFECTIVENESS. WE CONTINUE TO ASK "WHAT IS THIS IN FRONT OF US, AND IS OUR VIEW THE ONLY WAY TO SEE WHAT WE SEE?" THE METRICS FOLLOW.

1. *VALID INFORMATION.* THE ACTORS DESIGNS SITUATIONS OR ENVIRONMENTS WHERE PARTICIPANTS CAN BE ORIGINS AND EXPERIENCE HIGH PERSONAL CAUSATION, PSYCHOLOGICAL SUCCESS, CONFIRMATION AND ESSENTIALITY.

2. *FREE AND INFORMED CHOICE.* THE ACTOR S DESIGN TASKS THAT ARE JOINTLY CONTROLLED. THIS LEADS TO INCREASED LONG-RUN EFFECTIVENESS.

11. CHANGE MANAGEMENT 1997

CHANGE METRICS CONTINUED

3. *INTERNAL COMMITMENT TO THE CHOICES AND CONSTANT MONITORING OF ITS IMPLEMENTATION.* THE ACTORS RECOGNIZE AND ACT ON THE PREMISE THAT PROTECTION OF THE SELF IS A JOINT ENTERPRISE AND ORIENTED TOWARD GROWTH. THE ACTORS SPEAK IN DIRECTLY OBSERVABLE CATEGORIES, SEEK TO REDUCE BLINDNESS ABOUT THEIR OWN INCONSISTENCY AND INCONGRUITY. THE ACTORS BILATERALLY PROTECT OTHERS. HERE THERE IS LEARNING-ORIENTED NORMS OF TRUST AND INDIVIDUALITY. THERE IS OPEN CONFRONTATION ON DIFFICULT ISSUES AND PUBLIC TESTING OF THEORIES IN USE. THIS CONFRONTATION IS NOT UNKIND NOR DISRESPECTFUL, IT IS DARING AND ENCOURAGED. THE IDEA IS TO CHALLENGE CONSTRUCTS OF ACTION THAT ARE PRESENT IN THE GROUP.

12. CHANGE MANAGEMENT 1997

MU-SPIN PROJECT HEADQUARTERS. THERE ARE FOUR COMPONENTS TO THE HEADQUARTERS ORGAN IN THE MU-SPIN PROJECT: NASA PROJECT GOVERNMENT, NASA GOVERNMENT OUTSIDE PROJECT, ADNET CONTRACTORS, AND OTHER CONSULTANTS.

WE LOOKED FOR TWO THINGS HERE: COMMUNICATIONS CONSISTENCY BETWEEN THE GOVERNMENT COMPONENTS AND THE NON GOVERNMENT COMPONENTS, AND ADHERENCE TO A CONSISTENT DECISION MAKING MODEL. WE FOCUSED ON THE COMMUNICATION BETWEEN PROJECT LEADERSHIP AND THE OTHER CONSULTANTS, AND BETWEEN PROJECT LEADERSHIP AND ADNET CONTRACTORS. WE COULD NOT OBSERVE OTHER LINKAGES BECAUSE WE WERE NOT POSITIONED TO DO SO. THE REASON FOR THIS PATH IS BECAUSE WE SEEK TO SEE IF THERE IS A PROPENSITY TO EMBRACE THE GOVERNING VARIABLE *VALID INFORMATION* AS A MEANS OF LEARNING. WHAT A RESEARCHER LOOKS FOR HERE IS IF THE GROUP SHARES ALL RELEVANT INFORMATION, OR IF THE GROUP SHARES INFORMATION IN WAYS THAT OTHERS UNDERSTAND IT, OR IF THE GROUP SHARES INFORMATION IN WAYS THAT OTHERS CAN INDEPENDENTLY VALIDATE IT, OR IF THE GROUP CONTINUALLY SEEKS NEW INFORMATION TO DETERMINE WHETHER PREVIOUS DECISIONS SHOULD BE CHANGED.

13. CHANGE MANAGEMENT 1997

WHAT WE FOUND WAS THAT THIS GOVERNING VARIABLE WAS NOT SUFFICIENTLY UNDERSTOOD BY THE PARTIES SO THAT IT COULD BE INFRA STRUCTURALLY SUPPORTED. GOVERNMENT MEETINGS WITH THE ADNET CONTRACTORS ARE IRREGULAR AND THERE IS NO SET FORMAT WHEN THOSE MEETINGS TAKE PLACE. BOTH PARTIES DO NOT KNOW WHAT TO REPORT TO EACH OTHER BECAUSE THEY HAVE NOT AGREED ON HOW TO REPORT TO EACH OTHER. DECISION MAKING IS AMBIGUOUS. NEITHER THE GOVERNMENT NOT THE CONTRACTORS KNOW HOW TO IDENTIFY A DECISION TO EACH OTHER. INFORMATION IS SHARED, BUT ITS RELEVANCY IS NOT TESTABLE BECAUSE PROBLEM SOLVING MODELS ARE INTRINSIC AND PRIVATE.

WE ARRIVED AT THESE FINDINGS THROUGH VARIOUS MEETINGS THAT WE HAVE FACILITATED WITH BOTH PARTIES OVER THE LAST YEAR. BOTH PARTIES ACT COOPERATIVELY AS ETHNOGRAPHIC INFORMANTS. THERE IS A COMMITTED INTENT TO SUPPORT *VALID INFORMATION*. THE ADNET CONTRACTORS HAVE ASKED FOR REGULAR PROJECT STATUS MEETINGS AND HAVE REQUESTED THAT THE INSTITUTE FACILITATE THOSE MEETINGS. WE HAVE AGREED TO DO SO. OUR ROLE WILL BE TO HELP BOTH PARTIES SEE THAT THE PROJECT IS UNDERGOING VERY DISRUPTIVE CHANGE AND THAT THE USUAL SHORT CRISP OR CLEAR INFORMATION THAT TAKES PLACE BETWEEN PARTIES IN A STABLE ENVIRONMENT IS NOT RELEVANT NOR USEFUL HERE. WE WILL TRY TO HELP BOTH PARTIES SEE THAT THEY TOGETHER WILL DEFINE THE NEW PARAMETERS OF THEIR RELATIONSHIP , AND THIS IS QUITE HEALTHY AND PROGRESSIVE FOR THE PROJECT AS A WHOLE.

14. CHANGE MANAGEMENT 1997

THE GOVERNMENT SIDE HAS AGREED TO ALLOW INTERVENTIONS WITH THE ADNET CONTRACTORS AS PART OF THE INSTITUTE'S ROLE IN THE PROJECT. IT ALSO RECOGNIZES THE TRADITIONAL ROLES THAT BOTH GOVERNMENT AND CONTRACTORS HAVE PLAYED OVER THE YEARS. WE WILL TRY TO HELP THE PARTIES SEE THAT THESE TRADITIONAL ROLES ARE QUITE DYSFUNCTIONAL TO THE PROJECT.

PROJECT LEADERSHIP AND OTHER OUTSIDE CONSULTANTS. WE HAVE OBSERVED THIS EVOLVING RELATIONSHIP SINCE JANUARY OF 1997. ONE CONTRACTOR IS OFFICED AT MU-SPIN HEADQUARTERS. THE OTHERS HAVE FACILITIES ELSEWHERE. NO EFFECTIVE PROVISIONS FOR THE INSTITUTE TO BE HOUSED AT MU-SPIN HEADQUARTERS HAVE BEEN MADE. THE CONSULTANTS HAVE NOT BEEN ORGANIZED AS A GROUP. THEY ARE INDEPENDENT AND ARE USUALLY COMMUNICATED WITH IN THAT WAY. THERE HAVE BEEN SOME COMMON THEME MEETINGS WITH RESPECT TO FUTURE INVOLVEMENT IN THE PROJECT. INFORMATION RELATIVE TO THAT COMMON INTEREST HAS BEEN SHARED. OUR ROLE WITH THE OTHER CONSULTANTS IS STILL EVOLVING. THERE IS SUBSTANTIAL OPPORTUNITY FOR CROSS SERVICE SUPPORT. WE HAVE NOT BEEN ASKED TO EXPAND OUR ROLE HERE BEYOND THAT OF SCIENTIFIC OBSERVER.

15. CHANGE MANAGEMENT 1997

KEY IDEA

THE STORY AT MU-SPIN HEADQUARTERS. THE STORY AT HEADQUARTERS IS A STORY OF VERY POWERFUL CHANGE AND DISRUPTION. NORMALLY UNDERSTOOD COMMUNICATIONS ARE NOT PRESENT. THE NEWNESS OF THE GROWTH IN THE INTELLECTUAL PRODUCTS ACROSS MU-SPIN NATIONWIDE IS EXCITING AND TERRIFYING. THE GROWTH CANNOT BE MANAGED TRADITIONALLY. IT CALLS FOR RISK TAKING OF A DIFFERENT SORT: LEARNING HOW TO LEARN WITHOUT A MAP. CAUTION AND CHALLENGE ARE TUGGING AT EACH OTHER. TRADITION AND RADICAL TRANSFORMATION ARE TRYING TO COMPLIMENT EACH OTHER. TELLING A COLLEAGUE WHAT TO DO IS QUITE DYSFUNCTIONAL. ENGAGING A COLLEAGUE IN NEW DISCOVERY IS THE BETTER PATH TO TRAVEL. THE OWNERSHIP OF THE GROWTH IS PROJECT WIDE. GROWTH IN DEMAND CONTROL AT MU-SPIN HEADQUARTERS IS A MAJOR AREA OF CONCERN. COLLECTIVE MANAGERIAL STRATEGIES APPEAR TO BE A GOOD BASIS FOR PROBLEM SOLVING IN THESE DYNAMIC THEATERS OF CHANGE.

16. CHANGE MANAGEMENT 1997

THE INTERVENTION IN THE FIELD. WE STUDIED THE PROPENSITY FOR SECOND ORDER LEARNING IN THE FIELD AS WE VISITED VARIOUS NRTS SITES OVER THE LAST YEAR. WE CONDUCTED WORKSHOPS ON TEAM BUILDING AND PROJECT MANAGEMENT AT THREE SITES AND FACILITATED SEVERAL MEETINGS AT TWO SITES. AT TWO SITES, WE WERE OBSERVERS ONLY. WE CONDUCTED SEVERAL ETHNOGRAPHIC INTERVIEWS BY TELEPHONE WITH THREE NRTS PRINCIPAL INVESTIGATORS. WE HAVE SOME PRELIMINARY OBSERVATIONS THAT ARE STILL BEING TESTED:

1. PROJECT MANAGEMENT AS A CONCEPT IS UNDERSTOOD IN AN ELEMENTARY WAY ACROSS THE FIELD.
2. CROSS BOUNDARY MANAGEMENT WITHIN A CLUSTER IS NOT WELL SUPPORTED.
3. THE NEW VISION OF MU- SPIN IS NOT UNDERSTOOD ACROSS THE FIELD.

WE PRESENT OUR INITIAL UNDERSTANDING IN AN ANECDOTAL WAY WITH SITE EVIDENCE AND A FULLER DISCUSSION AND FILM OF THE WORKSHOP AT SOUTH CAROLINA STATE UNIVERSITY.

17. CHANGE MANAGEMENT 1997

WE FIRST OBSERVED THE VARIOUS WEB AND RELATED WORKSHOPS AT ALL SITES. IT APPEARED THAT RECIPIENTS WERE BENEFITTING FROM THE INSTRUCTION BEING RECEIVED AT THE WORKSHOP. WE COULD NOT DETERMINE IF HELP DESKS HAD BEEN ESTABLISHED TO FOLLOW UP ON THE INITIAL TRAINING TAKING PLACE. THE ESTABLISHMENT OF A CLUSTER WIDE HELP DESK WOULD IMPLY THAT THE NOTION OF PARTNERING ACROSS CORPORATE BOUNDARIES WAS BEGINNING TO TAKE HOLD.

IT WAS CLEAR THAT EACH CLUSTER NEEDED TO ADDRESS THE CLUSTER WIDE SUPPORT AND MAINTENANCE QUESTION. EACH CLUSTER HAS NETWORK SUPPORT FACILITIES AT VERY DIFFERENT DEGREES OF CAPACITY. THE PARTNERS IN EACH CLUSTER HAVE NOT HERETOFORE SEEN THIS AS AN ACROSS CLUSTER QUESTION. IT HAS BEEN A TRADITIONAL EACH INSTITUTION FOR ITSELF ISSUE. IN SOUTH CAROLINA AND IN TENNESSEE, WE ADDRESSED THESE ISSUES DIRECTLY. OUR INTERVENTION THERE WILL BE DESCRIBED BELOW. WE WERE ABLE FILM THE WORKSHOP AT SOUTH CAROLINA, AND WE'LL PRESENT SOME HIGHLIGHTS.

18. CHANGE MANAGEMENT 1997

AND NOW THE MOVIE...

Technology Transfer & Commercialization

Maurice D. Foxworth
Foxworth & Dinkins, Inc.
312 9th Street, SE
Washington, DC 20003
U.S.A.
202-546-7669
202-546-2374

Technology commercialization is a core mission of NASA. Consequently, The NASA MU-SPIN project has placed a central emphasis on enhancing the involvement of the NRTS in technology commercialization activities. This session will discuss MU-SPIN's technology commercialization concept and strategy. Current NRTS commercialization initiatives will, also, be discussed.



MU-SPIN

Research/Education Outreach
Coordination Status Update

Valerie L. Thomas

MU-SPIN Research/Education Outreach
Coordinator

Presented at the MU-SPIN Conference

October 9, 1997





What's Next: Alternative Computing?

Virtual University
Research Opportunities
K-12 Educational Programs

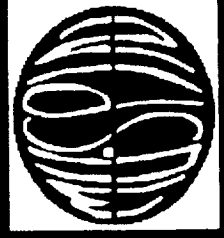

Outreach Strategic Implementation



NRTS “Expert Institute Concept”
Distance Learning
Summer Student and Faculty Programs
Research/Education Outreach Information
& Tracking System
MU-SPIN Partnerships
Pre-College Education Outreach

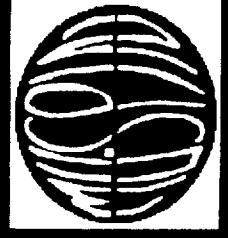



Current Initiatives

- Web Page - Showcasing Impact of MU-SPIN Outreach Program
- Web-Based Education Programs (K-12)
- Summer Student Program
- Development of Partners - Research & Commercialization Opportunities
 - Elizabeth City ATLAS Example
- Distance Learning



Web-Based Educational Programs



Innovative Learning

Sky Math

GLOBE

Knowledge Integration Environment (KIE)

Explorers of the Universe

Adventures in Supercomputing





Accomplishments

- Addition of the Outreach Coordinator & Staff
- Development of an Outreach Strategic Plan
- Development of a MU-SPIN Information & Tracking System (Web-Based)
- Development of Electronic Form to Input Information
 - NRTS Impact Report
 - Student Profiles





Accomplishment (Continued)

Initiated Monthly NRTS Teleconferences
– Communication & Coordination

Development of a Summer Student Program





Accomplishments

Initiated Discussions to Form Partnerships

- CCNY/CUNY & Code 935 (NASA/GSFC) -
Regional Validation Center
- University of the District of Columbia (UDC)
& Code 935; and UDC & MU-SPIN Project -
Regional Validation Center and UDC/MU-
SPIN Collaboration
- NOAA/Weather Service & MU-SPIN Project -
Collaborative Activities





Outreach Staff

Valerie L. Thomas, MU-SPIN Research/
Education Outreach Coordinator

Carol Boquist, MU-SPIN Science
Communications Consultant

Chevell L. Thomas, MU-SPIN Education
Consultant

Judy Laue, MU-SPIN Graphics and
Editorial Consultant

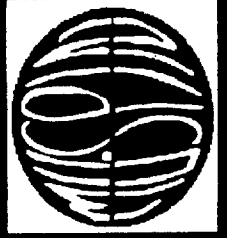



Future Activities (2000-2005)

- Increased Participation by NRTS Institutions in the Web-Based Education Programs
- Increased Publications & Presentations on the MU-SPIN Outreach Activities
- Incorporation of the Outreach Impact Information from all of the NRTS in the New Web Site





Futu

Inclusion of Technology Transfer/
Commercialization and Change
Management impacts in the New Web Site
Implementation of the MU-SPIN Summer
Program
Implementation of the Distance Learning &
Formalizing the Virtual University





MU-SPIN

MU-SPIN Participation in the NASA/
GSFC Education Showcase
Development of MU-SPIN Research
Opportunity Alert System
Develop Partnerships with Other NASA
Centers, Government Agencies, Industry &
Academia



GLOBAL LEARNING AND
OBSERVATIONS IO
BENEFIT THE
ENVIRONMENT

NASA GODDARD SPACE FLIGHT
CENTER EDUCATION OFFICE

Framework Components

NASA Mission
(Content)

Strategic Enterprises:

Mission to Planet Earth

Space Science

Human Exploration and
Development of Space

Aeronautics and Space
Transportation Technology

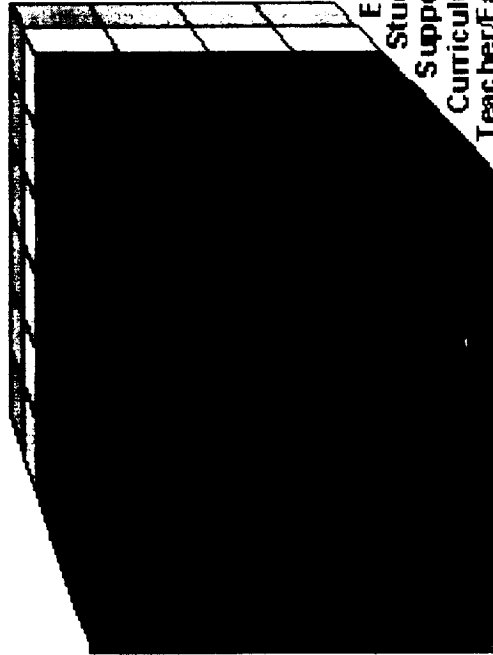

Education
Implementation
Approaches:

Mission, R & D, and Operations
Educational Technology
Student Support
Support for Systemic Change
Curriculum Support & Dissemination
Teacher/Faculty Preparation & Enhancement

K-4 5-8 9-12 CC UG G

Customer: Education Community
(Formal/ Informal)

NASA EDUCATION FRAMEWORK

MTFE Objectives

Systemic Mechanisms

- ◆ Enhance the capabilities of the broad education community
- ◆ Contribute to K-12 mathematics, science and technology through promotion of involvement
- ◆ Enhance participation of schools, significant number of underrepresented groups
- ◆ Strengthen the interface between educators and scientists

COBE Science and Inquiry

Processes

- ◆ A tool to enhance understanding of Earth Systems
- ◆ All measurements and equipment as straightforward as possible
- ◆ Enhance environmental awareness throughout the world
- ◆ Reach higher levels of achievement in math, science and technology

GLOBE Legacy

Global Environmental

Education

- ◆ Reaching thousands of schools and tens of thousands of students
- ◆ Authentic sense of participation
- ◆ Understanding of the World
- ◆ Teaching Environmental Education at all levels

GLOBE'S EDUCATION

Technology Solutions

- ◆ Use teachers and students to monitor the entire earth
- ◆ “A way to make the MTPE become a Mission by the People of Planet Earth”
Gore
- ◆ “To change minds and hearts all over the world on the subject of the environment”
Gore

Systematically Addressing Science Frameworks

- ◆ Integrate GLOBE protocols within the Earth System Science Investigations
- ◆ Extensive use of GLOBE data server visualizations, graphs and reference datasets
- ◆ Use of NASA's current and future missions of remote sensing datasets
- ◆ Authentic participation in the international effort to study and understand the Earth

Local Actions Have Global Effects

3 Elements effect Life

- ◆ Temperature
 - ◆ Salinity
 - ◆ Dissolved Oxygen
- Enhanced Protocols

- ◆ Alkalinity
- ◆ Nitrates
- ◆ Turbidity

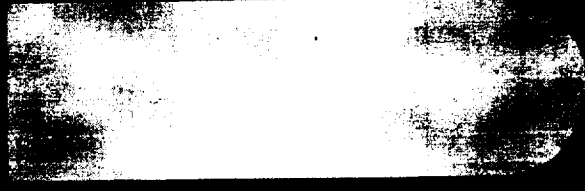

Investigating

- ◆ Specific data collection procedures
- ◆ Collecting data
- ◆ Analyzing data
- ◆ Comparisons
- ◆ Graphic Interpretation
- ◆ Archive/Over time
- ◆ Conclusion



Global Star and Earth System

- ◆ Observation of the area- What seems right/ wrong?
- ◆ Hands-on Activities-How does the system interact?
- ◆ Data Collection-Using the protocols
- ◆ Research-What was it like in the past?
- ◆ Data Collection-GLOBE Archives
- ◆ Primary Source Interviews

Understanding Earth Resources

- ◆ Using satellite images/Remote Sensing
- ◆ Analyzing the results
- ◆ Drawing a conclusion
- ◆ Recommendations
- ◆ Action

Call for Participation Presentations

*Dr. Nizar Al-Holou
University of Detroit Mercy*

*Dr. S. Raj Chaudhury
Norfolk State University*

*Mr. Brian Giza
University of Texas at Austin*

*Dr. Katherine Price
Texas A&M University at Corpus Christi*

*Dr. Linda Hayden & Mr. Kurt E. Roberson
Elizabeth City State University*

Development of A Computer Based Instructional (CBI) Curriculum for Greenfield Coalition

Nizar Al-Holou, Ph.D.
Associate Professor
Electrical Engineering Dept.,
University of Detroit Mercy,
Detroit, MI 48219-0900

Supported by NSF through Greenfield coalition

Objectives of the Curriculum

- Develop competencies in the Principles of Electrical Engineering and Physics knowledge areas. Cover the following knowledge sub areas:
 - Electrostatic
 - DC circuit analysis
 - AC circuit analysis
 - Inductance, Capacitance and Electromagnetism
 - Digital Concepts

- Provide candidates with enough background that is relevant to the manufacturing environment at Focus:Hope.

- Have the depth that will be very useful to support/supplement the educational efforts at the participating universities in this field.

Instructional Modules:

- **Module 1: Electrostatic**
- **Module 2: Introduction to Electric Circuits**
- **Module 3: DC Circuits Analysis**
- **Module 4: Inductance, Capacitance and Electromagnetism**
- **Module 5: Sinusoidal Steady-State Analysis**
- **Module 6: Selected Topics in Electric circuits**
- **Module 7: Transient Analysis**
- **Module 8: Digital Concepts**

Module 1: Electrostatic:

1. ..Electric Charges
2. Coulomb's Law
3. Potential Difference
4. Work and Energy.
5. Case Studies

Prerequisites:

- Equations with parameters
- Quadratic Equations

Outcome:

- understand Electricity
- Relate the forces experienced by different charges

Assessment:

- On-line testing
- written test
- Case Study Report

Module2: Introduction to Electric Circuits:

1. Electric Circuit Demonstration
2. Ohm's Law
3. Resistors
4. Measurement Devices
5. Power in Electric Circuits
6. DC Circuits
7. Parallel Circuits
8. Series-Parallel Circuits
9. Case Study

Prerequisites:

- Module 1
- Equations with parameters
- Quadratic Equations
- Graphs

Outcome:

- Relate the terminal voltage, current, and power
- Simplify electric series circuit, parallel circuits and series-parallel circuits.
- master Ohm's Law and Kirchoff's Laws.

Assessment:

- On-line testing
- written test
- Case Study Report

Module3: DC Circuits Analysis:

1. Circuit analysis techniques:
 - a. source transformation
 - b. Nodal Voltage
 - c. Mesh current methods
 - d. Superposition Principle
 - e. Voltage and Current Division Rules
 - e. Cramer's Method
2. Thevenin and Norton equivalent circuits
3. maximum power transfer and load matching.
4. Case study

Prerequisites:

- Module 2,
- System of Linear Equations
- Matrix Arithmetic: Determinants, Cramer's method
- Differentiation

Outcome:

- Mastering circuit analysis techniques
- Analyze complicated circuits

Assessment:

- On-line testing
- written test
- Case Study Report

Module 4: Inductance, Capacitance & Electromagnetism:

1. Magnetic Forces
2. Induced emf
3. Inductance
4. Capacitance
5. Energy of charged capacitors and inductors
6. Case Studies

Prerequisites:

- Modules 1-3,
- First Order Differential Equations.

Outcome:

- Relate the force experienced by a conductor to the intensity of magnetic field and other variables.
- understand Faraday and Lenz' laws

Assessment:

- On-line testing
- written test
- Case Study Report

Module 5: Sinusoidal Steady-State Analysis:

1. Periodic Functions
2. Complex Numbers
3. Reactive Elements
4. Phasor Concept
5. Real and Reactive Power
6. Power Factor and its Effect on Power
7. Case studies such as Appliance and equipment power ratings, efficiency of tools such as cutting tools will be studied.
8. Power Factor Corrections.
9. Case Study.

Prerequisites:

- Modules 1-5
- Complex Number Arithmetic

Outcome:

- Relate frequency, amplitude, phase, terminal voltage and current to resistance and reactance of the circuit.
- Understanding the characteristics of periodic functions
- Master Phasor technique to analyze, and solve AC Circuits
- Distinguish between real and reactive powers
- Mastering power factor corrections

Assessment:

- On-line testing
- written test
- Case Study Report

Module 6: Selected Topics in Electrical Engineering:

1. Diode
2. Transformer
3. Operational Amplifiers
4. Case Studies

Prerequisites:

- Modules 1-5
- Exponential functions
- Integration

Outcome:

- understanding of transformers, operational amplifiers, diodes, and their applications

Assessment:

- On-line testing
- written test
- Case Study Report

Module 7: Transient Circuits:

1. The natural response of RL circuit
2. The natural response RC circuit.
3. The natural response of RLC circuit
4. Analogy
5. Case Studies

Prerequisites:

- Modules 1-6
- First Order and Second Order Differential Equations

Outcome:

- Understand the behavior of the Inductor and Capacitor
- Distinguish between transient and steady state responses
- Understand the principles of storing energy in L & C
- Understand the principle of spark plugs principle.

Assessment:

- On-line testing
- Written test
- Case Study Report

Module 8: Digital Concepts:

1. Number Systems
2. Boolean Algebra
3. Logic Gates
4. Flip Flops
5. Sequential Circuits

Outcome:

- Understand Boolean Algebra
- Understand basic digital elements such as Logic gates, Flip Flops
- Understand sequential circuits

Prerequisites:

- Modules 1-4
- Boolean Algebra

Assessment:

- On-line testing
- written test
- Case Study Report

Components of CBI:

- Attractive text screen and graphics
- Choice of Voice or text or both
- Convenient, standardized navigation buttons
- Ease of Navigation with the module
- Use of hot buttons
- Case studies and examples
- Video clips
- Animation
- Book marking
- On line tests with Feedback to user
- Provide progress report to faculty

Our Experience:

- Six modules have been introduced to candidates at Focus:Hope
- A text Book are used along with the CBI modules
- Students
 - like the CBI modules
 - did not like using the text book
 - took the quizzes repeatedly until they get perfect grade

Dr. S. Raj Chaudhury
Norfolk State University



Introduction

Multimedia Tour

Beyond the Clouds

Browse Data

Lessons & Resources

DAAC Web Site

Glossary



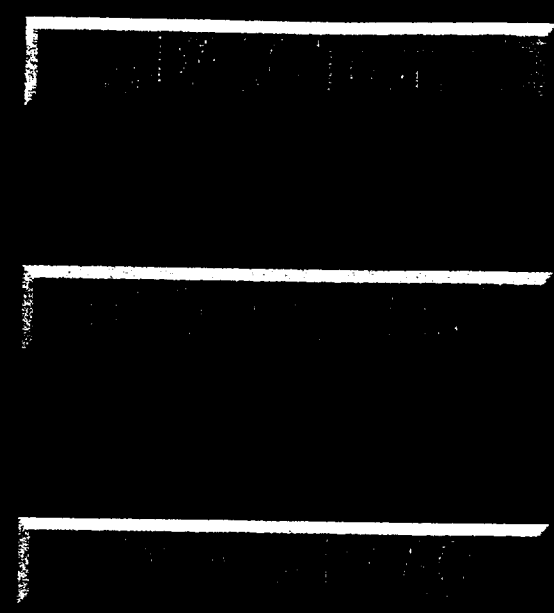
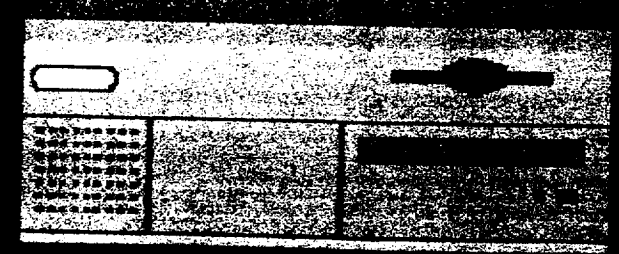
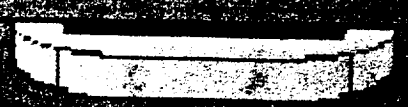
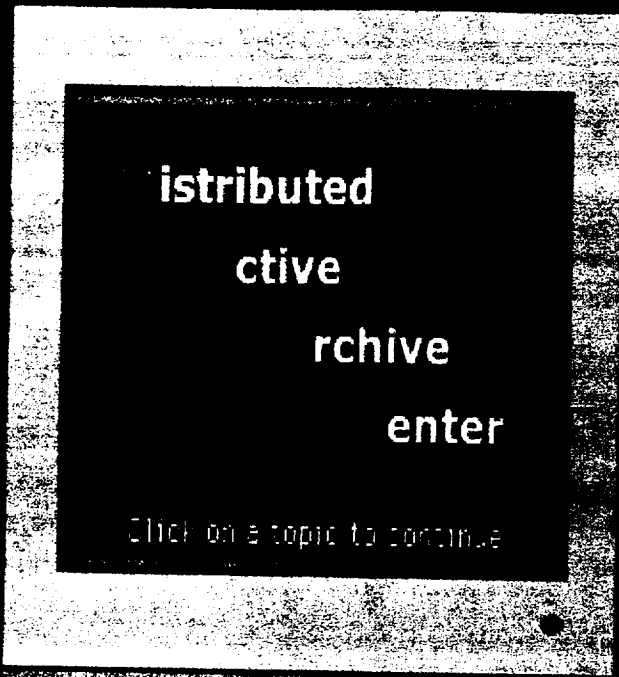

The *Langley Distributed Active Archive Center (DAAC)*, located at the NASA Langley Research Center in Hampton, Virginia, is one of 9 DAACs across the United States that process, store and distribute data from NASA's Earth science research satellites and field measurement programs. The DAACs are part of EOSDIS (Earth Observing System Data Information System). A computer system is being developed to make data held in the archives of other government agencies, organizations and countries easily accessible via the Internet.

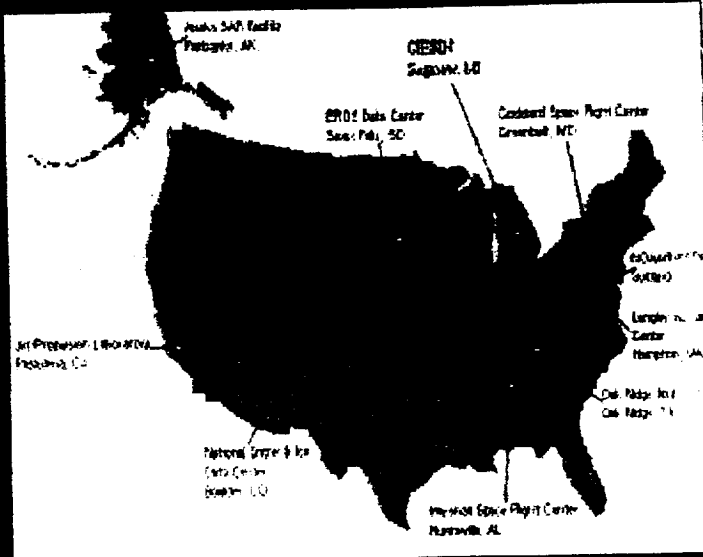

NASA DAACs Across the United States

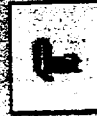

The Langley DAAC is responsible for
archiving and distributing NASA atmospheric
science data in the areas of

aerosols

radiation

clouds

tropospheric chemistry

click on the words in red



These are some of the research projects supported by the DAAC that study the effects of clouds and solar radiation on the global climate.



Scroll over the projects' names on the right and click on each for more information.

ERBE

ISCCP

ERBE

AMIP

Biomass Burning

IMPACT

SR02 II

LTP

CLDS



These are sample data sets on the Earth Radiation Budget visualized by using ClimateWatcher.

Mission to Planet Earth data



Incoming Solar Energy

Reflected Solar Energy

Absorbed Solar Energy

Surface Temperatures

Net Energy Balance

Spacebound Energy

Greenhouse Effect





Beyond the Clouds

Analyzing satellite images of
world-wide cloud cover



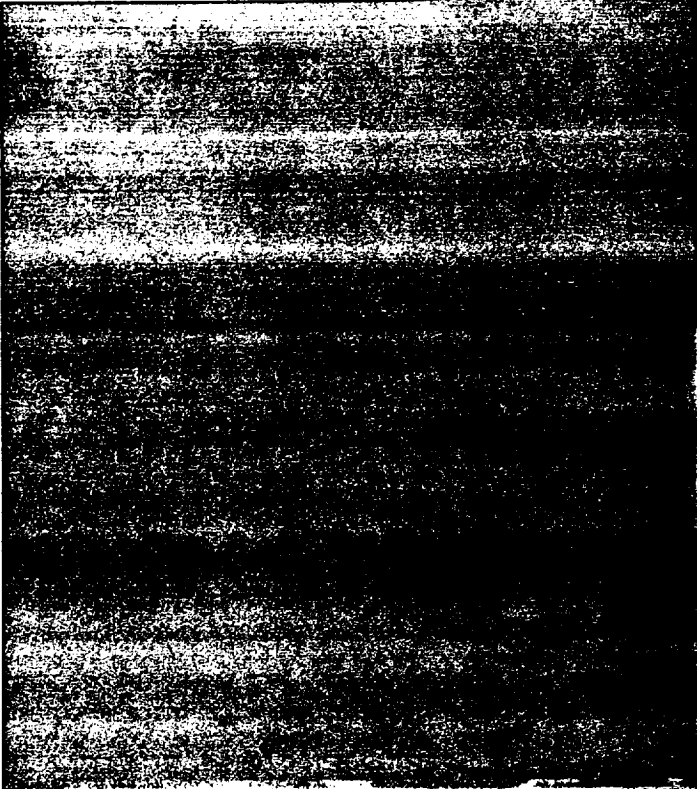

Click on the words in red to learn their definitions

How do clouds form?

Clouds form when water vapor in the air turns into droplets of water or ice crystals. These droplets form on tiny particles of dust or pollution that are in the troposphere. The droplets remain in the air because they are so light. These droplets form clouds that play an important role in the Earth's climate by affecting the amount of precipitation a region will



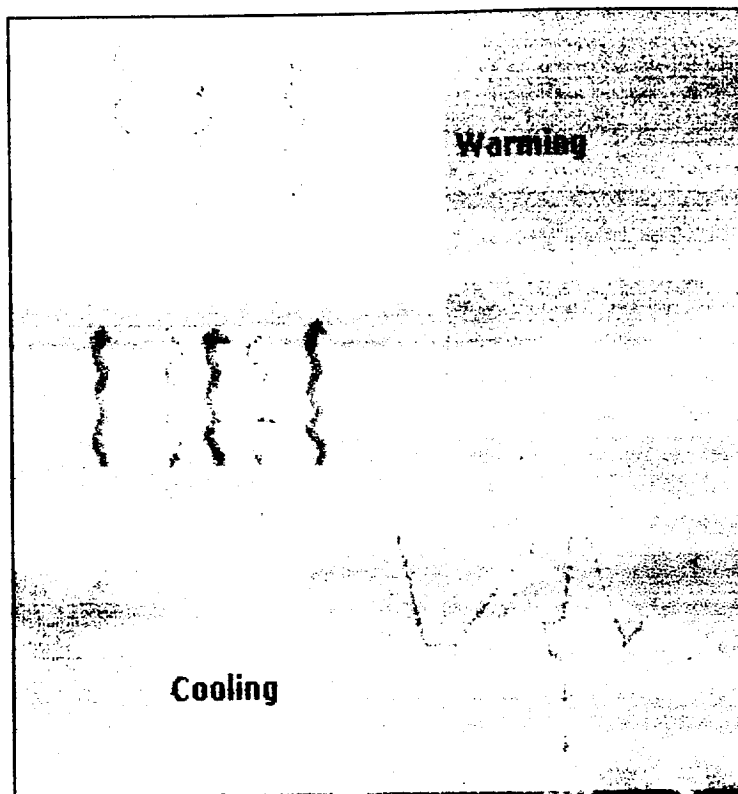

Warming

Clouds do both!

Warming

- Clouds warm the Earth by trapping the radiation re-emitted at the Earth's surface. Without clouds this heat would be lost into space.

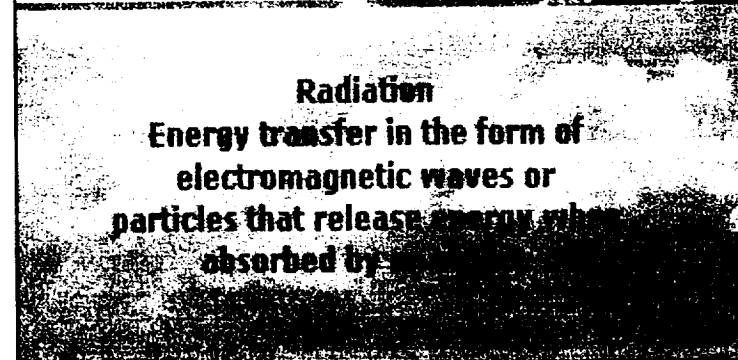

Cooling

Cooling

- Clouds reflect incoming solar radiation which limits the heat absorbed by the Earth, just like heat is reflected from the outer surface of a white house.

Radiation
Energy transfer in the form of electromagnetic waves or particles that release energy when absorbed by an object.



Using HTML as a Collaborative Work Tool For Middle School Students

Brian Giza

The Regional Collaboratives For Excellence In Science Teaching

SZB 356, U. T. Austin, 78712

(512) 471-9279

bhgiza@tenet.edu

<http://www.edb.utexas.edu/regcol/>

personal website:

<http://www2.cibola.net/~bhgiza/>

Abstract

As the gulf between technology haves and have-nots increases, educators benefit from understanding how the most common tool of internet collaboration, Hypertext Markup Language, may be used in their own classrooms. A classroom which may have computers, but lack a direct internet connection, can still use HTML off-line as a collaborative work tool, preparing students and educators for an increasingly on-line world. This document summarizes the training approach taken by the Texas Regional Collaboratives in educator professional development for the use of HTML in schools.

Introduction

Most people believe that the internet is a giant network of computers connected together throughout the world – and it is...partly...But the internet is really something even more fundamental and less well understood. The internet would more accurately be described as a set of...

(what do you think?)

Protocols (an agreed-upon method for doing things)

Setting The Context For The Classroom - Collaboration in the development of the World Wide Web

The internet is not run by anyone, or controlled by anyone, in the classic sense, but there are international standards organizations which have committees to agree upon how computer networks can connect and share information. There are a lot of different kinds of networks, and many have proprietary protocols, but if a network uses the agreed-upon international standards, it is capable of sharing data or collaborating via the "internet" in the popular sense, that subset of protocols and organizational structures which is commonly called the World-Wide Web - the largest and most powerful network ever developed.

The process of working together to set standards is not about permission hierarchies or control ... it merely means that a process is in place to ensure that a computer network can speak a language common to other networks. Collaboration and information sharing is more important in this process than the market-driven proprietary approaches which have been so valuable in creating innovative solutions to networking problems. This philosophical position, that common standards and the free flow of information is pre-eminent, has not been universally endorsed, and some fascinating battles are playing out in the marketplace today. There is an intriguing tension between individual, often highly creative proprietary approaches which move the technologies forward, but which butt heads with the drive toward common standards.

These protocols are good for collaboration, and cooperative work was what they were developed for, by military, research, and university collaborators, so that they could share information and communicate over great distances, no matter where they are, or what type of computer or operating system they are using.

People agreeing about how computers can talk to each other so that they can too...a nice concept generally.

Of course, some of the most vitriolic and intense verbal battles may be witnessed on the usenet as advocates for various platforms or approaches exchange ideas in the "comp.infosystems" newsgroups ... but we will emphasize civility for now...

During the 1980's a young physicist named Tim Berners-Lee used a form of HYPERTEXT (electronically linked documents) to keep track of his own research, and he eventually became a key advocate of this tool. helping others to use this method of connecting information together. It worked very well on the big main-frame multi-user UNIX computers he and his co-workers at Europe's CERN research institute used.

Berners-Lee continued to collaborate with his fellow physicists in the U.S.A. and elsewhere, using the early version of the internet available then --actually little more than a way of sending e-mail back and forth. In late 1991 he sent out a message to many of his co-workers who had also begun to use hypertext, inviting them to join an electronic mail LIST, or central place to send and receive e-mail. The subject of the list was to improve hypertext communication and collaboration over networks. Since there were so many types of networks developing, collaboration was going to take some agreement, and maybe even some argument about standards. These e-mail messages were archived, and can be retrieved by anyone knowledgeable about the process. Here is that first message:

WorldWideWeb mailing list: Introduction
Tim Berners-Lee (timbl)
Mon, 28 Oct 91 16:33:14 GMT+0100

We have (at last!) started the www-interest mailing list. Your name is, for one reason or another, on it. The list is a list for announcements about the World Wide Web (W3) distributed information system, mainly about o New online information available o New W3 software releases If you do not want to be on this list, please accept our apologies and mail listserv@info.cern.ch with the message body delete www-interest (small piece cut out by me for brevity) If you have any queries for a human response, mail www-interest-request@info.cern.ch.
Tim BL

Towards the end of 1992 there was a new person adding his e-mail messages to the list, a university graduate student by the name of Marc Andreessen, who worked for NCSA at the University of Illinois in Champagne. He posted this message:

html & emacs
Marc Andreessen (marca@ncsa.uiuc.edu)
Mon, 16 Nov 92 20:21:23 -0800

Anyone written code to construct HTML files in Emacs?
I'm hacking something up; let me know if you're interested....Marc

A little while later Andreessen, now a regular poster to the listserve, submitted a message announcing the release of his "hack" -- a very creative bit of software which allowed a user to click on text links to jump from one document to another, and which displayed pictures seamlessly along with the text. This product, which was released for free, was called MOSAIC, and soon after that Andreessen, in his early to mid

twenties, started a company called NETSCAPE, to commercialize the product. The stock made millions the first day it was released...

Marc Andreessen (marca@ncsa.uiuc.edu)

Thu, 19 Aug 93 03:27:42 -0500

You may be happy to know that I have before me a Mosaic running a quite revised HTML widget, thanks to Eric's kamikaze work ethic, that includes the following features: No more document pages or large virtual windows - everything is managed by the widget itself (including scrollbars). (TEXT REMOVED BY ME FOR BREVITY) Jumping to anchor in document in new window (e.g. using middle button) now works.

Performance

performance

performance!

(Really!) In addition to Eric, I'd like to thank my mother, Roy Buchanan, Johannes Brahms, Cariann and Amy at Espresso Royale, Pepperidge Farm, J. Crew, Smith Barney Hutton Shearson Lehman Brothers And Sisters, Mystery Science Theatre 3000, the State of Idaho, and Bill Clinton for these breakthroughs. G'night, Marc

In Sum:

- The World Wide Web is a special form of the internet which uses Hypertext (associated with Tim Berners-Lee), and graphic-based software tools (like NETSCAPE, developed by Marc Andreessen) to simplify sharing and displaying information.
- It is perfect for schools, and IT WILL WORK WHETHER A COMPUTER IS ATTACHED TO A NETWORK OR NOT. We will discuss that further in the next section.
- It is the perfect tool for collaborative work groups: It was developed for that purpose, and since it is so easy to use, a middle-school student can learn to use NETSCAPE and Hypertext Markup Language (HTML) to present group reports or write papers quickly and easily.

Making HTML Easy and the internet EASY to learn and use

Question: What is the "Language Of The Internet"?

Answer: The common internet protocol most often uses a document language called HTML ("HyperText Markup Language") to share information. HTML is an easy-to-learn system for controlling how text and images are displayed and transferred from computer to computer - or even just on one computer, without a network.

HyperText Markup Language is a text-based protocol designed to transmit information about the way a document has been formatted. Every word processor does the same thing, and most do it in their own special, proprietary way, which is why it is so difficult to open a Word 6 for Macintosh document in WordPerfect, for example. Each word processor uses somewhat different hidden codes to save information about tables, bold or italicized text, headings, etc. This text manipulation process is known as document markup and the codes often use obscure and hidden symbols or characters. HTML is just an agreed-upon text-based protocol to do markup without odd or proprietary characters. It is especially capable of doing two main things:

- 1 - Exchange documents, including document formatting information as asy-to-read and platform independent text.
- 2 - include addressing, linking, or hyperlinking information within the document.

If you format text and then save it as "RTF" text (Rich Format Text), it stores the formatting information as hidden coded text. You can see this by opening an RTF file with a plain text editor such as Notepad in

Windows, or Teachtext on a Macintosh. In many word processors you can "reveal codes" to see the formatting. In the images below you can compare how this is done:

Image 1: (insert image titled "paracode.gif" here)
This image shows how Word 6 paragraph formatting can be revealed, showing its special characters.

Image 2: (insert image titled "rtfsampl.gif" here)
RTF was a common cross-platform document markup standard which also used plain text formatting – but was complex and not easy to create by hand.

Image 3: (insert image titled "htmsampl.gif" here)
HTML greatly simplifies the understanding of document markup with intuitive formatting "tags" or codes, allowing even middle school students to quickly learn to manipulate documents with its language.

There is even better news: Now that HTML has become such a popular standard, most word processors permit you to save documents as HTML, just by choosing that file type in the "Save As" menu. As a matter of fact, that is one good way to learn HTML, by comparing the HTML created by a modern word processor when saving an existing document with HTML created from scratch!

In addition, there are a lot of computer software companies working as hard as they can to dream up the best way to make life simpler and easier for people who want to create HTML documents from scratch. These "Web Editors" are often very powerful, and very cheap.

There are several software "Web Editors" which will even check your HTML syntax, identifying errors and highlighting them for you. Some of the most powerful ones are absolutely free. One example of this type of HTML-checking web editor is "Webber", a PC-based tool from Expertintelligence Corporation. Another popular Windows-based tool which is small enough to fit on a floppy together with the files it creates, which includes an integrated preview browser, and which is free, is DIDA by Godfrey Ko. It can be given to students to take home with them, furnishing them with all the HTML tools they need in one small file. Webber and DIDA suffer from being Windows-only though.

A very useful cross-platform tool which has a whole suite of features, which works virtually identically in both the Mac and Windows versions, and which contains an integrated preview browser is AOLPress, available free online. It is one of the best values for Mac users, and has an advantage for classrooms with a mix of platforms, since you can train once for both the Mac and Windows user, concentrating on the HTML content issues, and not platform-specific ones. All three of these tools (Webber, DIDA, and AOLPress) will generate a pre-formatted blank HTML page, making the process of getting started much easier.

Teaching and Learning Basic HTML

Earlier in this presentation HTML was described as an agreed upon method for formatting documents which can be transferred electronically, and which stores addressing information within the document. HTML is also very, very logical in human terms. Ask yourself: What would be the easiest way to create a memorable code that would tell a computer to "begin centering here" (insert text of choice) "end centering here" and which would be easy for humans to remember and use? Let us see how HTML does it:

```
<CENTERinsert whatever you want centered here</CENTER
```

The method shown above is the most common and easy to use method for centering things on a page when using HTML. Although it was not part of the original plan it has been adopted by the standards organizations.

In HTML a formatting code is called a TAG. (example: <CENTER)

All HTML tags begin and end with angle brackets: "<" and ">". Most HTML TAGS come in pairs, an opening and a closing version, with the closing, or ending version of the pair being the same as the beginning version, except that the closing tag begins with a slash after the first angle bracket. In the CENTER TAG described above, the opening tag is <CENTER and the closing tag is </CENTER>. HTML is not brain surgery. Kids take to it very quickly.

One concern parents, teachers, and administrators have about the use of the internet in the classroom is that often some students know far more than we do about this technology. That is O.K., though. HTML and the internet has been an important feature of K-12 technology for only about five years...a very small part of an adult's life, but a major chunk of time in the life of a middle school student. A twelve-year-old may have constructed their entire framework of understanding about technology around the idea that the internet is important, and they are often highly motivated to learn about it. So how do we turn this motivation to our benefit? By training peer leaders in appropriate internet use!

When NASA's MU-SPIN program partnered with El Paso's schools and the local Regional Education Center to create a program to develop these peer leaders, the result was the KWIC Kids program ("Kids Writing Internet Curricula"), a successful component in the local technology outreach of NASA MU-SPIN's Network Resource Training Center.

(insert image "kwicert.gif" here)

There are many excellent references for teaching HTML which would complement any program of professional development in use of the internet. Our program recommends two because of their cross-platform approach, as well as simple and comprehensive information: Netscape's guide (some versions of which come with their software), and Elizabeth Castro's Visual Quickstart Guide "HTML and the World Wide Web" (get the second edition, which covers HTML version 3.2).

Basic Stuff:

Almost all HTML documents are made up of two sections:

1: The HEADER, which contains information for the computer and the software to use. Headers begin with <HEAD and end with </HEAD> (Don't confuse headers with the traditional document heading used by many students and teachers in classroom documents - in this case the information between <HEAD and </HEAD> is not for the human reader, and contains information almost exclusively for the software).

2: The BODY, which contains the part of the document that the user will see, including all of the text, graphics, tables, and the formatting information affecting them. The body begins with <BODY and ends with </BODY>. HTML documents begin with <HTML and end with the </HTML tag.

For the rest of this tutorial we will refer to a standard HTML style guide or Template. I usually have students initially copy this template out by hand, or type it on a computer, to get used to seeing HTML tags, and to get a feel for what they mean.

Although HTML coding can be extremely complex, it does not need to be. Some of the most information-rich and beautiful web pages are also the most simple in terms of the code that created them. HTML gets most complex when people try to use it to reproduce desktop publishing documents -- something which it was not designed to do. It was designed for simple information sharing and the linking of documents together in a platform independent way. It is perfect for group reports in a science lab, or to create

"Powerpoint" style multimedia presentations. These kinds of uses can be accomplished by using just fifteen TAGS! It is not unreasonable to expect students or educators to learn such a small repertoire of powerful commands. The benefits for cooperative work in the classroom are potentially very significant.

These first ten TAGS are sufficient to make a simple HTML page without any inline images or hyperlink connections. See if you can figure out what each what each one stands for:

- 1: <HTML and </HTML
- 2: <HEAD and </HEAD
- 3: <TITLE and </TITLE
- 4: <BODY and </BODY (Body includes <BODY BGCOLOR="" and <BODY BACKGROUND="" many tags have extensions, and these extensions are particularly useful in creating attractive pages).
- 5: <H1 and </H1
- 6: <CENTER and </CENTER
- 7: <B and </B (HTML purists prefer <STRONG and </STRONG)
- 8: <I and </I (HTML purists prefer <EM and </EM)
- 9: <P
- 10: <BR

The last five "Key" TAGS are more complicated, but they give HTML its power. They are:

- 11: <IMG SRC="imagenam.gif" (where imagename.gif is the name of an image file, with the proper extension, such as .gif)
- 12: <A HREF="filename.html"filename.html</A (where filename.html is the name of a file to be hyperlinked to this location - meaning that selecting the name between the opening and closing tag will cause the browser software to move to that page).
- 13: <TABLE and </TABLE
And the table row and cell (table data) tags:
 - 14: <TR and </TR
 - 15: <TD and </TD (the table tags are by far the most complicated formatting tags of these fifteen, but they can be extremely useful in control document layout).

Almost all of these tags can be altered with additional components, but these are things that can be added later. For now, using just these tags powerful hyperlinked and attractive documents can be created.

(insert the image "htmltemp.gif" here)

In the next section we will look at each tag, and add them one by one to an HTML page. I will save each page over and over again, numbering each one and opening it in Netscape to show how the document grows. I suggest saving documents in stages with numbered, consistent names as a standard method for learning HTML. I will begin, though, by making a directory (or folder) for my HTML and images, and I will put all of my versions there. It is good to have this incremental trail of versions to check when mistakes happen (and they will). Fortunately HTML is a very effective discovery learning tool, and students should be encouraged to make errors and compare them to working versions of pages.

Classroom Approaches

Classroom Templates (which may be found on the web at the URL <http://www.edb.utexas.edu/regcol/htm4kids/>). These sample templates take the learner step by step and tag by tag through the process of creating a useful HTML page. In this essay only the first and last versions of the HTML page training templates are included.

Page 01: (the blank HTML document, with just a title)
<HTML

```

<HEAD
<TITLEBG01: Look at where this goes! - on the TITLE BAR!
</TITLE
</HEAD
<BODY
</BODY
</HTML

```

Page 12: (the final page in the template sequence)

```

<HTML
<HEAD
<TITLEBG12:Look at where this goes! - on the TITLE BAR!
</TITLE
</HEAD
<BODY BGCOLOR="#FFFFFF"
<CENTER
<H1This is color #FFFFFF (white) - you may use any combination of six numbers 0-9 and letters A-F for
colors</H1
</CENTER

```

Now we will add some <Bbold</B text - and some <litalicized</I text <P

We have added a paragraph tag between the line above and this one. Add your paragraph here by replacing this text with your own.

```
<BR
```

And we have added a line break between the line above and this one

```

<P
<IMG SRC="picture.gif"
<P
<A HREF="nextpage.htm"nextpage.htm</A
<P
<Center
<TABLE Border="1"
<TR
<TDThis is in the first table cell</TD
<TDThis is in the second table cell</TD
</TR
<TR
<TDthis is in the third table cell</TD
<TDthis is in the fourth table cell</TD
</TR
</TABLE
</Center
</BODY
</HTML

```

Now: A five day classroom exercise for middle school. This is a five step sequence of lessons for using HTML as a collaborative work tool in a middle school classroom (This assumes a five-day, one period-per-day week, and that Netscape and a simple text editor such as Notepad or Teachtext is available on a computer in the classroom). Of course teachers should adapt this to their own situation.

Day 1:

Show students the "Standard HTML Style" template and have them copy it onto paper. Then have each student write three paragraphs on three separate pieces of paper: a paragraph about themselves, a paragraph about their family or school, and a paragraph about their favorite interest.

Day 2:

Students create three HTML files on paper, replacing the phrase "this is where you write your text" with their own paragraph on the Standard HTML Style template presented earlier. They may disregard the

subsequent paragraphs for now. If time permits they may use the computer text editor to begin writing their HTML, saving the files as plain text (no formatting) with the name "their initials-number.htm" (Since my initials are B.G., my first filename would be bg01.htm). We use the htm extension instead of html to ensure compatibility on all systems, even older DOS ones.

Day 3:

This day is usually spent writing the HTML on the computer. Remember to save each student's file with a distinctive name, and make sure that each file ends with the extension .htm (it is best to use all lowercase, and to never use any spaces). I create a directory or folder for each student to avoid conflicts. Day 4: The tricky part: Open Netscape, and using the File menu command OPEN: File browse for each student's file and display it. There will be mistakes. This is the learning process. Have students see if they can identify errors in each other's files. Try changing things (making fonts bold, or centering parts of text). Save each file separately as bg02.htm, bg03.htm, etc., each time you change it. Then a student can troubleshoot, or watch their HTML evolve.

Day 5:

Add hyperlinks to files, linking them together. A hyperlink from bg01.htm to bg02.htm would mean adding the phrase `<A HREF="bg02.htm" bg02.htm</A` on the document named bg01.htm. When it displays in Netscape you will only see the underlined term "bg02.htm", and clicking on it with a mouse will make Netscape jump to that file and display it (if the file is in the same directory with bg01.htm). Now try adding images and linking files from student workgroups together as one hyperlinked project made from many pages! Adding images: Using digital images saved in either jpg or gif format, you may add a picture to your student's directory, and then create a link that displays that picture on their page by use of the `<IMG SRC="picname.gif"` tag. Make sure to have both brackets (< and), to name files inside of quotes within a tag, and to never have spaces in a name. I use uppercase for tags, and lowercase for filenames, to make things easier to troubleshoot. Expect mistakes and enjoy them! Feel free to visit our website to see this training in action, or to contact me via my e-mail address of "bhgiza@tenet.edu". Good luck, and remember to have fun!

Geologic Mapping of Mars

Katherine H. Price
Texas A&M University-Corpus Christi
Physical & Life Science Dept.
6300 Ocean Drive, CI-316
Corpus Christi, Texas 78412
kprice@falcon.tamucc.edu
512-994-5721
512-994-2795

Planetary geologic mapping involves integrating a terrestrial-based understanding of surface and subsurface processes and mapping principles to investigate scientific questions. Mars mappers must keep in mind that physical processes, such as wind and flowing water on Mars, are or were different from terrestrial processes because the planetary atmospheres have changed differently over time. Geologic mapping of Mars has traditionally been done by hand using overlays on photomosaics of Viking Orbiter and Mariner images. Photoclinometry and shadow measurements have been used to determine elevations, and the distribution and size of craters have been used to determine the relative ages of surfaces- more densely cratered surfaces are older. Some mappers are now using computer software (ranging from Photoshop to ArcInfo) to facilitate mapping, though their applications must be carefully executed so that registration of the images remains true. Images and some mapping results are now available on the internet, and new data from recent missions to Mars (Pathfinder and Surveyor) will offer clarifying information to mapping efforts.



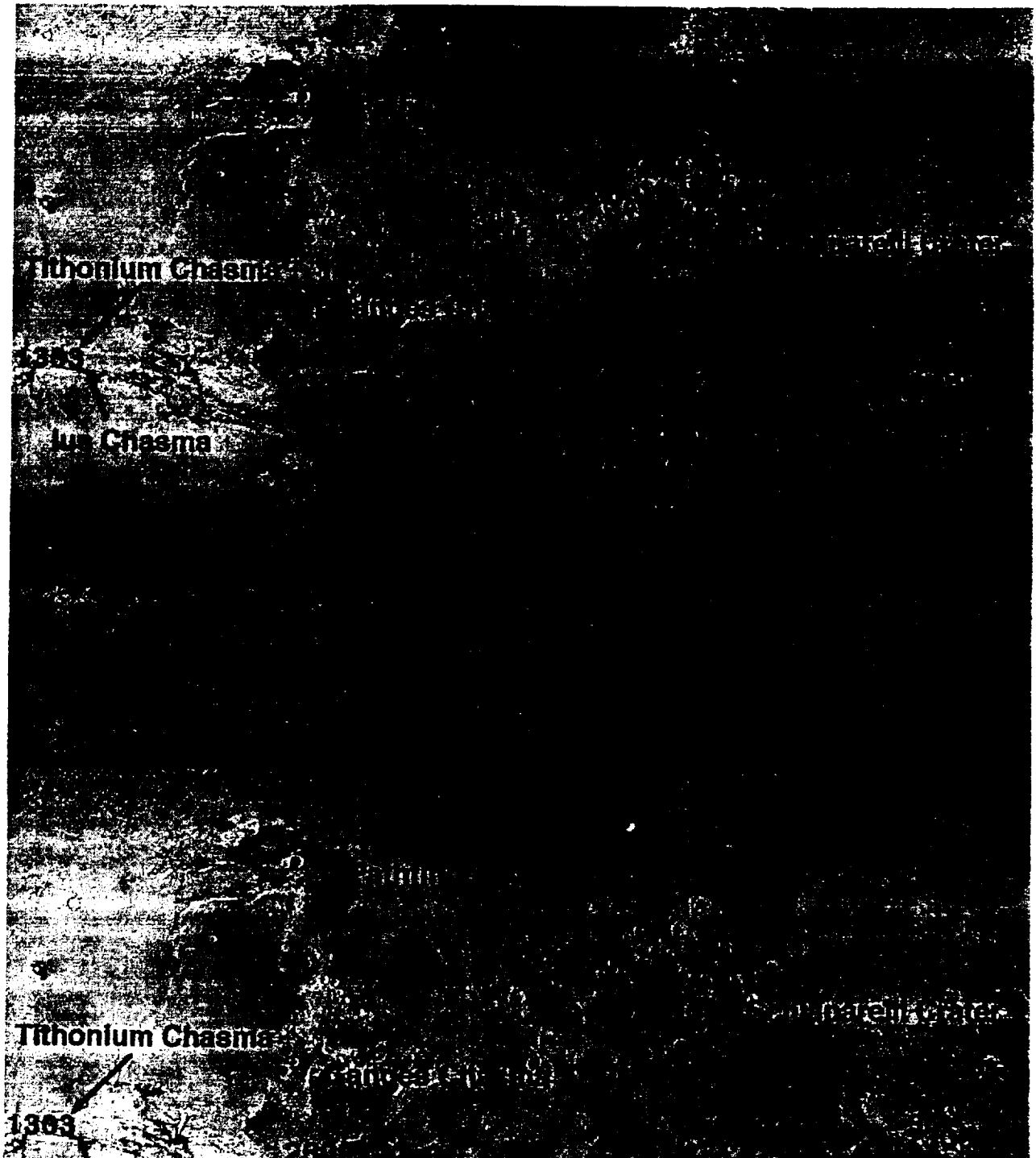

Tithonium Chasma

1303

Chasma

Tithonium Chasma

1303

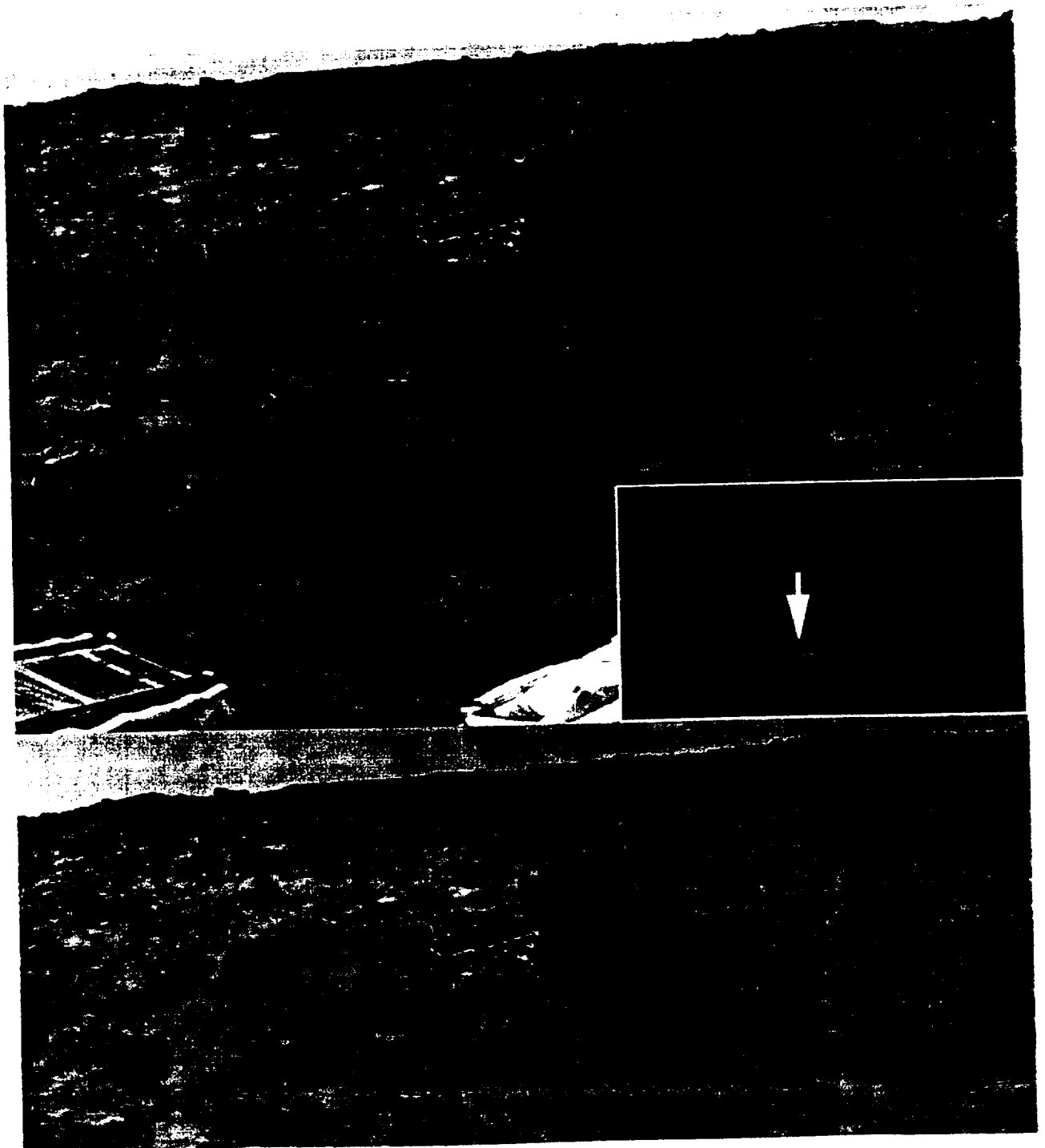

PEBBLES, COBBLES, AND SOCKETS



SHARK - SOL 71

Henry Moore

PEBBLES, COBBLES, AND SOCKETS



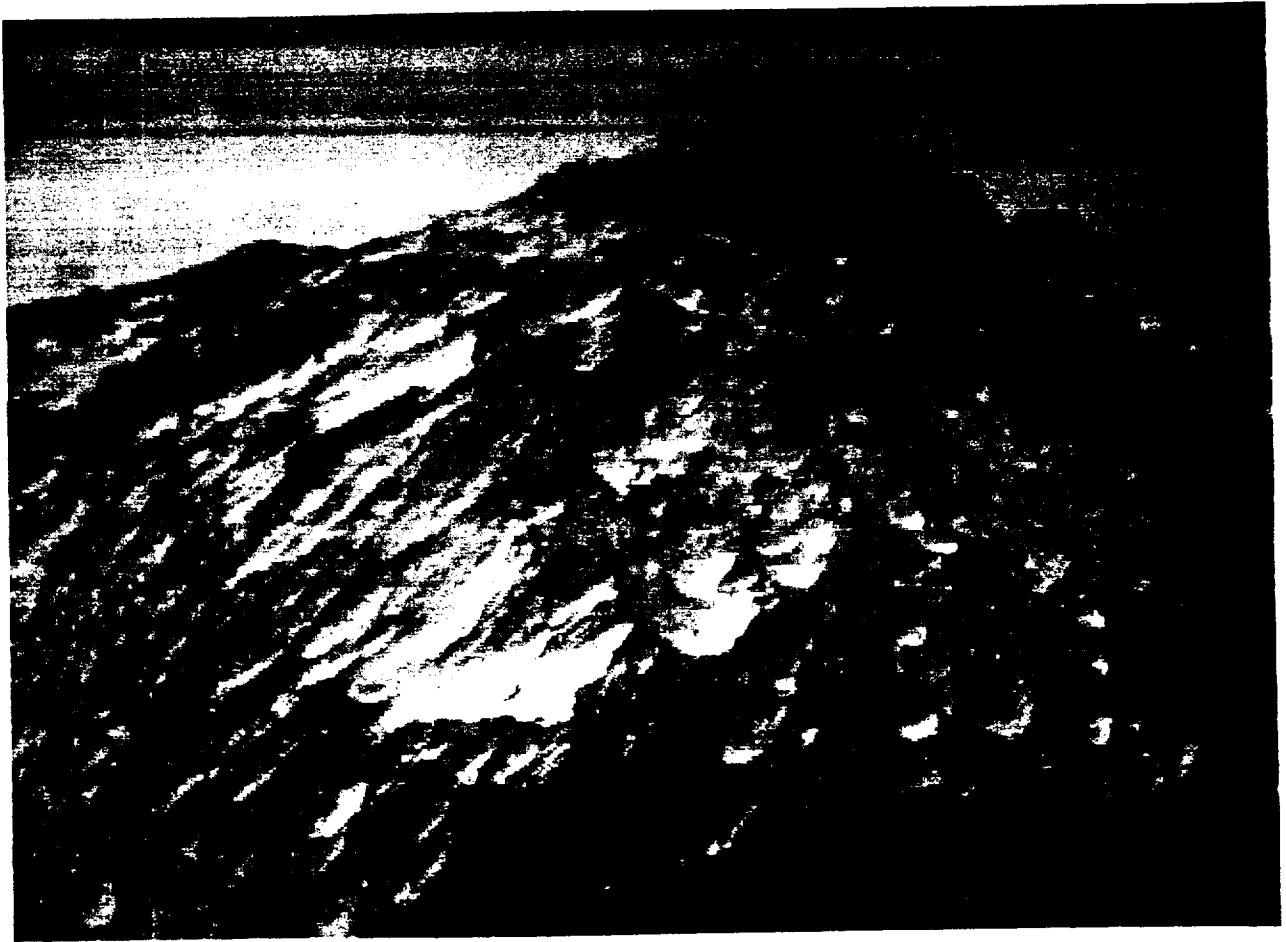

Temperature Profile from Pathfinder Atmospheric Structure Instrument

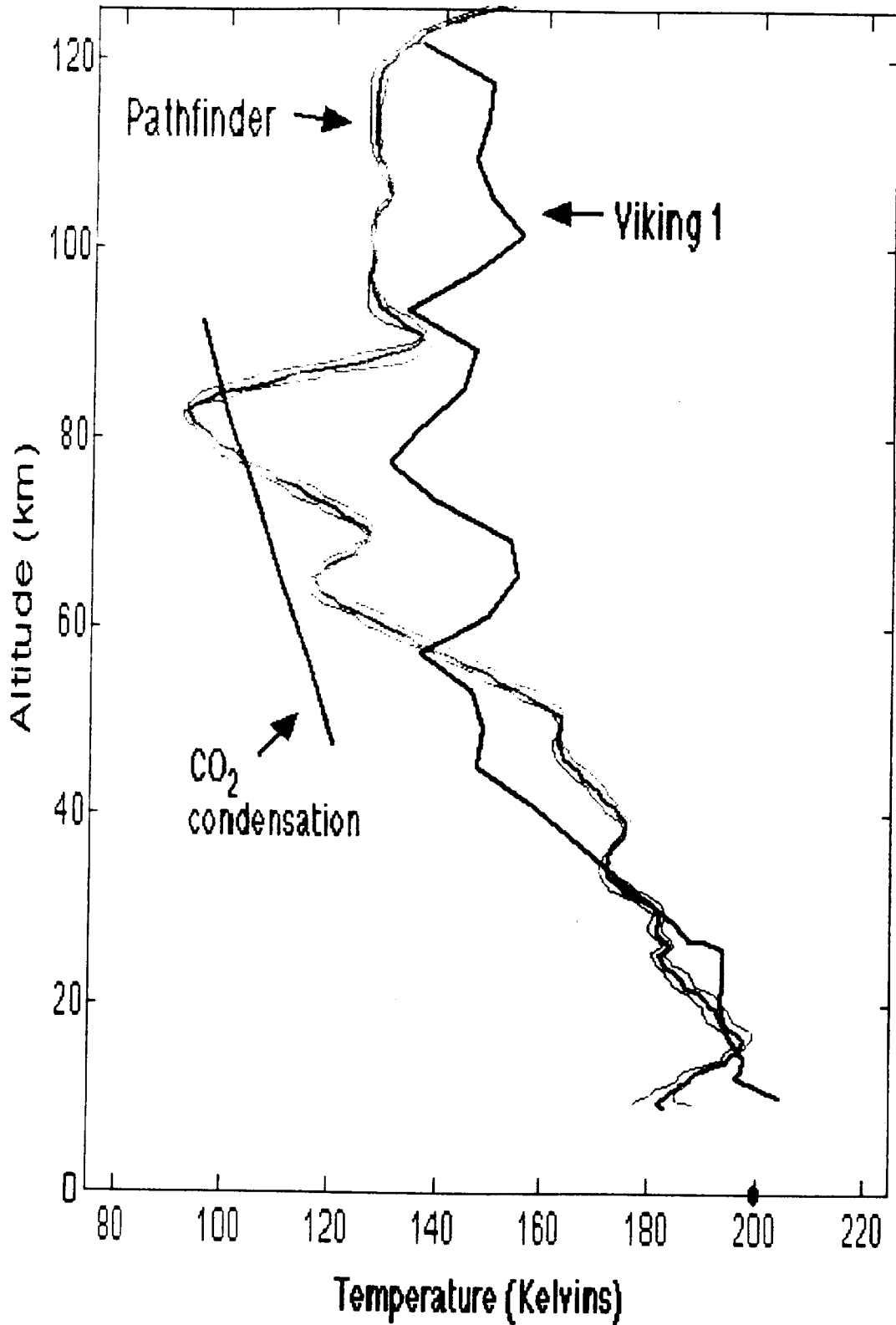

Temperature Profile from Pathfinder Atmospheric Structure Instrument

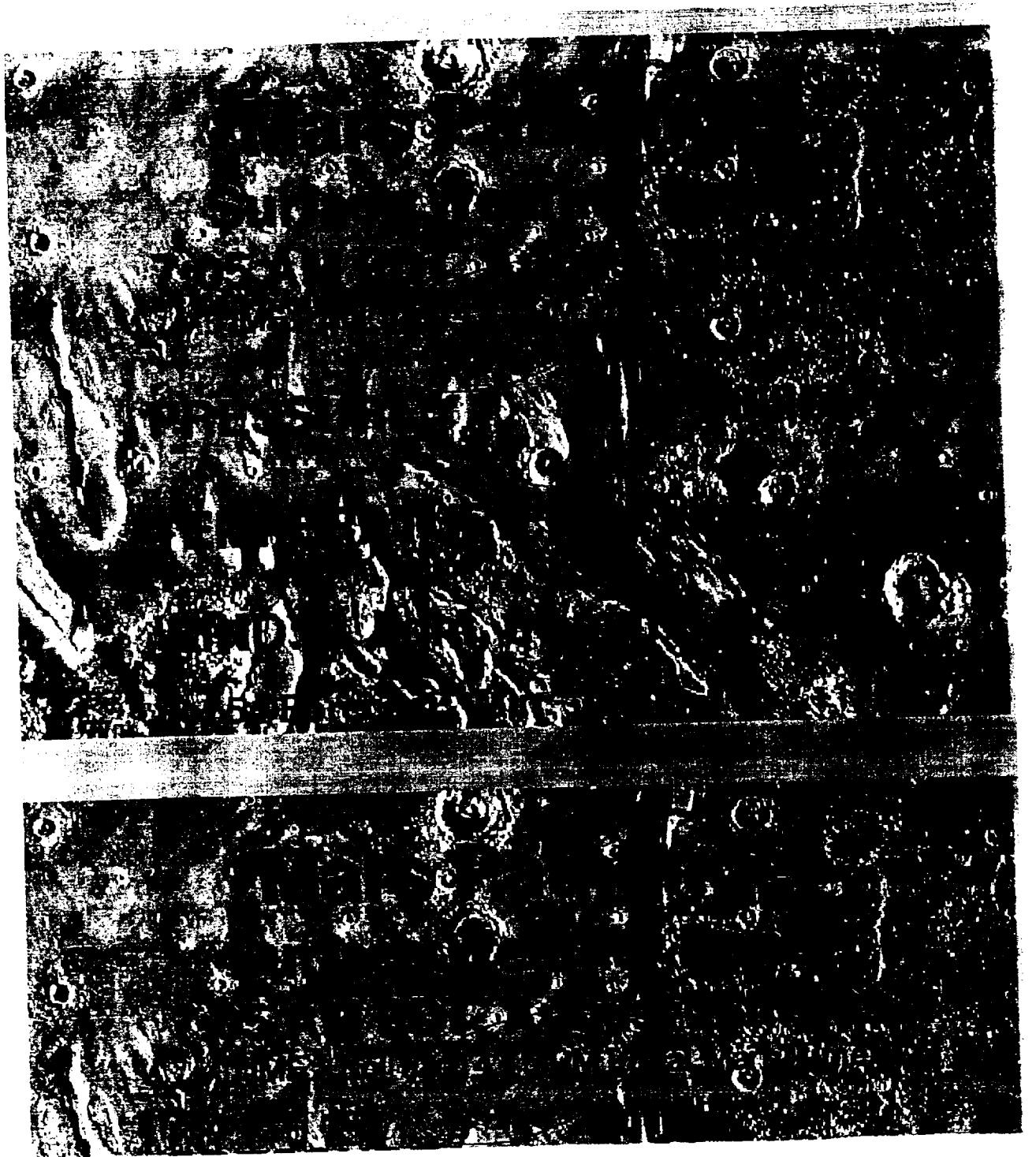

MARS TODAY

9/17/97 12:00:00Z

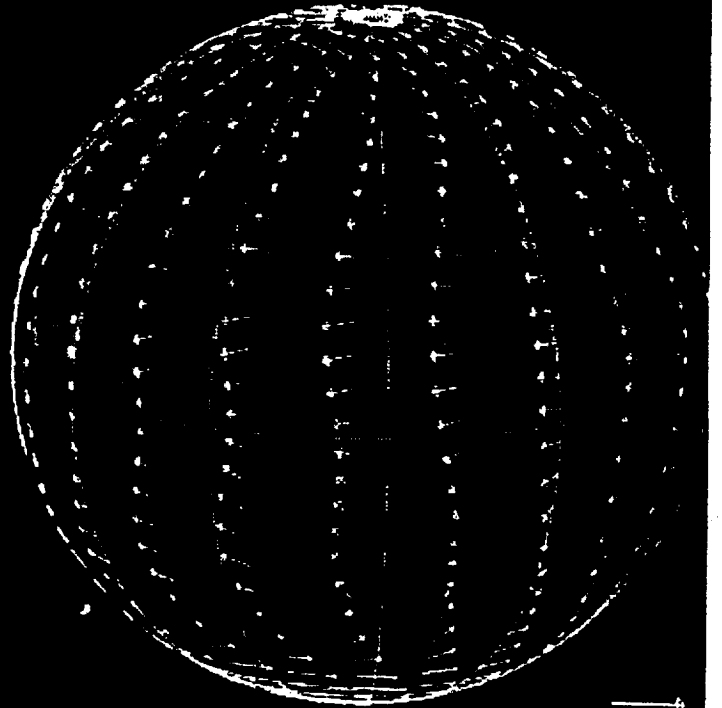
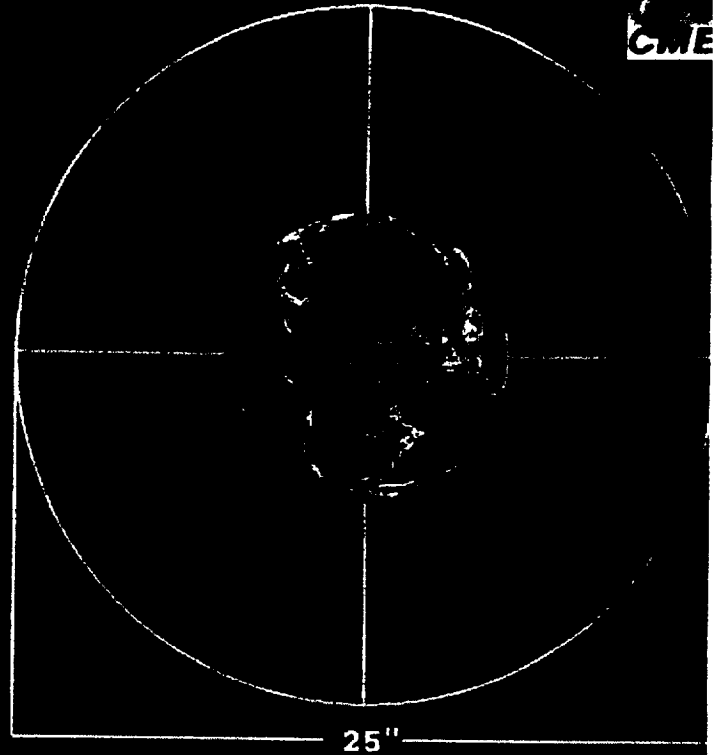
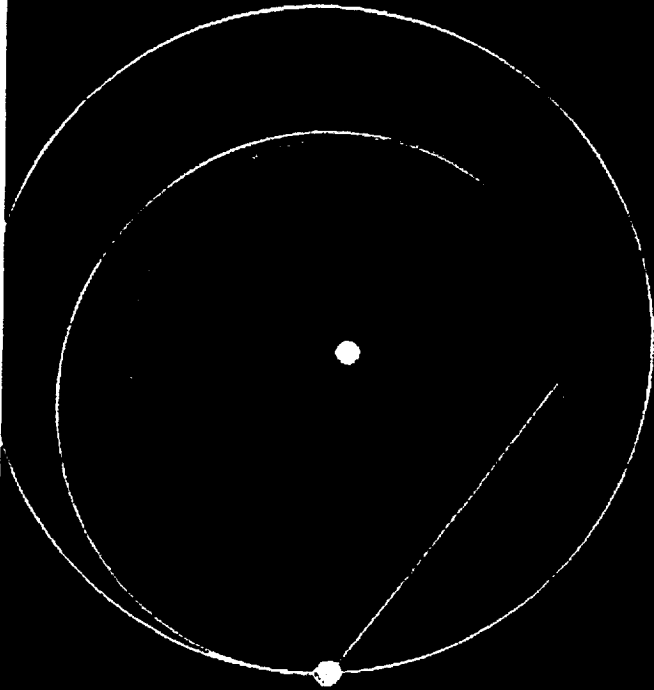

Temperature (K)

Diameter: 5.42 Phase Angle: 35.49
Ls: 182.61 Ds: -1.11
Longitude: 214.38 De: 14.17



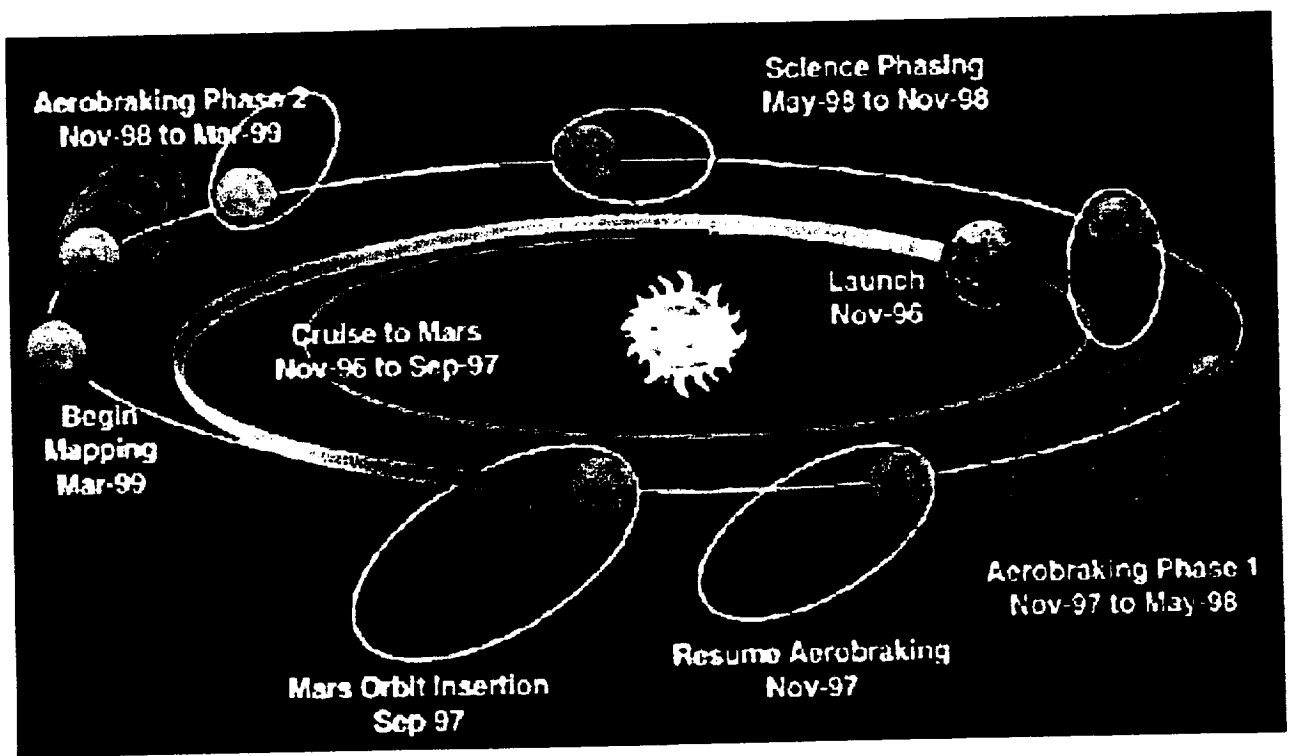

MGS - MOLA

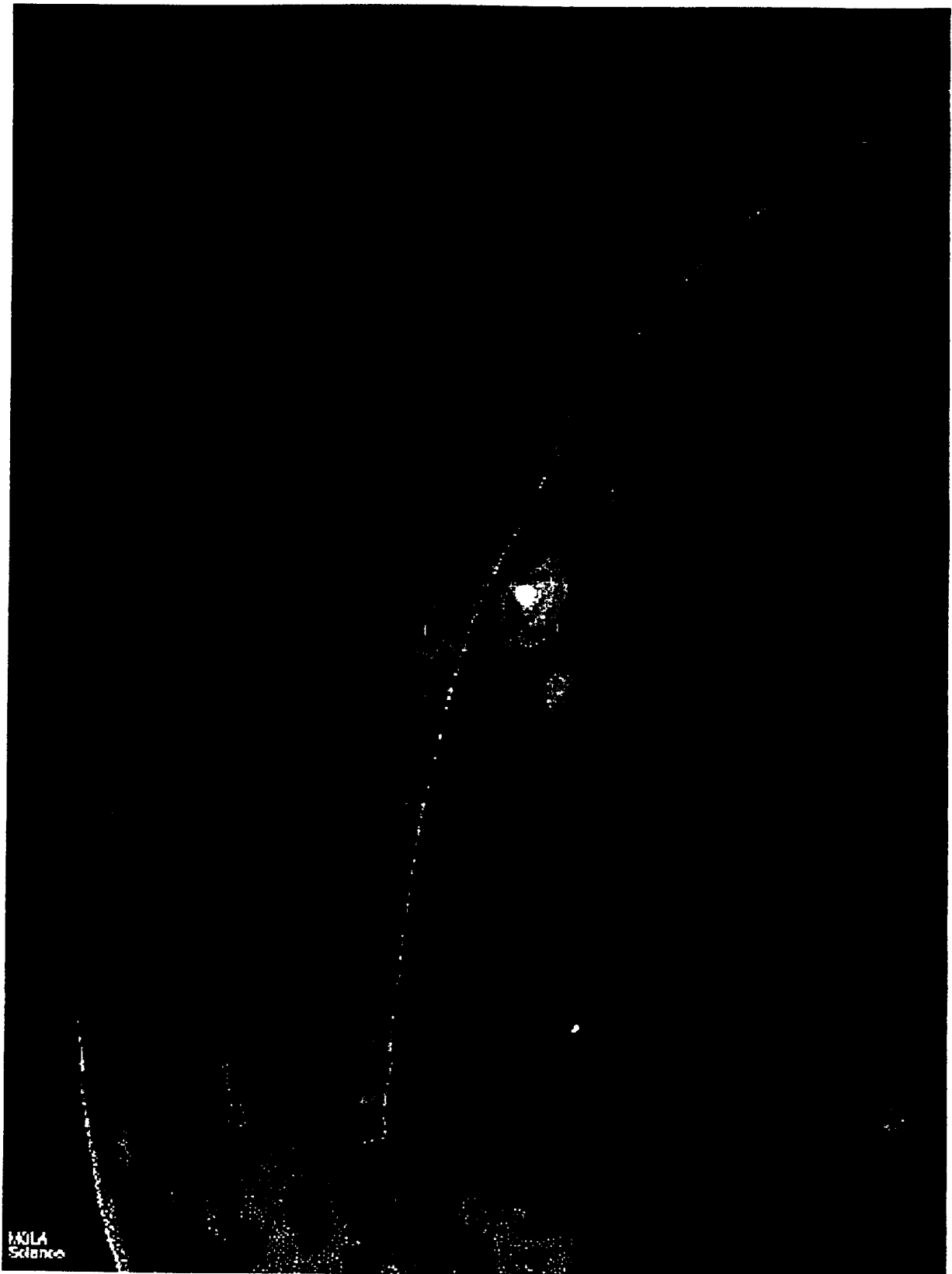

MOLA
Science



414

414



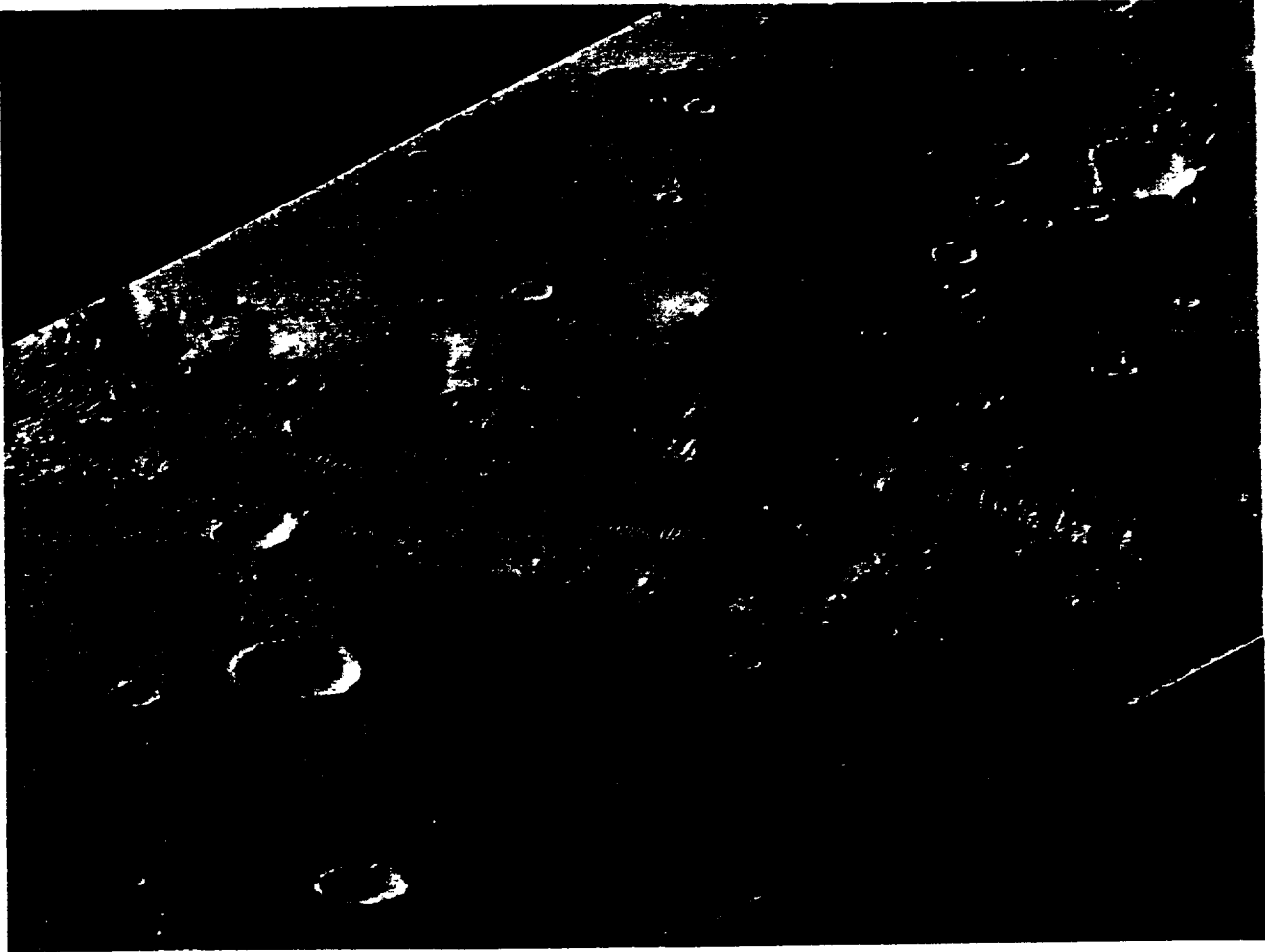

Advanced Networking and Technology

*Ms. Bessie Whitaker
NASA Ames Research Center*



NASA Research and Education Network
and the
Next Generation Internet

Tomorrow's Networking Applications Today

Christine M. Falsetti, NREN Project Manager
Bessie Whitaker, NREN Deputy Project Manager



Next Generation Internet

- Announced by President Clinton on October 10, 1996
- Partnership between government, industry, and academia
- Goal is to help create the foundation for the networks and networked applications of the 21st Century
- Administration is committed to at least \$100 million/year for 3 years
- Key agency players include DARPA, Energy, NASA, NIH, NIST and NSF

NASA RESEARCH AND EDUCATION NETWORK

Tomorrow's Networking Applications Today



Vision

- *Extend U.S. technological leadership in computer communications through a program of research and development that advances leading edge networking technology and services.*

The NASA Research and Education Network (NREN) project and its existing network is the basis for implementation of the NASA NGI plan



Objectives:

- *Improve distributed application performance over networks*
- *Act as a catalyst in the integration of high performance networking technology*
- *Provide nationwide prototypes for terrestrial, satellite, wireless and wireline communications systems.*
- *Ensure that different types of networks work together as a cohesive system.*



NREN's Goals

- **Application: support demonstration of next generation applications requiring advanced networking technologies**
- **New technologies and services: sponsor research and development in new networking technologies and services in support of the high performance applications requirements**
- **Testbed(s): build a high performance network infrastructure in support of both network research and science applications research**



NGI Goals

1. *Promote experimentation with the next generation of network technologies*

2. *Develop a next generation network testbed to connect universities and federal research institutions at rates that are sufficient to demonstrate new technologies and support future research*

3. *Demonstrate new applications that meet important national goals and missions*

Metrics

- *quality of service including security*
- *adoption of technologies by private sector*
- *ability of network testbed to accommodate goal one research results and goal three applications*
- *100-1000 times end-to-end performance improvement*
- *about 100 research institutions connected*
- *100+ high-importance applications*
- *value of applications in testing networking technologies*



Target: Three Dimensional Networking

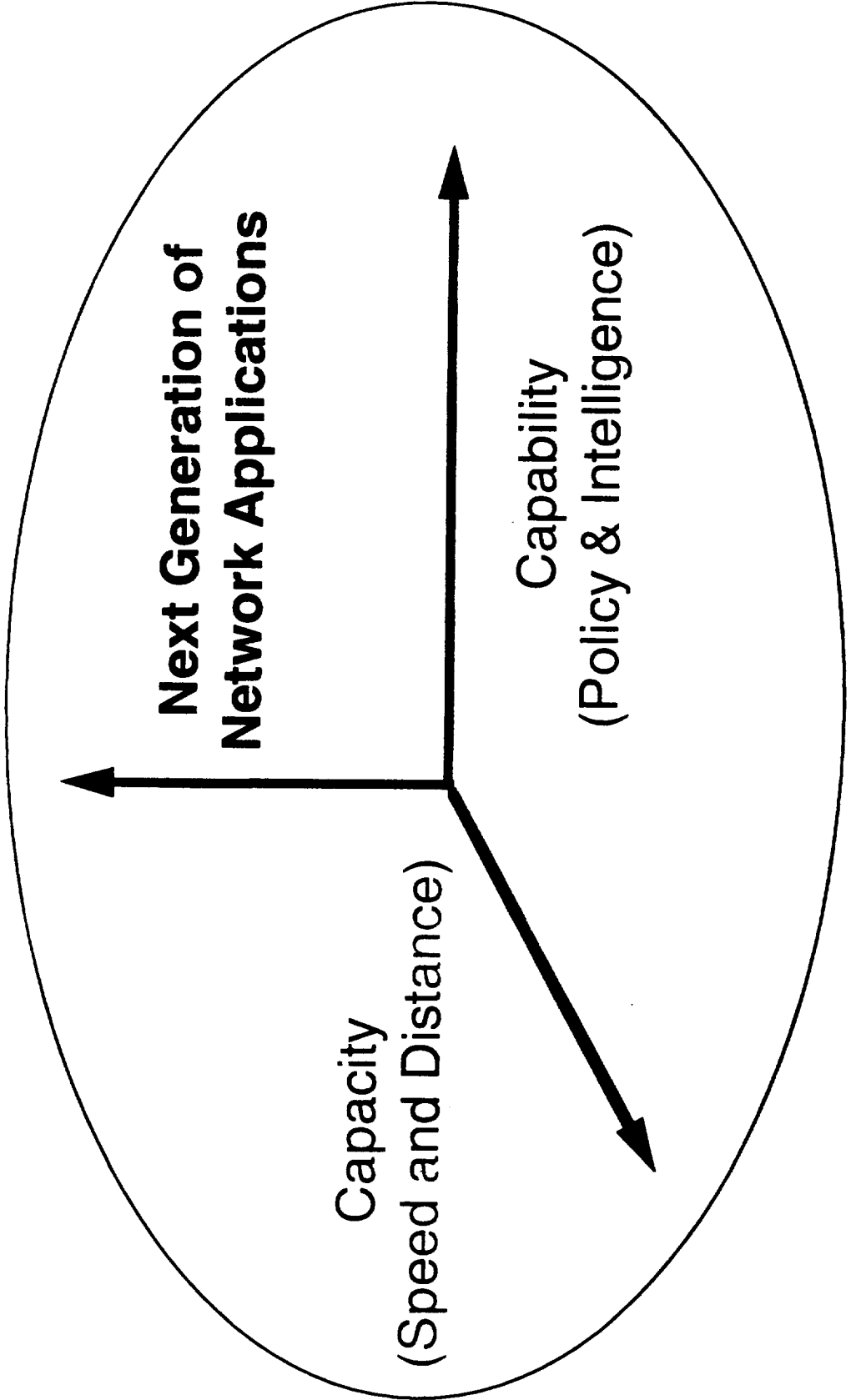

NASA RESEARCH AND EDUCATION NETWORK

Tomorrow's Networking Applications Today



NGI: Foundation for the Future

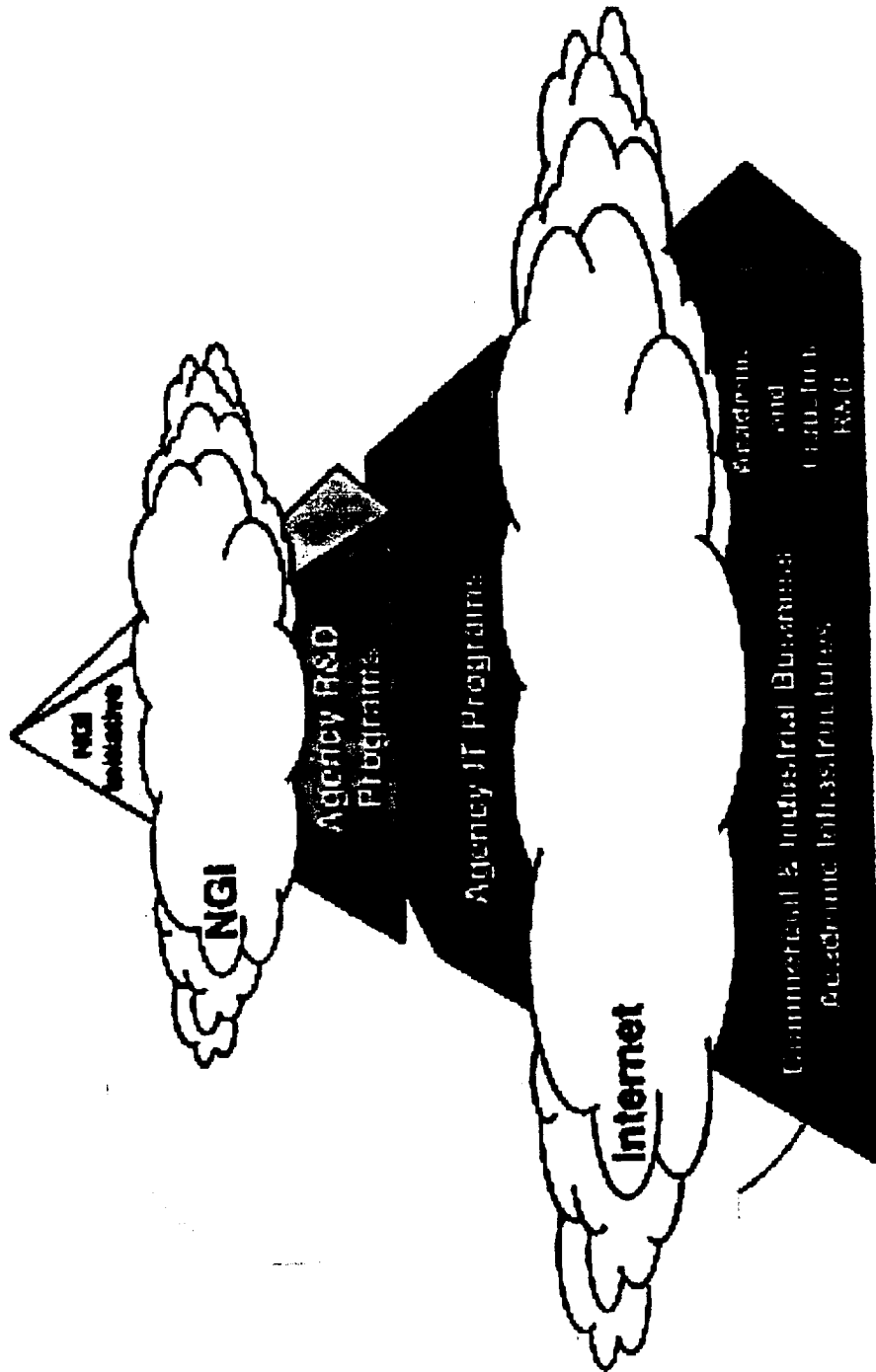

Strategy: Partnerships

Gov't., Industry & Academia

Research & Development

Applications & Technology Demonstrations

Technology Transfer

Results

- Increased Scientific Productivity
- Increased Mission Success Probability
- Enhanced Science & Technology Transfer Mechanisms
- Increased Service Reliability



Next Generation Internet Architecture

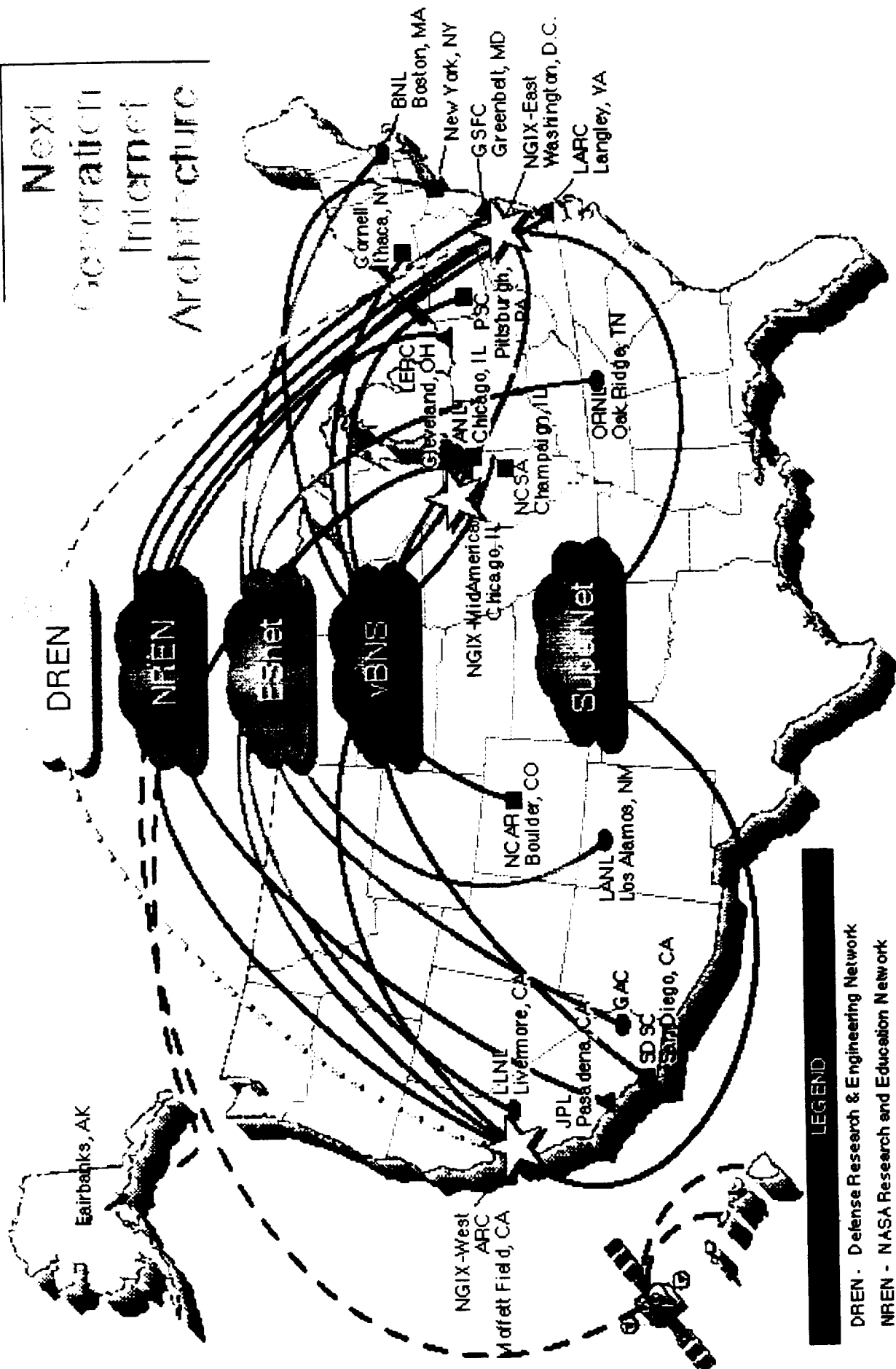

- LEGEND**
- DREN - Defense Research & Engineering Network
 - NREN - NASA Research and Education Network
 - ESnet - Energy Sciences Network (DOE)
 - vBNS - Very High Speed Backbone Network Service (NSF)
- NOTE: vBNS will support initial Internet 2 community
- SuperNet - Terabit Research Network (DARPA)



Network Classifications

- **Class 1** **Networking Research**
 “Bleeding Edge, breakable Networks”
 Ex.: CAIRN, NTON, SVTT, MONET, ATDnet, AAI
- **Class 2** **Research Networks**
 “Leading Edge, Advanced Application Enabled”
 Ex.: NREN, ESnet, VBNS, DREN
- **Class 3** **Operational Networks**
 “State-of-the-art technology”
 Ex.: NI, Aeronet, NSF Connections
- **Class 4** **Production Networks**
 “Commercially available technology”
 Ex.: ISP, SprintLink, MCIOne, AT&T, @Home, etc.



Internal Technology Transfer Model

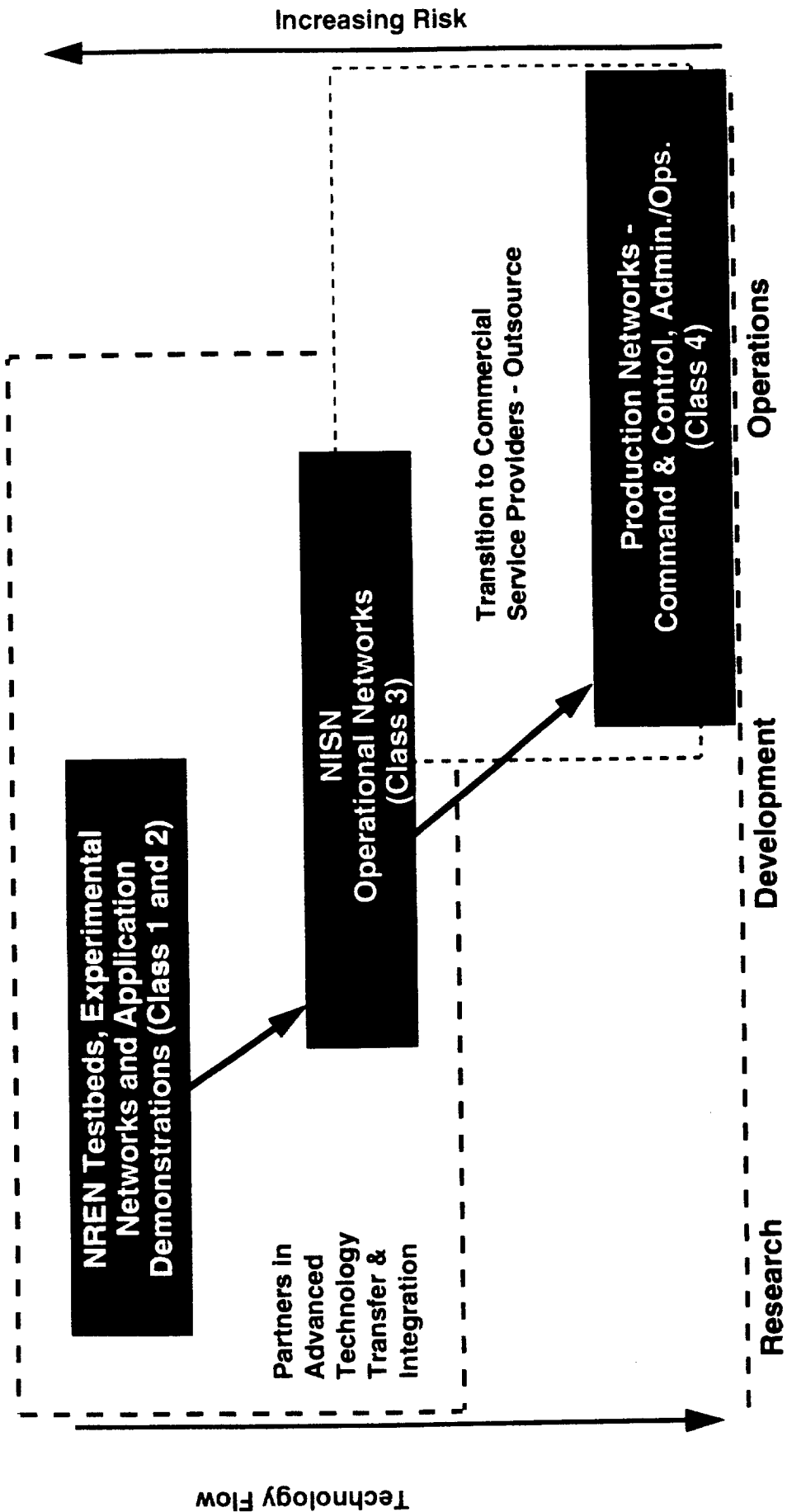

NASA RESEARCH AND EDUCATION NETWORK

Tomorrow's Networking Applications Today



Impact of the NREN Program

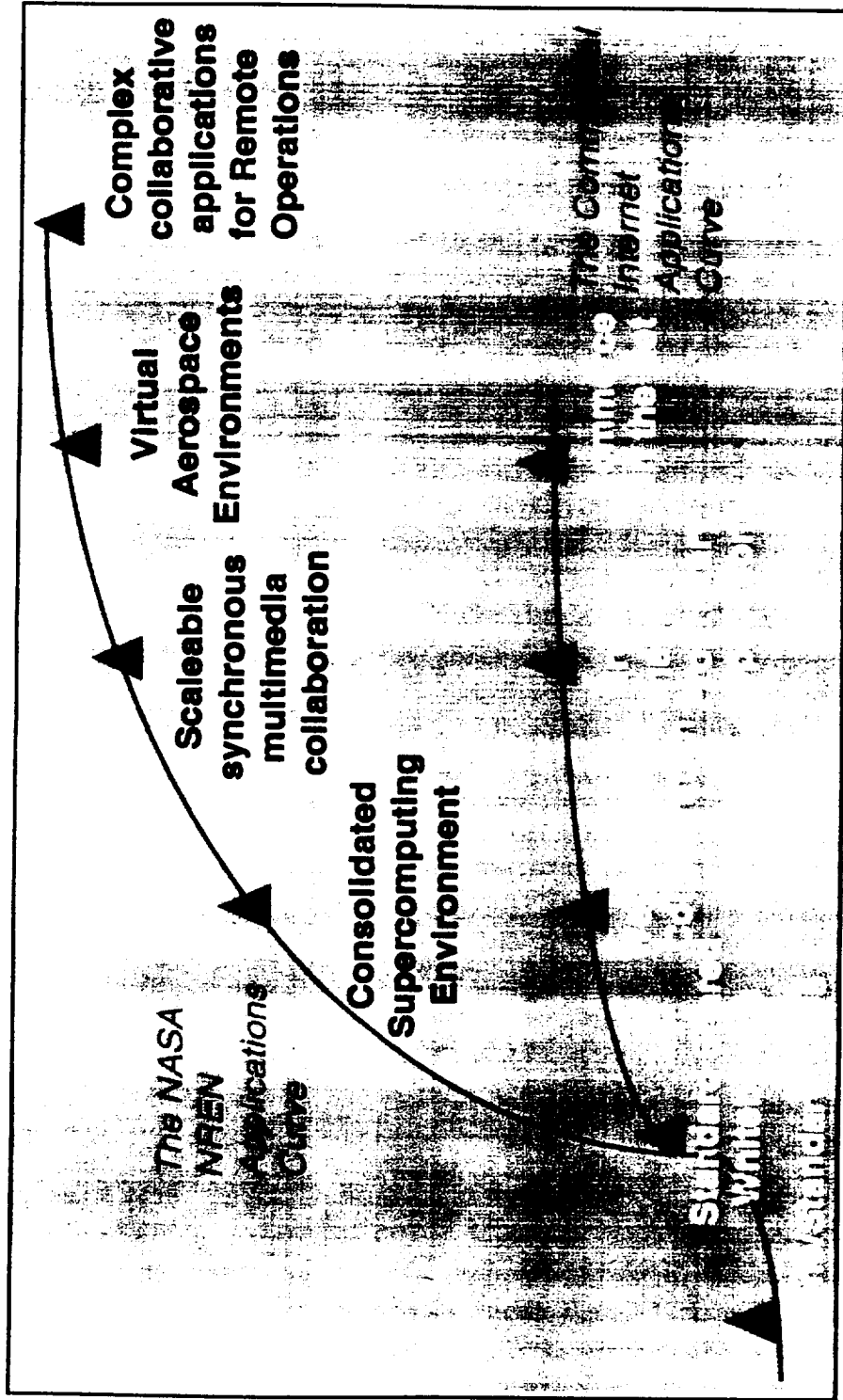

FY96 FY97 FY98 FY99 FY00 FY01

Time



Network Technology Services

- *High bandwidth*
- *Bandwidth reservation*
- *Low latency*
- *Low jitter*
- *Nomadcity*
- *Real-time*
- *Variable priority*
- *Strong Security*
- *Adaptable Net Management*
- *Selectable Loss Rate*
- *Scaleability*
- *Multicasting*
- *....*

NASA RESEARCH AND EDUCATION NETWORK

Tomorrow's Networking Applications Today

Applications

Accelerate network technology development to meet NASA unique requirements today.



Origins - Astrophysics

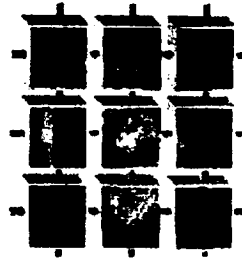

Mission to Planet Earth:
Advanced Earth Sciences Investigations



Space Exploration

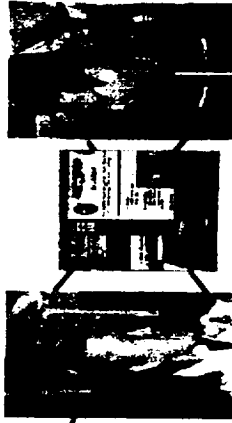

Telemedicine, Interactive Consultations, Remote Protocols and Procedures



Advanced Aerospace Design and Test Tools - Wind Tunnels on-line, Virtual Flight Simulation Laboratories





Summary

- *The Network is :*
 - switches, routers, muxes
 - lines, circuits, services
 - end systems, operating systems, libraries
 - applications
 - people, relationships
- *End users need capabilities to “see” and “control” the Network*
- *Need joint commercial, government, and university R&D ventures to define and build the future Network and services*

Multimedia Break-out Session - Day 2

*Dr. Michael Kolitsky
University of Texas at El Paso*

*Dr. William Lupton
Morgan State University*

*Dr. Mou-Liang Kung & Mr. Wallace Hendricks
Norfolk State University*

Dr. Michael A. Kolitsky
University of Texas at El Paso



Demonstration

Demonstration

Demonstration

Demonstration

Demonstration

Demonstration

Demonstration

Demonstration

Demonstration

Demonstration

Demonstration

Demonstration

Demonstration

Demonstration

Demonstration

JavaScript and Dynamic

1. HTML

2.

3.

4.

Main Menu

Wow **This is a Test** Oh Boy

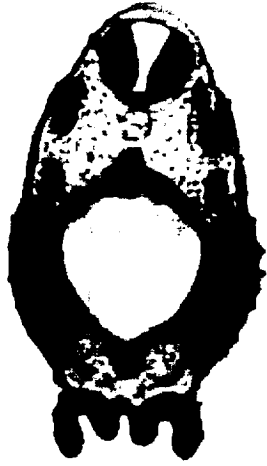

1

STOP

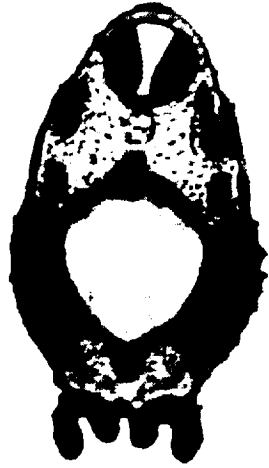

1

IMAGE 1	IMAGE 2	IMAGE 3	IMAGE 4	IMAGE 5	IMAGE 6
---------	---------	---------	---------	---------	---------



1

Slower	Faster	STOP	DISPLAY IMAGE	START
--------	--------	------	---------------	-------



1

12345678

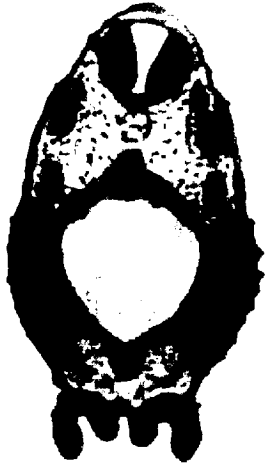

1

Slower	Faster	STOP	DISPLAY IMAGE	START
--------	--------	------	---------------	-------

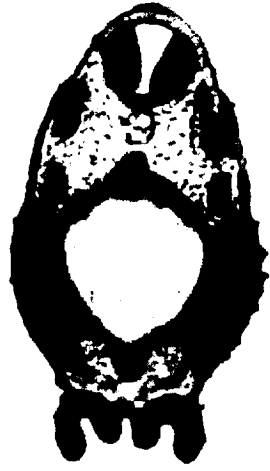

1



Display Off



1



Display Off

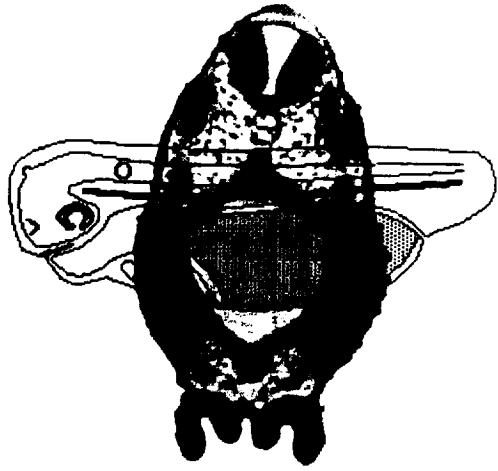

1





1

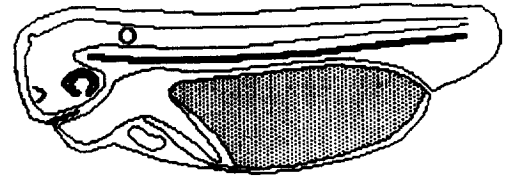

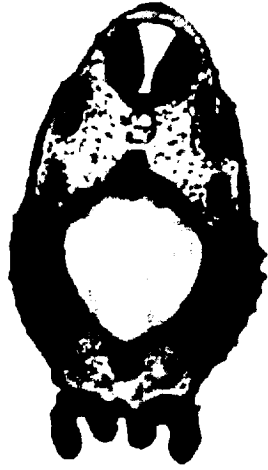

1

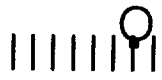

Display Off

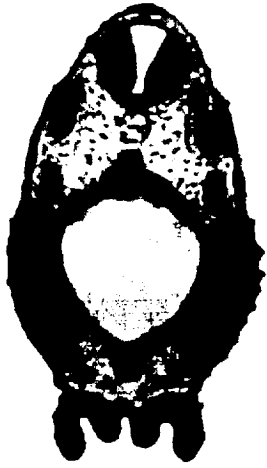

1



12345678



1

12345678

Move mouse over and out of this text

Dr. William Lupton
Morgan State University

TECCO

Products & Services

The Corporate Website of Tecco, Inc.

AL J BRA[®]

AL J BRA is a Windows based multimedia CD-ROM tutorial which illustrates and teaches Algebra I and II concepts.

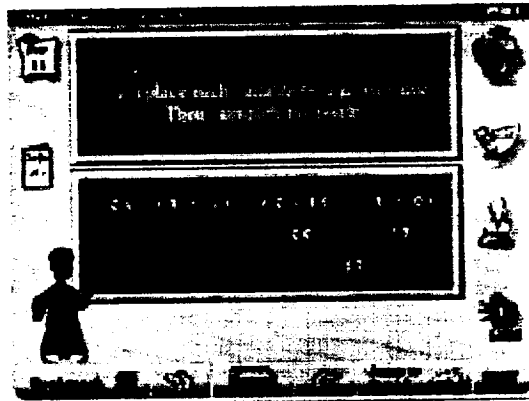

Corporate Pro
Products & S
What's New
Contact Us

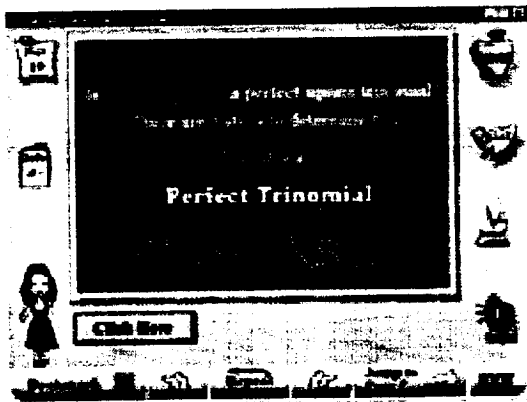

AL J BRA features a multicultural cast of animated teens led by AL J, who tutor users in a peer-to-peer environment in algebra topics ranging from real numbers to quadratic equations.

Bundled with AL J BRA are three math-based games:

- [Rescue Mission](#)
- [Solve-It](#)
- [Co-Pilot](#)

For more information or to purchase a copy please [contact us](#).

These games challenge the user's algebraic skills to successfully complete action-packed sequences.

AL J BRA offers a challenge section that allows users to test their comprehension of each lesson. AL J BRA also allows the user to monitor their progress in each section of the software. The results are saved for later review.



Electronic Publishing on Multiple Media

Mou-Liang Kung, Wallace Hendricks, Sue Koopman, and Eric Delk
Department of Computer Science
Norfolk State University
Norfolk, Virginia 23504
757-683-8650
757-683-9229
m_kung@vger.nsu.edu

The Proliferation of Internet usage in the general public is attributed to eye-pleasing Web documents created in HTML (HyperText Markup Language), a page-displaying language for network delivery. However, HTML suffers from many limitations. Since the HTML document style is built in the Web browser, Web documents are permanently locked to the Web Browser, and vice versa, limiting HTML documents for Web publishing only. When a document created in HTML needs to be published on other media such as disks, CD-ROM, or paper, an elaborate editing processes must be used, one for each media. Furthermore, HTML is but one document type totally incapable of describing sophisticated structures found in music scores, molecular structure, mathematical formula, etc.

Ideally, a document should only be created once and published many times on demand, on different publishing media, and on the fly. The way to achieve this is to create documents in SGML (Standard Generalized Markup Language). SGML is an ISO standard that defines a set of rules to create to new document markup languages, free from computing platform, editing software, format, style or presentation. An SGML document is a text with its structure (header, paragraph, table, and lists) clearly tagged according to a specific DTD (Document Type Definition). This DTD, written in the meta-language SBML, defines the tags and the relationship among the tagged texts for a particular document type, whether it is musical, chemical or mathematical in nature. Accessing the SGML, documents for viewing, printing, or web publishing is really nothing but attaching a style sheet for a particular kind of output media on the fly. Although HTML was a DTD derived from SGML, the lack of enforcement of document validation in browsers makes parsing of non-validated HTML documents for structure impossible, consequently completely useless for other types of electronic publishing.

SGML is known for its power but unfortunately, its complexity as well.

Validated SGML tools are expensive. The high startup cost and the complexity of SGML are the main reasons for its lack of public acceptance. But the problems of SGML are now tackled head-on by the World Wide Web Consortium (W3C). The W3C recently published the working draft of a new meta-language, XML (eXtensible Markup Language), a trimmed down version of SGML, specially tailored for network delivery.

XML allows one to deliver powerful, structured documents without the SGML complexity. An immediate application is in the PUSH technology (e.g. CDF, Microsoft's Channel Definition Format). The XML documents, pushed from the vendors to the customers, can carry structured information such as IP-numbers and user-specific identification for proper information dissemination. In addition, structured XML documents take JAVA to a new height when it gives JAVA something to process on to achieve ubiquitous computing.

A state-of-the-art SGML based electronic publishing system called DynaText is being setup at Norfolk State University under a software grant from INSO Corporation (formerly EBT). The DynaWeb, a part of the DynaText Publishing system is one of the few Web Servers that serve XML documents. The experience of converting the NSU Catalog and other hypermedia courseware to SGML/XML will be presented.

Networking Break-out Session - Day 2

*Mr. Kurt E. Roberson
Elizabeth City State University*

*Dr. Shermane Austin
City College of New York*

Mr. Kurt E. Roberson
Elizabeth City State University

NetDay '97

NetDay '97
North Carolina

Benefits of NetDay'97

NetDay'97 is a public and private partnership to wire and connect as many schools to the Internet.

The idea behind NetDay'97 isn't to wire every class room in every school at the same time. It's a chance to get some network connections in place in at least 2 - 3 classrooms, a library or computer lab.

To make it possible, volunteers are needed to get the work done.

Businesses will be asked to sponsor schools. This means they will spend \$295-340 on each kit necessary to wire schools and many will provide technical support and labor to install the equipment.

What is NetDay '97

The students and teachers will have valuable resources at their desk top. By connecting the schools to the Internet, students can now tap into vast information the Internet offers such as: virtual libraries, museums, zoos, white house, weather maps, study medical material , send email across the world, and produce audio and video conferencing such as: CU-SeeME.

Teachers around the world can also share curricula on the Internet.

NetDay'97 Training

Before NetDay'97, schools should conduct NetDay training for their volunteers. The training of volunteers should consist of the following:

- How to install Category 5 wiring
- Category 5 wiring scheme
- Understanding Blueprints
- How to use termination tools
- How to install Category 5 termination kits
- Instructions on safety issues

NetDay'97

Installing the cables

- Label both ends of the cable with a non erasable marker
- Do the longest run first
- Use tie-wraps to bundle the cables together and to mount the cables if possible to the wall or ceiling.
- Mount cables in Raceway in the classrooms

NetDay'97

Installing the cables

- **Never cut unlabeled cables**
- **Never label cables "Mr. Rogers classroom"**
- **Don't plan runs longer than 300 feet - cable length restriction**
- **Don't allow cables to be stretched, pinched or kinked**
- **Don't cut corners with cable - leave ample slack**
- **Don't install cables over or to close too florescent lights or power lines - causes interference.**

Why Category 5 Wire

Used in extremely high speed LAN application or voice applications. Category 5 products meet all specifications for category 1,2,3,4,5 as well as proposed UL (underwriters laboratories) specifications for 100MHz LANs. Recommended for high speed LANs.

Why Category 5 Wire



- Easy to Install
- Accommodates up to 1,000 devices
- Cable is typically 24 AWG unshielded twisted pair
- Cable segments may not exceed 100 meters (330ft)
- Segment connectors are 4,6 & 8-pin modular plugs and jacks
- Cable twist are kept within .5 inch of the IDC (isolated displacement contacts). to prevent Near end crosstalk (NEXT).
- 10 to 100mbps Bandwidth

Category 5 Wiring Scheme 568A

EIA 568A

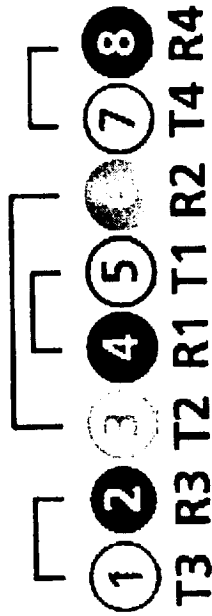

This is the newest of the sequence options as published in the EIA (electrical institute association) Commercial Building Cabling specification for terminating UTP (unshielded twisted pair) cable.

Category 5 Wiring Scheme 568B

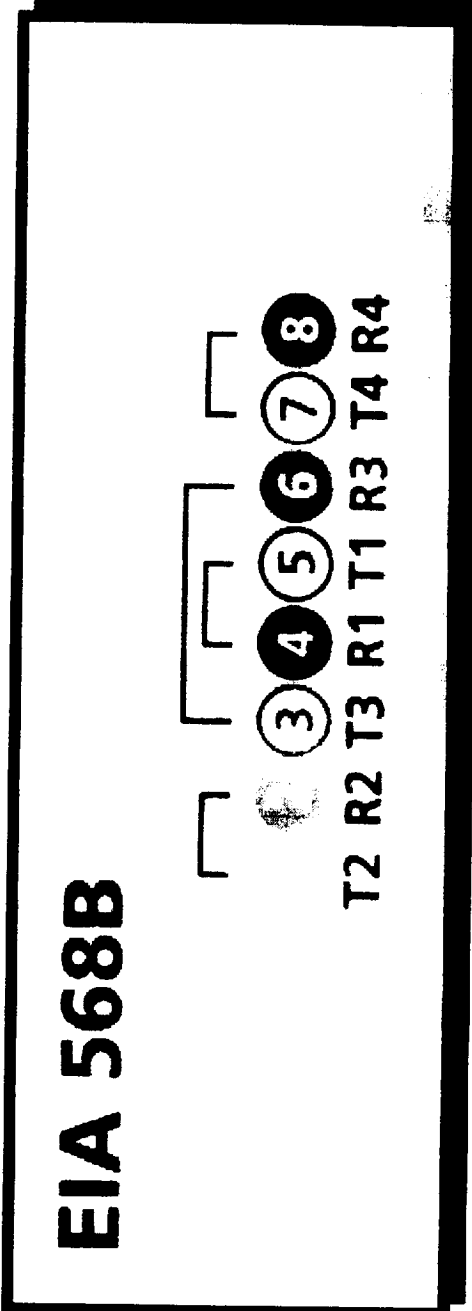

568B has become the most widely specified sequence worldwide for new data installations.

RJ45 Pinout

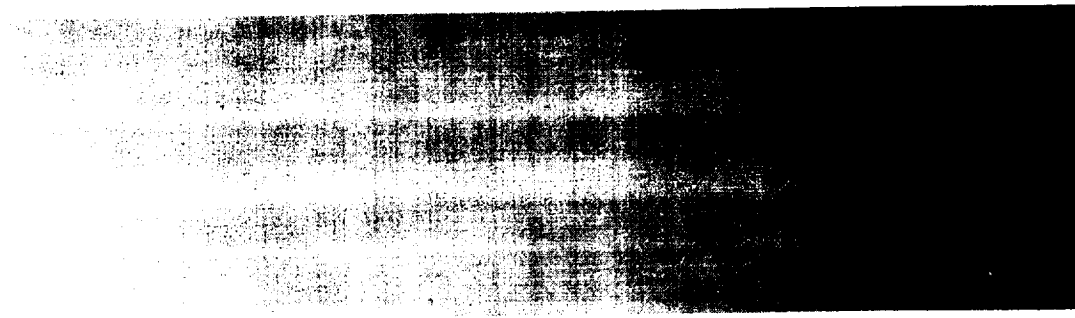
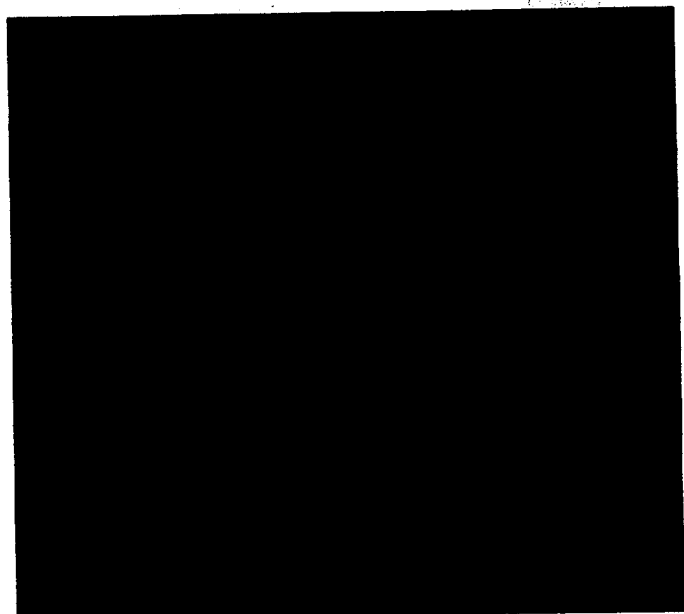
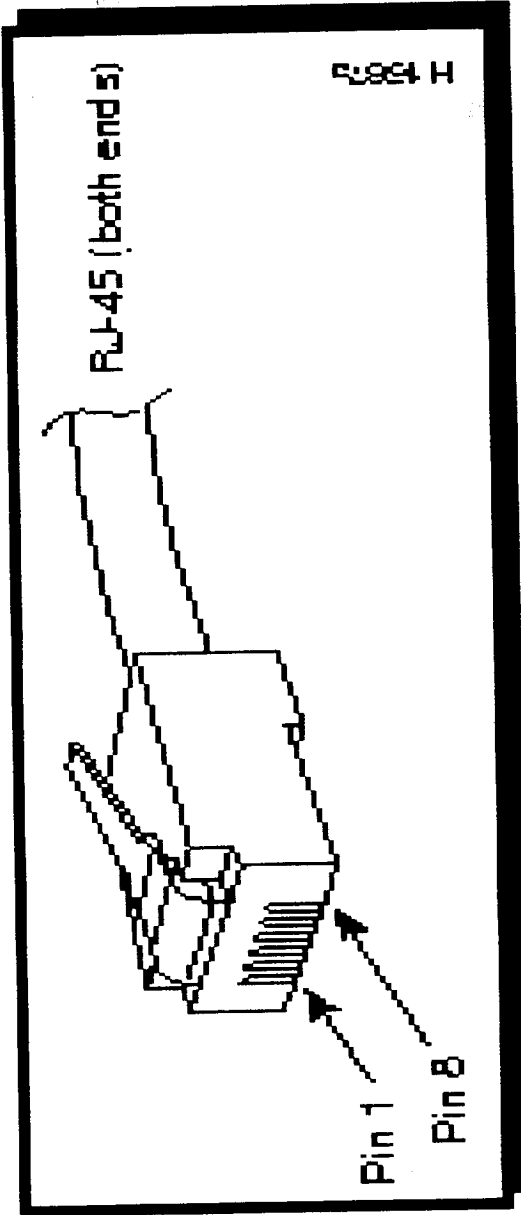

NetDay '97 Training



**Training Volunteers on implementing Category 5
termination kits**

NetDay '97 Training



Training Volunteers on implementing Category 5 Patch Cables

NetDay '97 Training



**Training Volunteers on implementing Category 5
Patch Cables**

NetDay'97 Blueprinting

Installation Steps

- Cable Routing
- Cable wiring conduits
- Fiber Optic (single/Multi-mode)
- Twisted-pair wire (STP or UTP)
- Router
- Hubs/Switches
- Category 5 termination tools

Networks Installation Reference Map

ECSU LESTER HALL CONFIGURATION CHART

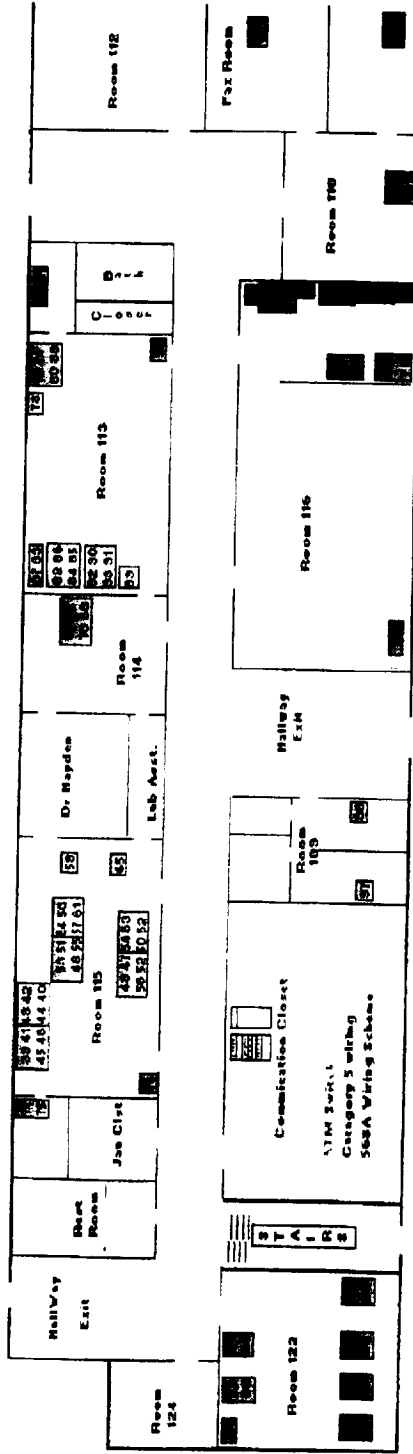

HUB Port#	HUB Port#
48. Hub. Ser. 1000	26.
49.	27.
50. Indy. Indy7.	28.
51. Indy. Indy6	29.
52. Indy. Indy12	30.
53.	31.
54. Hertford	32.
55. Indy. Indy5	33.
56. Indy. Indy10	34.
57. Indy. Indy4	35.
58. Indy. Indy1	36.
59.	37.
60.	38.
61. Indy. Indy2	39. Indy. Indys9
62. Indy. 318-male	

HUB Port#	HUB Port#
1.	
2.	
3.	
4.	
5.	
6.	
7.	
8.	
9.	
10.	Mac. Earth
11.	
12.	
13.	
14.	
15.	
16.	
17.	

NetDay '97 Safety Issues

Protect yourself and others by following these basic safety guidelines.

- **Wear safety glasses**
- **Use common sense with ladders.**
- **Wear protective clothing**
- **Don't be careless when lifting heavy material**
- **Use tools with care**
- **Beware of electrical cable**

NetDay 97 Hardware

Components

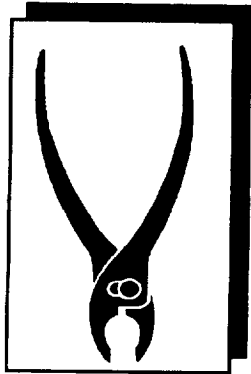

Pliers

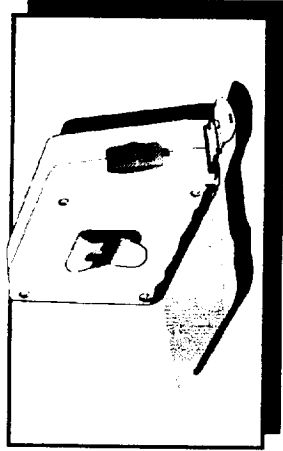

Rulers



Hammers



**Screw
Drivers**

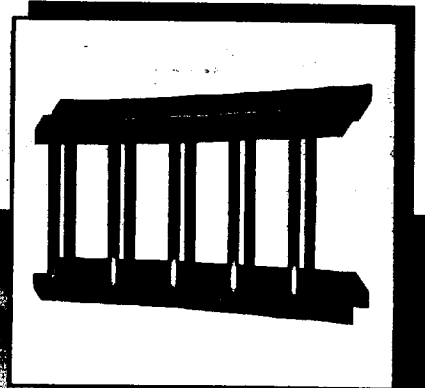

Ladders

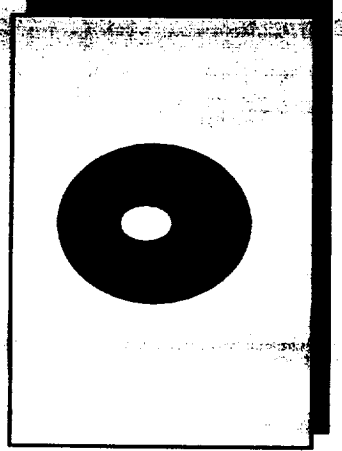

Tape

NetDay '97 Hardware

Components



**Universal LAN
Kit**

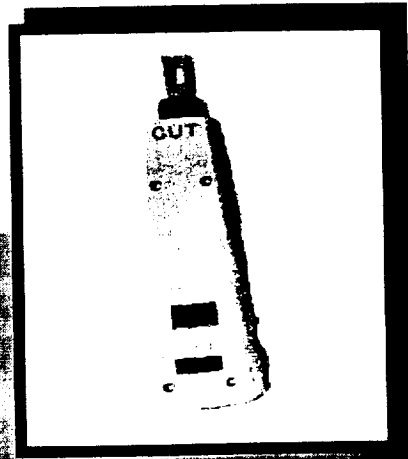

Compact Tool

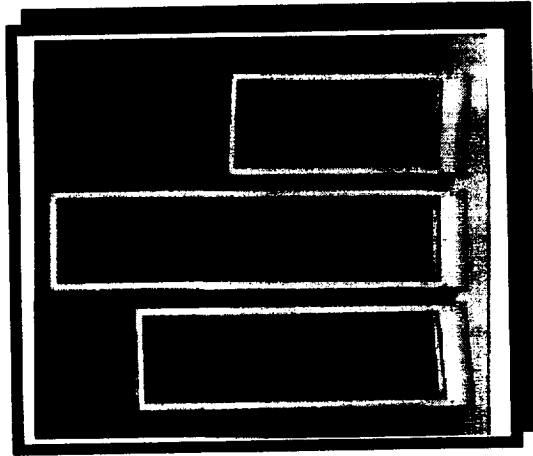

Wiring Rack



Golpher Pole



Fish Tape

NetDay '97 Hardware

Components

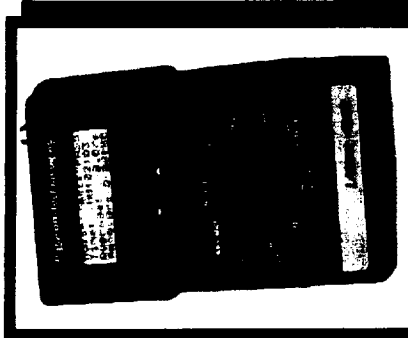

**Cat 5 Cable
Tester**

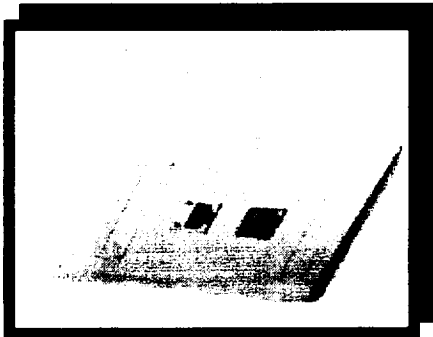

Media Box

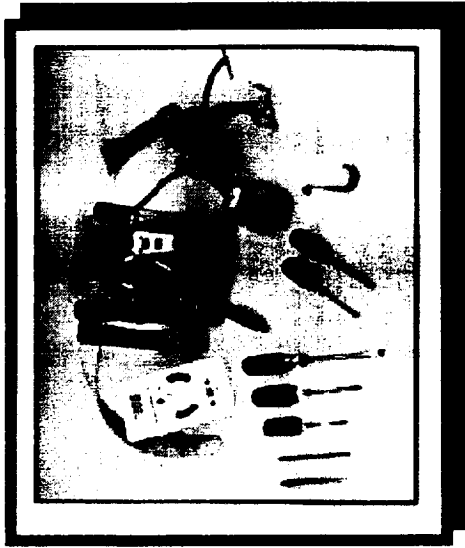

Tool Kit



g Duck

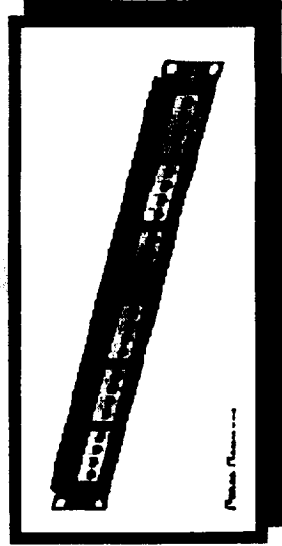

Cat 5 Patch Panel

NetDay '97 Networks

Components

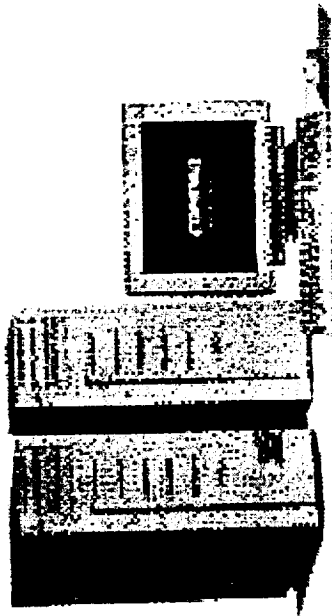

PC-LAN+ Servers

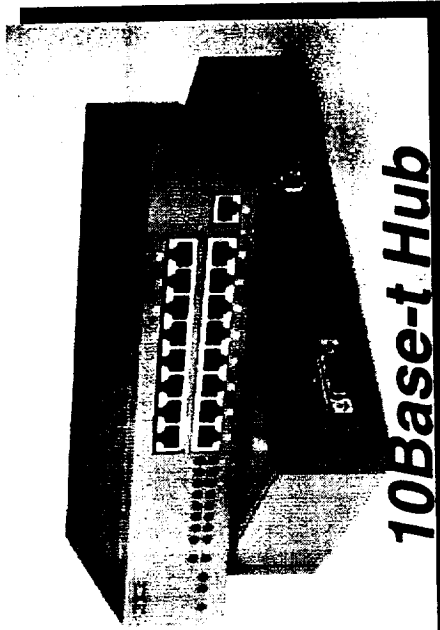

10Base-t Hub

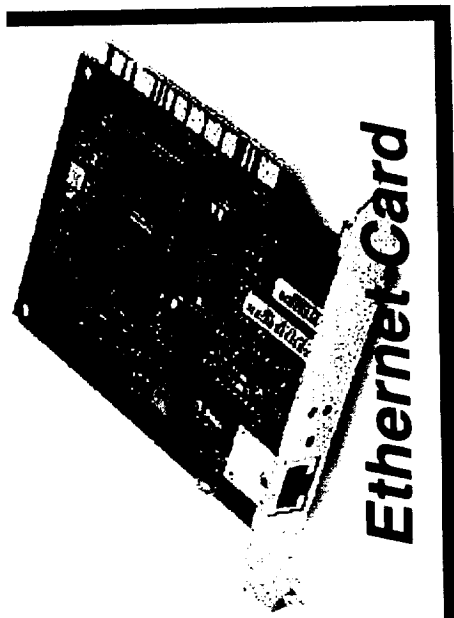

Ethernet Card

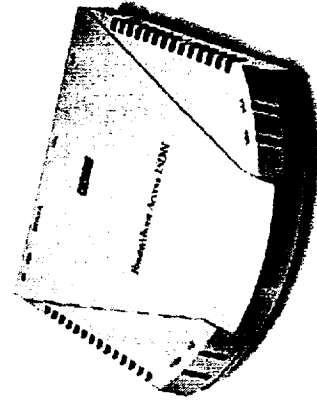

ISDN Router

NetDay '97 Volunteers at

Work

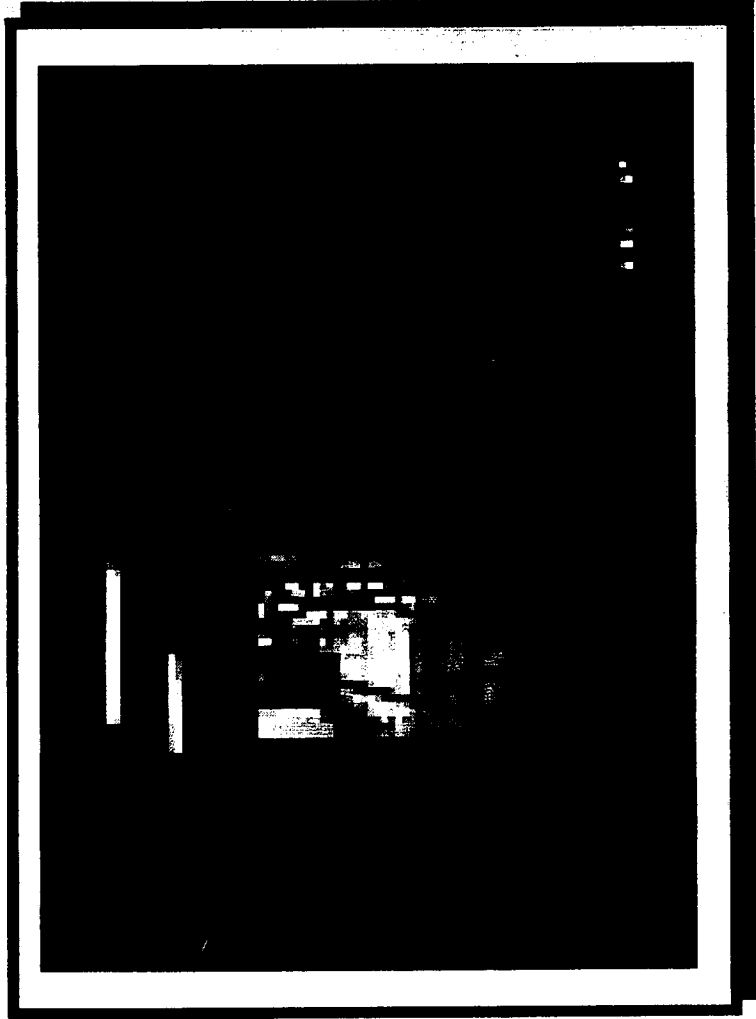

NetDay '97 Network

Components

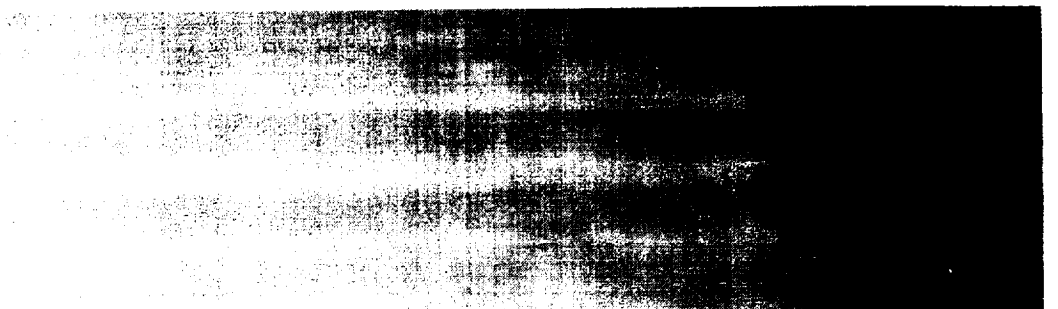
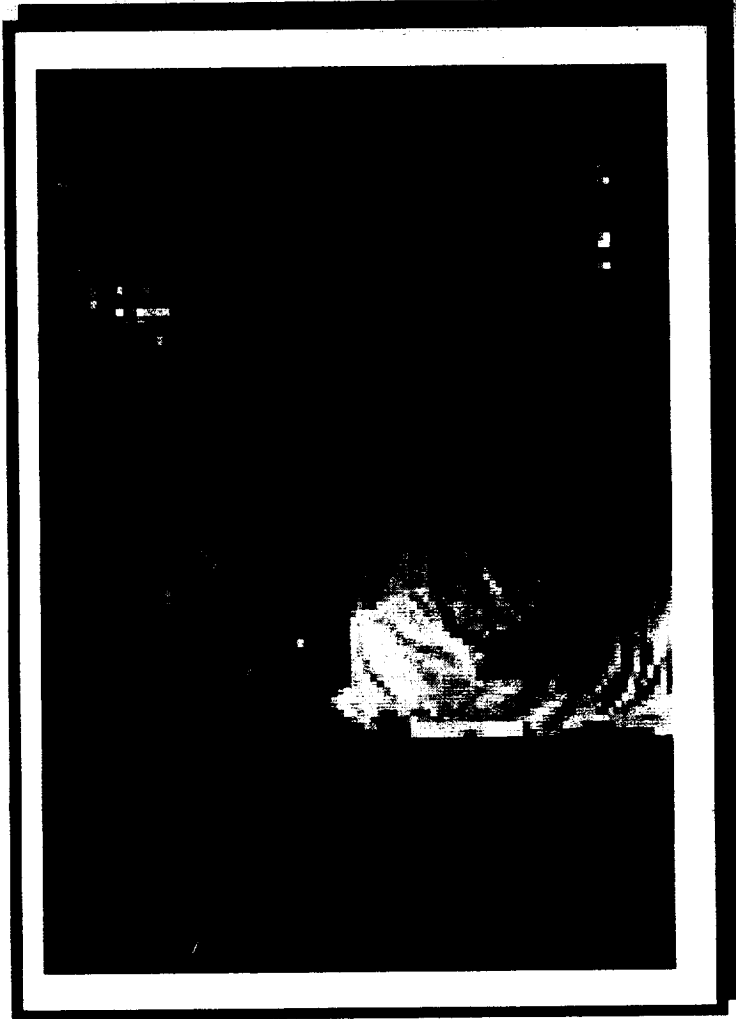

NetDay '97 Networks

Results

Audio & Video Conferencing Component

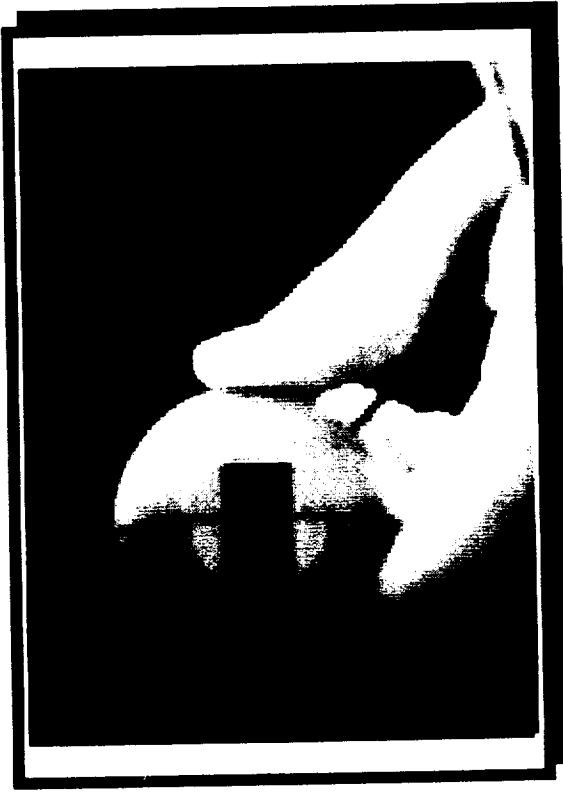

CU-SeeMe

**Pre-College MSET Education Programs
Break-out Session - Day 2**

*Ms. Elaine Lewis
NASA Goddard Space Flight Center*

*Ms. Carolyn Harris
NASA Goddard Institute of Space Studies*

Framework Components

NASA Mission
(Content)

Strategic Enterprises:

Mission to Planet Earth

Space Science

Human Exploration and
Development of Space

Aeronautics and Space
Transportation Technology

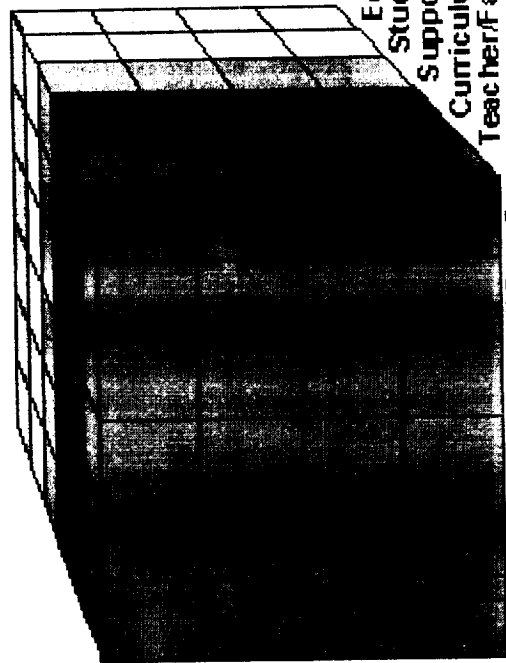

Education
Implementation
Approaches:

Mission, R & D, and Operations
Educational Technology
Student Support
Support for Systemic Change
Curriculum Support & Dissemination
Teacher/Faculty Preparation & Enhancement

K-4 5-8 9-12 CC UG G

Customer: Education Community
(Formal/ Informal)

NASA EDUCATION FRAMEWORK

MTPE Objectives

Systemic Change

- ◆ Enhance the capabilities of the broad education community
- ◆ Contribute to K-12 mathematics, science and technology through promotion of involvement
- ◆ Enhance participation of schools, significant number of underrepresented groups
- ◆ Strengthen the interface between educators and scientists

GLOBE Science and Inquiry Processes

- ◆ A tool to enhance understanding of Earth Systems
- ◆ All measurements and equipment as straightforward as possible
- ◆ Enhance environmental awareness throughout the world
- ◆ Reach higher levels of achievement in math, science and technology

GLOBE Legacy

Global Environmental Education

- ◆ Reaching thousands of schools and tens of thousands of students
- ◆ Authentic sense of participation
- ◆ Understanding of the World
- ◆ Teaching Environmental Education at all levels

GLOBE'S Educational Philosophy is Global

- ◆ Use teachers and students to monitor the entire earth
- ◆ “A way to make the MTPE become a Mission by the People of Planet Earth”
Gore
- ◆ “To change minds and hearts all over the world on the subject of the environment”
Gore

Systematically Adapt the Science Framework of MTPE

- ◆ Integrate GLOBE protocols within the Earth System Science Investigations
- ◆ Extensive use of GLOBE data server visualizations, graphs and reference datasets
- ◆ Use of NASA's current and future missions of remote sensing datasets
- ◆ Authentic participation in the international effort to study and understand the Earth

Local Actions Have Global Effects

3 Elements effect Life

- ◆ Temperature
- ◆ Salinity
- ◆ Dissolved Oxygen

Enhanced Protocols

- ◆ Alkalinity
- ◆ Nitrates
- ◆ Turbidity

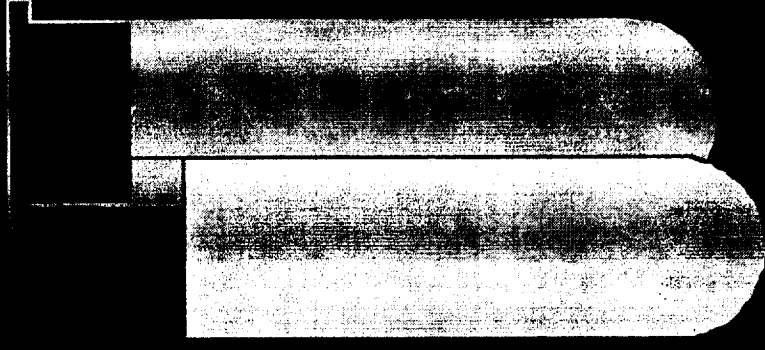

Investigation

- ◆ Specific data collection procedures
- ◆ Collecting data
- ◆ Analyzing data
- ◆ Comparisons
- ◆ Graphic Interpretation
- ◆ Archive/Over time
- ◆ Conclusion



Understanding Earth Systems

- ◆ Observation of the area- What seems right/ wrong?
- ◆ Hands-on Activities-How does the system interact?
- ◆ Data Collection-Using the protocols
- ◆ Research- What was it like in the past?
- ◆ Data Collection-GLOBE Archives
- ◆ Primary Source Interviews

Understanding Earth Systems

- ◆ Using satellite images/Remote Sensing
- ◆ Analyzing the results
- ◆ Drawing a conclusion
- ◆ Recommendations
- ◆ Action

**NASA MUSPIN SEVENTH ANNUAL
USERS' CONFERENCE**

Presentation by

Goddard Institute for Space Studies

Friday, October 10, 1997

NASA INVESTMENT
GISS - CUNY - NYC SCHOOLS COLLABORATION

AGENCY STRATEGIC OUTCOMES

Preservation of the Environment

We study the Earth as a planet and as a system to understand global change, enabling the world to address environmental problems

Educational Excellence

We involve the educational community in our endeavors to inspire America's students, create learning opportunities, and enlighten inquisitive minds

ICP GOALS

Excellence in Science Education

We involve students and faculty in our research to develop meaningful ways to integrate climate and planetary science data and research into school curriculum and prepare the next generation of scientists, engineers and citizens.

Diversity in Science

We collaborate with the New York City education community, uniquely positioned to prepare one of the nation's largest, most ethnically and racially diverse pre-college and college student populations, in order to provide networks that retain minority students in the science pipeline.

GISS Institute on Climate and Planets Research Teams

Cloud Structure in Storm Lifecycles

Forcings on Climate Sub-Teams

- Optimization of the GISS GCM Vertical Resolution
- Trends in Tropospheric Sulfates
- Representation of El Niño, Storms, and Rossby Waves in the GISS GCM and their relationships
- Ocean Variability in the Coupled General Circulation Model

Global Methane Inventory

Impacts of Climate Change

Palynology and Climate Change

Radiative Forcings on the Earth's Climate

Evolution of the ICP Pilot 1994-1996

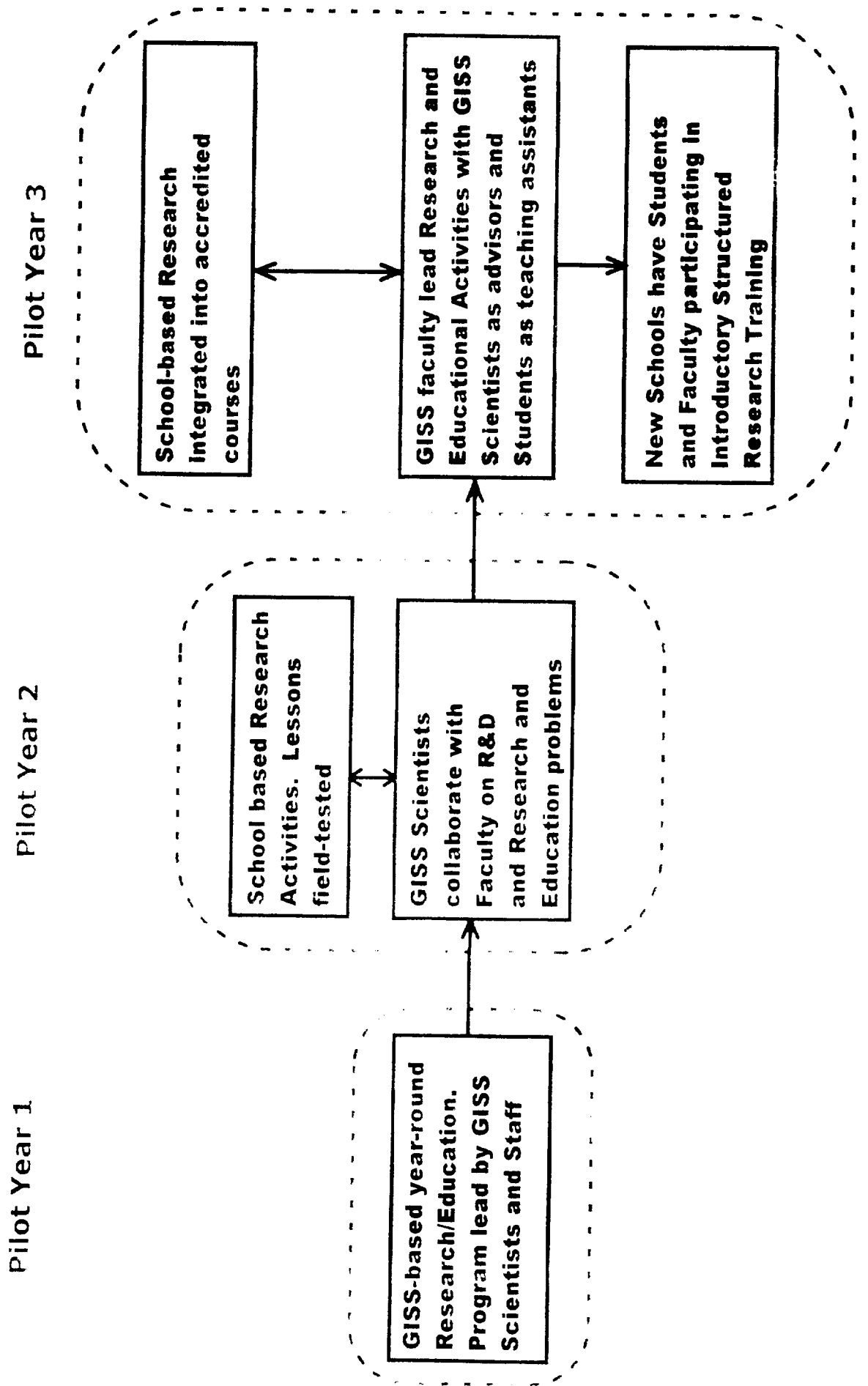

OUTCOMES

Systemic Impact

- Accredited research courses and/or integrated research into science courses.
- ICP directly addresses New York City and State education goals and strategies in science and math.

Academic Advancement:

Student tracking shows:

- advancement of all students to higher levels of science courses
- mentoring of peers in sciences
- increase in science, computer and technical skill and knowledge

Public Awareness

- NASA's research is shared by students and faculty at more than sixty local, state, regional and national science presentations, papers academic competitions

Educational Networks

- Students and faculty are utilizing new networks at GISS, our science colleagues at other public and private institutions, CUNY and NYC Schools to obtain increasing academic and professional opportunities, e.g. internships, jobs.

GISS/ICP MODEL SCHOOL NETWORK AND CENTERS OF EXCELLENCE

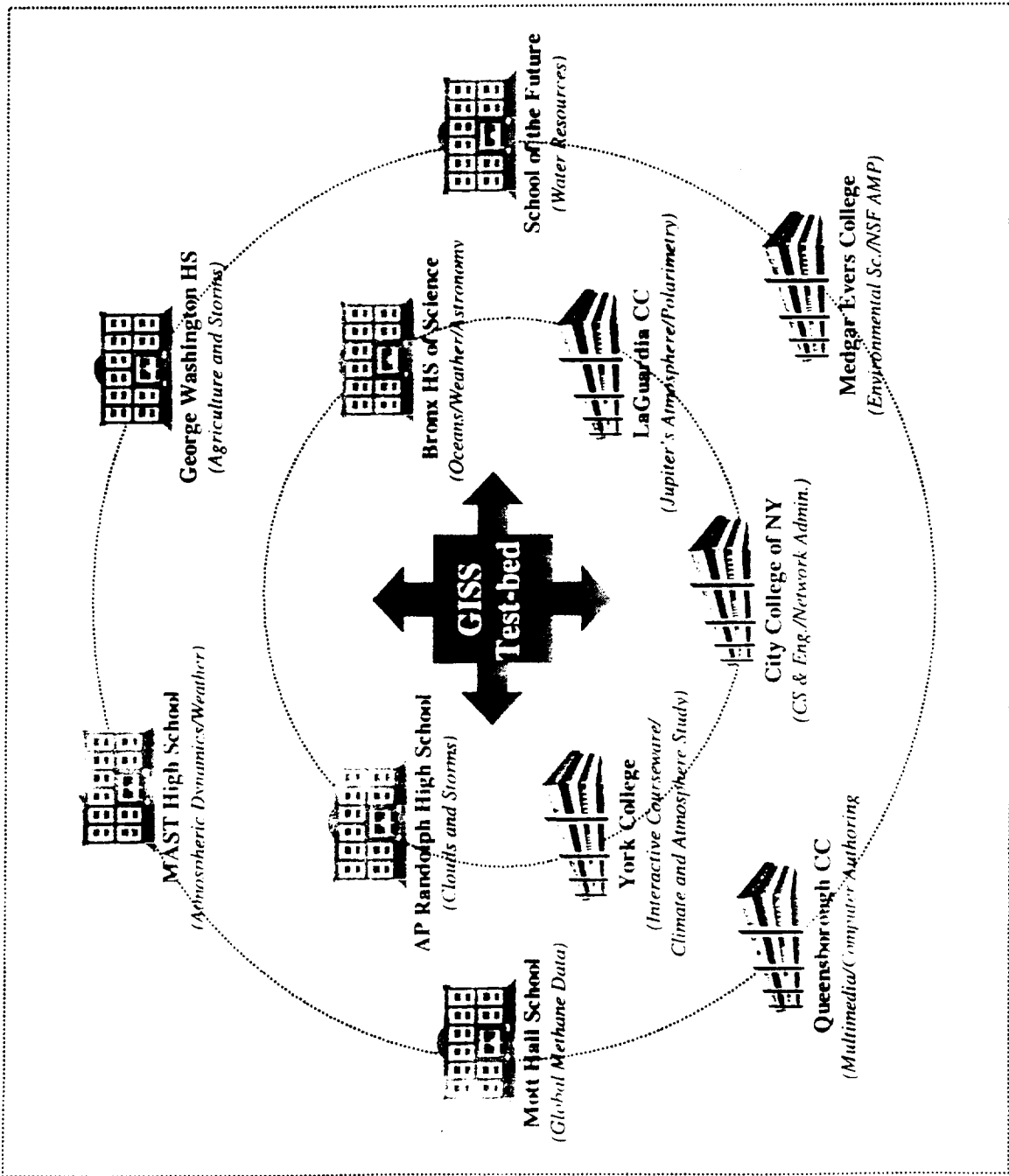

RECOMMENDED MINIMUM COMPUTING CAPABILITY:

- 10-15 High-end PC
- Local Area Network
- Network Server
- External Data Storage Media
- T-1 Internet Connection (Fractional)/Partners: Dial-up
- Software: word processors, spreadsheets, data display, image manipulation, C and Fortran compilers, Web browsers, ftp & email clients
- Black/white and Color printers
- Overhead LCD display

TRAINING/PERSONNEL:

- Network/Systems Administrator
- Basic Internet/Web, and Excel or other software training for data analysis.

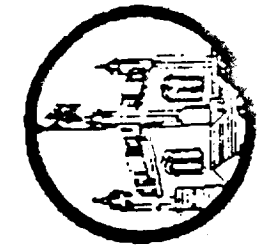

**A. Philip Randolph
Campus High School at City College**
135th Street & Convent Avenue
New York, New York 10031
(212) 926-0113
Nathalie McFarlane, Principal

Center for Excellence

- Clouds and Storms
- Research Analysis using Excel

- Student Assessment Rubrics
- Constructivist Curriculum

ICP Faculty Initiatives

population impacted

- Energy and Climate Research Course, using cloud research 30 students
- Investigations courses integrate 2 week Sunphotometer research 200 students
- Independent R&D project to build a hand-held Sunphotometer 2 students
- Internal energy unit in physics uses climate research to teach heat transfer, phase changes, specific heat, gas laws
- Student assessment matrix designed/field-tested on student graphical interpretation skills and scientific knowledge
- Physics faculty (1) and ICP Technology Coordinator develop Internet/Excel Workshop
- 1st student entry in the Westinghouse in 15 years
- Access to computer lab for research and research space allocated

Spin-offs - Schools and Colleges

The Bronx High School of Science

75 WEST 205TH STREET

BRONX, N. Y. 10468

STANLEY BLUMENSTEIN
PRINCIPAL

Center for Excellence

- Oceans, Weather, Astronomy
- Using the Internet for Research
- Computer Network Administration
- Scenario-based Curriculum
- Mentoring Westinghouse Projects

ICP Faculty Initiatives

- Geoscience research course, using ICP modules/labs on radiative balance, atmospheric composition 102 students
- Other ICP modules concern sea level rise in NYC and temperature distribution
- Astronomy class integrates ICP modules on Earth orbit, planetary energy balance 65 students
- Geoscience (1) and physics faculty (1) contribute to R&D team developing Research Projects Workshop
- School Technology Coordinator and student conduct MU-SPIN Internet training for ICP high school teams
- Dedicated computer lab for research and research space allocated

population impacted

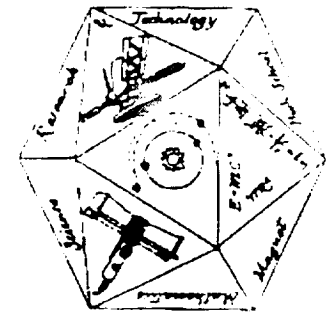

MATHEMATICS, SCIENCE RESEARCH & TECHNOLOGY

207-01 116th Avenue, Cambria Heights, New York 11411
 Tel. (718) 978 1837 • Fax (718) 978-2063

Henrietta Fullard, Principal

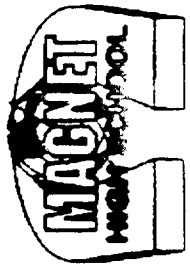

Center for Excellence

- Atmospheric Dynamics and Weather
- Student Research Publications

- Pre-Engineering and Technology Education

ICP Faculty Initiatives

- Advanced/Introductory research course to study weather and climate
- Research magazine produced by students and earned recognition by Scholastic Press
- Climate Newsletter is in production for distribution throughout school
- Dedicated computer lab for research and research space allocated
- Dedicated lab for digital/electronic research

population impacted

70-75 students

Spin-offs - Schools and Colleges

ICP WEB GOAL

- Provide a way for students and faculty to actively participate in the ICP program from their schools/colleges, contributing to team research, gaining research knowledge and skills and annually presenting their findings.
- This research tool is expected to create a student and faculty research network in NYC public schools and CUNY colleges that addresses national and state Standards for Science, Mathematics and Technology.



NASA Goddard Institute for Space Studies

Institute on Climate and Planets

Student and Faculty Research Center

Research
Projects

Earth Climate
Course

Annual
Conference

Library

Entrance



Data & Images

Interactive
Courseware

ICP Partners



Goddard Institute
for Space Studies



Mission to
Planet Earth



Equal Opportunity
Programs Office



NASA
Education

About the ICP
Calendar
Participants

Building
Directory

ICP Partners



City University
of New York



Columbia
University



NASA
MU-SPIN



New York City
Public Schools

VRI version 1.2

<http://summer.giss.nasa.gov/index.html>

Last updated: 1997:09:24, Latika Keegan

MENU

Teacher's Manual

Research Skills

Other Research Tasks

Downloads

ICP projects

GISS home



Goddard Institute for Space Studies

ICP home

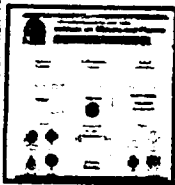

New Researcher Investigation

The knowledge and skills acquired in this study are meant to be a first step toward forming an informed perspective on the question: *Is the Climate Changing?* Specifically, this investigation involves students in the study of how much the Earth's climate varies and why. It provides students with the opportunity to submit a viewpoint to this homepage based on the results of their study. Communicating knowledge gained in research is a responsibility that scientists have to educate the public and build scientific consensus for their research.

By advancing through three levels of research tasks (basic, intermediate, and advanced) you will gain experience thinking about and working through a problem scientifically. You will be introduced to the current ICP projects, as well as the research skills and the climate data that will advance our understanding of the climate system.

Viewpoints: Is the Climate Changing?

Policy Makers



Scientists

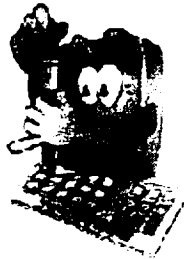

Students



Add
View

Add Your

[Begin New Researcher Investigation](#)

New Researcher Investigation: Is The Climate Changing?

After carefully analyzing the figure, write your analysis in the "Student Journal." below.

Changes In Temperature Global Record (1870 - 1990)

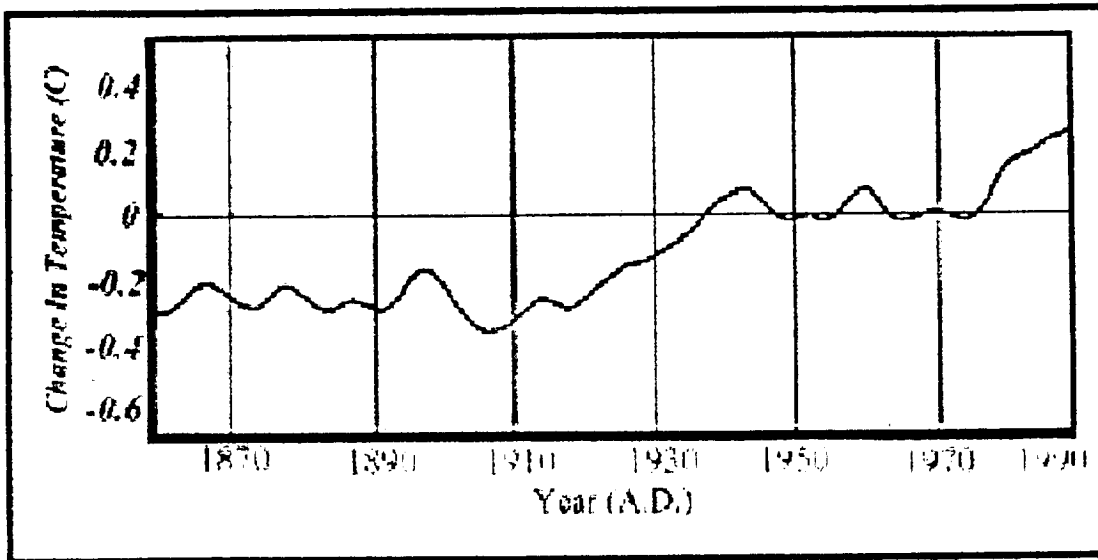

Student Journal

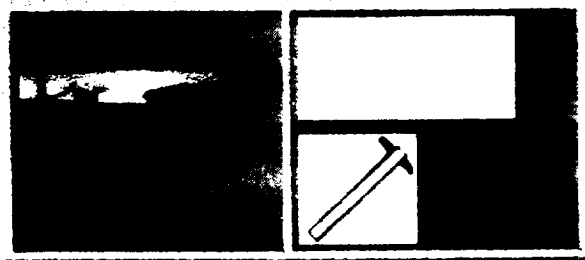

First name: _____

Last name: _____

1. Are there any periods that look particularly interesting in terms of how fast and by how much temperature is changing?



2. Does the overall change in temperature during this most recent hundred year record indicate temperatures that are: warming, cooling, constant and/or fluctuating?



Add to Journal



Cloud Structure in Storm Lifecycles

Introduction: The Problem With Clouds

What if humans are causing our planet Earth to heat up? Will polar ice caps melt? Will sea levels rise? Will deserts expand? If the Earth's climate is changing, what will happen to the clouds? Will more clouds form? Will these clouds warm or cool the planet?

Research scientists at NASA attempt to predict future climate changes. But they need to know more about clouds to make better predictions. Since storms are the primary cloud-makers in the Earth's atmosphere, the clouds project attempts to study how storm systems make clouds.



Infrared satellite image of the earth. (Source: ISCCP)

This year the clouds project will track cloud formations through many individual storms, as well as how clouds change as a result of stormier seasons over a number of years.

These investigations will provide a better understanding of how storms make clouds, helping scientists to better simulate clouds in computer models, and improving their ability to predict how the Earth's future climate will change. For a more detailed discussion, please visit the [Clouds project description](#) page.

Guiding Science Questions

While learning about the Earth's climate through research activities and projects, it is important to recall the main questions that currently guide climate research projects at the [Institute on Climate and Planets](#):

1. What makes the Earth a habitable planet?
2. Is the Earth's climate changing?
3. Can we realistically simulate climate variability?
4. **What is the role of clouds in climate change?**
5. How do clouds relate to atmospheric dynamics?

Skills/Knowledge Development

Basic

About ICP

[Introduction](#)

[Calendar](#)

[Participants](#)

[Schools](#)

Projects

[Model](#)

[Oceans](#)

[Radiation](#)

[Clouds](#)

[Impacts](#)

[Methane](#)

Earth Climate

[Philosophy](#)

[Structure](#)

[Content](#)

Data & Images

[Courseware](#)

[Storm Tracks
atlas](#)

[Documentation](#)

Library

[Glossary](#)

Conference

[ICP Home](#)

[GISS Home](#)

- Introductory activity
- How can a cloud affect the Earth's temperature?
- What does a cloud look like from a satellite?
- Using satellite images of storm clouds to make weather predictions.

Intermediate

- Learn how to classify clouds.
- Introduction to NASA data plots of storms and clouds.
- What is the effect of low,thick clouds in the atmosphere?
- What kinds of clouds are produced by midlatitude storms?

Advanced

- Relating storm clouds to global climate change.

1997-1998 Long-Term Research Projects

Students may use NASA data plots on storm clouds to participate in a number of investigations that:

- Connect science to global climate change
- Facilitate analysis and inquiry skills
- Relate fundamental science concepts to climate research
- Allow students to collaborate with practicing NASA scientists

The following is a list of sample investigation questions:

Current Research Questions

- What is the relationship between variations in seasonal atmospheric dynamics and seasonal cloud properties?
- What is the relationship between sea level pressure anomaly and cloud thickness in a mid-latitude storm?

Future Research Note: these pages yet to be added. Please be patient.

- How is surface pressure related to clouds during ocean storms?
- How is surface pressure related to clouds during land storms?
- What kinds of clouds form along a cold front in a storm?
- How are tropical storm clouds different from midlatitude storm clouds?

<http://summer.giss.nasa.gov/projects/clouds/index.html>

Last updated: 1997:10:07, LK

What Kinds of Clouds Are Produced By Midlatitude Storms?

In the earlier activity, *Hypothesis*, you made some predictions as to the amounts of the different cloud types that would be seen in a storm. In the previous activity, *Data*, you have seen how cloud researchers are able to identify the types of clouds found in a storm from satellite data. In this section you will see how you can use this data to determine the true percentages of all cloud types occurring in a storm. To make this determination, you will transfer the satellite data into a spreadsheet and use the spreadsheet to see the distribution of the cloud types in the storm.

The procedure described below will guide the user through some preliminary steps in a short analysis of the midlatitude storm data. This procedure assumes that the user is using the spreadsheet Microsoft Excel, the Windows 95 operating system, and a Windows 95 based Web Browser.

The following sections show the steps that you need to follow in order to get the data that you will use to determine the distribution of the types of clouds found in a midlatitude storm of your choosing. If at any time you are unsure as to how you should carry out that step, click on that step and the detailed instructions for that step will appear in the bottom frame in the column to the right.

Determining the true percentage of cloud types in a storm

1. Select the region of your storm with the most clouds.
2. Open the "Storm Analysis" worksheet for your version of Excel.
3. Copy the Optical Thickness data into the first column of the spreadsheet.
4. Copy the Cloud Top Pressure data into the second column of the spreadsheet.
5. Run the macro *CloudProp* to produce a graph of your data.
6. Save the graph as an HTML document.

About the Clouds Web Pages

The Clouds instructional web pages are designed to engage students in learning about the Earth's climate through project work that emphasizes the relationship between clouds and long-term climate change.

Students are introduced to the process of conducting scientific research that may contribute to solving research problems concerning climate researchers at the NASA Goddard Institute.

The Clouds Web Pages: Progressive Educational Features

Problem-based learning:

Students engage in actual scientific research

Systems Thinking

The study of clouds involves exploring Earth as a system

Visualization:

Complex concepts are presented through computer animations

Raw Data Acquisition:

Students gain access to actual satellite imaging data

Spreadsheet Analysis:

Students manipulate data by interfacing with Microsoft Excel

Communication:

Research results are presented over the World Wide Web

Collaboration:

Students communicate with research partners over the Internet

Contribution:

Student research may contribute to scientific publications

-
- [Return to Education Page.](#)
-

ACCOUNTABILITY

GISS-based Program: 50 participants (30 students and 20 faculty)

- Research Presentations and papers
- ICP Web Site with Users Participating on Research Teams
- NY State Accredited Integrated Science Course
- R&D and Dissemination Via Workshops and Seminars
- Elementary School Program Lead by Students
- Leverage public and private resources

School-based Program Model: Research Program and/or Classes

- Research papers and presentations
- ICP Outreach to other schools via student and faculty training
- School web sites
- Leverage public and private resources

ACCOUNTABILITY

OUTCOME

PROPOSED ICP 1997-2000

ICP PILOT PROGRAM FOUNDATION

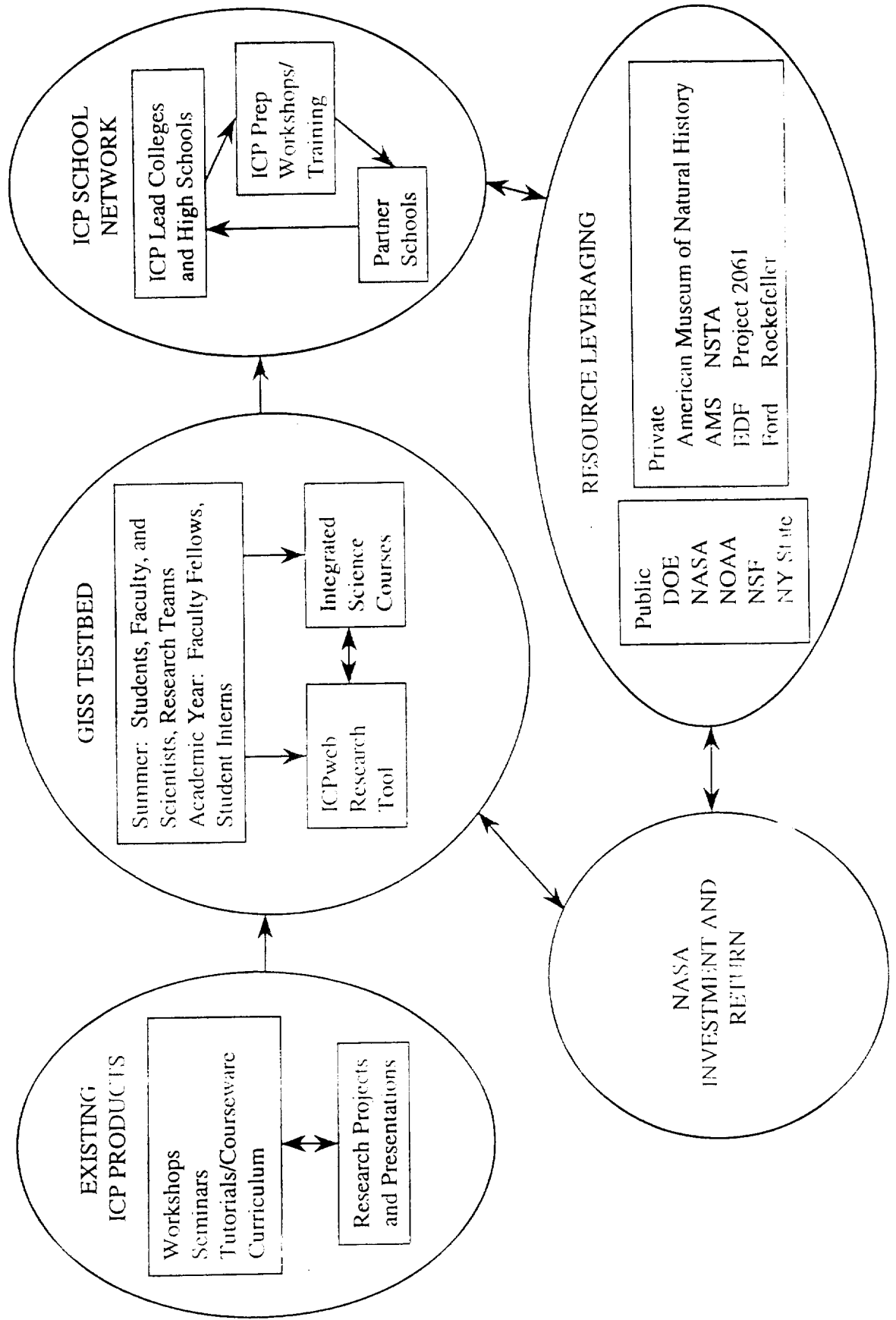

Earth Climate Course Curriculum Module Structure

Core Events

NY State Science Standard

“Big” science question
and problem scenario

#S1: *elaborate on basic scientific
and personal explanations of
natural phenomenon*

#S7: *analyze interdisciplinary
problems on local, national,
global scale*

Exploring students initial
understanding of the problem

#S6: *Common themes - model
behavior of natural systems,
also #S7*

Concept learning - activities to
develop science knowledge and skill

#S2: *access information from a range
of sources and use advanced
features, also: #S1, #S6*

*The “knobs” that control global
and local climate*

#S3: *Mathematics*, #S4: *Physical
Setting*

*What happens when you start
playing with these “knobs”?*

Research project - current climate
investigations at varying levels of difficulty

#S1, #S2, #S3, #S4, #S7
addressing real-world problems

*Monitoring the health of the Planet Earth via
satellite and ground-based
data and GCM output.*

Systems Thinking - development and revision
of climate system concept maps

#S4, #S6 and #S7

How are the “knobs” interconnected?

Defending and communicating research results

#S6 and #S7

1997/98 Schools Piloting ICP Research & Curriculum

Schools	School-based Activity	Student Impact
<u>Forcings and Chaos</u>		
York College	Meteorology Course	20-25
MAST HS	Research Class	20-25
Far Rockaway HS	Earth Science Class	25-30,
A. Philip Randolph HS	Research in Environmental Studies	20-25
Bronx HS of Science	GeoSciences Class Research Program	20-25
<u>Clouds</u>		
A. Philip Randolph HS	Weather & Climate Research Class	20-25
Southern Connecticut State	Research Program	3-5
<u>Climate Impacts</u>		
School of the Future	Research Program	2-3
Hunter College	Research Program Oceanography Class	2-4 15-20
<u>Radiative Forcings</u>		
Townsend Harris HS	Physics Class Research Program	20-25 3-5
LaGuardia CC	Electrical Eng. Projects Class Research Program	20-25 3-5
Medgar Evers College	Instrumentation Course	15-20
CCNY	Remote Sensing Course	15-20
<u>Methane</u>		
Mott Hall Junior High	Earth Science Class	25-30
<u>Palyonology</u>		
George Washington HS	AP Biology Class Research Program	20-25 10-15

**Institutional SEM Development & Proposal Writing
Break-out Session**

*Dr. Mildred Boyd
NASA Goddard Space Flight Center*

*Dr. Nagi Wakim
Bowie State University*

Vertical text or markings along the right edge of the page, possibly a page number or header.

51

Institutional Science, Engineering & Mathematics Education (SEME) Development

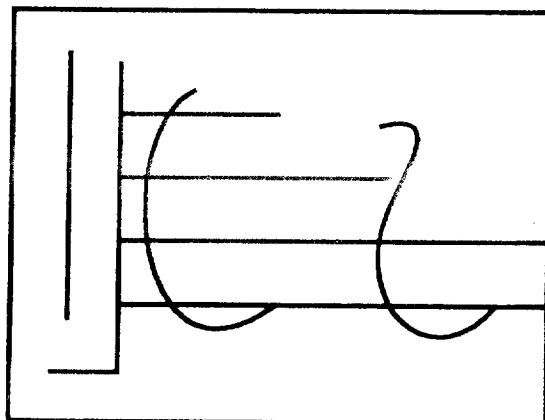

A MODEL INSTITUTION
FOR EXCELLENCE

A Hybrid Model for SEM Education Reform

Nagi T. Wakim

Associate Provost and Director, MIE Program

(301) 464-7241

(301) 464-7818 (Fax)

nwakim@bowiestate.edu

www.sem.bowiestate.edu

Key SEM Elements to Address

- ◆ **Students**
- ◆ **Faculty**
- ◆ **Staff**
- ◆ **Academic programs**
- ◆ **Sponsored programs**
- ◆ **Physical & technological infrastructure**
- ◆ **Academic structure (schools, depts, ...)**

Practices & Observations

- ◆ Bottom-up vs. Top-down
 - ◆◆◆ Hybrid
- ◆ Centralization vs. Decentralization
 - ◆◆◆ Federation
- ◆ Programs vs. Projects
 - ◆◆◆ Comprehensive Model
- ◆ Goals & Objectives
 - ◆◆◆ Strategic Planning with Operational Tasks

Reform Model Characteristics

- ◆ **Framework**
- ◆ **Comprehensive**
- ◆ **Scaleable**
- ◆ **Bottom up development**
- ◆ **Top level leadership and support**
- ◆ **Assessable**
- ◆ **Modular validation and dissemination**

Model Components

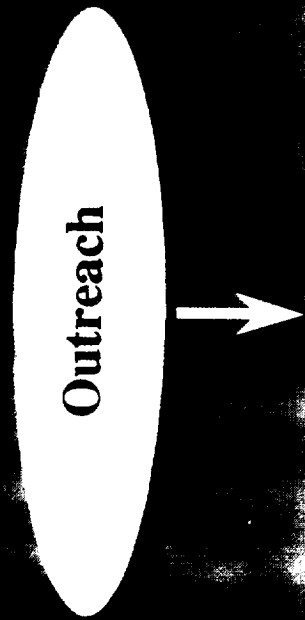

- Bridge programs
- Focused recruitment
- Showcasing accomplishments
- SEM awareness
- Public affairs

Model Components



- Assistantship programs
- Mentoring program
- Student development & enrichment programs
- Parental involvement
- SafetyNet program
- Academic support

Model Components

- 
- Integrate in undergraduate learning process
 - Promote & support scholarly work
 - Internal faculty grants
 - Discipline-based research

Model Components

- Curriculum enhancement
- Problem solving & laboratory experience
- Supplemental education
- Student-centered learning
- Focus on pedagogy
- Infusion of technology



Model Components

- 
- Support staff
 - Faculty & staff development
 - Information technology infrastructure
 - Facility enhancement

Model Components

- Corporate partnership program
- Graduate schools
- Feeder schools/colleges
- Industry & government

Contributor



Model Components

- Institutionalize with planning
- Formative & summative
- Capture and track perceptions
- Maximize use of IT
- External evaluator



SEM Education Reform Model

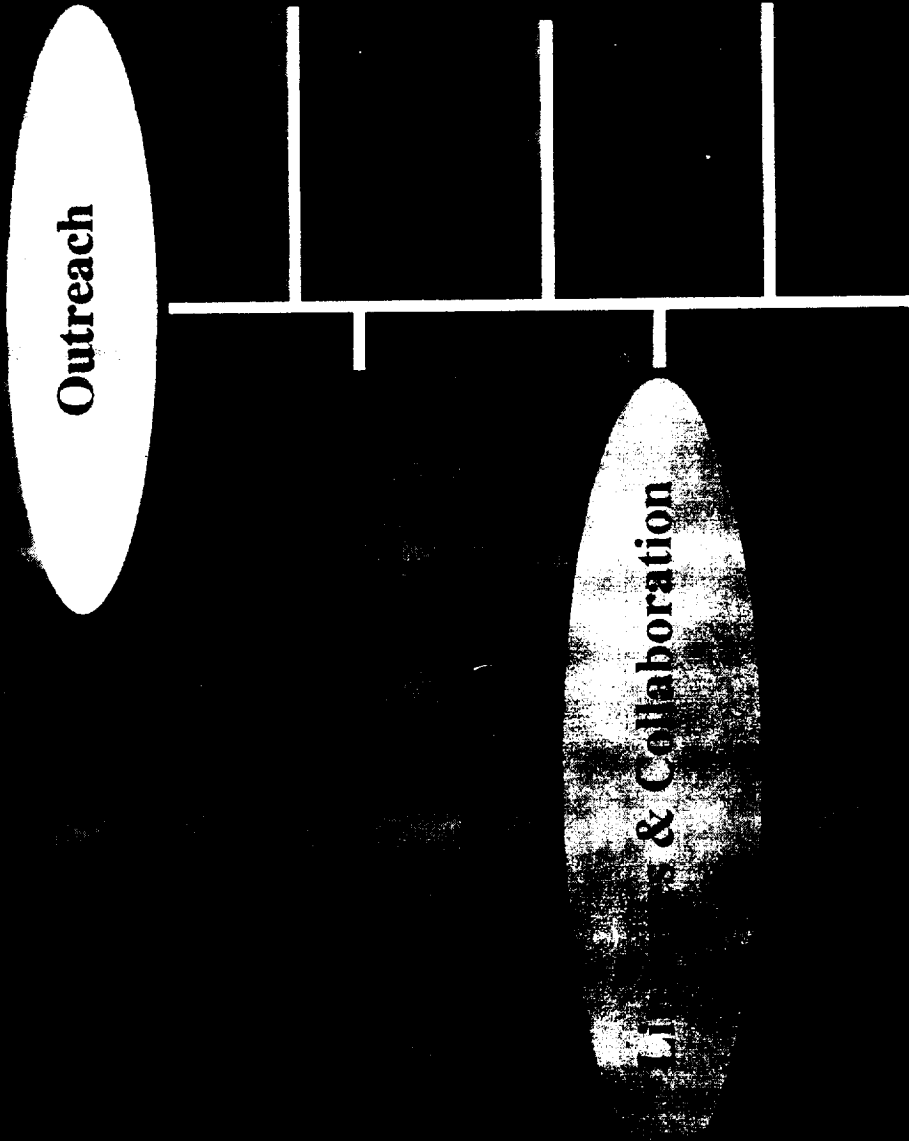

Q's & A's

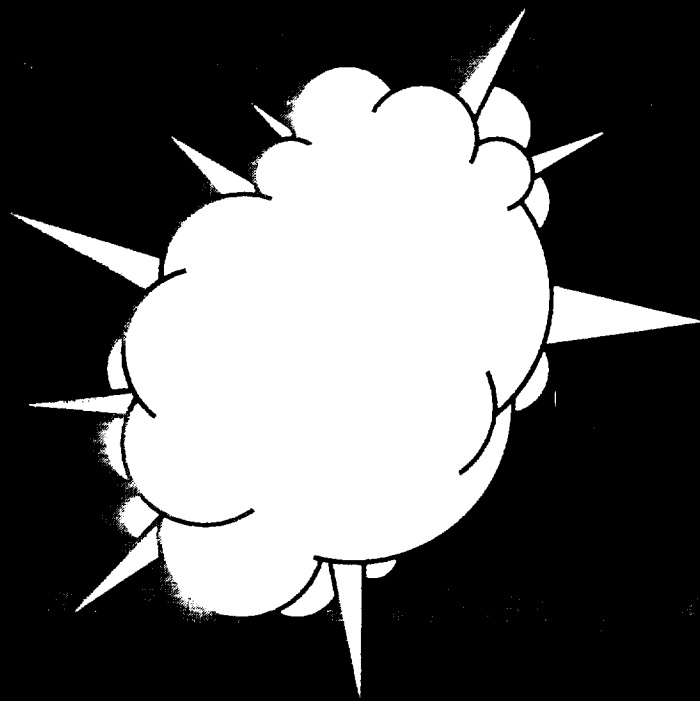

Distance Learning Break-out Session

Dr. Henry Ingle
University of Texas at El Paso

Dr. John Williams
Prairie View A&M University

UTEP

**Technology Planning &
Distance Learning**

The University Of Texas at El Paso

TPDL

**OUR
PERCEPTIONS**

Entrepreneurs have a tendency to make their own chances. There is the story of the shoe manufacturer who sent his two sons to the Mediterranean to scout out new markets.

One wired back: "No point in staying on. No one here wears shoes."

The other son wired back: "Terrific opportunities. Thousands still without shoes."

Who do you think eventually took over the business?

TPDL

**PREMISES BEHIND
THE VISION**

#1 Information technology is a basic and essential resource to the work of the university. The issue is no longer one of whether or not to use information technology, but rather what, when, where and how to use it for a strategic advantage.

Information technology needs to be easily and equitably accessible any time, on any subject, from any location, from any information technology source, and by any member of the community.

#2 A full range of information technology should be used to support more diverse and contemporary teaching and learning approaches and facilitate a broad range of scholarship, creative activity and research, while at the same time, preserving and disseminating vital information. It should facilitate the transformation of information to knowledge, expand learning opportunities, and allow limited resources to be used more effectively and with greater accountability.

#2b

In addition, the information technology infrastructure – that is, the delivery system for accessing and tapping information resources – should be characterized by its flexibility, ease of use, wide-spread connectivity, reliability, anytime-anywhere accessability, compatibility, standarization, expert support staff and, in totality, support the diverse users working to carry out the mission of the University.

#3 One hundred and twenty five years of instructional media research have effectively proven that no one medium is better than another in terms of meeting teaching and learning goals and that new technology does not displace good teachers. Instead, it makes them better.

We can teach and learn with all media, be they human, print, or electronic and whether near or from a far. The effectiveness of any medium is optimal when media are integrated and used in combination, and when we specifically outline the operating conditions for their use.

This includes the unique characteristics of both the learners and the content or messages to be delivered, the goals and objectives we are pursuing, and specific linkages between the teaching-learning conditions and the particular strengths of each medium that will be used. We call this process instructional design and the outcomes of the process are normally more student than faculty centered.

Evaluating the New Information Technologies

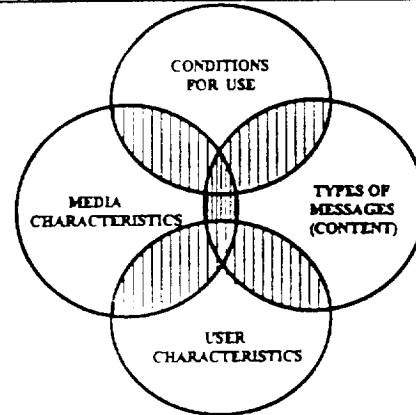
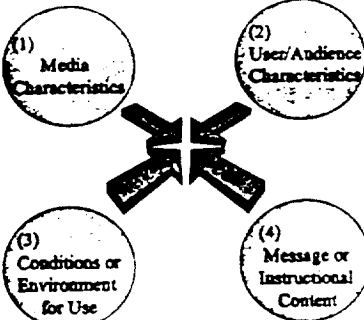

TPDL

OPPORTUNITIES FOR DISTANCE LEARNING

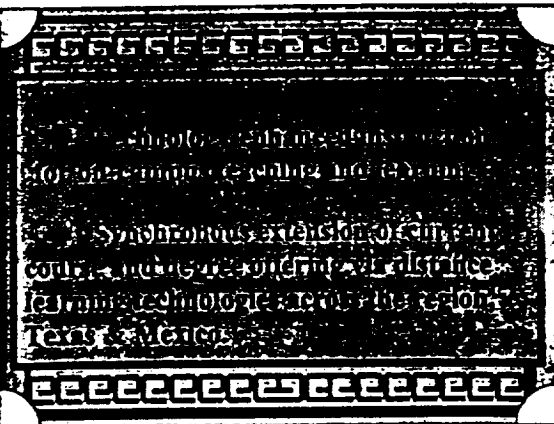

Working collaboratively with other educational entities to receive, transmit and design (tailor-made) distance learning instructional offerings.

Contract work to design and deliver both synchronous and asynchronous instruction to Ft. Bliss, the maquilas, the school districts and other adult learners at home and workplace.

TPDL

OUR MISSION



OUR MISSION

- Provides students access and opportunities to lifelong learning through the use of alternative media and methods for the delivery of instruction.
- Serves as the campus focal point and catalyst for the design, delivery and evaluation of distance education
- Works in collaboration with public and private sector institutions to meet the expanding needs for higher education and workforce re-tooling.



OUR MISSION

- Develops instructional programs that integrate a wide variety of print, face-to-face contact, and electronic communication media for teaching and learning.
- Promotes the cost-effective use of new information media and telecommunications technologies at instructional sites both on and off-campus.



TPDL

OUR SERVICES

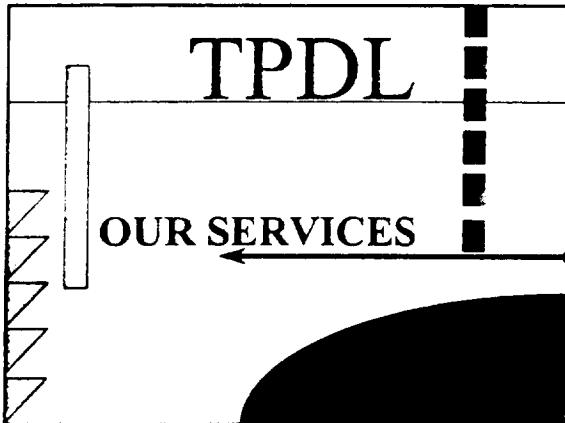

OUR SERVICES

- Work jointly with faculty, staff and students to design and adapt instructional material for distance learning.
- Train and provide support to faculty, staff and students in the proper use of equipment in the distance learning classrooms.
- Provide technical support during videoconferences and periods of multimedia classroom usage.
- Schedule and coordinate the use of campus distance learning facilities across the network service areas and other learning sites.
- Support faculty in the instructional development, implementation and integration of new media and technology for teaching and learning.

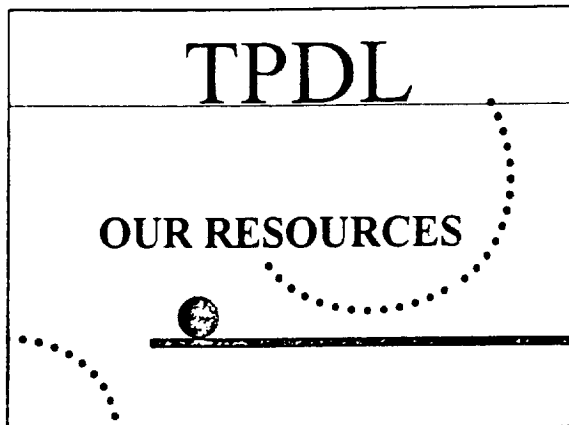

- Four fully equipped distance learning videoconferencing suites with up to a full T-1 in bandwidth.
- Regional, state, national and international connections through local and state telecommunication networks.
- ISDN dial-in and dial-up services for voice, video and data connectivity.
- Staff expertise in web page development and internet access.
- State of the art multimedia and interactive videoconferencing facilities.
- Image scanner and digital camera equipment for faculty and student instructional projects.
- Video projector and LCD panel for multimedia presentations.

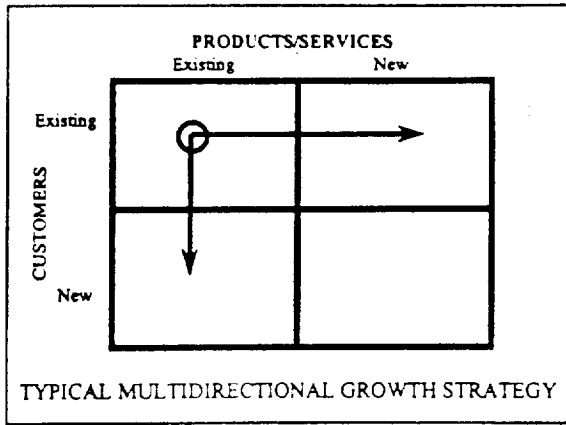
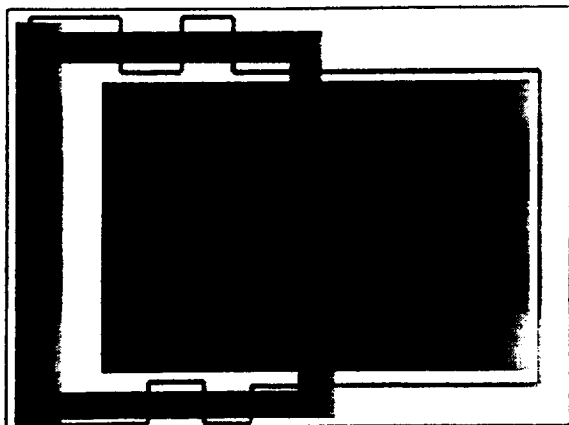

THRUST FOR FUTURE BUSINESS DEVELOPMENT

	Products		
	Current	Modified	New
Market	Current		
	Expanded		
	New		

Target Population Groups

- ◆ UTEP's Faculty, Staff, and Students
- ◆ Ft. Bliss Military and Civilian Personnel
- ◆ Regional School District Teachers, Administrators, and Students
- ◆ Northern Mexico's Consortium of Universities
- ◆ Border "Maquiladora" Industry Groups
- ◆ Small to Medium Size Border Business Groups
- ◆ Other UT Components Campus Sites and the UT TeleCampus
- ◆ "Niche" Audiences for Lifelong and Continuing Education Opportunities

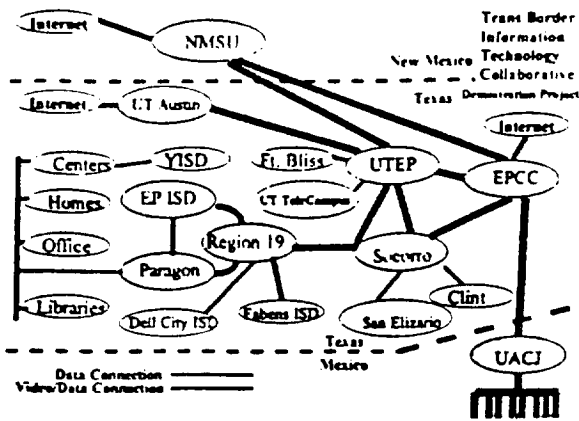

MASTER PLAN



UT TeleCampus
The University of
Texas System

University of Texas Videoconferencing Sites- 1997

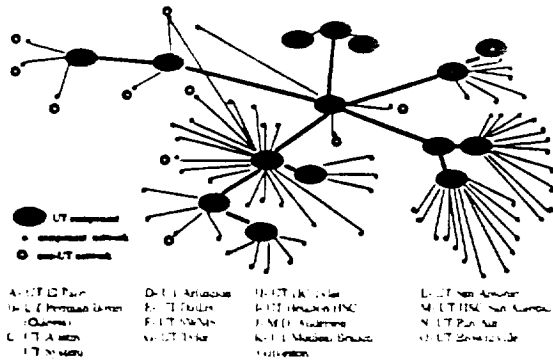

THE BORDERLAND ENCYCLOPEDIA



A digital curriculum for the 21st Century Higher Education Instruction on United States-Mexico Border Issues

Project funded with support of The UT System Chancellor's Office

<http://www.utep.edu/border>

The Commercialization of the Internet
Issues of Equity, Access, and Diversity

Welcome to the Fall 1997 seminar *Commercialization of the Internet: Issues of Equity, Access and Diversity*. Both Dr. Williams from the University of Texas at Austin and I here at the University of Texas at El Paso hope you will find this class a most worthwhile and rewarding experience as you begin to learn more about these new information technologies.

Dr. Henry Ingle
Associate Vice-President,
Office of Technology Planning
and Distance Learning



<http://www.utep.edu/ingle/internet/>

COMM 3459

Welcome to La Frontera/Borderlands Communication Seminar!

The course explores the U.S./Mexico Frontiers (border) and "the effects of new telecommunications media on communication practices" within and across the area.

For more information check our URL at:
<http://www.utep.edu/comm3459/spring97/>

One of the goals of the Seminar is to help students see what the border really is, and how the telecommunications have played an important role in the interaction between Mexico and the U.S.

To contact us go to:
<http://www.utep.edu/comm3459/fall97/>

WEB SITES

The University of Texas at El Paso 

www.utep.edu

The office of Technology Planning and Distance Learning 

www.utep.edu/tdl

Multimedia Teaching and Learning Center

www.mmtlc.utep.edu/mmtlc

The New Undergraduate Learning Center

sol.mmtlc.utep.edu/ulc

WEB SITES

Trans-Border Information Technology Collaborative (TB-ITC) 



www.utep.edu/tbitc

Borderlands Teleseminar

www.utep.edu/comm3459/spring97

Commercialization of the Internet Teleseminar



www.utep.edu/ingle/internet

Technology Planning & Distance Learning

The University Of Texas at El Paso

www.utep.edu/tdl



Oficina de Planeamiento Tecnológico y Educación a Distancia

Uniendo... La Enseñanza y el Aprendizaje... Desde Cerca y Lejos

<http://www.utep.edu/tdl/spanish>



Connecting Teaching to Learning Both Near And From Afar!

UTEP



Technology Planning &
Distance Learning

Thank you for your attention

Dr. Henry Ingle

Visit us at:
<http://www.utep.edu/dl>

