

NASA/TM—2000-209677



# Summary Report of Mission Acceleration Measurements for STS-95

Launched October 19, 1998

Kevin McPherson  
Glenn Research Center, Cleveland, Ohio

Kenneth Hrovat  
Tal-Cut Company, North Olmsted, Ohio

National Aeronautics and  
Space Administration

Glenn Research Center

---

February 2000

Available from

NASA Center for Aerospace Information  
7121 Standard Drive  
Hanover, MD 21076  
Price Code: A03

National Technical Information Service  
5285 Port Royal Road  
Springfield, VA 22100  
Price Code: A03

**SUMMARY REPORT OF MISSION ACCELERATION MEASUREMENTS FOR STS-95**  
**Launched October 29, 1998**

Kevin McPherson  
NASA Glenn Research Center  
Cleveland, Ohio

Kenneth Hrovat  
Tal-Cut Company  
North Olmsted, Ohio

This page intentionally left blank

**Abstract**

John H. Glenn's historic return to space was a primary focus of the STS-95 mission. The Hubble Space Telescope (HST) Orbital Systems Test (HOST), an STS-95 payload, was an in-flight demonstration of HST components to be installed during the next HST servicing mission. One of the components under evaluation was the cryocooler for the Near Infrared Camera and Multi-Object Spectrometer (NICMOS). Based on concerns about vibrations from the operation of the NICMOS cryocooler affecting the overall HST line-of-sight requirements, the Space Acceleration Measurement System for Free-Flyers (SAMS-FF) was employed to measure the vibratory environment of the STS-95 mission, including any effects introduced by the NICMOS cryocooler.

The STS-95 mission represents the first STS mission supported by SAMS-FF. Utilizing a Control and Data Acquisition Unit (CDU) and two triaxial sensor heads (TSH) mounted on the HOST support structure in Discovery's cargo bay, the SAMS-FF and the HOST project were able to make vibratory measurements both on-board the vibration-isolated NICMOS cryocooler and off-board the cryocooler mounting plate. By comparing the SAMS-FF measured vibrations on-board and off-board the NICMOS cryocooler, HST engineers could assess the cryocooler g-jitter effects on the HST line-of-sight requirements. The acceleration records from both SAMS-FF accelerometers were analyzed and significant features of the microgravity environment are detailed in this report.

**Acronyms and Abbreviations**

ADC	Analog-to-Digital Converter
CCPL	Cryogenic Capillary Pumped Loop
CDU	Control and Data Acquisition Unit
CRYOTSU	Cryogenic Thermal Storage Unit Payload
CTSU	Cryogenic Thermal Storage Unit Experiment
CTSW	Cryogenic Thermal Switch
ESA	European Space Agency
EST	Eastern Standard Time
$g_0$	acceleration due to Earth's gravitational force; 9.8 m/sec <sup>2</sup>
GRC	Glenn Research Center
GSFC	Goddard Space Flight Center
HOST	HST Orbital Systems Test
HST	Hubble Space Telescope
Hz	Hertz (cycles per second)
IEH	International Extreme Ultraviolet Hitchhiker
ISS	International Space Station
KSC	Kennedy Space Center
MET	Mission Elapsed Time
$\mu g$	one millionth of $g_0$
MMAP	Microgravity Measurement and Analysis Project
NASA	National Aeronautics and Space Administration
NASDA	National Space Development Agency of Japan
NICMOS	Near Infrared Camera and Multi-Object Spectrometer
PCUEP	Phase Change Upper End Plate
PI	Principal Investigator
PIMS	Principal Investigator Microgravity Services
PSD	Power Spectral Density
RMS	Root-Mean-Square
RSS	Root-Sum-Square
SAMS	Space Acceleration Measurement System
SAMS-FF	Space Acceleration Measurement System for Free-Flyers
STS	Space Transportation System
TSH	Triaxial Sensor Head
$X_H, Y_H, Z_H$	SAMS-FF sensor coordinate system axes
$X_O, Y_O, Z_O$	Orbiter structural coordinate system axes

**Table of Contents**

Abstract .....	i
Acronyms and Abbreviations .....	ii
Table of Contents .....	iii
List of Figures, List of Tables .....	iv
Acknowledgements .....	iv
1. Introduction .....	1
2. Mission Crew and Payloads .....	2
3. SAMS-FF Sensor Orientations and Locations .....	3
4. Overview of Acceleration Environment .....	4
5. Microgravity Environment .....	5
5.1. Discovery .....	6
5.1.1. Ku-band Antenna .....	6
5.1.2. Orbiter Structural Modes .....	6
5.1.3. Sleep Versus Wake Comparison .....	6
5.1.4. 0 – 2 Hz Environment .....	7
5.1.5. Session #32 Sawtooth Waveform .....	8
5.2. Cryogenic Thermal Storage Unit Disturbance Signature .....	8
6. Summary .....	9
7. References .....	10
Appendix A Power Spectral Density Plots for TSH 1 (0 – 30 Hz) .....	A-1
Appendix B Power Spectral Density Plots for TSH 1 (0 – 150 Hz) .....	B-1
Appendix C Power Spectral Density Plots for TSH 2 (0 – 30 Hz) .....	C-1
Appendix D Power Spectral Density Plots for TSH 2 (0 – 150 Hz) .....	D-1
Appendix E Interval Min/Max Plots for TSH 1 .....	E-1
Appendix F Interval Min/Max Plots for TSH 2 .....	F-1
Appendix G Accessing Acceleration Data Via the Internet .....	G-1
Appendix H Reader Feedback .....	H-1

**List of Figures**

Figure 1. SAMS-FF Equipment Location on the HOST Structure ..... 11

Figure 2. HOST Equipment Location in Discovery’s Cargo Bay ..... 11

Figure 3. Orbiter Structural Coordinate System ..... 12

Figure 4. TSH 1 Recording Session 32 Power Spectral Density Plot Showing 17 Hz  
and 4.8 Hz Benchmarks ..... 13

Figure 5. Crew Sleep versus Crew Active Session 32 versus Session 20 ..... 14

Figure 6. Crew Sleep Versus Crew Active Session 41 versus Session 37 ..... 15

Figure 7. TSH 1 Recording Session 32 Power Spectral Density Plot, 0 - 2 Hz ..... 16

Figure 8. TSH 2 Recording Session 32 Power Spectral Density Plot, 0 - 2 Hz ..... 17

Figure 9. TSH 1 Recording Session 41 Power Spectral Density Plot, 0 - 2 Hz ..... 18

Figure 10. TSH 2 Recording Session 41 Power Spectral Density Plot, 0 - 2 Hz ..... 19

Figure 11. Recording Session 32, 0.5 Hz Lowpass Filtered Data ..... 20

Figure 12. Recording Session 11 Illustrating 3 Active Cryocoolers and Associated Harmonics ..... 21

Figure 13. Recording Session 40 Illustrating 1 Active Cryocooler and Associated Harmonics ..... 22

**List of Tables**

Table 1. STS-95 Crew ..... 2

Table 2. STS-95 SAMS-FF TSH 1 Orientation and Location ..... 3

Table 3. STS-95 SAMS-FF TSH 2 Orientation and Location ..... 3

Table 4. TSH 1 to TSH 2 Axis Alignment ..... 3

Table 5. MET Start Time for Recording Sessions ..... 5

Table 6. RMS Acceleration Levels Attributed to CRYOTSU Cooler Operations ..... 9

**Acknowledgements**

The authors would like to thank the PIMS and SAMS-FF teams at the NASA Glenn Research Center, particularly Dale Mortensen, Bruce Johnson, Thomas Kacpura, Gregory Fedor, and Bruce Smith from SAMS-FF, for their invaluable contributions to the STS-95 mission and this report. The processing of the acceleration data by the SAMS-FF team made the analyses found in this report possible. The formatting and editing performed by Timothy Reckart on many of the graphics in this report was also much appreciated. The technical review, comments, and suggestions from Melissa Rogers and Richard DeLombard were much appreciated.

An additional thanks is owed to Darrell Story of the Goddard Space Flight Center for his information about the HOST payload. The authors would like to thank Charlotte Gerhart of the Air Force Research Laboratory Vehicle Technologies Branch for her information about the CRYOTSU flight experiment.



## 1. Introduction

Liftoff of the Space Shuttle Orbiter Discovery occurred at 2:20 p.m. Eastern Standard Time (EST) from the Kennedy Space Center (KSC) on Thursday, October 29, 1998, beginning the flight of STS-95 and John Glenn's historic return to space. The 92<sup>nd</sup> mission of the Space Transportation System had several objectives, including a variety of experiments to be conducted in the pressurized SPACEHAB module, deployment and retrieval of the SPARTAN free-flyer payload, the International Extreme Ultraviolet Hitchhiker (IEH) payloads, and the Hubble Space Telescope (HST) Orbital Systems Test (HOST). After nearly nine days in orbit, the Space Shuttle Orbiter Discovery landed at the KSC Shuttle Landing Facility at 12:04 p.m. EST on November 7, 1998.

As a part of its charter, the Microgravity Measurement and Analysis Project (MMAP) at NASA's Glenn Research Center (GRC) is tasked with the development of microgravity acceleration measurement systems whose function is to measure the relatively minute accelerations aboard the STS. Under normal circumstances, the focus of this report and the focus of the microgravity acceleration measurement effort for this mission would be the analysis of the STS microgravity acceleration environment in support of microgravity science Principal Investigators (PI). The STS-95 mission presented a unique situation in that the MMAP support was enlisted in support of the HOST payload of the HST program at NASA's Goddard Space Flight Center (GSFC).

The Space Acceleration Measurement System for Free-Flyers (SAMS-FF) was selected to support the HOST payload, specifically investigation of the vibratory output from the Near Infrared Camera and Multi-Object Spectrometer (NICMOS) cryocooler. Used previously in support of sounding rocket and KC-135 microgravity science investigations, the STS-95 mission represented the maiden voyage of the SAMS-FF in support of a payload on the STS. Utilizing a Control and Data Acquisition Unit (CDU) and two triaxial sensor heads (TSH) mounted on the HOST support structure in Discovery's cargo bay, the SAMS-FF and the HOST project were able to collect vibratory measurements both on-board and off-board the HOST equipment under test.

This report is divided into two parts consisting of introductory and background information (Sections 2-4) followed by detailed microgravity environment analysis (Sections 5-6). Section 2 describes the STS-95 crew and the primary payloads on-board STS-95. Section 3 details, via drawings and tables, the location of the SAMS-FF system components relative to the HOST payload. Section 4 contains more detailed discussions of the SAMS-FF and HOST hardware. It provides a detailed description of the HOST mission objective and the use of the SAMS-FF system to satisfy that objective. Since STS-95 was the inaugural STS mission for SAMS-FF, this section also details the SAMS-FF system. Section 5 describes the microgravity environment and contains appropriate comparisons to the Space Acceleration Measurement System (SAMS) data from previous missions. Finally, section 6 summarizes the findings of the analysis effort detailed in this report.

The first four appendices (Appendix A through Appendix D) of this report contain power spectral density (PSD) plots for the SAMS-FF data collected during the STS-95 mission. Appendices A and B contain PSD plots for the off-board TSH termed TSH 1. These PSD plots are provided over two frequency ranges, 0-30 Hz and 0-150 Hz. Appendices C and D contain PSD plots for the on-board TSH, termed TSH 2. These PSD plots are also provided over two frequency ranges, 0-30 Hz and 0-150 Hz. Appendices E and F are interval minimum/maximum plots for TSH 1 and TSH 2, respectively. All data for appendices A through F are plotted in the sensor coordinate system. Appendix G is provided for those interested in accessing the SAMS-FF acceleration data via the Internet. Appendix H solicits reader feedback regarding this report.

## 2. Mission Crew and Payloads

The STS-95 mission utilized seven crew members, including an international team with representatives from the European Space Agency (ESA) and the National Space Development Agency of Japan (NASDA). STS-95 marks the much-celebrated return to space of John Glenn as Payload Specialist-2. The entire STS-95 crew is listed in Table 1 below.

*Table 1. STS-95 Crew*

<b>Crewmember</b>	<b>Position</b>	<b>Abbreviation</b>
Curtis L. Brown	Commander	CDR
Stephen W. Lindsey	Pilot	PLT
Pedro Duque	Mission Specialist 1 (ESA)	MS-1
Stephen K. Robinson	Mission Specialist 2	MS-2
Scott E. Parazynski	Mission Specialist 3	MS-3
Chiaki Mukai	Payload Specialist 1 (NASDA)	PS-1
John H. Glenn	Payload Specialist 2	PS-2

The SPACEHAB module for STS-95 was a single module located in the forward portion of Discovery's payload bay. SPACEHAB provided facilities for a number of experiments sponsored by NASA, ESA, and NASDA in the life science and microgravity science disciplines. The SPARTAN 201 free-flyer was designed to study the conditions and processes of the hot outer layers of the Sun's atmosphere or solar corona and gathered information about the solar corona and solar wind. This was a re-flight of the SPARTAN payload flown on STS-87 that experienced technical difficulties after deployment from the Orbiter. The IEH payload included a half-dozen experiments mounted on a support structure in Discovery's cargo bay. More details about each of these payloads are contained in the STS-95 press kit [1].

### 3. SAMS-FF Sensor Orientations and Locations

The SAMS-FF configuration for the STS-95 mission consisted of two TSHs and a single CDU. TSH 1 was mounted on the primary HOST structure and TSH 2 was located on the vibration-isolated NICMOS cryocooler. Figure 1 and Figure 2 illustrate the location and orientation of the SAMS-FF TSH's on the HOST structure. Figure 1 is the HOST structure with the TSH area enlarged and Figure 2 is the HOST structure position in Discovery's cargo bay. The transformation equations for converting the recorded acceleration data from sensor head coordinates to Orbiter structural coordinates (Figure 3) are provided in Table 2 and Table 3. These tables are provided for continuity with previous mission summary reports, where data are presented in the Orbiter structural coordinate system. Again, for this report, all the data are referenced in sensor coordinates and Table 4 provides the relationship between the sensor axes from TSH 1 to TSH 2. On this mission, each SAMS-FF sensor axis accelerometer acquired more than four million measurements.

*Table 2. STS-95 SAMS-FF TSH 1 Orientation and Location*

Orientation		Location	
Orbiter Structural Axis	Sensor Axis	Orbiter Structural Coordinates (inches)	
+X <sub>O</sub>	X <sub>H</sub>	X <sub>O</sub> = 1146	
+Y <sub>O</sub>	-Z <sub>H</sub> cos(21°)-Y <sub>H</sub> sin(21°)	Y <sub>O</sub> = 64	
+Z <sub>O</sub>	Y <sub>H</sub> cos(21°)-Z <sub>H</sub> sin(21°)	Z <sub>O</sub> = 403	

*Table 3. STS-95 SAMS-FF TSH 2 Orientation and Location*

Orientation		Location	
Orbiter Structural Axis	Sensor Axis	Orbiter Structural Coordinates (inches)	
+X <sub>O</sub>	-Y <sub>H</sub>	X <sub>O</sub> = 1141	
+Y <sub>O</sub>	Z <sub>H</sub> cos(21°)-X <sub>H</sub> sin(21°)	Y <sub>O</sub> = 60	
+Z <sub>O</sub>	X <sub>H</sub> cos(21°)+Z <sub>H</sub> sin(21°)	Z <sub>O</sub> = 403	

*Table 4. TSH 1 to TSH 2 Axis Alignment*

TSH 1 Sensor Axis	TSH 2 Sensor Axis
+X <sub>H</sub>	+Y <sub>H</sub>
+Y <sub>H</sub>	+X <sub>H</sub>
+Z <sub>H</sub>	-Z <sub>H</sub>

#### 4. Overview of Acceleration Measurement Equipment

The primary objective of the HOST project was to demonstrate the successful in-flight operation of HST components to be installed during the next HST servicing mission. The SAMS-FF system supported HOST by making measurements of the vibratory environment both on-board the vibration-isolated NICMOS cryocooler and off-board the cryocooler. With the off-board TSH measurements serving as a baseline for the nominal Orbiter microgravity environment, an assessment of the contribution of the NICMOS cryocooler to the overall vibratory environment was obtained using the on-board TSH. Proper account of the contribution of the cryocooler was required in order to assess the impact of the vibrations of the cryocooler on the HST line-of-sight pointing requirements. The line-of-sight pointing accuracy of the HST is less than 0.007 arcsec, which is equivalent to viewing a dime on the Empire State Building from Washington, D.C. Therefore, an accurate measure of the vibratory contribution of the NICMOS cryocooler is paramount.

The SAMS-FF is a flexible and modularized acceleration measurement system capable of numerous operating configurations, including direct experiment control or autonomous operations. The HOST payload utilized this flexibility by interfacing directly with the SAMS-FF CDU to control recording of the microgravity environment during the STS-95 mission. The SAMS-FF utilizes a 24 bit analog-to-digital converter (ADC) and is capable of measuring accelerations over the range  $\pm 1.25$  g with a single gain setting. For further flexibility, each sensor head has a programmable sampling rate available, with a minimum of 10 samples per second and a maximum of 800 samples per second. These sample rates correspond to effective bandwidths as low as 2.5 Hz and as high as 200 Hz.

Unlike recent microgravity-dedicated SAMS missions where data were recorded continually throughout the mission, the data set collected by the SAMS-FF in support of the HOST payload consisted of forty-three recording sessions, each lasting 255 seconds. Table 5 lists the Mission Elapsed Time (MET) start time for recording sessions 3 through 43. Although, the SAMS-FF allows for a variable sampling rate, the HOST project requested a fixed sampling rate of 400 samples per second for each TSH. The nominal bandwidth at this sampling rate is approximately 100 Hz. Each TSH recorded data simultaneously with the other, enabling the on-board and off-board comparison of the acceleration environment during specific operational phases of the HOST equipment. Approximately ninety-seven percent of the available data storage was utilized with all data successfully downloaded on the ground. No on-orbit anomalies were reported in SAMS-FF operations.

While the data from each TSH were recorded simultaneously, the lack of long periods of contiguous data made analyzing the data a difficult task. This was especially true for frequency domain analysis, where color spectrograms (time vs. frequency vs. PSD) are normally employed to demonstrate the start and stop of vibratory events. For the appendices in this report, color spectrograms are replaced by PSD versus frequency and acceleration versus time plots.

*Table 5. MET Start Time for Recording Sessions*

<b>Session Number</b>	<b>MET Start Time</b>	<b>Session Number</b>	<b>MET Start Time</b>
3	000/00:05:59	24	003/15:18:40
4	000/06:16:20	25	003/15:23:10
5	000/19:51:51	26	003/22:09:55
6	000/19:58:48	27	003/22:14:20
7	000/20:12:30	28	004/09:07:49
8	000/20:17:40	29	004/09:12:36
9	000/20:23:30	30	005/09:05:33
10	000/21:26:26	31	005/09:10:24
11	001/00:58:00	32	005/15:01:29
12	001/18:29:27	33	006/07:02:30
13	001/20:48:05	34	007/21:59:00
14	001/20:53:25	35	008/03:38:40
15	002/04:25:50	36	008/03:44:30
16	002/04:30:30	37	008/03:49:55
17	002/18:22:52	38	008/05:55:56
18	002/18:27:40	39	008/07:43:47
19	002/18:32:24	40	008/10:02:55
20	002/20:20:04	41	008/12:48:48
21	002/20:24:55	42	008/14:30:40
22	002/20:30:00	43	008/14:35:25
23	002/20:34:25		

## 5. Microgravity Environment

The aim of the analysis in this section is to identify, quantify, and otherwise characterize significant aspects of the microgravity environment that were measured by the SAMS-FF. The top-level analyses demonstrate the ability of the SAMS-FF system to accurately measure the microgravity acceleration environment and aid the HOST team in satisfying their objectives. For those interested, further analyses of these data can be requested and tailored to specific needs by contacting the Principal Investigator Microgravity Services (PIMS) project at the GRC via electronic mail at [pims@grc.nasa.gov](mailto:pims@grc.nasa.gov).

## 5.1. Discovery Microgravity Environment

### 5.1.1. Ku-band Antenna

The root-mean-square (RMS) acceleration attributed to the Orbiter Ku-band antenna dither at 17 Hz (Figure 4) serves as a benchmark for the evaluation of the acceleration measurements recorded on STS-95 [2]. The 17 Hz dither frequency and its harmonics are present in acceleration data from all instrumented Orbiter missions; the STS-95 mission was no exception. The nominal RMS acceleration for the fundamental 17 Hz dither frequency is typically in the range of 100 – 200  $\mu\text{g}_{\text{RMS}}$  [3]. Per the Appendix A plots, the Ku-band antenna dither was present from recording session 3 (MET 000/05:59:00) through recording session 37 (MET 008/03:49:55). Session 32 was analyzed and the RMS acceleration value for the Ku-band antenna dither frequency was 140  $\mu\text{g}_{\text{RMS}}$ . For recording sessions 38 through 43, when the Ku-band antenna dither was turned off, the RMS acceleration for the frequency band normally dominated by the Ku-band antenna dither frequency (17 Hz) was reduced to less than 12  $\mu\text{g}_{\text{RMS}}$ .

### 5.1.2. Orbiter Structural Modes

A second benchmark for the evaluation of the acceleration measurements on STS-95 is the 4.8 Hz  $Z_0$ -axis structural mode (Figure 4). The RMS acceleration imparted on the environment from this structural mode is influenced greatly by crew activity. Nominal levels for the 4.8 Hz structural mode during crew active periods is in the range 20 – 30  $\mu\text{g}_{\text{RMS}}$  while crew quiet periods show a reduction to approximately 5 – 10  $\mu\text{g}_{\text{RMS}}$ . Again, recording session 32 (MET 005/15:01:29) was analyzed in detail because it was one of eleven recording sessions that occurred during a crew sleep period. For recording session 32, the RMS acceleration measured for the 4.8 Hz  $Z_0$ -axis structural mode was just under 4  $\mu\text{g}_{\text{RMS}}$ . This measurement is consistent with a crew quiet period. For recording session 20 (MET 002/20:20:04), the RMS acceleration measured for the 4.8 Hz  $Z_0$ -axis structural mode was 11.6  $\mu\text{g}_{\text{RMS}}$ , a value less than expected for a crew active period like session 20. Nonetheless, the delta of 7.6  $\mu\text{g}_{\text{RMS}}$  illustrates the influence of crew activity on this benchmark. The corresponding increase in energy when compared to recording session 32 is a direct result of crew activity on this structural mode.

### 5.1.3. Sleep Versus Wake Comparison

The differences in the microgravity environment between crew active periods and crew sleep periods have been documented for previous Shuttle missions [3-5]. Consequently, a high level illustration of the effects of crew activity and crew sleep will be provided in this report. Eleven of the forty-three SAMS-FF recording sessions occurred during crew sleep or crew inactive periods. Because the crew sleep periods represent the quietest microgravity environment, specifically in the 0 – 20 Hz region, the HOST project had particular interest in analysis of two crew sleep recording sessions, namely sessions 32 and 41.

Figure 5 plots the root-sum-square (RSS) PSD for recording session 20 (crew active, blue trace) and recording session 32 (crew sleep, red trace). For purposes of emphasizing the 0 – 20 Hz effects of crew activity, both recording sessions are plotted for the frequency range 0 - 30 Hz. The effects below 20 Hz are quite apparent as the blue trace and the red trace are clearly separated in this region of the plots. Above 20 Hz, the two traces are more aligned. The Ku-band antenna dither frequency at 17 Hz is relatively unaffected by the crew. However, the Orbiter structural modes at approximately 3.7 Hz and 4.8 Hz are clearly excited by the nominal crew activity present in recording session 20.

Figure 6 plots the RSS PSD for recording session 37 (crew active, blue trace) and recording session 41 (crew sleep, red trace). Again, the effects below 20 Hz are quite apparent as the blue trace and the red trace are clearly separated in this region of the plots. The Ku-band antenna dither frequency at 17 Hz shows a large difference unlike the comparison between sessions 20 and 32. The low level for the 17 Hz disturbance is not related to the crew's inactivity during session 41, but rather, it is because the 17 Hz Ku-band antenna dither was already turned off at this point in the mission. Like session 20, the Orbiter structural modes at approximately 3.7 Hz and 4.8 Hz are clearly excited by the nominal crew activity during recording session 37.

#### 5.1.4. 0 - 2 Hz Environment

As a result of a sensitivity in the 0 – 2 Hz frequency band, the HOST project requested a detailed look at this area of the spectrum. In particular, since sessions 32 (MET 005/15:01:29) and 41 (MET 008/12:48:48) represented the quietest measured spectra from the STS-95 mission, these sessions were examined in detail. A number of observations about this regime are listed below. The observations cited below were extracted from Figures 7-10.

##### Session #32

- Prominent spectral component at 0.6 Hz,  $Y_H$ -axis for TSH 1. This component was also observable on the  $X_H$ -axis of TSH 2 with a significantly reduced magnitude. The source of the disturbance at 0.6 Hz during session #32 has not been determined.
- $Y_H$ -axis for TSH 2 exhibited a strong spectral component at about 0.01 Hz (See Section 5.1.5)
- RSS RMS acceleration values for the frequency band  $0.2 < f < 2.11$  Hz, excluding the 0.6 Hz component cited previously, were  $1.05 \mu g_{RMS}$  for TSH 1 and  $1.00 \mu g_{RMS}$  for TSH 2

##### Session #41

- RSS RMS acceleration values for the frequency band  $0.2 < f < 2.11$  Hz, excluding the 0.6 Hz component cited previously, were  $1.16 \mu g_{RMS}$  for TSH 1 and  $1.13 \mu g_{RMS}$  for TSH 2

### 5.1.5. Session #32 Sawtooth Waveform

In order to better determine the nature of the 0.01 Hz disturbance source observed in session 32, a 0.5 Hz lowpass Chebyshev type II infinite impulse response filter was applied to the data from TSH 1 and TSH 2 for the entire session. The resultant acceleration versus time plot is shown in Figure 11 and indicates a strong sawtooth waveform for only the TSH 2,  $Y_s$ -axis data. The period of the waveform was 90 seconds, and the amplitude was 12 micro-g's (peak to peak). If this were a real disturbance, it would have corresponded to a displacement of 0.950 inches. This phenomenon was only observed on the  $Y_s$ -axis of TSH 2 and was not seen on the other axes. Therefore, it was concluded that this disturbance was not caused by a physical disturbance present in Discovery's microgravity environment.

The most likely cause of this sawtooth waveform is from several factors. First, the residual amount of acceleration was very low during this period, as close to "zero gravity" as been observed on the shuttle. It is speculated that the disturbance observed is actually the response of the control loop of the Allied Signal QA3000 accelerometer. A small amount of drag or stiction could cause an error signal to build up in the integral loop of the accelerometer, without affecting the position loop. The combination of quiet environment, proper orientation, and just the right amount of small acceleration input could lead to creating this signal. This scenario has been confirmed as a feasible explanation by the accelerometer vendor (Allied Signal). The observation of this phenomena illustrates the very low noise and high resolution capabilities of the SAMS-FF TSH signal conditioning path.

### 5.2. Cryogenic Thermal Storage Unit Disturbance Signature

The Cryogenic Thermal Storage Unit (CRYOTSU) flight payload consisted of four experiments: the Cryogenic Thermal Storage Unit (CTSU), the Cryogenic Capillary Pumped Loop (CCPL), the Cryogenic Thermal Switch (CTSW), and the Phase Change Upper End Plate (PCUEP). The objective of the CRYOTSU flight payload was to demonstrate the functionality of the four experiments to perform spacecraft thermal control in a near weightless, space environment. Supporting the CRYOTSU payload were five cryocoolers, which are small refrigerators designed to cool instruments to cryogenic temperatures.

Prior to the STS-95 mission, the HOST project indicated a concern regarding the vibrations from cryocoolers supporting the CRYOTSU flight payload, in particular the potential for the CRYOTSU payload to disturb the microgravity environment SAMS-FF and HOST was attempting to measure. The times for the recording sessions of SAMS-FF acceleration data were compared to the operating times of the CRYOTSU payload, specifically the cryocoolers. Eight of the forty-three SAMS-FF recording sessions coincided with operation of the CRYOTSU payload. Table 6 lists these recording sessions, the number of active cryocoolers during those recording sessions, and the RSS  $\mu g_{RMS}$  levels for the operating frequency range (28 – 28.5 Hz) of the cryocoolers.



**Table 6.** RMS Acceleration Levels Attributed to CRYOTSU Cooler Operations

Recording Session	Number of Active Coolers	RSS $g_{RMS}$ Levels ( $\mu g_{RMS}$ )
11	3	259.97
12	2	63.64
23	1	31.24
26	2	70.84
27	2	65.68
39	1	60.11
40	1	70.40
41	1	39.84
20	0	21.46
32	0	17.48

Sessions 20 and 32 are included at the bottom of Table 6 to illustrate the  $\mu g_{RMS}$  levels for periods when the CRYOTSU cryocoolers were not active. Session 32 is provided specifically for comparison to session 41; both of these recording sessions occurred during crew sleep periods.

Figure 12 and Figure 13 are 3-axis PSD representations of the TSH 1 acceleration data from recording sessions 11 and 40, respectively. The fundamental frequency of the cryocoolers is observed to be in the range of 28 to 28.5 Hz. As a result of the limited set of acceleration data available, no effort was made to specifically correlate any of the five cryocoolers to a specific measured fundamental frequency. The 28 – 28.5 Hz range represents the range of the observed fundamental frequency of the cryocoolers for the eight recording sessions when the cryocoolers were active. A single active cryocooler resulted in a narrow spectral line while multiple active cryocooler resulted in a more broad spectral disturbance. The broad spectral signature for the multiple active cryocooler configuration indicates each cooler has a slightly different operating frequency. The second and third harmonics of the cryocooler fundamental frequency are clearly visible in Figure 12 and Figure 13 at approximately 56 Hz and 84 Hz.

## 6. Summary

The STS-95 mission represented the return to space of John H. Glenn and the first STS mission for the SAMS-FF accelerometer. In this report, several microgravity disturbances were discussed. The extent of the analysis of the acceleration data for this mission was greatly limited by the non-contiguous nature of the recording plan. For the forty-three 255 second sessions recorded, the 17 Hz Ku-band communications antenna dither frequency and the 4.8 Hz  $Z_O$ -axis Orbiter structural mode were used as beacons to assess the ability of the SAMS-FF system to accurately measure the nominal STS microgravity environment. The measured accelerations for these beacons were consistent with measurements made by the SAMS system on previous STS flights. The CRYOTSU experiment cryocoolers were relatively high level disturbers with an operational frequency of approximately 28 Hz.

The magnitude of the CRYOTSU disturbance varied as a function of the number of active cryocoolers. The maximum disturbance observed for the configuration with three active cryocoolers was approximately  $260 \mu\text{g}_{\text{RMS}}$ . This represents a higher level disturbance source than the nominal  $100\text{-}200 \mu\text{g}_{\text{RMS}}$  17 Hz signature.

The analysis presented in this report is a top-level examination of the measured acceleration data from the STS-95 mission. GSFC performed a more detailed on-board versus off-board examination of the SAMS-FF acceleration data. For those interested, further detailed analyses of these data can be requested and tailored to specific needs by contacting the PIMS project at the GRC via electronic mail at [pims@grc.nasa.gov](mailto:pims@grc.nasa.gov).

## 7. References

- [1] STS-95 Press Kit, <http://shuttlepresskit.com/STS-95/index.htm>
- [2] Rogers, M. J. B., Hrovat, K., McPherson, K., Moskowitz, M., & Reckart, T. (1997) Accelerometer Data Analysis and Presentation Techniques. NASA Technical Memorandum 113173.
- [3] Rogers, M. J. B., Hrovat, K., McPherson, K., & Reckart, T. (1999) Summary Report of Mission Acceleration Measurements for STS-87. NASA Technical Memorandum 1999-208647
- [4] Hrovat, K. & McPherson, K. (1999) Summary Report of Mission Acceleration Measurements for STS-89. NASA Technical Memorandum 1999-209084.
- [5] DeLombard, R., McPherson, K., Hrovat, K., & Moskowitz, M. (1997) Comparison Tools for Assessing the Microgravity Environment of Missions, Carriers and Conditions. NASA Technical Memorandum 107446.

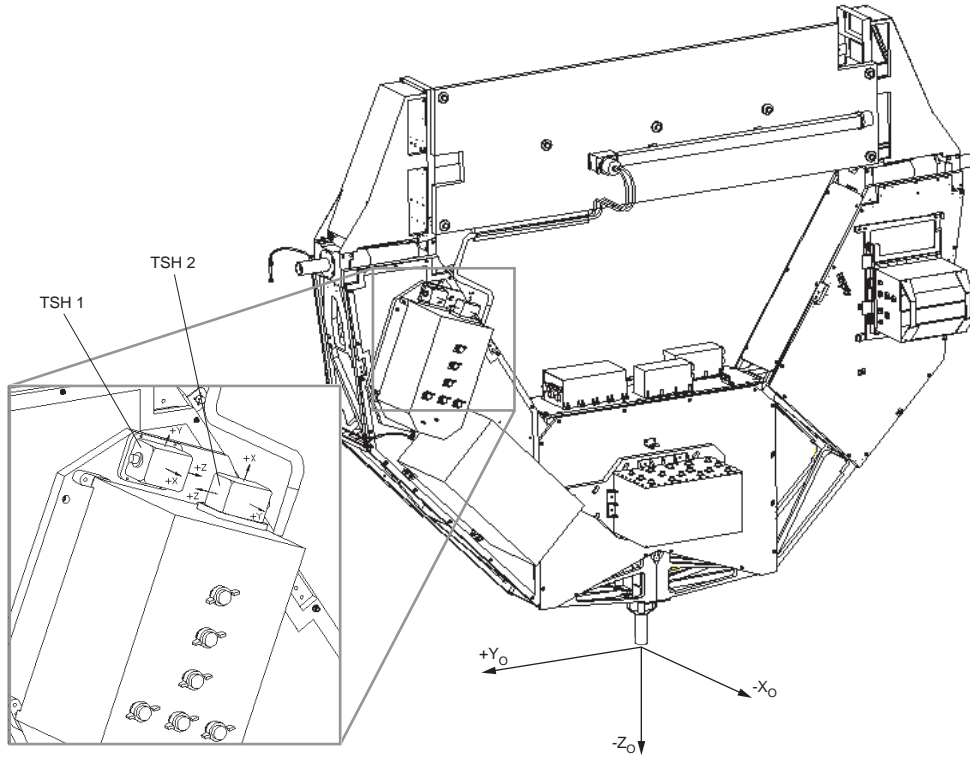

Figure 1. SAMS-FF Equipment Location on the HOST Structure.

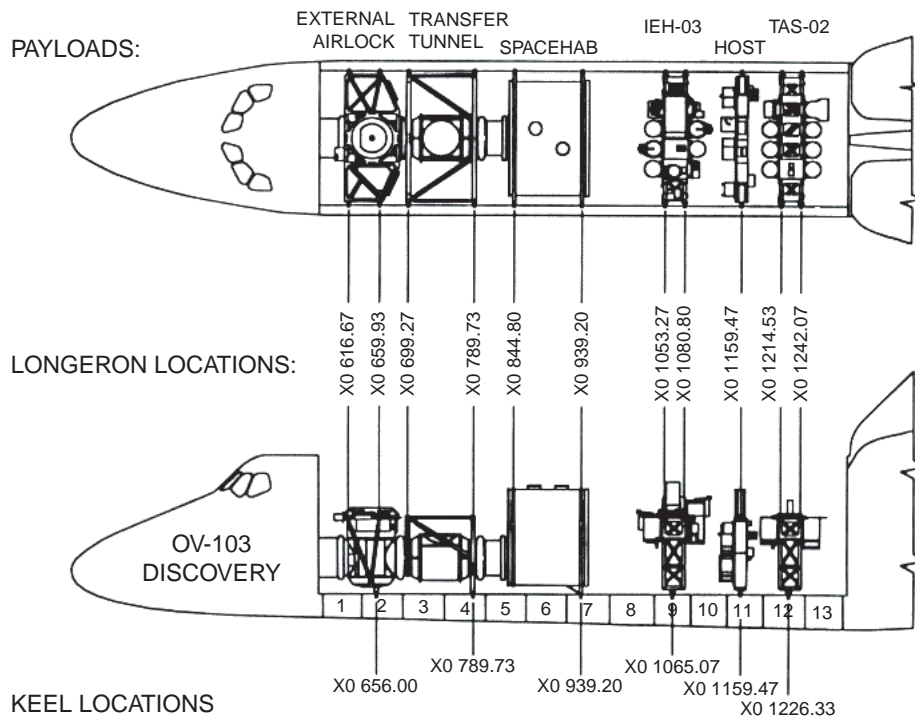

Figure 2. HOST Equipment Location in Discovery's Cargo Bay.

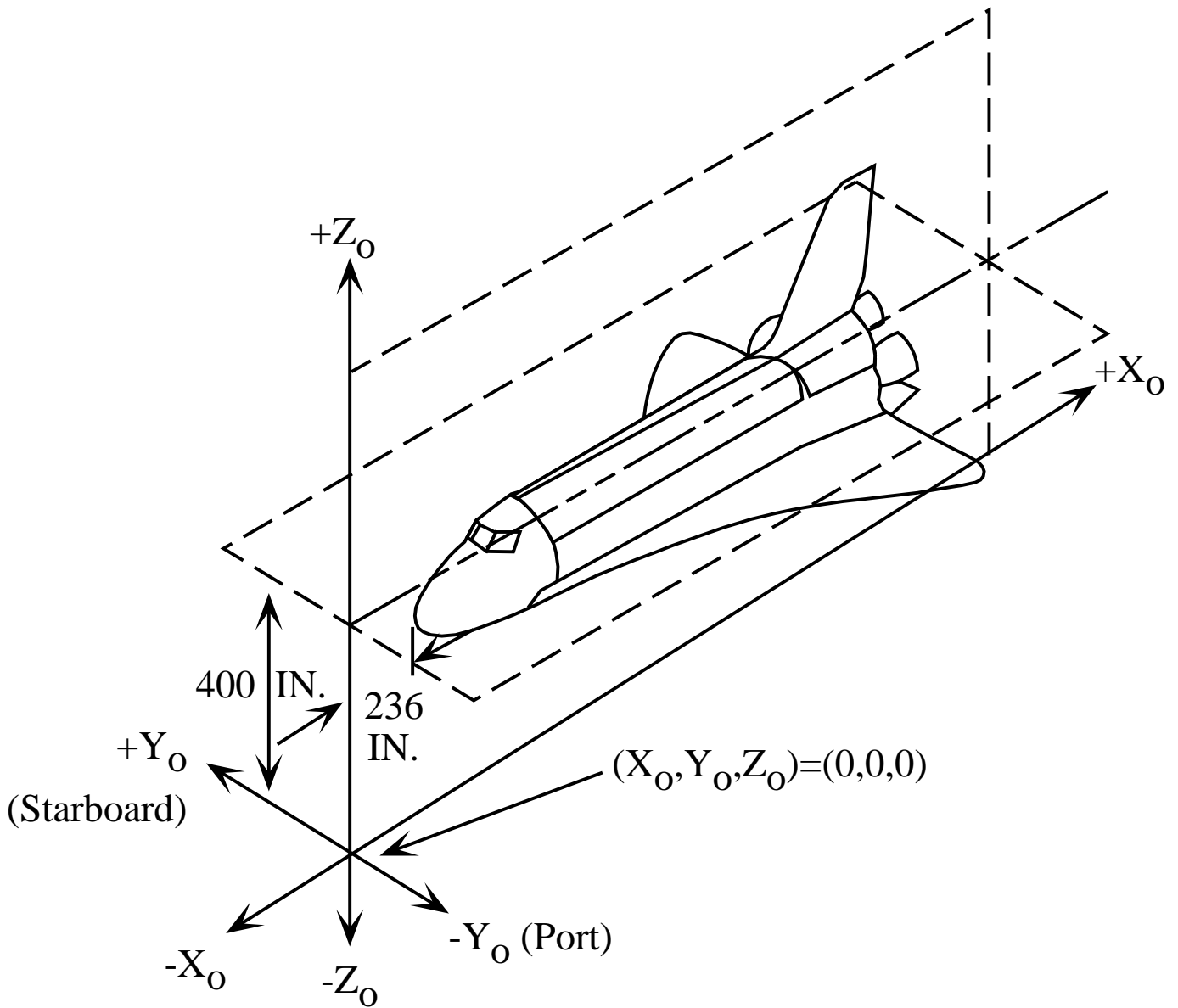

Figure 3. Orbiter Structural Coordinate System.

SUMMARY REPORT OF MISSION ACCELERATION MEASUREMENTS FOR STS-95

Head = SAMS-FF, 150 Hz  
fs=400 samples per second  
df=0.0122 Hz

Record Session #32, TSH #1  
005/15:00:45.949 (Hanning Window, k=3)

STS-95, HOST Mission  
SAMS-FF Coordinates  
T=4.1 minutes

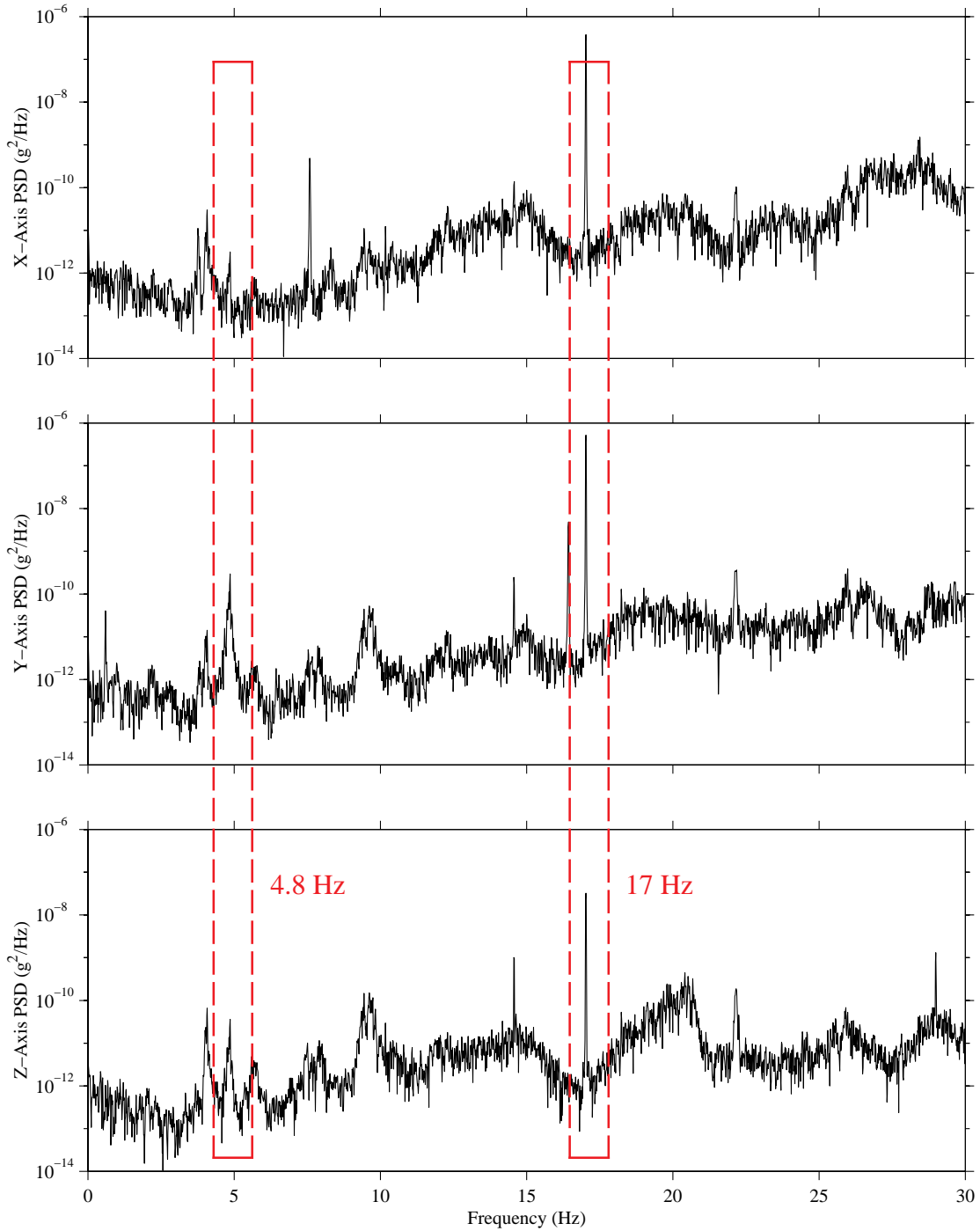

Figure 4. TSH 1 Recording Session 32 Power Spectral Density Plot Showing 17 Hz and 4.8 Hz Benchmarks.

Crew Active versus Crew Sleep (Session #20 vs. Session #32)  
MET Start at 002/20:19:12.344 (Hanning, k=12)

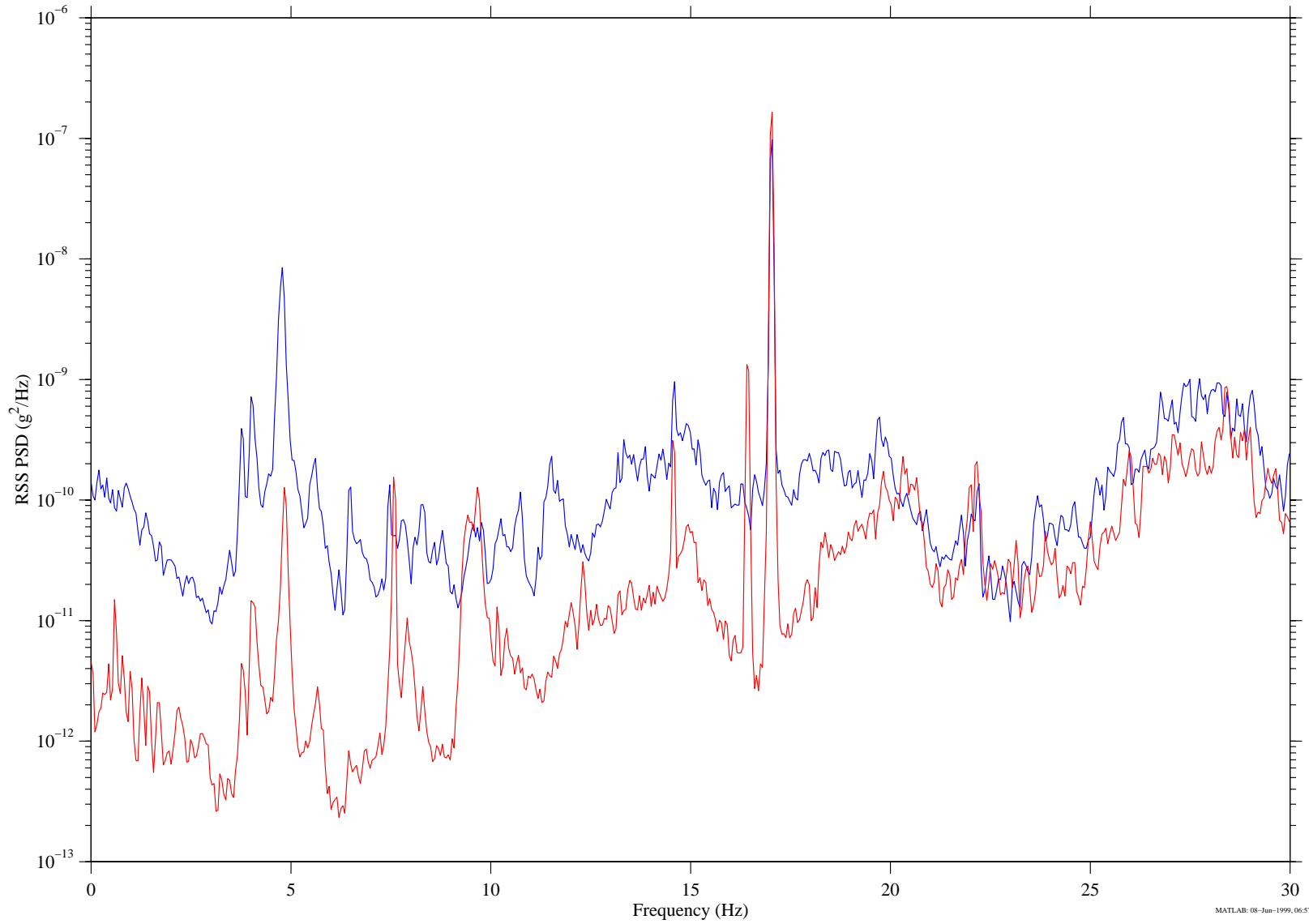

Figure 5. Crew Sleep versus Crew Active, Session 32 (red) versus Session 20 (blue).

Head SAMS-FF, TSH 1, 104.8 Hz  
fs=400 samples per second  
df=0.0488 Hz

STS-95, HOST Mission  
SAMS-FF Coordinates  
T=255.1 seconds

Crew Active Versus Crew Sleep (Session #37 vs. Session #41)  
MET Start at 008/03:47:22.101 (Hanning, k=12)

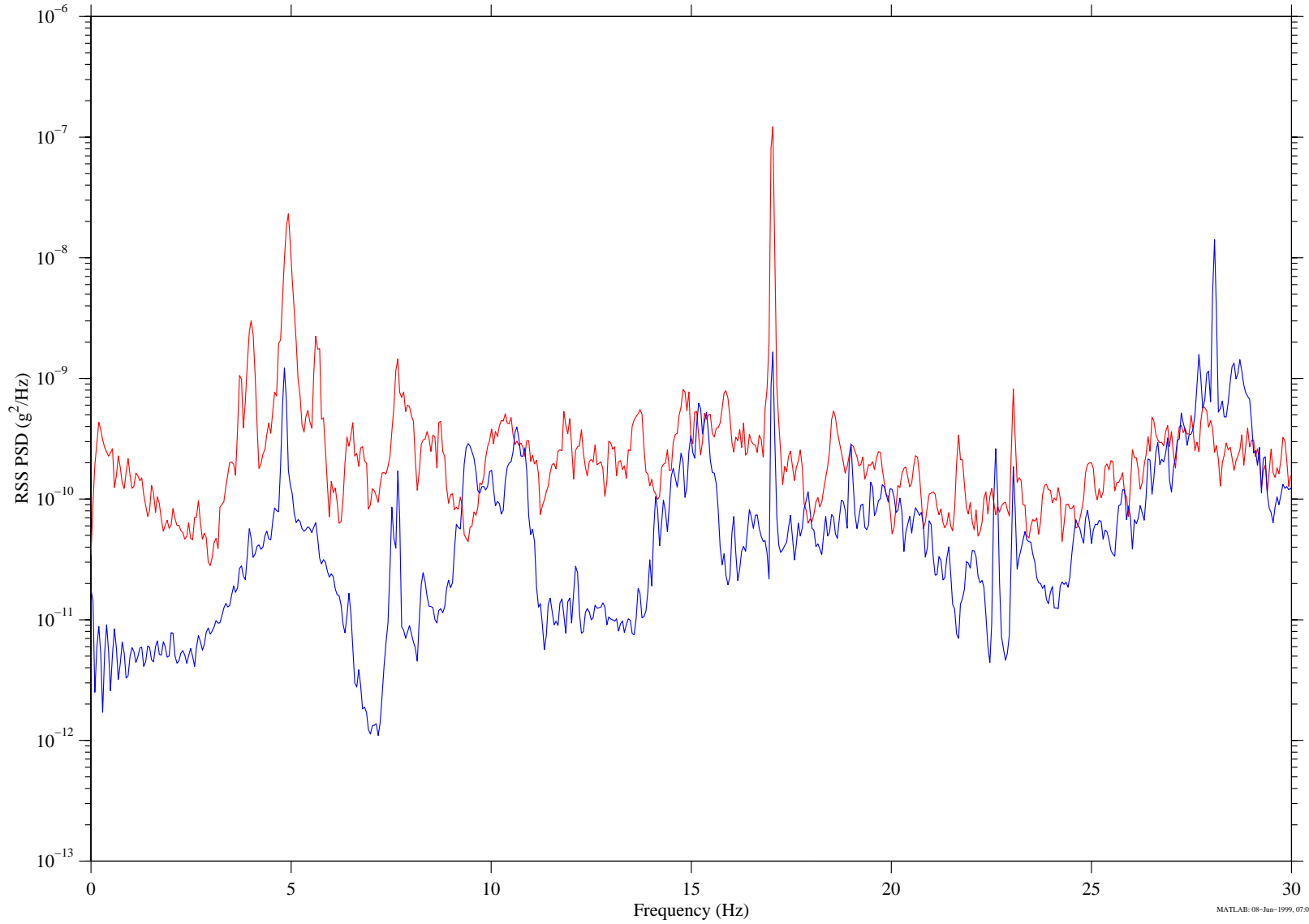

Figure 6. Crew Sleep versus Crew Active, Session 41 (blue) versus Session 37 (red).

# SUMMARY REPORT OF MISSION ACCELERATION MEASUREMENTS FOR STS-95

Head SAMS-FF, TSH 1, 150 Hz  
fs=400 samples per second  
df=0.0122 Hz

Session #32  
MET Start at 005/15:00:45.949 (Hanning Window, k=3)

STS-95, HOST Mission  
SAMS-FF Coordinates  
T=4.1 minutes

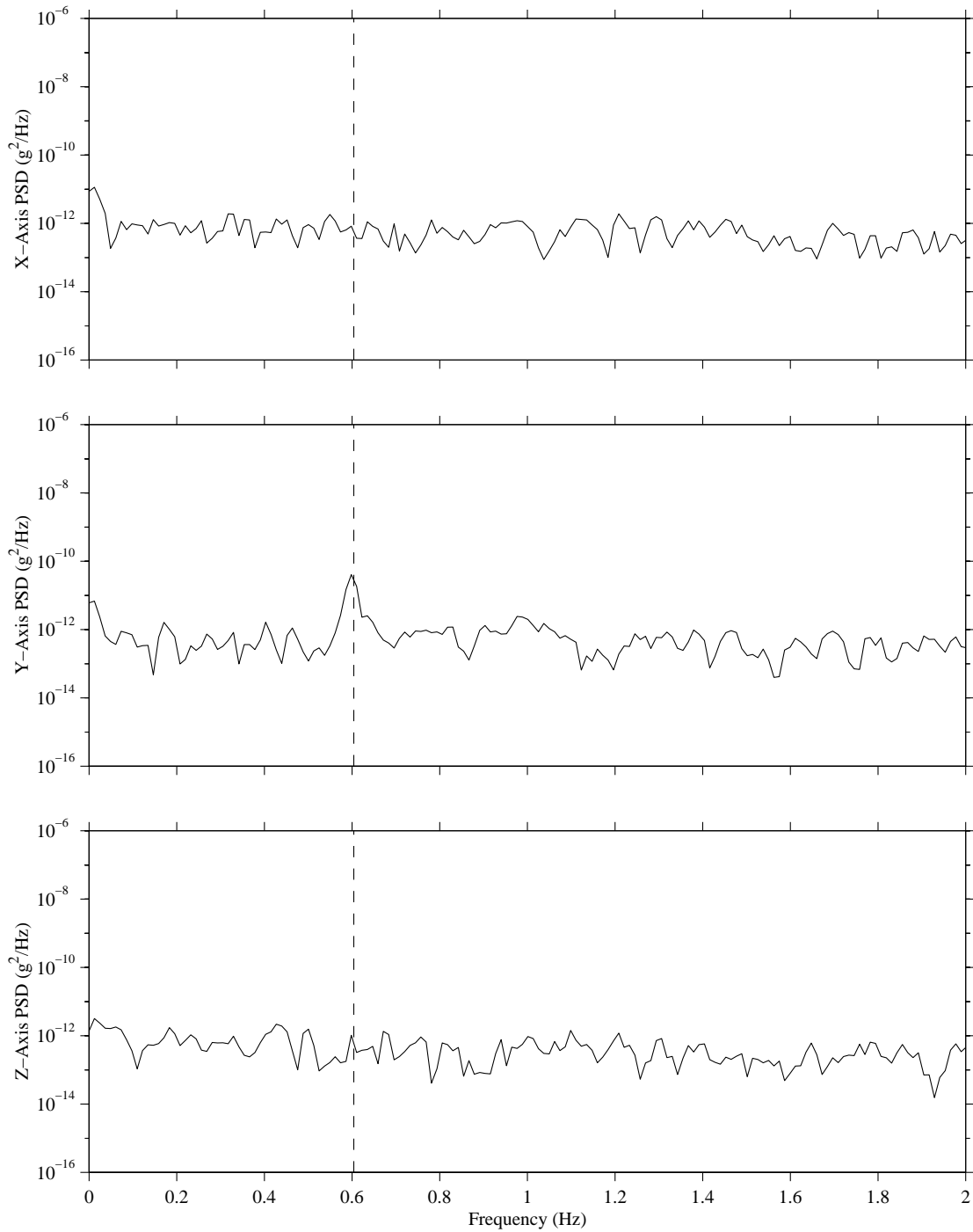

**Figure 7.** TSH 1 Recording Session 32 Power Spectral Density Plot, 0 - 2 Hz.



# SUMMARY REPORT OF MISSION ACCELERATION MEASUREMENTS FOR STS-95

Head SAMS-FF, TSH 2, 150 Hz  
fs=400 samples per second  
df=0.0122 Hz

Session #32  
MET Start at 005/15:00:46.949 (Hanning Window, k=3)

STS-95, HOST Mission  
SAMS-FF Coordinates  
T=4.1 minutes

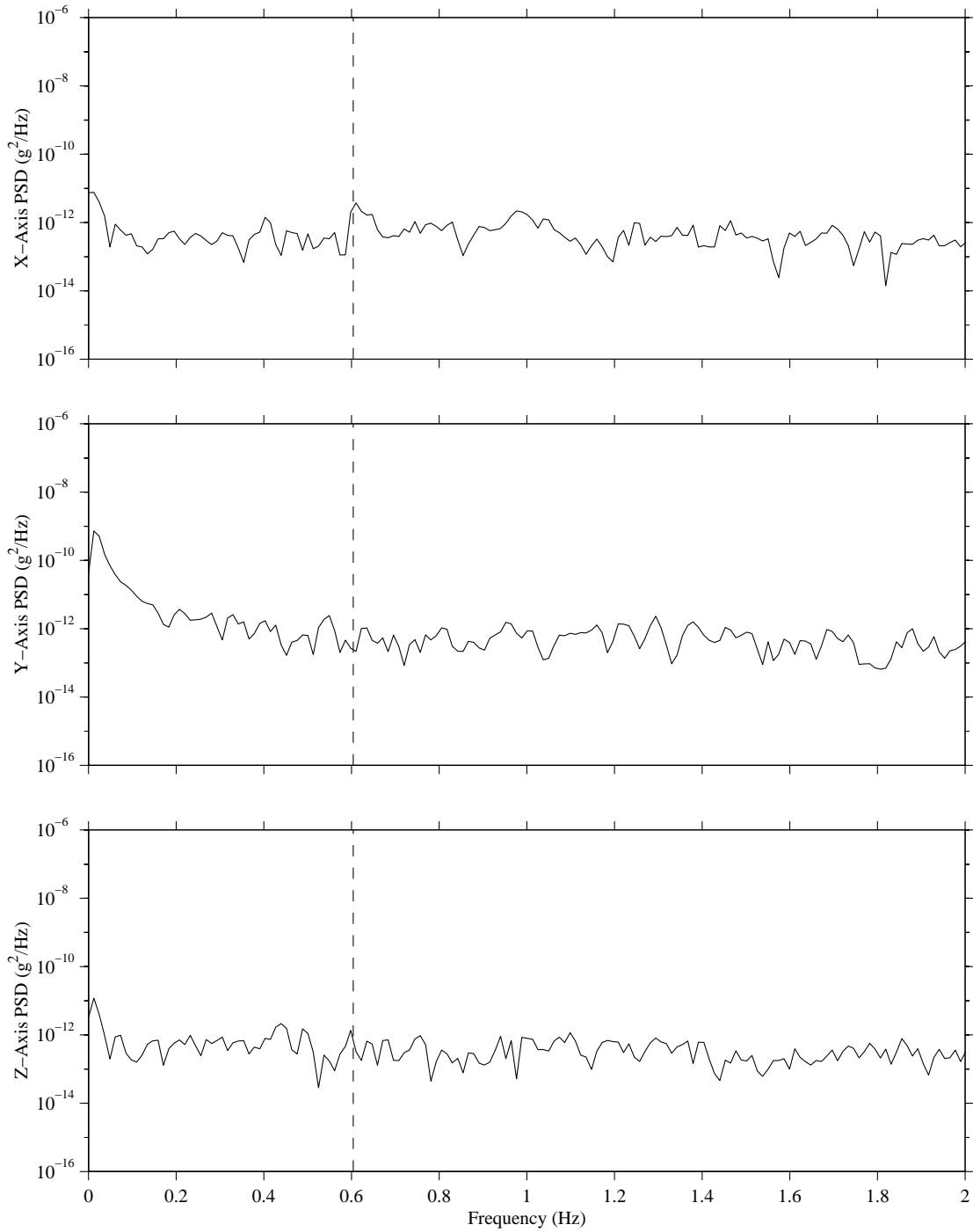

MATLAB: 02-Mar-1999, 08:01 am

**Figure 8.** TSH 2 Recording Session 32 Power Spectral Density Plot, 0 - 2 Hz.

SUMMARY REPORT OF MISSION ACCELERATION MEASUREMENTS FOR STS-95

Head SAMS-FF, TSH 1, 150 Hz  
fs=400 samples per second  
df=0.0122 Hz

Session #41  
MET Start at 008/12:47:41.959 (Hanning Window, k=3)

STS-95, HOST Mission  
SAMS-FF Coordinates  
T=4.1 minutes

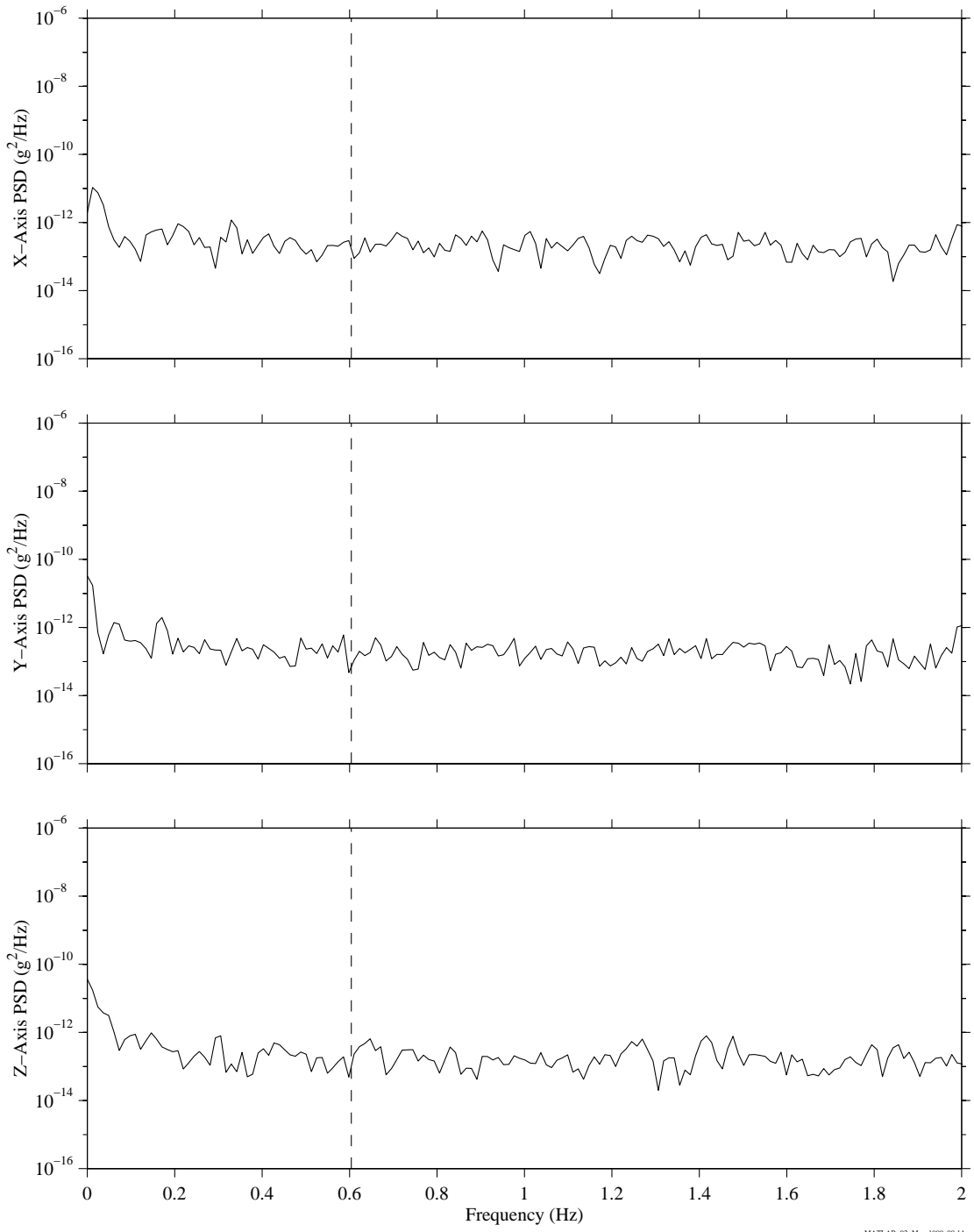

MATLAB: 02-Mar-1999, 08:14 am

Figure 9. TSH 1 Recording Session 41 Power Spectral Density Plot, 0 - 2 Hz.

SUMMARY REPORT OF MISSION ACCELERATION MEASUREMENTS FOR STS-95

Head SAMS-FF, TSH 2, 150 Hz  
fs=400 samples per second  
df=0.0122 Hz

Session #41  
MET Start at 008/12:47:42.959 (Hanning Window, k=3)

STS-95, HOST Mission  
SAMS-FF Coordinates  
T=4.1 minutes

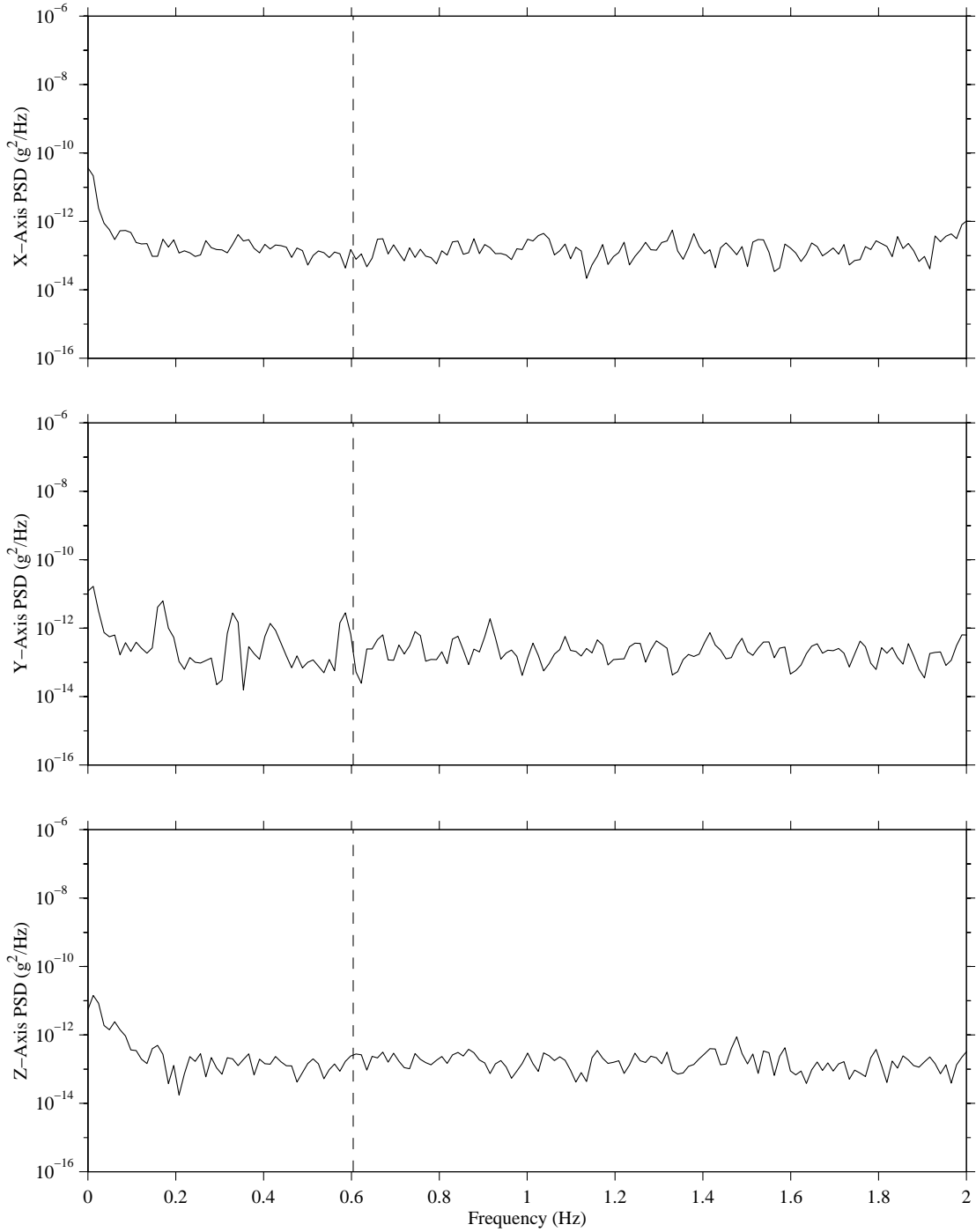

Figure 10. TSH 2 Recording Session 41 Power Spectral Density Plot, 0 - 2 Hz.

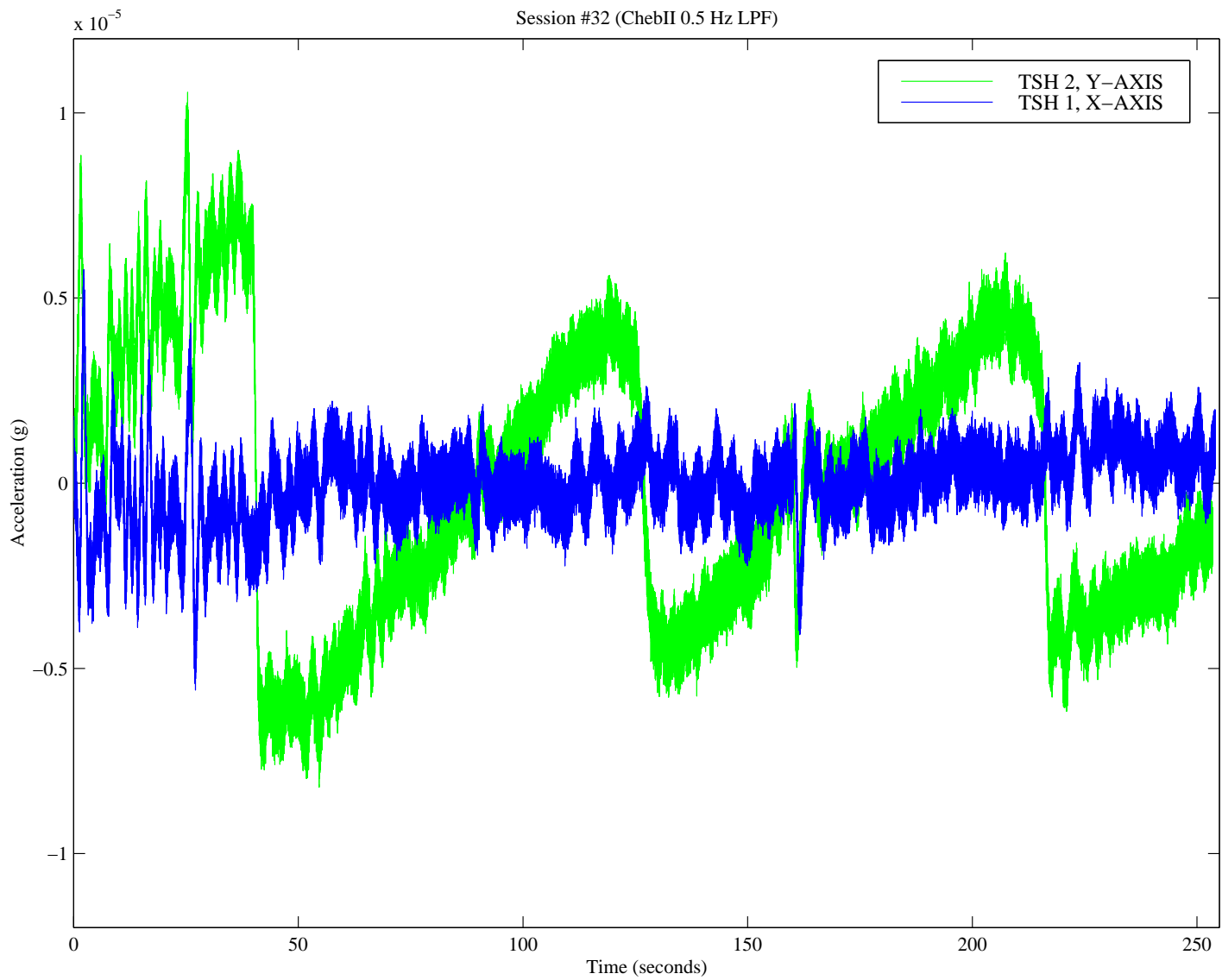

Figure 11. Recording Session 32, 0.5 Hz Lowpass Filtered Data.

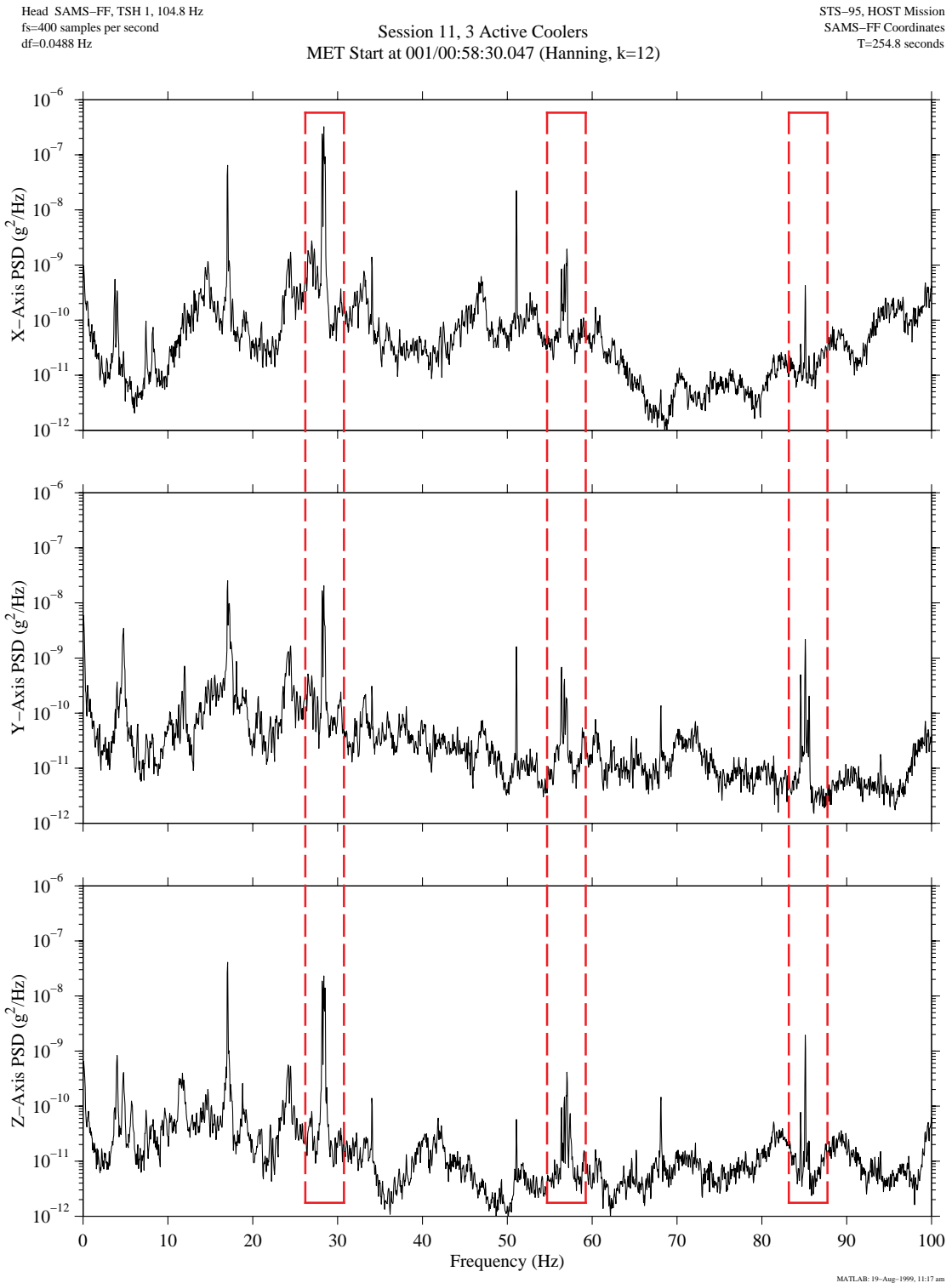

Figure 12. Recording Session 11 Illustrating 3 Active Cryocoolers and Associated Harmonics.

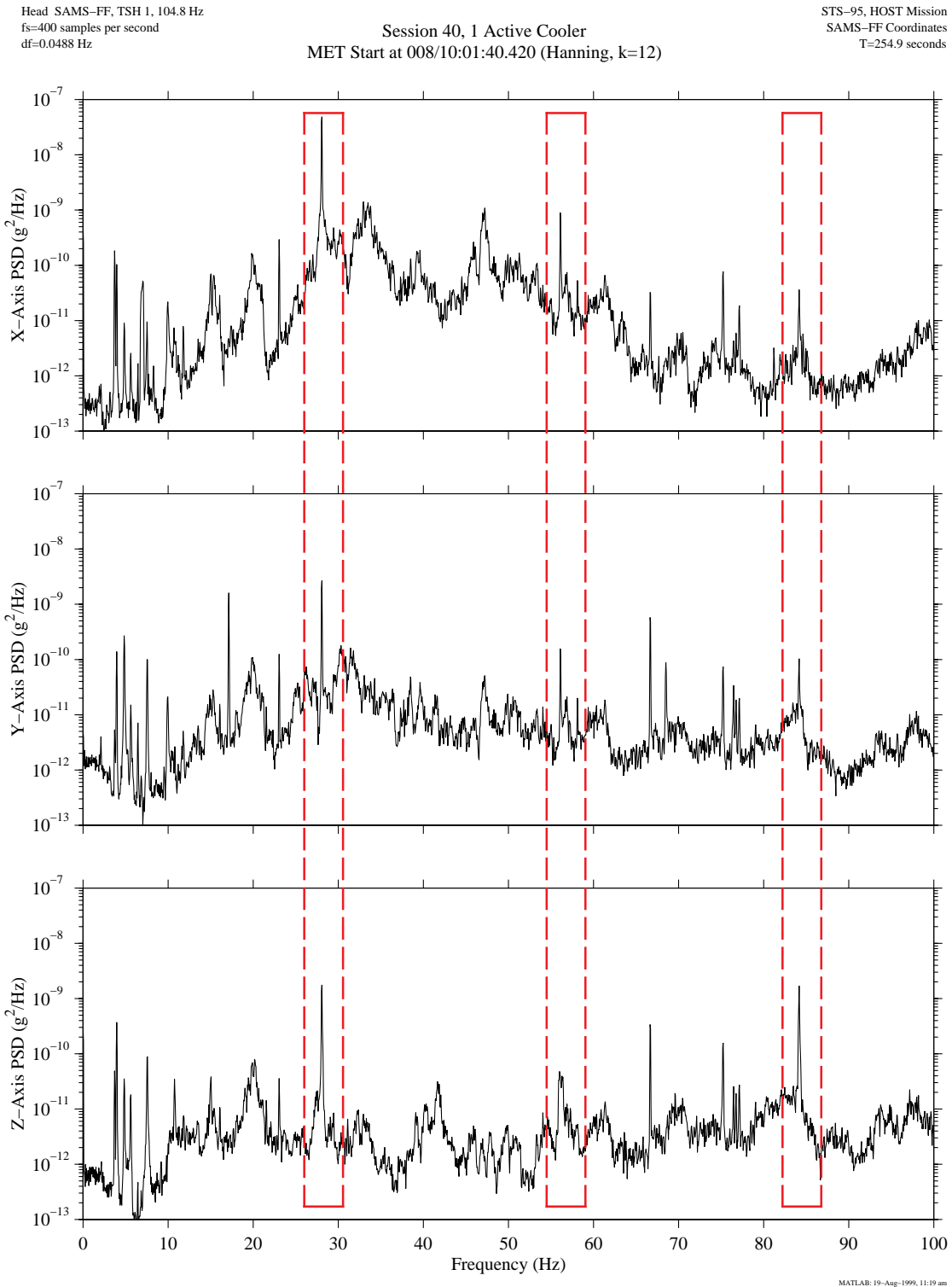

Figure 13. Recording Session 40 Illustrating 1 Active Cryocooler and Associated Harmonics.

**Appendix A - Power Spectral Density Plots for TSH 1 (0 - 30 Hz)**

SAMS-FF TSH 1 data collected during the STS-95 mission were used to generate the PSD plots in this appendix. These data were collected at a rate of 400 samples per second with an effective lowpass filter cutoff frequency of just over 100 Hz. While performing their g-jitter versus HST line-of-sight analysis, the HOST program expressed a particular interest in the frequency range 0 – 10 Hz. The plots are from recording sessions 3 through 43, with each plot except sessions 4 and 29 being comprised of 255 seconds worth of data. The time resolution used to compute the majority of the PSD plots was approximately 82 seconds, and the frequency resolution was 0.0122 Hz. Due to impulsive events in the time domain data, sessions 4 and 29 were limited to smaller overall time intervals resulting in a frequency resolution of 0.0488 Hz for these two recording sessions. To produce the PSD plots, a Hanning window was used for successive time intervals and the resultant PSDs were averaged together to create the plots. The parameter k indicates the number of PSDs averaged together to produce the plots. Because axial relationships were particularly important to the HOST project, the PSDs were calculated for all three axes.

These PSDs are intended to provide a snapshot of the frequency domain environment for each recording session. Those interested in further details are encouraged to contact the PIMS team.

**Appendix B - Power Spectral Density Plots for TSH 1 (0 - 150 Hz)**

SAMS-FF TSH 1 data collected during the STS-95 mission were used to generate the PSD plots in this appendix. These data were collected at a rate of 400 samples per second with an effective lowpass filter cutoff frequency of just over 100 Hz. The data in these PSDs are plotted out to a maximum frequency of 150 Hz. The plots are from recording sessions 3 through 43, with each plot except session 4 being comprised of 255 seconds worth of data. The time resolution used to compute the majority of the PSD plots was approximately 82 seconds, and the frequency resolution was 0.0122 Hz. Due to impulsive events in the time domain data, session 4 was limited to smaller overall time intervals resulting in a frequency resolution of 0.0488 Hz for this recording session. To produce the PSD plots, a Hanning window was used for successive time intervals and the resultant PSDs were averaged together to create the plots. The parameter  $k$  indicates the number of PSDs averaged together to produce the plots. Because axial relationships were particularly important to the HOST project, the PSDs were calculated for all three axes.

These PSDs are intended to provide a snapshot of the frequency domain environment for each recording session. Those interested in further details are encouraged to contact the PIMS team.



**Appendix C - Power Spectral Density Plots for TSH 2 (0 – 30 Hz)**

SAMS-FF TSH 2 data collected during the STS-95 mission were used to generate the PSD plots in this appendix. These data were collected at a rate of 400 samples per second with an effective lowpass filter cutoff frequency of just over 100 Hz. While performing their g-jitter versus HST line-of-sight analysis, the HOST program expressed a particular interest in the frequency range 0 – 10 Hz. The plots are from recording sessions 3 through 43, with each plot except session 29 being comprised of 255 seconds worth of data. The time resolution used to compute the majority of the PSD plots was approximately 82 seconds, and the frequency resolution was 0.0122 Hz. Due to impulsive events in the time domain data, session 29 was limited to smaller overall time intervals resulting in a frequency resolution of 0.0488 Hz for this recording session. To produce the PSD plots, a Hanning window was used for successive time intervals and the resultant PSDs were averaged together to create the plots. The parameter k indicates the number of PSDs averaged together to produce the plots. Because axial relationships were particularly important to the HOST project, the PSDs were calculated for all three axes.

These PSDs are intended to provide a snapshot of the frequency domain environment for each recording session. Those interested in further details are encouraged to contact the PIMS team.

**Appendix D - Power Spectral Density Plots for TSH 2 (0 – 150 Hz)**

SAMS-FF TSH 2 data collected during the STS-95 mission were used to generate the PSD plots in this appendix. These data were collected at a rate of 400 samples per second with an effective lowpass filter cutoff frequency of just over 100 Hz. The data in these PSDs are plotted out to a maximum frequency of 150 Hz. The plots are from recording sessions 3 through 43, with each plot comprised of 255 seconds worth of data. The time resolution used to compute the PSD plots was approximately 82 seconds, and the frequency resolution was 0.0122 Hz. To produce the PSD plots, a Hanning window was used for successive time intervals and the resultant PSDs were averaged together to create the plots. The parameter  $k$  indicates the number of PSDs averaged together to produce the plots. Because axial relationships were particularly important to the HOST project, the PSDs were calculated for all three axes.

These PSDs are intended to provide a snapshot of the frequency domain environment for each recording session. Those interested in further details are encouraged to contact the PIMS team.

## **Appendix E - Interval Min/Max Plots for TSH 1**

SAMS-FF TSH 1 data collected during the STS-95 mission were used to generate the interval average minimum/maximum plots in this appendix [2]. These data were collected at a rate of 400 samples per second. The plots are from recording sessions 3 through 43, with each plot comprised of 255 seconds worth of data. The time interval used for generating these plots was 0.25 seconds. Because axial relationships were particularly important to the HOST project, the internal min/max plots were calculated for all three axes.

These interval minimum/maximum plots are intended to provide a snapshot of the time domain environment for each recording session. Those interested in further details are encouraged to contact the PIMS team.

**Appendix F - Interval Minimum/Maximum Plots for TSH 2**

SAMS-FF TSH 2 data collected during the STS-95 mission were used to generate the interval average minimum/maximum plots in this appendix [2]. These data were collected at a rate of 400 samples per second. The plots are from recording sessions 3 through 43, with each plot comprised of 255 seconds worth of data. The time interval used for generating these plots was 0.25 seconds. Because axial relationships were particularly important to the HOST project, the internal min/max plots were calculated for all three axes.

These interval minimum/maximum plots are intended to provide a snapshot of the time domain environment for each recording session. Those interested in further details are encouraged to contact the PIMS team.

## Appendix G - Accessing Acceleration Data Via the Internet

SAMS-FF data collected on Discovery during the STS-95 mission are available over the Internet from a NASA Glenn Research Center file server with hostname `beech.grc.nasa.gov`. Acceleration data and related files are arranged in a tree structure. The figure shown below illustrates this structure. The acceleration data files (located at the end of the tree structure) are named for the recording session and the TSH number. For example, a file named “Data0011accel0f1.cvt” in the directory “/pub/SAMS-FF/STS-95” would contain TSH 1 data for all three axes for recording session 11. The beech file server can be accessed via anonymous file transfer protocol (ftp), as follows:

1. Open a connection to the file server (hostname: `beech.grc.nasa.gov`)
2. Login with username: anonymous
3. Enter your complete e-mail address as the password
4. Navigate to the directory containing the desired files  
(like the path shown here: `/pub/SAMS-FF/STS-95`)
5. Enable ASCII file transfer
6. Transfer the desired files
7. Close the connection

If you encounter difficulty in accessing the data using the file server, send an electronic mail message to `pims@grc.nasa.gov`. Please describe the nature of the difficulty and give a description of the hardware and software you are using to access the file server, including the domain name and/or IP address from which you are connecting.

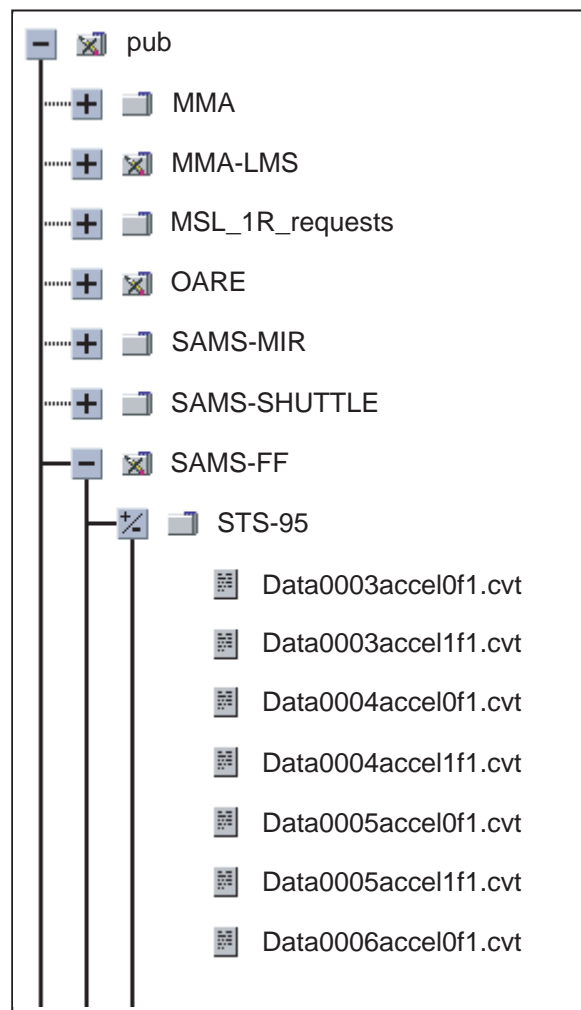

**Appendix H - Reader Feedback**

The PIMS team aims to provide information such as that contained in this report to the microgravity community in a form that is most helpful. To help us with this goal, we ask that you please answer the following questions and respond with any other feedback you may have:

1. Does this report fulfill your requirements for acceleration-related mission information?  
\_\_\_\_\_ Yes \_\_\_\_\_ No If no, then please explain?

---

---

---

2. Is there information in this report that you feel was not necessary or useful?  
\_\_\_\_\_ No \_\_\_\_\_ Yes If yes, then what should have been excluded and why?

---

---

---

3. Are there any specific analyses or data access needs you have regarding the acceleration data that have not been addressed?  
\_\_\_\_\_ No \_\_\_\_\_ Yes If yes, then please provide the details and PIMS will respond.

---

---

---

Name: \_\_\_\_\_ Telephone: \_\_\_\_\_  
Address: \_\_\_\_\_ Fax: \_\_\_\_\_  
\_\_\_\_\_ E-mail: \_\_\_\_\_

Please return this sheet to:

or, submit by:

PIMS Project Manager  
NASA Glenn Research Center  
21000 Brookpark Road  
Cleveland, OH 44135

Fax to PIMS Project: 216-433-8660  
E-mail to: [pims@grc.nasa.gov](mailto:pims@grc.nasa.gov)  
Online form at URL shown below.

<http://www.grc.nasa.gov/WWW/MMAP/PIMS/HTMLS/MSRs/STS-95/response.html>

# REPORT DOCUMENTATION PAGE

Form Approved  
OMB No. 0704-0188

Public reporting burden for this collection of information is estimated to average 1 hour per response, including the time for reviewing instructions, searching existing data sources, gathering and maintaining the data needed, and completing and reviewing the collection of information. Send comments regarding this burden estimate or any other aspect of this collection of information, including suggestions for reducing this burden, to Washington Headquarters Services, Directorate for Information Operations and Reports, 1215 Jefferson Davis Highway, Suite 1204, Arlington, VA 22202-4302, and to the Office of Management and Budget, Paperwork Reduction Project (0704-0188), Washington, DC 20503.

<b>1. AGENCY USE ONLY</b> (Leave blank)		<b>2. REPORT DATE</b> February 2000	<b>3. REPORT TYPE AND DATES COVERED</b> Technical Memorandum	
<b>4. TITLE AND SUBTITLE</b>  Summary Report of Mission Acceleration Measurements for STS-95			<b>5. FUNDING NUMBERS</b>  WU-101-46-0A-00	
<b>6. AUTHOR(S)</b>  Kevin McPherson and Kenneth Hrovat				
<b>7. PERFORMING ORGANIZATION NAME(S) AND ADDRESS(ES)</b>  National Aeronautics and Space Administration John H. Glenn Research Center at Lewis Field Cleveland, Ohio 44135-3191			<b>8. PERFORMING ORGANIZATION REPORT NUMBER</b>  E-12109	
<b>9. SPONSORING/MONITORING AGENCY NAME(S) AND ADDRESS(ES)</b>  National Aeronautics and Space Administration Washington, DC 20546-0001			<b>10. SPONSORING/MONITORING AGENCY REPORT NUMBER</b>  NASA TM-2000-209677	
<b>11. SUPPLEMENTARY NOTES</b>  Kevin McPherson, NASA Glenn Research Center; Kenneth Hrovat, Tal-Cut Company, 24831 Lorain Road, Suite 203, North Olmsted, Ohio 44070 (work funded under NAS3-27254). Responsible person, Kevin McPherson, organization code 6727, (216) 433-6182.				
<b>12a. DISTRIBUTION/AVAILABILITY STATEMENT</b>  Unclassified - Unlimited Subject Categories: 18, 20, and 35  This publication is available from the NASA Center for AeroSpace Information, (301) 621-0390.			<b>12b. DISTRIBUTION CODE</b>  Distribution: Nonstandard	
<b>13. ABSTRACT (Maximum 200 words)</b> John H. Glenn's historic return to space was a primary focus of the STS-95 mission. The Hubble Space Telescope (HST) Orbital Systems Test (HOST), an STS-95 payload, was an in-flight demonstration of HST components to be installed during the next HST servicing mission. One of the components under evaluation was the cryocooler for the Near Infrared Camera and Multi-Object Spectrometer (NICMOS). Based on concerns about vibrations from the operation of the NICMOS cryocooler affecting the overall HST line-of-sight requirements, the Space Acceleration Measurement System for Free-Flyers (SAMS-FF) was employed to measure the vibratory environment of the STS-95 mission, including any effects introduced by the NICMOS cryocooler. The STS-95 mission represents the first STS mission supported by SAMS-FF. Utilizing a Control and Data Acquisition Unit (CDU) and two triaxial sensor heads (TSH) mounted on the HOST support structure in Discovery's cargo bay, the SAMS-FF and the HOST project were able to make vibratory measurements both on-board the vibration-isolated NICMOS cryocooler and off-board the cryocooler mounting plate. By comparing the SAMS-FF measured vibrations on-board and off-board the NICMOS cryocooler, HST engineers could assess the cryocooler g-jitter effects on the HST line-of-sight requirements. The acceleration records from both SAMS-FF accelerometers were analyzed and significant features of the microgravity environment are detailed in this report.				
<b>14. SUBJECT TERMS</b>  SAMS; SAMS-FF; Microgravity environment; NASA; Acceleration measurements			<b>15. NUMBER OF PAGES</b> 40	
			<b>16. PRICE CODE</b> A03	
<b>17. SECURITY CLASSIFICATION OF REPORT</b> Unclassified	<b>18. SECURITY CLASSIFICATION OF THIS PAGE</b> Unclassified	<b>19. SECURITY CLASSIFICATION OF ABSTRACT</b> Unclassified	<b>20. LIMITATION OF ABSTRACT</b>	