

57

182P

Sharon Welch
s.s.welch@larc.nasa.gov
757-864-6611
2nd Gen RLU Airframe Project Manager
NASA Langley Research Center
Hampton, VA 23681

Dr. David Bowles
d.e.bowles@larc.nasa.gov
757-864-3095
3rd Gen RLU Airframe Project Manager
NASA Langley Research Center
Hampton, VA 23681

SPACE TRANSPORTATION TECHNOLOGY WORKSHOP
MARSHALL SPACE FLIGHT CENTER
OCTOBER 11-12, 2000

Airframe/TPS

Airframe/TPS Session

- ◆ **Each session chair(s) should:**
 - Coordinate with their co-chair
 - Develop and show an agenda
 - Introduce each speaker
 - Lead with an overview of their area
 - Show your roadmap(s)
 - Show Working Groups and membership
 - Give contact info (name, phone, email)
 - Get your charts plus your presenters charts to Bruce Shelton
(bruce.shelton@msfc.nasa.gov or 256-544-5231) by COB Sept 12

- ◆ **Each speaker should address (as appropriate):**
 - Technology goals and objectives
 - Background
 - Current status
 - Major accomplishments
 - Near term plans (including upcoming milestones)
 - Give contact info (name, phone, email)

- ◆ **Use this as a template**

- ◆ 12:45 - 1:00 Introduction 2nd Gen RLV Airframe S. Welch
- ◆ 1:00 - 1:20 Airframe Design and Integration S. Scotti
- ◆ 1:20 - 1:40 Aerothermodynamics C. Miller
- ◆ 1:40 - 2:00 Structures and Materials T. Johnson
- ◆ 2:00 - 2:20 Tanks D. Smith
- ◆ 2:20 - 2:40 Thermal Protection Systems M. Rezin
- ◆ 2:40 - 3:00 Integrated Airframe Demonstrations D. Glass

- ◆ 3:00 - 3:05 BREAK

- ◆ 3:05 - 3:30 Introduction 3rd Gen RLV Airframe D. Bowles
- ◆ 3:30 - 3:55 Integrated Design and Analysis T. Gates
- ◆ 3:55 - 4:20 Integrated Thermal Str. & Materials B. Jensen
- ◆ 4:20 - 4:45 Thermal Protection Systems S. Johnson

- ◆ Identification of Airframe Issues and Critical Technology
- ◆ Development Requirements- STAS Reports/Internal NASA Assessments
- ◆ 2nd Gen RLV Airframe Requirements Flowdown
- ◆ Element Managers
- ◆ Project Steering Council
- ◆ 2nd Gen RLV Airframe Roadmap
- ◆ Review of Elements - Recent Accomplishments
 - Airframe Design and Integration
 - Aero/Aerothermodynamics
 - Structures and Materials
 - Tanks
 - TPS
 - Integrated Airframe/Cryotank Demonstrations

Airframe/TPS

Introduction 2nd Gen RLV Airframe

- ◆ Range of concepts considered include - SSTO, TSTO, HTHL, VTHL, CTV
- ◆ Airframe Technical Issues
 - Performance and Weight Margins Too Low
 - Reliability/Reusability - safety goal appears achievable, but vehicle reliability not well understood; need for crew escape identified, but airframe requirements not defined
 - Aero Controls - Separation dynamics, stability and control
 - Propulsion/Airframe Integration
 - Operations

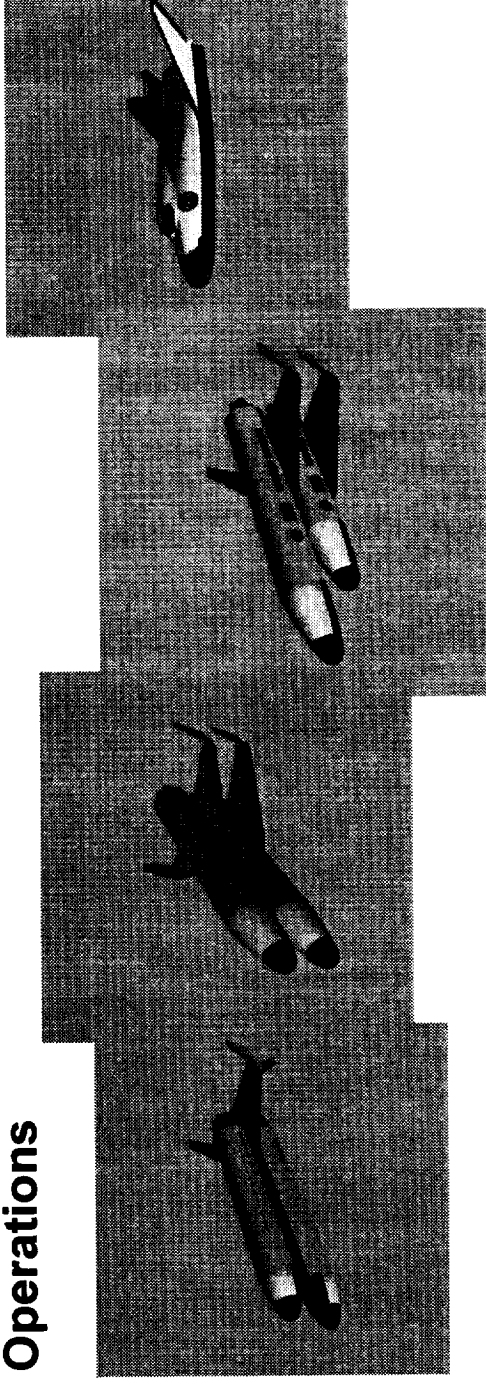

Airframe/TPS

STAS/Internal NASA Assessments

Based on Historical data for New Space Transportation Systems

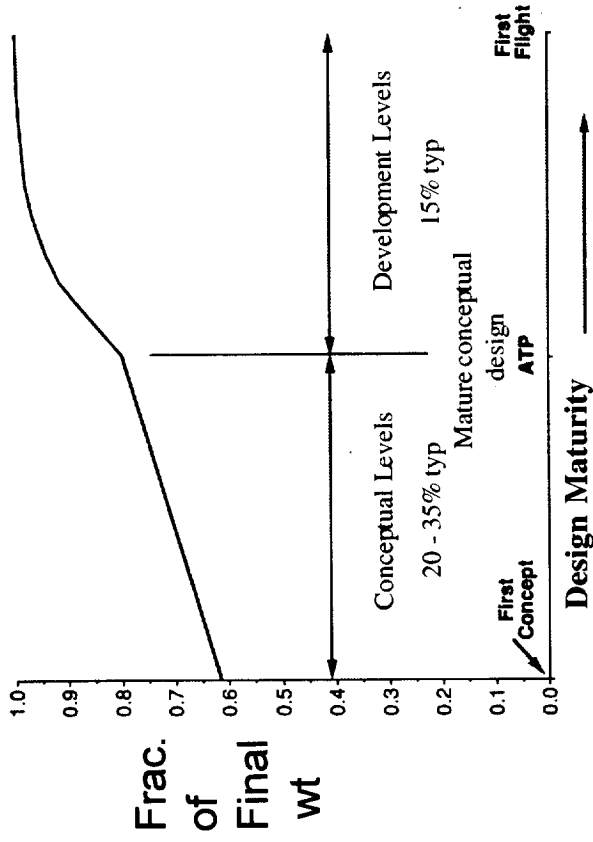

1995 Independent Assessment of X-33 Technology Development Program

"...the committee is concerned about the 15 percent maximum weight-growth margin specified by the program managers; 20 to 25 percent weight-growth margin is typical during the early stage of design development. The need to control weight growth tightly this early in the program places a premium on accurate calculation of structural performance and weight and on early verification that the structure can be built at or below the predicted weight."

-- from National Academy of Sciences
Committee on Reusable Launch Vehicle
Technology and Test Program - 1995

Airframe/TPS

Weight Growth and Weight Margin

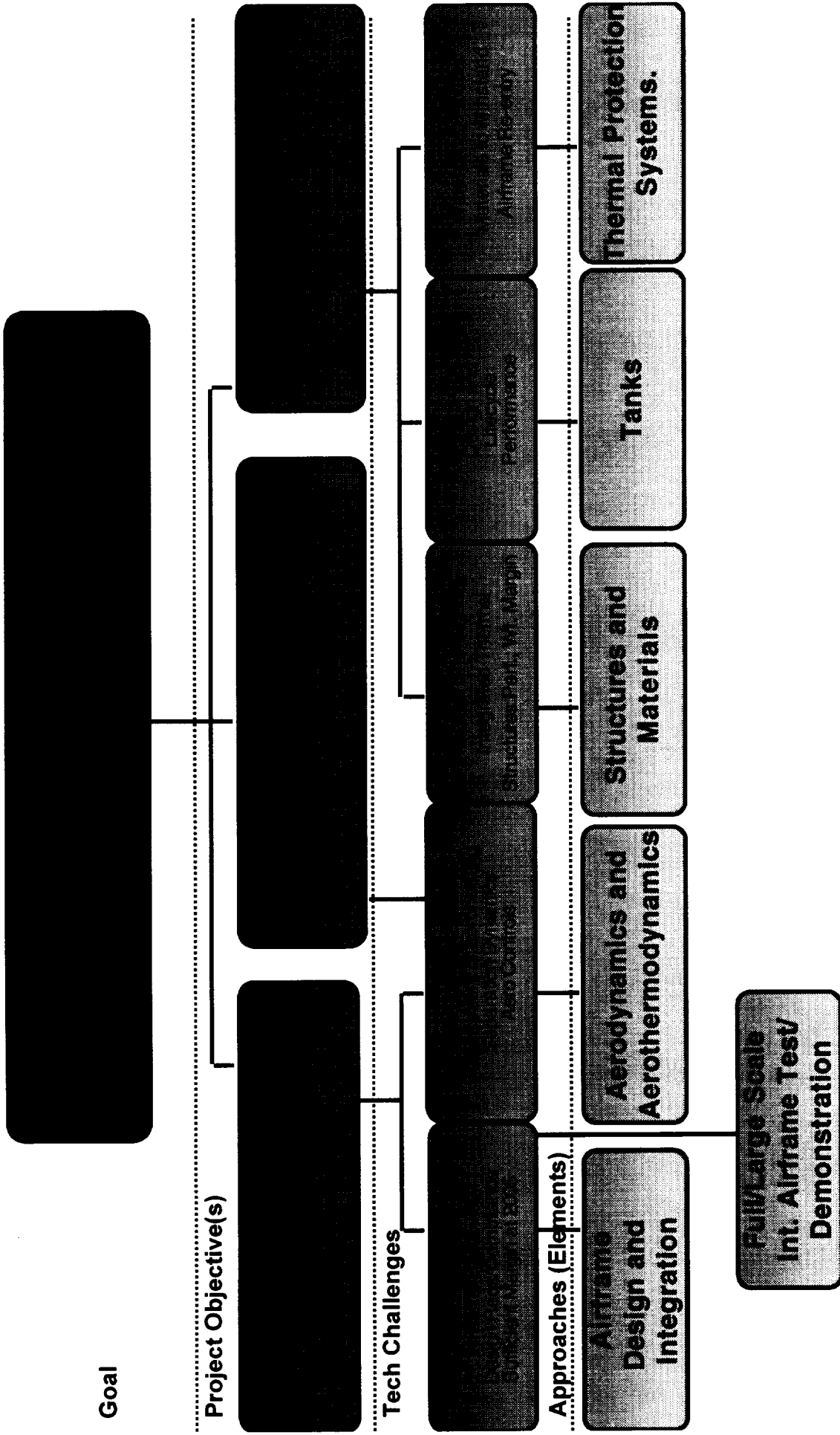

Airframe/TPS

Airframe Requirements Flowdown

Project Management

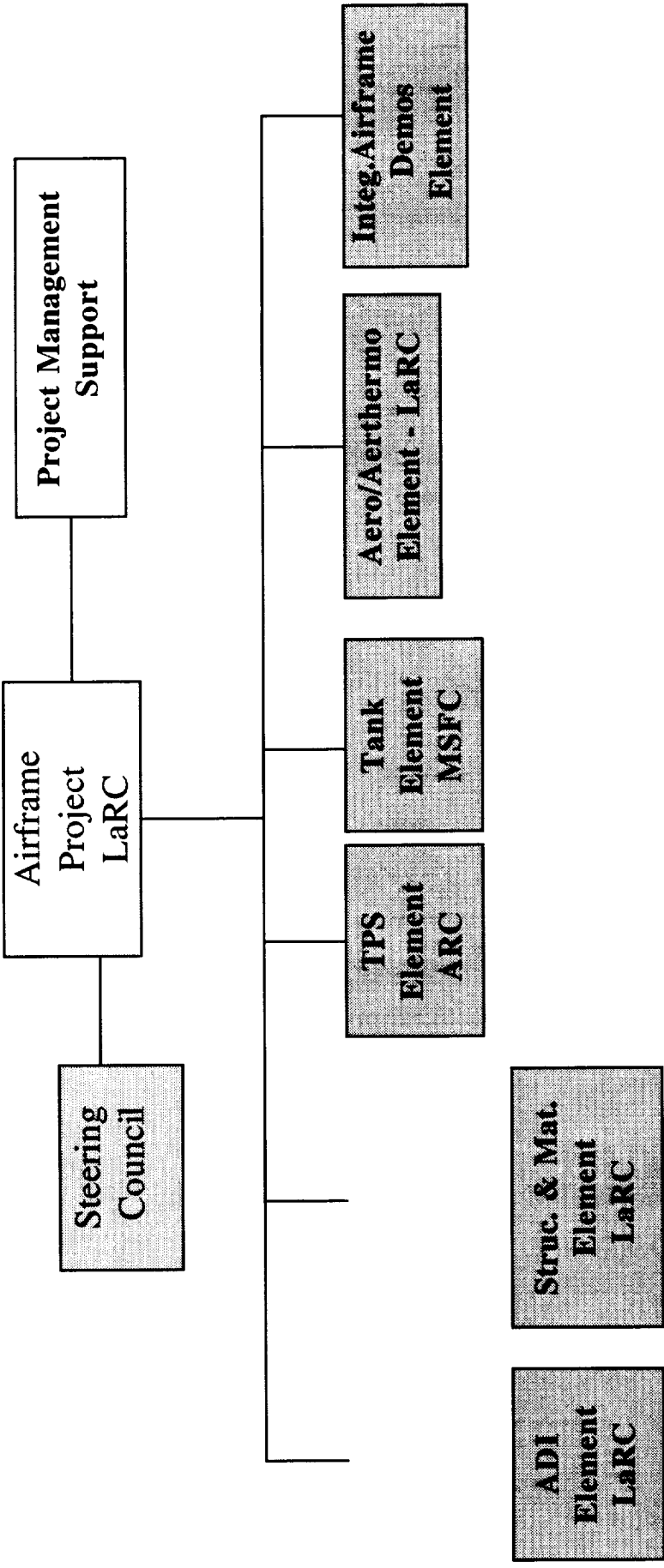

Airframe/TPS 2nd Gen Airframe Project

Airframe Design and Integration

Dr. Kim S. Bey

Phone: (757) 864-1351

k.s.bey@larc.naa.gov

Tanks

Drew Smith

Phone: (256) 544-4932

drew.smith@msfc.nasa.gov

Aero/Aerothermodynamics

Charles G. Miller

Phone: (757) 864-5020

c.g.miller@larc.nasa.gov

TPS

Dr. Marc Rezin

Phone: (650) 604-6395

mrezin@mail.arc.nasa.gov

Structures and Materials

Dr. James H. Starnes

Phone: (757) 864-3168

j.h.starnes@larc.nasa.gov

Airframe/TPS

Element Managers

Airframe Project - Sharon Welch

Element Working Groups

Airframe Design and Integration
Aero/Aerothermodynamics
Structures and Materials
Tanks
Thermal Protection Systems

Element Managers

Kim Bey
Charles Miller
Jim Starnes
Drew Smith
Marc Rezin

Affiliation

NASA
NASA
NASA
NASA
NASA

Full/Large Scale Int. Airframe/ Cryotank Demos

Industry/Element Working Groups

Industry/NASA/DoD

NASA Facilities Development

Jerry Housner
James Wycoff
John Balboni

2nd Gen RLV

Systems Engineering
Facilities Req. Team

NASA/DoD Req. Convergence

Michael Stropki
Mike Lovern

AFRL
BMDO

Structures IVHM

Bob Rogowski

NASA

Airframe/TPS

Airframe Project Steering Council

Airframe/TPS Roadmap

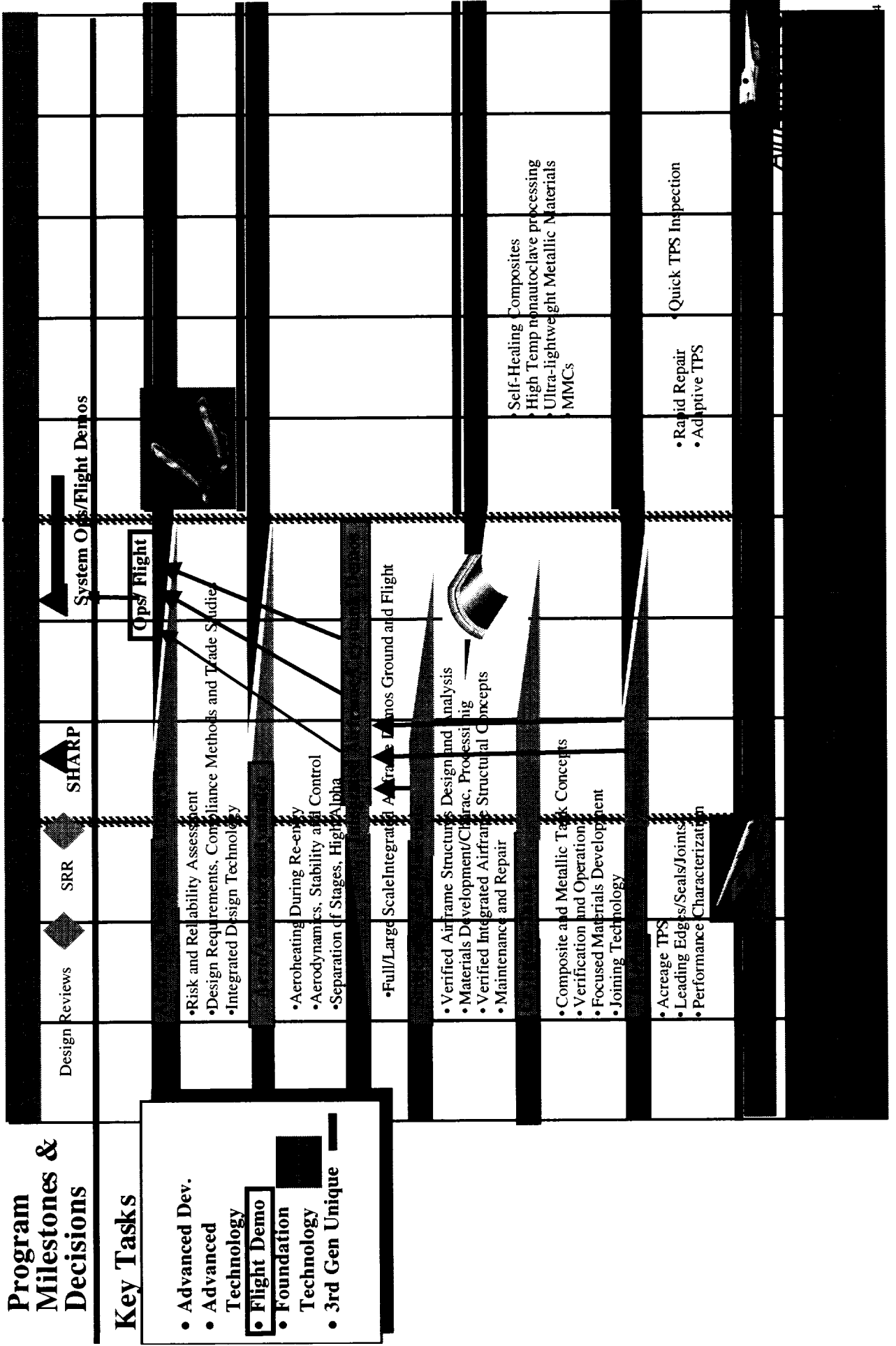

Stephen Scotti
s.j.scotti@larc.nasa.gov
757-864-5431

METALS AND THERMAL STRUCTURES BRANCH
NASA LANGLEY RESEARCH CENTER
HAMPTON, VA 23681

SPACE TRANSPORTATION TECHNOLOGY WORKSHOP
MARSHALL SPACE FLIGHT CENTER
OCTOBER 11-12, 2000

Airframe/TPS

AIRFRAME DESIGN AND INTEGRATION

- ◆ **Integrated Design Tools and Methods**
- ◆ **Integrated Airframe Trade Studies**
NRA 8-21 Overview
- ◆ **Risk and Reliability Assessment**
LaRC Points of Contact:

Jeff Stroud
Analytical and Computational Methods Branch, Structures and Materials
w.j.stroud@larc.nasa.gov
757-864-2928

Tom Zang
Multi-Disciplinary Design and Optimization Branch
t.a.zang@larc.nasa.gov
757-864-2307

Airframe/TPS

AIRFRAME DESIGN AND INTEGRATION: Major Areas

- ◆ Decompose operational, safety, and cost requirements into a comprehensive and consistent set of design criteria for different structural and material concepts for Reusable Launch Vehicles (RLVs)
- ◆ Develop compliance methods to ensure that different structural and material concepts are assessed at a consistent and adequate level of fidelity and safety
- ◆ Develop and assess weight reduction potential of integrated airframe concepts for RLVs, e.g. Thermal Protection System (TPS)/ TPS Support (TPSS)/ Cryogenic Tank (CT) System
- ◆ Compare performance and weight of various airframe structural and material concepts and structural arrangements and identify technology development needs
- ◆ Develop high fidelity parametric models that include airframe structural interactions and major design drivers

AIRFRAME INTEGRATION TRADE ^{Airframe/TPS} STUDIES **GENERAL OBJECTIVES**

- ◆ **Define vehicle requirements, definition, packaging**
- ◆ **Define airframe structural design requirements and develop compliance methods**
- ◆ **Define load conditions, loads, factors of safety, and materials**
- ◆ **Define integrated concepts**
- ◆ **Develop methods, perform analysis, and sizing**
- ◆ **Calculate system weights**
- ◆ **Assess concepts**

Airframe/TPS

TRADE STUDIES: GENERAL APPROACH

RLV Requirements

- Lightweight
- Fully reusable
- Easily maintained

Vehicle Definition

- Single Stage to Orbit (SSTO)
- Lifting body

Major Components

- Aerospike engines
- Engine Thrust Structure
(integrates engines, fins, tanks, and main landing gear)

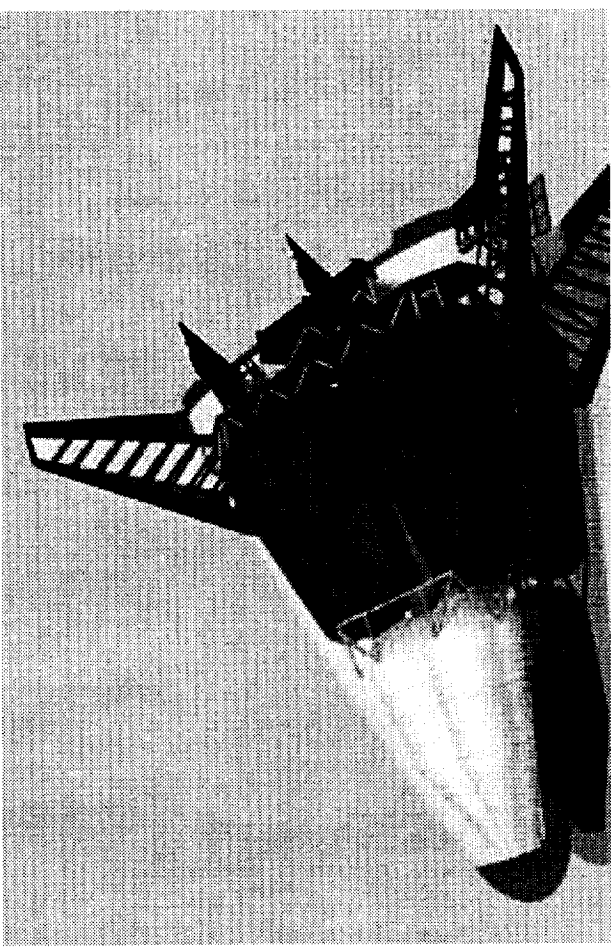

- Liquid Oxygen (LOX) Tank
- Liquid Hydrogen (LH2) Tanks
- Intertank
- Metallic Thermal Protection System and support structure

Airframe/TPS

SYSTEM DEFINITION

- ◆ **John T. Dorsey**
Airframe Integration & Concepts, Vehicle Loads,
Weights (Study Lead, NRA 8-21)
- ◆ **Max Blosser**
TPS Concepts (TPS Team Lead)
- ◆ **Carl Poteet**
TPS Thermal Analysis and Sizing, TPS Concepts
- ◆ **Roger Chen**
TPS Panel Acoustic, Fatigue, Creep Analysis & Sizing
- ◆ **Irv Schmidt**
TPS Panel and Tank Stiffening Design
- ◆ **John Wang**
Semi-Conformal & Lobed Tank Analysis and Sizing
- ◆ **Su-Yuen Hsu**
TPS Panel Structural Analysis and Sizing
- ◆ **Lynn Bowman**
Non-Optimum and Vehicle Weights
- ◆ **Jeff Cerro**
Material Properties, Vehicle Loads
- ◆ **Nani Balakrishnan**
TPS Panel Structural Analysis and Sizing
- ◆ **David Myers**
Packaging, Weights, & TPS

- ◆ **Kevin Rivers**
2nd Gen RLV Airframe Integration and Trades Lead
- ◆ **Kim Bey**
Aerothermal Loads, Thermal Analysis, TPS Sizing

Airframe/TPS

TRADE STUDY TEAM

- ◆ **Tank Packaging and Geometry**
 - **Packaging configurations**
 - **Lobed versus conformal tanks**
 - **Minimize Distance between Outer Mold Line (OML) and Tank**

- ◆ **Component Trade Studies**
 - **Tanks**
 - **TPS and support structure**

- ◆ **Integrated TPS, TPS support, and tanks**
 - **Applicable to several architectures**
 - **In progress**

Airframe/TPS

TRADE STUDIES FOR NRA 8-21: MAJOR CATEGORIES

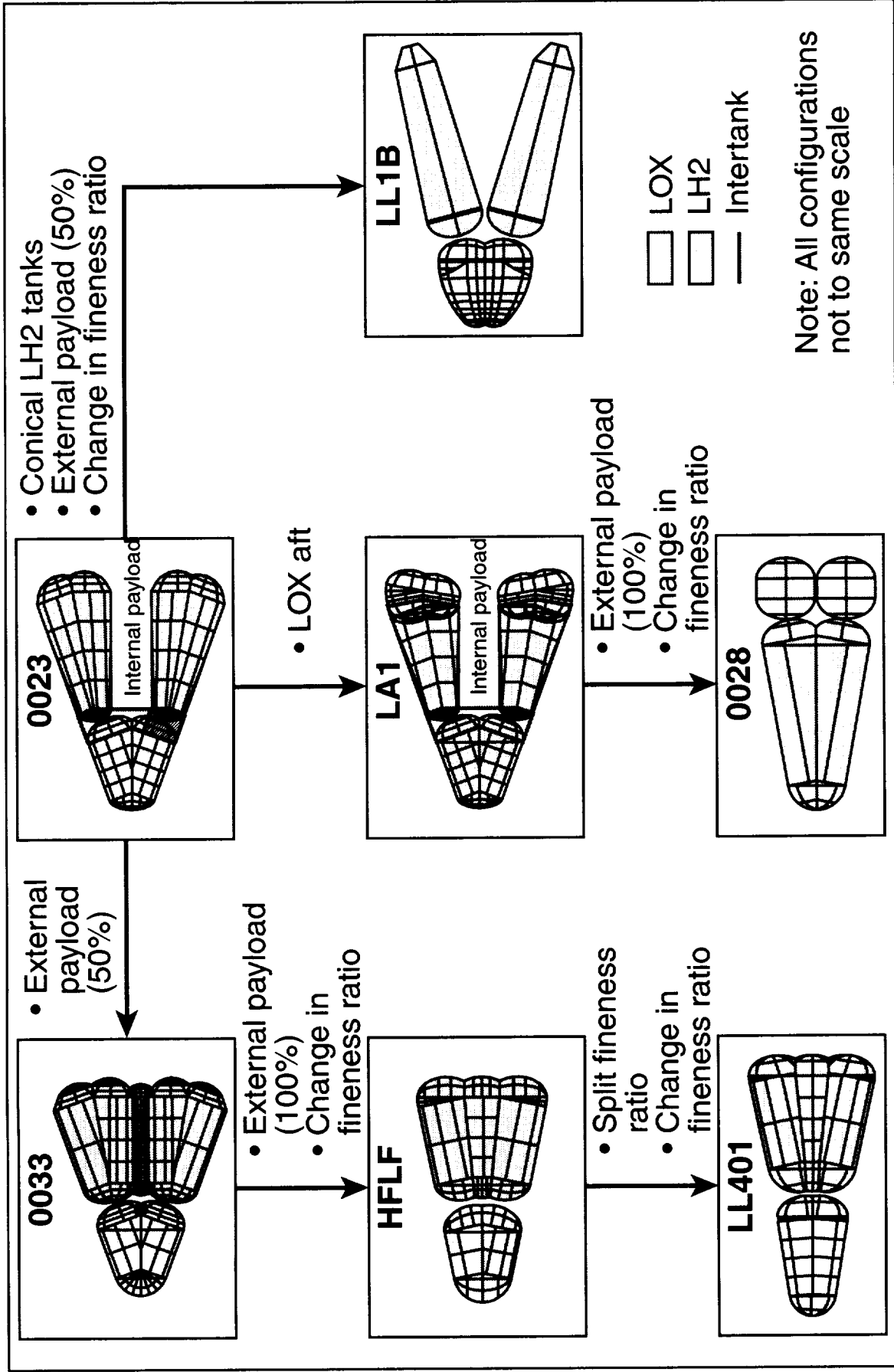

Airframe/TPS

PACKAGING CONFIGURATIONS

- **Material Specifications**

- Quasi-isotropic PMC laminates
- Limit strain 6000 $\mu\text{in./in.}$
- Minimum gage

- **Load Cases**

- Launch (1.355 g's)
- Max acceleration (3 g's)

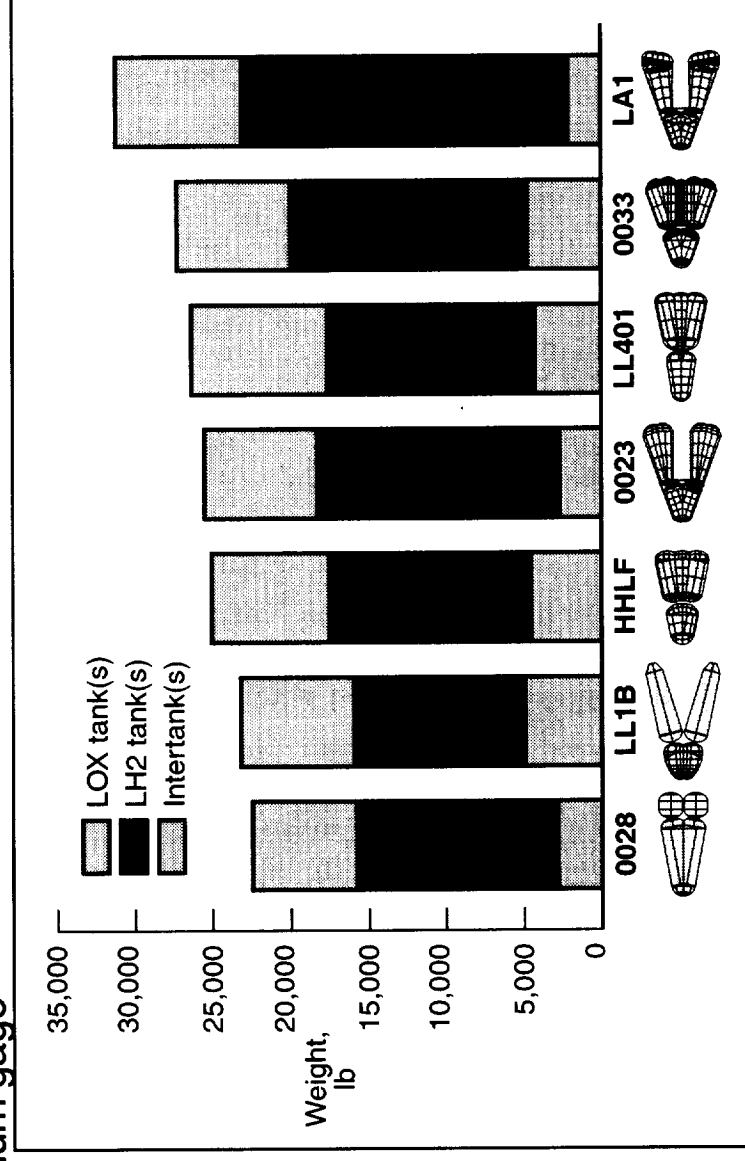

- **Interactions:**

- LOX-aft: reduced LH2 ullage pressure for tank stabilization changes engine operating requirements
- External payload and aerodynamics

Airframe/TPS

CONFIGURATION SIZING

LH2 Tank Geometry

LOX Tank Geometry

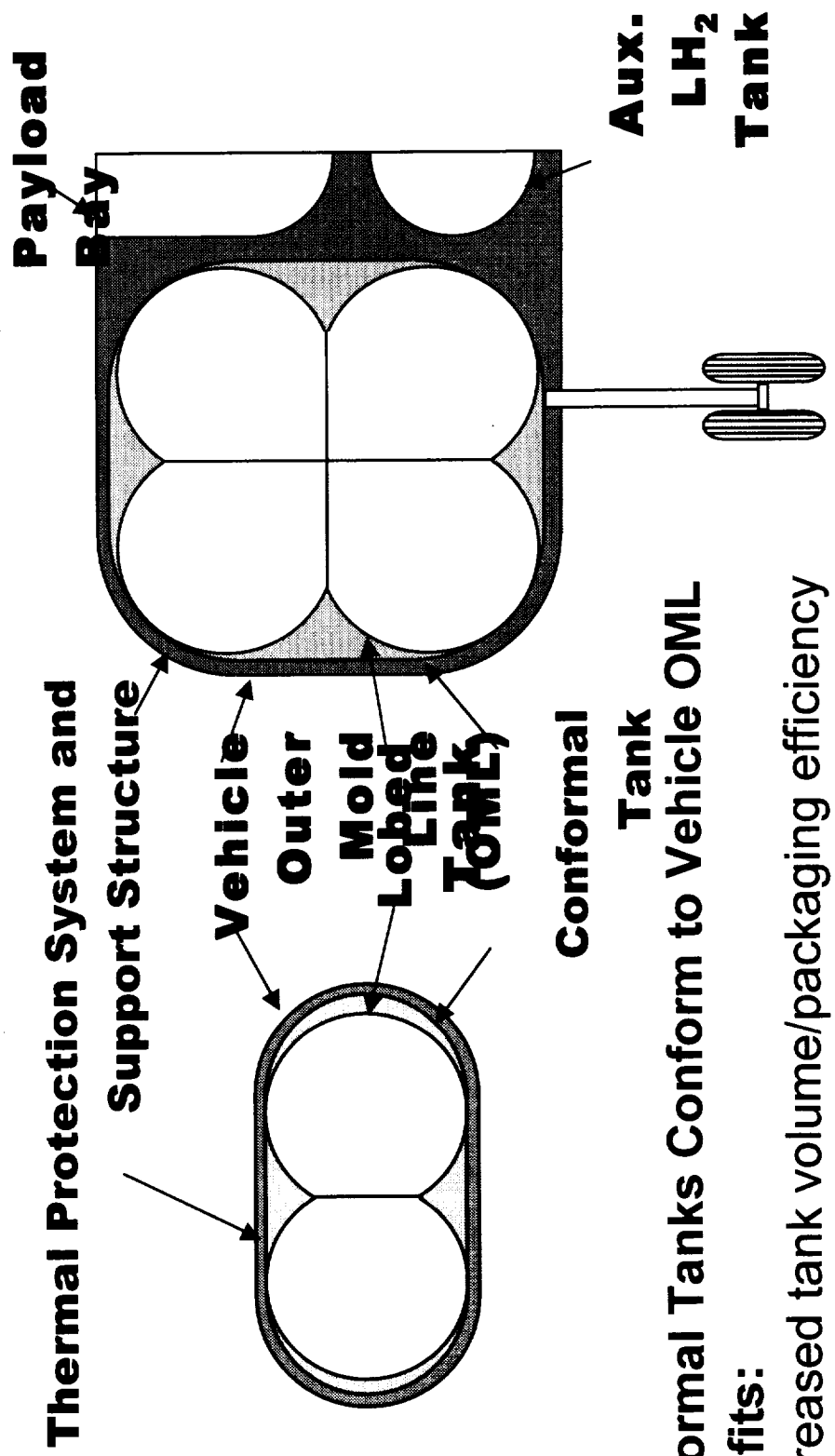

Conformal Tanks Conform to Vehicle OML

Benefits:

- ◆ Increased tank volume/packaging efficiency
- ◆ Reduced TPS support structure
- ◆ Improved thrust load paths

Airframe/TPS

TANK GEOMETRY TRADE STUDIES

Axial Tension Webs

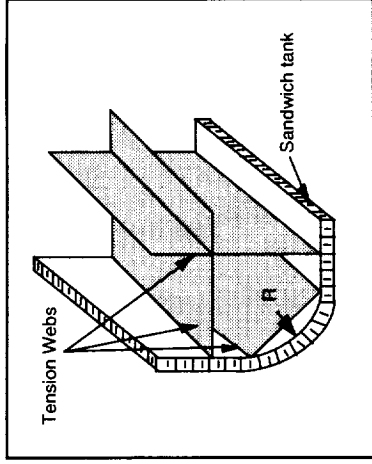

Frames & Ties

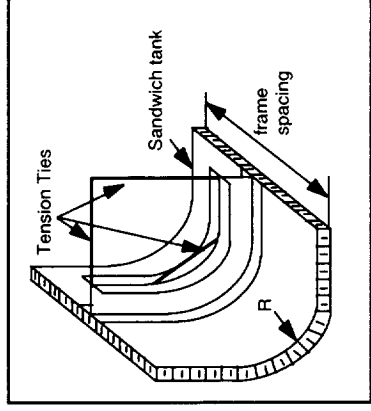

Orthogrid & Ties

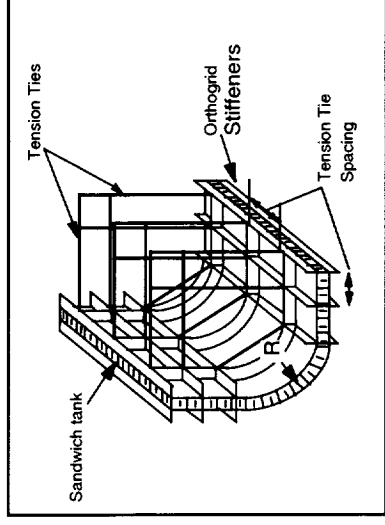

Transverse Webs

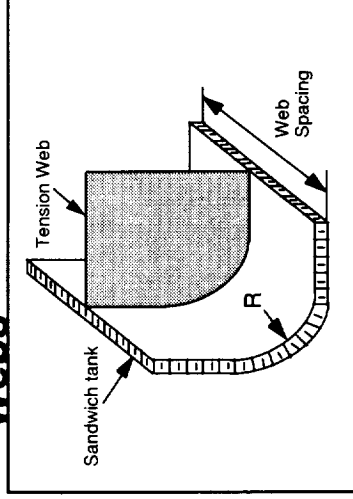

Quad-lobe & Webs

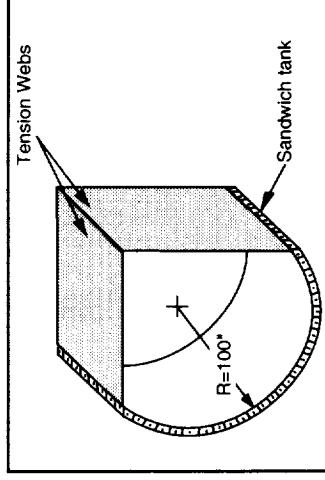

TANK STIFFENING CONCEPTS CONSIDERED

Corner radius = 0.635 m
Pressure = 137.9 KPa

No manufacturing min. gauge

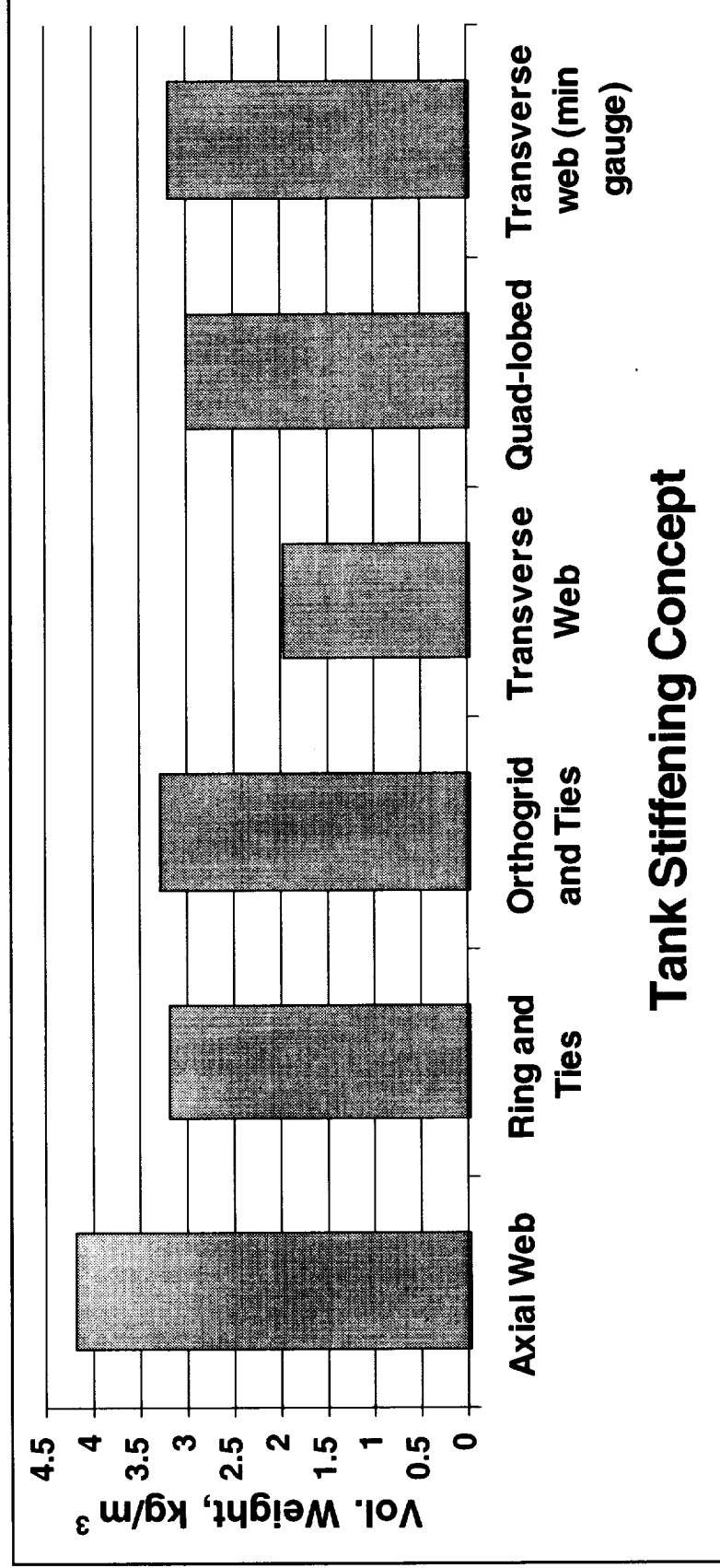

Airframe/TPS

TANK STIFFENING WEIGHTS COMPARISON

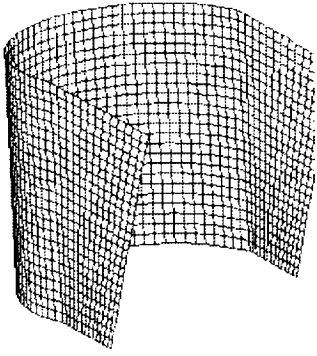

Intertank
Structure

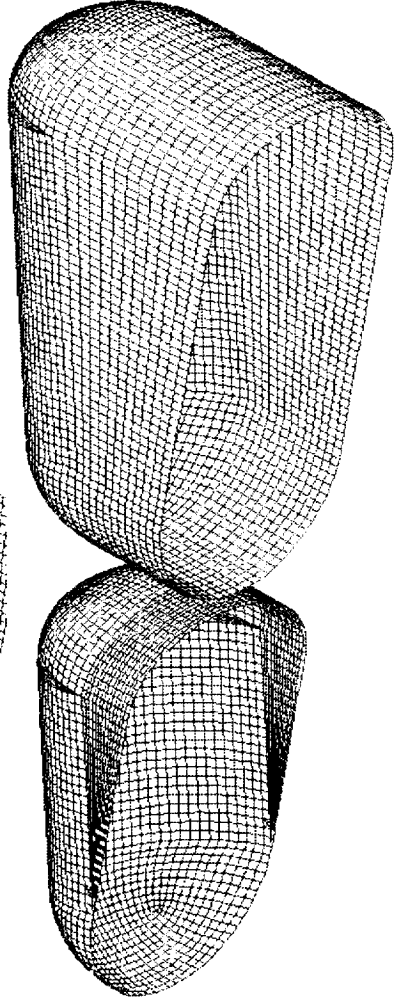

LOX Tank

LH2 Tank

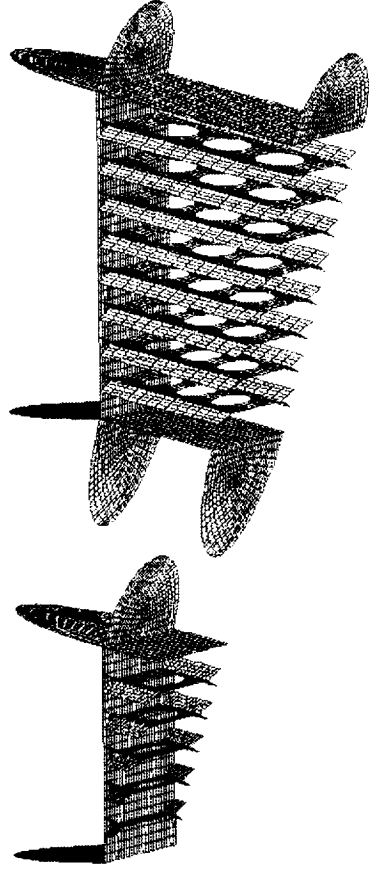

Tension Ties

Airframe/TPS

**SEMI-CONFORMAL SANDWICH TANK SYSTEM: FEM FOR SIZING
(In Progress)**

Metallic TPS Concepts for Windward Aeroshell Surfaces

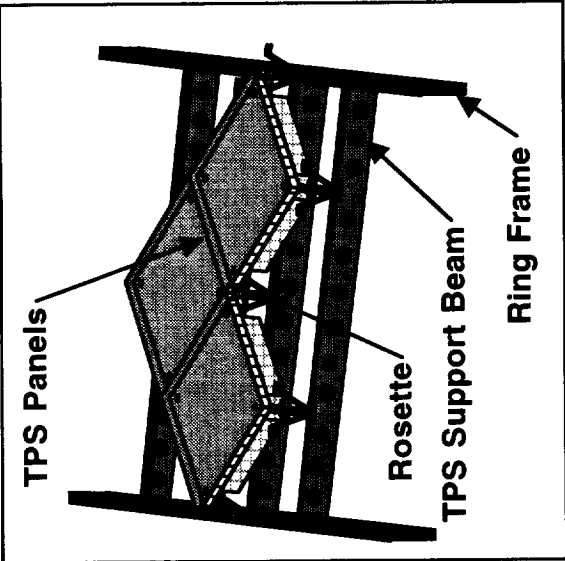
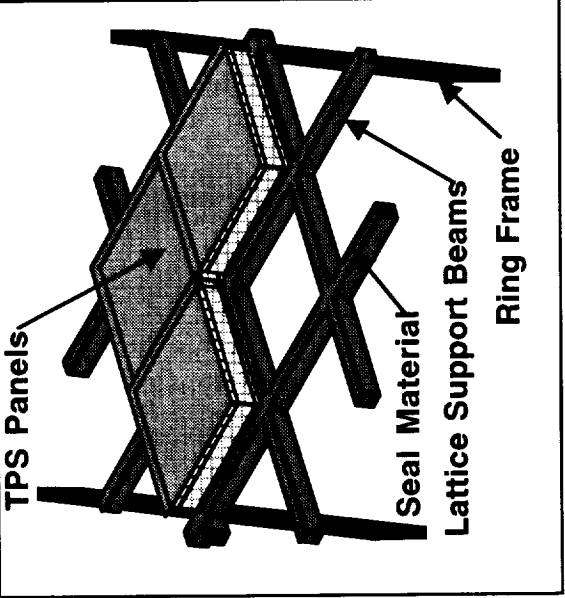
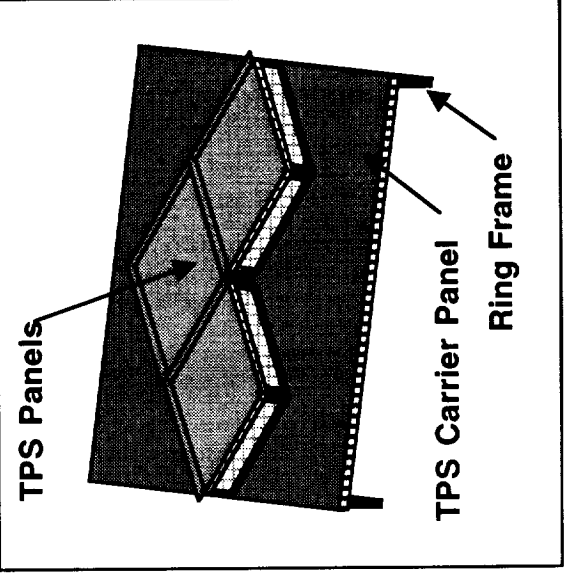
<p>Rohr X-33 Concept (baseline)</p>	<p>LaRC-Type TPS Panels with Lattice Seal & Support Frames</p>	<p>LaRC-Type TPS Panels Mounted to Carrier Plates</p>
 <p>TPS Panels Rosette TPS Support Beam Ring Frame</p> <ul style="list-style-type: none"> •Thermal stresses minimized •Light weight system •Simplified manufacturing •Seals on hot surface •Hot surfaces carry aero pressures •Panel damage/loss potentially catastrophic 	 <p>TPS Panels Seal Material Lattice Support Beams Ring Frame</p> <ul style="list-style-type: none"> •Seals and pressure bearing surface moved to cooler region •Tolerant to outer surface damage •More complex support structure •More costly TPS panel •Panel loss potentially catastrophic 	 <p>TPS Panels TPS Carrier Panel Ring Frame</p> <ul style="list-style-type: none"> •Carrier panel increases TPS options •Improved damage tolerance •Reduces number of seals •Pressure carried on large, cool panel •Heavier than other concepts •Complicates removal for inspection •Potential thermal stress issues

Airframe/TPS

TPS TRADE STUDY CONCEPTS

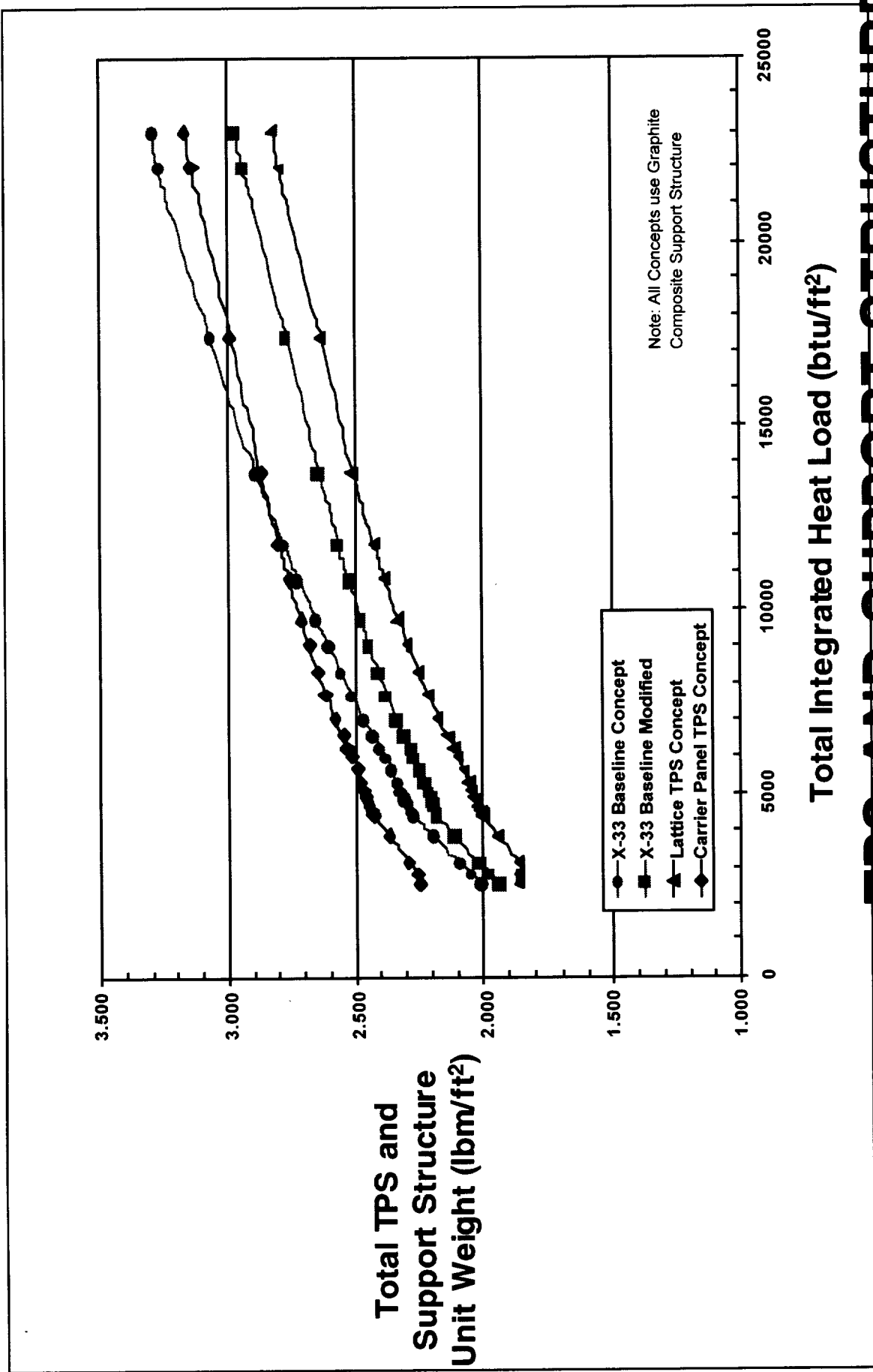

TPS AND SUPPORT STRUCTURE WEIGHTS

REPRESENTATIVE STRUCTURAL CONCEPTS

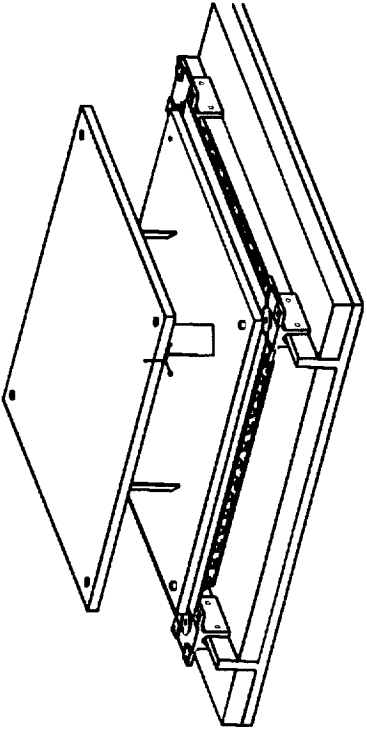

FEATURES

- Metallic TPS
- TPS Support Structure
- Purge Gap
- Cryogenic Foam
- Sandwich or Stiffened Skin Tank Wall

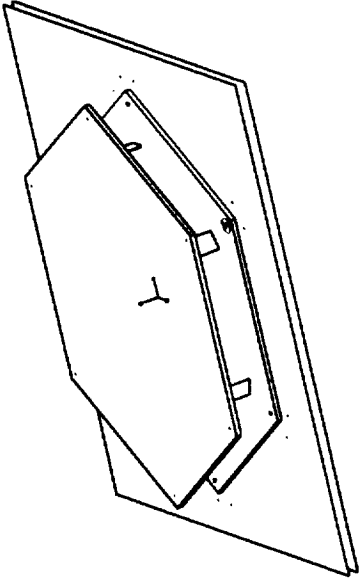
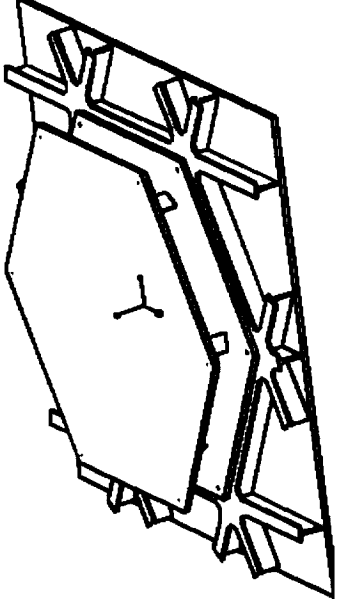

FEATURES

- Metallic TPS
- Direct Attach TPS
- Cryogenic Foam
- Sandwich, Stiffened Skin, or Integrally-Stiffened Tank Wall

Airframe/TPS

INTEGRATED TPS/TPSS/TANK SYSTEM DEFINITION

- **Hierarchy of sizing methods are needed to support trade studies and concept assessment. Even low fidelity sizing must capture effect**
- **of major design drivers (e.g. geometry, size, load, ...)**
- **Major deficiencies exist in the types of material data needed to optimize integrated airframe (TPS/TPS Support/Tank systems) for both metallic and polymeric composite systems**
- **Critical interactions exist within airframe systems, and between airframe and vehicle systems. New analytical formulations and/or tools are needed to take advantage of those interactions which significantly improve or enable vehicle/system viability.**

Airframe/TPS

CONCLUDING REMARKS

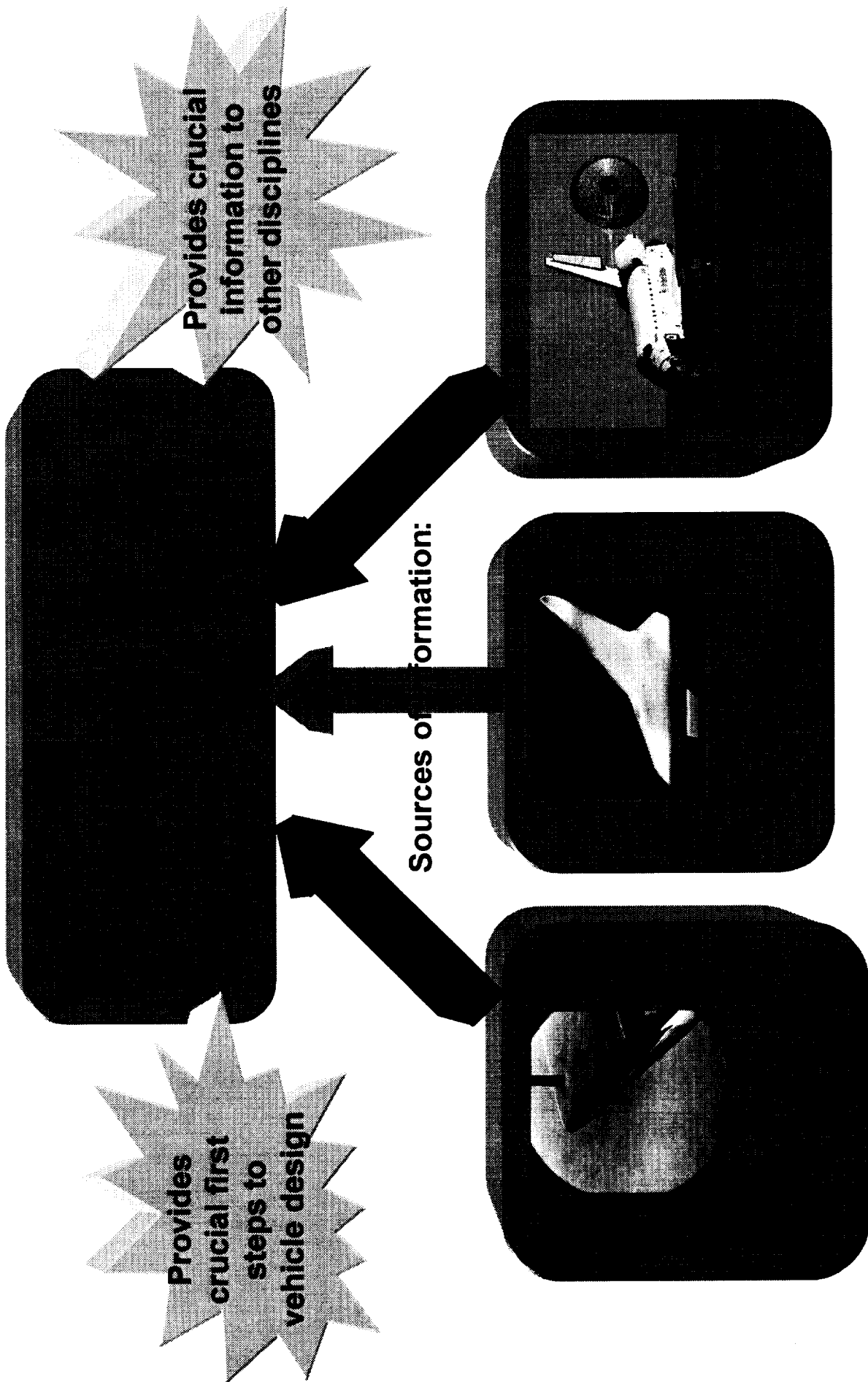

Airframe/TPS - Aerothermodynamics

Aerothermodynamics

Computational Fluid Dynamics (CFD)

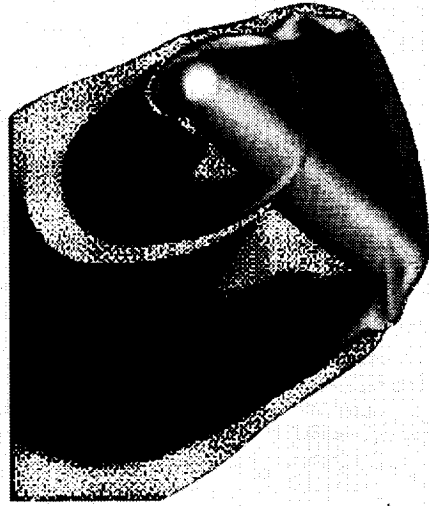

Ground-based testing

LMSW 603 B1001 at Mach 20

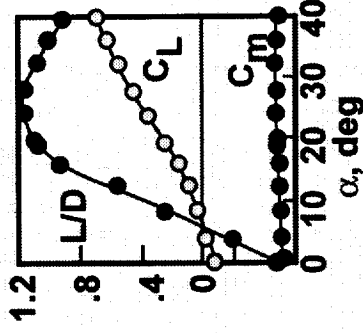

Calibrated against one another
Applied to flight (ascent/ decent)

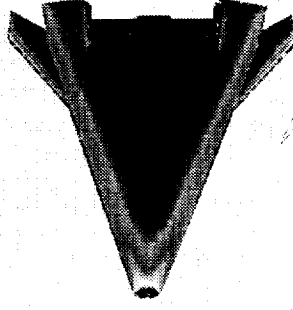

Materials

Structural Design

Thermal Protection System

Operations

Guidance, Control and Navigation

Airframe/TPS - Aerothermodynamics

Aerothermodynamics Provides Critical - Path Information

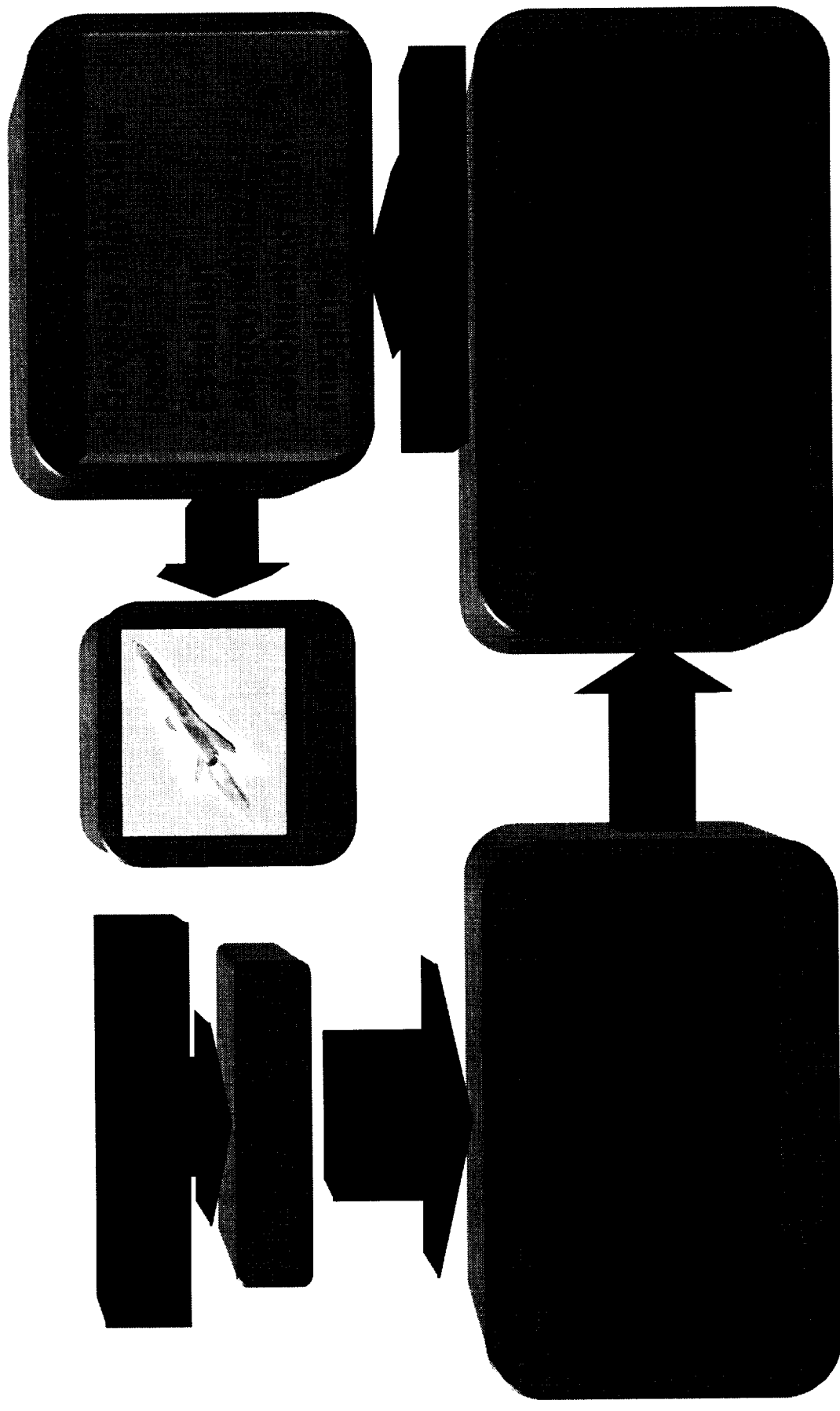

Airframe/TPS - Aerothermodynamics

Aerothermodynamic Process

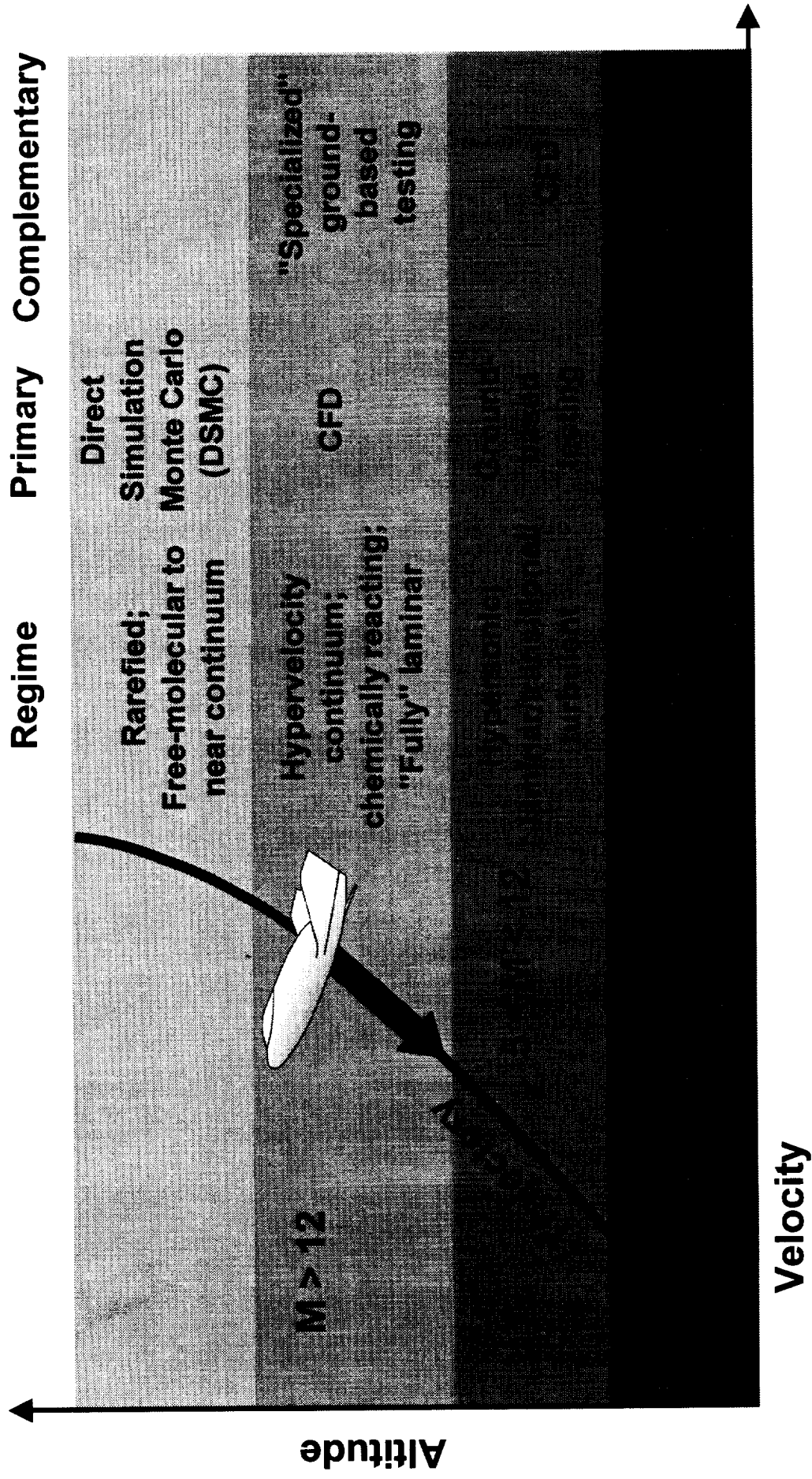

Airframe/TPS - Aerothermodynamics

Aerothermodynamic Methodology

Ames
Research Center
(thermal protection
systems)

Dryden Flight
Research Center

Johnson Space Center
(Crewed Aerospace Vehicles)

Marshall Space Flight
Center (Ascent)

Langley Aerothermodynamic Facilities Complex (AFC)

 <p>20-Inch Mach 6 Air</p>	 <p>31-Inch Mach 10 Air</p>	 <p>20-Inch Mach 13-18 Real Gas Simulation</p>
---	--	---

Airframe/TPS - Aerothermodynamics

LaRC is NASA Lead For Aerothermodynamics

Aerothermodynamic customer

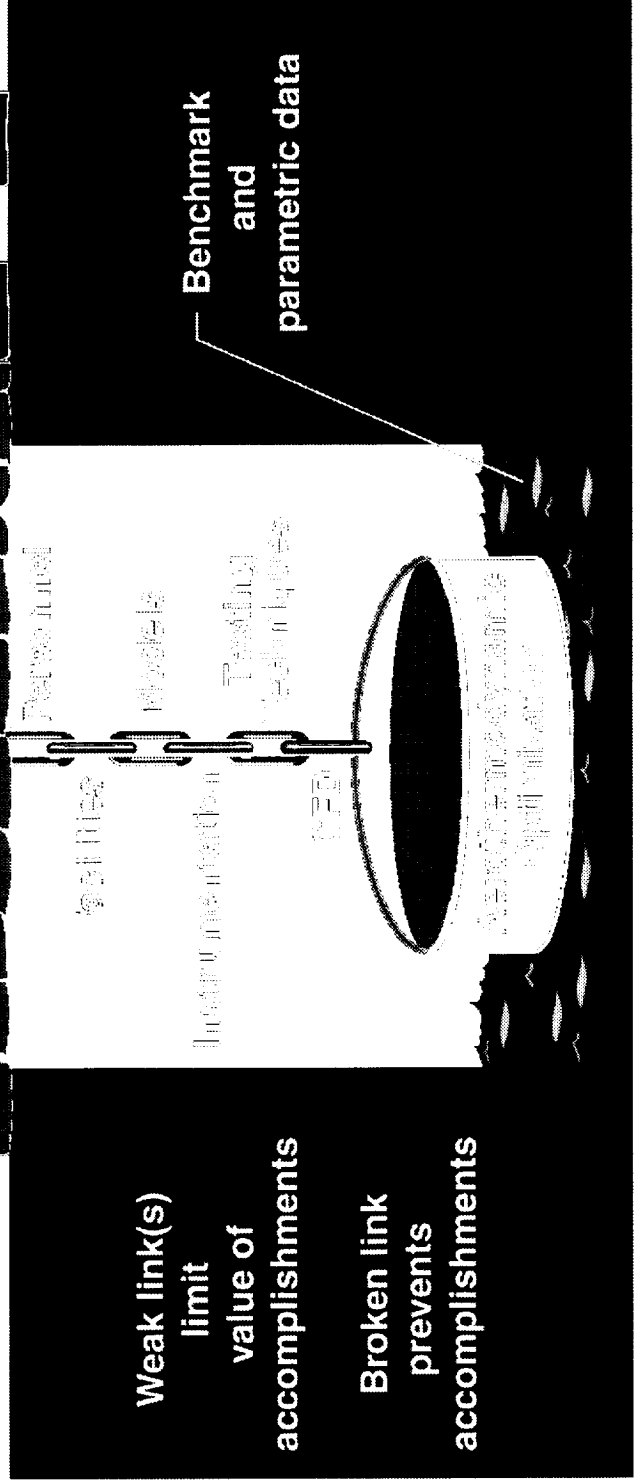
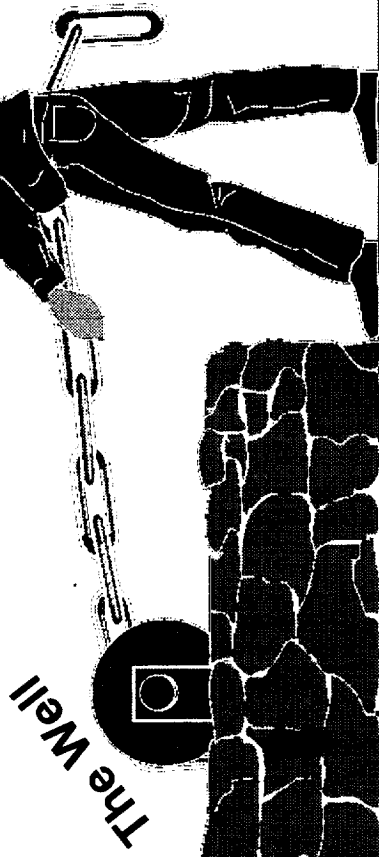

Weak link(s) limit value of accomplishments

Broken link prevents accomplishments

Airframe/TPS - Aerothermodynamics

Aerothermodynamic "Chain"

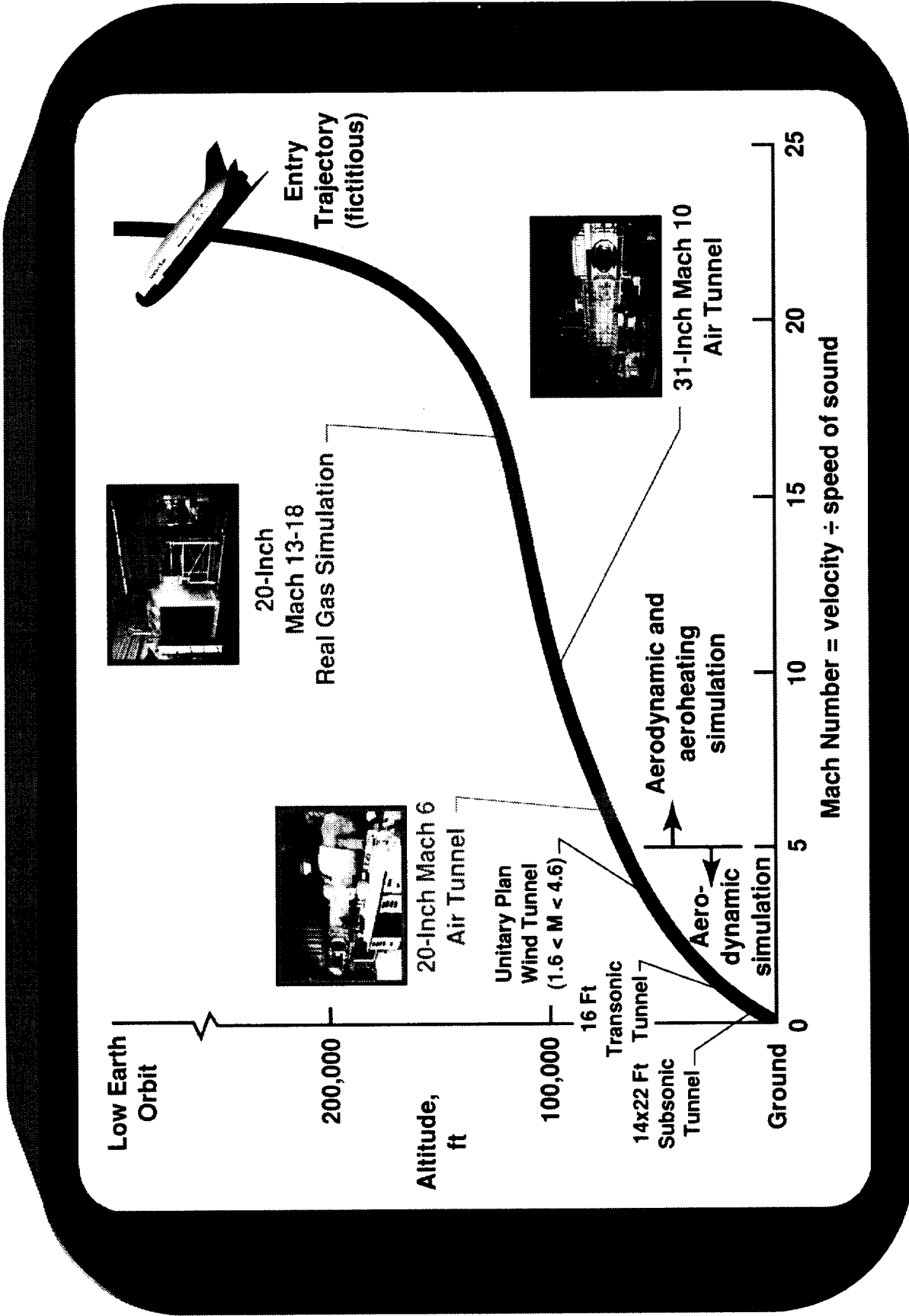

Airframe/TPS - Aerothermodynamics

Aerothermodynamic Flight Simulation Capability

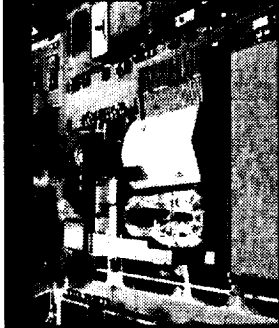

Low Turbulence
Pressure
Tunnel



14-by 22-Foot
Subsonic
Tunnel



16-Foot
Transonic
Tunnel

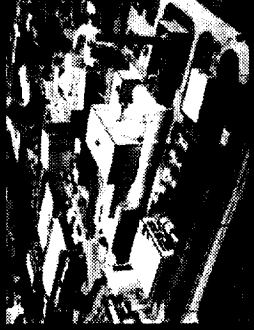

National
Transonic
Facility

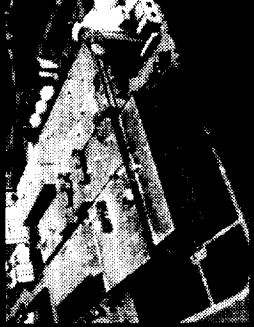

Unitary
Plan Wind
Tunnel



20-Inch
Mach 6 Air
Tunnel

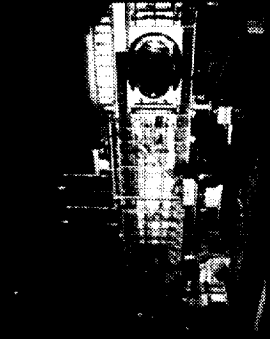

31-Inch
Mach 10 Air
Tunnel

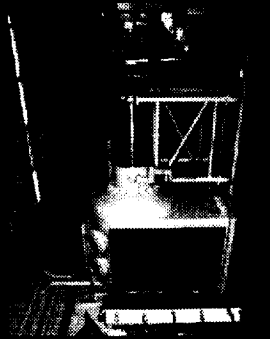

20-Inch
Mach 6 CF₄
Tunnel
(Mach 13-18 Real
Gas Simulation)

Airframe/TPS - Aerothermodynamics

LaRC Subsonic-to-Hypersonic Wind Tunnels

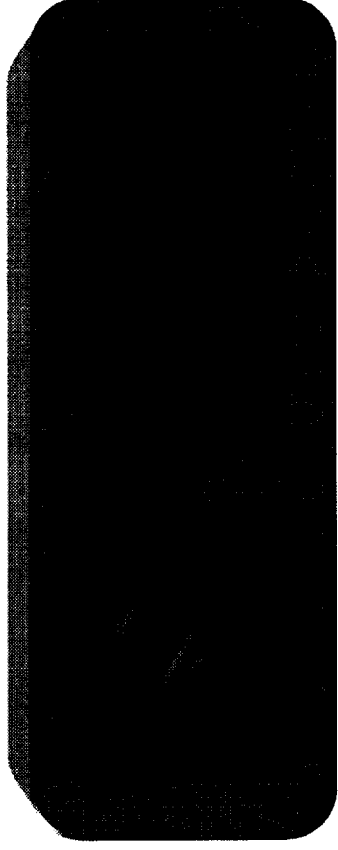
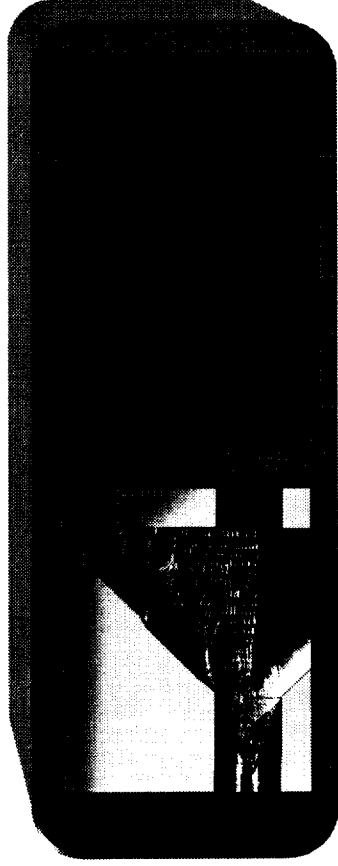
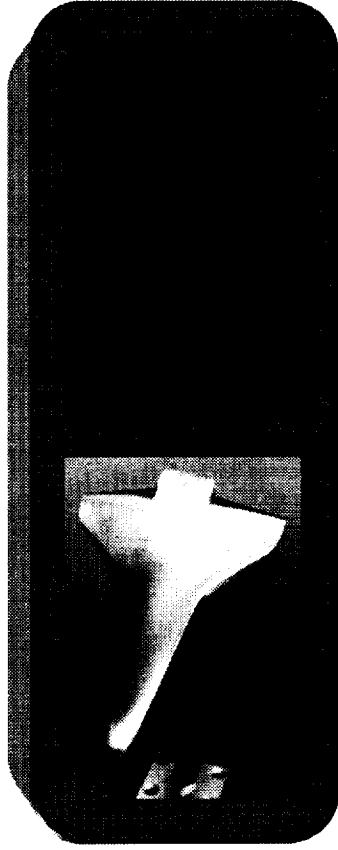
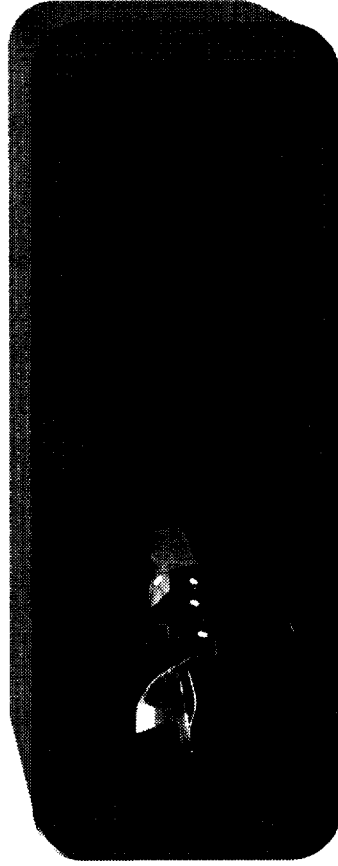
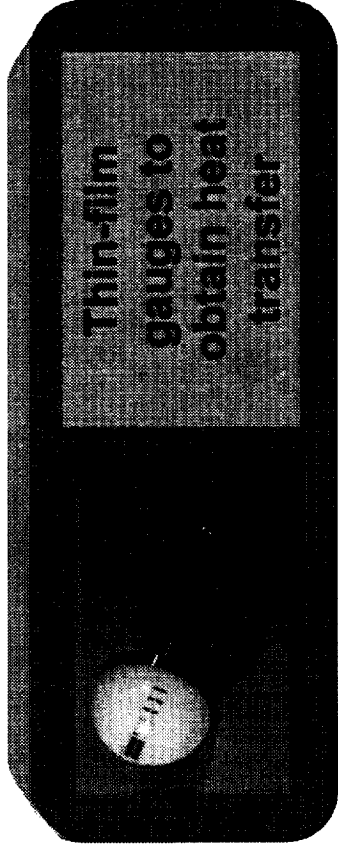
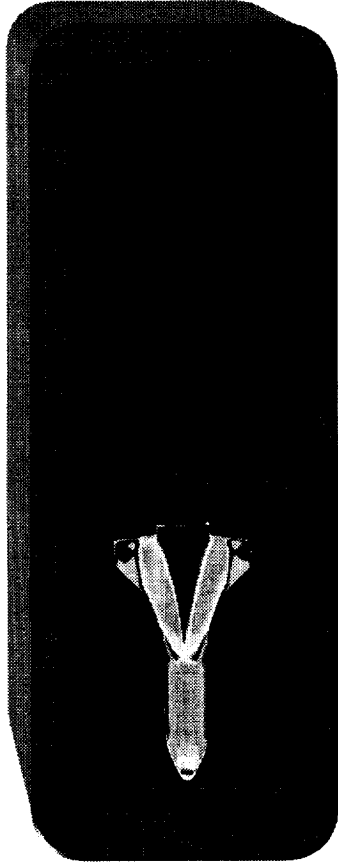

Airframe/TPS - Aerothermodynamics

Testing Techniques

Vehicle Concept



Model Fabrication

- Casting of ceramic models
- Rapid turnaround
- Complex shapes

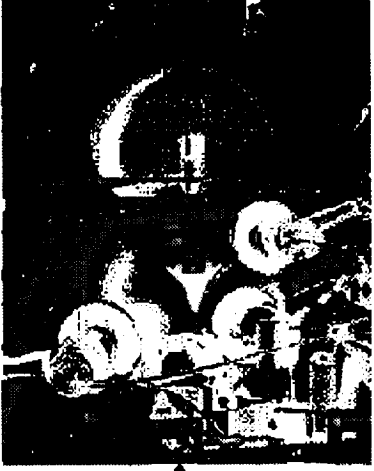

Wind Tunnel Testing

- Two-color fluorescence
- State-of-art computerized acquisition system

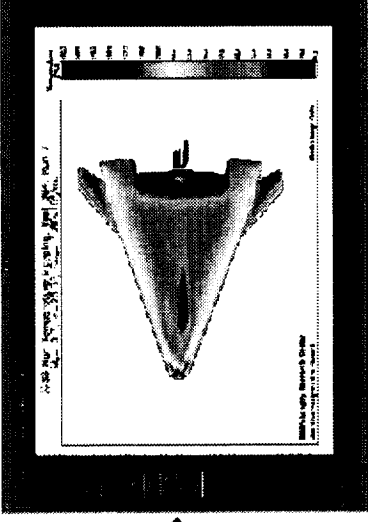

Analysis of Measurements

- Nonlinear theory to infer accurate temperatures
- User-friendly computer program (IHEAT)

Aeroheating data to customers

Airframe/TPS - Aerothermodynamics

Phosphor Thermography Process

$M_\infty = 10.33$ $\alpha = 20^\circ$ $Re_\infty = 1.03 \times 10^6$ $\theta_{cog} = 0^\circ$

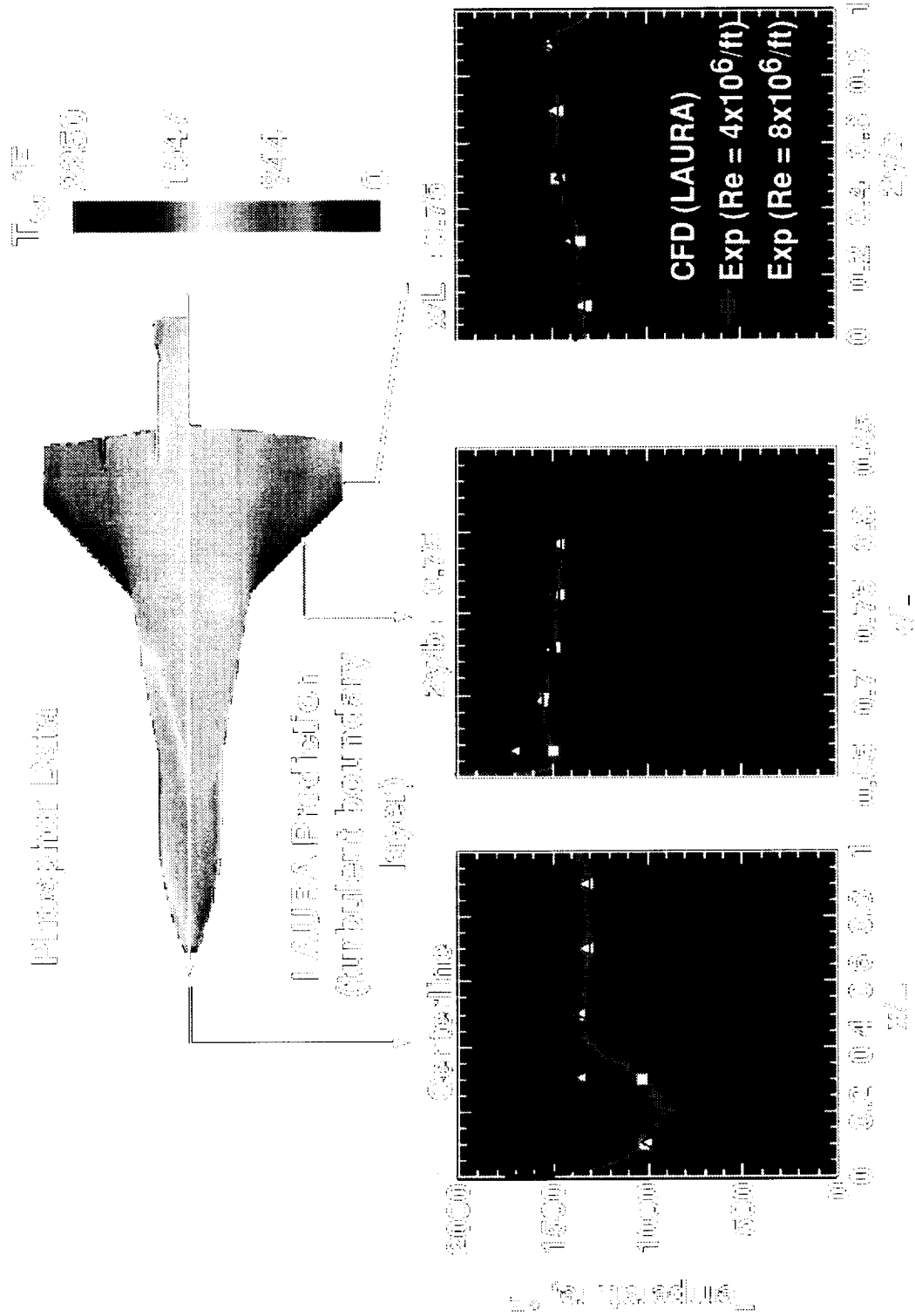

Airframe/TPS - Aerothermodynamics

Extrapolation of Measurements to Flight

Surface Heating

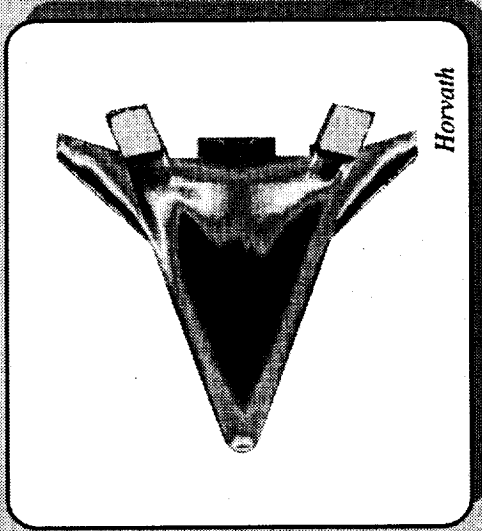

Forces and Moments

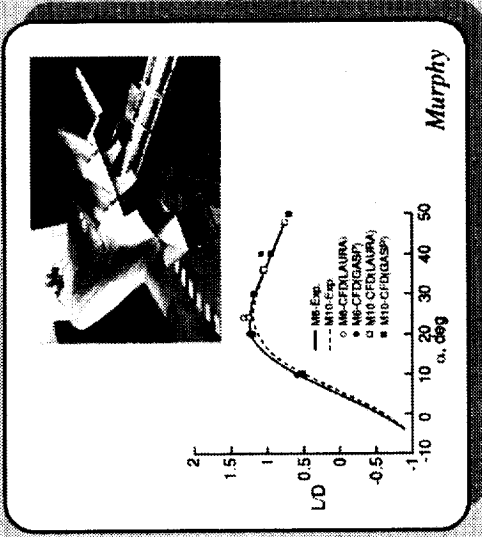

Surface Streamlines

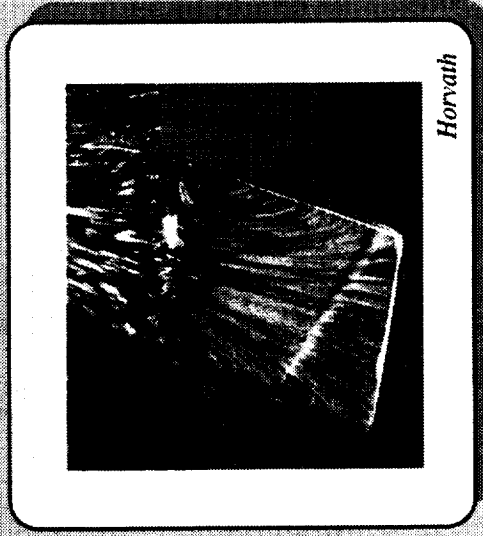

Shock Waves

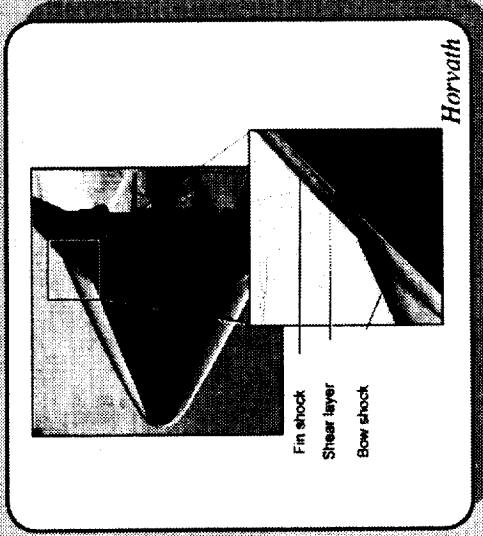



Space Station



Aeroassist
Orbital Transfer

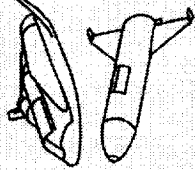

Space Transportation

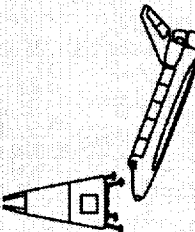

Aerospace
Planes



Free Molecular
Flow

Transitional
Flow

Continuum
Flow

LaRC Workhorse Codes for X-33/X-34/X-37



Navier Stokes*

Viscous Shock Layer

Inviscid/Boundary Layer

Direct Simulation Monte Carlo

DSMC Analysis Code (DAC); 3D capability developed by Jay LeBeau (JSC) and Dr. Richard Wilmoth; physical modeling per Dr. Graeme Bird, Univ. of Sydney

* Also, GASP, registered trademark of AeroSoft, Inc.

Airframe/TPS - Aerothermodynamics

Computational Fluid Dynamics (CFD)

X-33

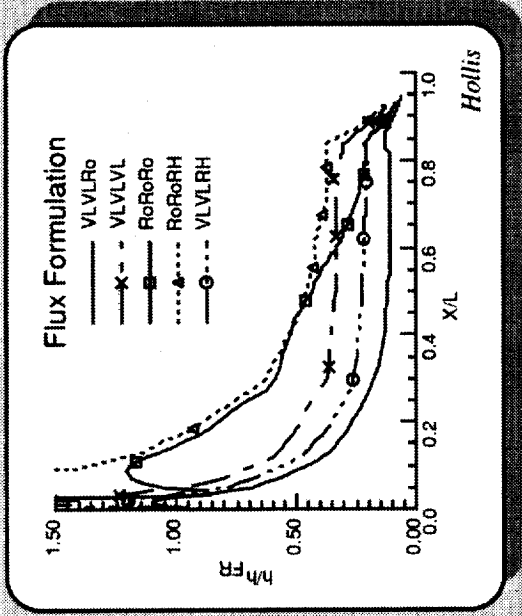
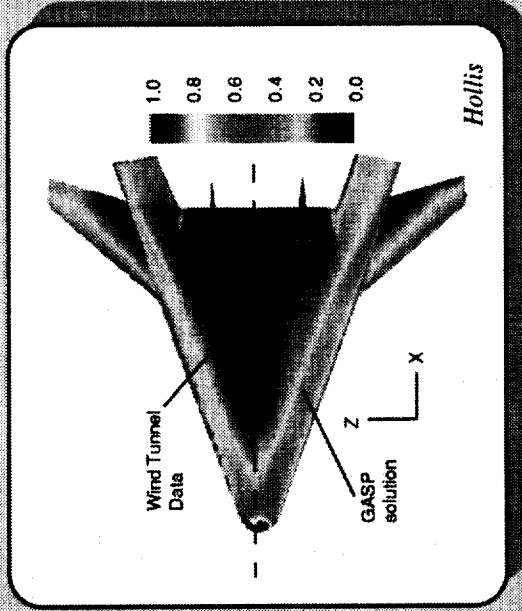

X-34

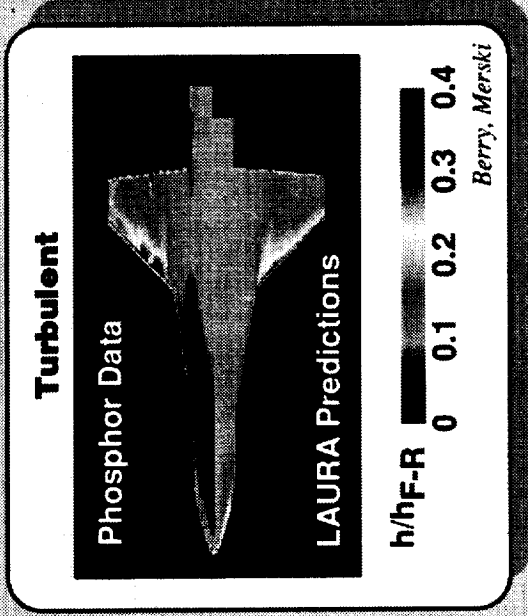
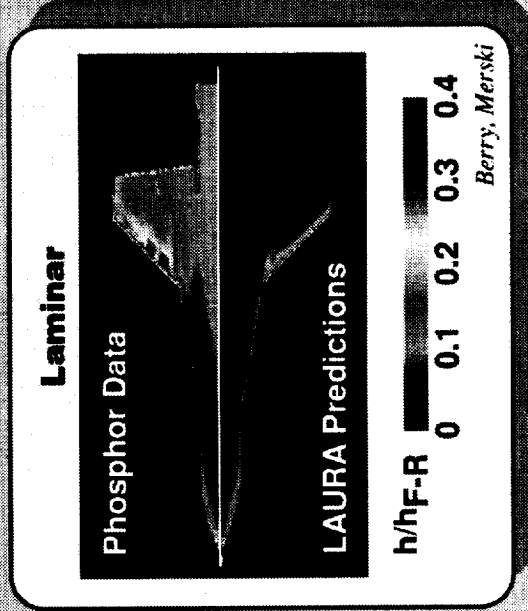

Airframe/TPS - Aerothermodynamics

Computational - Experimental Synergism

**Wind tunnel
measurements**

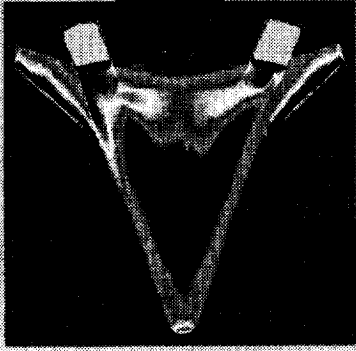

**Altitude
- angle of attack-
velocity mapping**

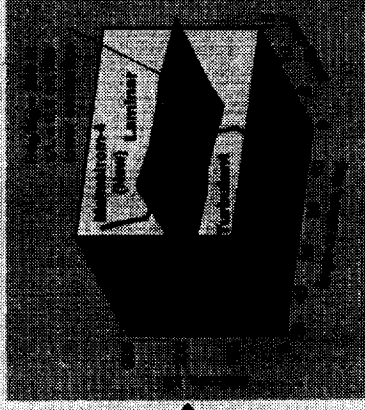

Thompson

**Roughness
transition
correlation**

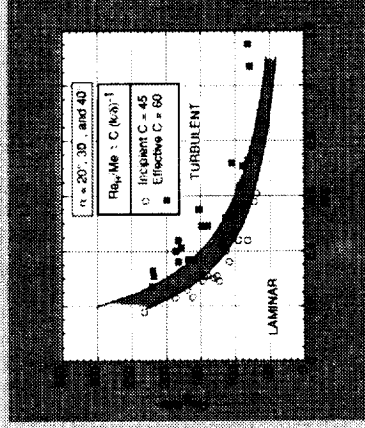

**Inviscid/boundary
layer predictions**



Airframe/TPS - Aerothermodynamics

X-33 Boundary Layer Transition Methodology

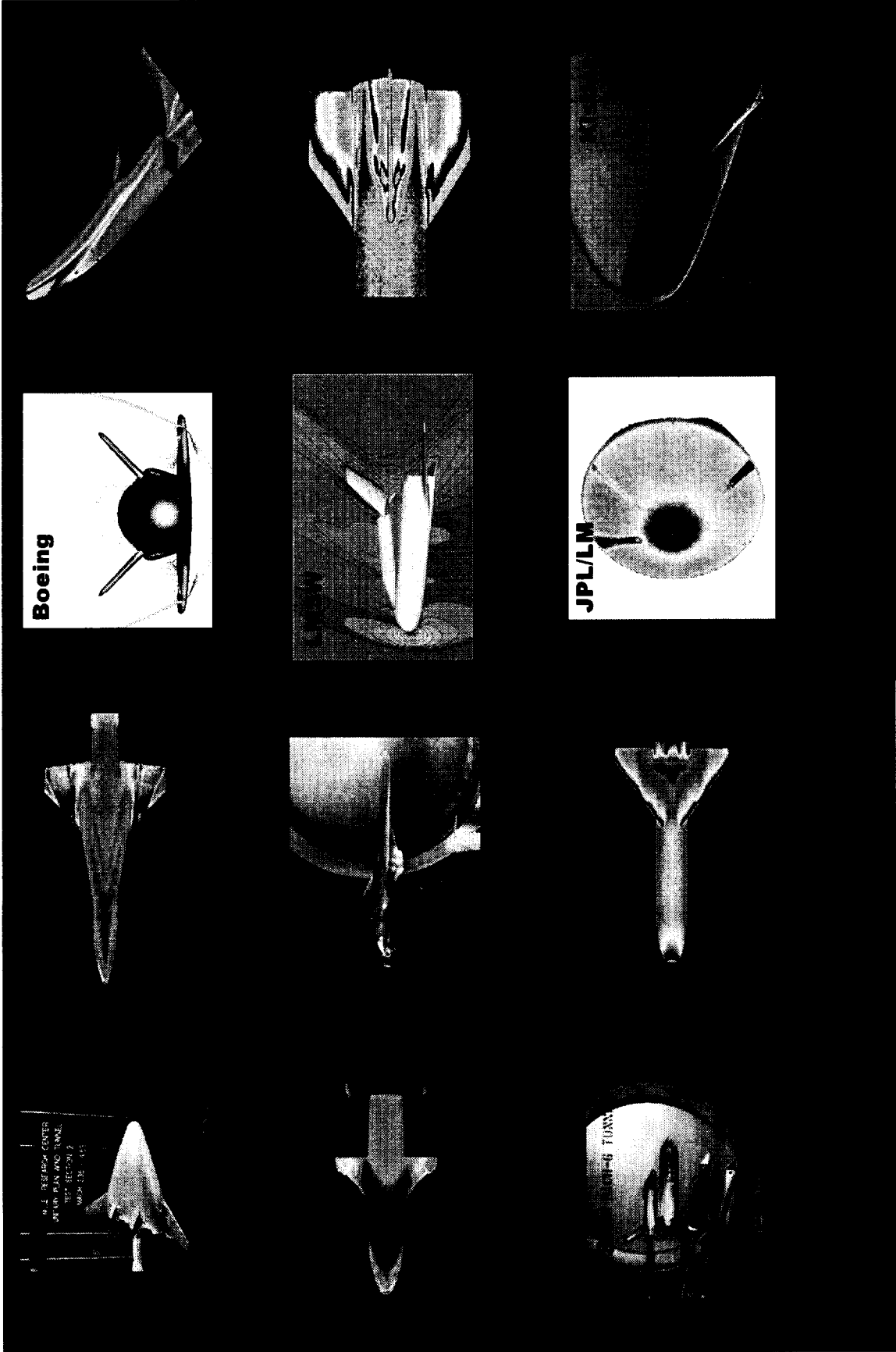

Airframe/TPS - Aerothermodynamics

Recent LaRC Aerothermodynamic Contributions

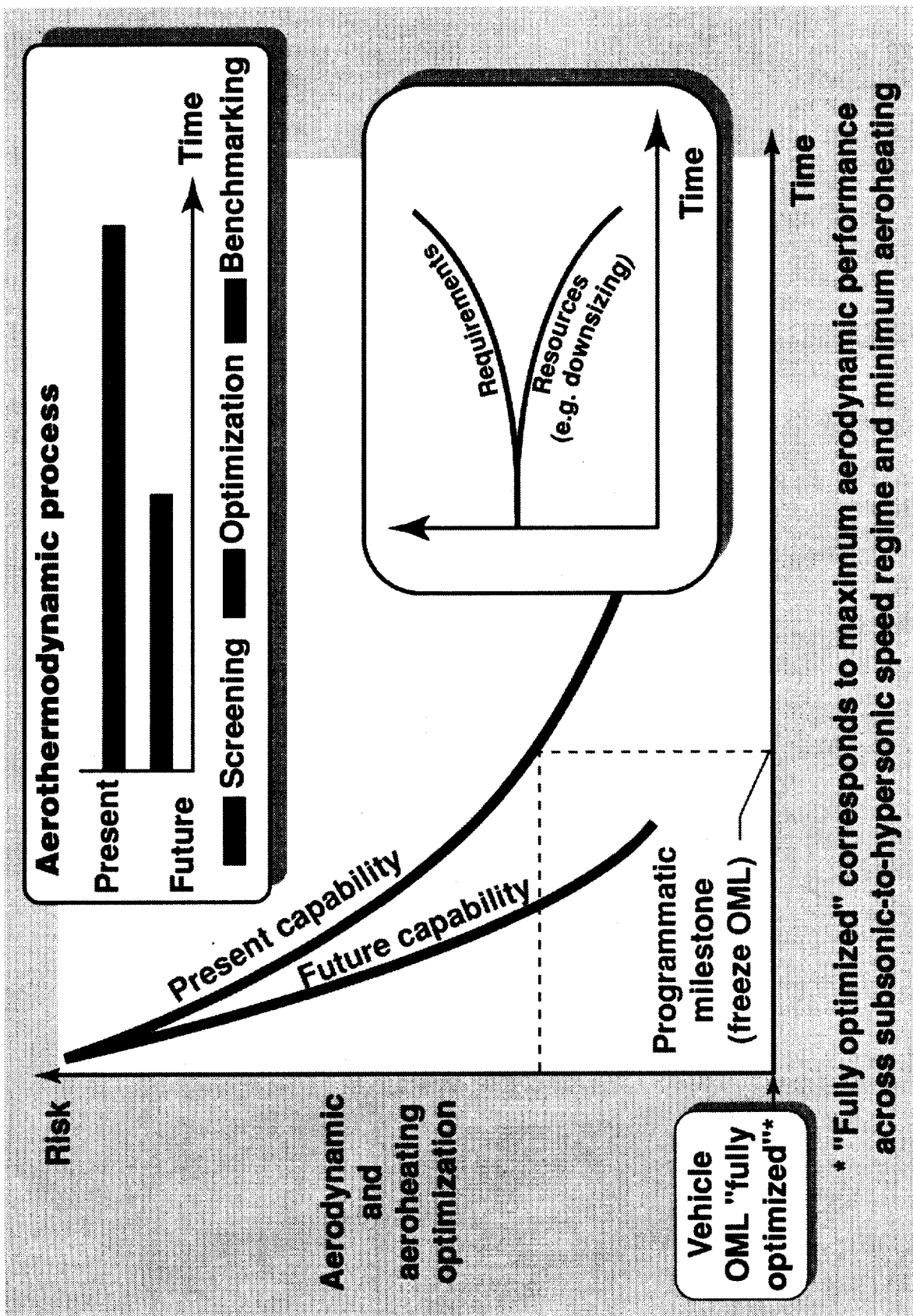

Airframe/TPS - Aerothermodynamics

Aerospace Vehicle Design: Risk vs. Time

Calibration/validation of experimental and computational tools via comparisons to flight data

- Aerodynamic performance/aeroheating characteristics extracted from flights

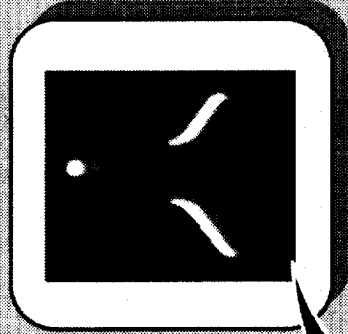

**BMDO/ISTEF
IR Image of
STS-96**

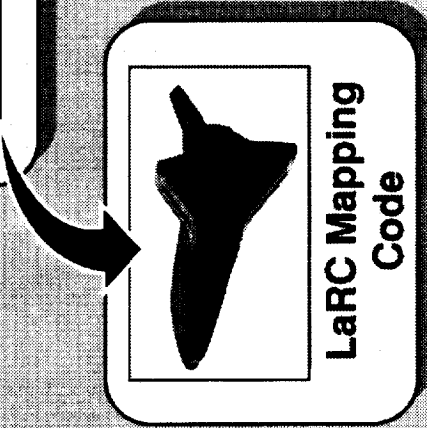

**Demonstrate on Orbiter
prior to X-33 application**



On-board and off-board aeroheating measurements

Airframe/TPS - Aerothermodynamics

Future Plans

◆ “Review of X-33 Hypersonic Aerodynamic and Aerothermodynamic Development”; ICA-0323

Richard A. Thompson, NASA Langley Research Center
Presented at 22nd International Congress of
Aeronautical Sciences, August 27 - Sept 1, 2000,
Harrogate, United Kingdom

Paper available:

<http://techreports.larc.nasa.gov/ltrs/PDF/2000/mtg/NASA-2000-22cicas-rat.pdf>

Extensive list of references

◆ **Journal of Spacecraft and Rockets; Vol. 36, No. 2, Mar-Apr 1999**
Special Section: X-34; pages 153-239
(collection of nine papers)

Airframe/TPS - Aerothermodynamics

Reference Sources for Recent RLV Studies

- ◆ 12:45 - 1:00 Introduction 2nd Gen RLV Airframe S. Welch
- ◆ 1:00 - 1:20 Airframe Design and Integration S. Scotti
- ◆ 1:20 - 1:40 Aerothermodynamics C. Miller
- ◆ 1:40 - 2:00 Structures and Materials T. Johnson
- ◆ 2:00 - 2:20 Tanks D. Smith
- ◆ 2:20 - 2:40 Thermal Protection Systems M. Rezin
- ◆ 2:40 - 3:00 Integrated Airframe Demonstrations D. Glass

- ◆ 3:00 - 3:05 BREAK

- ◆ 3:05 - 3:30 Introduction 3rd Gen RLV Airframe D. Bowles
- ◆ 3:30 - 3:55 Integrated Design and Analysis T. Gates
- ◆ 3:55 - 4:20 Integrated Thermal Str. & Materials B. Jensen
- ◆ 4:20 - 4:45 Thermal Protection Systems S. Johnson

2nd Gen Airframe/TPS - Structures and Materials:

Agenda

2nd Generation RLV Airframe Structures and Materials

**Theodore F. Johnson
NASA Langley Research Center
757-864-5418
t.f.johnson@larc.nasa.gov**

**Presented at the RLV Technology Workshop
NASA Marshall Space Flight Center
October 10-11, 2000**

2nd Gen Airframe/TPS - Structures and Materials:

Structures and Materials

- ◆ **Goals and Objectives**
- ◆ **Structures and Materials Roadmap**
- ◆ **Recent Accomplishments**
- ◆ **Description of NASA-led Tasks**
- ◆ **Summary**

2nd Gen Airframe/TPS - Structures and Materials:

Presentation Outline

- ◆ **Develop and demonstrate verified airframe and cryotank structural design and analysis technologies**
 - **Damage tolerance, safety, reliability and residual strength technologies**
 - **Robust nonlinear shell and cryotank analysis technologies**
 - **High-fidelity analysis and design technologies for local structural detail features and joints**
 - **High-fidelity analysis technologies for sandwich structures**

- ◆ **Demonstrate low cost, robust materials and processing**
 - **Polymeric Matrix Composite (PMC) and metallic materials and processing**
 - **Refractory composite and metallic hot structures materials and processing**

2nd Gen Airframe/TPS - Structures and Materials:

Goals and Objectives

- ◆ **Develop and demonstrate robust airframe structures and validated integrated airframe structural concepts**
 - **Low cost fabrication and joining**
 - **Operations efficient designs and inspection techniques, NDE**
 - **Scale-up and integrated thermal structural test**
 - **Airframe structures IVHM**

- ◆ **Demonstrate low cost, robust repair techniques**

- ◆ **Develop verified integrated airframe structural concepts**
 - **Integrated (Primary & cryotank struct./Insulation/TPS) structural concepts**

- ◆ **Plans developed for all structures and materials technology tasks work is being initiated**
- ◆ **High-fidelity nonlinear shell analysis capability under development for response, damage tolerance and residual strength analyses**
- ◆ **Lifecycle and durability testing of materials and structures are currently being conducted**
- ◆ **Tests of curved stiffened composite panel planned for cryo-pressure box test facility**
- ◆ **Cryo-pressure box successfully completed Operational Readiness Review (ORR)**
- ◆ **Developing test capability for Helium permeation under combined temperature and mechanical loads**

2nd Gen Airframe/TPS - Structures and Materials:

Recent Accomplishments

Maximum Principal Strain Plots

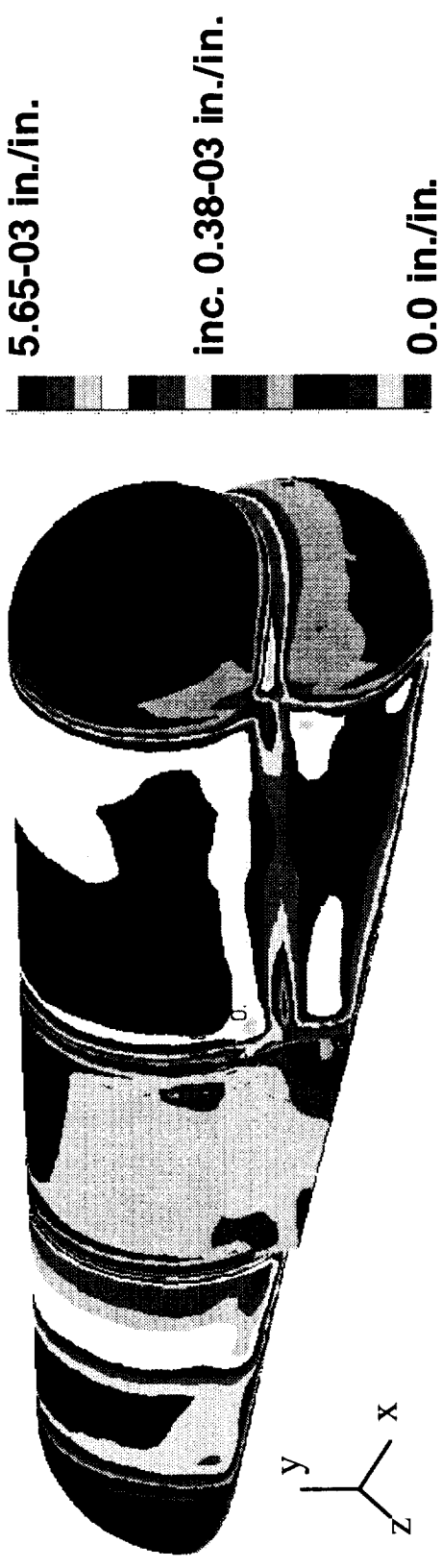

Linear Analysis



Nonlinear Analysis

2nd Gen Airframe/TPS - Structures and Materials:

Multi-Lobed Tank Nonlinear Analysis

Space Shuttle Superlightweight External Tank Identifies LO₂ Tank Local Stability Mode

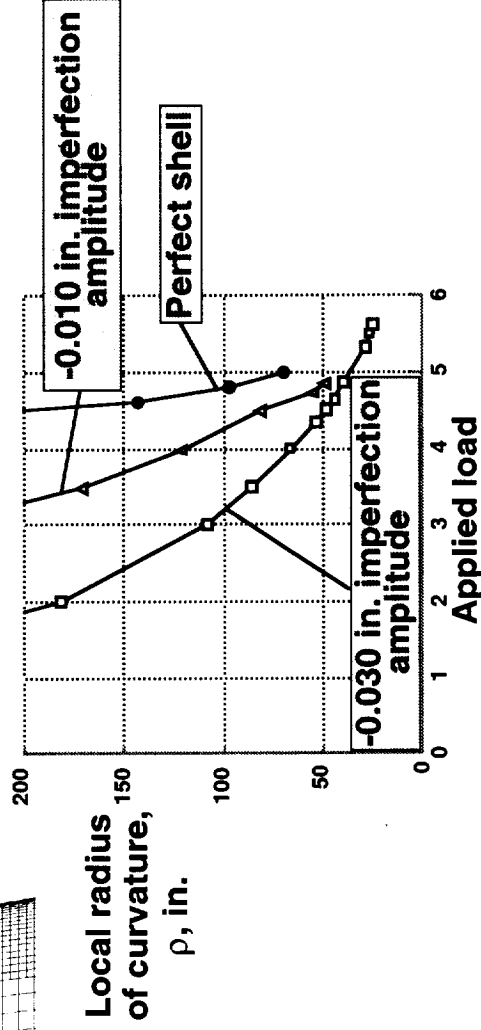
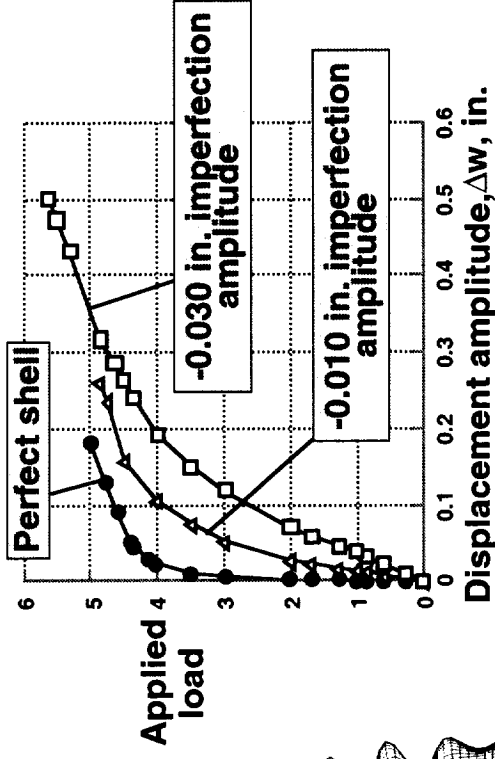
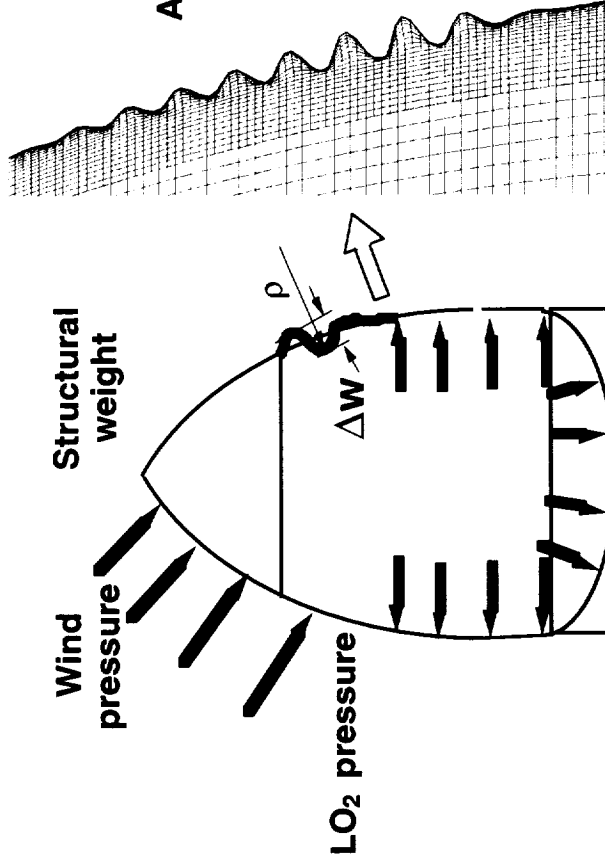

2nd Gen Airframe/TPS - Structures and Materials:

High Fidelity Nonlinear Analysis

Traditional Design Knockdown Factors

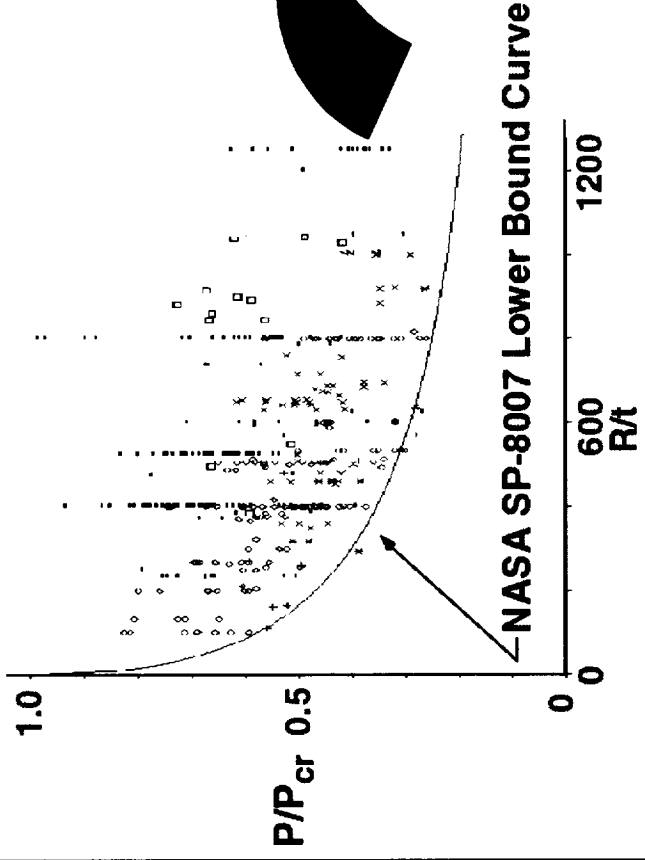

Objective: Develop verified high fidelity analysis tools to reduce dependence on tests

High fidelity analysis

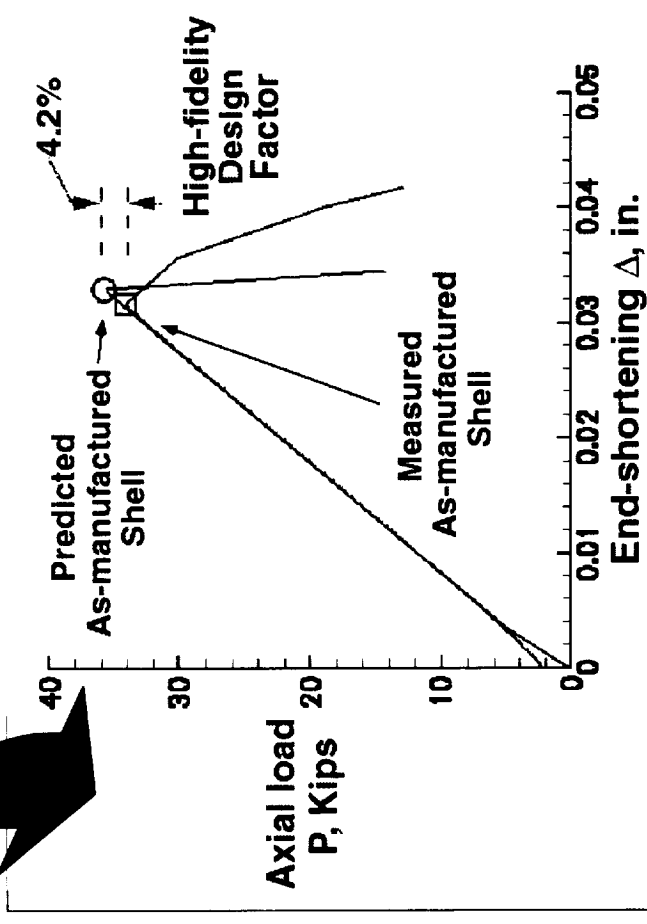

2nd Gen Airframe/TPS - Structures and Materials:

Technologies:

- ◆ High fidelity modeling
- ◆ Rapid and accurate analysis tools
- ◆ Prediction capability for all failure mechanisms
- ◆ Progressive failure methods for residual strength
- ◆ Intelligent testing approaches

High Fidelity Non-Linear Structural Analysis for Predicting Complex Structural Phenomena

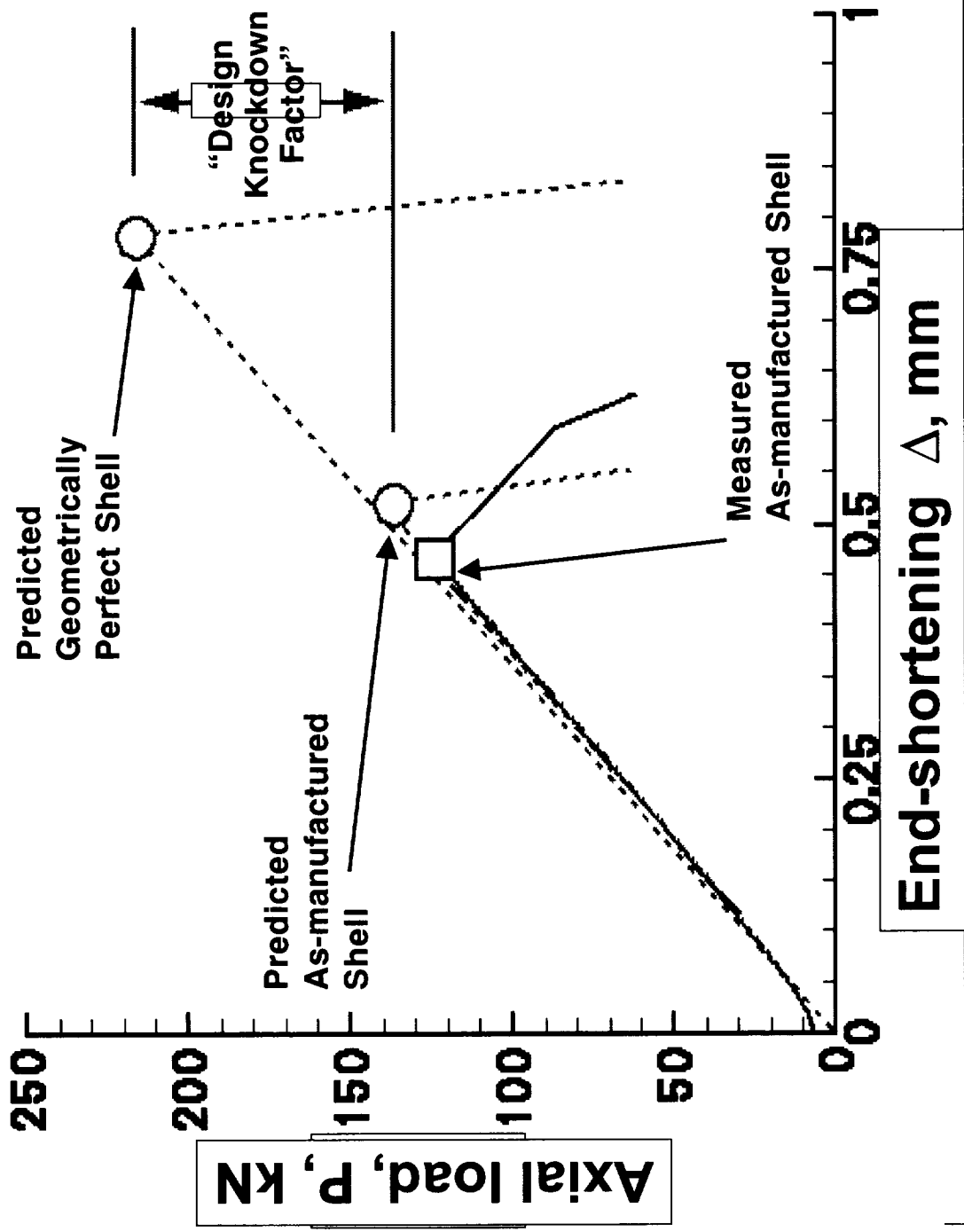

2nd Gen Airframe/TPS - Structures and Materials:

Predicted and Measured Response of a Composite Shell Structure

Laboratory Coupons

M(T) 12.0 in., 2a = 4 in.

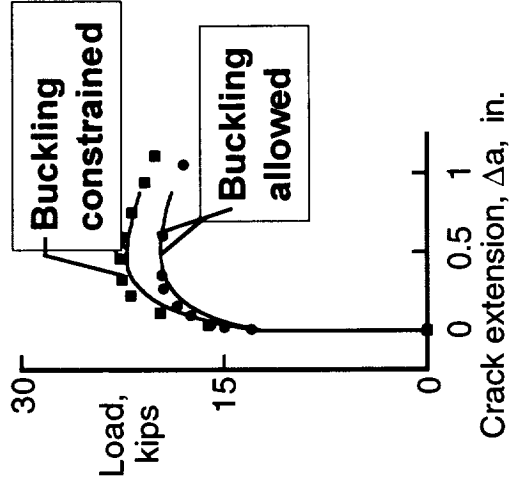
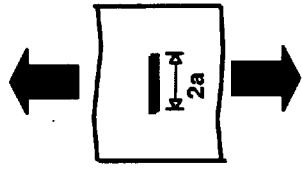

Fuselage Panel with Multiple Site Damage (MSD)

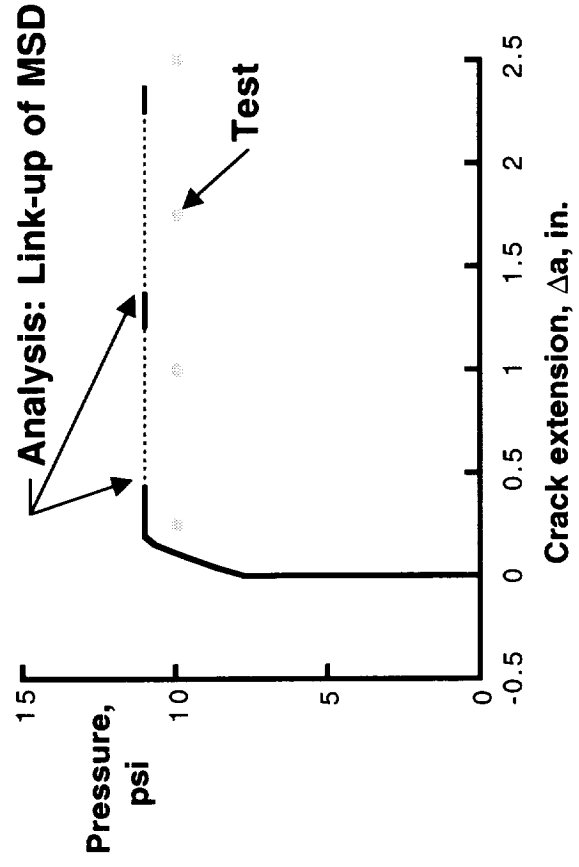
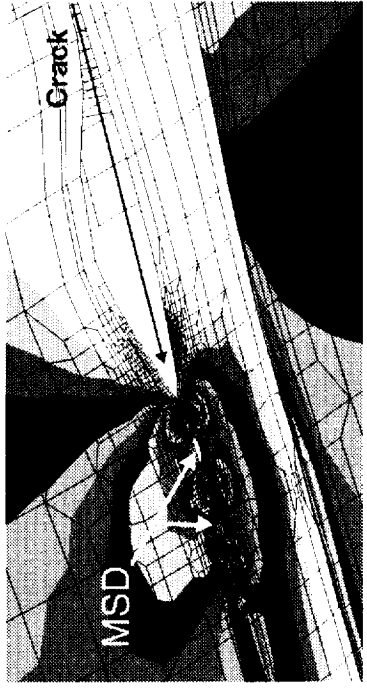

2nd Gen Airframe/TPS - Structures and Materials:

Applying Advanced Methods for Residual Strength Predictions

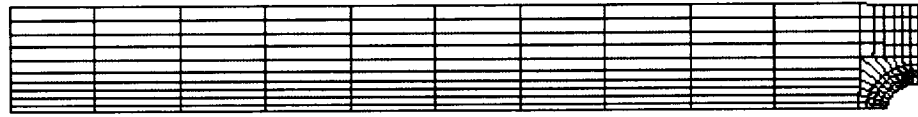

Tension-loaded composite plate with a cutout

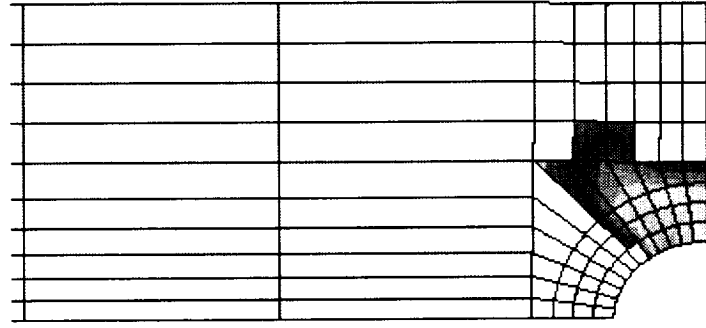

2700 lb.

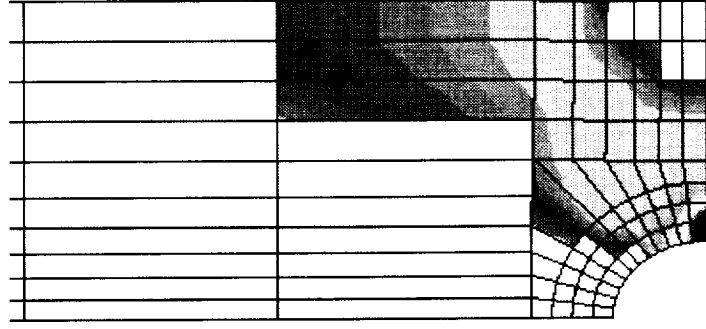

3150 lb.

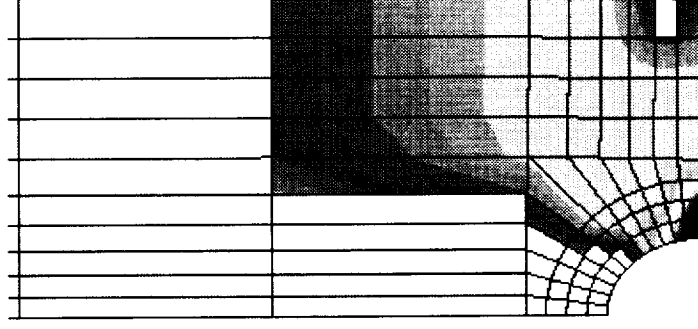

3376 lb.

Percent
Failed Plies
per Element

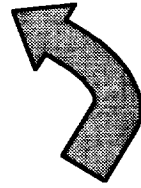
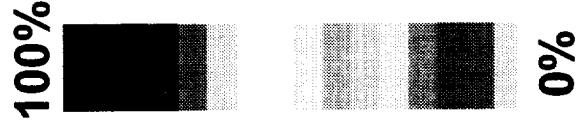

2nd Gen Airframe/TPS - Structures and Materials:

Progressive Failure Analysis

Maximum load solution for a composite plate with a cutout

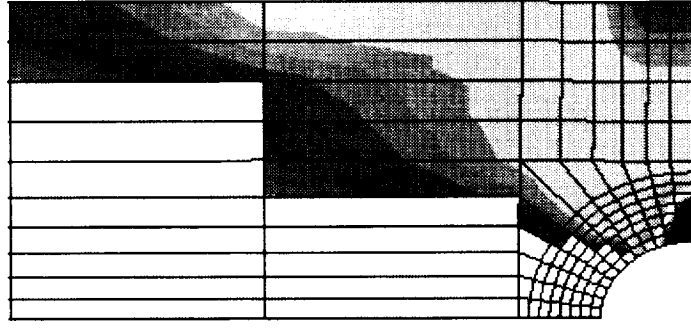

3430 lb.

Percent
Failed Plies
per Element

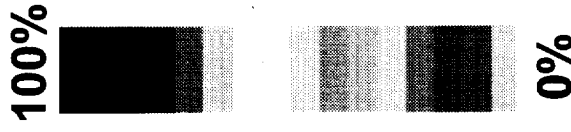

Longitudinal Stress Distribution in
Outer 0-deg. Ply



4.013E+05 psi

Inc. 1.442E+04 psi

2.164E+05 psi

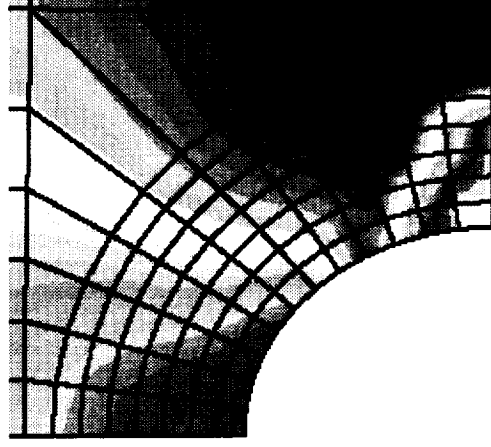
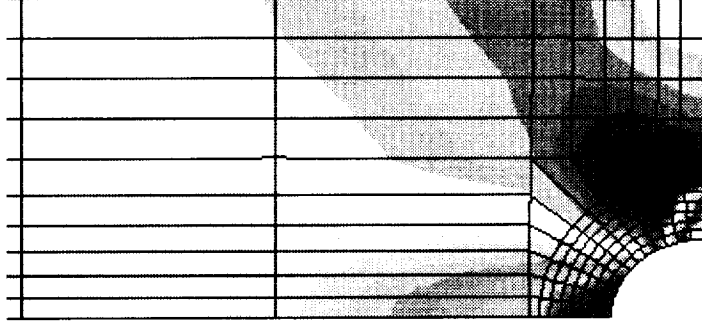

2nd Gen Airframe/TPS - Structures and Materials:

Progressive Failure Analysis - Cont.

**RLV wing box
test setup**

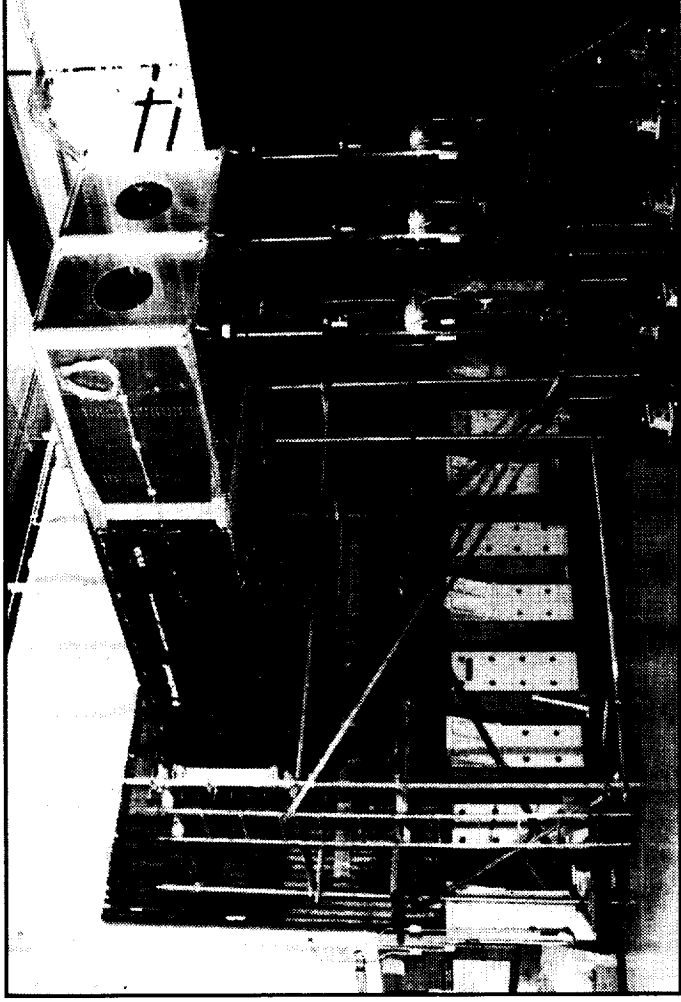

**Measured and
calculated strains on
an RLV wingbox
upper and lower
surfaces**

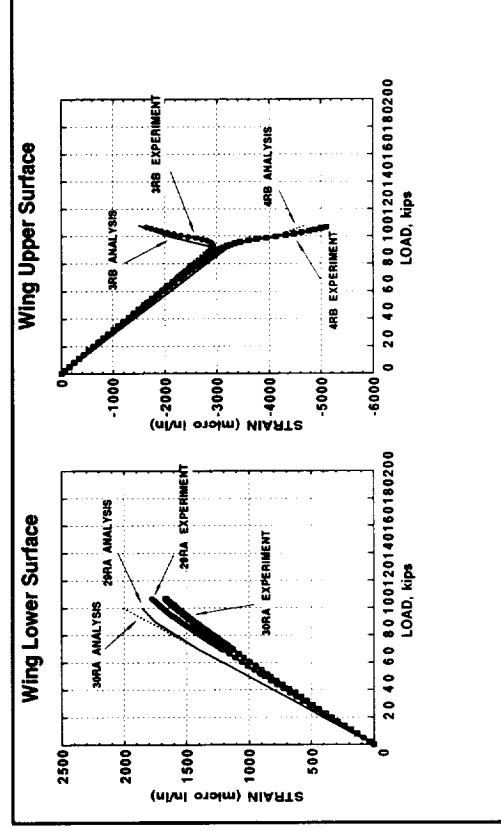

2nd Gen Airframe/TPS - Structures and Materials:

X-33 Phase I Graphite Composite Wing Box Design Validation Test

Distributed Fiber-Optic (F/O) Sensing for Structures IVHM

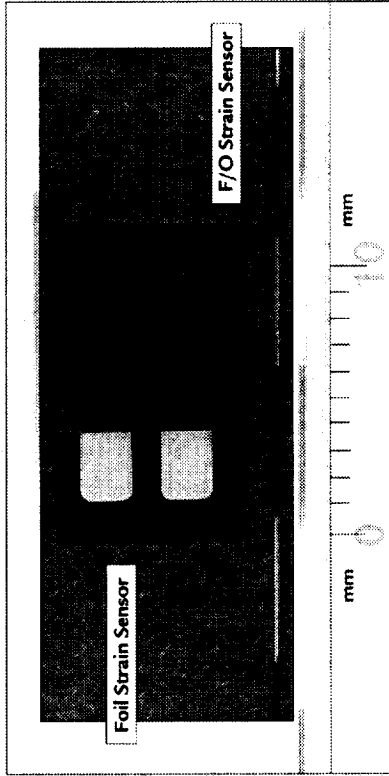

High Density Structural Sensors

- 10,000 Sensors < 1 pound
- Strain, Temperature, & Hydrogen (Propellant Leaks)
- Future Research - Vibration, Shape, Acoustic Emission, Chemistry (Corrosion)
- < \$10/Sensor

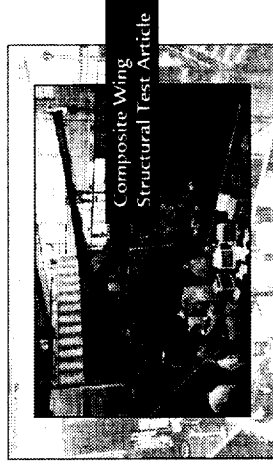
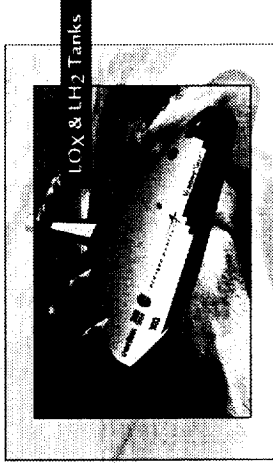

2nd Gen Airframe/TPS - Structures and Materials:

Distributed Fiber Optic Sensing

Capabilities:

Loads

- Bi-axial tension is applied
- Max. axial load is 450 kips
- Max. internal pressure is 45 psig
- Internal cooling to -400°F
- Internal heating to 250°F
- External heating to 1000°F

Geometry

- Panel size is 65 in. x 76 1/2 in.
- Panel radii from 130 in. to 266 in. (80 in. is possible)
- Panels can have internal and external ring frames and stringers

Benefit

- Full-scale tank features
- Testing at subcomponent costs

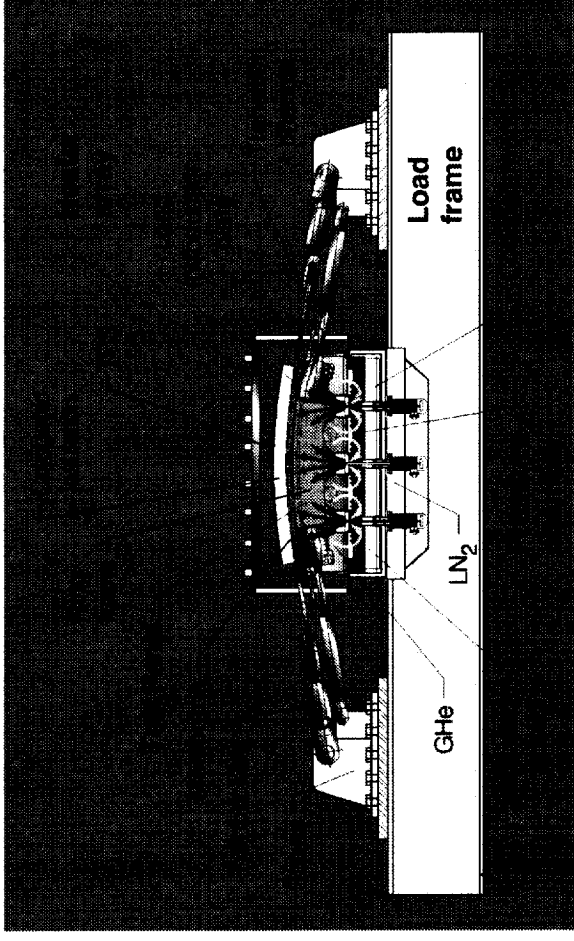

2nd Gen Airframe/TPS - Structures and Materials:

Cryogenic Pressure Box Facility

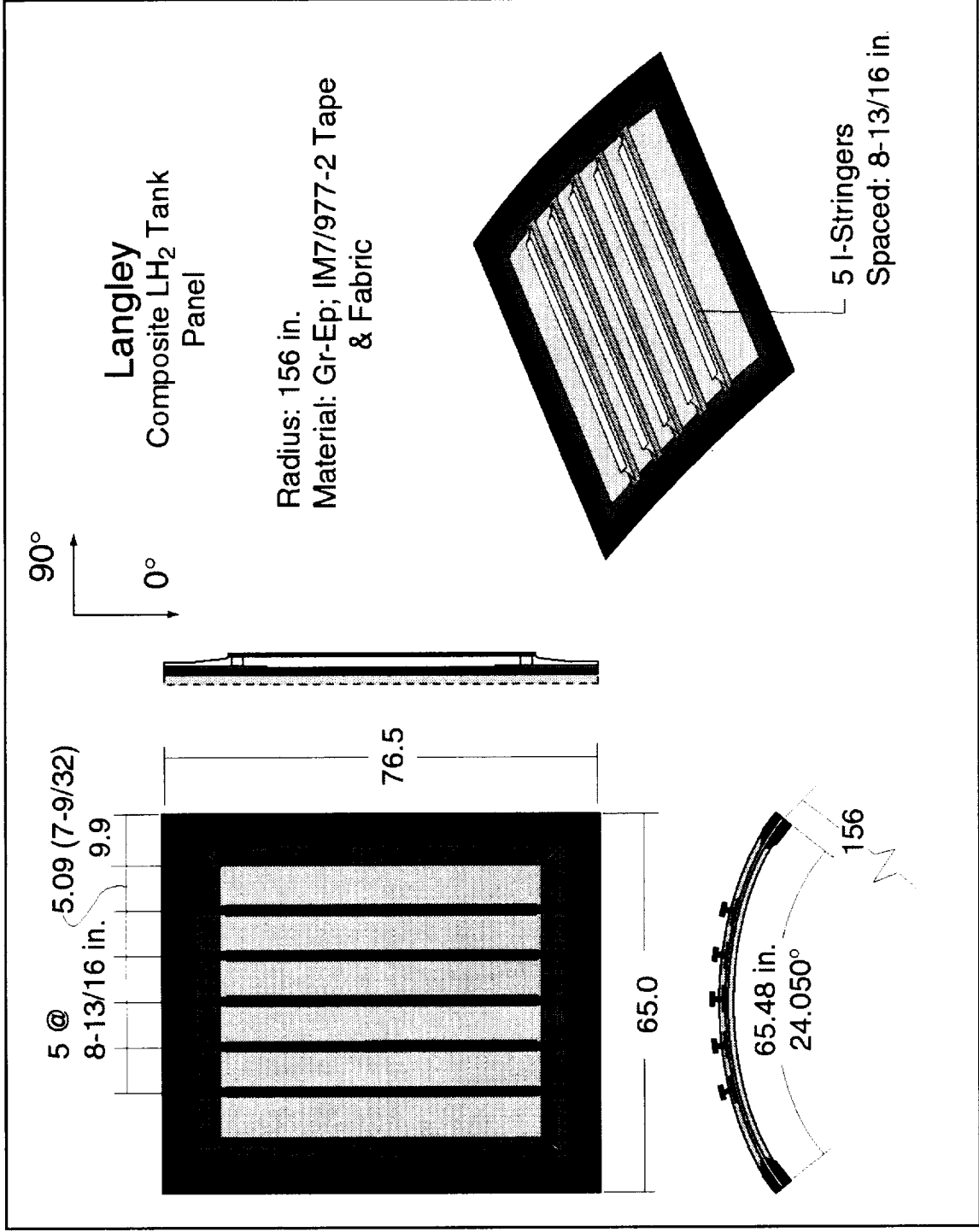

2nd Gen Airframe/TPS - Structures and Materials:

Cryogenic Pressure Box Panel

- Combined thermal and structural analysis
- Traceable solutions to flight articles

Full sized articles

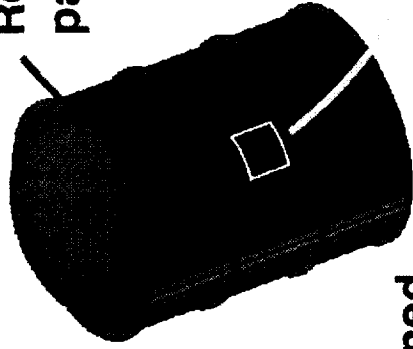

Tank geometry modelled as a cylinder

Graphite-Epoxy Externally stiffened LH₂ tank

Representative panel section

Structural Analysis

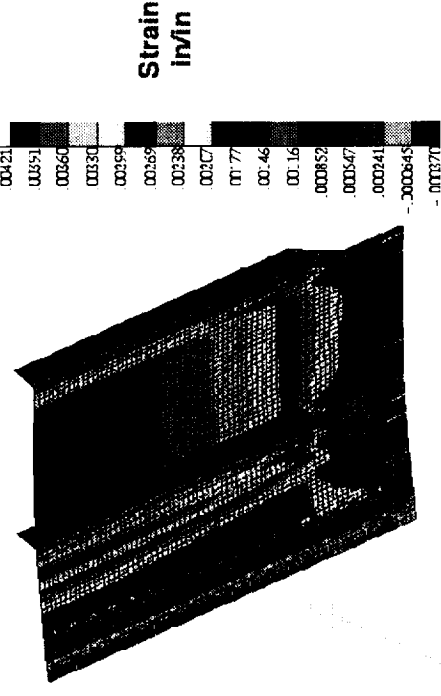

Thermal Analysis

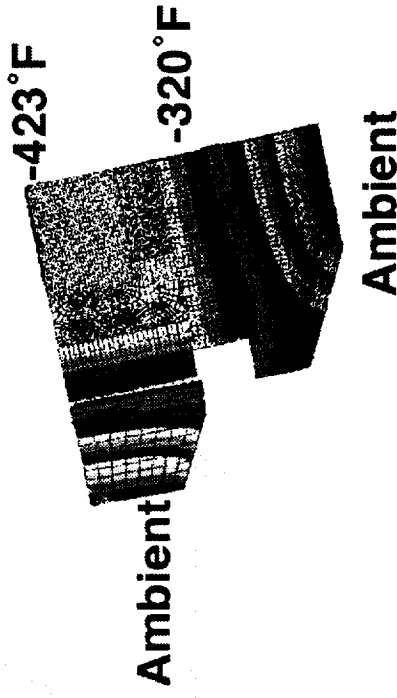

2nd Gen Airframe/TPS - Structures and Materials:

Correlation of Analysis to Test

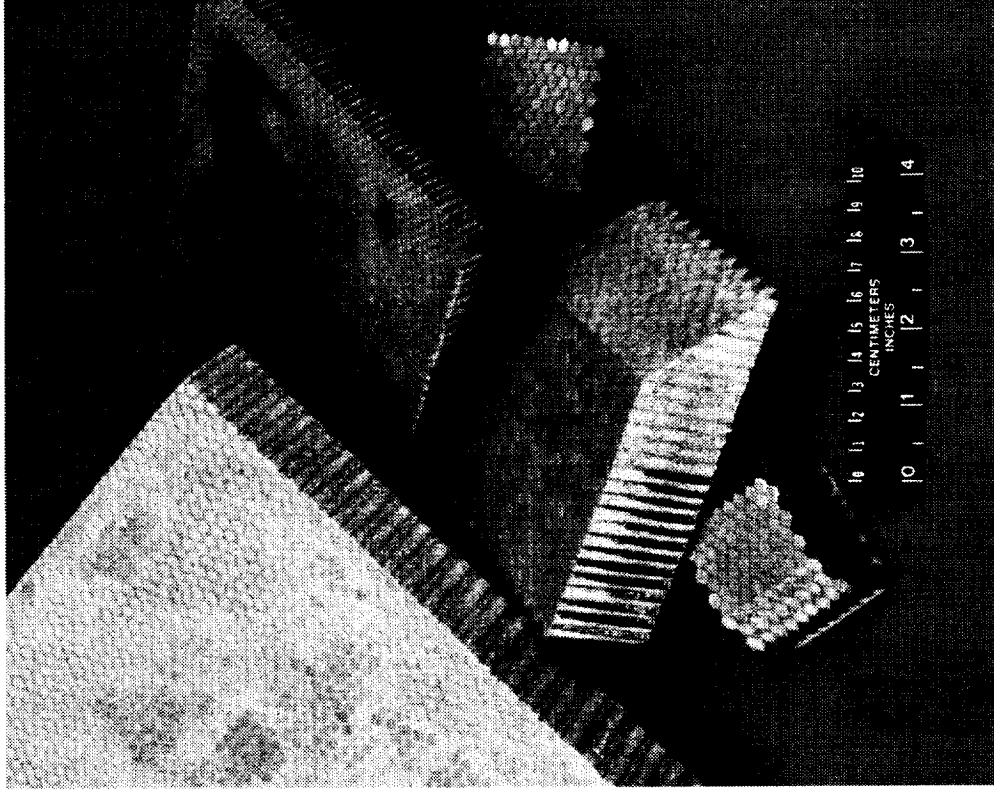

- ◆ Any honeycomb material can be foam filled - Korex, Nomex, Graphite, etc.
- ◆ Honeycomb cell size from 1/8" and larger can be foam filled.
- ◆ Honeycomb core thickness from 1/4" and larger.
- ◆ Foam densities ~2.6 pcf.

2nd Gen Airframe/TPS - Structures and Materials:

TEEK Foam Filled Honeycomb Materials

Cross-Section of fixture

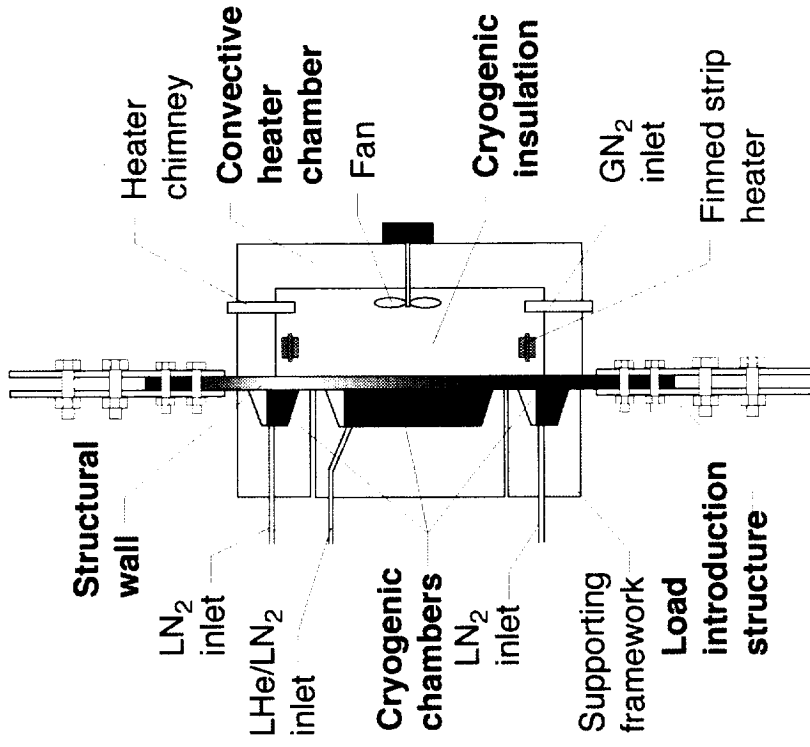

Specimens

Substrate: 1' x 2' & 1' x 4'

Min. Temp.

-423°F (Cryo. side)
10°F (Foam surface)

Max. Temp.

250°F (Cryo. side)
450°F (Foam surface)

Max. Load: 110 kips

2nd Gen Airframe/TPS - Structures and Materials:

Thermal/Mechanical Tension Test

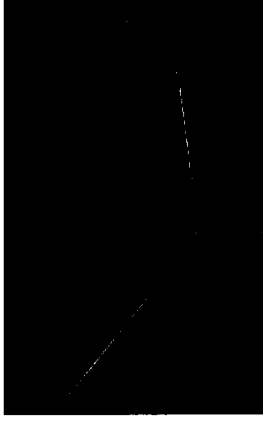

Hoop Y-joint



Axial Y-joint

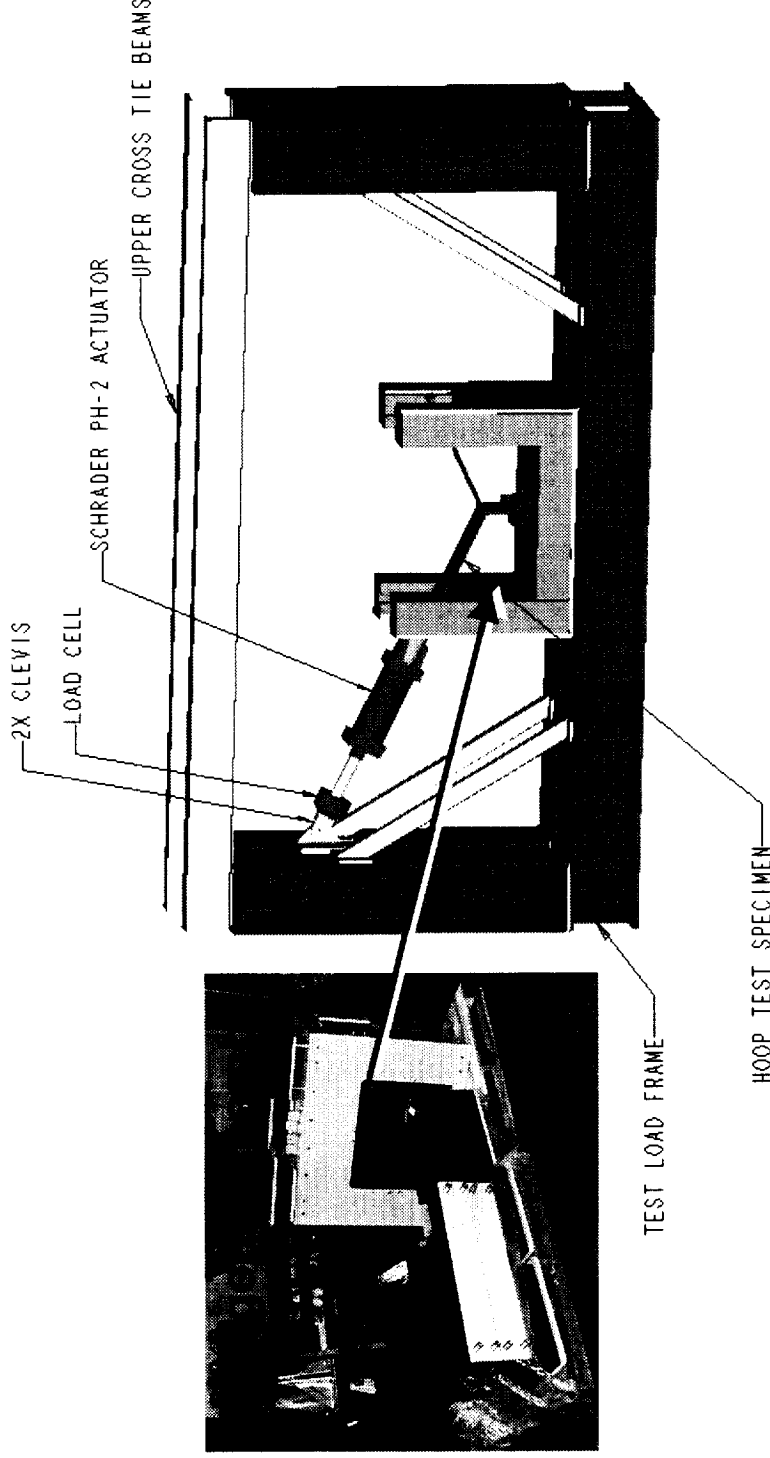

Specimens

- 2 Hoop Tension Y-Joints
 - Arm-to-Barrel step joint
- 2 Axial Tension Y-Joints
 - Axial and Arm-to-Barrel step joint

Test Plan

- 10 Thermal Cycles (-423°F to +250°F)
- Pull to failure at -423°F
- Record failure load, failure mode

2nd Gen Airframe/TPS - Structures and Materials:

Hoop & Axial Y-Joint Tests

Element

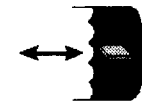

Thermal
Cycling



Mechanical
Cycling



Determine
residual
strength

Panel



Cyclic Combined
Thermal-Mechanical
loads tests



Cyclic Combined
Thermal-Mechanical
loads tests

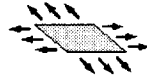

Biaxial
loads tests

Subcomponent



8 Ft. Tunnel



Cryogenic
Pressure Box

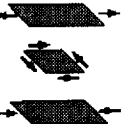

D-Box

Section for
additional
element tests

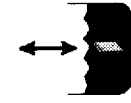

2nd Gen Airframe/TPS - Structures and Materials:

Materials in Structural Applications

◆ **NASA's Thermal Protection System (TPS) Technologies**

- RLV Focused Projects
- Recent or Emerging Technologies

◆ **NASA's TPS Research, Development & Testing Capabilities**

- TPS Development Approach
- Laboratories
- Modeling
- Databases
- Test Facilities

◆ **TPS POC**

Marc Rezin

NASA Ames Research Center

(650) 604-6395

mrezin@mail.arc.nasa.gov

Space Transportation Technology Workshop - Airframe Section

TPS Technologies & Capabilities

- ◆ **Constituents and Fabrication Techniques for Metallic TPS - LaRC**
 - Advanced joining techniques
 - Surface property characterization
 - Durable, lightweight coating development
- ◆ **Metallic TPS Concepts - LaRC**
 - Improved metallic TPS concepts
 - Lower risk, subsurface panel-to-panel seals, cooler subsurface attachments
- ◆ **Advanced Durable Blanket TPS - ARC Partnership w/ Industry**
 - Lower fabrication and maintenance unit costs
 - Suitable for application to windward vehicle surfaces
- ◆ **High Temperature Integrated Structures - LaRC Partnership w/ Industry**
 - Structurally integrated high temperature wing design
 - Reduced manufacturing costs and improved load bearing characteristics

Space Transportation Technology Workshop - Airframe Section

RLV Focused Project of the ASTP

◆ Durability

- TUF1 & White TUF1 on AETB Ceramic Tiles - ARC
- Structural Seals & Thermal Barriers - GRC
- Toughened LI-900 - ARC
- Metallic Sandwich Panel TPS - LaRC
- Metal Covered Ceramic Blankets (DurAFRSI) - ARC
- CMC Covered Ceramic Tiles - LaRC
- Advanced Durable Ceramic Blankets - ARC with Industry Partner

◆ Lower Thermal Conductance

- Reduced Conductivity AETB Ceramic Tiles - ARC
- Nano-Phase Ceramic Insulations - ARC
 - Aerogel & other xerogel composites

◆ Higher Temperature Capability

- Ultra-High Temperature Ceramics - ARC, GRC, LaRC
 - including Zr & Hf based ceramic composites
- High Temperature Seals - GRC
- Heat Pipe Cooled Leading Edges - LaRC
- TUFH-HT, Ultra-TUFI on AETB Ceramic Tiles - ARC
- Higher Temperature Coatings for CMCs - JSC, LaRC
- Light-weight Ceramic Ablators - ARC
 - SIRCA, PICA, SPLIT

◆ Lower TPS Life Cycle Costs

- TPS Health Monitoring Techniques - ARC, KSC, & Industry Partners
 - Remote scanning with distributed passive sensors
- Organo-ceramic Materials - ARC
 - QUIC-Fix, QUIC-Stick, QUIC-TUFI
- Higher-Temperature Felts - ARC
- Integral Cryogenic Insulation / TPS - ARC, MSFC

Space Transportation Technology Workshop - Airframe Section

Recent or Emerging Technologies, ctd.

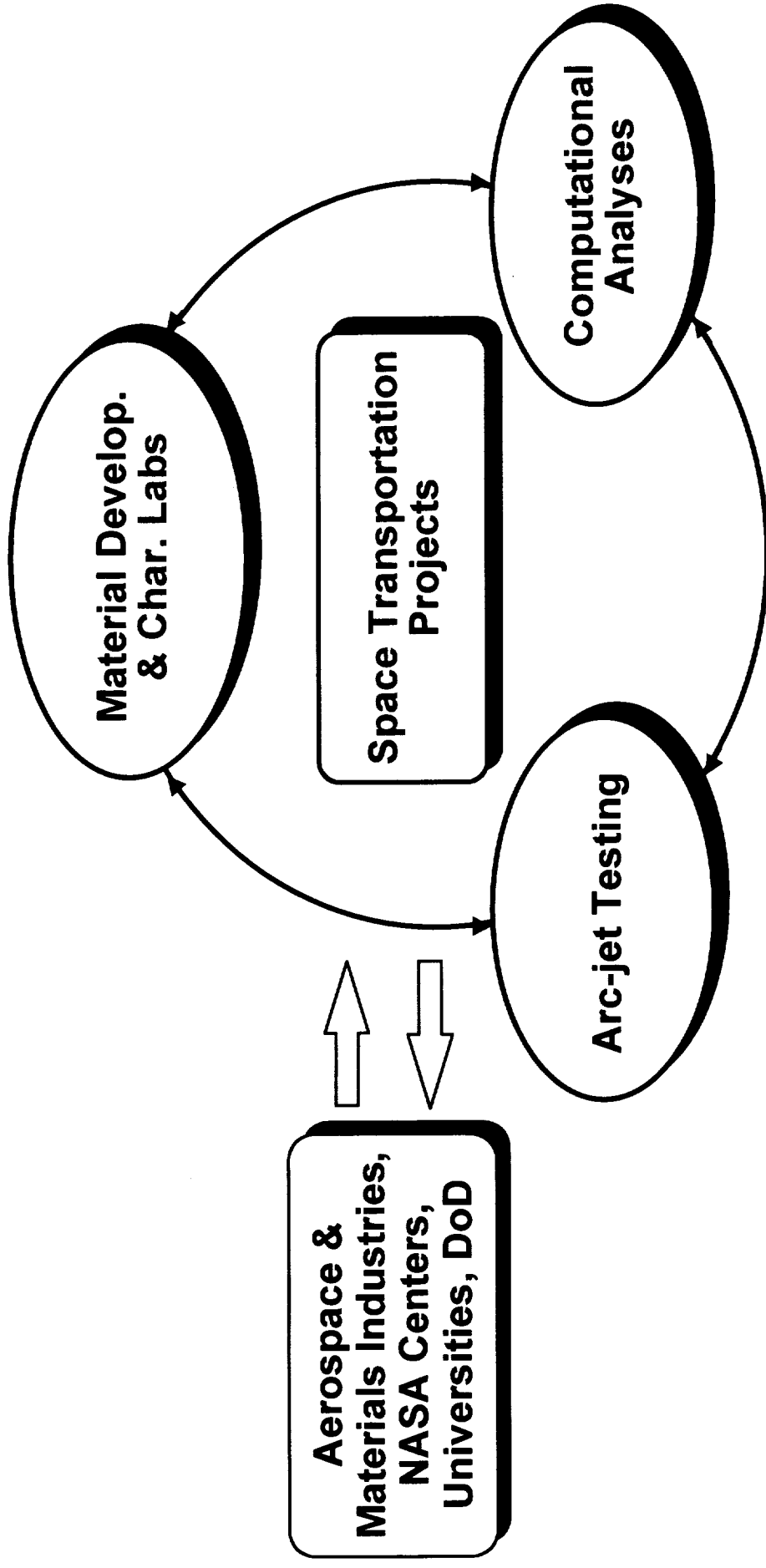

A Synergistic, Multidisciplinary Approach, Combining National Arc-jet Facilities, Material Development Labs, and Analysis Capabilities
Extensive Industry Interaction, Collaboration and Technology Transfer

Space Transportation Technology Workshop - Airframe Section

TPS Development Approach

- ◆ **Materials Development & Characterization Laboratories**
 - *ARC, GRC, JSC, LaRC*
 - Material Processing & Optimization
 - Material Structure Analysis
 - Thermo-mechanical Properties
 - Thermo-chemical Stability
 - Optical Properties
 - Heat Transfer Properties

- ◆ **Modeling - ARC, GRC, LaRC**
 - Vehicle Flow Environments, Aerodynamic & Aerothermal Predictions
 - TPS Material Response Analysis & Sizing
 - Ground Test Facility Flow Characterization for Optimal Testing
 - Test Model Design Optimization
 - Post-test Data Analysis & Interpretation

<http://tpsx.arc.nasa.gov>

- ◆ TPSX is an engineering design tool that provides material property and performance data on a variety of thermal protection system materials.
- ◆ TPSX contains data on over 500 materials and allows users to search, display and output the information in several formats .
- ◆ TPSX is available as a downloadable Windows program and on the Web.
- ◆ TPSX has nearly 1000 registered users and the web site receives ~1200 hits per week.

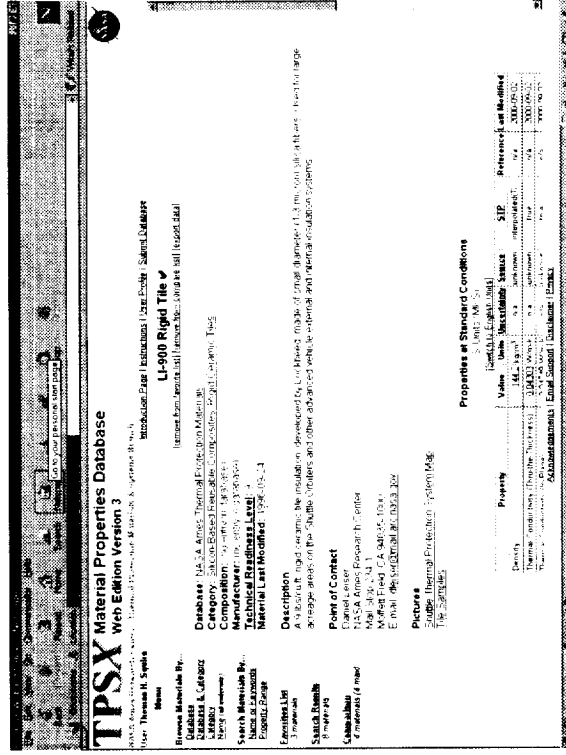

TPSX Web Edition

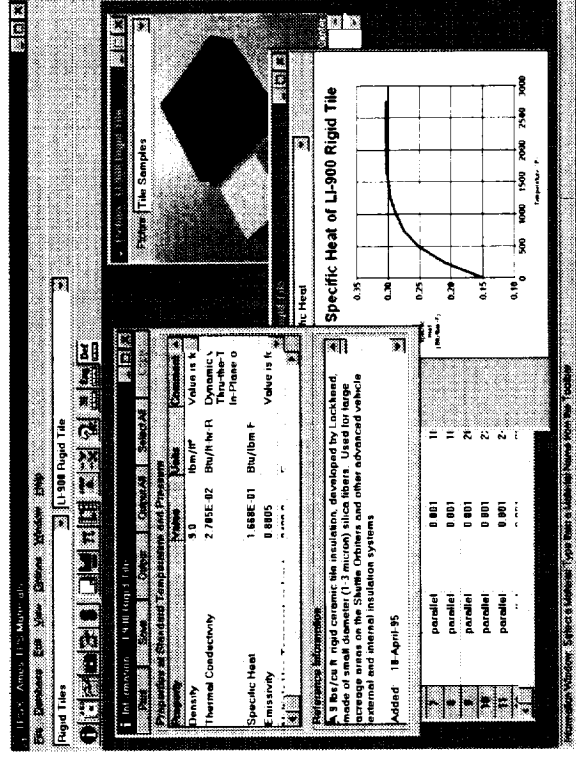

TPSX Windows Program

Space Transportation Technology Workshop - Airframe Section

Thermal Protection Systems Expert & Material Property Database

- ◆ **Arc Jets**
 - ARC, JSC
- ◆ **Radiant Heating Facilities**
 - ARC, JSC
- ◆ **Wind Tunnels**
 - ARC, LaRC, MSFC
- ◆ **Aircraft-based Testbeds**
 - DFRC
- ◆ **Impact Durability Assessment**
 - ARC
- ◆ **Vibro-acoustic Facilities**
 - ARC, LaRC

INTEGRATED AIRFRAME DEMONSTRATIONS



David E. Glass and J. Wayne Sawyer
NASA Langley Research Center

Tel: (757) 864-5423

d.e.glass@larc.nasa.gov

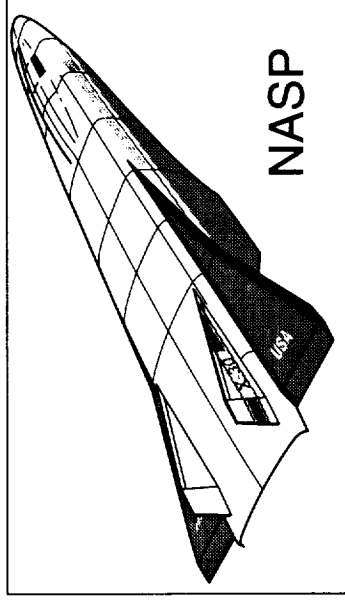
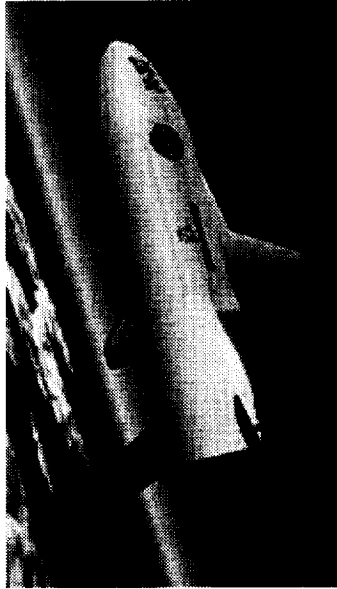

Space Transportation Technology Workshop

- Evolution of technology
 - Increase heat flux/temperature capability
 - Decrease cost, complexity and weight
 - Increase size

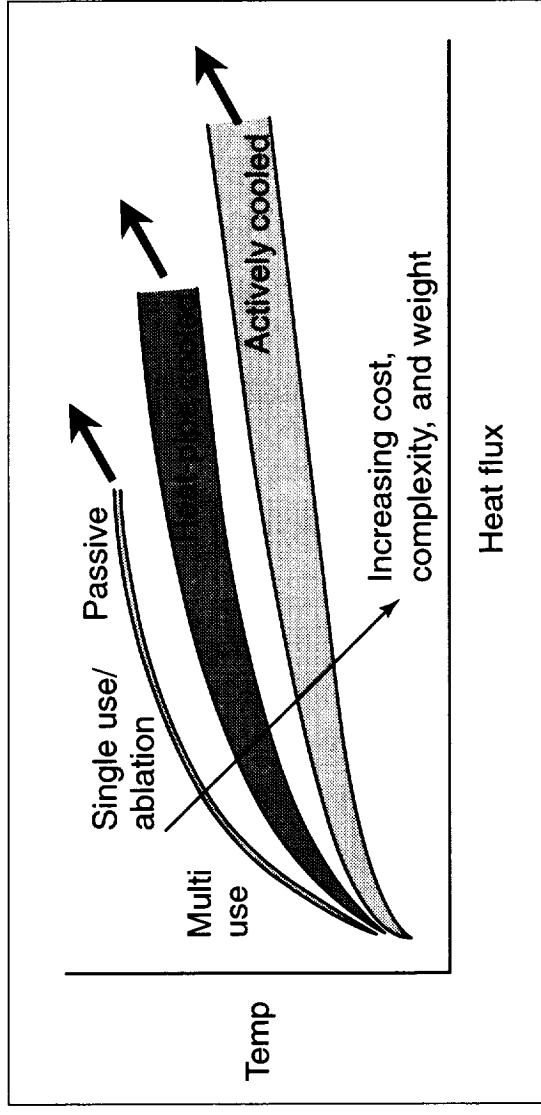

- Control surfaces
 - Accomplishments and status
 - C/C elevon (NASP)
 - Ruddervator and flaperon (X-37)
 - Next step
 - Full size orbiter body flap

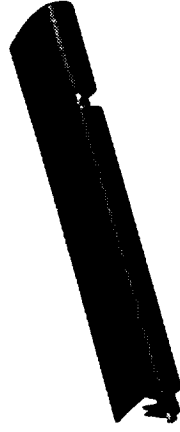

- Heat-pipe-cooled leading edges (HPCLE)
 - Accomplishments and status
 - Metallic (Shuttle)
 - C/C (NASP)
 - Next step
 - C/C HPCLE segment for radiant heating test and orbiter flight experiment

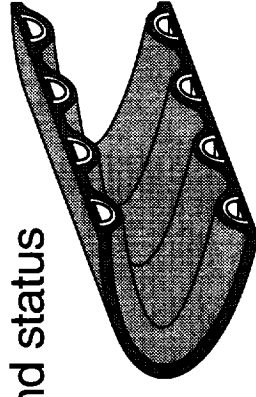

Space Transportation Technology Workshop

HOT STRUCTURE COMPONENTS FOR POTENTIAL FLIGHT DEMO

- Objective
 - Develop and verify the technology required for application of minimal weight control surfaces that meet NASP vehicle requirements
- Approach
 - Develop design and fabrication concepts
 - Verify concept design through sub-component fabrication and tests
 - Design and fabricate full-scale segment of C/C control surface
 - Verify design and fabrication technology by thermal/structural tests
- Payoff
 - Vehicle enabling
 - Reduced structural weight

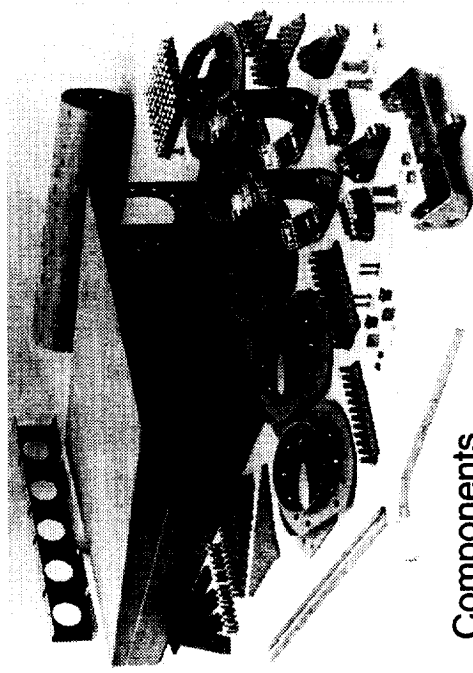

Components

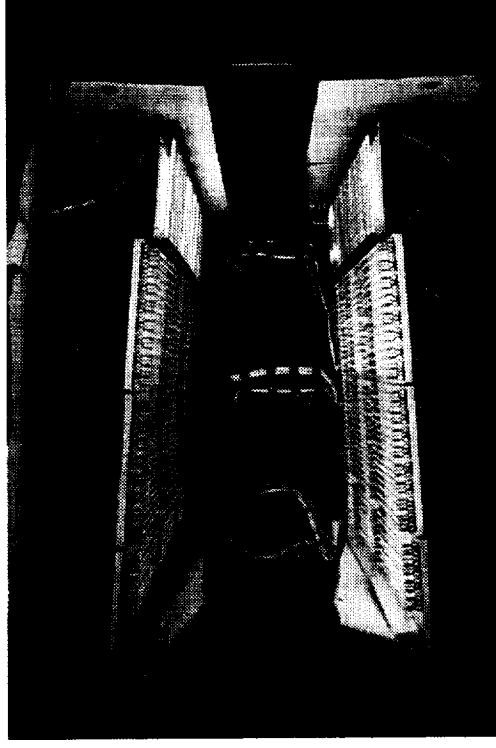

Space Transportation Technology Workshop

CONTROL SURFACES C/C CONTROL SURFACE FOR NASP

- Objectives
 - Develop and validate C/SiC control surfaces for the X-37
 - Deliver 2 flight approved flaperons and 2 moveable ruddervators for installation on the flight vehicle

- Team members
 - LaRC - lead
 - Boeing - requirements
 - BF Goodrich - C/SiC fabrication
 - MR&D - consultant
 - AFRL - test

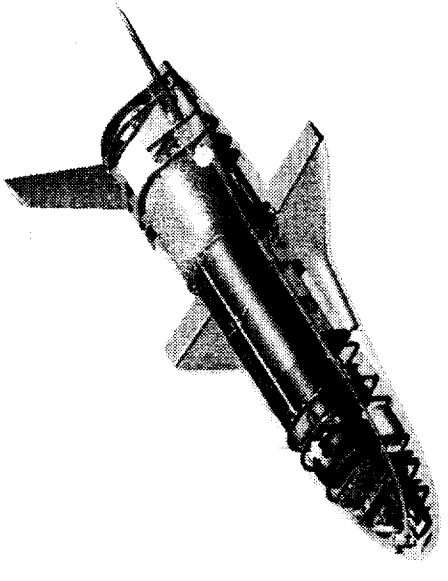
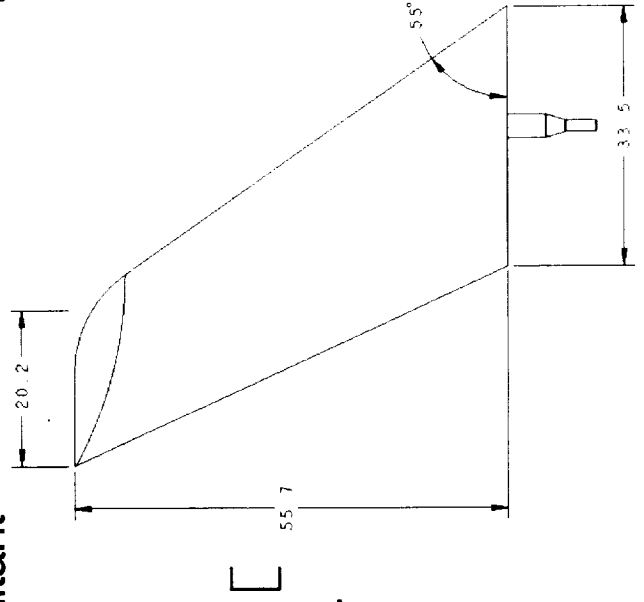
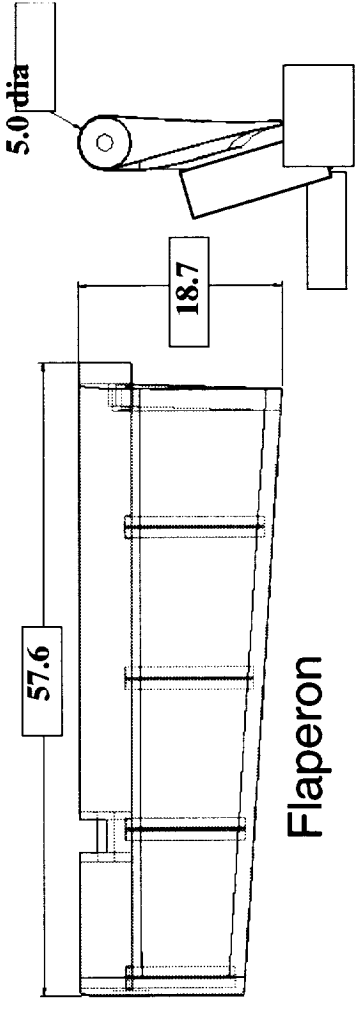

Space Transportation Technology Workshop

CONTROL SURFACES X-37 FLIGHT COMPONENTS

- Material property and sub-element (RT - 2800°F)
- Subcomponent (RT)
- Full scale thermal/structural test component
- Proof test of flight article (RT)

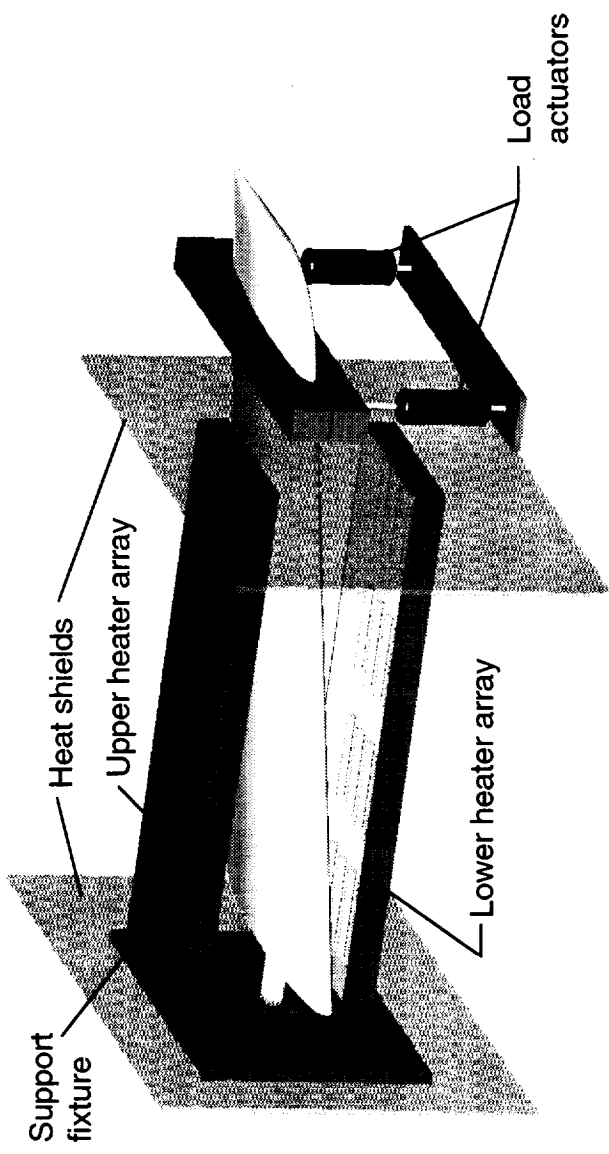

Schematic diagram of ruddervator thermal/structural test at AFRL

Space Transportation Technology Workshop

CONTROL SURFACES X-37 FLAPERON AND RUDDERVATOR VALIDATION

- Status
 - Design, analysis, and fabrication validated through thermal/structural tests and analysis of large full-scale segment of C/C control surface for NASP
 - Design, analysis, and fabrication will be validated through thermal/structural tests and analysis and through flight of small full-scale flaperons and ruddervators for the NASA/Boeing X-37 vehicle and small full-scale body flap for the X-38 vehicle
- Issues
 - Validation of major load bearing structural joints in C/C or CMC structures
 - Technology required for the fabrication of large multi-part components using C/C or CMC materials
 - Life cycle performance of large hot structures components



Hot Structures Control Surfaces

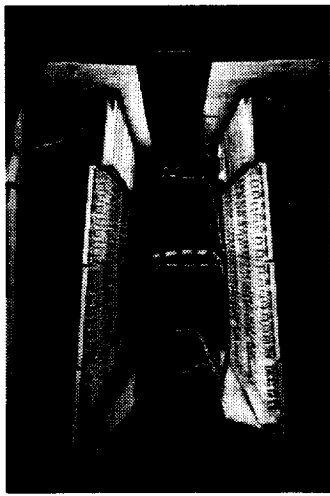

C/C control surface for NASP

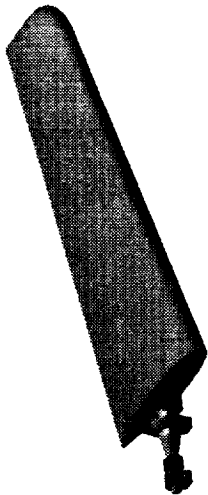

Ceramic matrix composite flap for X-37

- **Phase I**
 - Design concepts developed
 - Fabrication plan developed
 - Sub-component test articles designed
- **Phase II**
 - Sub-component test articles fabricated
 - Design/fabrication validated through sub-component analysis and tests
 - Full-scale component (shuttle or RLV size) design developed
- **Phase III**
 - Full-scale control surface fabricated
 - Design/fabrication validated through thermal/structural analysis and tests
 - Flight test

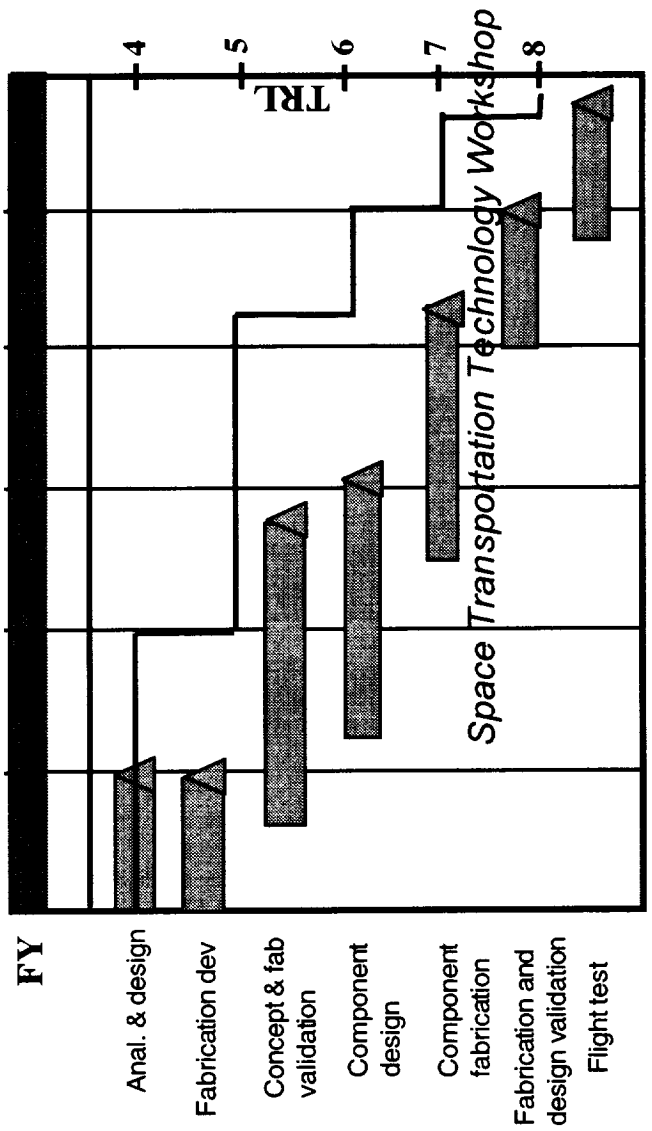

- **Current State of the Art**
 - Aluminum or low-temperature composite structure with ceramic tile TPS
- **Performance Metrics**
 - Reduced weight, more durable and less maintenance and operating costs than current Space Shuttle control surfaces
- **Potential risks**
 - Higher initial cost
- **Participants**
 - LaRC, DFRC, industry

- Design and fabricate large full-scale C/C or CMC control surface component for Space Shuttle or RLV size vehicle

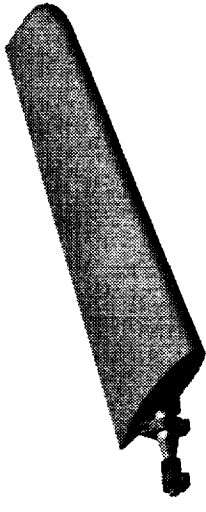

- Validate the design and fabrication procedure through static thermal/structural tests and analysis

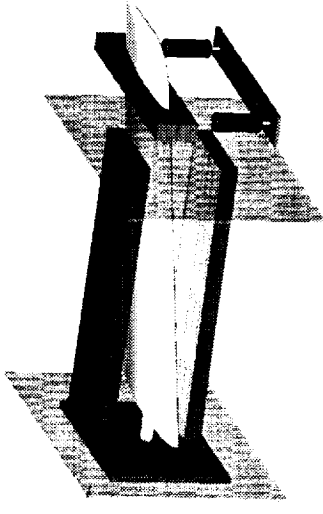

- Evaluate life-cycle performance through simulated multi-reentry thermal/structural load cycles



- Flight test on Space Shuttle or RLV size vehicle

Space Transportation Technology Workshop

CONTROL SURFACES POTENTIAL TASKS FOR FLIGHT DEMO

- ◆ 12:45 - 1:00 Introduction 2nd Gen RLV Airframe S. Welch
- ◆ 1:00 - 1:20 Airframe Design and Integration S. Scotti
- ◆ 1:20 - 1:40 Aerothermodynamics C. Miller
- ◆ 1:40 - 2:00 Structures and Materials T. Johnson
- ◆ 2:00 - 2:20 Tanks D. Smith
- ◆ 2:20 - 2:40 Thermal Protection Systems M. Rezin
- ◆ 2:40 - 3:00 Integrated Airframe Demonstrations D. Glass

- ◆ 3:00 - 3:05 BREAK

- ◆ 3:05 - 3:30 Introduction 3rd Gen RLV Airframe D. Bowles
- ◆ 3:30 - 3:55 Integrated Design and Analysis T. Gates
- ◆ 3:55 - 4:20 Integrated Thermal Str. & Materials B. Jensen
- ◆ 4:20 - 4:45 Thermal Protection Systems S. Johnson

3rd Gen Airframe/TPS:

3rd Generation Agenda

FY01 and Beyond Program Plan

POC: Dave Bowles
3rd Gen Airframe Program Manager
(757) 864-3095
d.e.bowles@larc.nasa.gov

3rd Gen Airframe/TPS:

3rd Generation Airframe Technologies

◆ **Project Scope:**

- Develop and demonstrate 3rd generation airframe technologies that provide significant reductions in cost of space transportation systems while dramatically improving the safety and higher operability of those systems.

◆ **Supports Goal 9**

- Earth-to-Orbit (Goal 9): Conduct research and technology development and demonstrations which will enable U.S. industry to increase safety by four orders of magnitude (loss of vehicle/crew probability less than 1 in 1,000,000 missions) and reduce costs by two orders of magnitude (\$100's per pound) within 25 years.

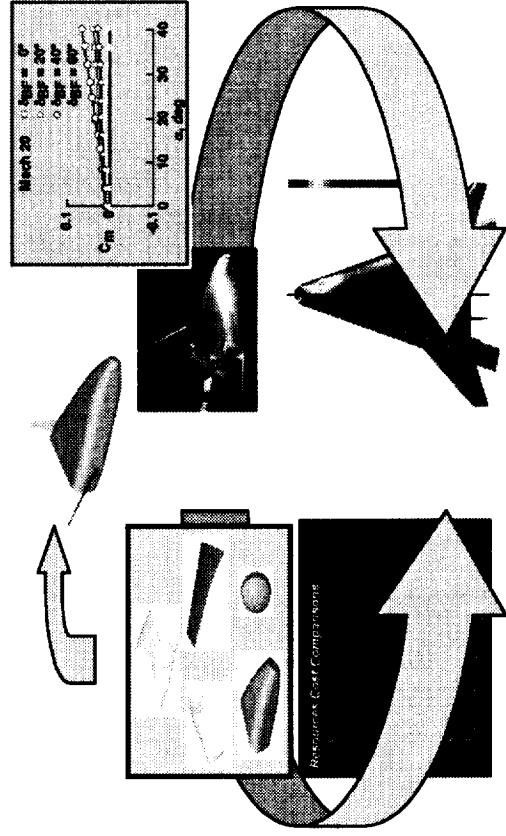

Integrated Airframe Design
(LaRC Lead)

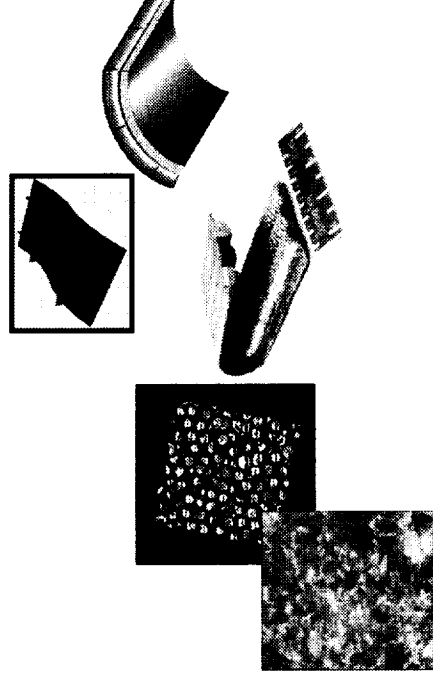

Int. Thermal Structures & Materials
(LaRC Lead)



Thermal Protection Systems
(ARC Lead)

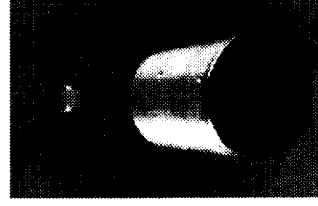

Aero/Aerothermo Enhancement
(LaRC Lead, No FY00 Funding)

3rd Gen Airframe/TPS:

Airframe Technology Elements

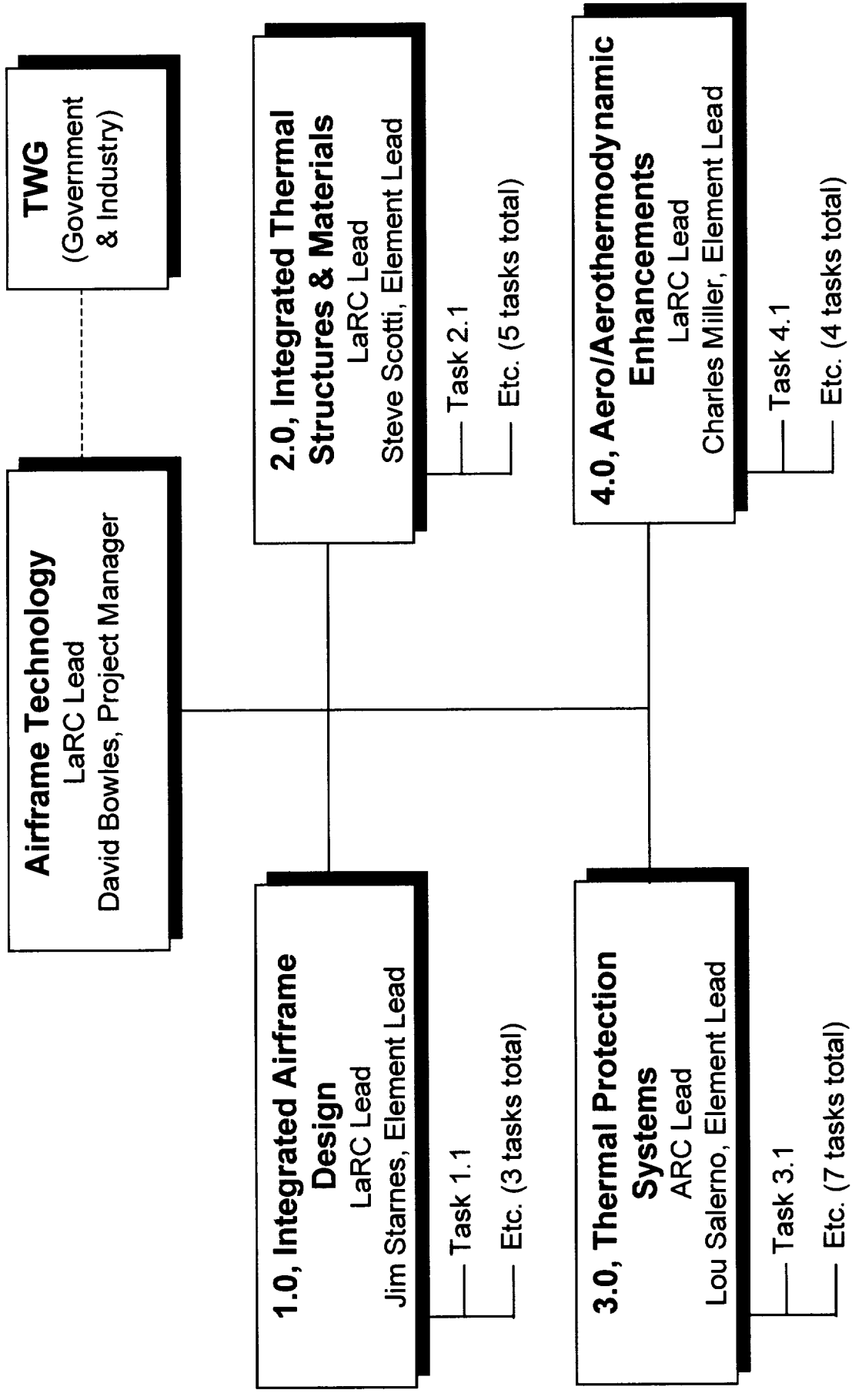

3rd Gen Airframe/TPS:

Airframe Organization and WBS

- ◆ **Integrated Design & Analysis**
 - Dr. James H. Starnes
 - (757) 864-3168
 - j.h.starnes@larc.nasa.gov
- ◆ **Integrated Thermal Structures & Materials**
 - Dr. Stephen J. Scotti
 - (757) 864-5431
 - s.j.scotti@larc.nasa.gov
- ◆ **Thermal Protection Systems**
 - Dr. Louis J. Salerno
 - (650) 604-318
 - lsalerno@mail.arc.nasa.gov
- ◆ **Aero/Aerothermodynamic Enhancements**
 - Dr. Charles G. Miller
 - (757) 864-5221
 - c.g.miller@larc.nasa.gov

3rd Gen Airframe/TPS:

Element Lead Contact Information

1. **Dave Bowles (Acting Chair), Project Manager, LaRC**
2. **Jim Starnes, Integrated Airframe Design Element Lead, LaRC**
3. **Steve Scotti, Integrated Thermal Structures and Materials Element Lead, LaRC**
4. **Lou Salerno, Thermal Protection Systems Element Lead, ARC**
5. **Charles Miller, Aero/Aerothermal Enhancement Element Lead, LaRC**
6. **Frances Hurwitz, GRC**
7. **Pete Rodriguez, MSFC**
8. **Jason Hatakeyama, Boeing**
9. **Derek Townsend, Lockheed Michoud**
10. **Ravi Deo, Northrup-Grumman**
11. **Mike Stropki, DoD (alternate Dan Cleyrat)**
12. **Tom Dragone- OSC**
13. **Roger Kimmel, DoD**

Ex-Officio:

1. **Marshall Merriam ARC**
2. **Partha Dasgupta, GRC**
3. **Gaspere Maggio, SAIC**

TWG Scope

- ◆ **Government and Industry participants**
- ◆ **Primary responsibilities**
 - Review technical progress and results (annual?)
 - Recommend technical priorities
 - Foster coordination with industry and other government agencies

3rd Gen Airframe/TPS:

Technical Working Group (TWG)

3rd Gen Airframe/TPS:

Top Level Budget Summary

3rd Gen Airframe/TPS:

Task Structure and Leads

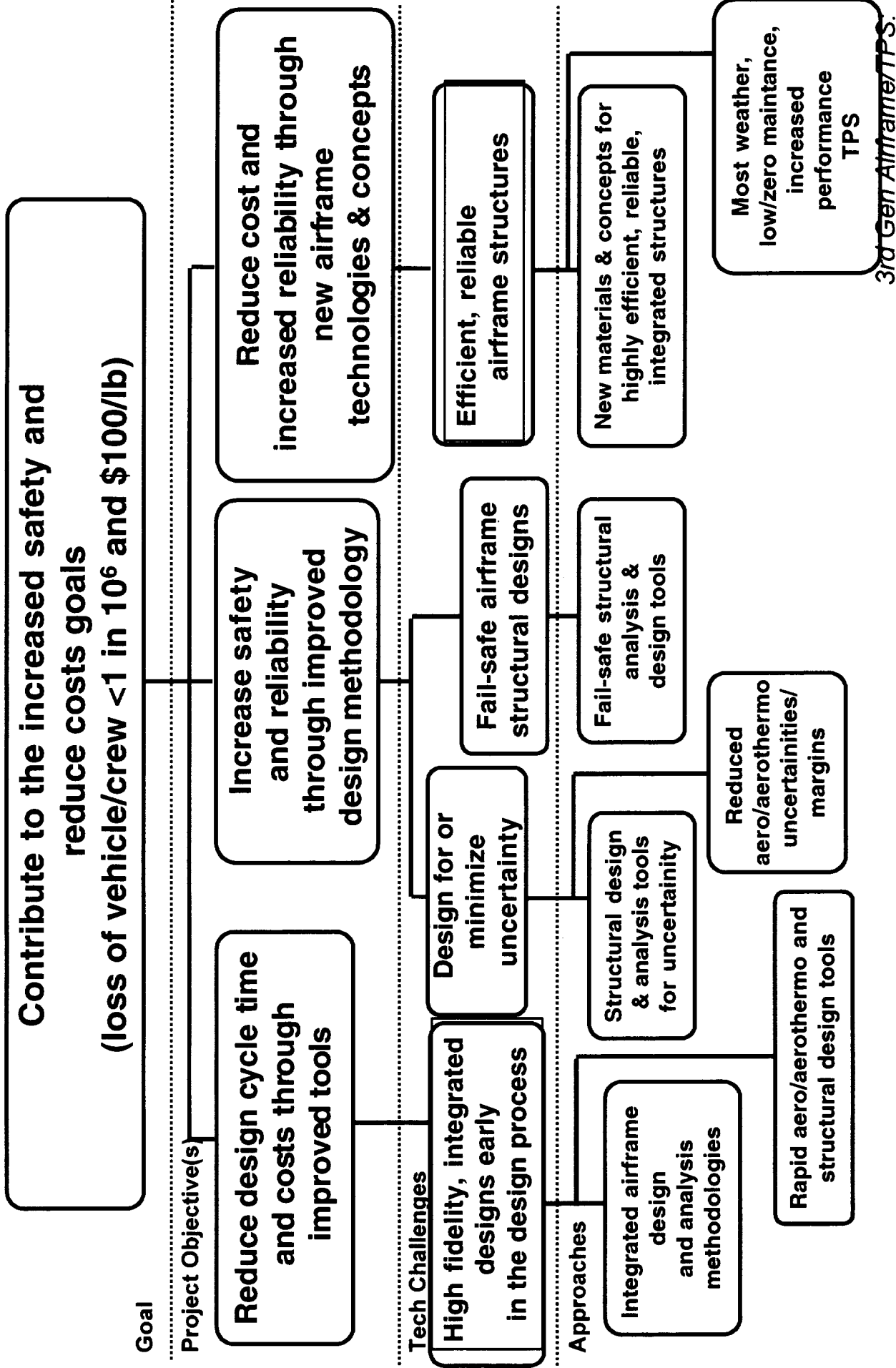

Goals, Objectives, Challenges, Approaches

3rd Gen Airframe/TPS

- ◆ **Goal:**
 - **Reduced Cost (\$100/lb)**
 - **Increased Safety (LOC/LOV 1 in 10⁶)**
- ◆ **Challenge:**
 - **How to meet both simultaneously?**
- ◆ **Strategy:**
 - **Requires paradigm change**

Conventional Paradigm: **New Paradigm:**

Cost ↓ Safety ↓ Cost ↓ Safety ↑

- **Paradigm change achieved by**

Inherent Reliability through Robust Designs

Advanced Airframe Technologies Allow Robust Designs at Reduced Weights

- ◆ ***High fidelity, reliability based analysis and design methodologies***
- ◆ ***Advanced materials and structural concepts***

3rd Gen Airframe/TPS:

Strategy for Meeting the Goals

Major Milestones

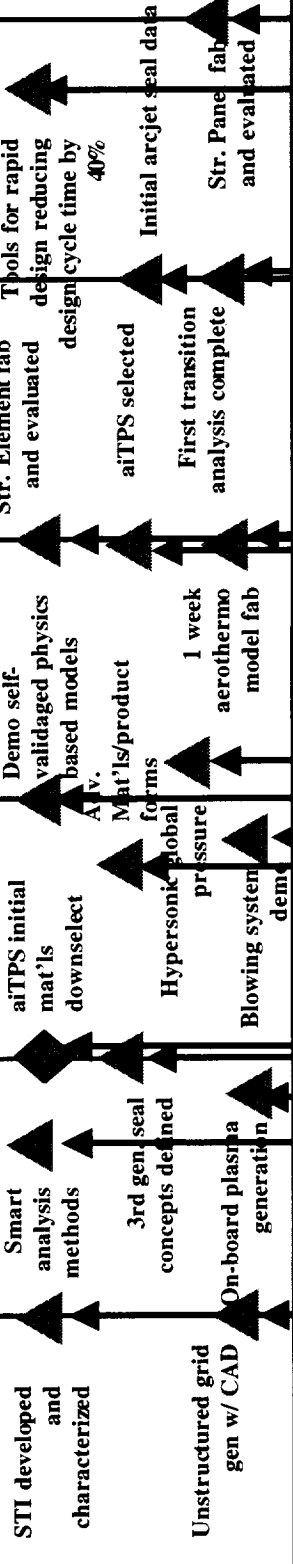

● Component/
Subsystem
Demo

● Systems /
Integrated
Demo

▭ Flight Demo

▭ DoD Activity

▬ Overguideline

Continuing synergy with AVSTPO, DoD, and other Programs

3rd Gen Airframe/TPS:

Project Roadmap

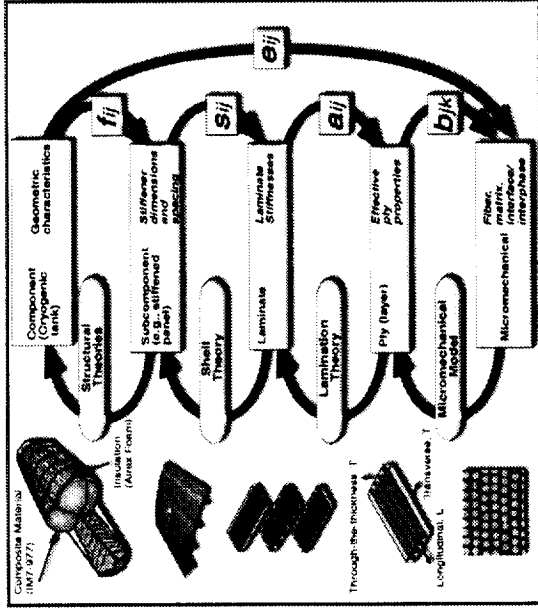

- ◆ **Goals**
 - Contribute to 100x cost reduction and 10, 000x safety improvement goals
- ◆ **Objectives**
 - Develop integrated airframe design and analysis technologies to reduce design cycle time by 40% and design cost
 - Develop verified fail-safe structures design and analysis technologies that increase the reliability by an order of magnitude and increase performance

- Integrated advanced design and analysis methods that reduce design cycle time
- Airframe structural design and analysis methods that relate risk, cost and performance
- Verified fail-safe structural design and analysis methods that increase reliability

- ◆ **Major FY01 / 02 Products**
 - Parametric studies to identify key parameters (9/01)
 - Develop “smart” analysis methods that can automatically account for uncertainties (9/02)
- ◆ **Major FY03 - 06 Products**
 - Develop high-fidelity physics-based analysis methods for predicting coupled thermal-structural response (9/03)
 - Structural design and sizing for residual strength (9/04)
 - Rapid, hierarchical analysis (9/06)

3rd Gen Airframe/TPS:

Integrated Airframe Design

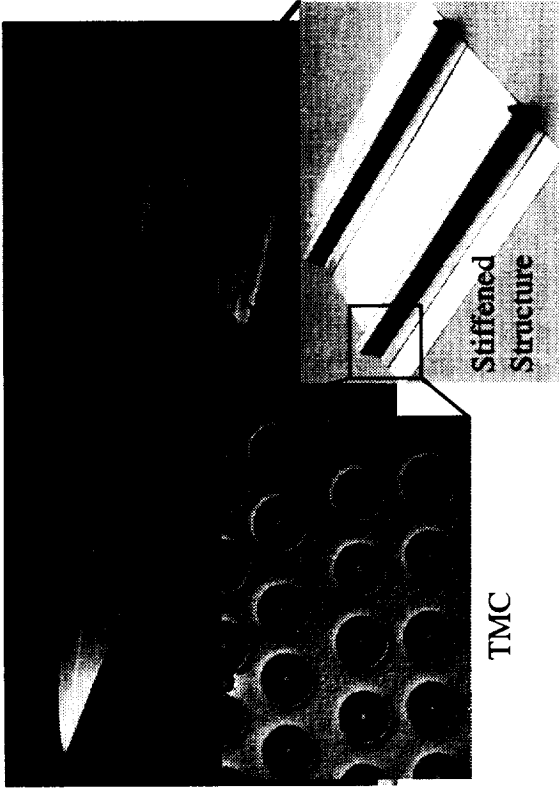

- ◆ **Goals**
 - Contribute to 100x cost reduction and 10, 000x safety improvement goals
- ◆ **Objectives**
 - Efficient and reliable hot wing structures with low maintenance and fabrication costs
 - Efficient and reliable conformal cryotank structures with low maintenance and fabrication costs

- Ultra-high properties over extended temperature ranges for both hot wing and conformal cryotank structures
- Large-scale fab of structures into high-efficiency/reliable/functional component hardware for both hot wing and conformal cryotank structures
- Thermal & thermal-structural concepts including control/accommodation of temperatures and thermal stresses

- ◆ **Major FY01 / 02 Products**
 - Select constituents and processes (9/01)
 - Advanced adhesives for non-autoclave processing (9/02)
 - MMC and Al-Mg-Be materials characterization (9/02)
- ◆ **Major FY03 - 06 Products**
 - Integrated airframe concepts defined and assessed (12/02)
 - TMC fiber/matrix interaction studies (9/03)
 - Advanced cryogenic insulation (9/03)
 - MMC and Al-Mg-Be cryogen compatibility (9/03)
 - Structural elements made of adv materials fab and evaluated (9/04)
 - Structural panels made of adv mat'ls (9/06)

3rd Gen Airframe/TPS:

Integrated Thermal Structures and Materials

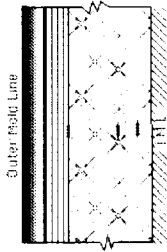
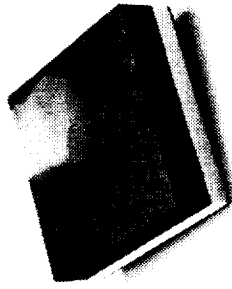

STI Exploits Embedded Phases of Nanostructural or Energy Transport Control Materials into Tiles, Blankets, and other TPS to isolate and control cryopumping, radiation, convection, and conduction

- ◆ **Higher temperature lower density systems**
- ◆ **Improved operating margins**
- ◆ **Fault tolerant systems**
- ◆ **Most weather capability**
- ◆ **Low/zero maintenance**

- ◆ **Goals**

- **Increased TPS safety, reliability, operability, and decreased cost**

- ◆ **Objectives**

- **Necessary ground development and characterization**
- **Development and demonstration of highly reusable TPS with extended life cycle capabilities, including most weather flight capability and fail-safe performance**
- **Assessment, simulation, and prediction of TPS degradation and failure**

- ◆ **Major FY01 / 02 Products**

- **Superthermal Insulation materials development and characterization (9/01)**
 - **Initial aiTPS materials downselection (9/02)**
 - **3rd gen seal concepts defined (9/02)**
- ◆ **Major FY03 - 06 Products**
 - **Completed initial arcjet testing of seal concepts (9/05)**
 - **MITAS graded layer systems for mechanical/thermal test (9/06)**

3rd Gen Airframe/TPS:

Thermal Protection Systems

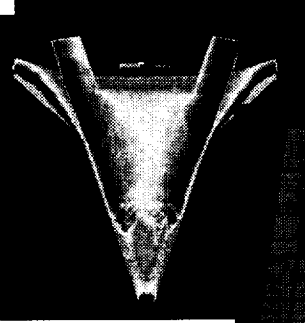

◆ **Goals**

- Contribute to 100x cost reduction and 10, 000x safety improvement goals

◆ **Objectives**

- Reduce time for aero/aerothermo design of aerospace vehicles (factor of 20 by 2010)
- Reduce aero/aerothermo uncertainties/margins and enhanced performance by 10x

- ◆ Decrease ground-based facility testing time by a factor of 20
- ◆ Develop aerothermo multidisciplinary techniques
- ◆ Decrease CFD prediction times by a factor of 30
- ◆ Determination and control of boundary layer transition
- ◆ Flow control or modification of flow environment

◆ **Major FY01 / 02 Products**

- Unstructured grid generation with CAD (10/01)
 - Low shrinkage metal model casting (12/01)
- ◆ **Major FY03 - 06 Products**
- High resolution image acquisition (12/02)
 - Automated 3-D image mapping software (12/03)
 - 1 week aerothermo model fab (9/04)
 - First transition analysis complete(12/05)
 - Tools for rapid design reducing design cycle time by 40% (6/06)

3rd Gen Airframe/TPS:

Enhanced Aero/Aerothermo

- ◆ **Varies across elements and tasks**
 - **University grants (existing and new)**
 - **Existing task assignment contracts**
 - **Specific RFPs ?**
 - **In-House (facilities, materials, equipment, PBC's, etc.)**

FY01 Funding Distribution (Net \$7.76M)

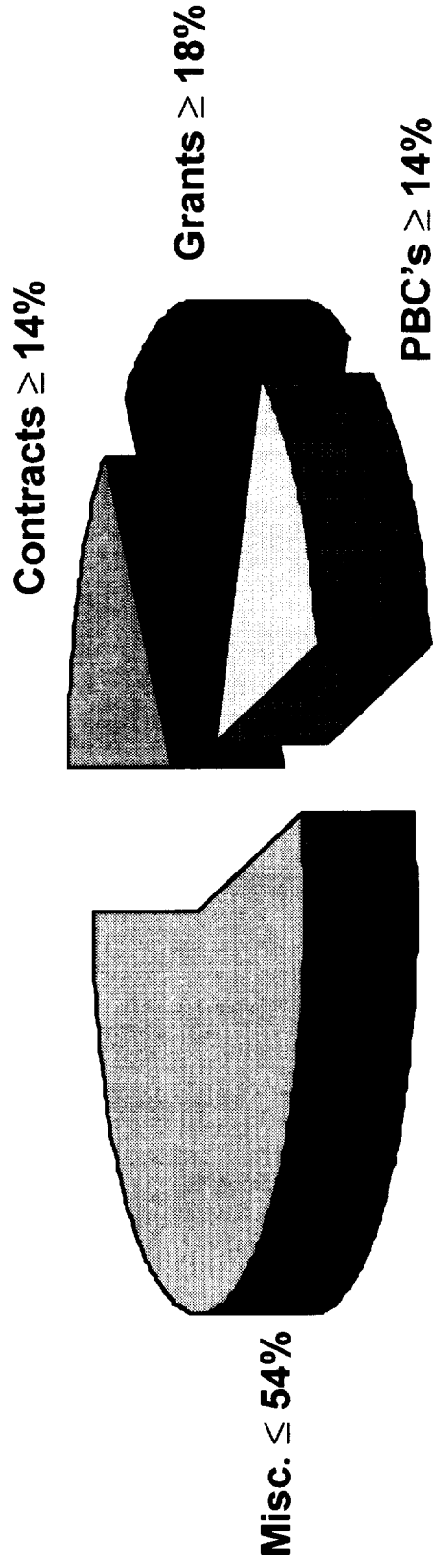

3rd Gen Airframe/TPS:

Acquisition Strategy

◆ Overall Project Level Risks

Objective: Develop and demonstrate 3rd generation airframe technologies that provide significant reductions in cost of space transportation systems while dramatically improving the safety and higher operability of those systems

- Risk:
 - Uncertainty in funding and budget reduction constraints
- Risk Mitigation Strategy:
 - Use Desclope plan within budget constraints
- Risk:
 - Lack of good systems analysis to identify technology cost/benefit trades
- Risk Mitigation Strategy:
 - Develop systems analysis to conduct cost/benefit trades
 - Utilize TWG to help set technology priorities
- Risk:
 - High risk technologies, all of which might not proceed as planned
- Risk Mitigation Strategy:
 - Use multiple technical approaches where feasible

3rd Gen Airframe/TPS:

Risk Management

- ◆ **Solid Technical Plan in Place**
- ◆ **Strong Intercenter Team (ARC, GRC, LaRC, MSFC)**
- ◆ **Looking Forward to Industry/Academia Input and Participation**

3rd Gen Airframe/TPS:

FY01 Summary Comments

◆ **Focus on those activities that will be continued/built upon in FY01**

◆ **Topics include**

- **Integrated Design and Analysis**
 - Damage Tolerance & Repair
 - Safe Structures Design Technology
- **Integrated Thermal Structures & Materials**
 - Resins for transfer molding or infusion processing
 - Nonautoclave processable adhesives
 - Automated Tape Placement Device with e-beam cure
- **Thermal Protection Systems**
 - Quick Processed, Low Cost Erosion Resistant TPS
 - SmartTPS
 - Advanced High Temperature Structural Seals
 - UHTC Sharp Leading Edges
 - High Temperature Felt TPS

3rd Gen Airframe/TPS:

FY00 Research Highlights

Integrated Design and Analysis Overview

Dr. Tom S. Gates
NASA Langley Research Center
(757) 864-3400
t.s.gates@larc.nasa.gov

3rd Gen Airframe/TPS:

Integrated Design and Analysis

◆ **PMC Damage Tolerance & Repair**

• **POC's:**

- Dr. Damodar R. Ambur
- (757) 864-3449
- d.r.ambur@larc.nasa.gov

- Dr. Tom S. Gates
- (757) 864-3400
- t.s.gates@larc.nasa.gov

◆ **Safe Structures Design Technologies**

• **POC:**

- Dr. Damodar R. Ambur, NASA LaRC
- (757) 864-3449
- d.r.ambur@larc.nasa.gov

3rd Gen Airframe/TPS:

Integrated Design and Analysis

PMC Damage Tolerance and Repair Goals & Objectives

- ◆ **Develop methodology for assessing the effects of manufacturing defects**
- ◆ **Develop damage tolerance criteria and damage tolerance database for RLV cryogenic tank structures**
 - **impact**
 - **pressure leakage**
 - **cryogenic permeation**
 - **validated damage prediction tools**
- ◆ **Develop repair technology**

PMC Damage Tolerance and Repair Current Program Status

- ◆ **Initiated in FY1999 as Bantam Damage Tolerance Program**
- ◆ **Continued as PMC Damage Tolerance Program during FY2000 with reduced funding level**
- ◆ **Needs continuation to address technology issues that will limit composites application to cryogenic tank structures**

3rd Gen Airframe/TPS:

Integrated Design and Analysis

PMC Damage Tolerance and Repair

Current Technical Status

- ◆ **FY1999:**
 - Established damage tolerance requirements (impact, pressure leakage, cryogenic permeation)
 - Fabricated and impact tested flat and curved thin-skin panels made of different material forms
 - Conducted impact damage tolerance tests for damage resistance and barely visible damage (BVD); developed a 0.05 in. dent depth BVID criterion
 - Developed analytical methods to predict the impact response and damage resistance for curved, thin laminated composites
- ◆ **FY2000:**
 - Assessed existing repair methods for stiffened-skin and sandwich constructions
 - Developed analysis methods for optimally sizing bolted and bonded anisotropic patch repairs
 - Completed compression-after-impact strength tests on three material forms
 - Developed analytical models and methods to assess the critical size of delaminations for combined loading conditions
 - Assessed mixed-mode fracture toughness for IM7/977-2 and AS4/PEEK material systems at cryogenic temperatures
 - Conducting pressure leakage threshold tests

3rd Gen Airframe/TPS:

Integrated Design and Analysis

PMC Damage Tolerance and Repair

ENERGY THRESHOLDS FOR BARELY VISIBLE IMPACT DAMAGE OF CURVED THIN LAMINATES MADE OF DIFFERENT MATERIAL FORMS

Criterion: 0.05-in. dent depth

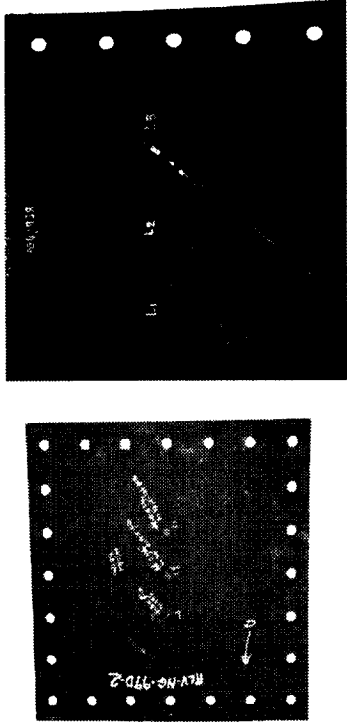

Pre-impregnated tape material

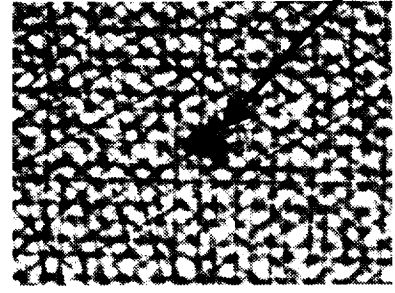
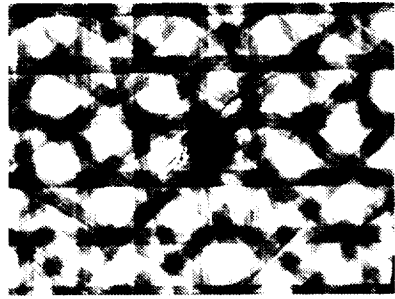

Graphite-glass intra-ply material

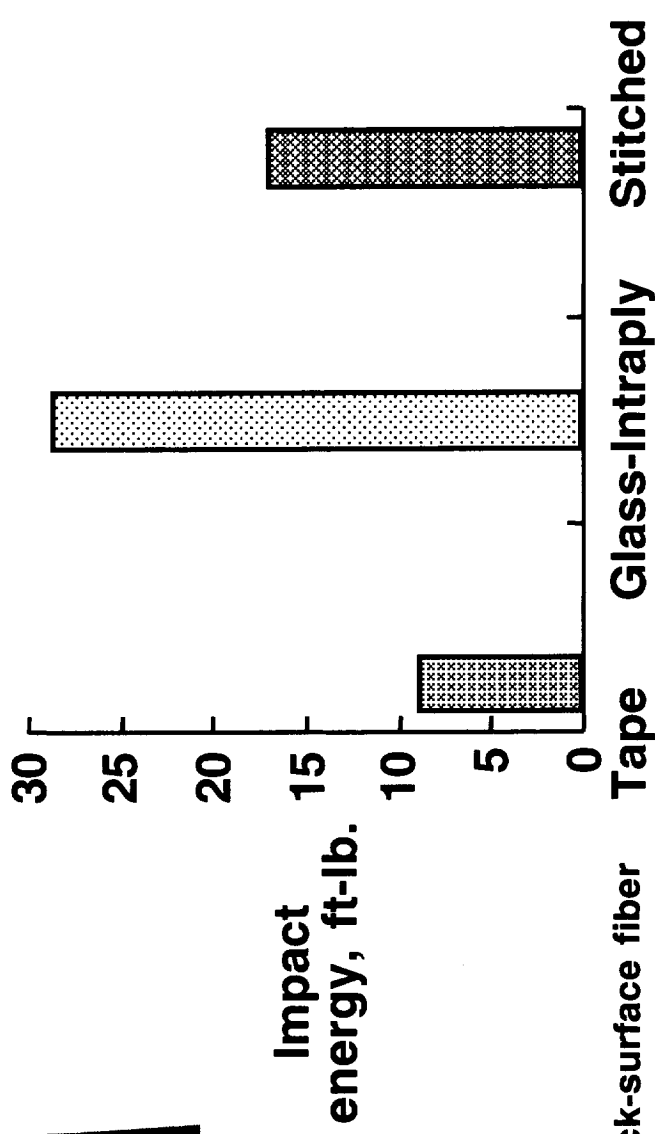

Back-surface fiber splitting

3rd Gen Airframe/TPS:

Integrated Design and Analysis

PMC Damage Tolerance and Repair

TYPICAL COMPRESSION RESPONSE AND FAILURE OF 16-PLY-THICK CURVED PLATES LOADED IN COMPRESSION

Displacement contour

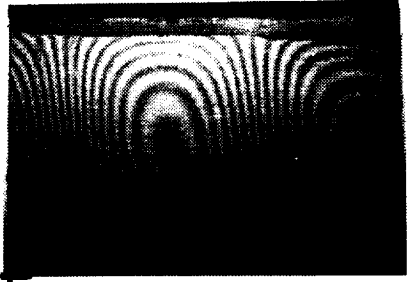

Undamaged

Failed specimen

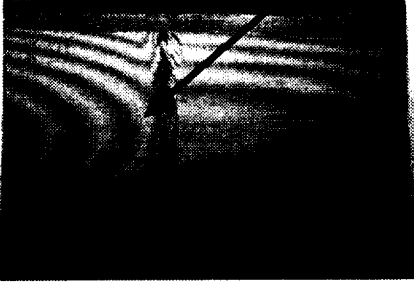

Failure location



Impact damaged

Impact damage location



3rd Gen Airframe/TPS:

Integrated Design and Analysis

PMC Damage Tolerance and Repair

COMPARISON OF COMPRESSION-AFTER-IMPACT STRENGTH RESULTS FOR CURVED THIN PLATES

AS4-3502 Prepreg Tape Material

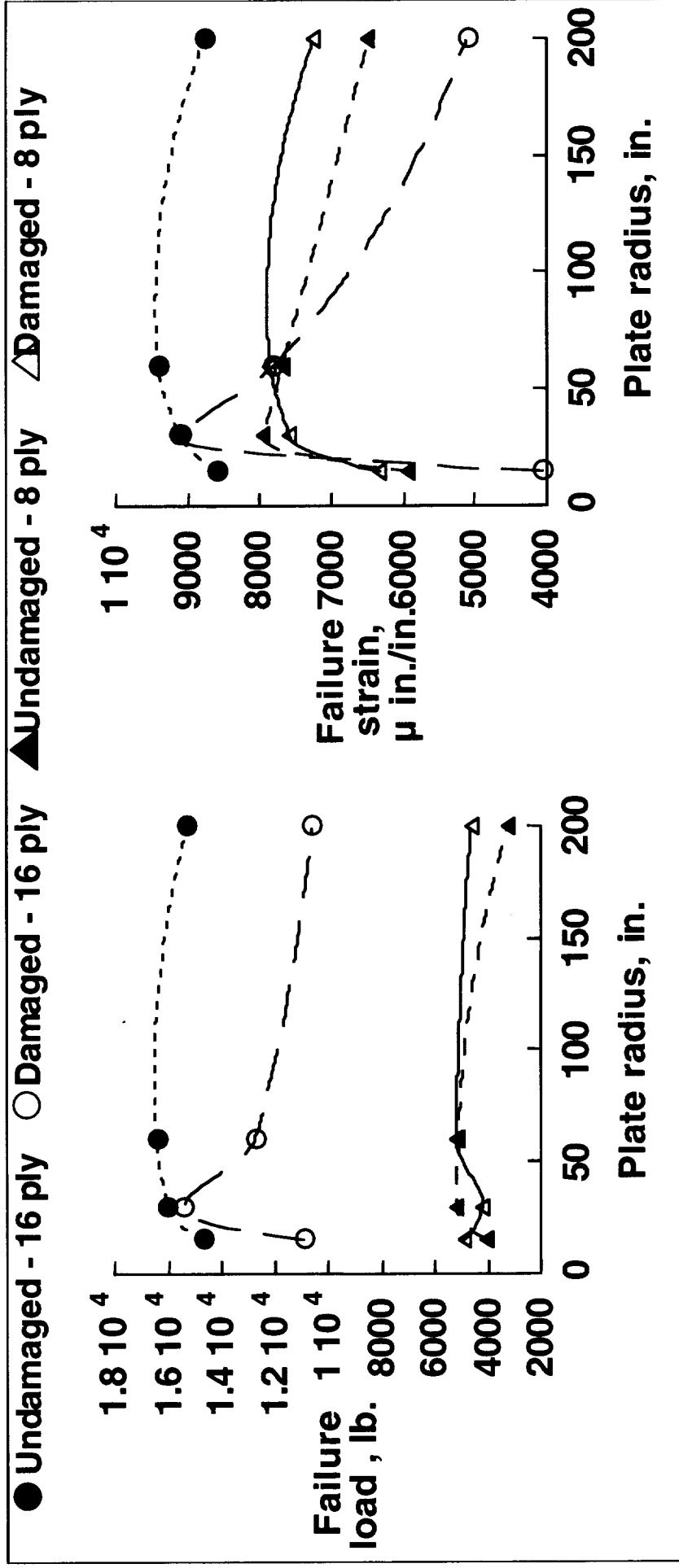

3rd Gen Airframe/TPS:

Integrated Design and Analysis

PMC Damage Tolerance and Repair

COMPARISON OF RESIDUAL STRENGTH RESULTS FOR PLATES SUBJECTED TO DROPPED-WEIGHT IMPACT AND STATIC INDENTATION DAMAGE

- 2.5 lb impactor, 10 in. by 10 in. plate size ○ Static indentation, 10 in. by 10 in. plate size
- 2.5 lb impactor, 9 in. by 5 in. plate size □ Static indentation, 9 in. by 5 in. plate size
- ▲ 2.5 lb impactor, 10 in. by 10 in. plate size △ Static indentation, 10 in. by 10 in. plate size

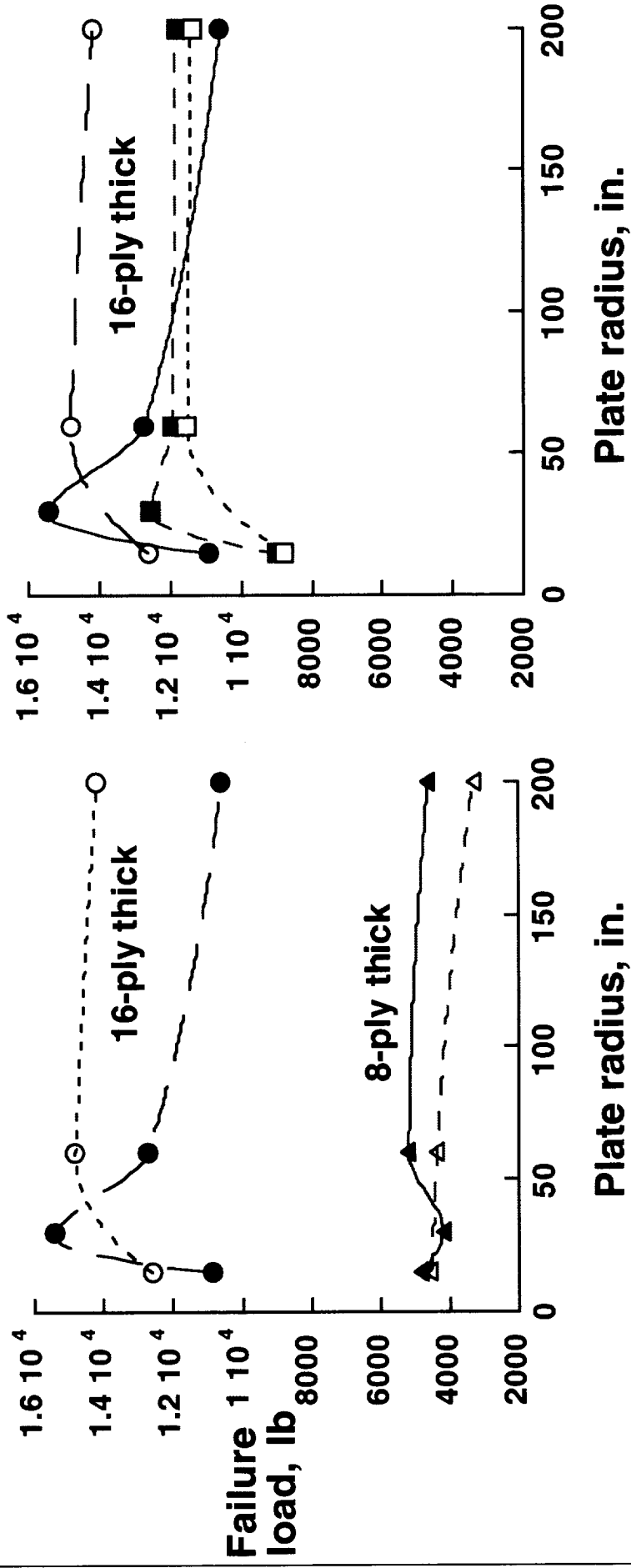

3rd Gen Airframe/TPS:

Integrated Design and Analysis

PMC Damage Tolerance and Repair

SCHEMATIC DIAGRAM OF TEST SET-UP FOR PRESSURE LEAKAGE TESTS

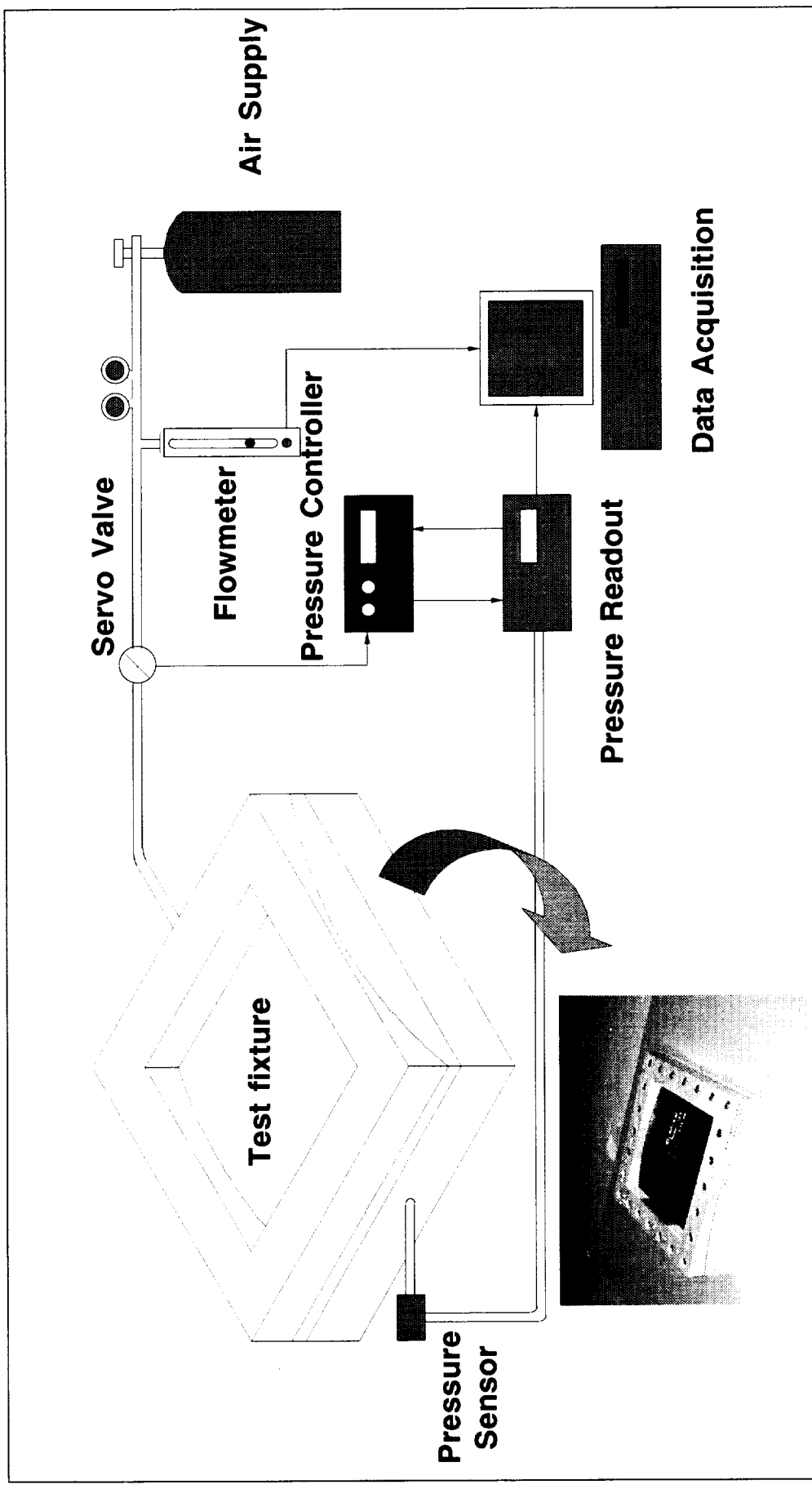

3rd Gen Airframe/TPS:

Integrated Design and Analysis

PMC Damage Tolerance and Repair

SUMMARY OF ANALYTICAL EFFORTS

- ◆ **Impact response of thin curved laminates**
- ◆ **Finite element analysis to assess critical manufacturing defect size for combined mechanical and thermal loaded structures**
- ◆ **Methods for optimizing bonded and bolted repairs**

3rd Gen Airframe/TPS:

Integrated Design and Analysis

PMC Damage Tolerance and Repair

DEVELOPED NONLINEAR ANALYSIS METHOD FOR ACCURATELY DETERMINING IMPACT RESPONSE AND DAMAGE INITIATION

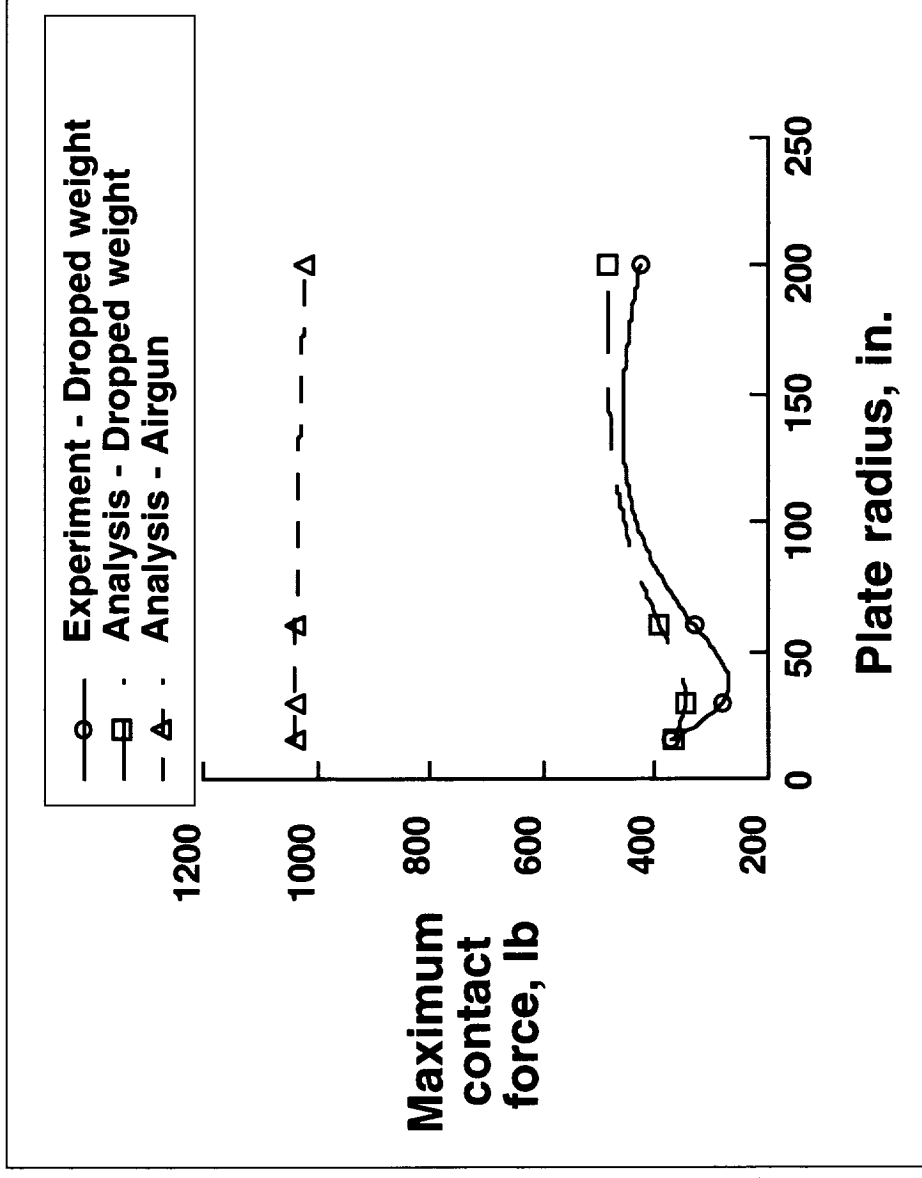

3rd Gen Airframe/TPS:

Integrated Design and Analysis

PMC Damage Tolerance and Repair

DELAMINATION GROWTH STUDIES

Modeling and Analysis Approach

Global model

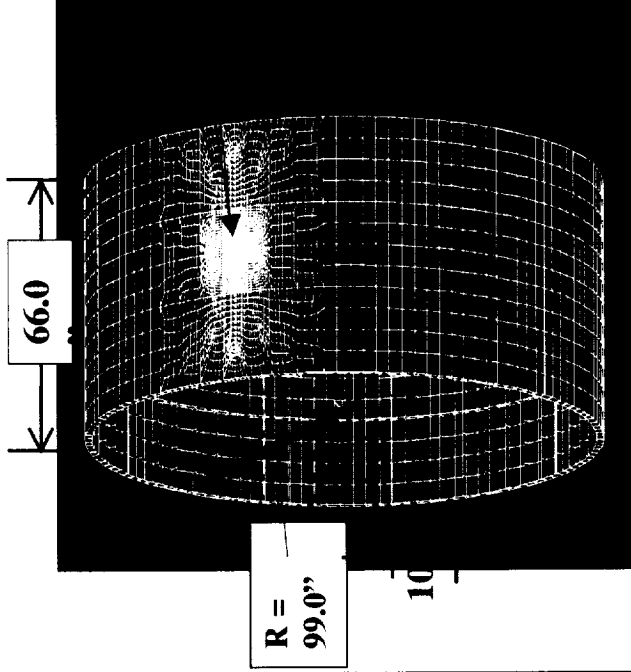

- Number of elements: 10,664
- Dof: 64,314

Local model

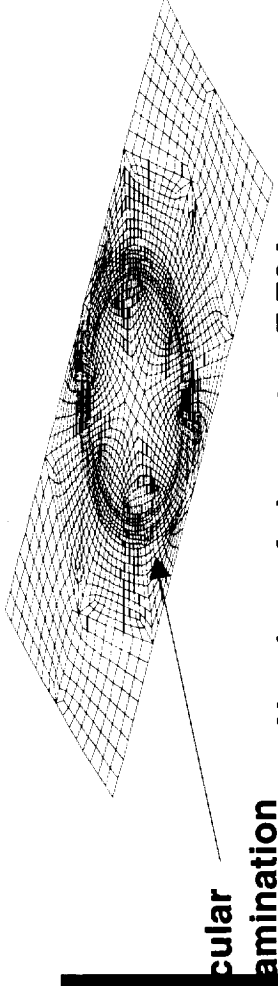

- Number of elements: 7,784
- Dof: 46,548

Virtual crack closure technique to determine strain energy release rates.
Parametric studies with combined mechanical, thermal and internal pressure loading conditions.

- Critical delamination size and location.
- Stiffened skin and sandwich constructions.

3rd Gen Airframe/TPS:

Integrated Design and Analysis

PMC Damage Tolerance and Repair

APPROACH FOR DELAMINATION GROWTH VERIFICATION TESTING

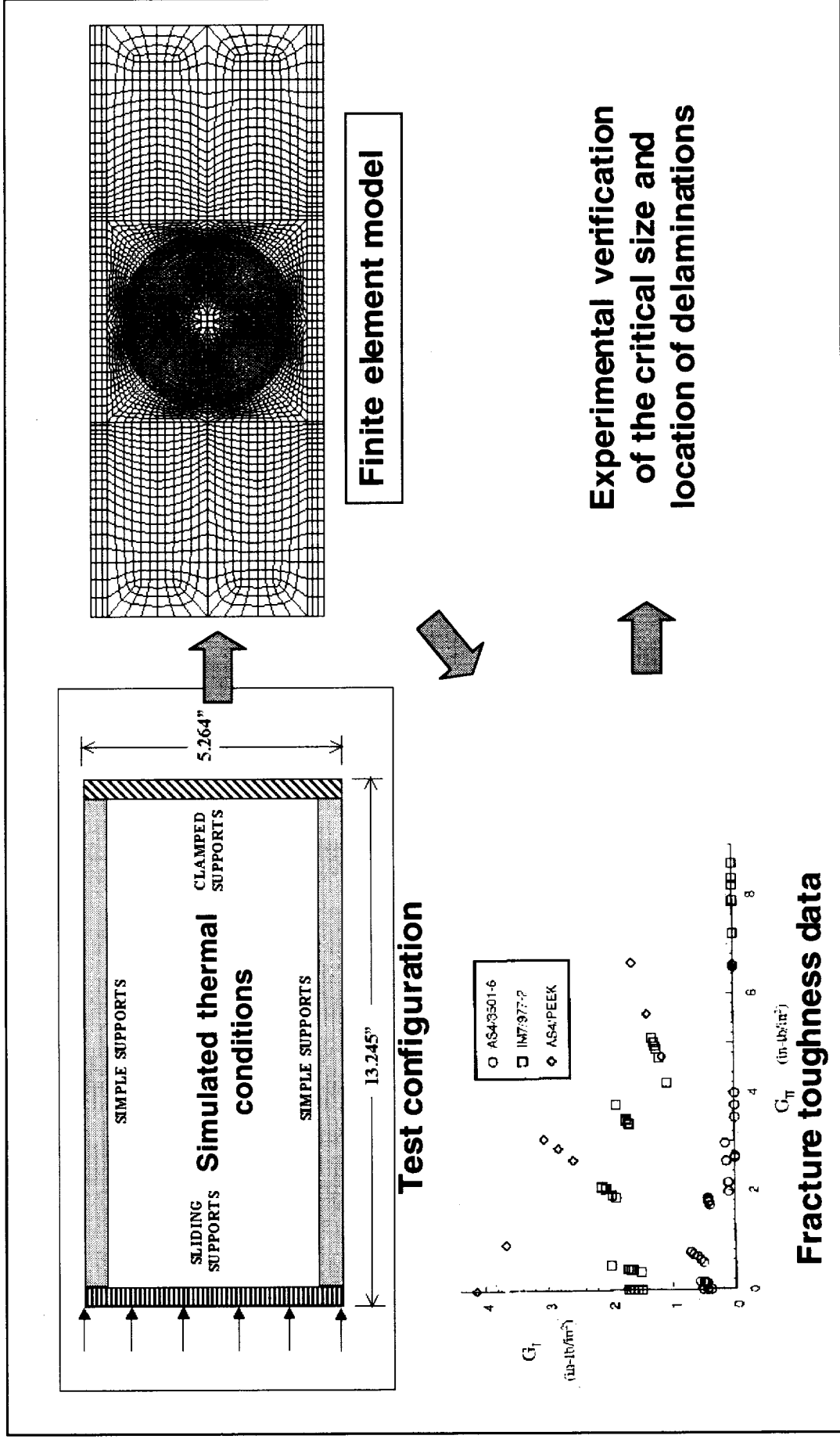

3rd Gen Airframe/TPS:

Integrated Design and Analysis

PMC Damage Tolerance and Repair

NEAR-TERM PLANS

- ◆ **Conduct pressure leakage tests on laminates made from different material forms**
- ◆ **Complete compression-after-impact strength tests on laminates made from different material forms**
- ◆ **Complete delaminated panel compression tests at cryogenic temperatures to verify criticality of the effects of defects**

3rd Gen Airframe/TPS:

Integrated Design and Analysis

- ◆ **PMC Damage Tolerance & Repair**
 - POC - Dr. Damodar R. Ambur/Dr. Tom S. Gates, NASA LaRC

- ◆ **Safe Structures Design Technologies**
 - POC - Dr. Damodar R. Ambur, NASA LaRC

3rd Gen Airframe/TPS:

Integrated Design and Analysis

Safe Structures Design Technologies

Goals and Objectives

- ◆ Develop validated second generation nonlinear progressive failure analysis method for composite structures subjected to combined mechanical loads
- ◆ Develop non-deterministic analysis and design methods that bound manufacturing uncertainties
- ◆ Conduct sensitivity analyses for manufacturing uncertainties
- ◆ Develop and demonstrate 3rd. generation progressive failure analysis method that includes combined mechanical and thermal load effects and delaminations
- ◆ Develop design and analysis relationships between structural weight and reliability for composite structures subjected to combined mechanical and thermal loads
- ◆ Develop hybrid deterministic and non-deterministic analysis and design methods that account for uncertainties at the material, structures, and mission levels
- ◆ Conduct hierarchical sensitivity analyses and identify design trends for multiple length scales subjected to combined loads

3rd Gen Airframe/TPS:

Integrated Design and Analysis

Safe Structures Design Technologies

- ◆ **Current Program Status**
 - Initiated in FY2000
 - Efforts continue under the 3rd Generation RLV Program
- ◆ **Current Technical Status**
 - Developed analytical methods and algorithms for using the current damage progression methods to predict the response of nonlinearly deformed structures
 - Conducted progressive damage verification tests on a compression-loaded composite cylinder
 - Conducting progressive damage verification tests on a composite panel subjected to nonlinear deformation with in-plane shear loading
 - Initiated tools development for predicting delamination initiation and growth

3rd Gen Airframe/TPS:

Integrated Design and Analysis

Safe Structures Design Technologies

MECHANICS TECHNOLOGY FOR PROGRESSIVE FAILURE ANALYSIS

- ◆ Embed progressive failure criteria and material degradation models with robust nonlinear structural mechanics solver STAGS
- ◆ Provide progressive damage capability coupled with large displacement, large rotation deformation states for laminated composite structures
- ◆ Provide traditional and state variable damage models
 - Maximum strain with ply discounting
 - Crack density based criteria for failure and degradation
 - User interfaces include ABAQUS/UMAT
- ◆ Incorporate artificial damping feature to mitigate non-convergence problems in re-establishing equilibrium
- ◆ Establish consistency between first and second variations for the energy functional
- ◆ Enhance visual depiction of progressive damage simulation
- ◆ *Increased design robustness through evaluation of extreme loading conditions and understanding possible composite structures failure scenarios*

3rd Gen Airframe/TPS:

Integrated Design and Analysis

Safe Structures Design Technologies

COMPRESSION-LOADED POSTBUCKLING COMPOSITE PANEL

24-ply Graphite-epoxy
orthotropic laminate

Starnes & Rouse, AIAA
Paper 81-0543

Failure load = 21,910 lbs
End shortening at failure
= 0.0818 in.

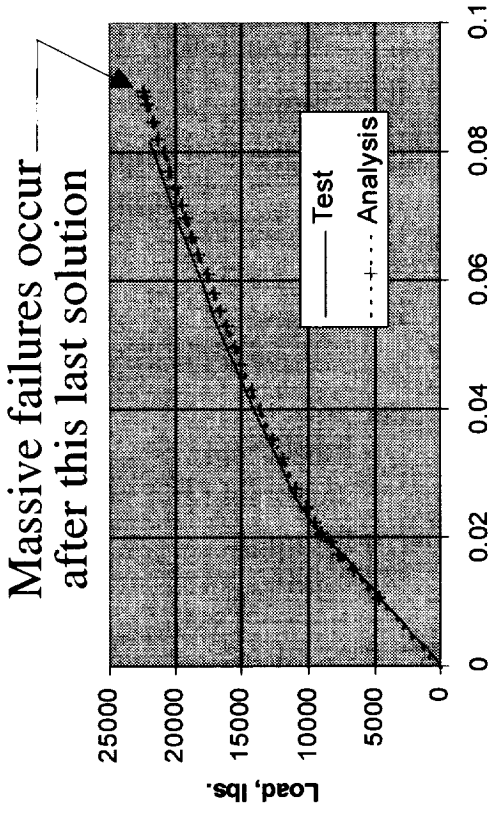

Out-of-plane
Deflections

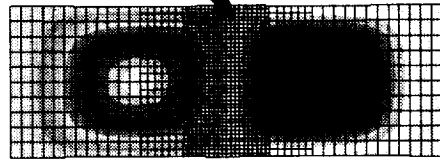

Node
Line in
Buckle
Pattern

Percent Failed Plies

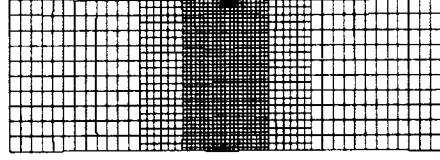

Close-up
of Failed
Region



Inplane Shear Stress in
Outer 0-deg. Layer

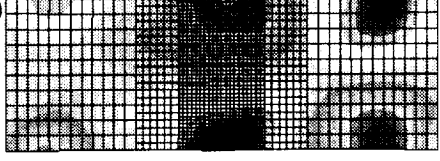

Close-up
Showing
Stress Relief



3rd Gen Airframe/TPS:

Integrated Design and Analysis

Safe Structures Design Technologies

CORRELATION OF PROGRESSIVE FAILURE ANALYSIS RESULTS FOR PANELS AND SHELLS

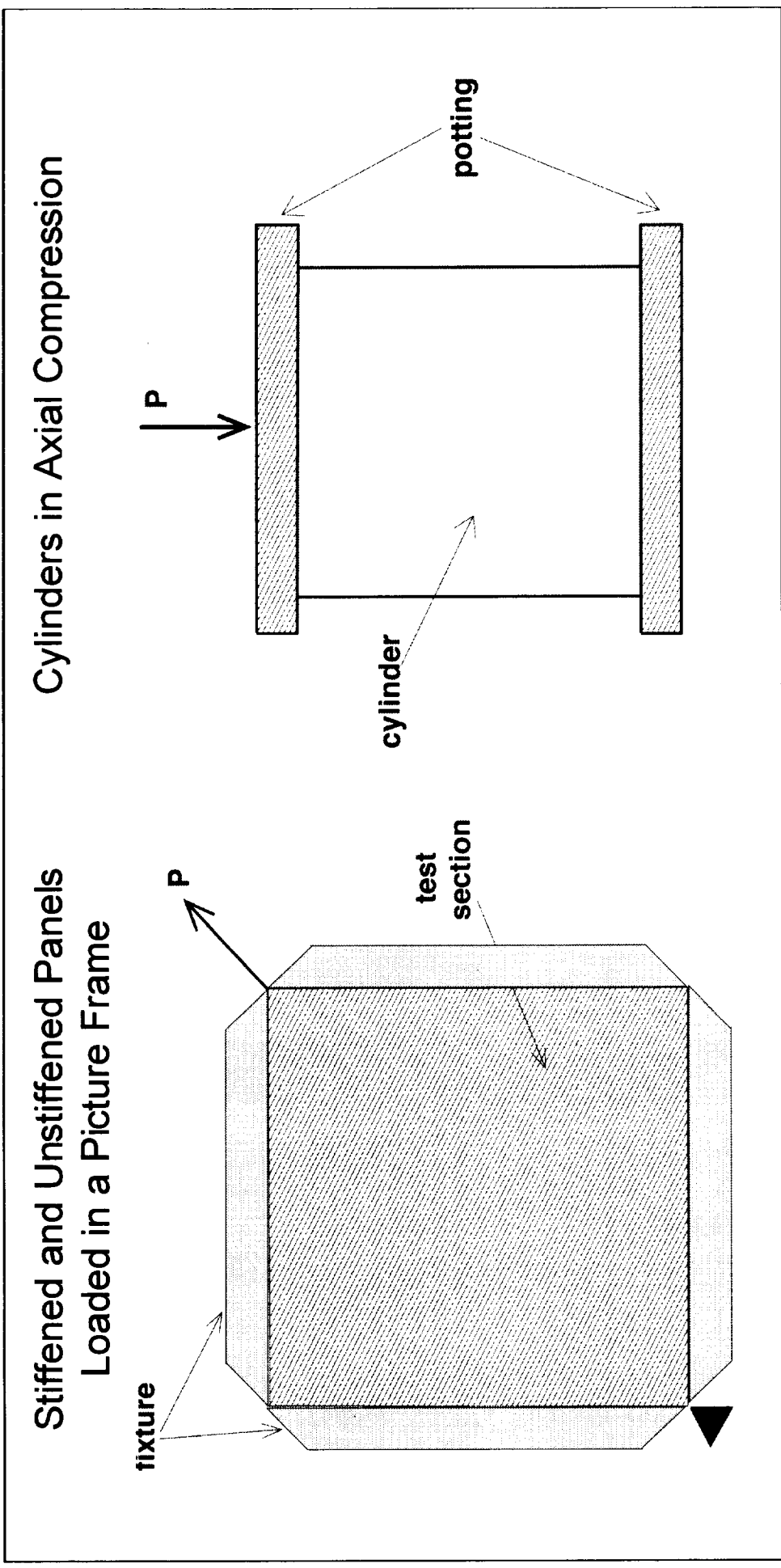

Stiffened and Unstiffened Panels Loaded in a Picture Frame

Cylinders in Axial Compression

3rd Gen Airframe/TPS:

Integrated Design and Analysis

Safe Structures Design Technologies

UNSTIFFENED PANEL LOADED IN PICTURE FRAME SHEAR

- Panel size: 12-in. by 12-in.; Thickness: 0.0896-in.
- Stacking sequence is $[\pm 45/0/90]_{2s}$
- $E_{11} = 18.5$ Msi, $E_{22} = 1.67$ Msi, $G_{12} = 0.87$ Msi,
 $G_{13} = 0.87$ Msi, $G_{23} = 0.258$ Msi, $\mu_{12} = 0.3$
- $X_T = 0.233$ Msi, $X_C = 0.21$ Msi, $Y_T = 0.0147$ Msi,
 $Y_C = 0.0287$ Msi, $SC = 0.02975$ Msi

Failure Load:
54,807 lbs - Test
54,447 lbs - Analysis

Strain Normal to Fiber Direction on Top and Bottom Surfaces at Center of Test-Section

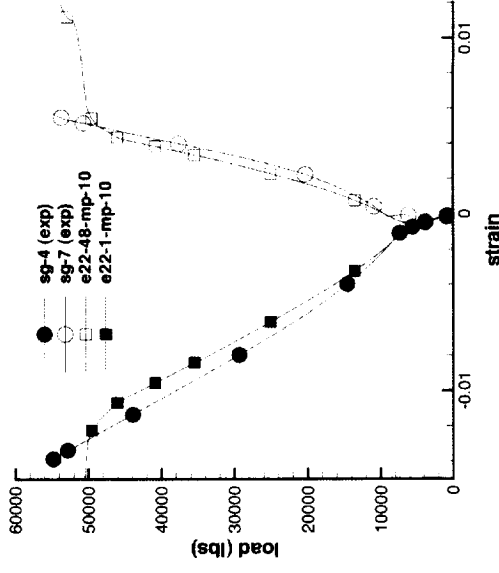

Map of Matrix Failure Region



3rd Gen Airframe/TPS:

Integrated Design and Analysis

Safe Structures Design Technologies

BEAD-STIFFENED PANEL LOADED IN PICTURE FRAME SHEAR

- Panel size: 12-in. by 12-in.; Thickness: 0.08-in.
- Stacking sequence is $[\pm 45/\pm 45/0/\pm 45/90]_s$
- $E_{11} = 18.0$ Msi, $E_{22} = 1.50$ Msi, $G_{12} = 0.82$ Msi, $G_{13} = 0.82$ Msi, $G_{23} = 0.82$ Msi, $\mu_{12} = 0.3$
- $X_T = 0.30$ Msi, $X_C = 0.20$ Msi, $Y_T = 0.013$ Msi, $Y_C = 0.031$ Msi, $SC = 0.027$ Msi

Failure Load:
27,936.9 lbs - Test
26,995.9 lbs - Analysis

Axial Strain on the Top and Bottom Surfaces at Center of Panel

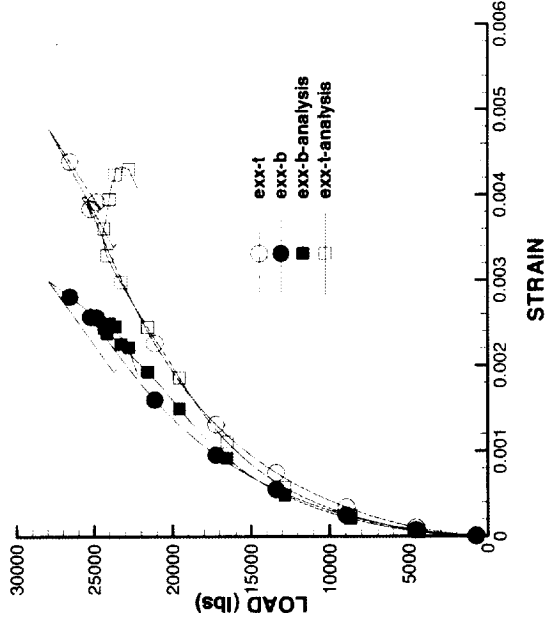

Map of Matrix Failure Region

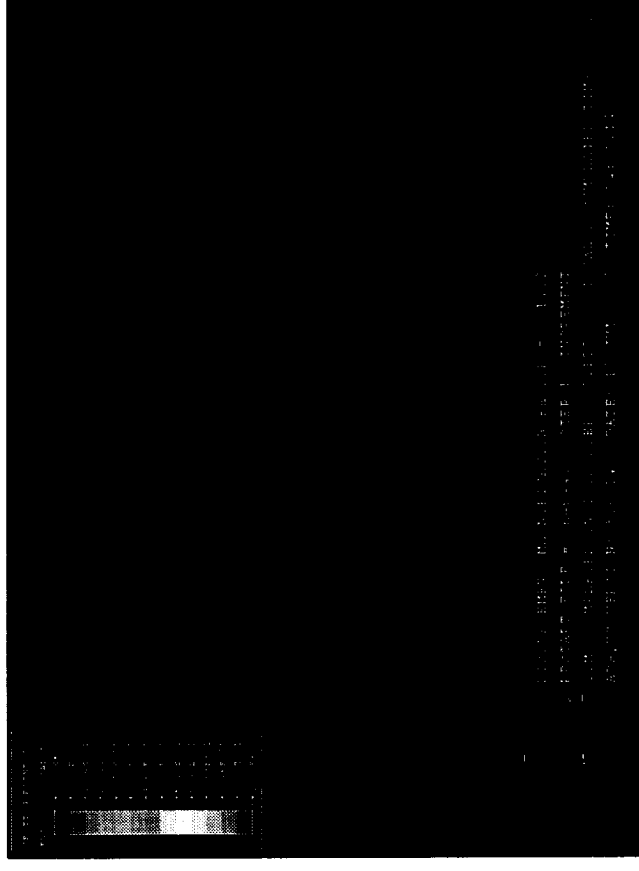

3rd Gen Airframe/TPS:

Integrated Design and Analysis

Safe Structures Design Technologies

EFFECTS OF MANUFACTURING UNCERTAINTIES ON COMPOSITE CYLINDER AXIAL COMPRESSION RESPONSE

- Cylinder is 16.0-in. long; 16.0-in. diameter
- Laminate is $[\pm 45/0/90]_{2s}$ and 0.08-in. thick
- $E_{11} = 19.0$ Msi, $E_{22} = 1.450$ Msi, $G_{12} = 0.814$ Msi, $G_{13} = 0.814$ Msi, $G_{23} = 0.55$ Msi, $\mu_{12} = 0.3$
- $X_T = 0.156$ Msi, $X_C = 0.156$ Msi, $Y_T = 0.00725$ Msi, $Y_C = 0.0145$ Msi, $SC = 0.010826$ Msi

Two models were considered:

- Model 1:
 - Measured geometric imperfection modeled
 - 7,560 elements; 4-noded
- Model 2:
 - Measured geometric imperfection modeled
 - Laminate imperfection modeled as ply drop
 - 10,692 elements; 4-noded

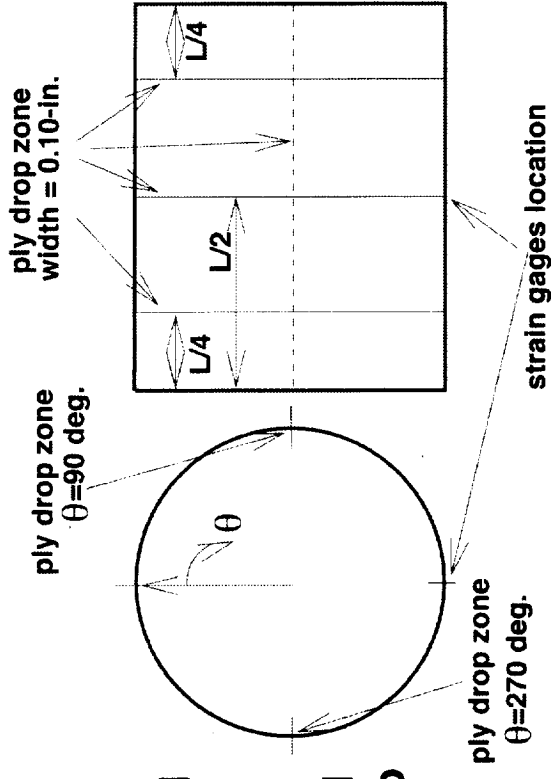

3rd Gen Airframe/TPS:

Integrated Design and Analysis

Safe Structures Design Technologies

EFFECT OF MANUFACTURING UNCERTAINTIES ON
COMPOSITE CYLINDER AXIAL COMPRESSION RESPONSE (Contd.)

Load Vs. End-shortening Results

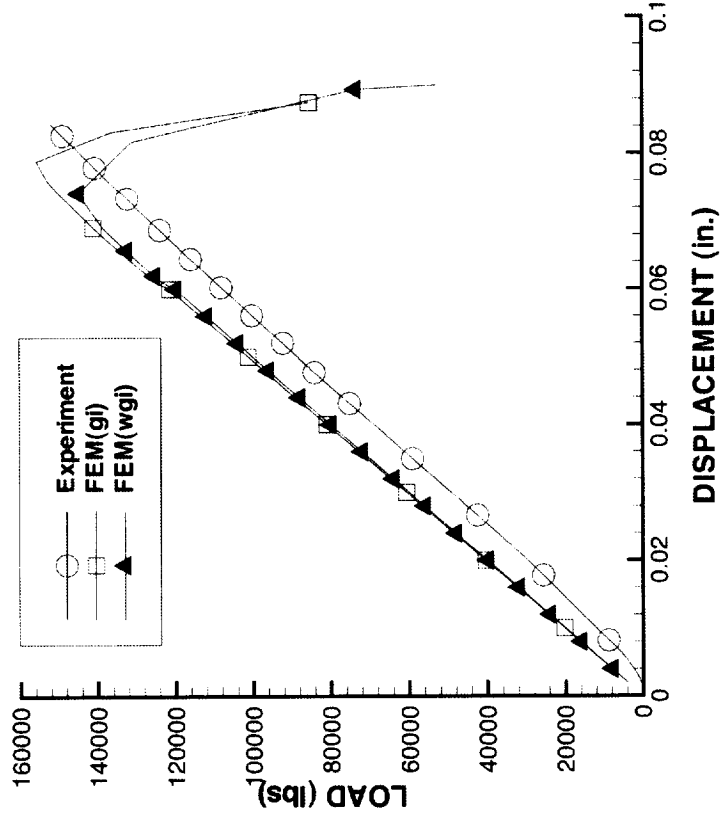

Load Vs. Axial Strain Results

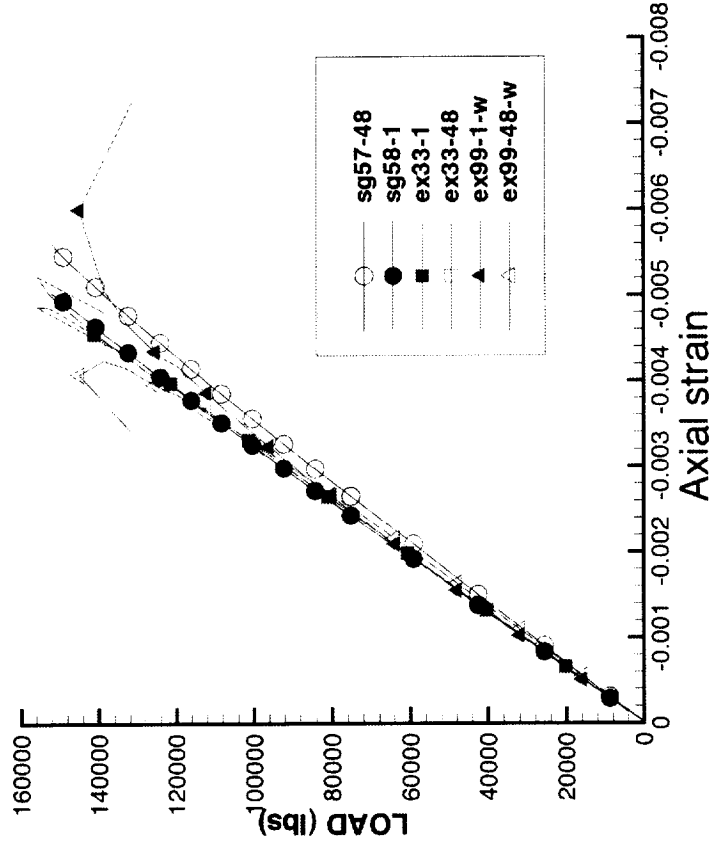

3rd Gen Airframe/TPS:

Integrated Design and Analysis

Safe Structures Design Technologies

EFFECT OF MANUFACTURING UNCERTAINTIES ON
COMPOSITE CYLINDER AXIAL COMPRESSION RESPONSE (Contd.)

Map of Failure Region for Model 1

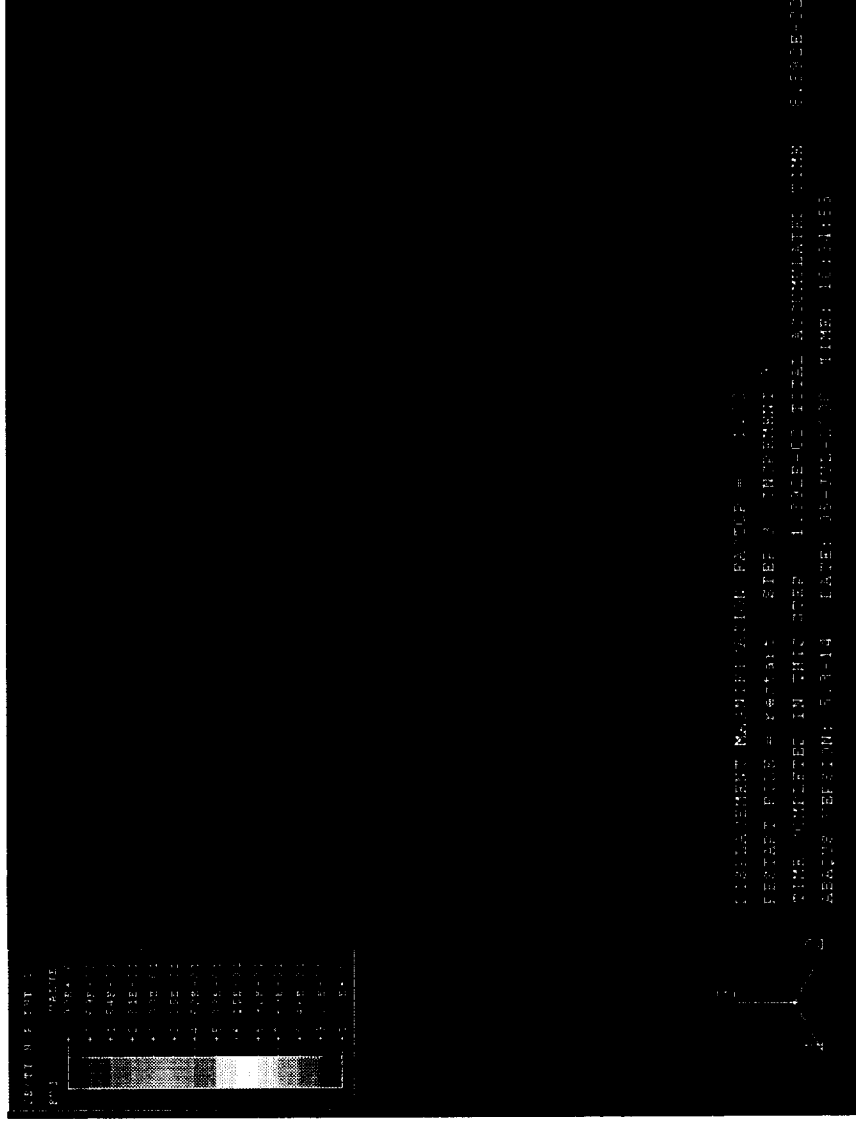

3rd Gen Airframe/TPS:

Integrated Design and Analysis

Safe Structures Design Technologies

EFFECT OF MANUFACTURING UNCERTAINTIES ON COMPOSITE CYLINDER AXIAL COMPRESSION RESPONSE (Concluded)

Map of Failure Region for Model 2

Failure modes and damage region results obtained using Model 2 compare well with experimental results

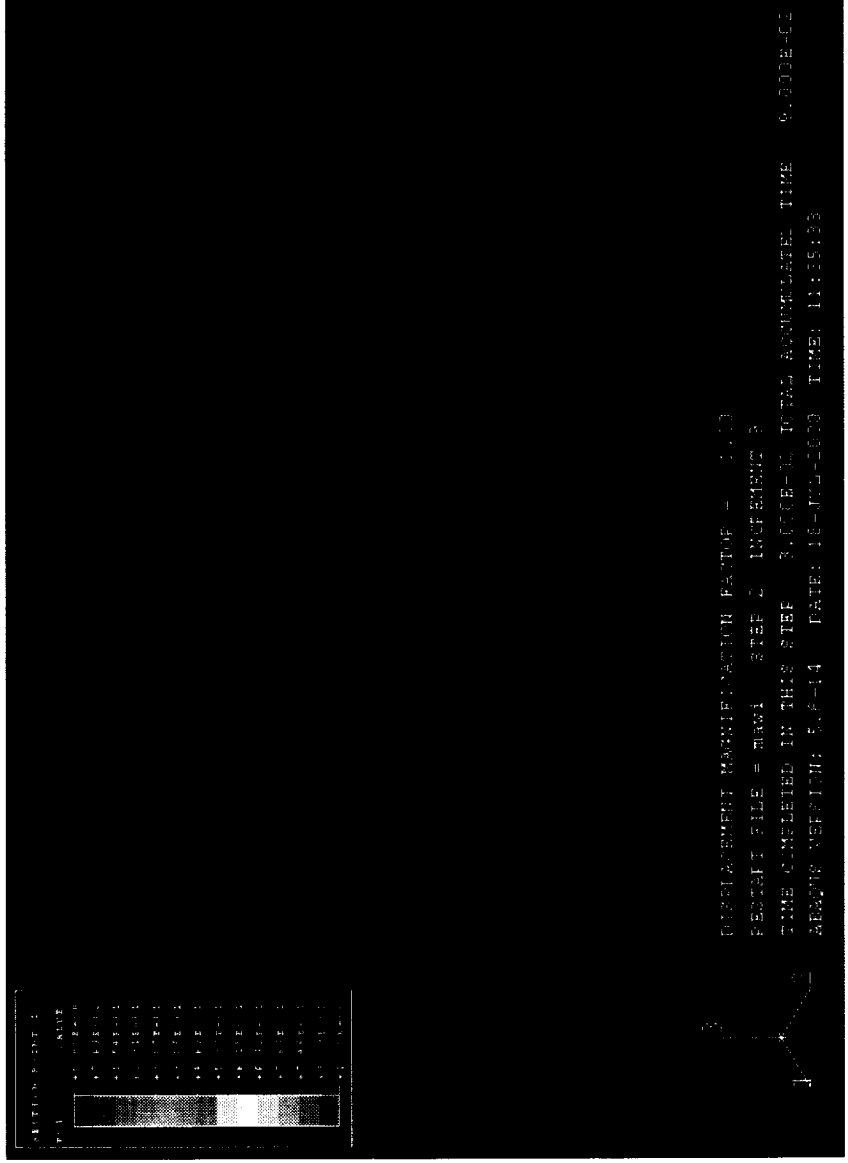

3rd Gen Airframe/TPS:

Integrated Design and Analysis

Safe Structures Design Technologies

NEAR-TERM PLANS

- ◆ Conduct inplane shear tests on stiffened and unstiffened panels
- ◆ Correlate analytical and experimental results
- ◆ Continue efforts to validate the decohesion element for simulating the delamination failure mode
- ◆ Incorporate decohesion element into STAGS finite element analysis code

3rd Gen Airframe/TPS:

Integrated Design and Analysis

Integrated Thermal Structures & Materials Overview

Dr. Brian Jensen
NASA Langley Research Center
(757) 864-4271
b.j.jensen@larc.nasa.gov

3rd Gen Airframe/TPS:

Int. Thermal Structures and Materials

◆ **Resins for transfer molding or infusion processing**

- **POC:**
 - Paul M. Hergenrother
 - (757) 864-4270
 - p.m.hergenrother@larc.nasa.gov

◆ **Nonautoclave processable adhesives**

- **POC:**
 - Dr. Brian J. Jensen
 - (757) 864-4271
 - b.j.jensen@larc.nasa.gov

◆ **Automated Tape Placement Device with e-beam cure**

- **POC:**
 - Harry L. Belvin
 - (757) 864-9436
 - h.l.belvin@larc.nasa.gov

3rd Gen Airframe/TPS:

Int. Thermal Structures and Materials

High Temperature RLV Tank Concept

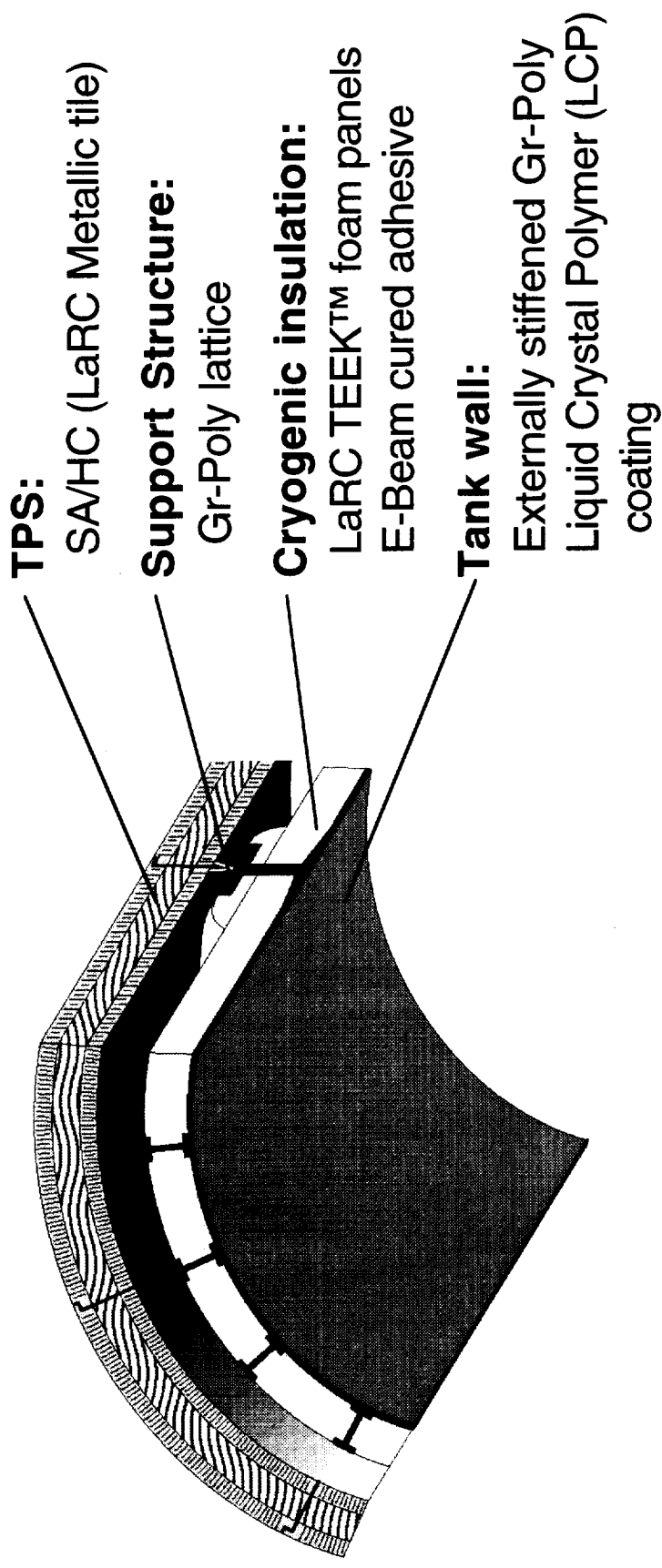

3rd Gen Airframe/TPS:

Int. Thermal Structures and Materials

- ◆ **Resins for transfer molding or infusion processing**
 - POC - Paul M. Hergenrother, NASA LaRC

- ◆ **Nonautoclave processable adhesives**
 - POC - Brian J. Jensen, NASA LaRC

- ◆ **Automated Tape Placement Device with e-beam cure**
 - POC - Harry L. Belvin, NASA LaRC

Accomplishments, RTM/RI Resins

- ◆ **LaRC prepared 5 resins with Tgs as high as 625°F, <1% volatiles, moderate toughness and low melt viscosity and sent to Boeing or Lockheed Martin**
- ◆ **GRC prepared 4 resins with Tgs as high as 700°F, <10% volatiles and low melt viscosity and sent to Boeing**
- ◆ **Boeing successfully fabricated 2' x 2' x 36 ply composites by resin infusion (RI) of stitched preforms from all NASA supplied resins**
- ◆ **Lockheed Martin successfully fabricated 13" x 14" x 16 ply composites by resin transfer molding (RTM) from all NASA supplied resins**

3rd Gen Airframe/TPS:

Int. Thermal Structures and Materials

Chemistry of PETI-298

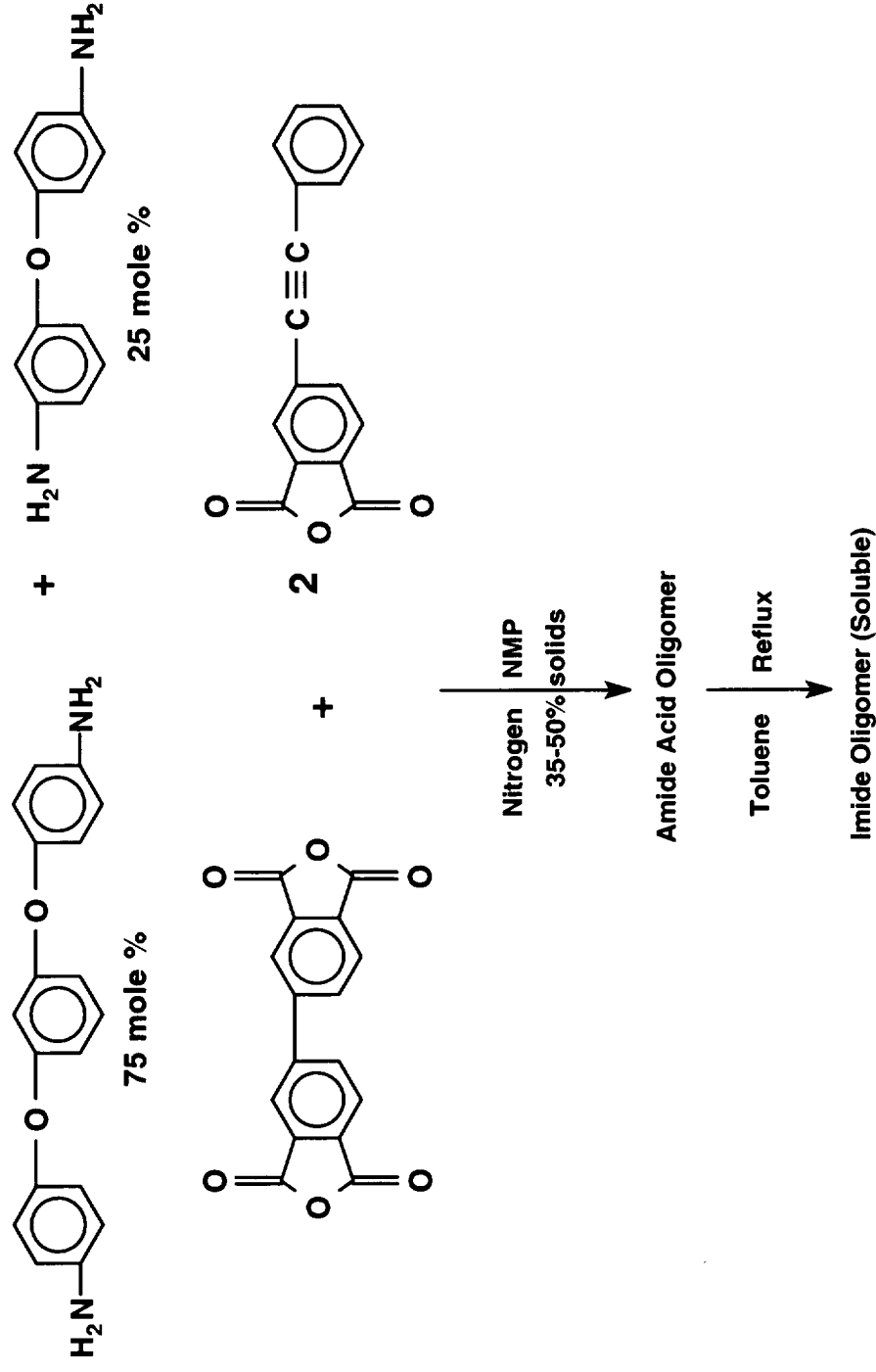

Calculated Mn 750 g/mole = PETI-298

3rd Gen Airframe/TPS:

Int. Thermal Structures and Materials

Comparison of PETI Oligomers Prepared From 1,3,3 and 1,3,4 - APB

APB Diamine	Calculated Mn, g/mole	Glass Transition Temp., °C Initial	Glass Transition Temp., °C Cured*	Melt Viscosity @ 280°C, poise
1,3,3	750	132	258	1-6
1,3,3	1250	151	244	5-15
1,3,4	750	139	298	6-13
1,3,4	1250	165	285	10,000**

* Cured 1 hour at 371°C

**Viscosity dropped to ~30 poise at 325°C

3rd Gen Airframe/TPS:

Int. Thermal Structures and Materials

Photomicrographs of PETI-298 Laminates Fabricated Via RTM

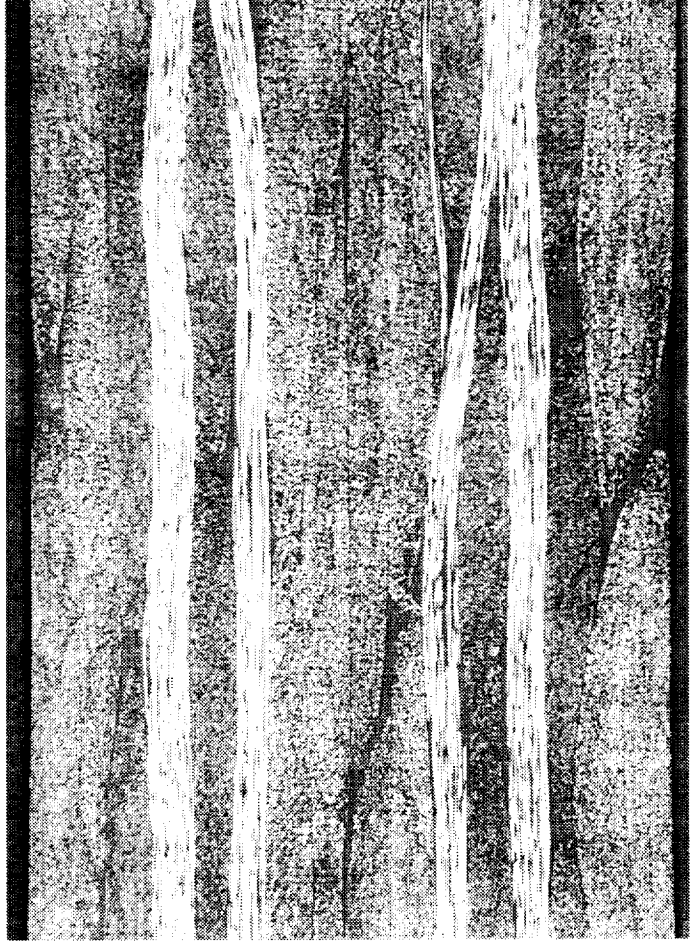

25 x Magnification

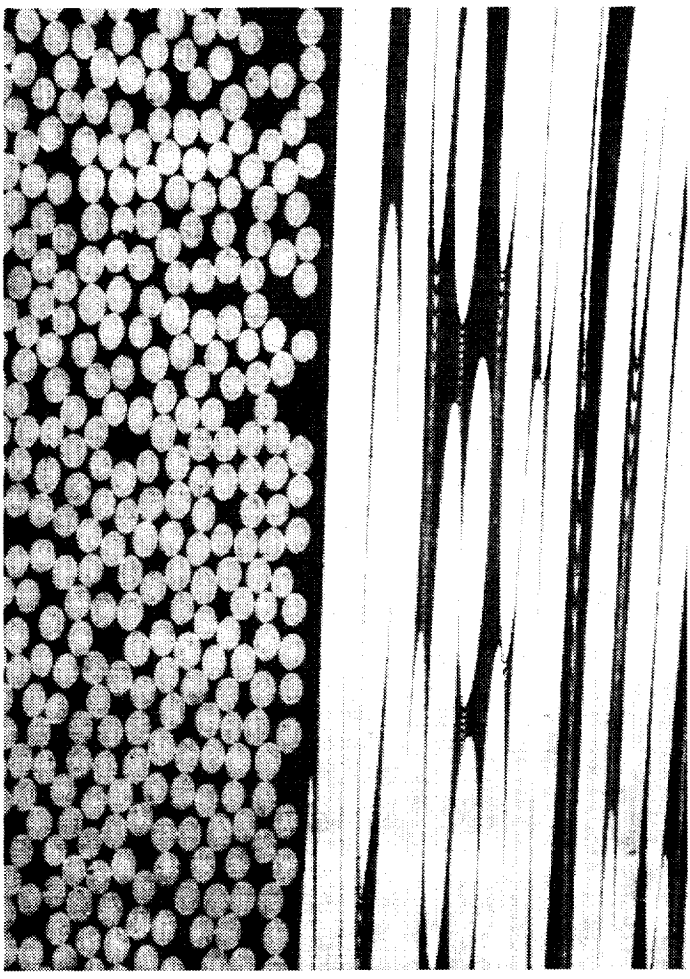

400 x Magnification

3rd Gen Airframe/TPS:

Int. Thermal Structures and Materials

Mechanical Properties of AS-4/PETI-298 Fabric Composites Fabricated Via Resin Transfer Molding (8 ply)

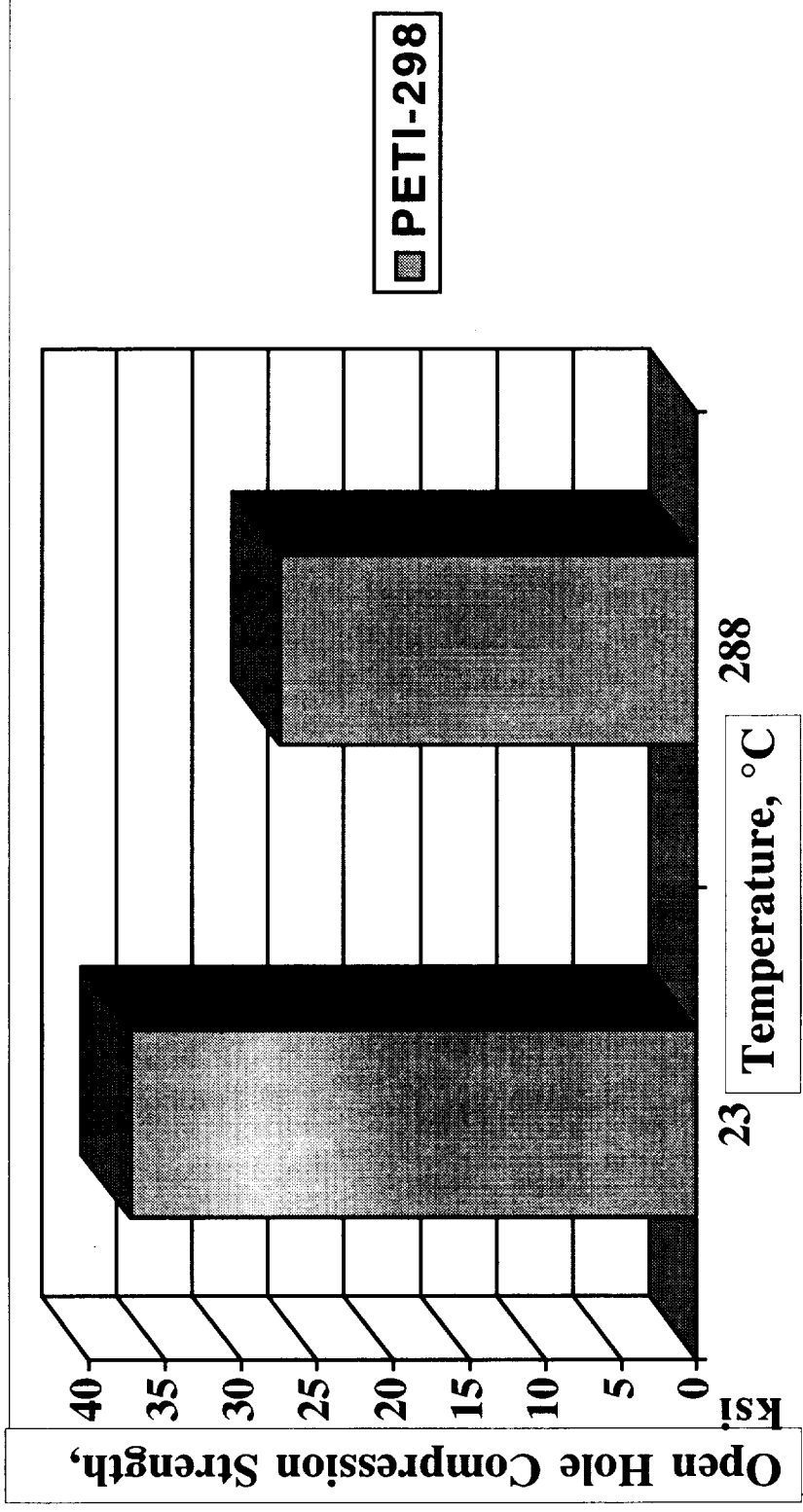

PETI-298 cured 1 hr @ 370°C, T_g = 302°C (8 ply AS-4 fabric)

Un-notched Compression Strength at 23°C = 60 ksi

3rd Gen Airframe/TPS:

Int. Thermal Structures and Materials

Mechanical Properties of IM-7 PETI-298 Stitched Composites Fabricated Via Resin Infusion (36 ply)

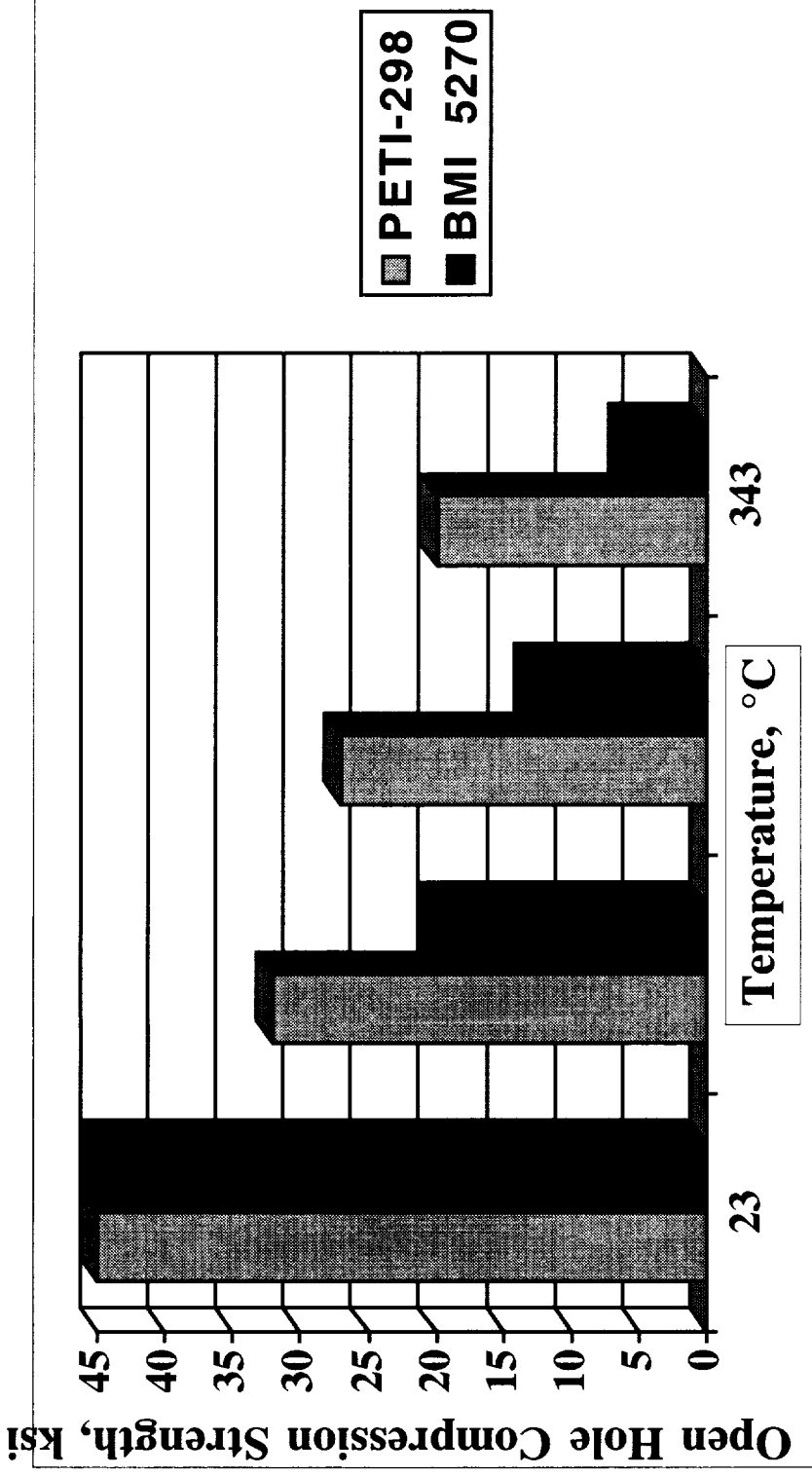

PETI-298 cured 1 hr @ 370°C, postcured at 370°C, Tg = 338°C (Panel 36 ply x 22" x 22", stitched)

BMI 5270 cured 4 hr @ 190°C, postcured at 232 and 260°C, Tg = 299°C

3rd Gen Airframe/TPS:

Int. Thermal Structures and Materials

- ◆ **Resins for transfer molding or infusion processing**
 - POC - Paul M. Hergenrother, NASA LaRC

- ◆ **Nonautoclave processable adhesives**
 - POC - Brian J. Jensen, NASA LaRC

- ◆ **Automated Tape Placement Device with e-beam cure**
 - POC - Harry L. Belvin, NASA LaRC

Accomplishments, LaRC PETI-8

- ◆ **Developed and supplied to Cytec Fiberite several non-autoclave processable adhesives.**
- ◆ **LaRC PETI-8 is a phenylethynyl terminated polyimide adhesive which has low melt viscosity and excellent melt stability at temperatures below 300°C, allowing the production of excellent adhesive bonds under vacuum bag pressure, without the need for external pressure normally supplied by an autoclave. Heating at 316°C for 8 hours provides excellent titanium to titanium tensile shear strengths from 75°F to at least 350°F and excellent flatwise tensile strengths at 75°F.**
- ◆ **Plan to continue work on adhesives which do not require an autoclave for processing. Concentrate on vacuum bag / oven processing, hot melt adhesives and the use of e-beam radiation to cure advanced adhesives. Optimize the properties of LaRC PETI-8 by studying various formulations of the adhesive tape and various cure conditions.**

3rd Gen Airframe/TPS:

Int. Thermal Structures and Materials

LaRC PETI-8

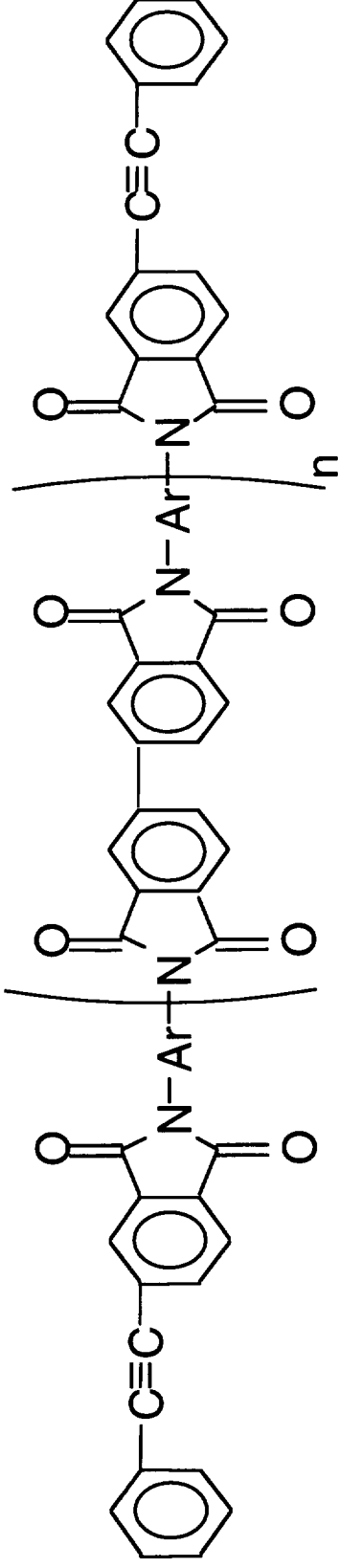

Titanium to Titanium Tensile Shear Strengths

Required

5000 psi at 75° F

3500 psi at 350° F

Achieved

7400 psi

6200 psi

Flatwise Tensile Strength (Composite Skins over Titanium core)

Required

1000 psi at 75° F

Achieved

1370 psi

Bonding Conditions:

Vacuum Bag Only Pressure, 316°C, 8 hour hold, 5V CAA surface treatment

3rd Gen Airframe/TPS:

Int. Thermal Structures and Materials

Cytec Fiberite Results for PETI-8 Bonding

Evaluated 550°F, 575°F and 600°F cycles from 4-12 hours under vacuum bag only pressure for several different formulations. Shown are results for 600°F, 4 hour cycle.

PETI-8 Tensile Shear Strength	<u>75°F</u>	<u>350°F</u>
Titanium substrate, CAA Anodized	7000 psi (min.)	5000 psi (min.)
PETI-5 composite substrate (interlaminar failure at both test temperatures)	5500 psi	4500 psi
PETI-8 Flatwise Tensile Strength	<u>75°F</u>	
2024 Al face sheets, FPL etched, 3/16" Ti core	1800 psi	

Cytec currently preparing two 2' x 2' PETI-5 composite panels to be bonded together as a wide area specimen.

3rd Gen Airframe/TPS:

Int. Thermal Structures and Materials

- ◆ **Resins for transfer molding or infusion processing**
 - POC - Paul M. Hergenrother, NASA LaRC

- ◆ **Nonautoclave processable adhesives**
 - POC - Brian J. Jensen, NASA LaRC

- ◆ **Automated Tape Placement Device with e-beam cure**
 - POC - Harry L. Belvin, NASA LaRC

Accomplishments, ATP with E-Beam Cure

- ◆ GRC has Cooperative Agreement with Kent State University to study e-beam irradiation of polyimide thin films. (Shows little effect on mechanical properties or Tg)
- ◆ GRC has Cooperative Agreement with University of Delaware to study new e-beam curable resins. (Extent of cure dependent on molecular mobility)
- ◆ GRC in-house e-beam curable resin development. (Diels-Alder trapping of quinodimethane intermediates formed under radiation)
- ◆ LaRC and Boeing developing a tape laying machine with e-beam cure-on-the-fly processing. Undergoing acceptance testing at Boeing and will be shipped to LaRC when facilities are ready.

3rd Gen Airframe/TPS:

Int. Thermal Structures and Materials

◆ Products/ Benefits/Payoff:

- Validate the cause of low performance in E-beam cured graphite/epoxy composites and investigate methods for improving their performance through the use of novel sizings or resin additions.
- The goals are to:
 - Positively identify the deficiencies causing reduced properties in E-beam cured composites
 - Identify and demonstrate the best method for performance improvement
- Improved performance of E- beam composites will enable out-of-autoclave fabrication of large cryo tanks. Higher performance of these materials directly reduces RLV vehicle weight.

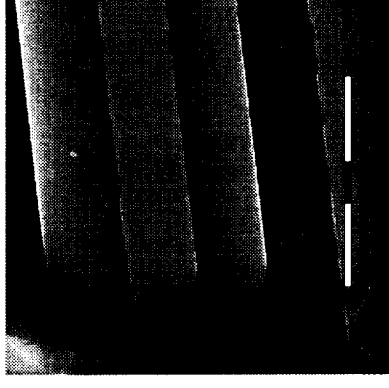

E-Beam Cured Cat-B



Thermally Cured 8552

3rd Gen Airframe/TPS:

Int. Thermal Structures and Materials

E-beam Gun Head from Electron Solutions, Inc. E-beam Gun Head from Electron Solutions, Inc. Boeing Stapp Laying Gantry

This task will design, fabricate and deliver a tape laying device capable of laying E-beam "cure-on-the-fly" (COTF) prepreg for material evaluations.

• Products/ Benefits/Payoff:

COTF E- beam curing will enable out-of-autoclave fabrication of RLV cryo tanks which will substantially reduce overall vehicle weight.

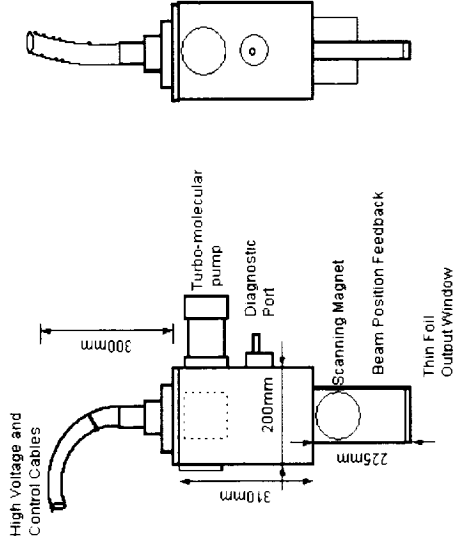

**E-beam Gun Head from
Electron Solutions, Inc.**

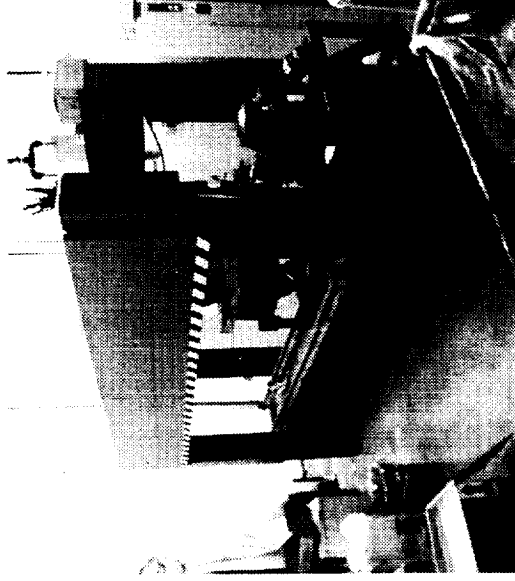

Boeing Tape Laying Gantry

3rd Gen Airframe/TPS:

Int. Thermal Structures and Materials

Overview of TPS tasks

Sylvia M. Johnson
Branch Chief
Thermal Protection Systems
NASA Ames Research Center
Moffett Field, CA 94035
(650) 604-2646/smjohnson@mail.arc.nasa.gov

3rd Gen Airframe/TPS:

Thermal Protection Systems

- ◆ **Quick Processed, Low Cost Erosion Resistant TPS**
- ◆ **Smarter TPS**
- ◆ **Advanced, High-Temperature Structural Seals**
- ◆ **UHTC Sharp Leading Edges**
- ◆ **High Temperature Felt TPS**

3rd Gen Airframe/TPS:

Thermal Protection Systems

◆ **Quick Processed, Low Cost Erosion Resistant TPS**

• **POC's:**

- Dr. Daniel Leiser, David Stewart, Huy Tran, Dr. Susan White
- dleiser@mail.arc.nasa.gov
- (650) 604-6076
- dstewart@mail.arc.nasa.gov
- (650) 604-6614
- htran@mail.arc.nasa.gov
- (650) 604-0219
- swhite@mail.arc.nasa.gov
- (650) 604-6617

3rd Gen Airframe/TPS:

Thermal Protection Systems

Quick Processed, Low Cost, Erosion Resistant TPS

- ◆ **Objective**
 - Develop light weight & low cost durable TPS for easy application to RLV payload launchers
 - Develop quickly processed composite TPS processing & repair techniques
 - Develop higher temperature capability tile TPS
- ◆ **Benefits**
 - **Reduced installation & operations cost**
 - **Enhanced payload capability resulting from TPS weight reduction**
 - **Enhanced flight envelope & performance resulting from higher temperature capability TPS which can result in improved safety**

3rd Gen Airframe/TPS:

Thermal Protection Systems

Quick Processed, Low Cost, Erosion Resistant TPS

Technical Accomplishment

More Capable Ceramic Tile TPS Demonstrated

POC: Dr. Daniel Leiser

September 2000

Relevant Milestone: Task 2 - Quick Processed Erosion Resistant TPS,

- Higher temperature capability (above 3,000°F), and
- Faster processed ceramic tile TPS produced, 8/15/00

Shown: A graphic of an entry vehicle with a higher temperature capability tile TPS leading edge being tested in a hypersonic arc plasma stream that will be cheaper, safer and easier to repair.

Accomplishments

- Arc jet testing was completed on candidate ceramic tile TPS at 3,000°F for 2 and 4 minutes (Tile TPS currently limited to 2700°F);
- Arc jet testing was completed on candidate QUICTUF1 tiles at 2800°F for 5 minutes.

Relation to Milestone

- This reduces the cost of ceramic tile TPS substantially by reducing the labor required and extends its usage capability to higher temperature locations (i.e., leading edges) where much more expensive (i.e., carbon/carbon), difficult to replace and flaw sensitive materials are characteristically applied .

Future Plans: Continue extending the temperature capability of the materials reduce the labor required to produce these materials.

3rd Gen Airframe/TPS:

Thermal Protection Systems

Quick Processed, Low Cost, Erosion Resistant TPS

Technical Accomplishment

Higher Temperature Capability Tile Leading Edge

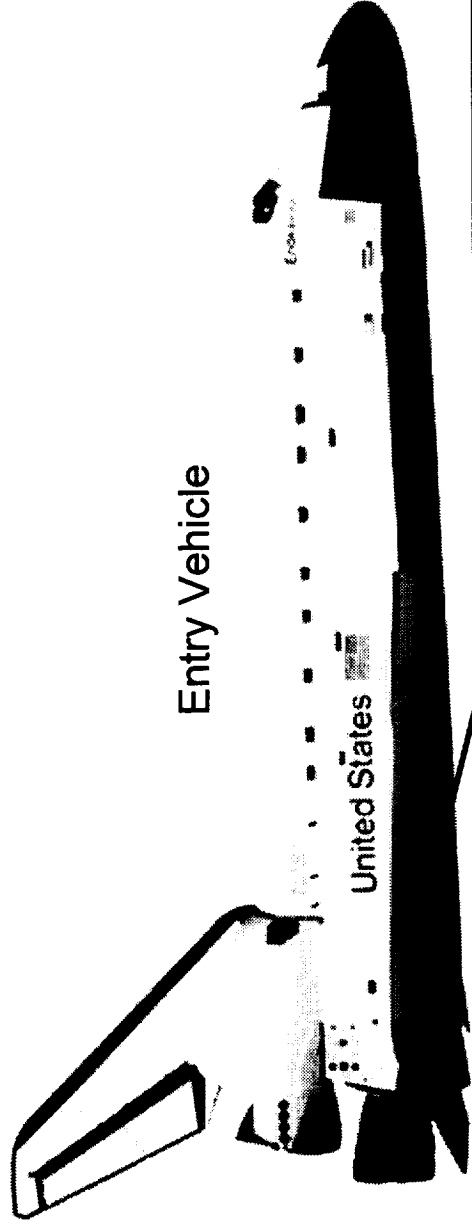

Entry Vehicle

Ceramic Tile TPS in
Hypersonic Arc Plasma Stream



3rd Gen Airframe/TPS:

Thermal Protection Systems

Quick Processed, Low Cost, Erosion Resistant TPS

Technical Accomplishment

Aerogel-Tile Development

POC: Dr. Dan Leiser & Dr. Susan White
September 2000

Relevant Milestone: Autoclave equipment on-line to produce large scale Aerogel-Tiles. (September FY99)

Shown: Large Scale Autoclave Supercritical Processing Equipment that is used to produce either pure aerogels or aerogel-tile composites. Aerogels are organic, inorganic or metal oxide-based highly porous monoliths or nano-particulate materials.

- Extremely light weight - critical for Space
- Lowest solid conductivity: Superinsulator

Aerogel tiles exploit low thermal conductivity and low density of aerogels and AETB's high temperature capability and moderate density

Accomplishment / Relation to Milestone and ETO: The Autoclave equipment is currently on-line and the operational procedures are being developed to produce large scale aerogel tiles, enabling progress towards the goal of reducing TPS weight.

Future Plans: Continue producing, characterizing and optimizing aerogel-tile composites tailored for specific spacecraft insulation applications.

3rd Gen Airframe/TPS:

Thermal Protection Systems

Quick Processed, Low Cost, Erosion Resistant TPS

Technical Accomplishment

Aerogel Tile Development

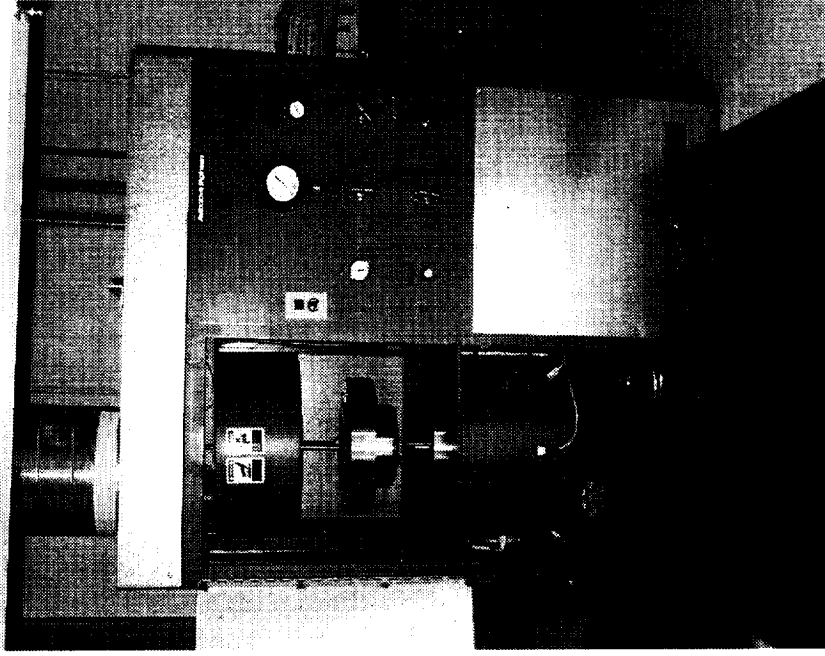

Large-Scale Autoclave
Equipment



Pure Aerogels

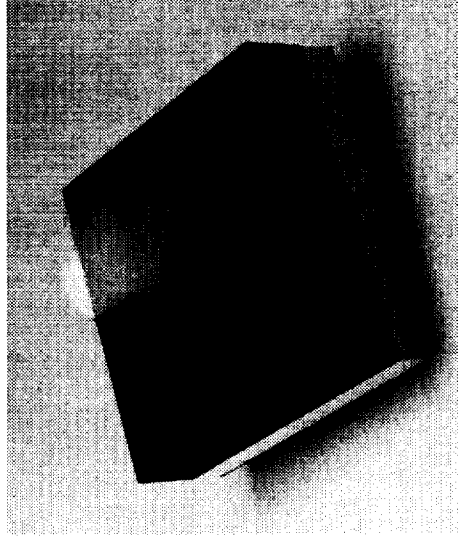

Aerogel-Tiles

3rd Gen Airframe/TPS:

Thermal Protection Systems

Quick Processed, Low Cost, Erosion Resistant TPS

Technical Accomplishment

Erosion Resistant TPS

POC: Huy Tran
September 2000

Relevant Milestone: Task 2 - Quick Processed Erosion Resistant TPS,

- Resin impregnated fabric reinforced erosion resistant tile TPS surface successfully tested at 2200°F for 30 min.

Shown: A graphic of an erosion-resistant leading edge tile TPS with a fabric reinforced face.

Accomplishment

- Testing was completed on a fabric reinforced erosion resistant TPS at 2200°F for 30 minutes.

Relation to Milestone

- This material concept will reduce the cost of ceramic tile TPS substantially by extending its usage capability to more damage prone locations where characteristically much more expensive materials are applied .

Future Plans: Develop adhesion technique for multi-layered fabric reinforced face on tile TPS, further improving erosion resistance and perform arc jet testing on leading edge configuration test model

3rd Gen Airframe/TPS:

Thermal Protection Systems

Quick Processed, Low Cost, Erosion Resistant TPS

Technical Accomplishment

Erosion Resistant Leading Edge Concept

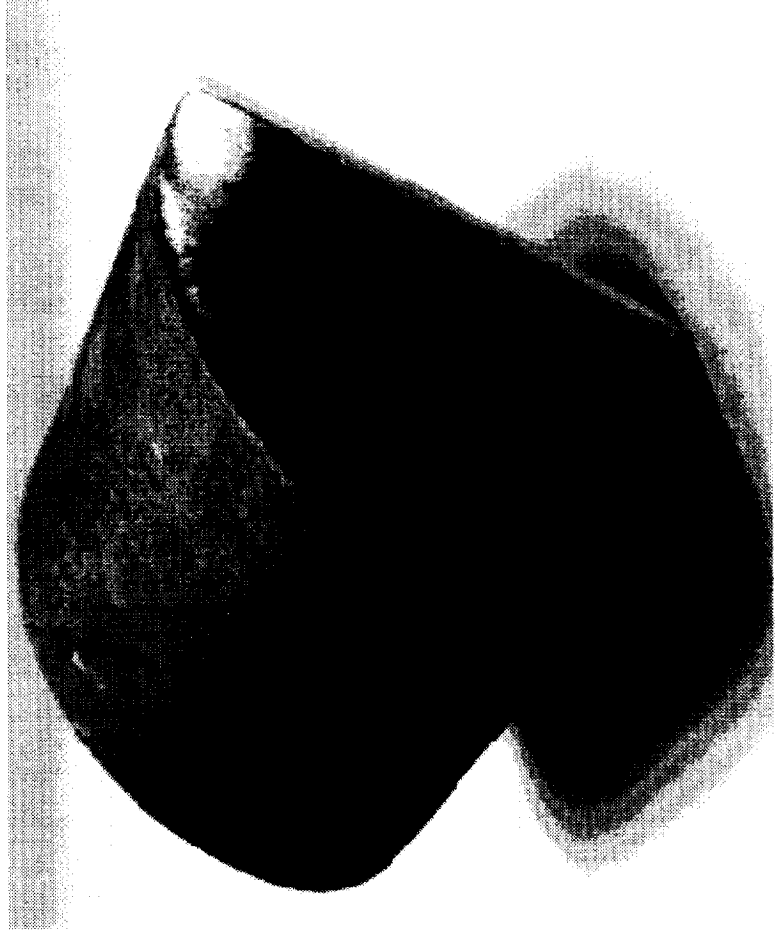

3rd Gen Airframe/TPS:

Thermal Protection Systems

- ◆ **SmartPS**
 - **POC:**
 - **Frank Milos**
 - **Fmilos@mail.arc.nasa.gov**
 - **(650) 604-5636**

3rd Gen Airframe/TPS:

Thermal Protection Systems

SmartTPS

Passive Wireless Thermal-Overlimit Sensor

- ◆ **Background:** Inspection of intertile gaps, primarily for evidence of hot-gas inflow and subsurface charring, is a slow and labor intensive task that involves close-up, hand-on visual inspection. The highest priority for health monitoring of TPS is development of a sensor system that can automatically monitor the subsurface temperature and rapidly communicate the sensor data to outside the vehicle using wireless communications technology.
- ◆ **Technology goals and objectives:** The goal of this subtask is to develop a miniature sensor that combines a passive temperature measurement, an identification microchip, and a micro-antenna to enable wireless communications.

3rd Gen Airframe/TPS:

Thermal Protection Systems

SmartPS

Passive Wireless Thermal-Overlimit Sensor

- ◆ **Current Status and major accomplishments:** A prototype passive sensor was designed and manufactured. The sensor fits into a 50-mil gap, can survive 15 minute exposure to about 650 °F (345 °C), and indicates a thermal-overlimit event using a fuse that melts at 558 °F (292 °C).
- ◆ **Near-term plans:** As required, additional sensors of the same (or slightly modified) design will be manufactured, and sensors will be tested in preparation for possible Shuttle Orbiter flight experiments.
- ◆ **Note:** currently TRL=4 to 5. After arc jet/qualification testing we will be at TRL= 5 to 6.

3rd Gen Airframe/TPS:

Thermal Protection Systems

SmartTPS

Passive Wireless Thermal-Overlimit Sensor

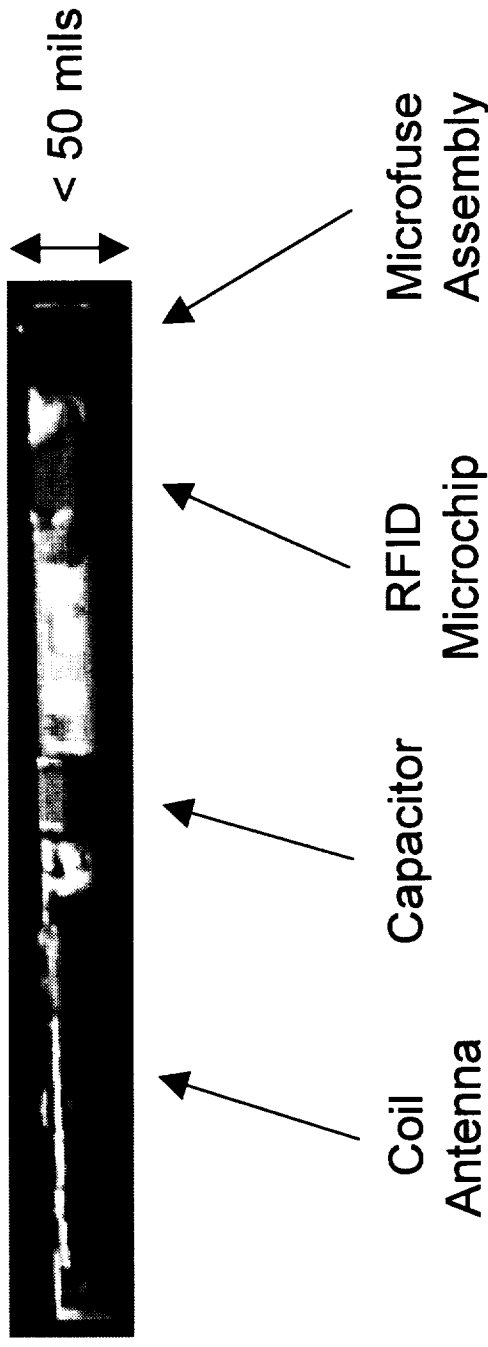

- Sensor fits into 50-mil gap between TPS tiles
- Tag mass is 75 mg
- Microfuse opens at 558 °F to indicate a thermal-overlimit event
(other fuse temperatures using different solder alloys are possible)
- Sensor should survive 15 minutes exposure to 650 °F

3rd Gen Airframe/TPS:

Thermal Protection Systems

SmartTPS

Active Wireless Thermal-Profile Sensor

- ◆ **Background:** In some cases, rather than simply indicating a thermal-overlimit event, it is desirable to measure and record TPS temperatures. For example, in-flight TPS gap or surface temperatures may be useful for environment characterization and performance evaluation.
- ◆ **Technology goals and objectives:** The goal of this subtask is technology development to combine active sensors, micro-batteries, an identification microchip, and a micro-antenna for communications to enable in-flight data acquisition with on-ground data readout. In the long-term, real-time data acquisition is desirable for applications such as MMOD impact detection.

3rd Gen Airframe/TPS:

Thermal Protection Systems

SmartPS

Active Wireless Thermal-Profile Sensor

- ◆ **Current Status and major accomplishments:** A proof-of-concept prototype active sensor using COTS components was designed and manufactured. The electronics are bonded to the back of a TPS tile, and an attached Type-K thermocouple is placed anywhere within a TPS tile. The time and some criteria for data acquisition are downloaded to the microchip, subsequently temperature data are acquired and stored, and finally the time-tagged data are retrieved using wireless communications.
- ◆ **Near-term plans:** The prototype sensor will be tested and a demonstration model will be manufactured.
- ◆ **Note:** After some testing we will be at TRL= 3 to 4.

3rd Gen Airframe/TPS:

Thermal Protection Systems

SmartPS

Active Wireless Thermal-Profile Sensor

- Tile sensor plug bonded to Microtag, this assembly then inserted into tight-fitting hole at back of tile.
- Periodically monitors temperatures at bond line and near the surface.
- Time-tagged data will be output to wand-style reader.
- Technique can be generalized for many uses
 - limited by microbattery life.
- For future designs, several thermocouples may be monitored simultaneously (however wires must be run to each TC location) with data output from one RFID device.

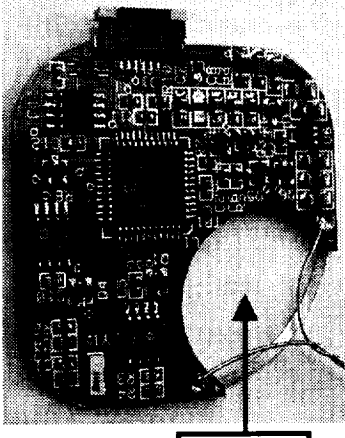

battery
inserted
here

Prototype Active Microtag
(to scale)

Front Surface: transient temperature can exceed 2000°F
(test in arc jet or use blow torch for demo)

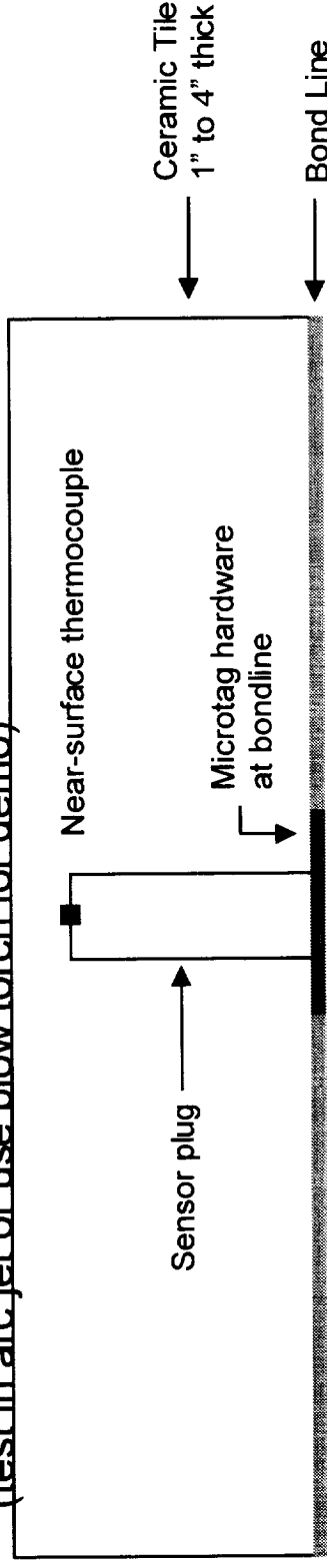

Back Surface: transient temperature below 300°F
(transient temperature to 650°F may be ok in future versions)

3rd Gen Airframe/TPS:

Thermal Protection Systems

SmartTPS

Surface Laser Measurement Tool

- ◆ **Background:** Surface TPS defects can be detected by a post-flight inspection. Currently for Shuttle a team of humans performs a hands-on inspection using rulers and other tools to measure the dimensions of holes, inter-tile steps and gaps, etc. In principle, this inspection could be performed more rapidly and reliably using smart automated scanning tools.
- ◆ **Technology goals and objectives:** The goal of this subtask is to develop portable laser-based tools for rapid surface inspection of TPS.

3rd Gen Airframe/TPS:

Thermal Protection Systems

SmartPS

Surface Laser Measurement Tool

- ◆ **Current Status and major accomplishments:** Working with Joe Lavelle in Code SFT, a pre-prototype laser-scanning tool was manufactured and demonstrated. This hand-held tool scans a 3” x 3” surface area and obtains quantitative measurements of the surface depth suitable for obtaining full dimensions of surface flaws such as impact chips and holes.
- ◆ **Near-term plans:** An improved prototype device that uses two lasers has been designed. The prototype will be manufactured and tested in FY01.
- ◆ **Note:** TRL =3, will be 4 after new prototype is tested.

3rd Gen Airframe/TPS:

Thermal Protection Systems

SmartTPS Surface Laser Measurement Tool

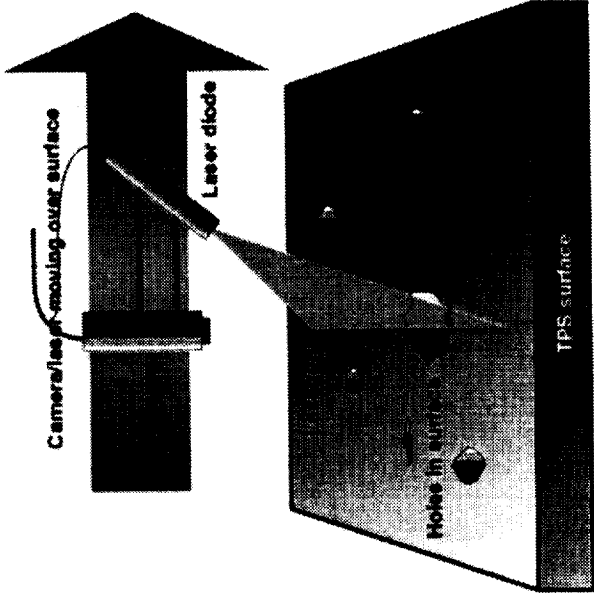
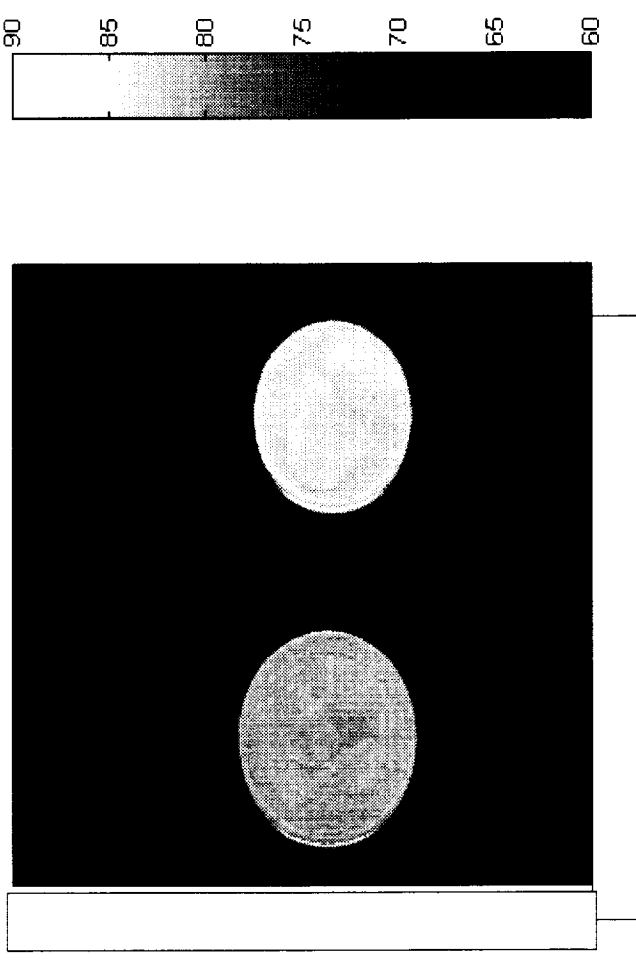

Image of coins and holes from pre-prototype
(shading indicates depth)



Theory of Operation

- The camera/laser sensor head moves across the surface.
- A straight laser line is projected down onto the surface at an angle from normal.
- Distortions in the reflected line indicate the depth of the surface.
- The prototype will use two lasers to eliminate masking effects.

3rd Gen Airframe/TPS:

Thermal Protection Systems

◆ **Advanced, High Temperature Structural Seals**

- **POC:**

- patrick.dunlap@grc.nasa.gov

3rd Gen Airframe/TPS:

Thermal Protection Systems

Advanced High Temperature Structural Seals

- ◆ Technology goals and objectives
 - Development and testing of advanced high temperature structural seal concepts for control surfaces of new generation of small reusable launch vehicles
- ◆ Background
 - Control surfaces of reusable launch vehicles require resilient seals to block high temperature flow between components that move relative to one another for multiple cycles
 - Current seal designs exhibit loss of resiliency after repeated load cycles at high temperatures
 - Advanced seals are required with higher levels of resiliency, flexibility, temperature endurance, and flow blocking capabilities
- ◆ Significant program synergy with X-38 (CRV) control surface seal testing at JSC & GRC as well as X-37 program
- ◆ TPS-20 program partners:
 - NASA GRC lead
 - NASA Ames & Boeing support



3rd Gen Airframe/TPS:

Thermal Protection Systems

Advanced High Temperature Structural Seals

◆ Major accomplishments

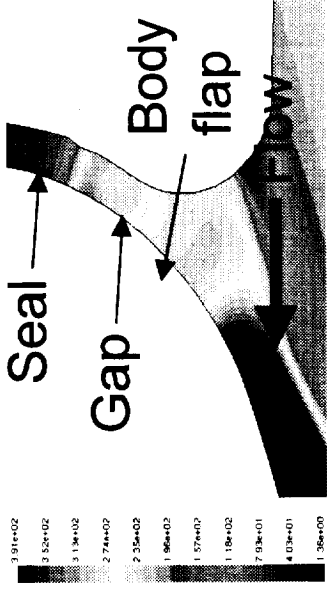

⇐ Preliminary aerothermal analyses revealed X-38 body flap seal temperatures of 2300°F

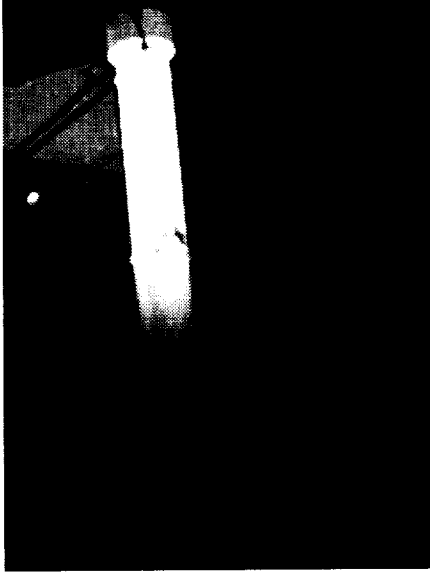

GRC temperature exposure tests show reduction of resiliency & seal preload in ⇒ baseline seal design (used on Shuttle)

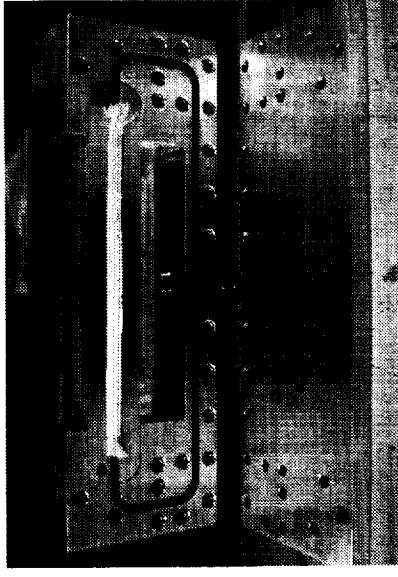

⇐ GRC flow tests of baseline control surface seal before & after temperature exposure showed 25% increase in flow after exposure

3rd Gen Airframe/TPS:

Thermal Protection Systems

Advanced High Temperature Structural Seals

- ◆ Major accomplishments (continued)

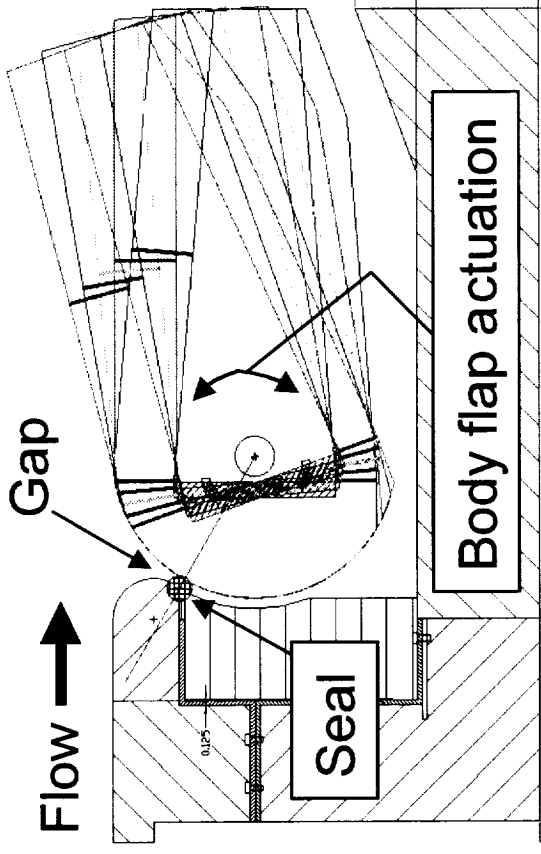
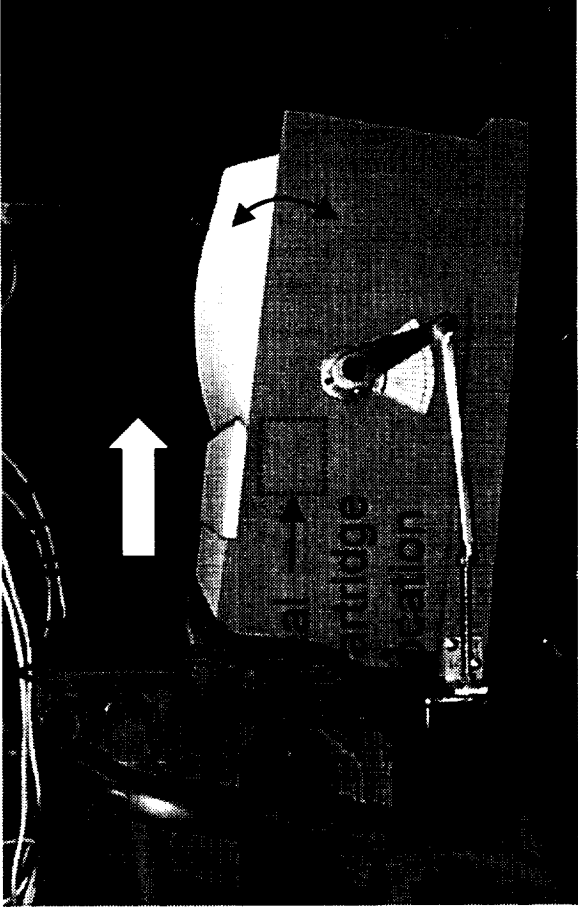

- ◆ Fabricated one-of-a-kind arc jet model to test simulated body flap seals under representative temperature and heating conditions in Ames panel test facility
- ◆ Baseline and advanced seals will be tested using replaceable seal cartridge
- ◆ Upstream and downstream temperature and pressure measurements will be used to validate aerothermal model
- ◆ Body flap actuation during test will be used to assess:
 - ◆ Effects of seal scrubbing
 - ◆ Increased aerothermal loads due to body flap deflection

3rd Gen Airframe/TPS:

Thermal Protection Systems

Advanced High Temperature Structural Seals

- ◆ **Current status**
 - Element seal designs (Gen 1) identified and will be tested at Ames arc jet test facility (1QFY01)
 - Arc jet test fixture being assembled and instrumented at Ames
- ◆ **Near term plans & milestones**
 - Complete fabrication of arc jet test fixture
 - Complete arc jet tests on baseline and advanced seal designs (Gen 1/Gen 2) at Ames
 - Validate aerothermal model based on results of arc jet testing
 - Assess gap width effects on seal heating rates & maximum temperatures
 - Assess effects of seal flow rates on maximum seal temperatures
- ◆ **Contact info:**
 - Dr. Bruce M. Steinetz, (216) 433-3302, Bruce.M.Steinetz@grc.nasa.gov
 - Patrick H. Dunlap, Jr., (216) 433-6374, Patrick.H.Dunlap@grc.nasa.gov

3rd Gen Airframe/TPS:

Thermal Protection Systems

◆ UHTC Sharp Leading Edges

• POC's:

- ARC: jdbull@mail.arc.nasa.gov
- Jeff Bull 650-604-5377
- GRC: slevine@grc.nasa.gov
- Stan Levine 216-433-3246
- LaRC: d.e.glass@larc.nasa.gov
- David Glass 757-864-5423

3rd Gen Airframe/TPS:

Thermal Protection Systems

UHTC Sharp Leading Edges

- ◆ **Goal:** Advance TRL of UHTC sharp leading edges
- ◆ **Background:** UHTC sharp leading edges have been demonstrated in flight and ground tests to operate at temperatures as high as 5100 °F. The TRL of these materials and systems must be advanced in order for them to be adopted in viable sharp leading edged aerospace vehicles.
- ◆ **Major Accomplishments:**
 - ARC: Measured the thermal and mechanical properties of ZrB₂/SiC (ZS), ZrB₂/C/SiC (ZCS), and HfB₂/SiC (HS) at 72, 742, 2192 and 2552 °F. Performed process refinement based on results of post-mortem micro-structural analysis of sharp leading edge components and flexure bars. Integrated NASA GRC CARES into UHTC design tools.

3rd Gen Airframe/TPS:

Thermal Protection Systems

UHTC Sharp Leading Edges

- ◆ **Major Accomplishments (cont.):**
 - GRC: Hyper-X, Mach 10 selected for sharp leading edge case example. Identified low cost leading edge transition material (Honeywell C/SiC). Developed preliminary designs for leading edge using C/SiC transition to UHTC. Modified NASA CARES for use with ARC finite element analysis application (MARC).

- ◆ **Near Term Plans:**
 - ARC: Characterize UHTC materials. Process thermal mechanical data and update UHTC engineering database (TPSX). Identify ground test facility, geometry, and conditions for joint center evaluation of sharp leading edge systems per PLT (7/01).
 - GRC: Continue development of transition material. Hold PDR on sharp leading edge design (9/01).
 - ARC, GRC, LaRC: Investigate improved sharp leading edge materials, coated CMCs, improved UHTC compositions, etc.

3rd Gen Airframe/TPS:

Thermal Protection Systems

- ◆ Felts
 - POC's:
 - Christine Johnson
 - NASA Ames Research Center
 - cjohnson@mail.arc.nasa.gov
 - (650) 604-6395
 - Marc Rezin
 - NASA Ames Research Center
 - mrezin@mail.arc.nasa.gov
 - (650) 604-6163

3rd Gen Airframe/TPS:

Thermal Protection Systems

High Temperature Felt TPS

- **Technology Goals and Objectives**
Development of a family of low cost, high temperature felts with multiple use temperature limits of up to 1500°F. By blending fibers of several types (carbon, refractory oxide, organic, and pre-ceramic), specific combinations of durability, temperature capability and cost can be produced.
- **Background**
Current felt TPS (FRSI) has a multiple use temperature limit of 750°F, limiting its areas of use. Current TPS blankets (AFRSI) for multiple use up to 1500°F are more costly, less durable, and requires more labor for inspection and repair than the felt TPS under development in this task.
High Temperature Felts contribute to lower initial and recurring costs for Reusable Launch Vehicles while enhancing their rapid turn-around capability.

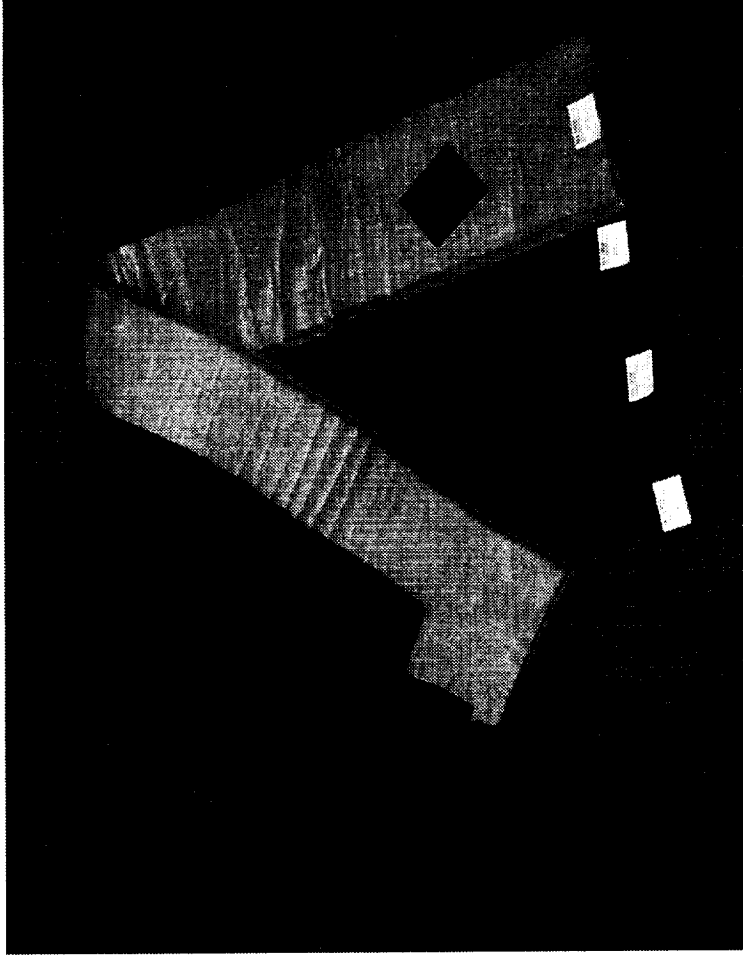

3rd Gen Airframe/TPS:

Thermal Protection Systems

High Temperature Felt TPS

- **Current Status, Major Accomplishments**

Four different organo-ceramic hybrid felt types and three carbon-based felts have been fabricated. Coupon-level thermo-chemical stability assessment and mechanical property testing has produced promising results.

- **Near Term Plans**

Component-level thermo-chemical stability assessment in the Ames AHF arc jet facility, and durability screening in a vibro-acoustic environment, are currently scheduled for the week of 11/13/00.

3rd Gen Airframe/TPS:

Thermal Protection Systems