

# Optimal Inflatable Space Towers with 3 - 100 km Height

**ALEXANDER BOLONKIN**

Senior Research Associate of NRC in Eglin AFB, USA

Former Senior Researcher of NASA

5 Mooney Road, #E-10, Fort Walton Beach, FL 32547, USA or 1310 Avenue R, #6-F, Brooklyn, NY 11229, USA.

Email: Bolonkin@aol.com

---

Theory and computations are provided for building inflatable space towers up to one hundred kilometres in height. These towers can be used for tourism, scientific observation of space, observation of the Earth's surface, weather and upper atmosphere, and for radio, television, and communication transmissions. These towers can also be used to launch space ships and Earth satellites.

These projects are not expensive and do not require rockets. They require thin strong films composed from artificial fibers and fabricated by current industry. The towers can be built using present technology. The towers can be used (for tourism, communication, etc.) during the construction process and provide self-financing for further construction. The tower design does not require work at high altitudes; all construction can be done at the Earth's surface.

The transport system for a tower consists of a small engine (used only for friction compensation) located at the Earth's surface. The tower is separated into sections and has special protection mechanisms in case of damage.

Problems involving security, control, repair, and stability of the proposed towers are addressed in other publications. The author is prepared to discuss these and other problems with serious organizations desiring to research and develop these projects.

**Keywords:** Space tower, inflatable, high height, optimal.

---

## 1. Introduction

### 1.1 Brief History

The idea of building a tower high above the Earth into the heavens is very old [1]. The writings of Moses, about 1450 BC, in his book *Genesis*, Chapter 11, refer to an early civilization that in about 2100 BC tried to build a tower to heaven out of brick and tar. This construction was called the Tower of Babel, and was reported to be located in Babylon in ancient Mesopotamia. Later in Chapter 28, about 1900 BC, Jacob had a dream about a staircase or ladder built to heaven. This construction was called Jacob's Ladder. More contemporary writings on the subject date back to K.E. Tsiolkovski in his manuscript "Speculation about Earth and Sky and on Vesta," published in 1895 [2]. This idea inspired Sir Arthur Clarke to write his novel, *The Fountains of Paradise* [3], about a space tower (elevator) located on a fictionalized Sri Lanka, which brought the concept to the attention of the entire world.

Today, the world's tallest construction is a television transmitting tower near Fargo, North Dakota,

USA. It stands 629 m high and was built in 1963 for KTHI-TV. The CNN Tower in Toronto, Ontario, Canada is the world's tallest building. It is 553 m in height, was built between 1973-1975, and has the world's highest observation desk at 447 m. The tower structure is concrete up to the observation deck level. Above is a steel structure supporting radio, television, and communication antennas. The total weight of the tower is 3,000,000 tons.

The Ostankin Tower in Moscow is 540 m in height and has an observation desk at 370 m. The world's tallest office building is the Petronas Towers in Kuala Lumpur, Malaysia. The twin towers are 452 m in height. They are 10 m taller than the Sears Tower in Chicago, Illinois, USA.

Current materials make it possible even today to construct towers many kilometers in height. However, conventional towers are very expensive, cost-

ing tens of billions of dollars. When considering how high a tower can be built, it is important to remember that it can be built to any height if the base is large enough. Theoretically, a tower could be built to geosynchronous Earth orbit (GEO) out of bubble gum, but the base would likely cover half the surface of the Earth.

The proposed inflatable towers are cheaper in lots of hundreds. They can be built on the Earth's surface and their height can be increased as necessary. Their base is not large. The main innovations in this project are the application of helium, hydrogen, or warm air for filling inflatable structures at high altitude, a solution of the stability problem for tall (thin) inflatable columns, and the utilization of new artificial materials [4]-[7].

### 1.2 Tower applications

The inflatable high towers (3-100 km high) have numerous applications for government and commercial purposes:

- Entertainment and Observation platform:
- Entertainment and Observation deck for tourists. Tourists could see over a huge area, including the darkness of space and the curvature of the Earth's horizon.
- Drop tower. Tourists could experience several minutes of free-fall time. The drop tower could also provide a facility for experiments.
- A permanent observatory on a tall tower would be

competitive with airborne and orbital platforms for Earth and space observations.

- Communication boost: A tower tens of kilometers in height near metropolitan areas could provide much higher signal strength than orbital satellites.
- Solar power receivers: Receivers located on tall towers for future space solar power systems would permit use of higher frequency, wireless, power transmission systems (e.g. lasers).
- Low Earth Orbit (LEO) communication satellite replacement: Approximately six to ten 100-km tall towers could provide the coverage of a LEO satellite constellation with higher power, permanence, and easy upgrade capabilities.

Other new revolutionary methods of access to space are described in [8]-[16].

## 2. Description of Innovation and Problem

### 2.1 Tower structure

The simplest tourist tower (Fig. 1) includes: Inflatable column, top observation deck, elevator, expansions, and control stability. The tower is separated into sections by horizontal and vertical partitions (Fig. 2) and contains entry and exit air lines and control devices.

### 2.2 Filling Gas

The compressed air filling the inflatable tower provides the weight. Its density decreases at high altitude and it cannot support a top tower load. It is

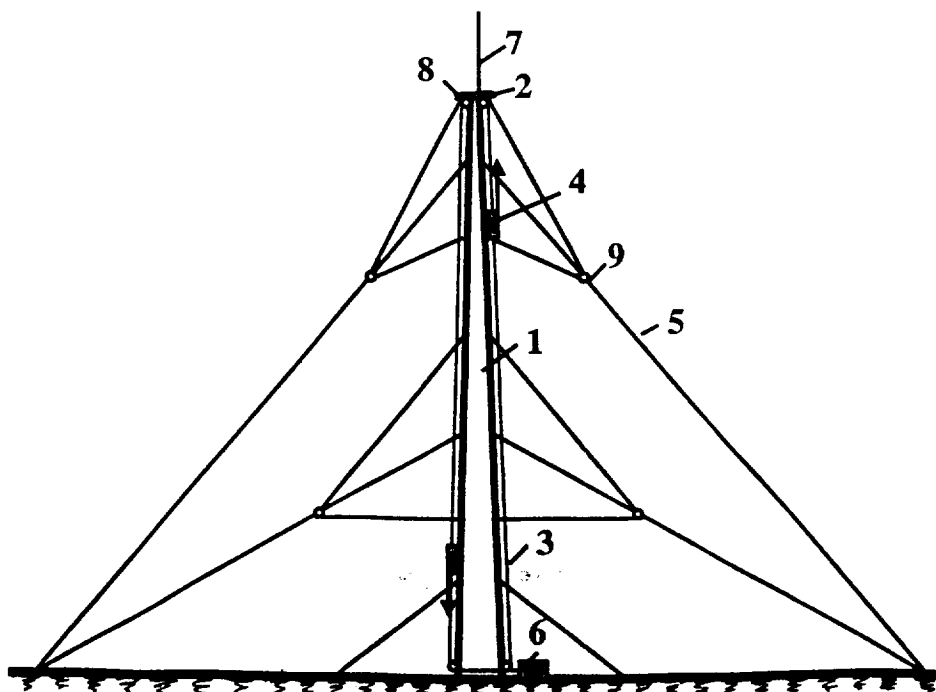
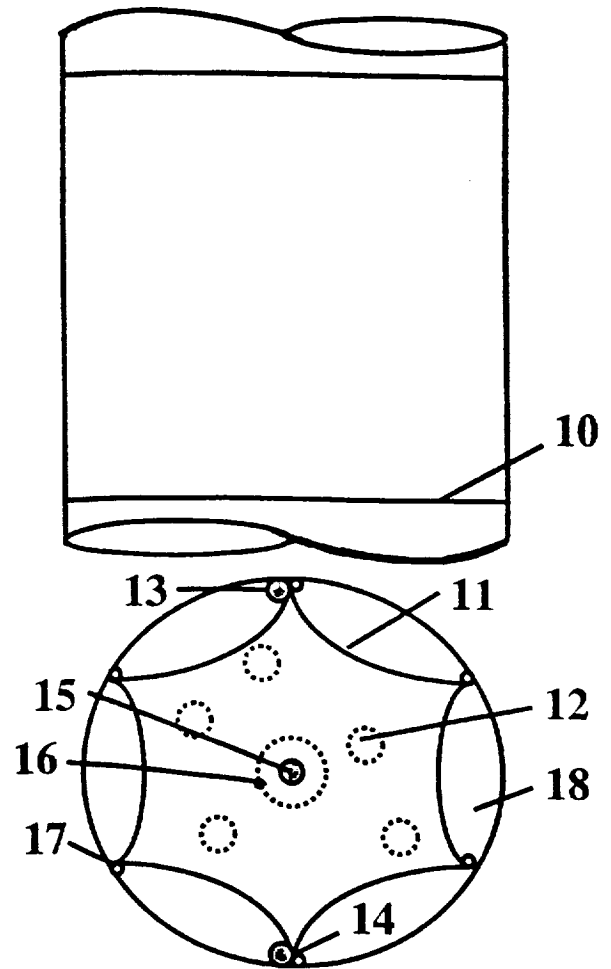

Fig. 1 Inflatable tower of height 3 km (10,000 ft.). Notations: 1. Inflatable column of radius 5 m; 2. observation desk; 3. load cable elevator; 4. passenger cabin; 5. expansion; 6. engine; 7. radio and TV antenna; 8. rollers of cable transport system; 9. control of stability.

Fig.2. Section of inflatable tower. Key: 10. horizontal film partitions; 11. light second film (internal cover); 12. air balls; 13. entrance line of compression air and pressure control; 14. exit line of air and control; 15. control laser beam; 16. sensors of laser beam location; 17. control cables and devices; 18. section volume.



suggested that the towers are filled with a light gas, for example, helium, hydrogen, or warm air. The computations for changing pressure of air, helium, and hydrogen are presented in fig. 3 [Eq. (1)]. If all the gases have the same pressure (1.1 atm) at the Earth's surface, then their columns have very different pressures at 100 km altitude. Air has 0 atm, hydrogen has 0.4 atm, and helium has 0.15 atm. A pressure of 0.4 atm means that every square meter of a tower top can support 4 tons of useful load. Helium can support only 1.5 tons.

Unfortunately, hydrogen is dangerous, as it can burn. The catastrophes involving dirigibles are sufficient illustration of this. Hydrogen can be used only above altitudes of 13-15 km, where the atmospheric pressure decreases by ten times and the probability of hydrogen burning is small.

The average temperature of the atmosphere in the interval from 0 to 100 km is about 240 °K. If a tower is made from a dark material, then the temperature inside the tower will be higher than the temperature of the atmosphere at a given altitude in day time, so that the tower support capability will be greater [Eq. (1)].

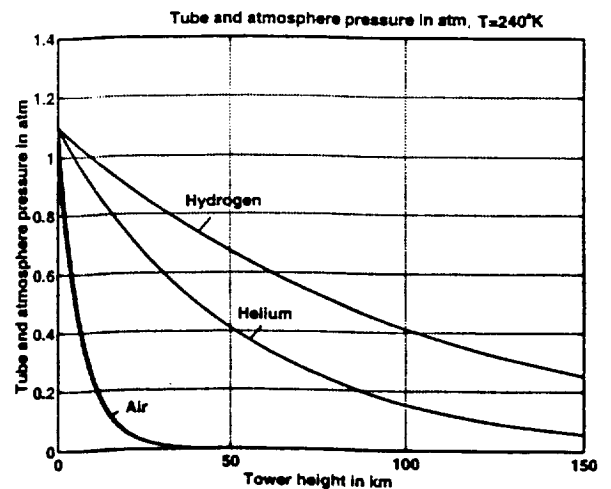

Fig. 3 Variation of the hydrogen, helium, and air pressure versus height in the interval 0 - 150 km of altitude.

The observation radius versus altitude is presented in figs. 4 & 5.

### 2.3 Tower Material

Only old (1973) information about textile fiber for inflatable structures has been located [4]. This is for DuPont textile Fiber *B* and Fiber *PRD-49* for tire cord. They are six times as strong as steel (400,000

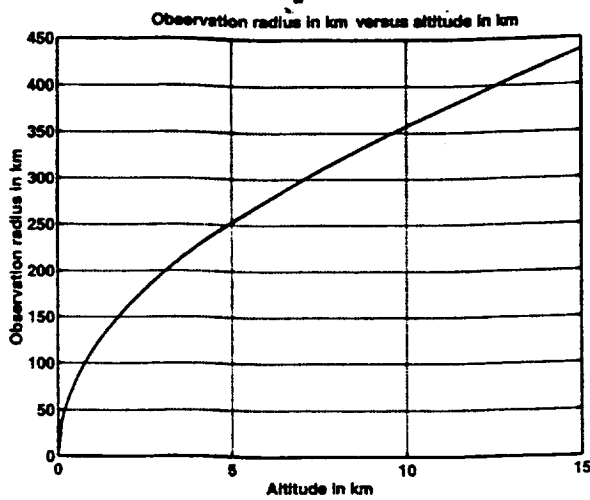

Fig. 4 Observation radius for altitudes up to 15 km.

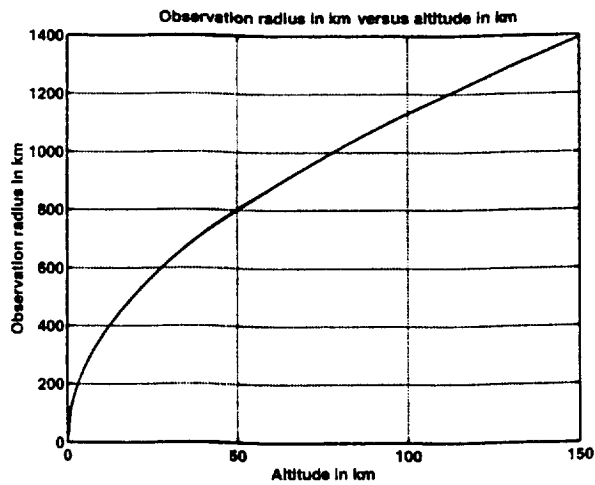

Fig.5. Observation radius for altitudes up to 150 km.

psi or 312 kg/mm<sup>2</sup>) with a specific gravity of only 1.5. The minimum available yarn size (denier) is 200, the tensile modulus is  $8.8 \times 10^6$  (B) and  $20 \times 10^6$  (PRD-49), and the ultimate elongation (percent) is 4 (B) and 1.8 (PRD-49).

The tower parameters vary depending on the strength of textile material (film), specifically the relation of the admissible tensile stress  $\sigma$  to specific density  $\gamma$ . Current industry widely produces artificial fibers having tensile stress  $\sigma = 500-620$  kg/mm<sup>2</sup> and density  $\gamma = 1800$  kg/m<sup>3</sup>. Their ratio is  $K = 10^{-7} k = 10^7 \sigma/\gamma = 0.28-0.34$ . There are whiskers (in industry) and nanotubes (in the laboratory) having  $K = 1-2$  (whiskers) and  $K = 5-11$  (nanotubes). Theory predicts fibers, whiskers and nanotubes having  $K$  ten times greater [5]-[7].

The tower parameters have been computed for  $K = 0.05 - 0.3$ , with a recommend value of  $K = 0.1$ . The reader can estimate tower parameters for other strength ratios.

## 2.4 Tower Safety

It is a common assumption that inflatable construction is dangerous, on the basis that a small hole (damage) could deflate the tower. However that assumption is incorrect. The tower will have multiple vertical and horizontal sections, double walls (covers), and special devices (e.g., air balls) which will temporarily seal a hole. If a tower section sustains major damage, the tower height is only decreased by one section. This modularity is similar to combat vehicles. Bullets many damage its tires, but the vehicle continues to operate.

## 2.5 Tower Stability

Stability is provided by expansions (tensile elements). The verticality of the tower can be checked by laser beams and sensors monitoring beam location (Fig. 2). If a section deviates from the vertical, control cables, control devices, and pressure changes restore the tower position.

## 2.6 Tower Construction

The tower building will not have conventional construction problems such as lifting building materials to high altitude. All sections are identical. New sections are put under the tower, the new section is inflated, and the entire tower is lifted. It is estimated that the building may be constructed in 2-3 months. A small tower (up to 3 km) can be located to city.

## 2.7 Tower Cost

The inflatable tower does not require high cost building materials. The tower will be a hundred times cheaper than conventional solid towers 400-600 m tall.

## 3. Theory of Inflatable Towers

The equations developed and used for estimation and computation are provided below. All equations are in the metric system

### 1. The pressure of any gas in a column versus altitude

For a given molecular weight  $\mu$ , temperature  $T$  of an atmosphere gas mixture, and gravity  $g$  of planet, then the atmosphere pressure  $P$  versus altitude  $H$  may be calculated using the equation

$$P = P_0 \exp(-\mu g H / RT) \text{ or } P_r = P/P_0 = \exp(-aH), \quad (1)$$

where  $P_0$  is the pressure at the planet surface (for the Earth  $P_0 = 10^5$  [n/m<sup>2</sup>]), and  $R = 8314$  is the

gas constant. For air,  $\mu = 28.96$ ; for hydrogen,  $\mu = 2$ ; for helium  $\mu = 4$ ;  $a = \mu g / (RT)$ .

## 2. Optimal cover thickness and tower radius

Consider a small horizontal cross-section of tower element. Using the known formulas for mass and stress, then

$$\begin{aligned} Pds = gdm, \quad dm = 2\pi r \gamma \delta dH, \quad s = \pi(R^2 - r^2), \\ R = r + dr, \quad ds = 2\pi r dr, \end{aligned} \quad (2)$$

where  $m$  = cover mass [kg],  $\gamma$  = cover specific weight [kg/m<sup>3</sup>],  $\sigma$  = cover tensile stress [n/m<sup>2</sup>],  $d$  = sign of differential,  $s$  = tower cross-section area which support a tower cover [m<sup>2</sup>],  $g = 9.81$  [m/sec<sup>2</sup>] gravity,  $R, r$  = radius of tower [m].  $\pi = 3.14$ ,  $P$  is surplus internal gas pressure over outside atmosphere pressure [n/m<sup>2</sup>]. Substituting the above formulas in the first equation gives

$$pdr = g\gamma\delta dH, \quad (3)$$

From the equation of stress the cover thickness

$$2\pi R P dH = 2\delta \sigma dH \text{ or } \delta = \pi R P / \sigma \quad (4)$$

Substituting (4) into (3) and integrating gives

$$R = R_0 \exp(-\pi g H / k) \text{ or } R_r = R / R_0 = \exp(-\pi g H / k), \quad (5)$$

where  $R_r$  is the relative radius,  $R_0$  is the base tower radius [m], and  $k = \sigma / \gamma$ .

## 3. Tower lift force $F$

$$F = PS, \quad S = S_0 S_r, \quad S_r = \pi(R_r R_0)^2 / S_0, \quad S = S_0 R_r^2, \quad (6)$$

$$F = P S_0 R_r^2, \quad (7)$$

where  $S_0 = \pi R_0^2$  is the cross-section tower area at  $H = 0$ , and  $S_r = S / S_0$  is the relative cross-section tower area.

Substituting (1) and (5) in (7) gives

$$\begin{aligned} F = P_0 S_0 \exp[-(a+2\pi g/k)H] \text{ or} \\ F_r = F / P_0 S_0 = \exp[-(a+2\pi g/k)H], \end{aligned} \quad (8)$$

where  $F_r$  is the relative force.

## 4. Base area for a given top load $W$ [kg].

The required base area  $S_0$  (and radius  $R_0$ ) for a given top load  $W$  may be found from (8) if  $F = gW$ .

$$P_0 S_0 = gW / F_r(H_{max}) \text{ and } R_0 = (S_0 / \pi)^{1/2}. \quad (9)$$

## 5. Mass of cover.

From (2)

$$dm = 2\pi R \gamma \delta dH. \quad (10)$$

Substituting (1), (4) and (5) in (10) gives

$$dm = (2\pi/k) P_0 S_0 \exp[-(a+2\pi g/k)H] dH. \quad (11)$$

Integrating this relation from  $H_1$  to  $H_2$ , gives

$$M = [2\pi P_0 S_0 / k(a+2\pi g/k)] [F_r(H_1) - F_r(H_2)], \quad (12)$$

or the relative mass equals (for  $H = 0$ )

$$M_r = M / (P_0 S_0) = [2\pi/k(a+2\pi g/k)] (1 - F_r). \quad (13)$$

## 6. Thickness of a tower cover

This may be found from (4), (5) and (1)

$$\delta = (\pi \gamma / k) P_0 R_0 \exp[-(a + \pi g/k)H]. \quad (14)$$

The relative thickness equals

$$\delta_r = \delta / P_0 R_0 = (\pi \gamma / k) \exp[-(a + \pi g/k)H]. \quad (15)$$

## 7. Maximum admissible bending moment

This quantity, for example from the wind, equals [see (8),(5)]

$$M_b = FR = R_0 P_0 S_0 R_r F_r, \quad (16)$$

Or the relative bending moment is

$$M_{br} = M_b / (R_0 P_0 S_0) = R_r F_r. \quad (17)$$

## 8. Gas mass $M$ into tower

Write the gas mass in a small volume and integrate this expression for altitude

$$dm_g = \rho dV, \quad dV = \pi R^2 dH, \quad \rho = \mu P / RT = \rho_0 P_r, \quad (18)$$

where  $V$  is volume,  $\rho$  is gas density,  $\rho_0$  is gas density at altitude  $H_1$ . Substituting  $P_r$  from (1), integrating, and substituting  $F_r$  from (8), gives

$$M_g = [\pi \rho_0 R_1^2 / (a+2\pi g/k)] [F_r(H_1) - F_r(H_2)], \quad (19)$$

where lower index "1" means values for lower end and "2" means values for top end.

The relative gas mass is

$$M_{gr} = M_g / \rho_0 R_1^2 = [\pi / (g+2\pi g/k)] [F_r(H_1) - F_r(H_2)]. \quad (20)$$

9. Base tower radius

From (8) for  $F = gW$ , then

$$R_1 = (gW/\pi P_1 R_p)^{1/2}, \quad (21)$$

where  $W$  is the top load {kg}.

10. Tower mass  $M$  [kg]

$$M = \pi R_1^2 P_1, \quad (22)$$

11. Viewing distance

The distance  $L$  which can be viewed of the Earth from a high tower is given by

$$L = (2R_p H + H^2)^{0.5}, \quad (23)$$

where  $R_p = 6,378$  km is the Earth radius. The results of computation are presented in figs.4-5.

4. Project 1 - A Simple Air Tower of 3 km Height (Base Radius 5 m, 15 ft.,  $K=0.1$ )

This inexpensive project provides experience in design and construction of a tall inflatable tower, and in its stability. The project also provides funds from tourism, radio and television. The inflatable tower has a height of 3 km (10,000 ft). Tourists will not need a special suit or a breathing device at this altitude. They can enjoy an Earth panorama in radius up to 200 km. The bravest of them could experience 20 seconds of free-fall time followed by 2g overload.

4.1 Results of Computations

Assume the additional air pressure is 0.1 atm, the air temperature is 288 °K (15 °C, 60 °F), and the base radius of tower is 5 m. Take  $K = 0.1$ . Computations of the radius are presented in fig.6. If the tower cone is optimal, the tower top radius must be 4.55 m. (Fig.6). The maximum useful tower top lift is 46 tons (Fig.7). The cover thickness is 0.087 mm at the base and 0.057 mm at the top (Fig.8). The outer cover mass is only 11.5 tons (Fig.9). If light internal partitions are added, the the total cover weight will be about 16 - 18 tons (compared to the 3 million tons of the 553 m tower at Toronto). The maximum admissible bending moment versus altitude (presented in Fig.10) ranges from 390 ton\*meter (at the base) to 210 ton\*meter at the tower top.

4.2 Economical Efficiency

Assume the cost of the tower is \$5 million, the

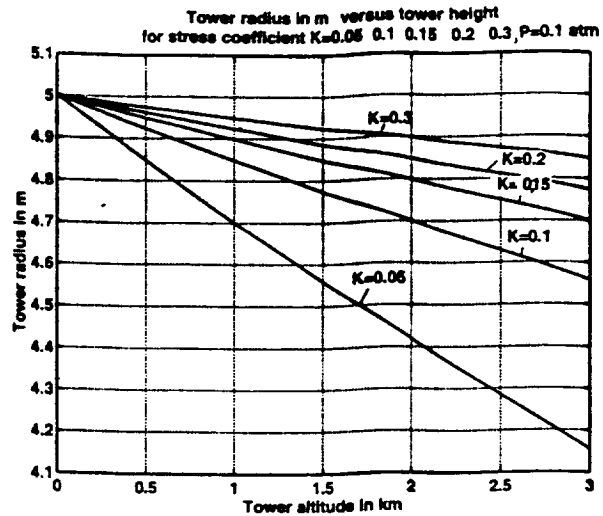

Fig. 6 Tower radius versus tower height for the 3 km air tower.

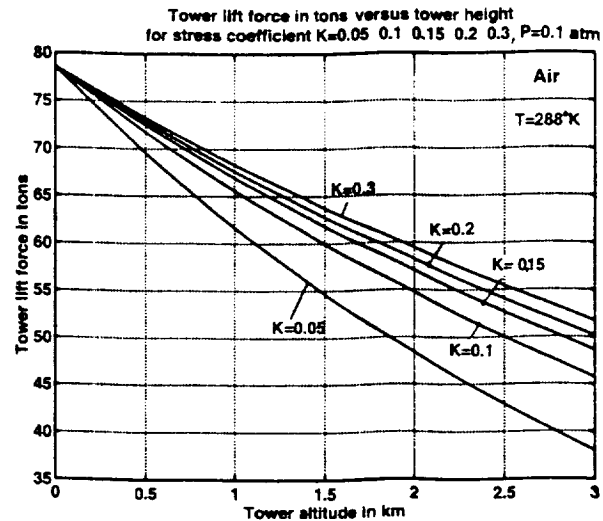

Fig. 7 Tower lift force versus tower height for the 3 km air tower.

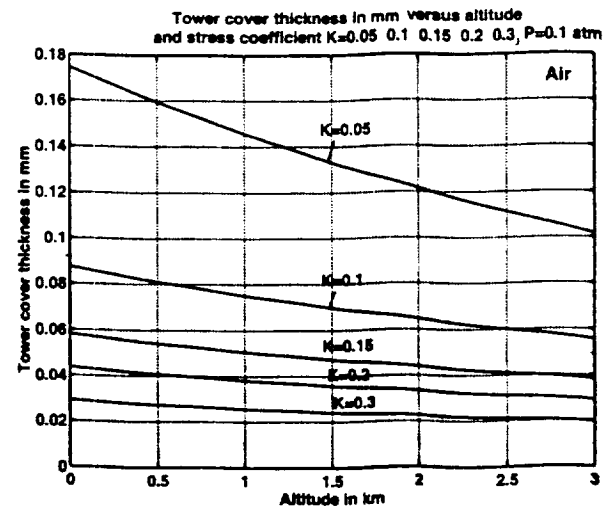

Fig. 8 Tower cover thickness for the 3 km air tower.

lifetime is 10 years, the annual maintenance \$1 million, the number of tourists at the tower top is 200 (15 tons), the time at the top is 0.5 hour, and

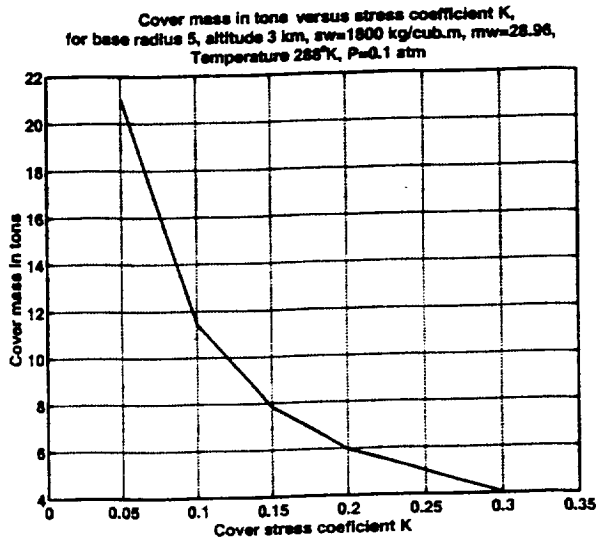

Fig. 9 Cover mass of the 3 km air tower versus stress coefficient.

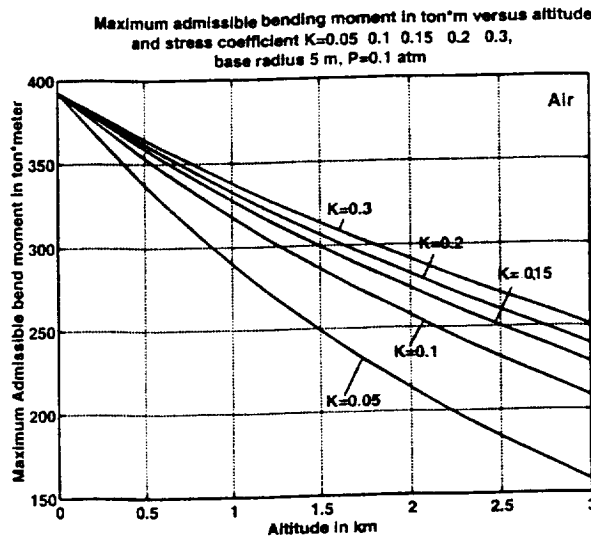

Fig. 10 Maximum admissible bending moment.

that the tower is open 12 hours per day. Then 4800 tourists will visit the tower per day, or 1.7 million per year. The unit cost of one tourist is  $(0.5+1) \times 10^6 / 1.7 \times 10^6 = 1$  \$/person. If a ticket costs \$9, then the profit is  $1.7 \times 10^6 \times 8 = \$13.6$  million per year. If a drop from the top of the tower (in a special cabin, free-fall (weightlessness) time is 20 sec, followed by overload of 2g) costs \$5 and 20% of tourists take this option, then the additional profit will be \$1.7 million.

## 5. Project 2 - Helium Tower of 30 km Height (base radius 5 m, $K = 0.1$ )

### 5.1 Results of Computation

Take the additional pressure over atmospheric pressure as 0.1 atm. The change of air and helium pres-

sure versus altitude are presented in figs. 3&4. The change of radius versus altitude is presented in fig. 11. For  $K = 0.1$  the radius is 2 m at an altitude of 30 km. The useful lift force is presented in figs. 12,13. For  $K = 0.1$  it is about 75 tons at an altitude of 30 km. It is a factor of two times greater than the air tower of 3 km. This is not surprising, because the helium is lighter than air and it provides a lift force. The cover thickness is presented in fig. 14. It changes from 0.08 mm (at the base) to 0.42 mm at an altitude of 9 km and decreases to 0.2 mm at 30 km. The outer cover mass is about 370 tons (Fig. 15). The required helium mass is 190 tons (Fig.16).

The tourist capability of this tower is two times greater than the three km tower, but all tourists must stay in cabins.

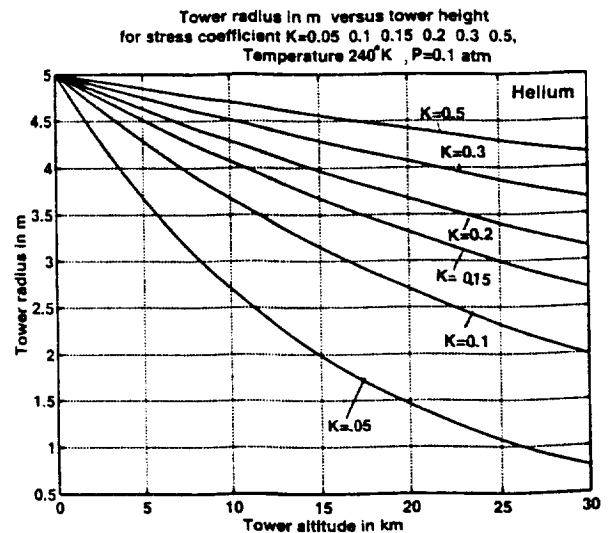

Fig. 11 Tower radius versus tower height for the 30 km helium tower.

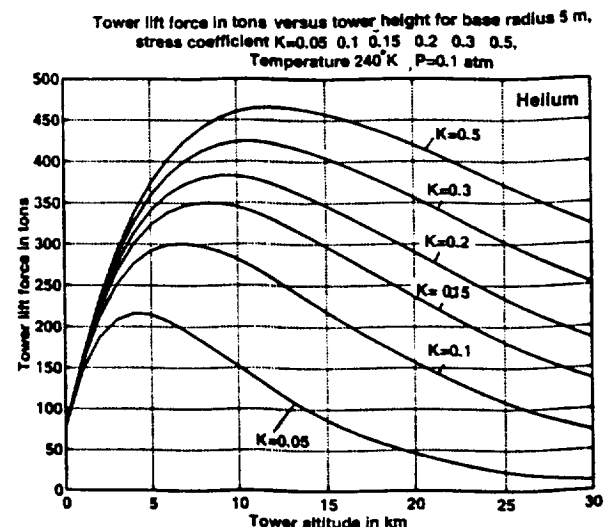

Fig. 12 Tower lift force versus tower height for the 30 km helium tower.

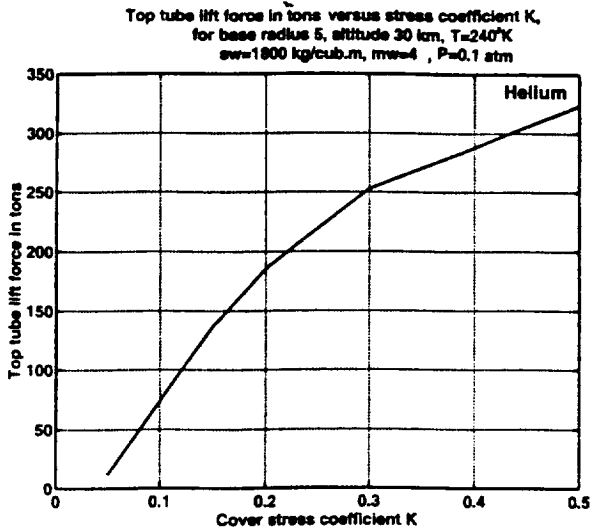

Fig. 13 Top lift force for the 30 km helium tower.

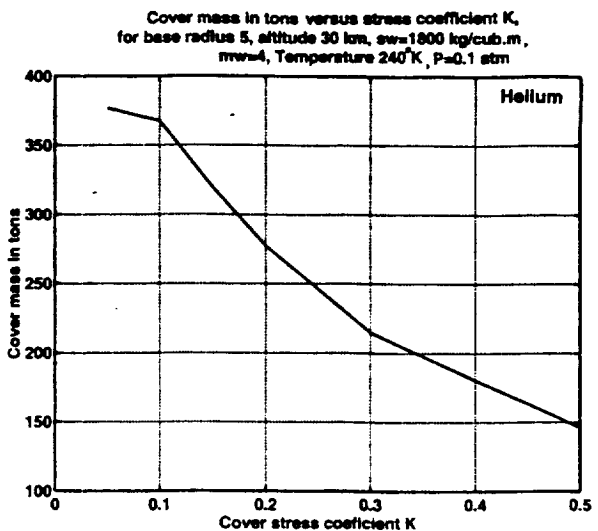

Fig. 15 Cover mass versus stress coefficient for the 30 km helium tower.

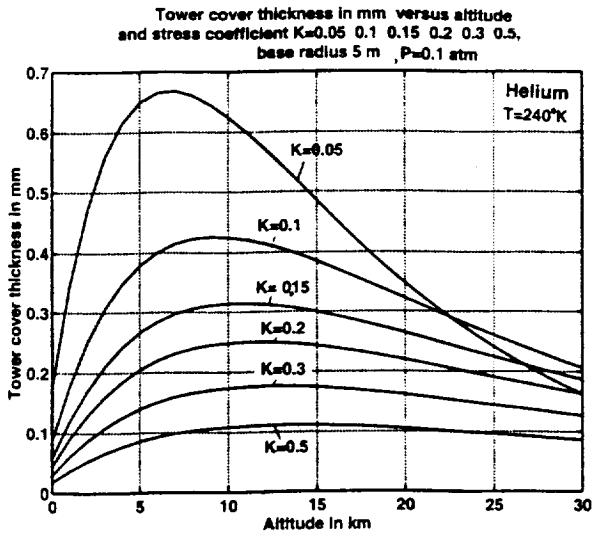

Fig.14 Tower cover thickness versus tower height for 30 km helium tower.

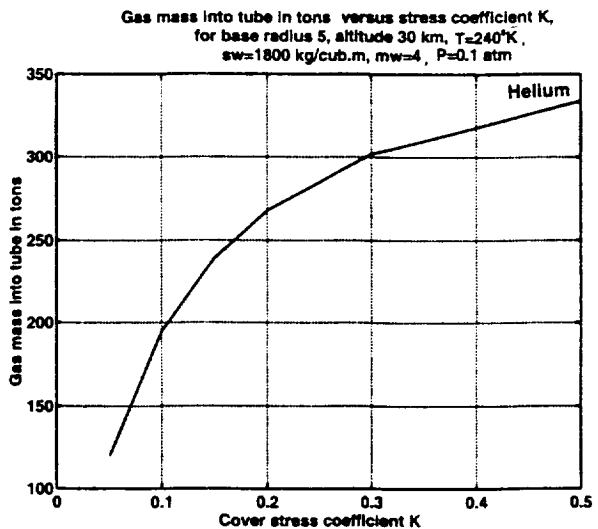

Fig. 16 Helium mass for the 30 km tower.

## 6. Project 3 - Air-Hydrogen Tower of 100 km height (Base Radius of the Air Part is 35 m; the Hydrogen Part has a Base Radius of 5 m)

This tower includes two parts. The lower part (0-15 km) is filled with air. The top part (15-100 km) is filled with hydrogen. It makes this tower safer, because the small atmospheric pressure at high altitude decreases the probability of fire. Both parts may be used for tourists.

### 6.1 Air Part, 0-15 km

The base radius is 25 m, the additional pressure is 0.1 atm, the average temperature is  $240^\circ K$ , and the stress coefficient  $K = 0.1$ . The change of radius is presented in fig. 17, the useful tower lift

force in fig. 18, the tower outer cover thickness in fig. 19, the maximum admissible bending moment in fig. 20, and the cover mass fig. 21. The tower can be used for tourism and as an astronomy observatory. For  $K = 0.1$ , the lower (0-15 km) part of the project requires 570 tons of outer cover (Fig. 21) and provides 90 tons of useful top lift force (Fig. 18).

### 6.2 Hydrogen Part, 15-100 km

This part has a base radius of 5 m, has an additional gas pressure of 0.1 atm, and requires a stronger cover, with  $K = 0.2$ .

The results of computation are presented in the following figures: the change of air and hydrogen pressure versus altitude in fig. 3; the tower radius versus altitude in fig. 22; the tower lift force versus altitude in fig. 23; the tower thickness in fig. 24; the



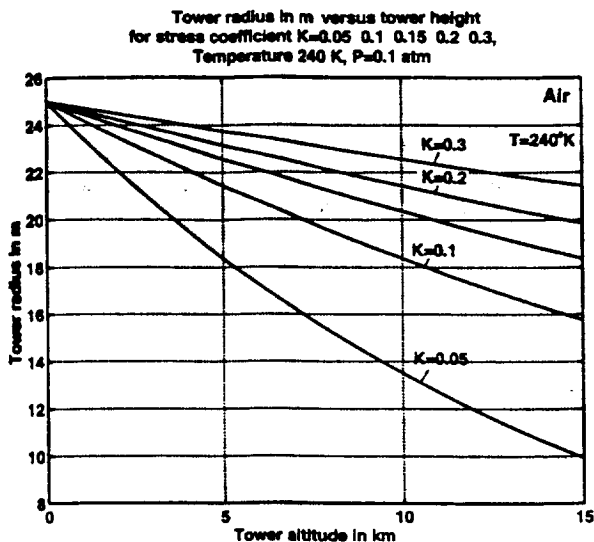

Fig. 17. Air lower part of 100 km tower. Tower radius versus altitude.

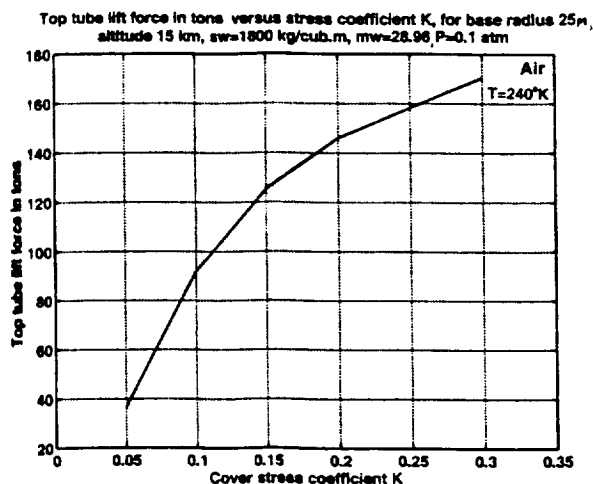

Fig. 18 Air lower part of 100 km tower. Top lift force.

cover mass in fig. 25; the lift force in fig. 26; the hydrogen mass in fig. 27.

The useful top tower load can be about 5 tons maximum for  $K = 0.2$ . The cover mass is 112 tons. The hydrogen lift force is 37 tons. The top tower will press on the lower part with a force of only  $112 - 37 + 5 = 80$  tons. The lower part can support 90 tons.

Readers can easily calculate any variant by using the presented figures.

The proposed projects have optimal change of radius, but a designer must find the optimal combination of the air and gas parts.

## 7. Conclusions

The theory and computation presented here show

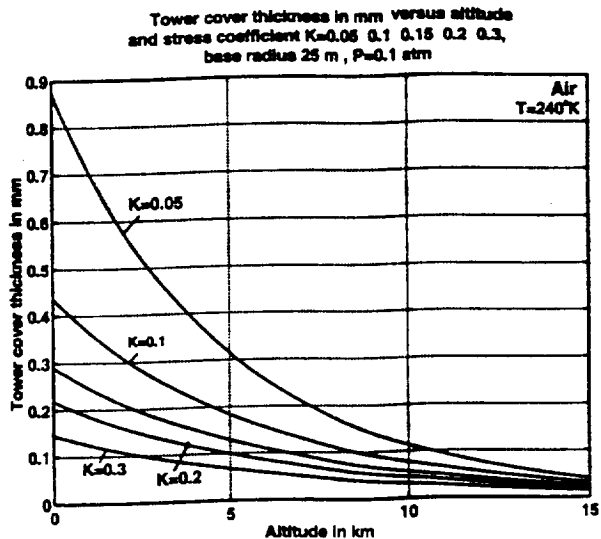

Fig. 19. Air lower part of 100 km tower. Tower cover thickness versus altitude.

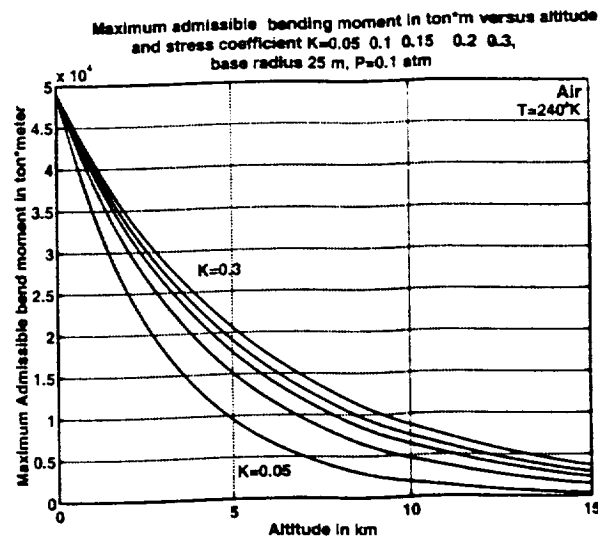

Fig. 20 Air lower part of 100 km tower. Maximum admissible bending moment.

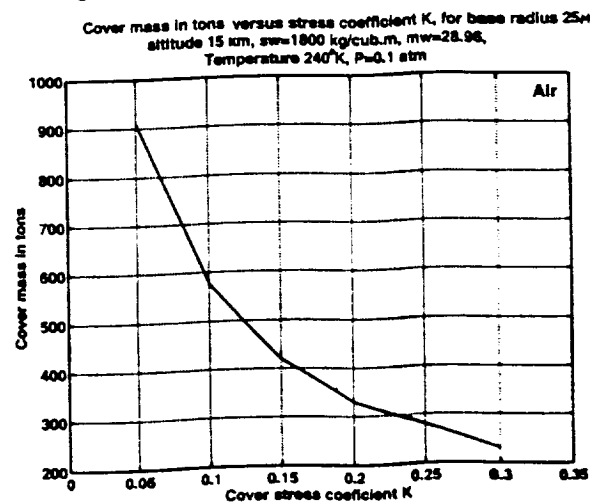

Fig. 21 Air lower part of 100 km tower. Cover mass.

that an inexpensive tall tower can be designed and constructed and can be useful for industry, government and science.

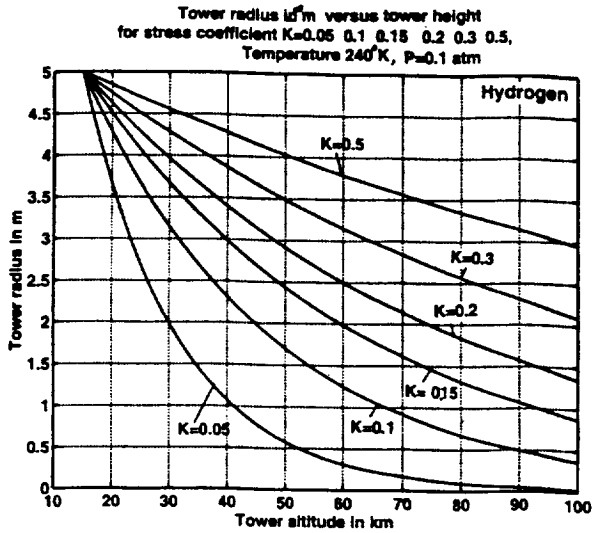

Fig. 22. Hydrogen top part of 100 km tower. Tower radius versus altitude.

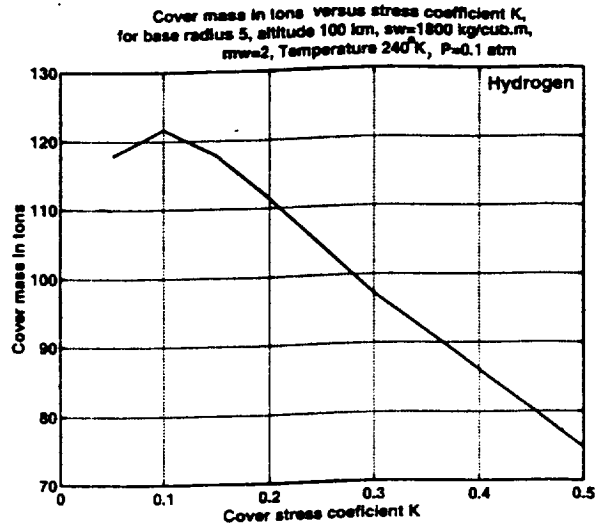

Fig. 25. Hydrogen top part of 100 km tower. Cover mass.

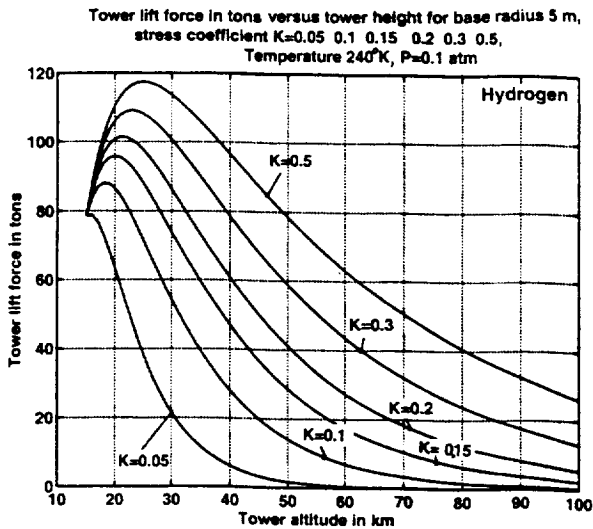

Fig. 23 Hydrogen top part of 100 km tower. Tower lift force versus altitude.

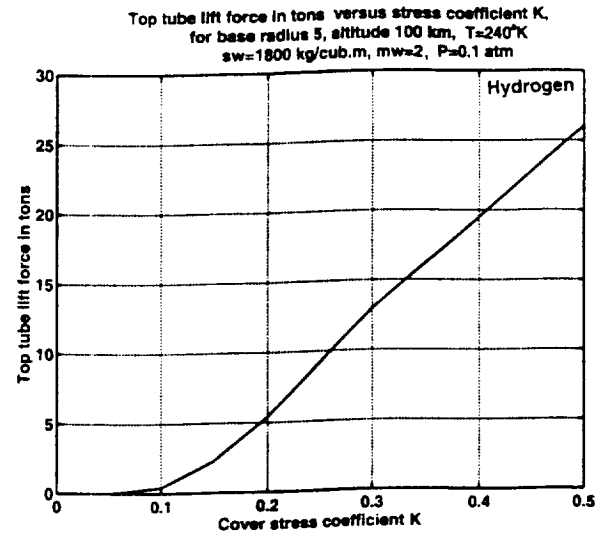

Fig. 26. Hydrogen top part of 100 km tower. Tower top lift force.

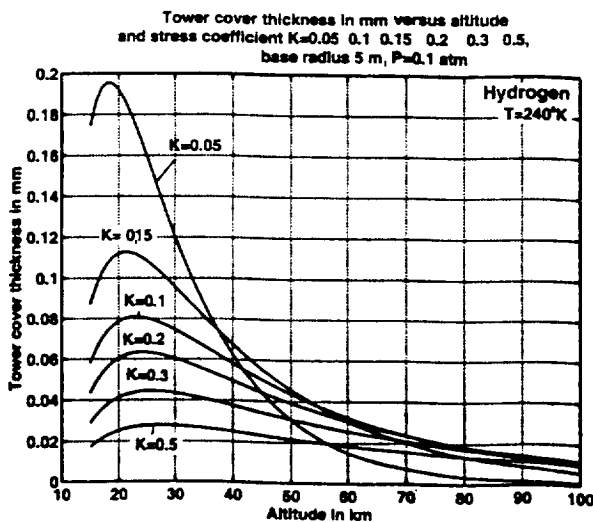

Fig. 24 Hydrogen top part of 100 km tower. Tower cover thickness.

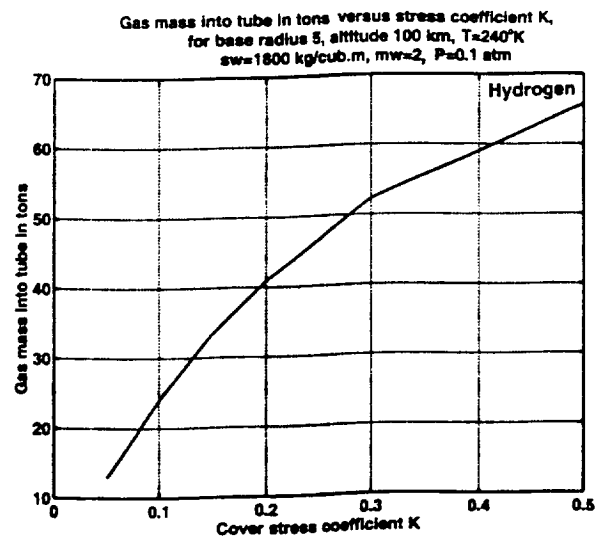

Fig. 27. Hydrogen top part of 100 km tower. Requested hydrogen mass.

The author has developed the innovation, estimates, and computations for the above mentioned problems. Even though these projects may seem impossible for current technology, the author is prepared to discuss the project details with serious organizations that want to develop these projects.

## 8. Acknowledgement

The author wishes to acknowledge Dr. D. Jeffcoat from the Air Force Research Laboratory AFRL/MNG (Eglin AFB, Florida, USA) for his help in editing and correcting the English.

## References

1. D.V. Smitherman, Jr., "Space Elevators", *NASA/CP-2000-210429*, 2000.
2. K.E. Tsiolkovski, "*Speculations About Earth and Sky on Vesta*", Moscow, Izd-vo AN SSSR, 1959; *Grezi o zemle i nebe* (In Russian), Academy of Sciences, U.S.S.R., Moscow, p.35, 1999.
3. A.C. Clarke, "*Fountains of Paradise*", Harcourt Brace Jovanovich, New York, 1978.
4. J.T. Harris, "Advanced Material and Assemble Methods for Inflatable Structures", AIAA Paper No. 73-448 (1973).
5. F.S. Galasso, "*Advanced Fibers and Composites*", Gordon and Breach Science Publishers, 1989.
6. "*Carbon and High Performance Fibers*", Directory, 1995.
7. M.S. Dresselhaus, "*Carbon Nanotubes*", Springer, 2000.
8. A.A. Bolonkin, "Hypersonic Gas-Rocket Launch System", *AIAA-2002-3927*, 38<sup>th</sup> AIAA/ASME/SAE/ASEE Joint Propulsion Conference and Exhibit, 7-10 July, 2002, Indianapolis, IN, USA.
9. A.A. Bolonkin, "Transport System for Delivery Tourist at Altitude 140 km and back", *IAC-02-IAA.1.3.03*, 53<sup>rd</sup> International Astronautical Congress - The World Space Congress - 2002, 10-19 Oct 2002, Houston, Texas.
10. A.A. Bolonkin, "Non-Rocket Missile Rope Launcher", *IAC-02-IAA.S.P.14*, 53<sup>rd</sup> International Astronautical Congress - The World Space Congress - 2002, 10-19 Oct 2002, Houston, Texas.
11. A.A. Bolonkin, "Hypersonic Launch System of Capability up 500 tons per day and Delivery Cost \$1 per Lb", *IAC-02-S.P.15*, 53<sup>rd</sup> International Astronautical Congress - The World Space Congress - 2002, 10-19 Oct 2002, Houston, Texas.
12. A.A. Bolonkin, "Employment Asteroids for Movement of Space Ship and Probes", *IAC-02-S.6.04*, 53<sup>rd</sup> International Astronautical Congress - The World Space Congress - 2002, 10-19 Oct 2002, Houston, Texas.
13. A.A. Bolonkin, "Non-Rocket Space Rope Launcher for People", *IAC-02-V.P.06*, 53<sup>rd</sup> International Astronautical Congress - The World Space Congress - 2002, 10-19 Oct 2002, Houston, Texas.
14. A.A. Bolonkin, "Inexpensive Cable Space Launcher of High Capability", *IAC-02-V.P.07*, 53<sup>rd</sup> International Astronautical Congress - The World Space Congress - 2002, 10-19 Oct 2002, Houston, Texas.
15. A.A. Bolonkin, "Non-Rocket Earth-Moon Transport System", *COSPAR02-A-02224*, 34<sup>th</sup> COSPAR Scientific Assembly - The World Space Congress - 2002, 10-19 Oct 2002, Houston, Texas.
16. A.A. Bolonkin, "Non-Rocket Earth-Mars Transport System", *COSPAR02-A-02226*, 34<sup>th</sup> COSPAR Scientific Assembly - The World Space Congress - 2002, 10-19 Oct 2002, Houston, Texas.

(Received 5 August 2002; 21 November 2002)

\* \* \*