

# **In-flight MTF Analysis of ADAR 5500 Aircraft Sensor**

By

Dr. Dennis Helder  
Manjunath K. Rangaswamy

Electrical Engineering Department  
South Dakota State University  
August 2002

## INTRODUCTION

The Modulation Transfer Function (MTF) of an imaging system is one parameter that can be used to describe the spatial resolution or the image quality of an imaging system. MTF is the system's frequency response to an input. The MTF at a specific frequency normally ranges from 0-1, where 0 indicates no frequency response and 1 indicates perfect frequency response. The MTF value at Nyquist frequency is calculated because the Nyquist frequency is the maximum sampling frequency of the system.

MTF analysis was performed on data acquired with an ADAR 5500 flown by Positive Systems on September 13-14, 2000 over Brookings, SD. Four edges from ground targets were used as inputs to the system. The system's MTF was calculated using a Matlab-based algorithm, which applied edge detection, numerical differentiation, and Fourier transformation methods to the target images.

## TARGETS

Four edge inputs were obtained from target areas on the ground: two from parking lot edges and two from tarp edges.

Parking lot edges were selected because they provide a sharp contrast between bright concrete and dark grass. Positive Systems scenes and images of edges from two different lots, called Parking Lot 1 and 2, are shown below in Figures 1(a), (b), (c) and 2(a), (b), (c). Each parking lot edge is approximately 45 pixels in length.

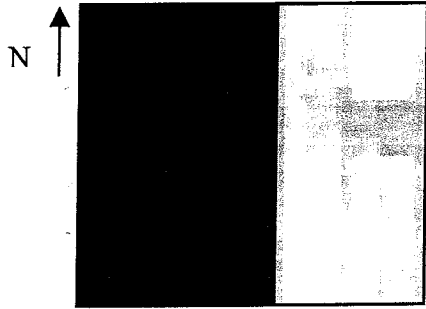

Figure 1a. Parking Lot 1 image (Red band)

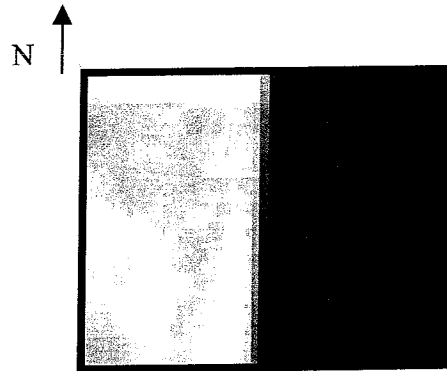

Figure 2a. Parking Lot 2 image (Red band)



Figure 1b. Parking Lot 1 Scene

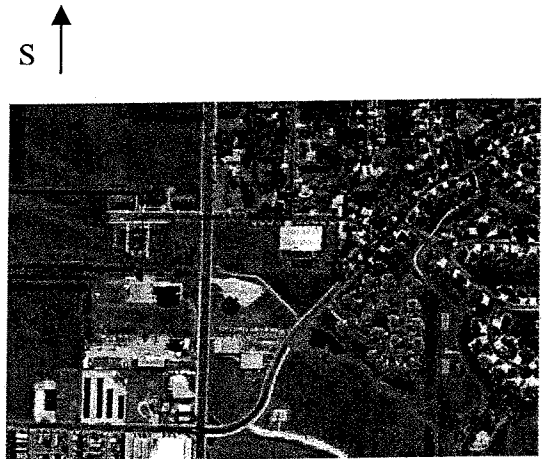

Figure 2b. Parking Lot 2 Scene

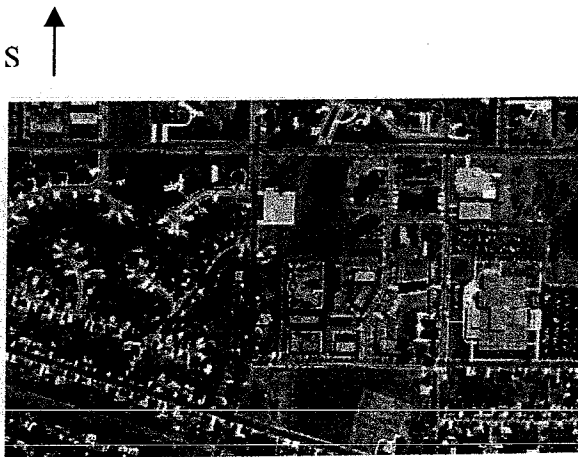

Figure 1c. Parking Lot 1 Scene

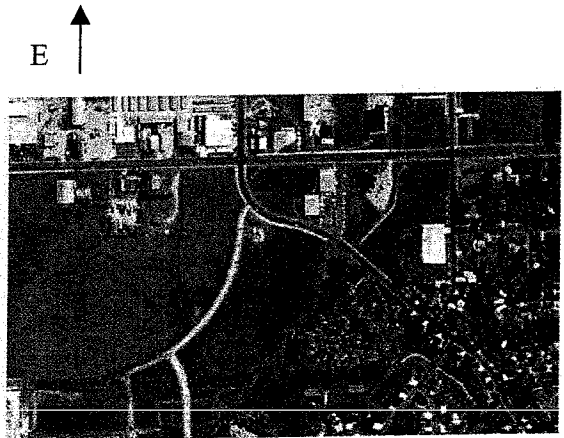

Figure 2c. Parking Lot 2 Scene

The tarp targets were also designed to provide sharp contrast between the reflective tarp and the grass. Six tarps were deployed on a grassy field, covering a rectangular area of 9x60 meters as shown in Figure 3c. An ADAR 5500 image of the tarp area and tarp layout is shown in Figure 3a & 3b. The west edge of the tarps was aligned  $8^\circ$  east of true north, an angle chosen to obtain uniformly distributed sub-pixel data. The west edge and the east edge of the tarps were both used as edge inputs.

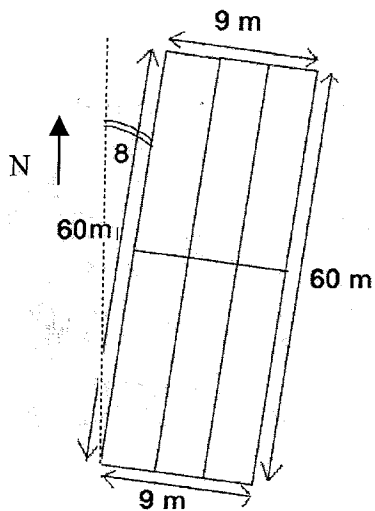

Figure 3a. Tarp Layout

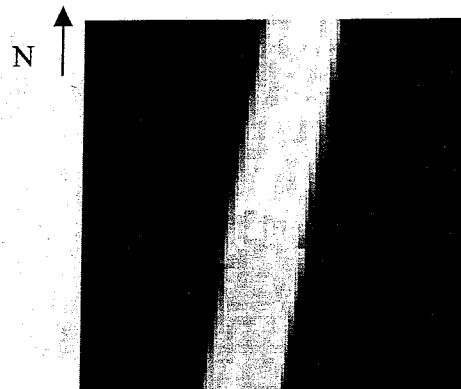

Figure 3b. Tarps (Green band)

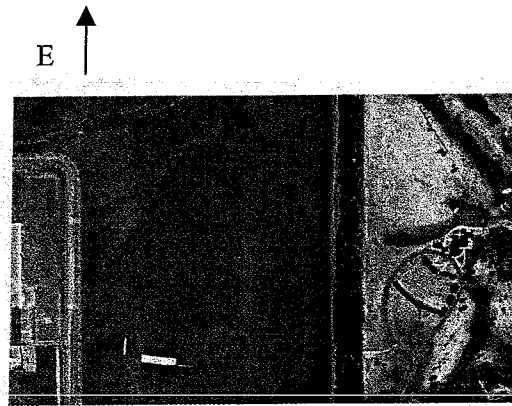

Figure 3c. Tarp Scenes

These targets were located in four scenes of the data received from Positive Systems. All three targets were visible in scenes 1 and 2. Only Parking Lot 2 was visible in scenes 3 and 4. The Blue and NIR bands from the Parking Lot images and the Blue and Red bands from the tarp images were not analyzed because of unclear edges such as those shown in Figure 4 below.

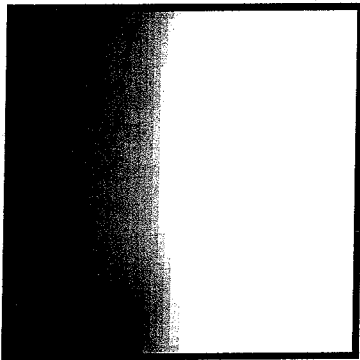

Figure 4a. Parking Lot image (Blue band).

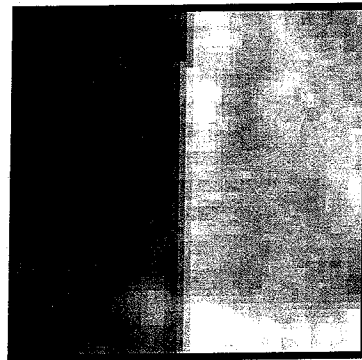

Figure 4b. Parking Lot image (NIR band).

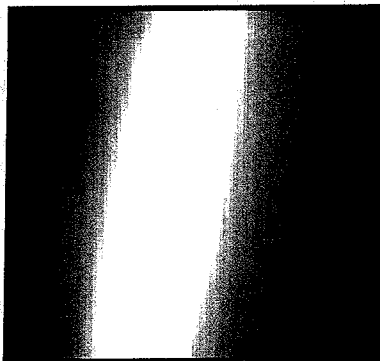

Figure 4c. Tarp image (Blue band).

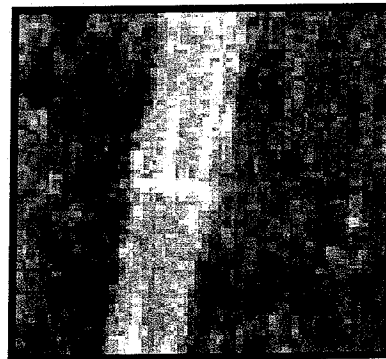

Figure 4d. Tarp image (Red band).

A total of 20 edges from Parking Lot 1, Parking Lot 2, and both tarp edges (east and west) were obtained for analysis. Two scenes of Green and Red bands were analyzed for

Parking Lot 1. Four scenes of Green and Red bands were analyzed for Parking Lot 2. Four scenes of Green and NIR bands were analyzed for both tarp edges. Some images were separated into two parts in order to better analyze their edges and minimize MTF degradation due to misalignment of the camera system CCD arrays.

### **MTF PROCEDURE**

The MTF of the ADAR5500 was calculated using a Matlab-based algorithm to perform the following procedure. First, the Edge Spread Function (ESF), which is a profile of the DN values of the edge, was obtained for each image. The ESF was differentiated to obtain the Line Spread Function (LSF), or one-dimensional Point Spread Function (PSF) of the system. The LSF was then Fourier transformed to obtain the MTF of the system.

#### ***Edge Spread Function***

The exact edge location for each edge image was determined using a digital differentiation and curve fitting method. Edge positions were determined for each line. Digital differentiation was applied to each line of DN values to detect a maximum slope. The sub-pixel edge points were determined by fitting a cubic polynomial equation to the edge data for each line. The derivative of the polynomial coefficients indicated the curve inflection point, which was assumed to be the sub-pixel edge location for each line.

The lines of pixels were aligned by their sub-pixel edge locations to form a straight vertical edge. A cubic spline was used to fit a smooth curve with 20 data points per pixel to the edge data for each line of pixels. The cubic splines for each line were averaged to obtain an average spline fit to the data, which is the ESF.

### ***Line Spread Function***

The LSF was obtained by applying simple digital differentiation to the ESF given by the following equation

$$LSF(n) = ESF(n) - ESF(n+1) \quad (1)$$

The resultant LSF was trimmed to 10 pixels to reduce noise in the uniform areas on either side of the edges. The LSF plot was normalized so its maximum value was 1.

The Full Width Half Maximum (FWHM), which is the width of the LSF at half of its maximum height, is a measurement of the amount of blurring present in an output image. The FWHM for each edge was obtained from the LSF.

### ***Modulation Transfer Function***

The MTF was obtained by applying a Fast Fourier Transform to the trimmed LSF. The resultant MTF magnitude was normalized by dividing the absolute MTF values by the DC value, which is the MTF at a frequency of zero. The location of the Nyquist frequency was found by the following equation

$$Nyquist\ frequency\ location = (\#\ of\ trimmed\ pixels) / 2 + 1 \quad (2)$$

If the MTF was obtained from an LSF with 10 trimmed pixels, the Nyquist frequency would be located at the sixth MTF value.

## RESULTS

### *Parking Lot 1*

Two scenes of Red and Green band images of the Parking Lot 1 edge were analyzed and the MTF at Nyquist frequency and the FWHM of the LSF were calculated.

The image used to analyze the Parking Lot 1 edge for the Red band, Scene 1 is shown in Figure 5a. The sub-pixel edge locations were marked with red circles and a least square error line was drawn through them to mark the edge location.

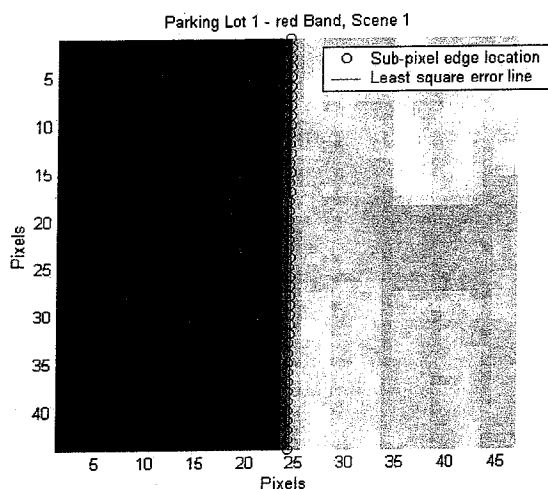

**Figure 5a. Parking Lot 1 edge - Red Band, Scene 1**

The aligned DN values for each line of pixels and the ESF fit to the data points were plotted as shown in Figure 5b. It can be seen from this figure that the data points are not evenly distributed, but are centered on specific pixel locations. This undesirable characteristic occurs because the angle of the edge in the image with respect to the camera system was not great enough to produce uniformly distributed data when the sub-pixel edge locations were aligned. An ESF was still fitted to the data, but it can be seen that few data points actually occur where the edge is transitioning from dark to bright.



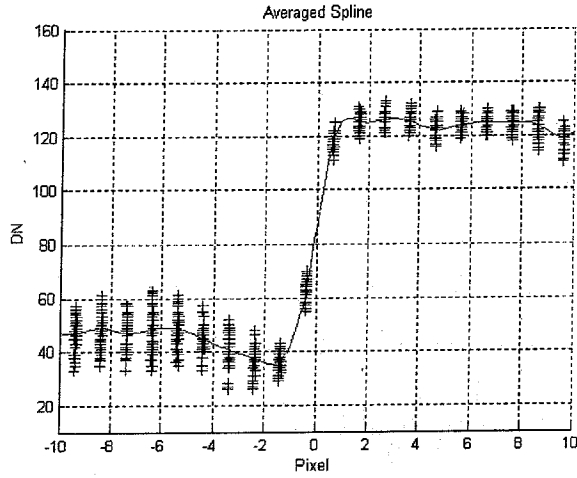

Figure 5b. Data points and the fit ESF, Parking Lot 1 - Red Band, Scene 1

The resultant LSF and MTF plots are shown below in Figures 5c and 5d.

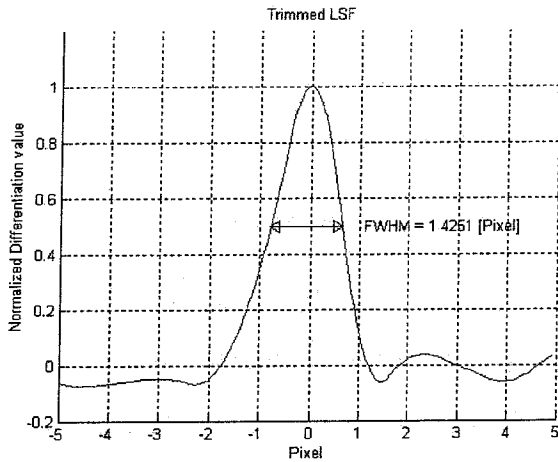

Figure 5c. LSF for Lot 1-Red Band, Scene 1

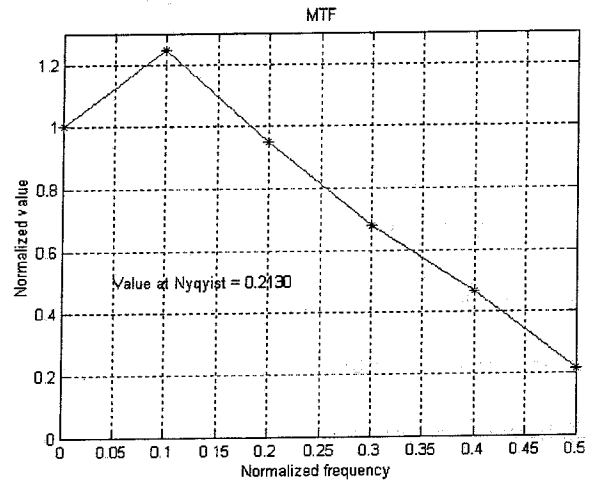
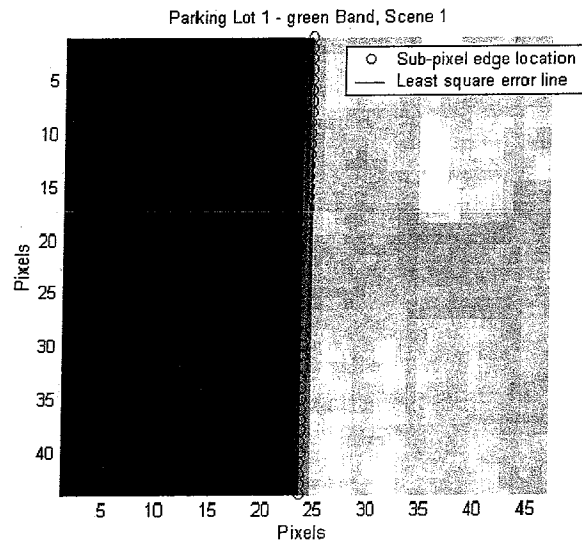

Figure 5d. MTF for Lot 1-Red Band, Scene 1

The image of the Parking Lot 1 edge in the Green band, Scene 1, is shown below in Figure 6a. This image is from the same scene and cropped from the exact same pixel locations as the previous image, but from a different band.



**Figure 6a. Parking Lot 1 edge - Green Band, Scene 1**

The data points and ESF plot for the Parking Lot 1 edge, Green band, Scene 1 image are shown in Figure 6b. It can be seen that the data points for this image are more evenly distributed than the plot in Figure 5b, but there are still limited data points present at the edge location, which makes interpretation of the resulting LSF and MTF plots difficult.

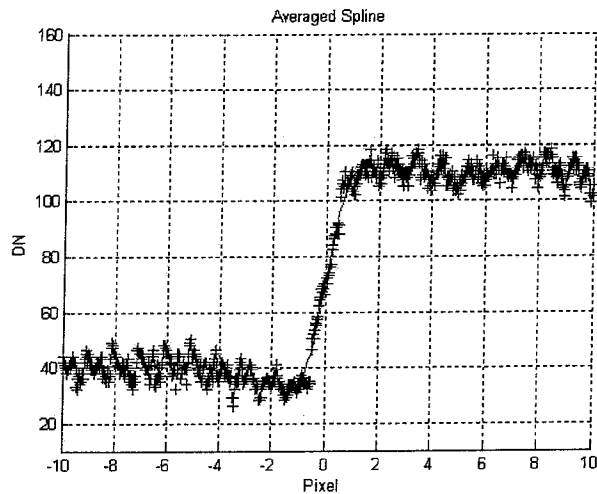

Figure 6b. Data points and the fit ESF, Parking Lot 1 - Green Band, Scene 1

The resultant LSF and MTF plots are shown below in Figures 6c and 6d.

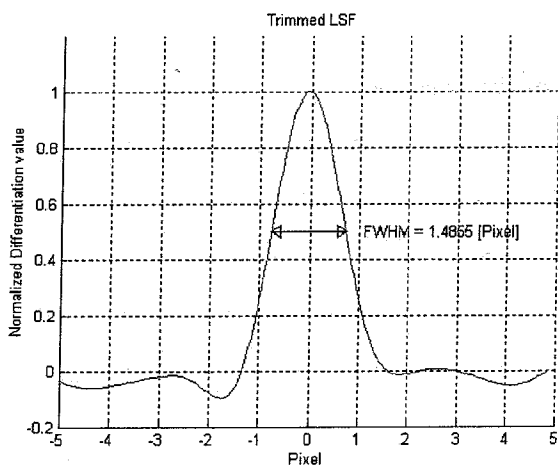

Figure 6c. LSF for Lot 1 – Green Band, Scene 1

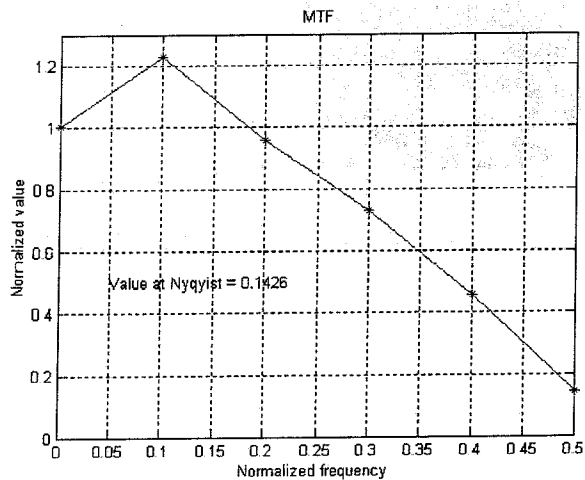
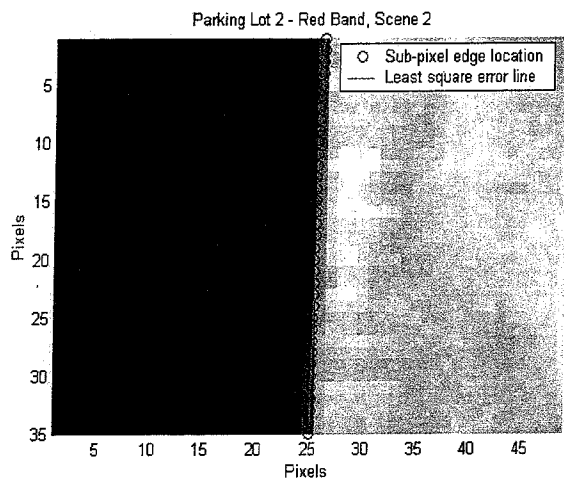

Figure 6d. MTF for Lot 1 – Green Band, Scene 1

The same plots were obtained for Parking Lot 1 images from Scene 2. The complete set of plots for both scenes is attached in the appendix.

*Parking Lot 2*

Similar results were obtained for the Parking Lot 2 edge as for the Parking Lot 1 edge. Four scenes of Red and Green band edge images were analyzed. The plots for each of these images are shown in the attached Appendix. Of the Parking Lot 2 Red band images, the Scene 2 image was found to have the best uniformly distributed data points and the most data points at the edge location. This image and its ESF, LSF, and MTF plots are shown in Figures 7a-d. Note that the edge image has been 'flipped' to produce a positive LSF after differentiation of the ESF.



**Figure 7a. Parking Lot 2 edge - Red Band, Scene 2**

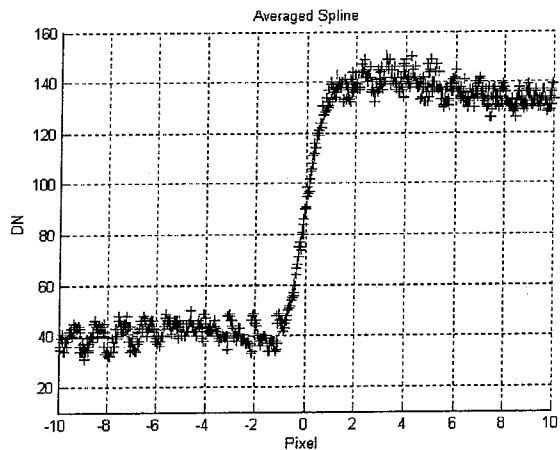

**Figure 7b. Data points and the fit ESF**

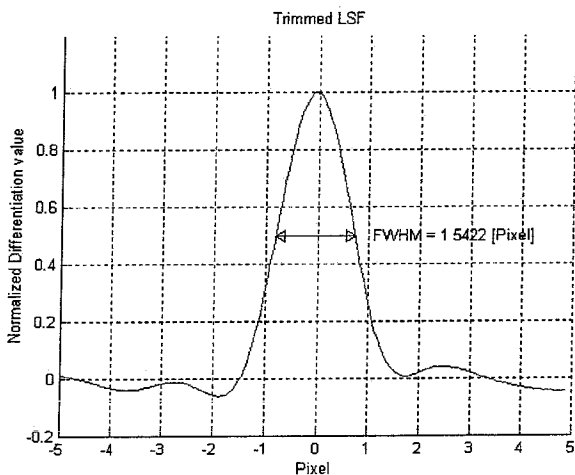

**Figure 7c. LSF plot**

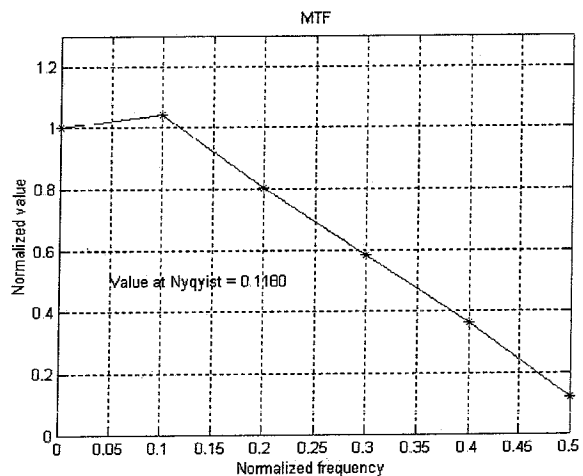

**Figure 7d. MTF plot**

The Green band, Scene 3 image was also found to have better data point distribution than the other Green band images for Parking Lot 2. This image and its ESF, LSF, and MTF plots are shown in Figures 8a-d.

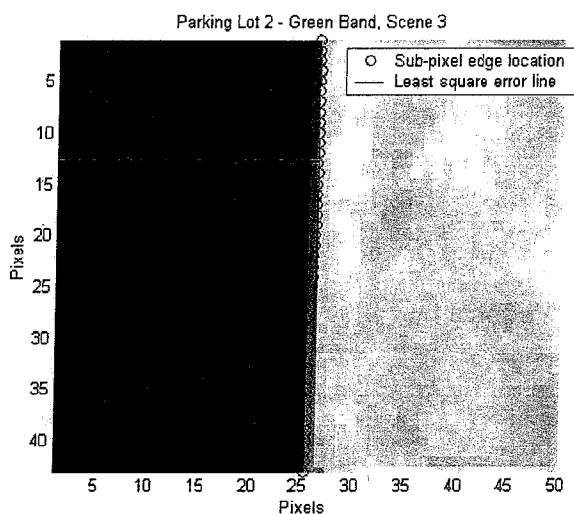

Figure 8a. Parking Lot 2 edge - Green Band, Scene 3

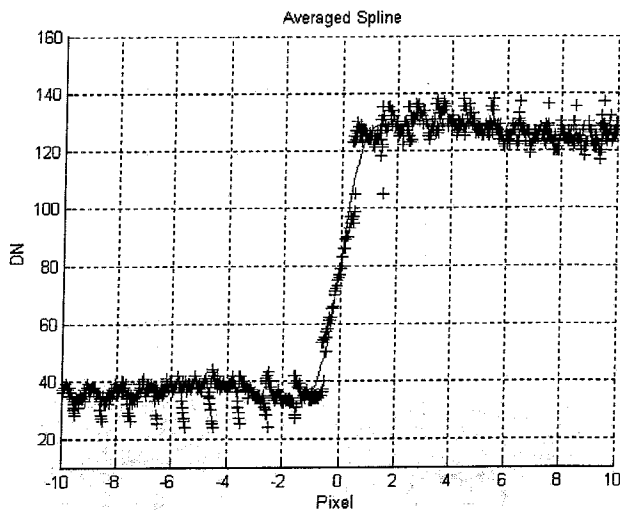

Figure 8b. Data points and the fit ESF

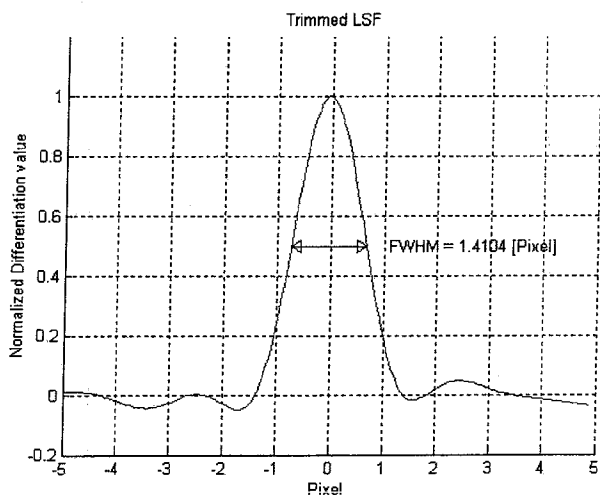

Figure 8c. LSF plot

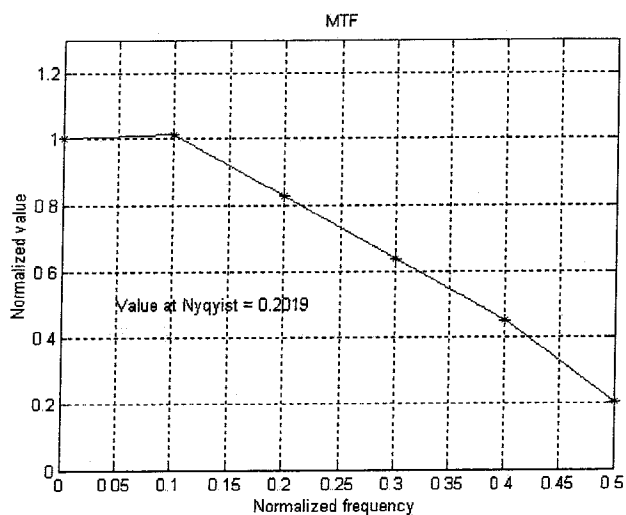
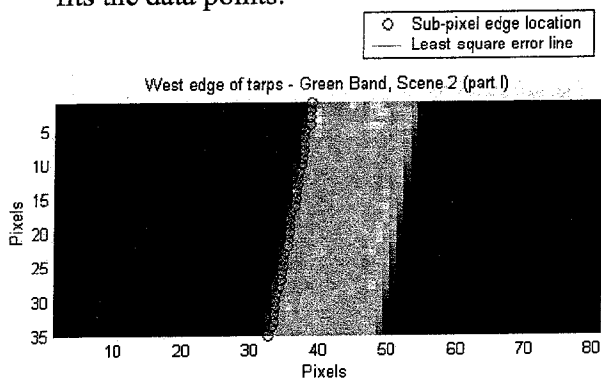

Figure 8d. MTF plot

*Tarp Edges*

It was found that because the tarp was deployed at an optimal angle for edge analysis, the data points for the tarp edges were much more uniformly distributed than those for the parking lot edges. The tarps were therefore determined to be the best of the three targets for MTF analysis.

Figures 9a-d shows one example of the MTF analysis of a west tarp edge. This analysis was done on the west edge of the tarp in a Green band image from Scene 2. It can be seen from Figure 8b that the data points are uniformly distributed throughout the edge and the ESF closely fits the data points.



**Figure 9a. Tarp west edge - Green Band, Scene 2**

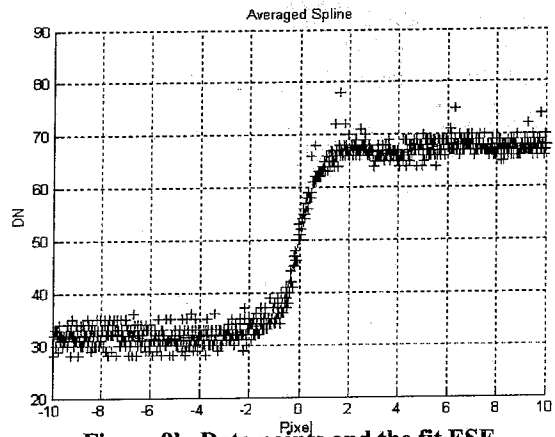

**Figure 9b. Data points and the fit ESF**

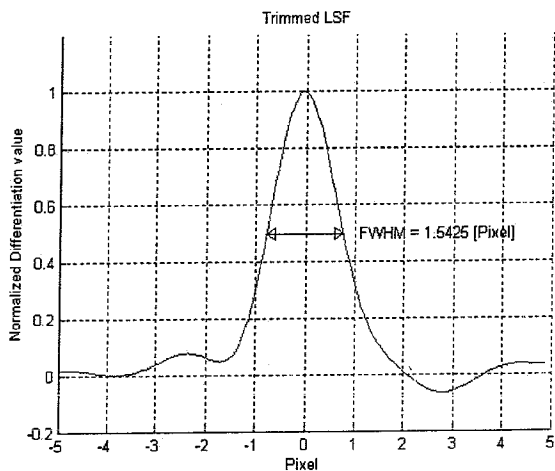

**Figure 9c. LSF plot**

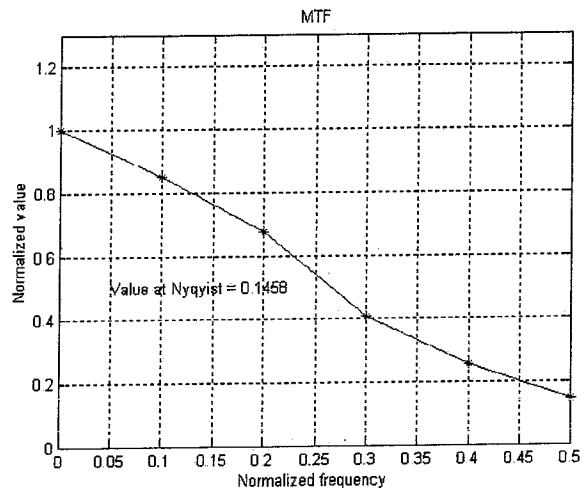

**Figure 9d. MTF plot**

Figures 10a-d show an example of MTF analysis of an east tarp edge. This analysis was done on the east edge of the tarp in a NIR band image from Scene 2. It can be seen from Figure 10c that the FWHM for NIR band edges is approximately two pixels wider than the FWHM for Green or Red band edges.

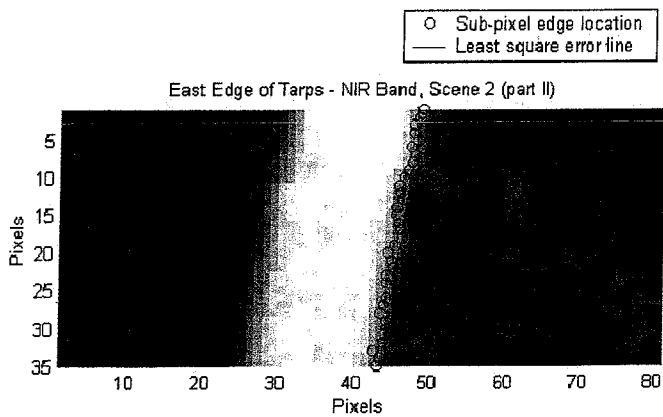

Figure 10a. Tarp east edge - NIR Band, Scene 2

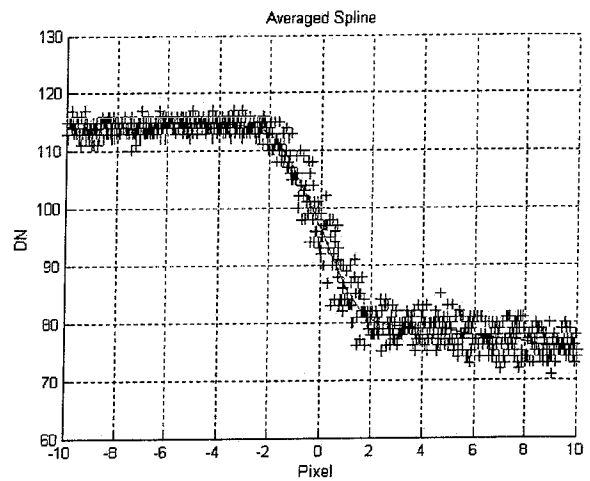

Figure 10b. Data points and the fit ESF

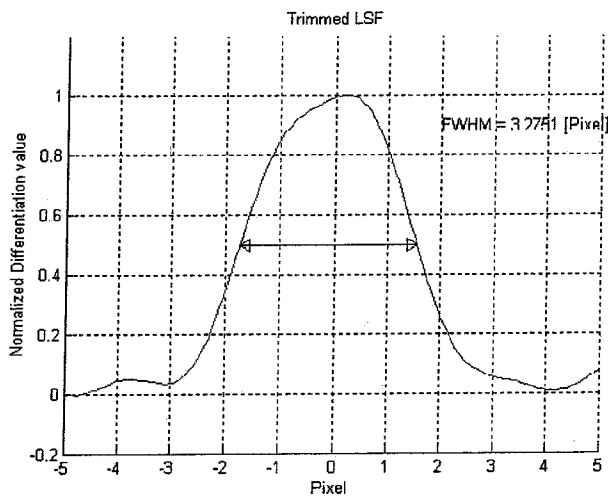

Figure 10c. LSF plot

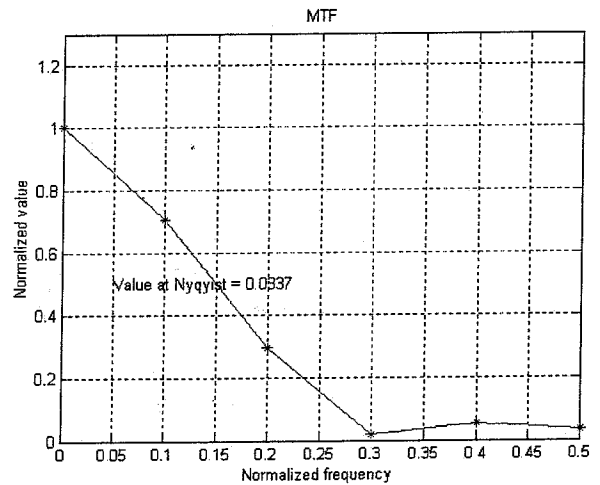

Figure 10d. MTF plot

The calculated values for the FWHM of the LSF and the MTF at Nyquist frequency for the Parking Lot1, Parking Lot 2, West and East Tarp edges are summarized in Tables 1, 2 & 3 respectively. The column labeled 'Data' is a qualitative assessment of the spatial distribution of the edge sample points. 'Good' indicates a relatively uniform distribution of samples; 'Fair' indicates data samples are in isolated locations; 'Noisy' indicates data with excessive random variations. 'Clumpy' indicates data distribution similar to Figure 5b. Abbreviations for targets are PL1=Parking Lot1, PL2=Parking Lot2; TW=west side of tarps; TE=east side of tarps. The column labeled 'Part' indicates a discontinuity existed in the relative location of the edge due, presumably, to imperfections in the CCD focal plane array. Thus, that edge was broken into two parts to prevent the discontinuity from producing deleterious effects on MTF estimations.

From the Red band results in Table 1, it is obvious that only one opportunity for a relatively accurate estimate is possible (PL2, S2). FWHM and MTF at Nyquist are estimated to be 1.54 and 0.12 respectively. East and West flight line were too noisy for MTF estimates.

Table 1. Red Band Results

Red Band					
Target	Scene	Data	FWHM (Pixel)	MTF@ Nyquist (Cycles/pixel)	Flight direction
PL1	S1	Clumpy	1.43	0.21	North
PL1	S2	Clumpy	1.24	0.38	North
PL2	S1	Clumpy	1.22	0.36	South
PL2	S2	Good	1.54	0.12	South
PL2	S3	Clumpy	1.53	0.18	South
PL2	S4	Clumpy	1.25	0.33	South



The data indicate that in the Green band the MTF estimates are consistent for West and East edges of the Tarp. We also have two reasonable MTF and FWHM values for Parking Lot2 (scenes 2&3) and one of Parking Lot1 (scene 1). Estimates of PSF/MTF were possible in the Green band along-track direction with east and west flight lines. Unfortunately, only one 'Good' data set was recorded (TW, S3). This result (MTF @ Nyquist = 0.19) is similar to what was recorded for the across-track MTF.

The NIR band data in table 3 below indicates scenel (part 2) and scene2 (part 2) of the West edges of the tarps produced the most acceptable MTF estimates. Results from the east and west flight lines were unacceptable.

Table 2. Green Band Results

Green Band						
Target	Scene	Part	Data	FWHM	MTF	Flight direction
PL1	S1		Fair	1.49	0.14	North
PL1	S2		Clumpy	1.19	0.45	North
PL2	S1	1	Clumpy	1.42	0.18	South
PL2	S2	2	Clumpy	1.44	0.23	South
PL2	S2	1	Good	1.27	0.32	South
PL2	S2	2	Clumpy	1.23	0.35	South
PL2	S3		Fair	1.41	0.2	South
PL2	S4		Clumpy	1.13	0.51	South
TW	S1	1	Clumpy	1.46	0.18	North
TW	S1	2	Good	1.48	0.17	North
TW	S2	1	Good	1.54	0.15	North
TW	S2	2	Good	1.54	0.16	North
TW	S3		Good	1.44	0.19	East
TW	S4		Noisy/Fair	1.48	0.14	West
TE	S1	1	Good	1.46	0.18	North
TE	S1	2	Good	1.47	0.16	North
TE	S2	1	Good	1.48	0.19	North
TE	S2	2	Fair	1.68	0.09	North
TE	S3		Noisy/Fair	1.51	0.13	East
TE	S4		Noisy/Fair	1.47	0.23	West

Table 3. NIR Band Results

NIR Band						
Target	Scene	Part	Data	FWHM	MTF	Flight direction
TW	S1	1	Noisy	3.32	0.01	North
TW	S1	2	Good	3.44	0.03	North
TW	S2	1	Noisy	3.2	0.04	North
TW	S2	2	Good	3.72	0.04	North
TW	S3		Noisy/Fair	2.6	0.03	East
TW	S4		Noisy	2.67	0.04	West
TE	S1	1	Noisy	4.01	0.01	North
TE	S1	2	Good/noisy	3.31	0.03	North
TE	S2	1	Noisy	3.66	0.01	North
TE	S2	2	Good/noisy	3.28	0.03	North
TE	S3		Noisy	2.98	0.03	East
TE	S4		Noisy	2.39	0.04	West

## CONCLUSION

MTF analysis was done on 20 edge images in an attempt to describe the image quality of Positive System's ADAR 5500 sensor while in flight. Final Estimates of MTF at Nyquist, and the FWHM values are calculated for each band as shown in table 4.

Table 4. Band Mean and Standard deviation

Band	FWHM		MTF@Nyquist	
	Mean	Stdev.	Mean	Stdev.
Green	1.440	0.150	0.150	0.119
Red	1.540	-	0.120	-
NIR	3.430	0.201	0.030	0.005

Several reasonable estimates for Green band MTF were derived from the tarp edges. Unfortunately, noisy data resulted in only one estimate for the Red band. Several reasonable estimates were produced from the NIR band that yielded a very large FWHM or small MTF. This is consistent with a visual assessment of the imagery that suggests this camera was not focused properly. Because of limited useful data, no results for MTF in the along-track direction are used in these conclusions. Lastly, no estimates of the Blue band were possible due to equipment malfunctions.



**REPORT DOCUMENTATION PAGE**

Form Approved  
OMB No. 0704-0188

The public reporting burden for this collection of information is estimated to average 1 hour per response, including the time for reviewing instructions, searching existing data sources, gathering and maintaining the data needed, and completing and reviewing the collection of information. Send comments regarding this burden estimate or any other aspect of this collection of information, including suggestions for reducing this burden, to Department of Defense, Washington Headquarters Services, Directorate for Information Operations and Reports (0704-0188), 1215 Jefferson Davis Highway, Suite 1204, Arlington, VA 22202-4302. Respondents should be aware that notwithstanding any other provision of law, no person shall be subject to any penalty for failing to comply with a collection of information if it does not display a currently valid OMB control number.

**PLEASE DO NOT RETURN YOUR FORM TO THE ABOVE ADDRESS.**

1. REPORT DATE (DD-MM-YYYY) 13-02-2003		2. REPORT TYPE		3. DATES COVERED (From - To)	
4. TITLE AND SUBTITLE In-Flight MTF Analysis of ADAR 5500 Aircraft Sensor				5a. CONTRACT NUMBER NAS13-650	
				5b. GRANT NUMBER	
				5c. PROGRAM ELEMENT NUMBER	
6. AUTHOR(S) Slawomir Blonski Vicki Zanoni Dennis Helder Manjunath K Rangaswamy				5d. PROJECT NUMBER	
				5e. TASK NUMBER	
				5f. WORK UNIT NUMBER	
7. PERFORMING ORGANIZATION NAME(S) AND ADDRESS(ES) Lockheed Martin Space Operations				8. PERFORMING ORGANIZATION REPORT NUMBER  SE-2003-02-00013-SSC	
9. SPONSORING/MONITORING AGENCY NAME(S) AND ADDRESS(ES) Earth Science Applications Directorate				10. SPONSORING/MONITOR'S ACRONYM(S)	
				11. SPONSORING/MONITORING REPORT NUMBER	
12. DISTRIBUTION/AVAILABILITY STATEMENT Publicly Available STI per form 1676					
13. SUPPLEMENTARY NOTES URL - <a href="http://www.esa.ssc.nasa.gov">http://www.esa.ssc.nasa.gov</a>					
14. ABSTRACT					
15. SUBJECT TERMS					
16. SECURITY CLASSIFICATION OF:			17. LIMITATION OF ABSTRACT	18. NUMBER OF PAGES	19b. NAME OF RESPONSIBLE PERSON
a. REPORT	b. ABSTRACT	c. THIS PAGE			19b. TELEPHONE NUMBER (Include area code)
U	U	U	UU	18	Slawomir Blonski (228) 688-1944