

Synchronized electronic shutter system (SESS) for thermal nondestructive evaluation

Joseph N. Zalameda

U. S. Army Research Laboratory, Vehicle Technology Directorate
Nondestructive Evaluation Sciences Branch MS 231
NASA Langley Research Center 23681

ABSTRACT

The purpose of this paper is to describe a new method for thermal nondestructive evaluation. This method uses a synchronized electronic shutter system (SESS) to remove the heat lamp's influence on the thermal data during and after flash heating. There are two main concerns when using flash heating. The first concern is during the flash when the photons are reflected back into the camera. This tends to saturate the detectors and potentially introduces unknown and uncorrectable errors when curve fitting the data to a model. To address this, an electronically controlled shutter was placed over the infrared camera lens. Before firing the flash lamps, the shutter is opened to acquire the necessary background data for offset calibration. During flash heating, the shutter is closed to prevent the photons from the high intensity flash from saturating the camera's detectors. The second concern is after the flash heating where the lamps radiate heat after firing. This residual cooling introduces an unwanted transient thermal response into the data. To remove this residual effect, a shutter was placed over the flash lamps to block the infrared heat radiating from the flash head after heating. This helped to remove the transient contribution of the flash. The flash lamp shutters were synchronized electronically with the camera shutter. Results are given comparing the use of the thermal inspection with and without the shutter system.

Keywords: thermography, single side inspection, flash lamp, electronic shutters, corrosion, disbond, delamination

1. INTRODUCTION

The advantages of thermal nondestructive evaluation are noncontact, rapid inspection, and imaging of large areas. The technique is safe where only a small amount of heat (typically less than 15 degrees Celsius above ambient) is applied to the surface of the structure. Because small changes in the surface temperature response are measured for defect detection, any extraneous influences can significantly effect the measurement. A new method is presented for thermal Nondestructive Evaluation (NDE). This new method uses a synchronized electronic shutter system (SESS) to remove unwanted transient heat source effects from the thermal image data. The use of shutters in thermal NDE is not new. Most applications of shutters in thermal NDE are used to modulate an optical heat source for periodic heating.¹⁻³ Shutters are also commonly used in some infrared sensors/cameras to maintain the calibration of the detectors.⁴⁻⁵ In this work synchronized shutters are placed over the flash lamps and infrared camera. The flash lamp shutter is not used to modulate the optical heat source, but to immediately close after firing to prevent the hot flash lamp from reflecting into the camera. The shutter on the infrared camera is not used to calibrate the camera's sensors but to block any reflected photons from entering the camera during the flash and to synchronize with the flash lamp shutters to allow for data capture only when the flash lamp shutters are closed. The shutters used in this work are electronically controlled and calibrated for frequencies up to 60 Hertz.

Flash lamps are the most commonly used heating source for thermal NDE. After flash heating, there is an observed residual effect of the flash lamps. This is usually seen in the temperature data as reflections from the hot lamps. These hot spots can give false indications of defects. This can usually be seen as a slowly fading pattern of the flash head reflected on the sample into the camera. Even for high emissivity painted surfaces this effect can still be seen. The transient nature of the flash head cool down is not known and its intensity would be dependent on the surface emissivity. The high luminance flash is produced with a flash tube that discharges a high voltage capacitor in a short period of time. These flash tubes usually have a fan cooler to minimize the temperature rise. As a result of the residual cooling, the flash head introduces a transient thermal response that is reflected onto the sample that is being inspected and back into the camera during thermal measurements. The use of shutters on the flash lamps removes this unwanted effect from the thermal image data. This technology can also be applicable for quartz lamp heating.

The infrared camera is another area of concern during flash heating. For example, when the infrared camera and flash heat source are located on the same side of the sample (single sided inspection) there is a tendency to expose the detectors of the cameras to a high intensity flash. This is a result of the surface emissivity never being a perfect absorber of all the incident photons. Since the light intensity is very high in order to heat the structure sufficiently, the result is that photons are reflected back into the infrared camera's detectors and therefore very high radiance are measured possibly out of the calibration range. Sometimes saturation of the detectors can occur where the measured radiance is above the dynamic range of the camera. By using a shutter on the infrared camera, the camera's infrared detectors are not exposed during flash heating. The camera's shutter is synchronized to the flash lamp shutter to insure that the thermal data is taken only when the flash lamp shutters are closed.

In this paper, the design and application of the SESS is discussed. Thermal data is presented to compare the SESS to conventional thermography where no shutters are used for both single side and through transmission measurements. The samples inspected thermally in this work are delamination in a composite cylinder, corrosion in a single layer aluminum plate, disbond in a two layer unpainted aluminum plate, and thermal diffusivity variations in a composite plate.

2. SESS DESCRIPTION

The SESS is composed of three shutters, flash lamp shutter adapters, and the shutter control electronics as shown in figure 1 for a single side setup. The first shutter is placed over the infrared camera. The other two shutters are placed over the two flash lamp heads using the adapters. The shutters are synchronized electronically. The operational timing diagram is shown in figure 2. Before firing the flash lamps, the camera shutter is opened to acquire the necessary background data frame for offset calibration. During flash heating, the camera shutter is closed to prevent the photons from the high intensity flash from entering the infrared inspection camera. The flash duration has been measured to be approximately 0.008 seconds.⁶ Immediately after the flash the camera shutter is opened to measure the surface temperature. This can be synchronized to the start of the acquisition of the next camera data frame by adjusting a delay in the shutter electronics. To remove the residual effect of the flash lamps radiating heat after firing, a shutter is placed over the flash heads to block the infrared heat radiating from the flash head after firing. A custom flash lamp shutter adapter was designed and fabricated out of aluminum and easily replaces the lamp's reflector. The custom shutter adapter holds the shutter over the flash tubes and are fully open when the flash tubes are fired. The flash lamp also reflects the light onto the target of interest during firing. The flash lamp shutters are synchronized electronically with the camera shutter to open when the camera shutter closes. A second adjustable delay is used to insure the flash lamp shutters are immediately closed after the flash duration. This whole sequence requires a minimum of two image data cycles in time, one for the background image capture and the other to operate the SESS during flash heating. The electronic shutters for both the camera and flash lamp are 5 and 7 moving blade shutters respectively. The shutters are solenoid controlled, powered by 12 volts and are calibrated up to 60 hertz. The

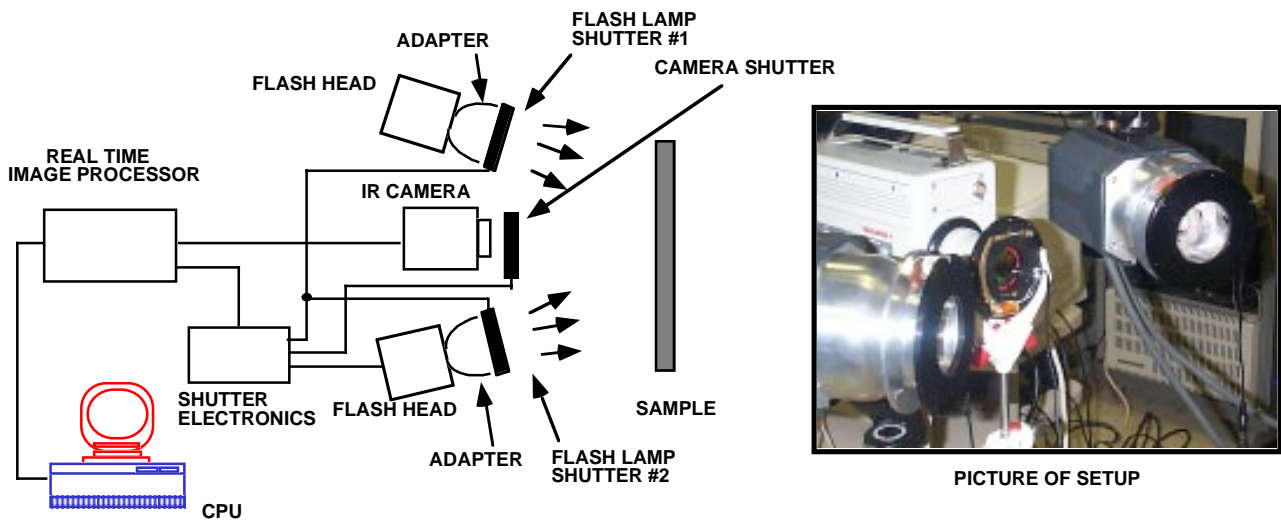

Figure 1. Schematic diagram of SESS implementation with picture.

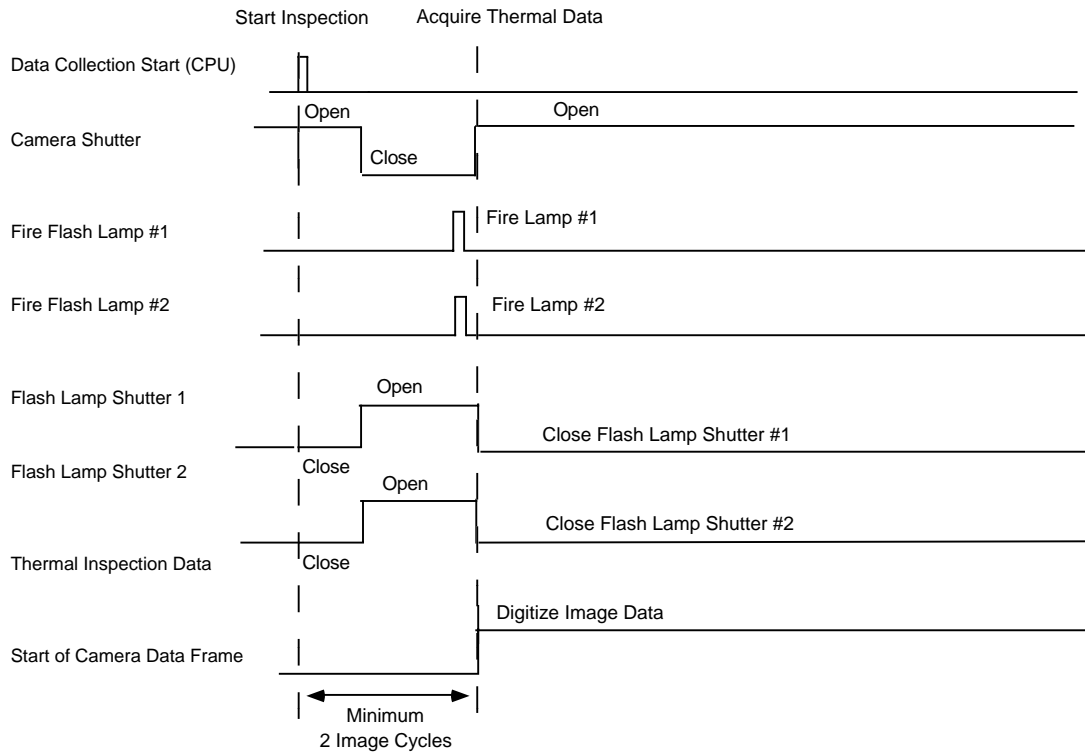

Figure 2. Timing diagram of SESS.

camera shutter is normally open and the flash lamp shutters are normally closed. This reduces the shutters power requirements by reducing the power duty cycle. The focal plane array infrared camera detector size is 256x256 operating in the 3 – 5 micrometer wavelength band. The camera output frame rate was 60 hertz and was connected to a real time image processor for image storage, averaging, and analysis.

3. EXPERIMENTAL RESULTS

3.1 Composite Cylinder Inspection

Using the setup shown in figure 1 some results of the single side measurements are shown in figures 3, 4, and 5. Shown in figure 3 is a temperature image taken during the flash on a composite cylinder without the SESS. As can be seen very large temperatures are measured erroneously due to the reflected radiation during the flash. Also a comparison is made of two sets of thermal data without shutters and with the shutters (figure 4) taken on the same composite sample. The sample is an aluminum cylinder with graphite epoxy wound filaments as the outer shell. A delamination exists between the outer composite shell and the aluminum. As shown in figure 4, the lamp reflection can be seen in the temperature data as a slowly fading hot spot. This is entirely removed with the shutters. Also shown in figure 4 are the temperature data at the same location on the sample. The temperature data is offset corrected and normalized. As shown, the temperature data is different because of the influence of the lamps radiating heat onto the sample which is reflected back into the camera. This difference in the time versus temperature profile produces errors when analyzing the thermal image data. The transient nature of the flash head cool down is not known and its intensity would be dependent on the surface emissivity. To image the defect, a time derivative calculation is applied to the temperature images.⁷ The time derivative image processing helps to remove some of the lamp reflections while enhancing defect contrast. Shown in figure 5 are the processed thermal inspection time derivative images with and without the SESS. By using the SESS, the lamp effects are removed from the raw temperature image and the processed time derivative image.

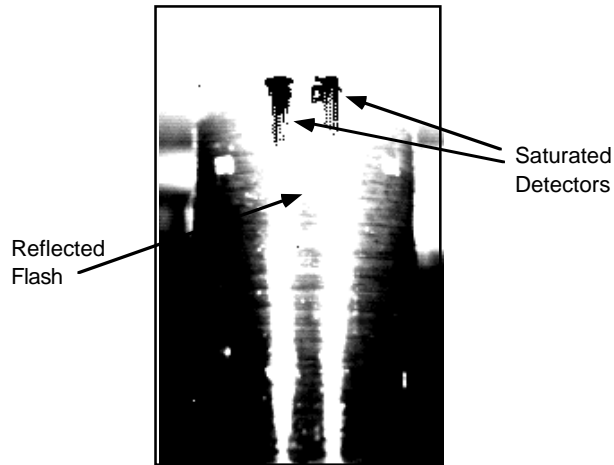

Figure 3. Temperature image during flash on composite cylinder without SESS.

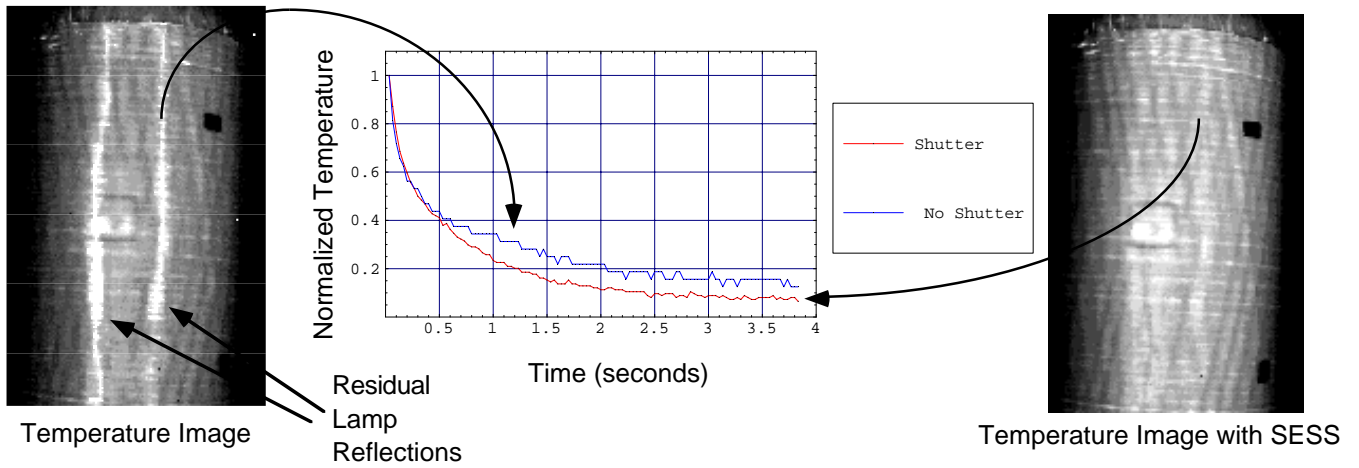

Figure 4. Temperature image after flash with and without SESS and time series plot comparison.

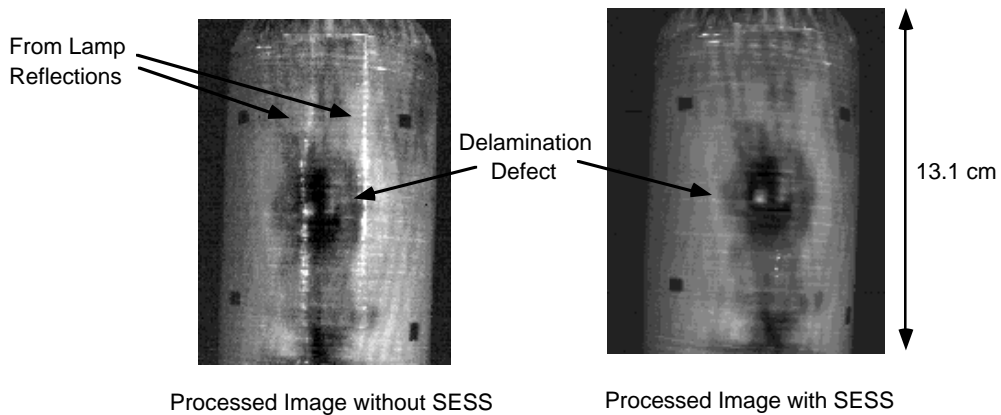

Figure 5. Processed inspection image of composite cylinder with and without SESS.

3.2 Corrosion Detection

A single layer aluminum corrosion sample was tested using the SESS setup shown in figure 1. The corrosion sample was a flat plate and painted with flat black paint to increase the surface emissivity. The sample was 0.102 centimeters thick with 1.27 centimeters diameter circular material loss regions of 0.0025, 0.0076, and 0.0127 centimeters in thickness for corrosion values of 2.5, 7.5, and 12.5 percent. The measurement parameters were 120 frames acquired at a camera frame rate of 60 hertz. As shown in figure 6, a comparison is made of the processed thermal images with and without the SESS for the detection of 7.5 and 12.5 percent corrosion. The processed thermal images were produced using a temperature normalization data reduction routine.⁸ The effect of the flash lamps are clearly seen in figure 6 as dark areas that can actually mask the corrosion area. Using the SESS removes the flash lamp effect so that only the defective areas are imaged. The 2.5 percent corrosion sample results are shown in figure 7 using a smaller field of view. In this case the corrosion is not detectable without using the SESS.

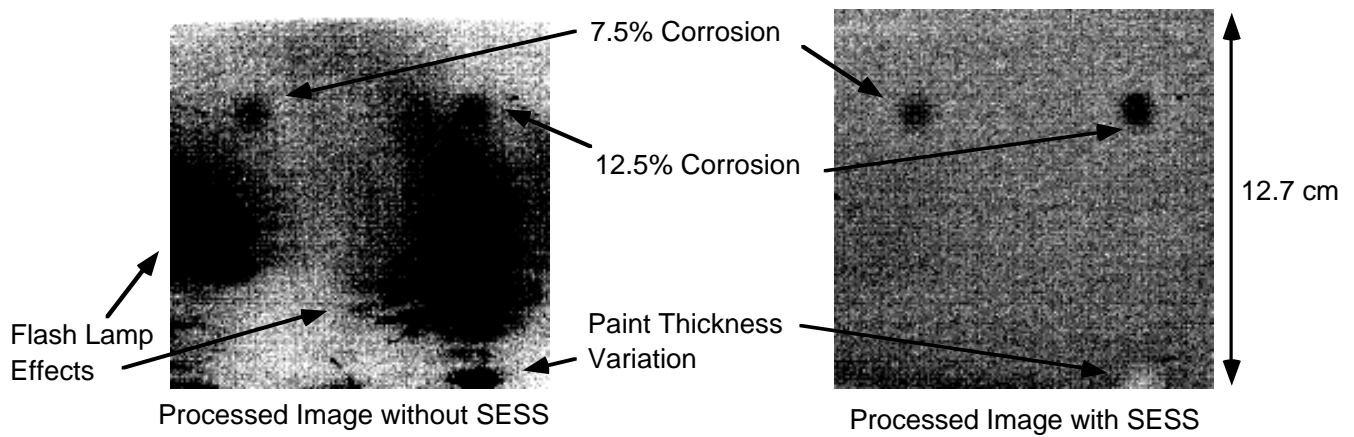

Figure 6. Inspection image of aluminum corrosion sample with and without the SESS.

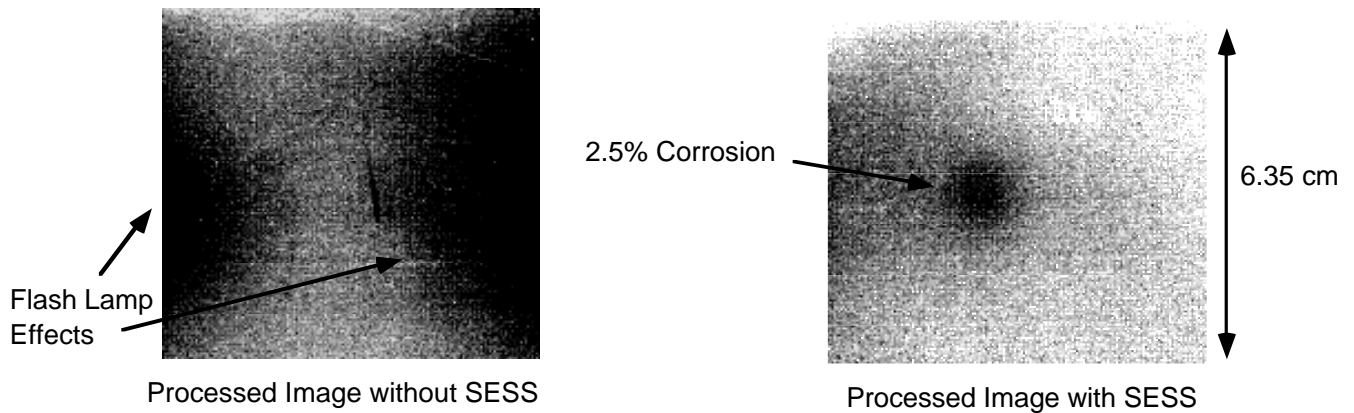

Figure 7. Inspection image of 2.5 percent aluminum corrosion sample with and without the SESS.

3.3 Disbond Detection on Uncoated Aluminum Sample

Thermal inspections were performed on an uncoated aluminum sample with an aluminum metal stiffener bonded to the backside. The aluminum sample was not shiny but gray from small surface abrasions. The sample was 0.066 centimeters thick and areas with the bonded metal were 0.145 centimeters thick. The processed thermal images were again produced using a temperature normalization data reduction routine. Shown in figure 8 is a picture of the sample and also the processed thermal images with and without using the SESS. The dark areas in the processed thermal images without the shutters mask the ability of the thermal inspection to reveal the bonded metal stiffener. Also the disbond area is not clearly detected. Using the SESS helps to image the disbond defect and the underlying structure of the stiffened panel.

3.4 Quantitative Through Transmission Inspection

Another advantage of having shutters on the flash lamps is for a through transmission thermal diffusivity measurement where the hot lamps radiate heat after flashing. The setup used is shown in figure 9. By using shutters on the flash lamps, custom-made baffles are not required for either the sample or on the lamp. For example, when inspecting samples smaller than the diameter of the flash lamp custom baffles were made specific to the size of the sample being tested. These baffles were used to block the flash lamps from radiating heat after firing. This is known as edge bleed over and would make the inspection of small samples difficult particularly around the edges because small temperature changes were being measured behind a hot background. This is shown in figure 10 for a flash test on a 2.54 x 12.7 centimeter composite sample 0.20 centimeters thick. Diffusivity images are also shown in figure 10 and were calculated using a curve fitting routine.⁹ The routine fits equation (1) below with the normalized temperature data.

$$T_N(t) = \left(1 + 2 \sum_{n=1}^{\infty} (-1)^n \text{Exp}\left[\frac{-n^2 \pi^2 \alpha t}{l^2} \right] \right) \quad (1)$$

$T_N(t)$ is the normalized temperature response, the fit parameter is α which is the thermal diffusivity, l is the known thickness, and t is time. The diffusivity image without the shutter contains errors. The diffusivity values are saturated near the edge of the sample. The diffusivity image of the composite sample using the SESS is more defined on the edges. By using the SESS, measurement errors of thermal diffusivity along the edge are reduced and therefore custom made baffles are not necessary.

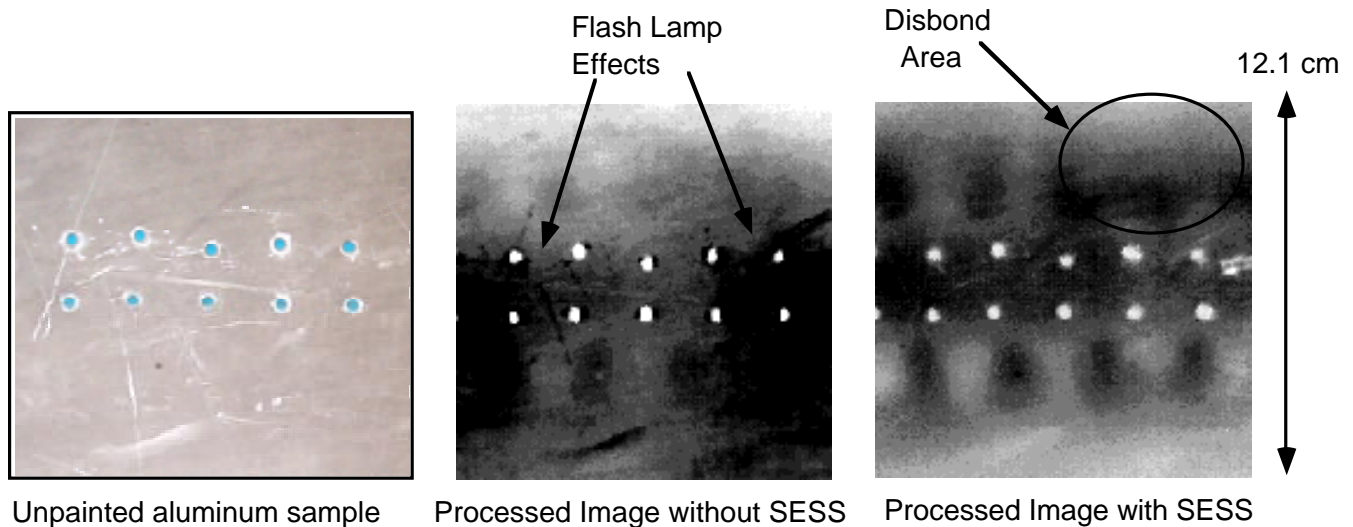

Figure 8. Thermal inspection of unpainted aluminum sample with and without SESS.

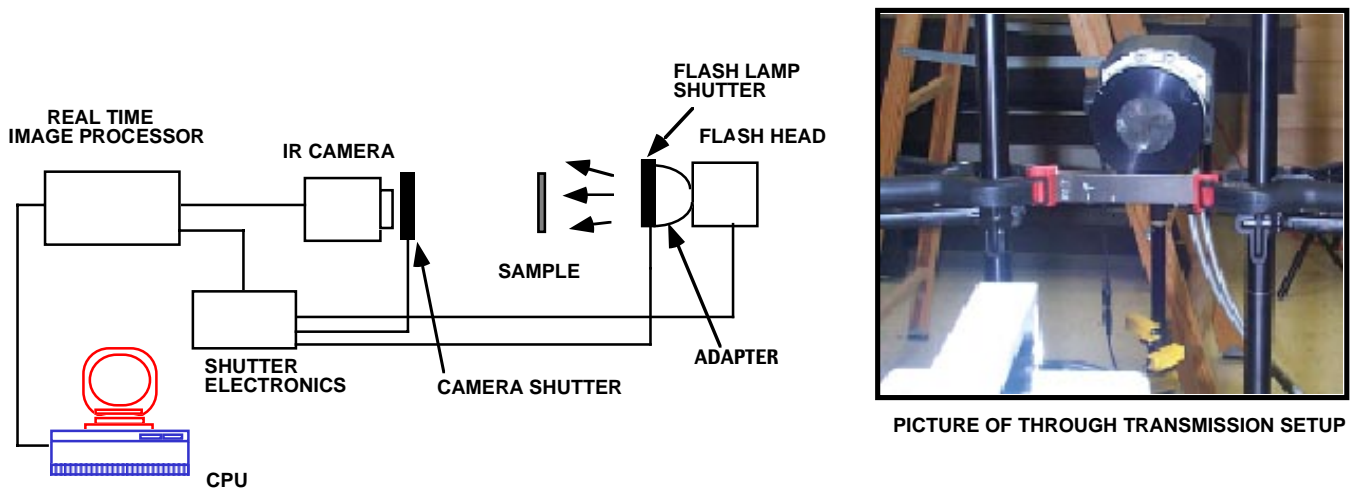

Figure 9. Schematic diagram of SESS through transmission implementation with picture.

4. CONCLUSIONS

It has been demonstrated that by using the SESS more improved thermal inspections are possible for both single side and through transmission setups. It has been shown that the transient cool down effect of the flash lamps after firing can effect the thermal inspection even for painted surfaces. Before the use of shutters, the state of the art was to optimize the angular position of the flash lamps in a way to minimize these reflections, this however does not totally remove them. Another approach was to minimize the heat lamp effects by using filters such as Plexiglas or quartz glass which are opaque in the infrared but transmit in the optical wavelength where the majority of heating occurs. The draw back of opaque filters is since they are in the line of fire they can attenuate the flash heat energy delivered to the object being inspected and since

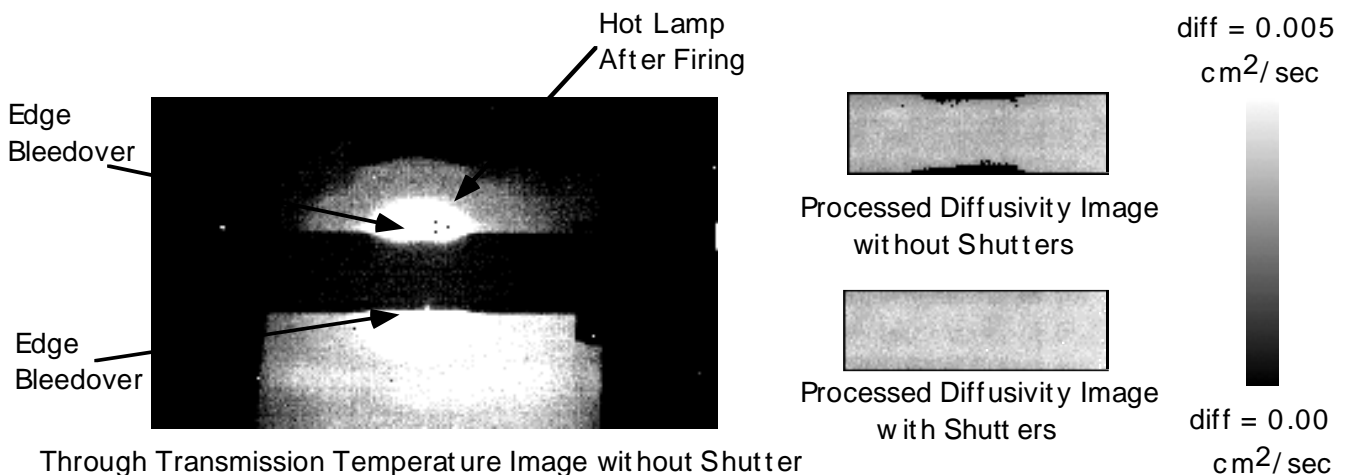

Figure 10. Through transmission diffusivity measurement of a 2.54 x 12.7 centimeter composite sample.

they absorb some energy, they tend to radiate heat thereby causing a transient cool down effect onto the thermal data. By using the SESS, the transient cool down effect of the flash lamp is removed. This is of additional importance when inspecting surfaces that are not high in emissivity. For infrared reflective surfaces the flash lamp cool down reflected back into the camera could dominate the measurement. In some instances as shown in figure 8 the coating of a surface before inspection may not be necessary. It has also been observed that surface emissivity variations are enhanced when the hot flash lamps are allowed to radiate onto an unpainted sample after firing.

Because infrared thermography requires the detection of small temperature differences on the surface for the detection of underlying defects it has been shown that by using the SESS improved defect resolution can be obtained. By using the SESS any unwanted flash lamp reflections are removed and therefore simplifies interpretation of the processed thermal images. The SESS is easily implemented on existing thermal inspection systems because the SESS is low cost, the timing electronics is very simple, and the shutters require very low power.

ACKNOWLEDGEMENTS

The author would like to acknowledge Mr. Jeff Seebo of Lockheed Martin for his design and fabrication help of the flash lamp adapter.

REFERENCES

- 4 M. J. Adams and Elton M. Crisman, U. S. Patent No. 4,854,724, March 1986.
- 5 T. Sakagami, S. Kubo, and Y. Teshima, "Fatigue crack identification using near-tip singular temperature field measured by lock-in thermography", Proceedings of SPIE, Thermosense XXII, 2000, pp. 174-181.
- 6 J. N. Zalameda and W. P. Winfree, "Thermal diffusivity measurements in composite porosity samples", Review of Progress in Quantitative NDE, edited by D. O. Thompson and D. E. Chimenti (Plenum Press, NewYork, 1989), pp. 1541 - 1547, Vol. 9B.
- 7 K. Tsuchimoto and A. Sema, U. S. Patent No. 5,994,701, Oct. 1997.
- 8 Indigo Systems Inc., Alpha uncooled microbolometer camera user's guide, 412-0003-10, Version 1.0.
- 9 J. N. Zalameda, W. P. Winfree, D. M. Heath, and J. T. Thornhill, "Heat source characterization for quantitative thermal nondestructive evaluation", Review of Progress in Quantitative NDE, edited by D. O. Thompson and D. E. Chimenti (Plenum Press, NewYork, 1998), pp. 585 - 592, Vol. 18A.
- 10 W. P. Winfree, B. S. Crews, H. I. Syed, P. H. James, and K.E. Cramer, "Thermographic Detection of disbonds in riveted lamp joints", 37th International Instrumentation Symposium, Denver, CO, pp. 1097-1105, 1991.
- 11 J. N. Zalameda, G. L. Farley, and B. T. Smith, "A field deployable nondestructive impact damage assessment for composite structures", American Society for Testing and Materials Journal of Composite Technology and Research, Vol. 18, No. 7, pp. 44-46.
- 12 K. E. Cramer and W. P. Winfree, "The application of thermal diffusivity imaging to SIC-Fiber reinforced silicon nitride", Review of Progress in Quantitative NDE, edited by D. O. Thompson and D. E. Chimenti (Plenum Press, NewYork, 1993), pp. 1305 - 1312, Vol. 12B.