

The Stability of the Boundary Layer and the Spot
(the effects on its shape, rate of growth and internal structure)

I. Wygnanski

Department of Fluid Mechanics and Heat Transfer
Tel Aviv University
Ramat-Aviv, Israel 66978

Aerospace and Mechanical Engineering Department
University of Arizona
Tucson, AZ 85721

ABSTRACT

The similarity among turbulent spots observed in various transition experiments, and the rate in which they contaminate the surrounding laminar boundary layer is only cursory. The shape of the spot depends on the Reynolds number of the surrounding boundary layer and on the pressure gradient to which it and the surrounding laminar flow are exposed. The propagation speeds of the spot boundaries depend, in addition, on the location from which the spot originated and do not simply scale with the local free stream velocity. The understanding of the manner in which the turbulent spot destabilizes the surrounding, vortical fluid is a key to the understanding of the transition process. We therefore turned to detailed observations near the spot boundaries in

general and near the spanwise tip of the spot in particular.

Two, oblique wave packets of the Tollmien - Schlichting type, were observed beyond the tip of the spot. They passively trailed the spot when the surrounding boundary layer was marginally stable, but beyond the critical Re they amplified and broke down generating either new autonomous spots or coalescing with the "parent" spot and changing its shape and its rate of growth. When the boundary layer stability was enhanced by favorable pressure gradient the wave packets disappeared. Their absence is associated with the smaller rate of spread of the spot in a favorable pressure gradient.

Measurements of all three components of velocity in a turbulent spot are rare, particularly near the tip of the spot. A special hot-wire rake consisting of 8 "V" arrays was built in order to measure the spanwise and streamwise components of velocity simultaneously over a sizable fraction of the span of the spot. The data reveals the existence of a strong spanwise component of velocity which increases monotonically with increasing distance from the plane of symmetry and attains its maximum value near the tip. This perturbation velocity resembles a wave which follows the leading interface of the spot and looks like a single vortex near the tip. It also changes direction near the tip from having the dominant vorticity component parallel to the leading interface to a dominant, yet diffused vertical vorticity. A typical dimension of this vortex is comparable to 20% of the span of the spot at the location measured. This observation does not support the notion which is based on observations in a nascent spot that a spot may consist of an orderly formation of "A" vortices whose number is proportional to the size of the spot. No such vortices were observed near the tip of a fully aged (or developed) spot when they were analyzed by similar techniques.

THE STABILITY OF THE BOUNDARY LAYER AND THE SPOT

(the effects on its shape, rate of growth and internal structure)

I. Wygnanski

Department of Fluid Mechanics and heat Transfer, Tel Aviv University,
Ramat- Aviv, Israel 66978
Aerospace and Mechanical Engineering Department, University of Arizona,
Tucson AZ. 85721

ACKNOWLEDGEMENTS

M. Zilberman

R. E. Kaplan

J. Haritonidis

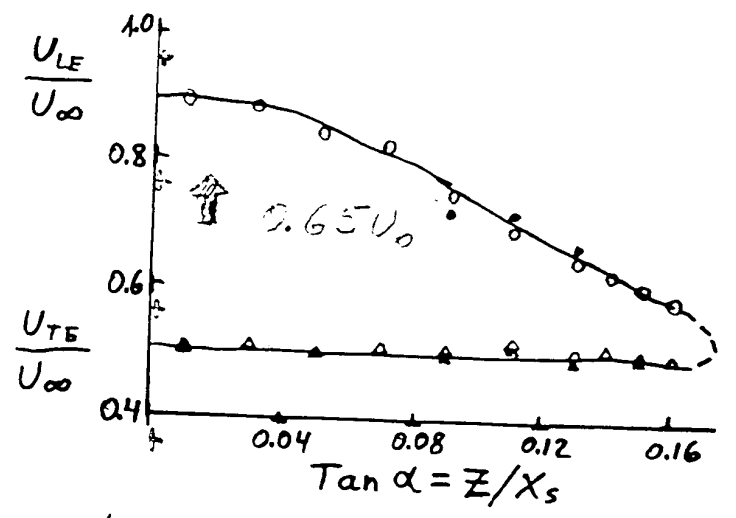
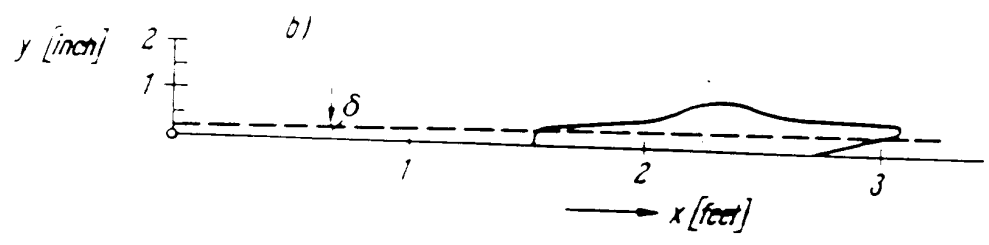
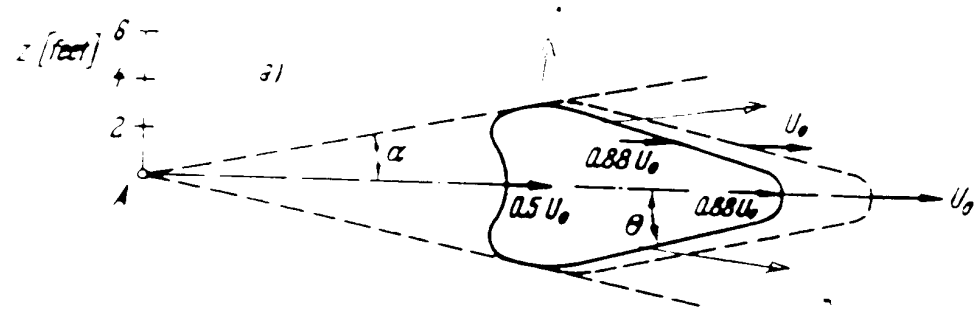
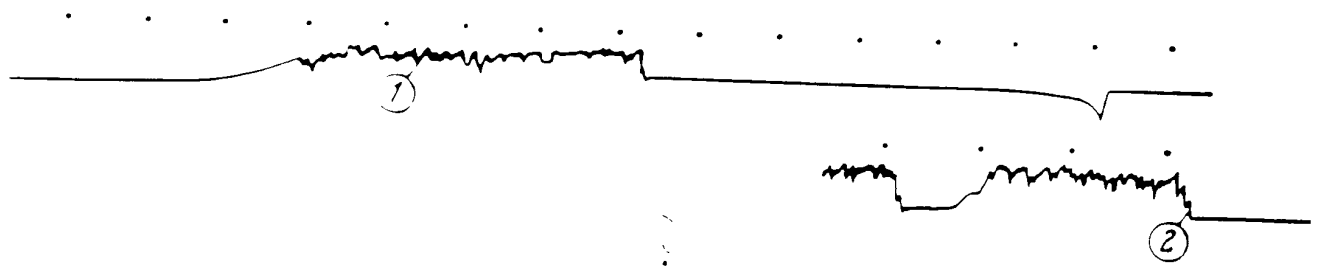
A. Glezer

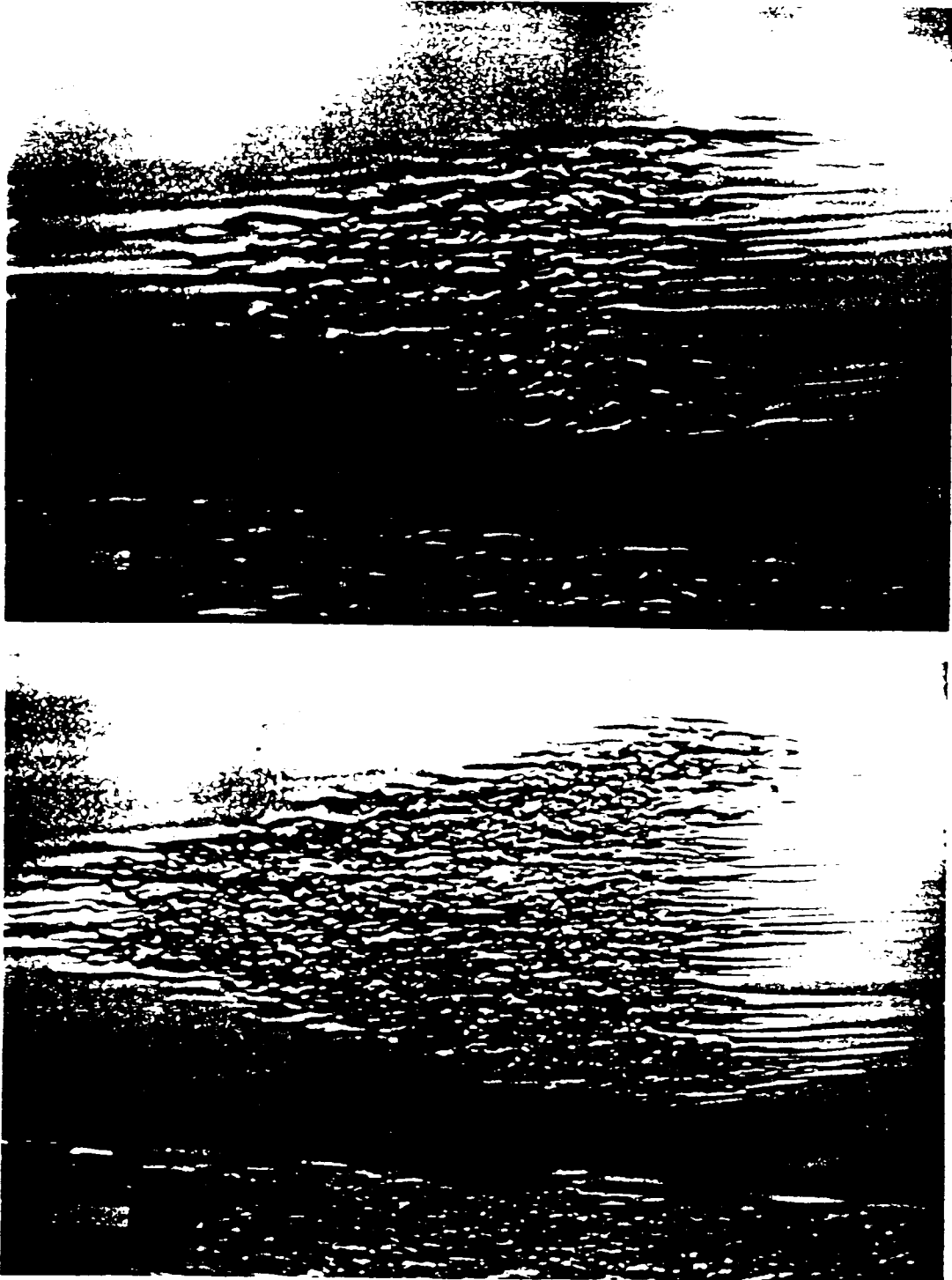
Y. Katz

A. Seifert

The work was supported for many years by AFOSR

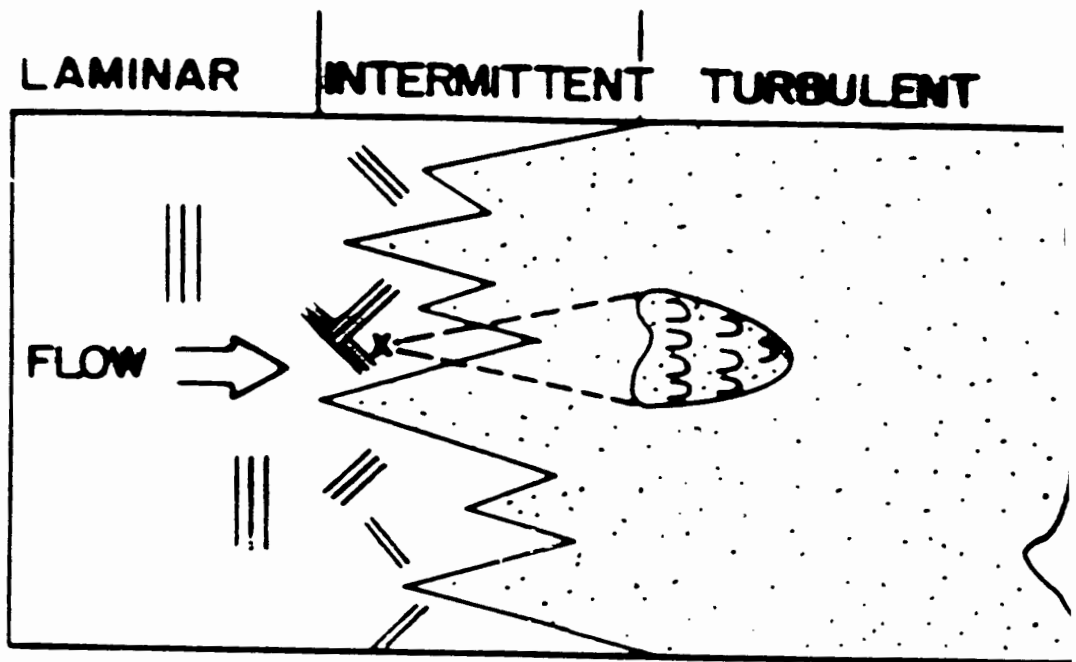
Journal of Applied Physics 195





Cantwell Coles & Dimotakis (1973)

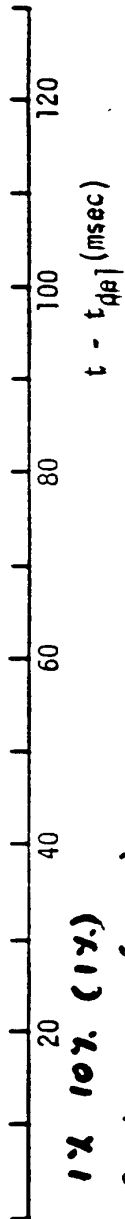
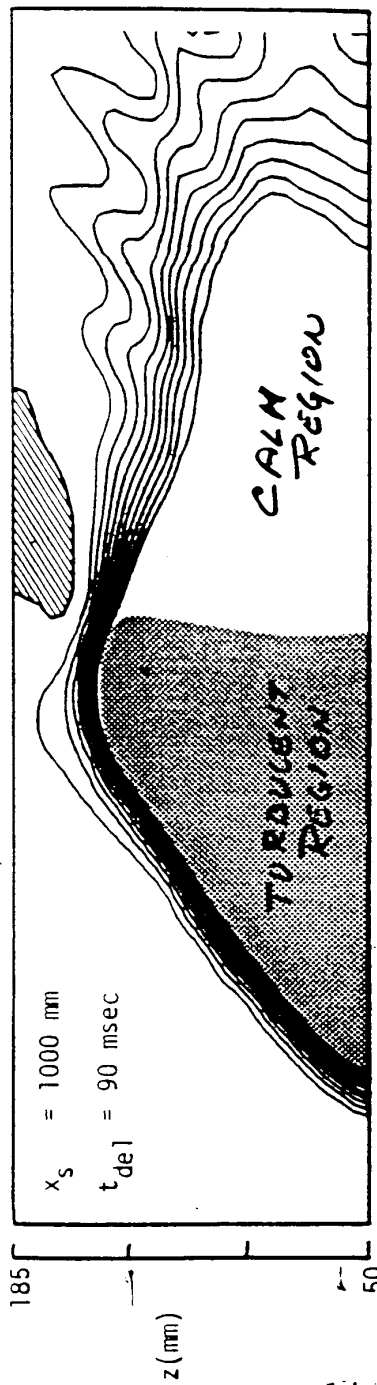
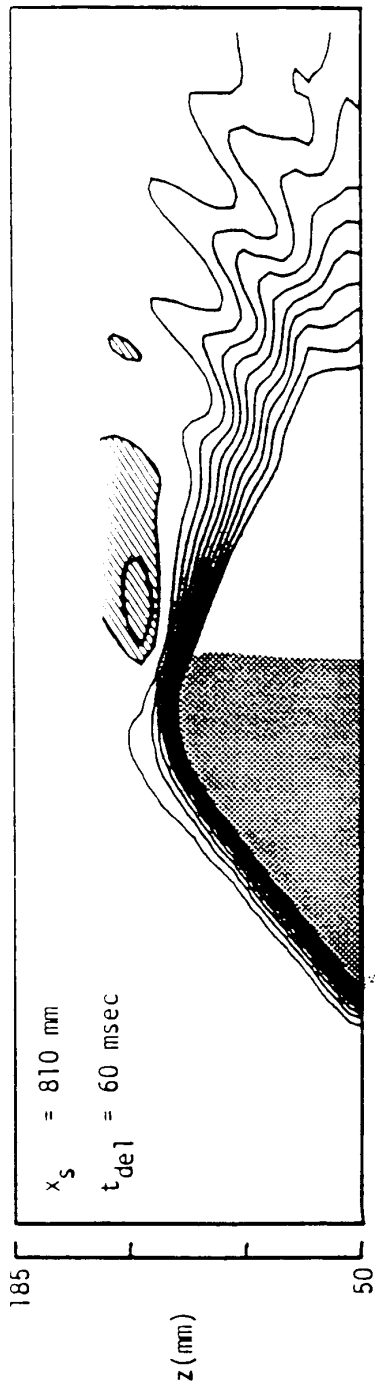
Figure 6. Aluminum visualization of sublayer streaks for turbulent spots in water. (a) Low Reynolds number; $U_{\infty} = 12$ cm/sec. (b) Higher Reynolds number; $U_{\infty} = 23$ cm/sec. Note region of transverse contamination from channel bottom.



1. The spot represents the final recognizable stage in the transition process.
2. It provides a linkage to linear stability.
3. It generates large coherent structures in a fully turbulent boundary layer.
4. It has a higher internal degree of order than the turbulent boundary layer.

$\beta \approx 0.$

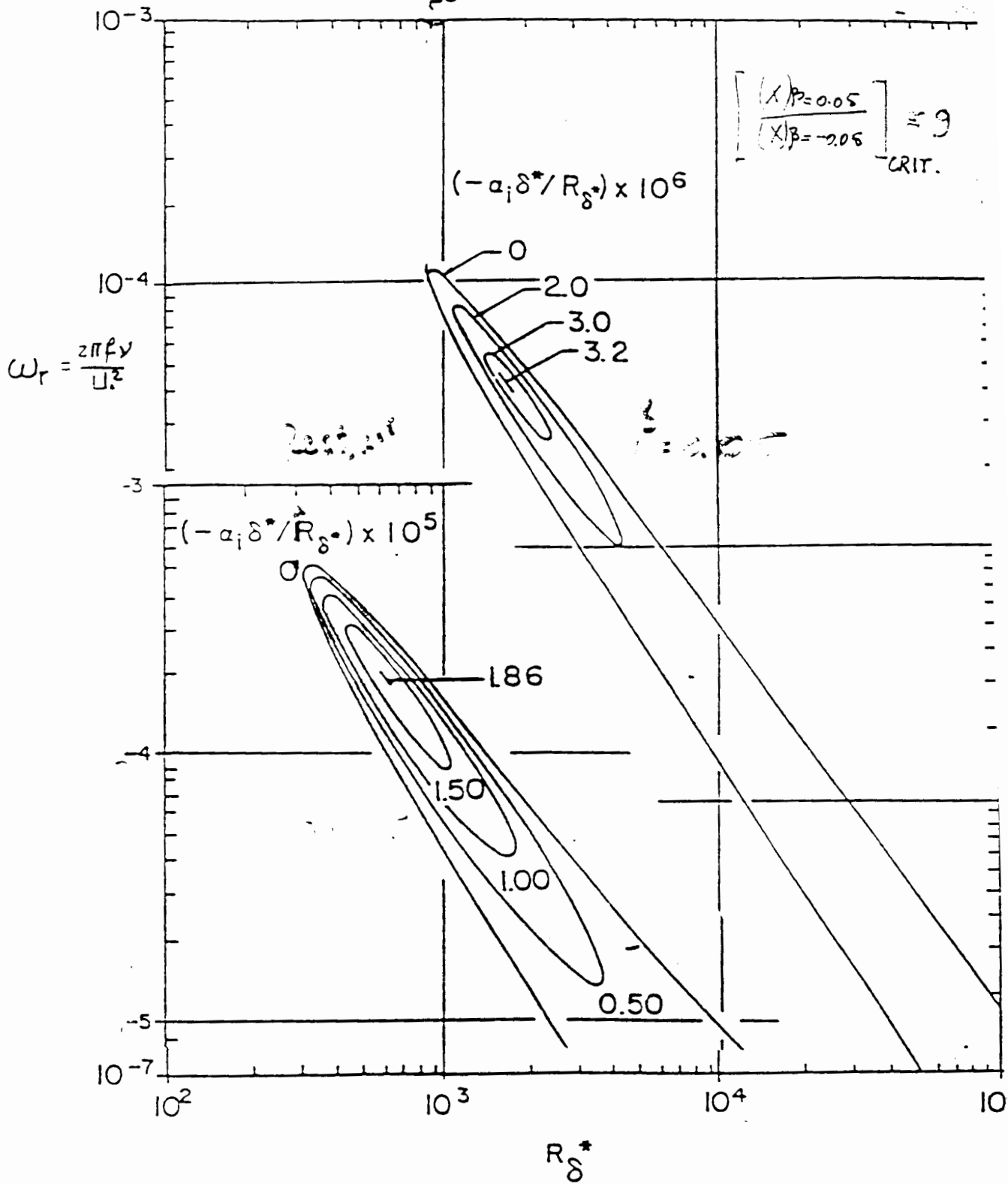
$$\frac{\gamma}{S^*} \approx 0.6$$



contour levels 1% 10% (1%)

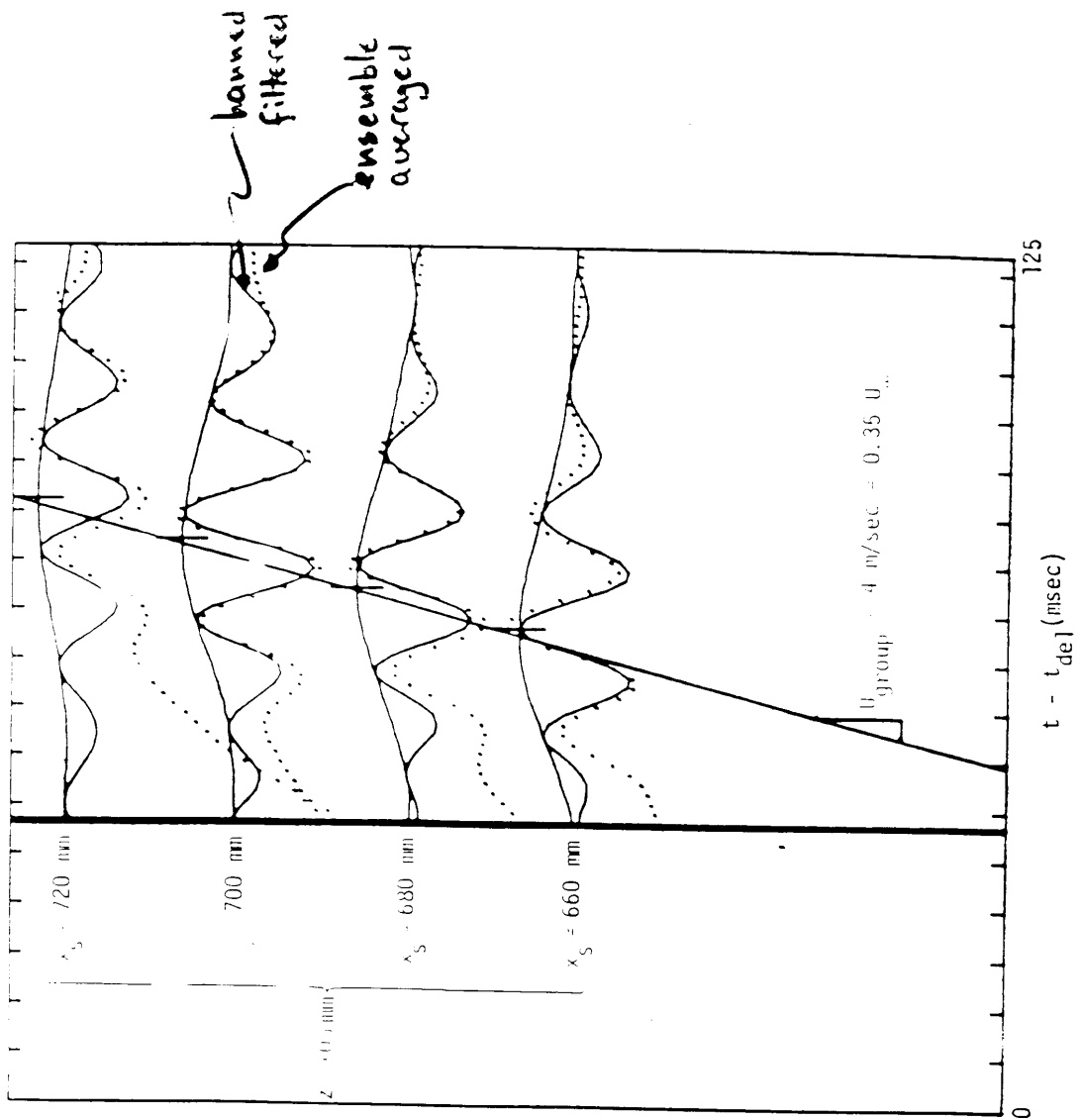
Not certain is not U_{de}

$$\langle \hat{v}(\bar{x}, t) \rangle = \langle v(\bar{x}, t) - v_{lam}(\bar{x}) \rangle \cdot \frac{1}{U_{\infty}}$$



WARZAN OKAMURA & SMITH (1968)

Figure 9. - Curves of constant spatial amplification rates ($\beta = 0.05$ (top)
 $\beta = -2.05$ (bottom))



Chamber
 & Thoma
 1995

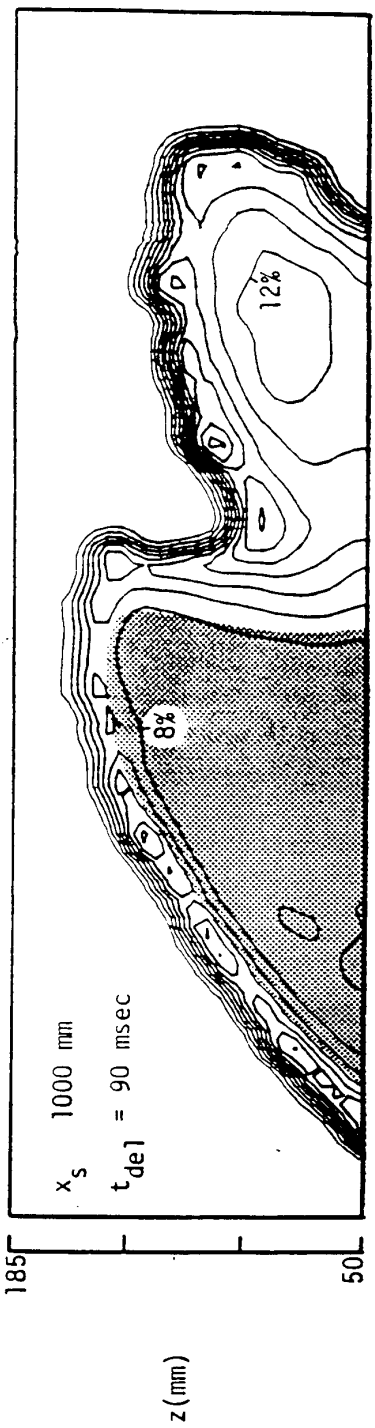
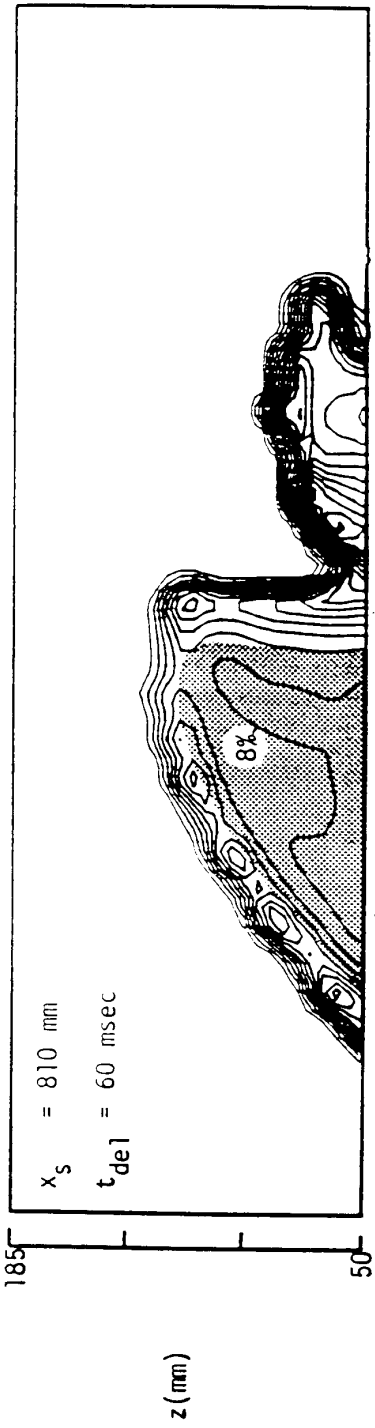
$$\langle u_c'^2(\bar{x}, t) \rangle = \frac{1}{\theta(\bar{x}, t)} \langle G(\bar{x}, t) \cdot u_c'^2 \rangle$$

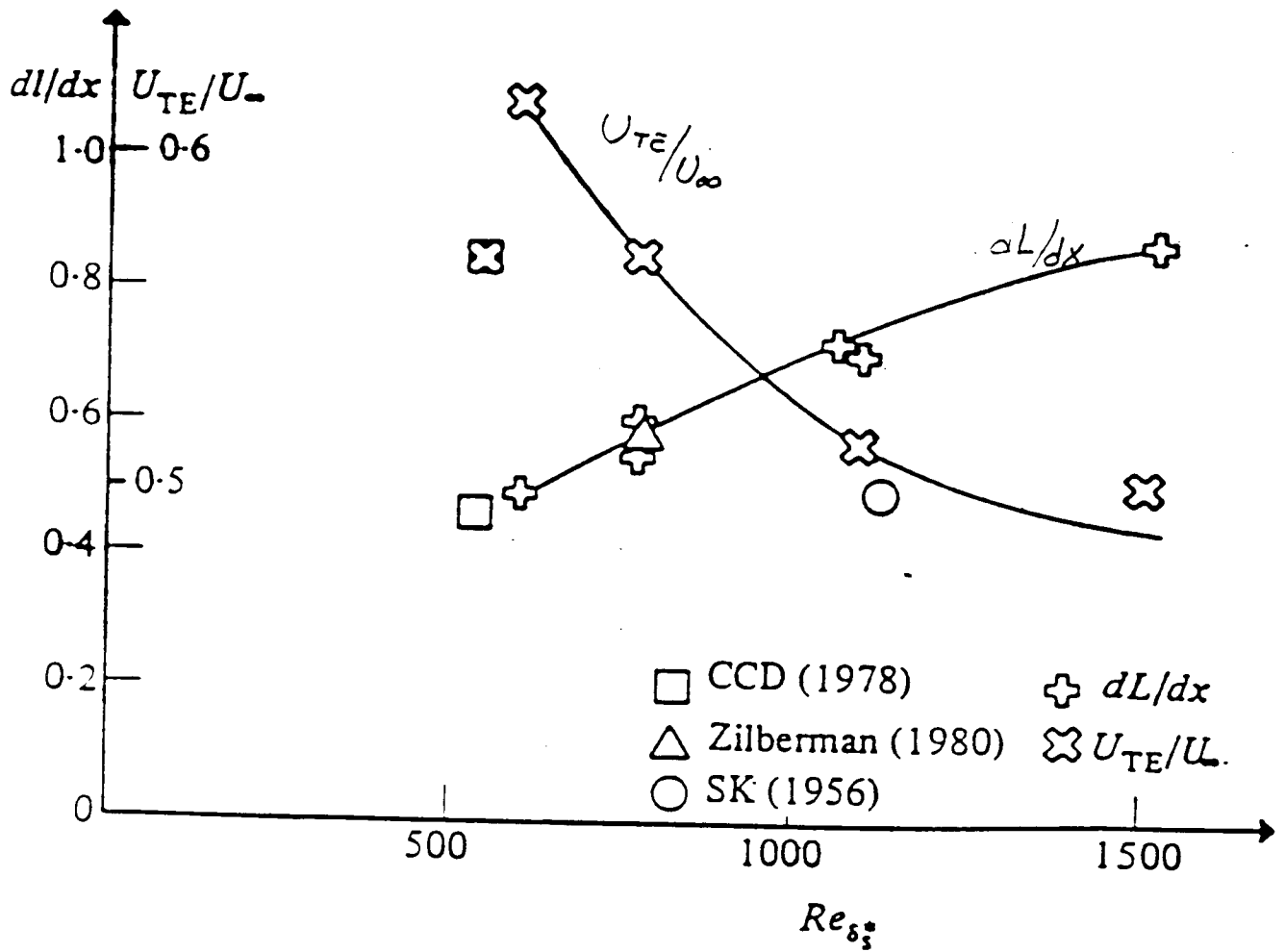
$$\beta = 0.0$$

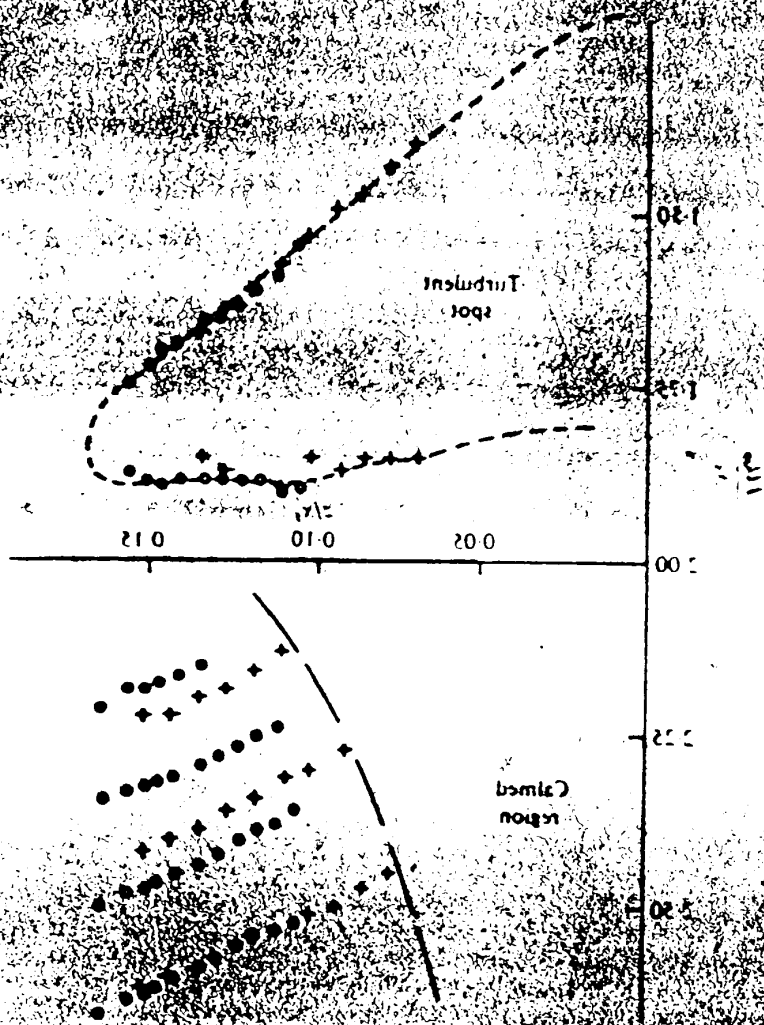
$$\frac{\lambda}{S^*} = 0.6$$

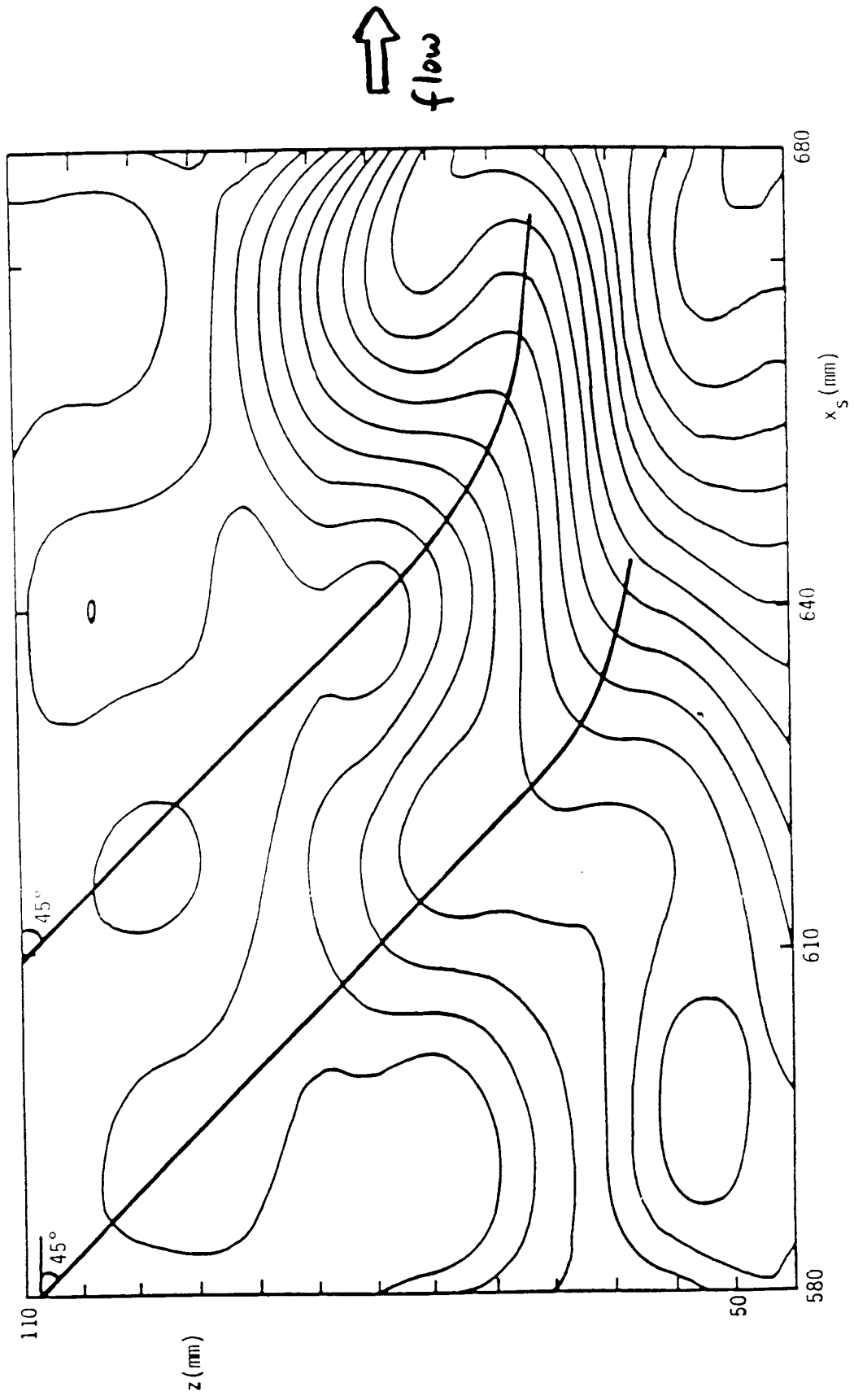


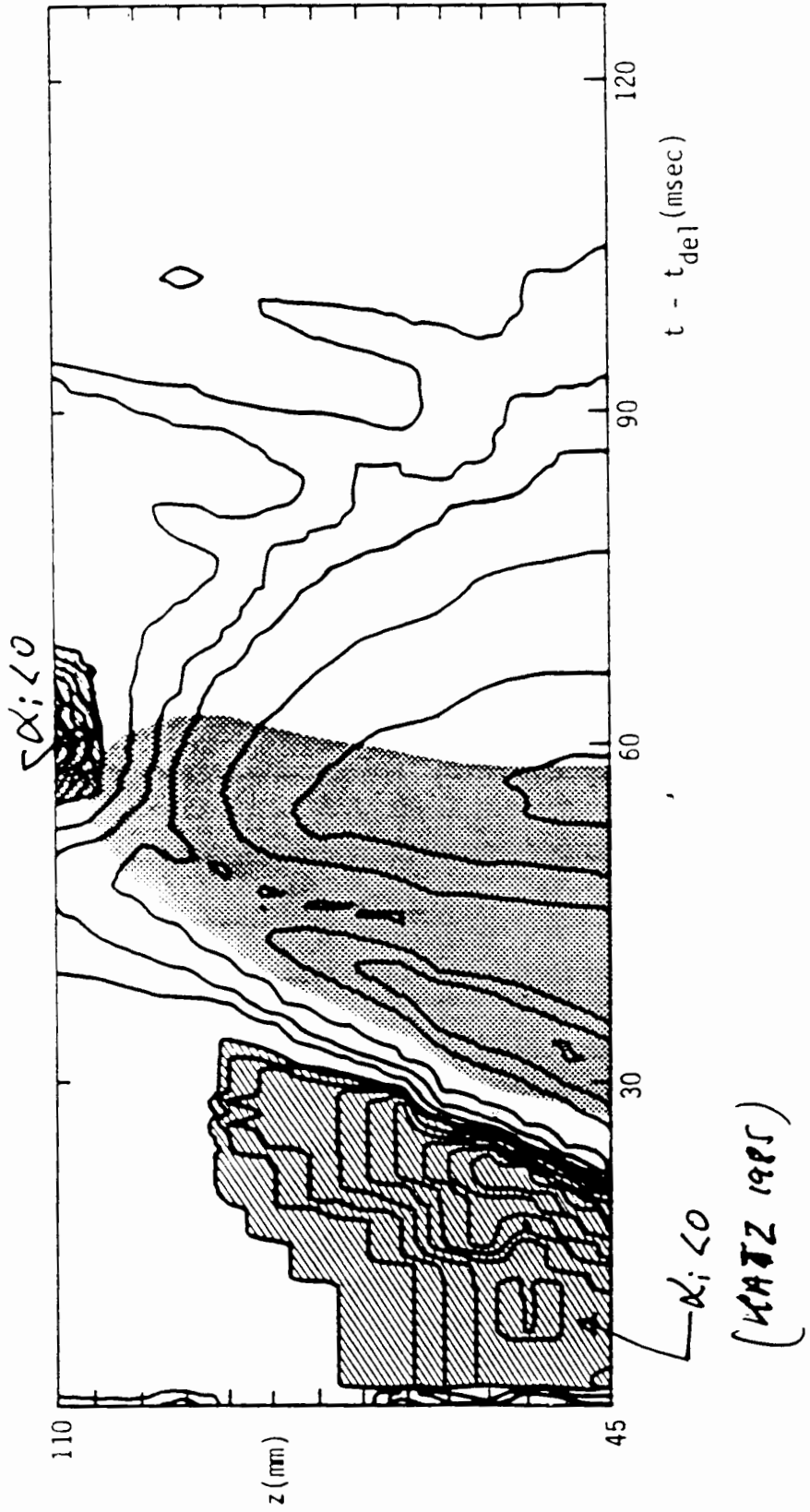
Note origin

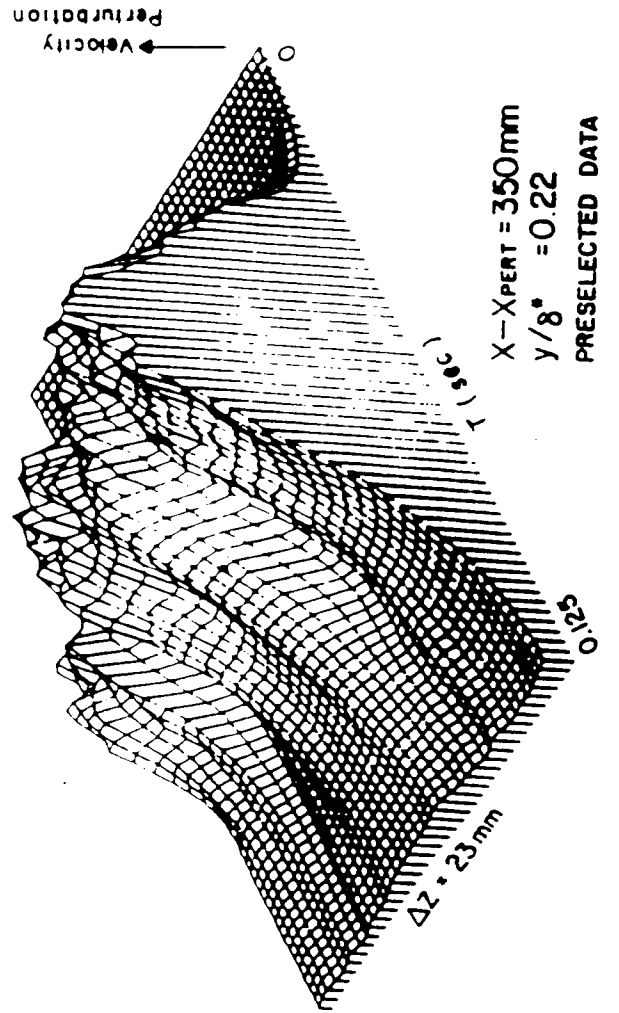
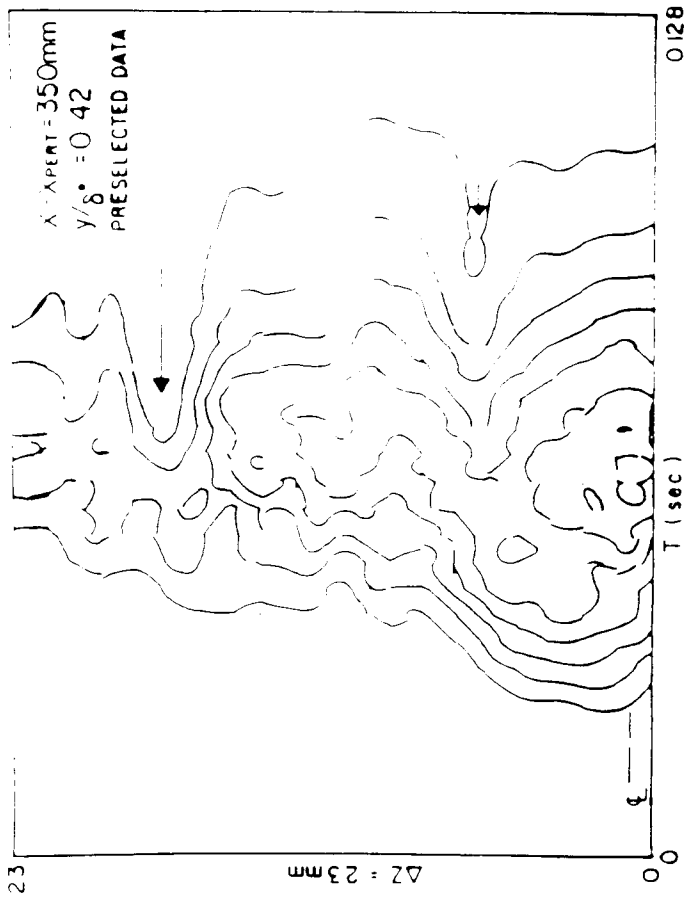


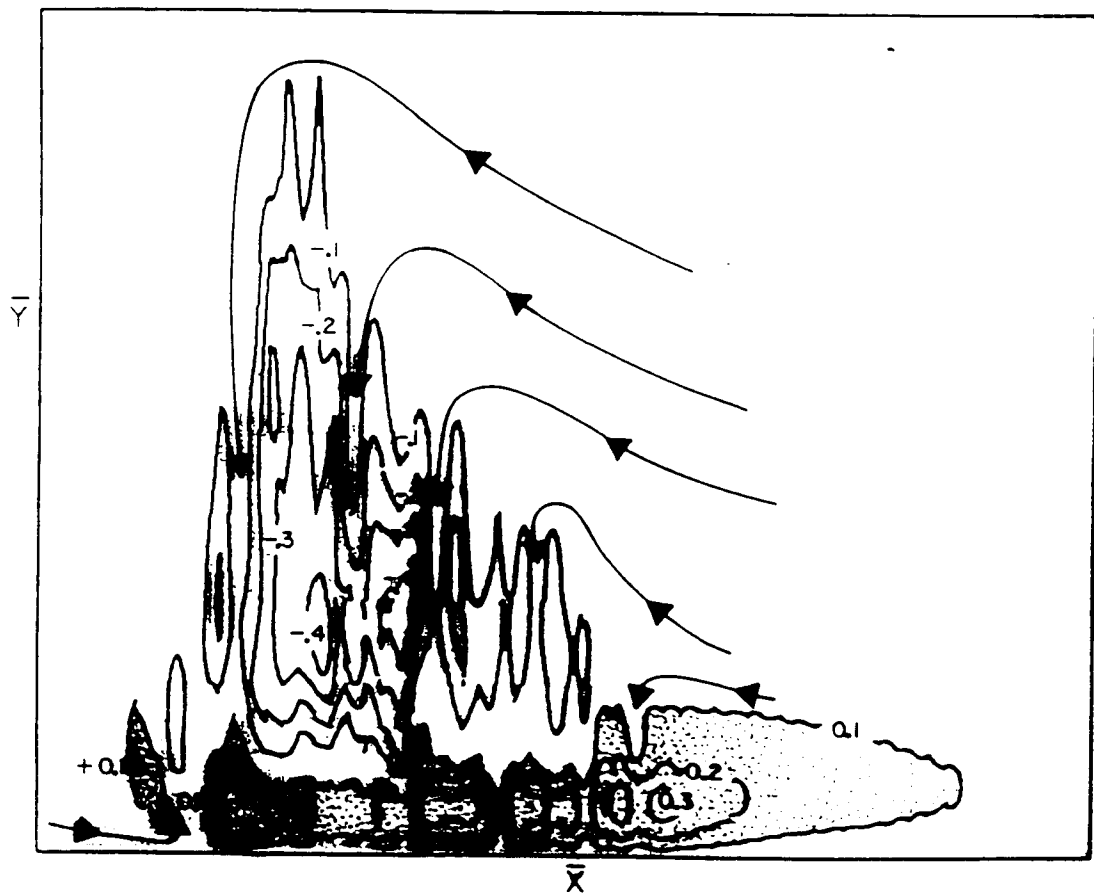
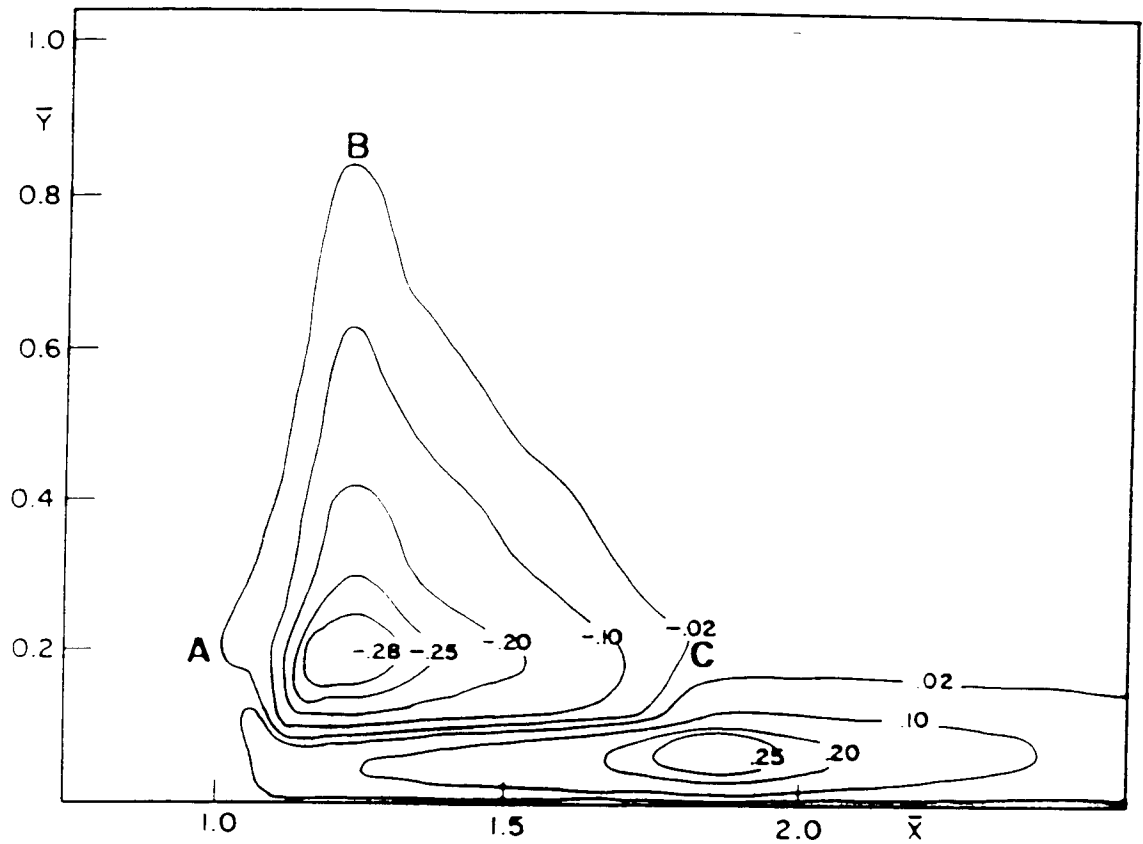












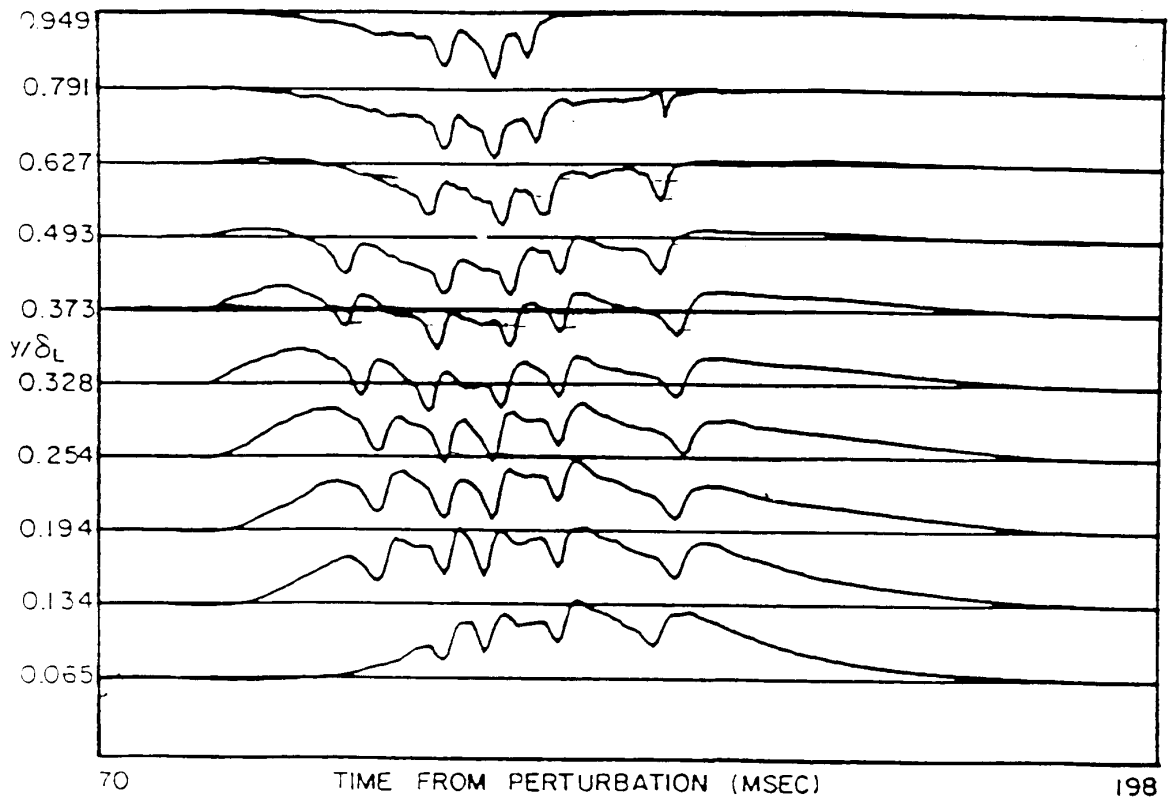


FIG. 6b

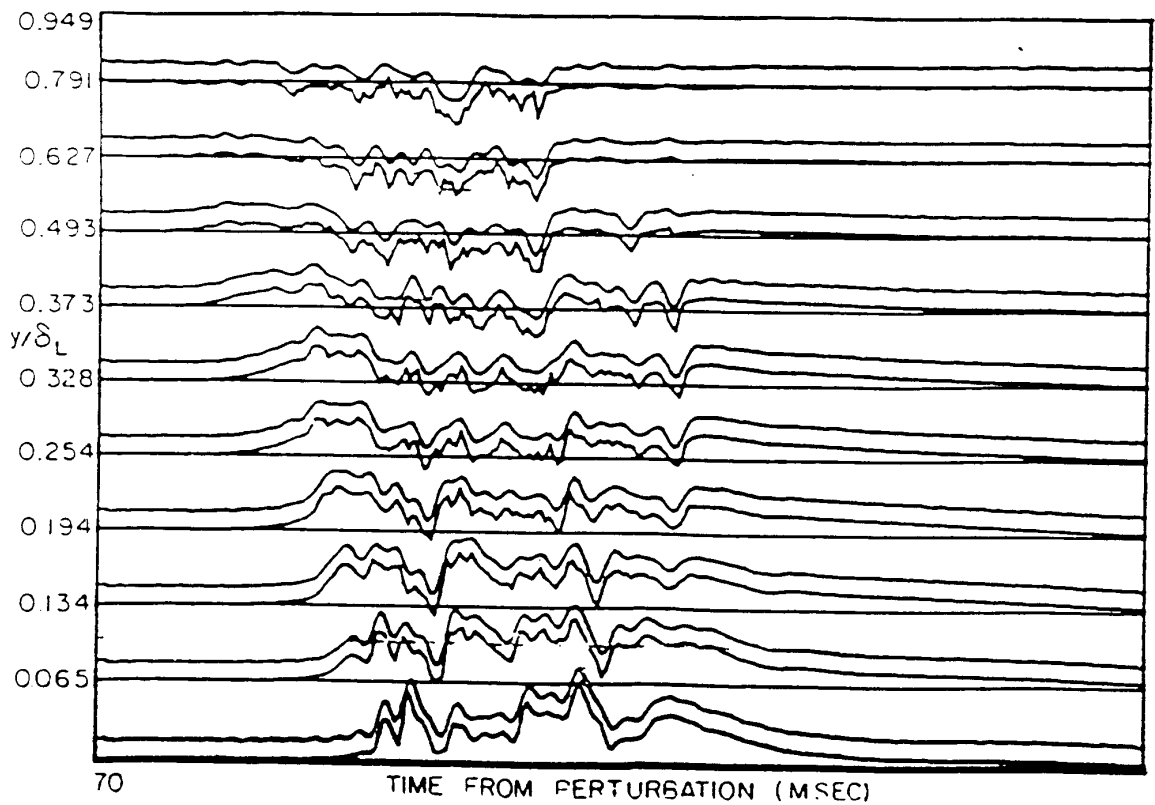


FIG. 6a

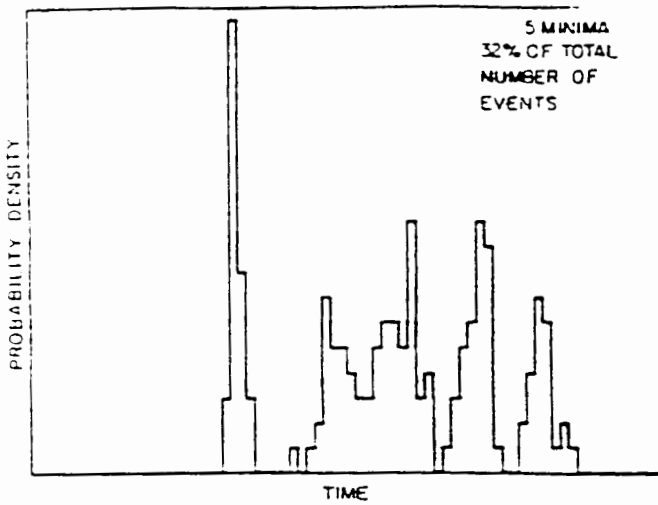


FIG. 7: HISTOGRAMS SHOWING THE PREFERRED TIME OF ARRIVAL OF EDDIES IN THE MOST PROBABLE SPOT AT A GIVEN LOCATION.

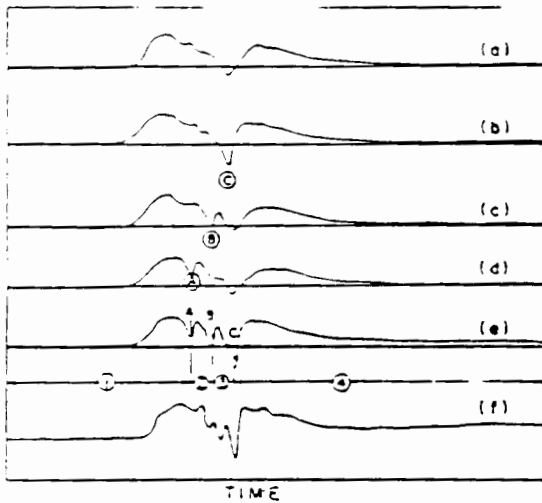


FIG. 8: A SCHEMATIC DIAGRAM SHOWING THE EDUCTION TECHNIQUE

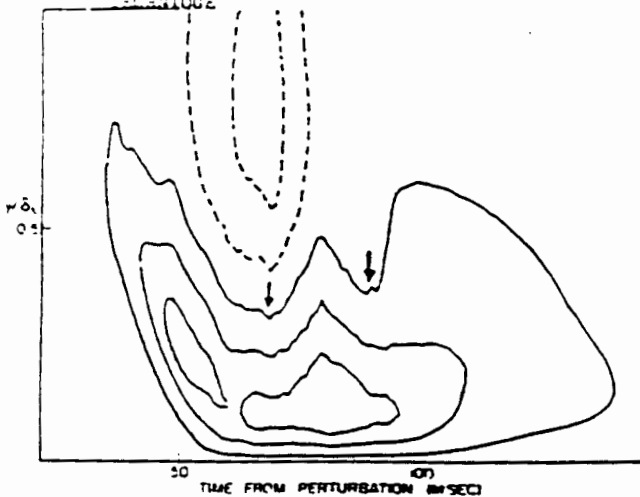


FIG. 9: VELOCITY PERTURBATION CONTOURS RESULTING FROM A PASSAGE OF A SPOT a) simple ensemble average

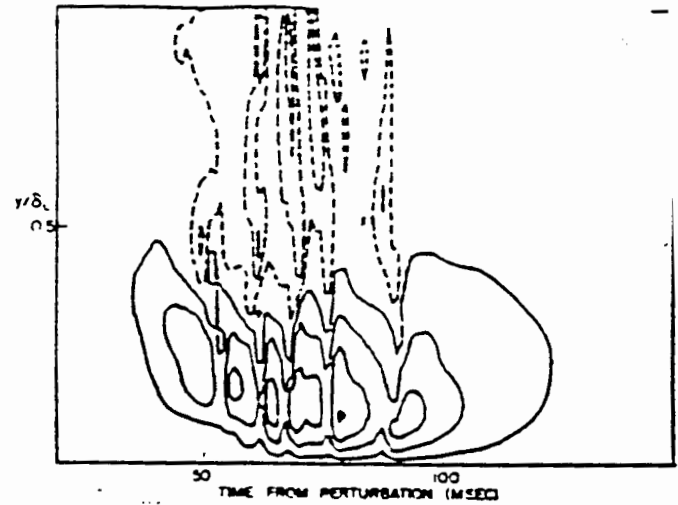


FIG. 9: b) the most probable realization

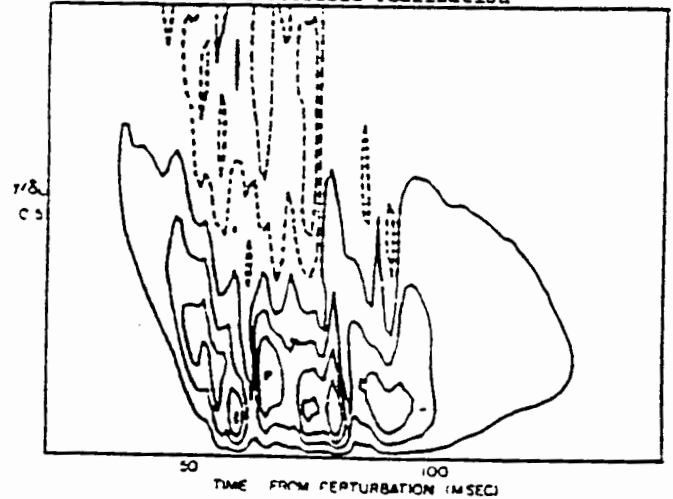


FIG. 9: c) a single realization

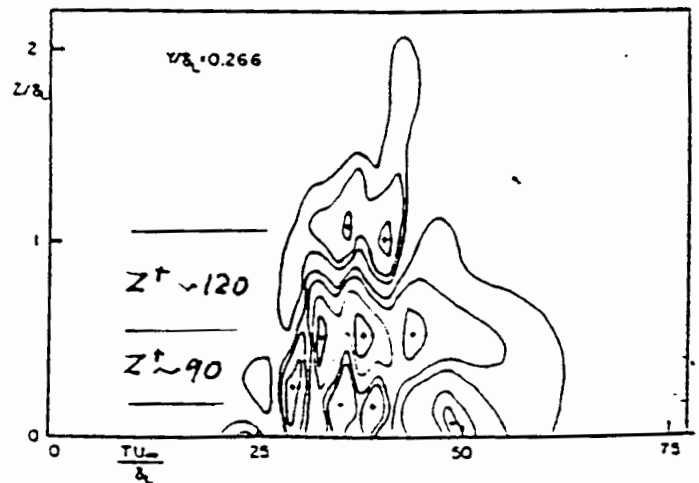
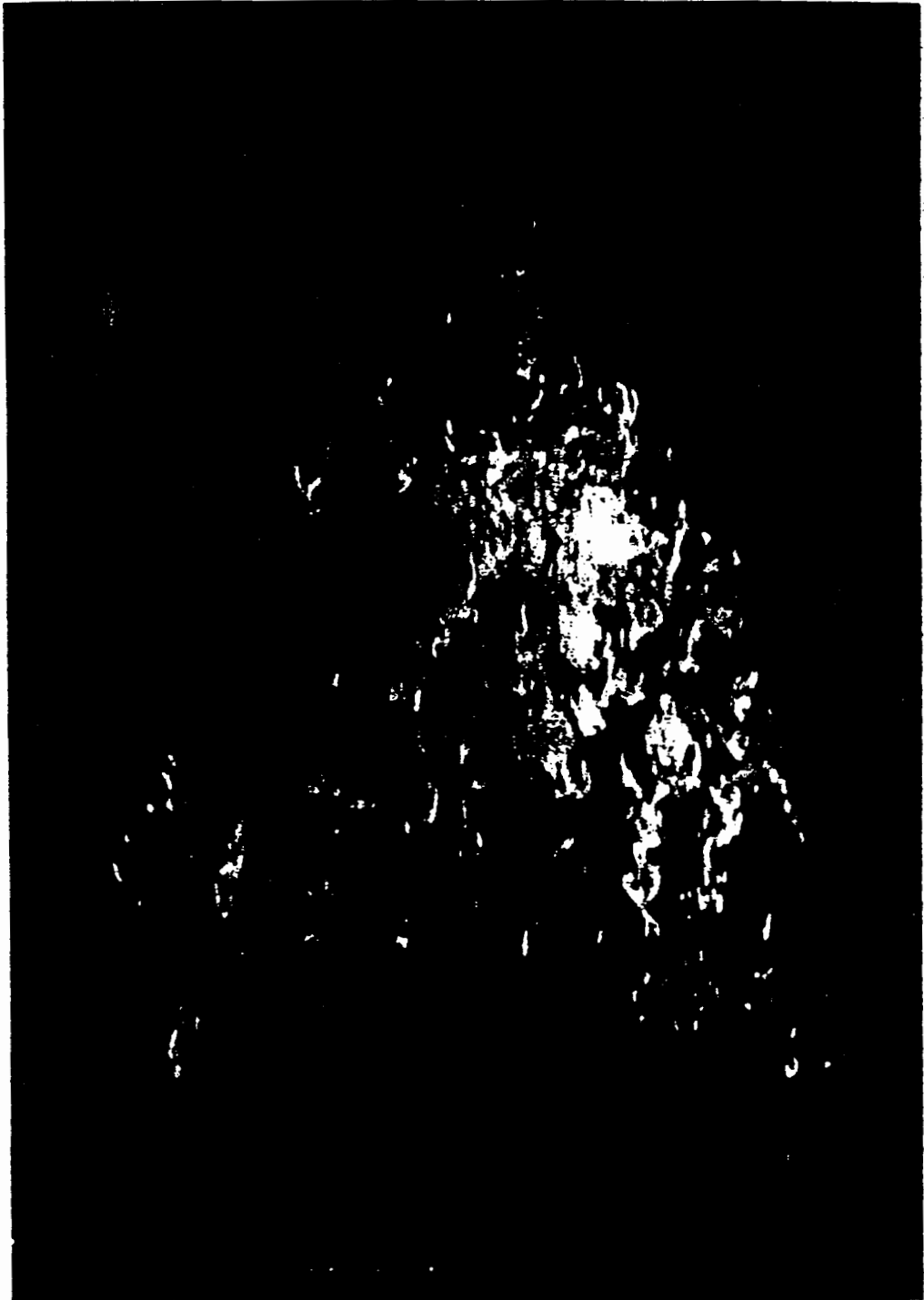
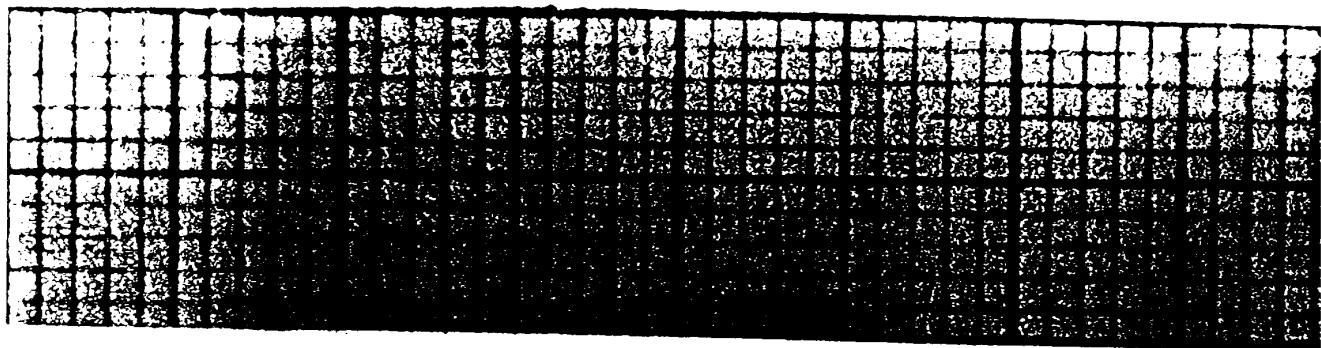
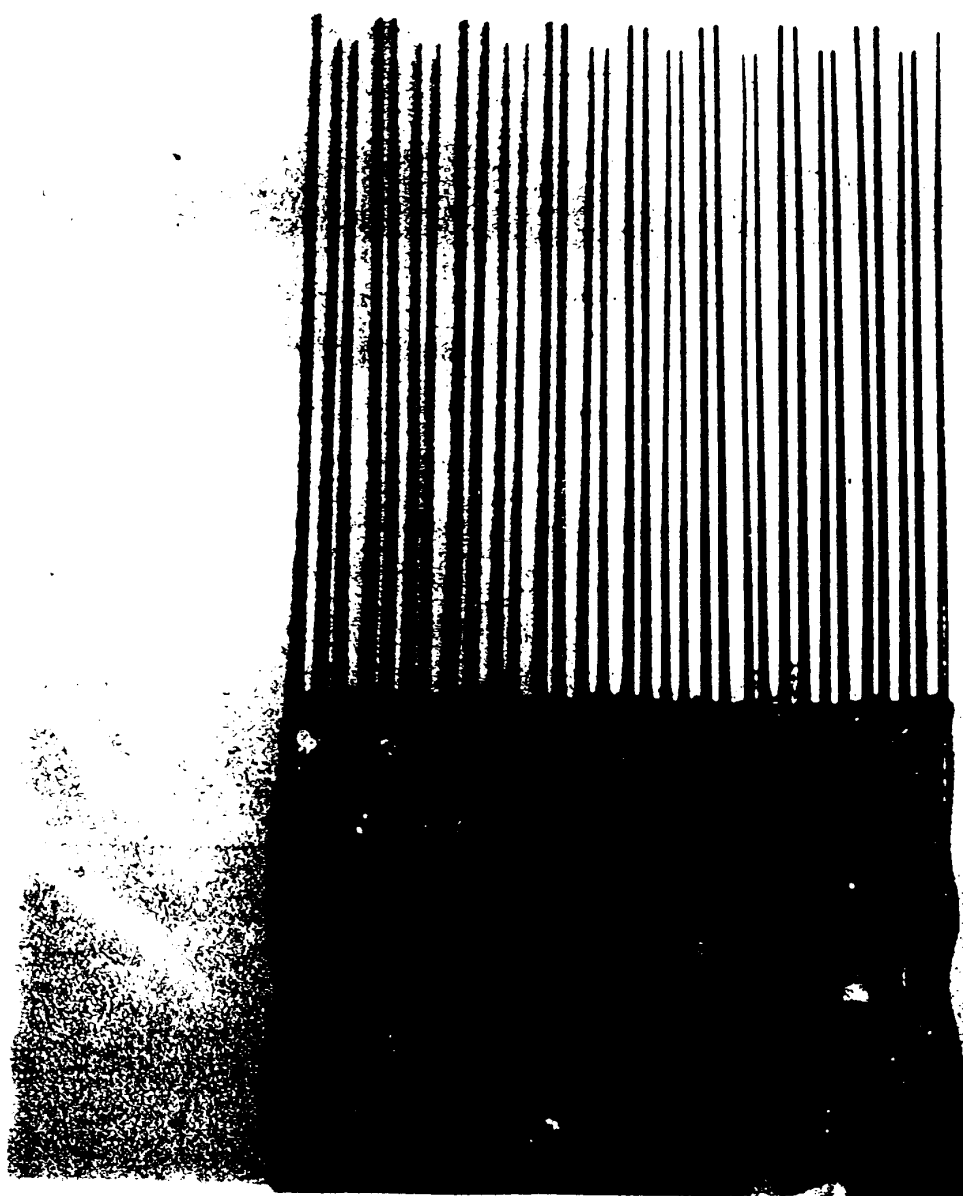


FIG. 10: PLAN VIEW OF A SPOT. MOST PROBABLE REALIZATION





5 mm



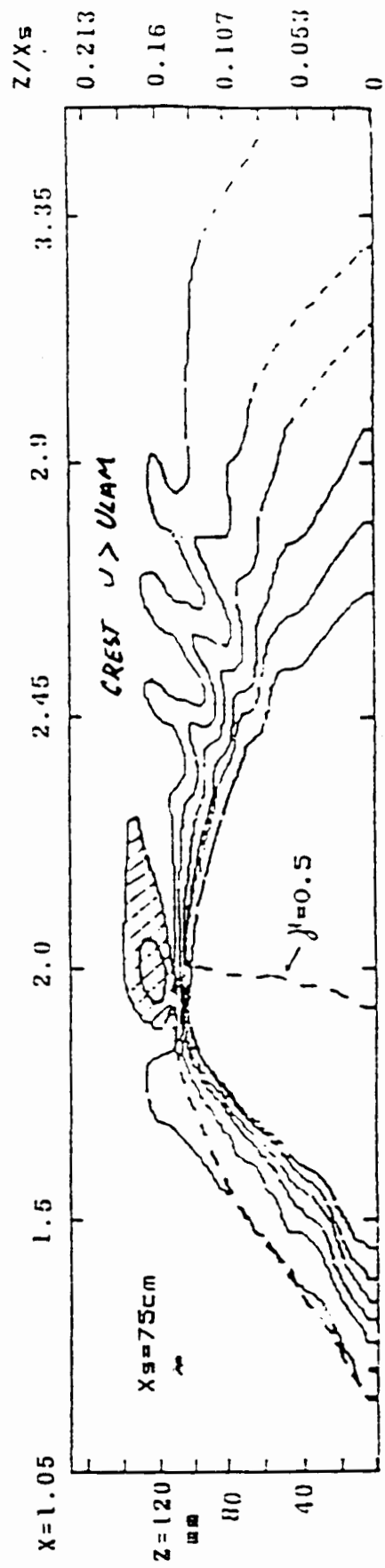
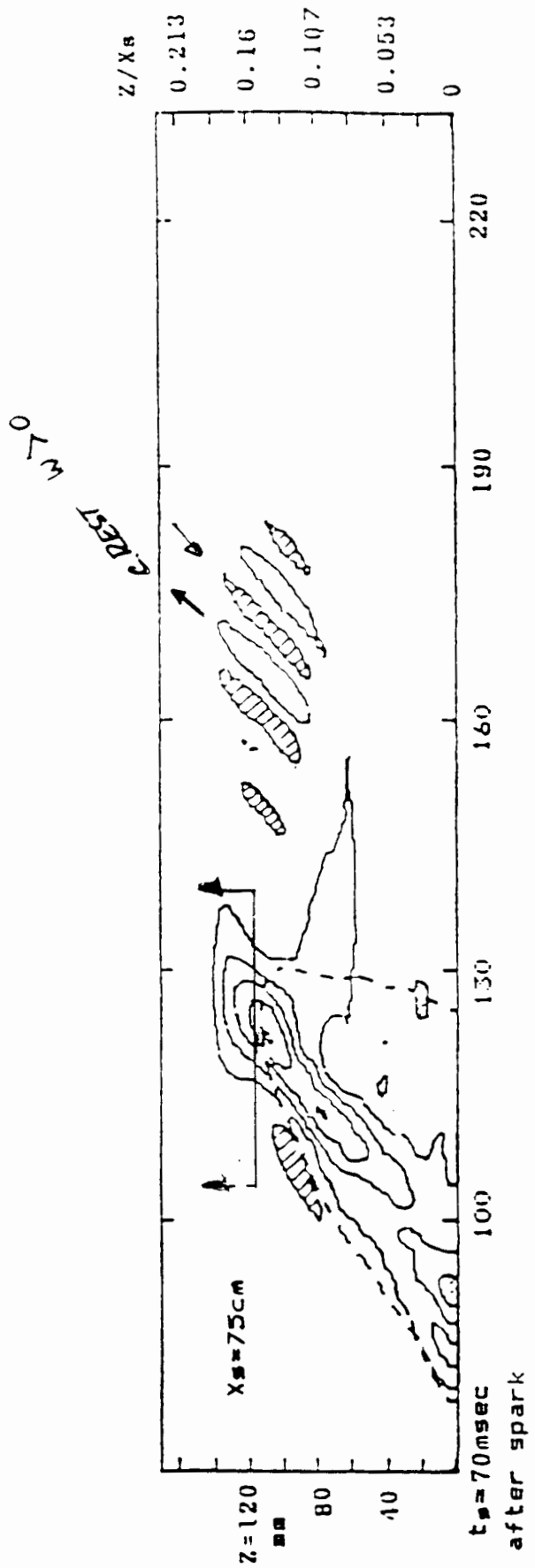


Fig. 4.2.4 comparison between Educated U perturbation (lower fig.) and Educated W (upper fig.) at $X_s=75\text{cm}$.

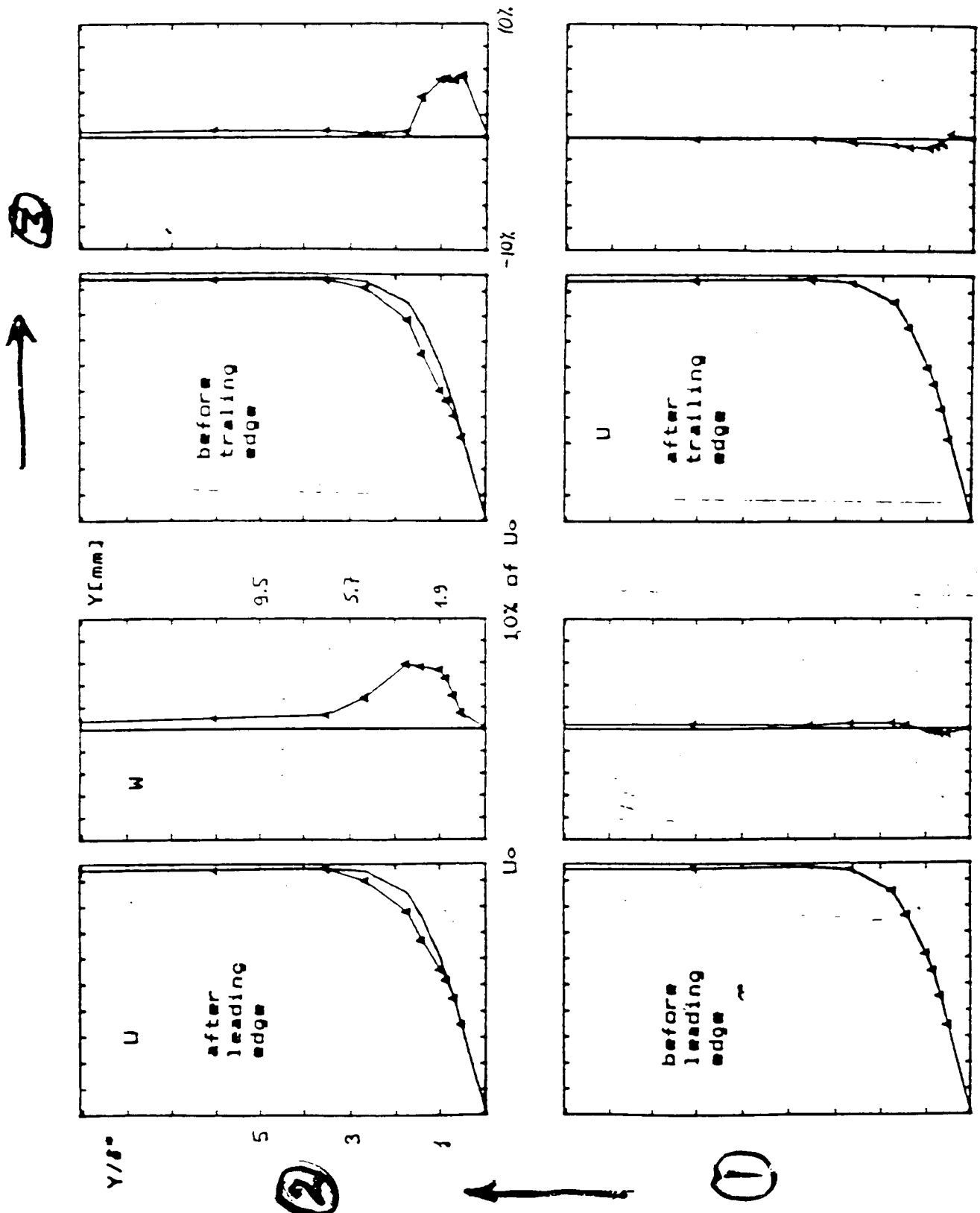
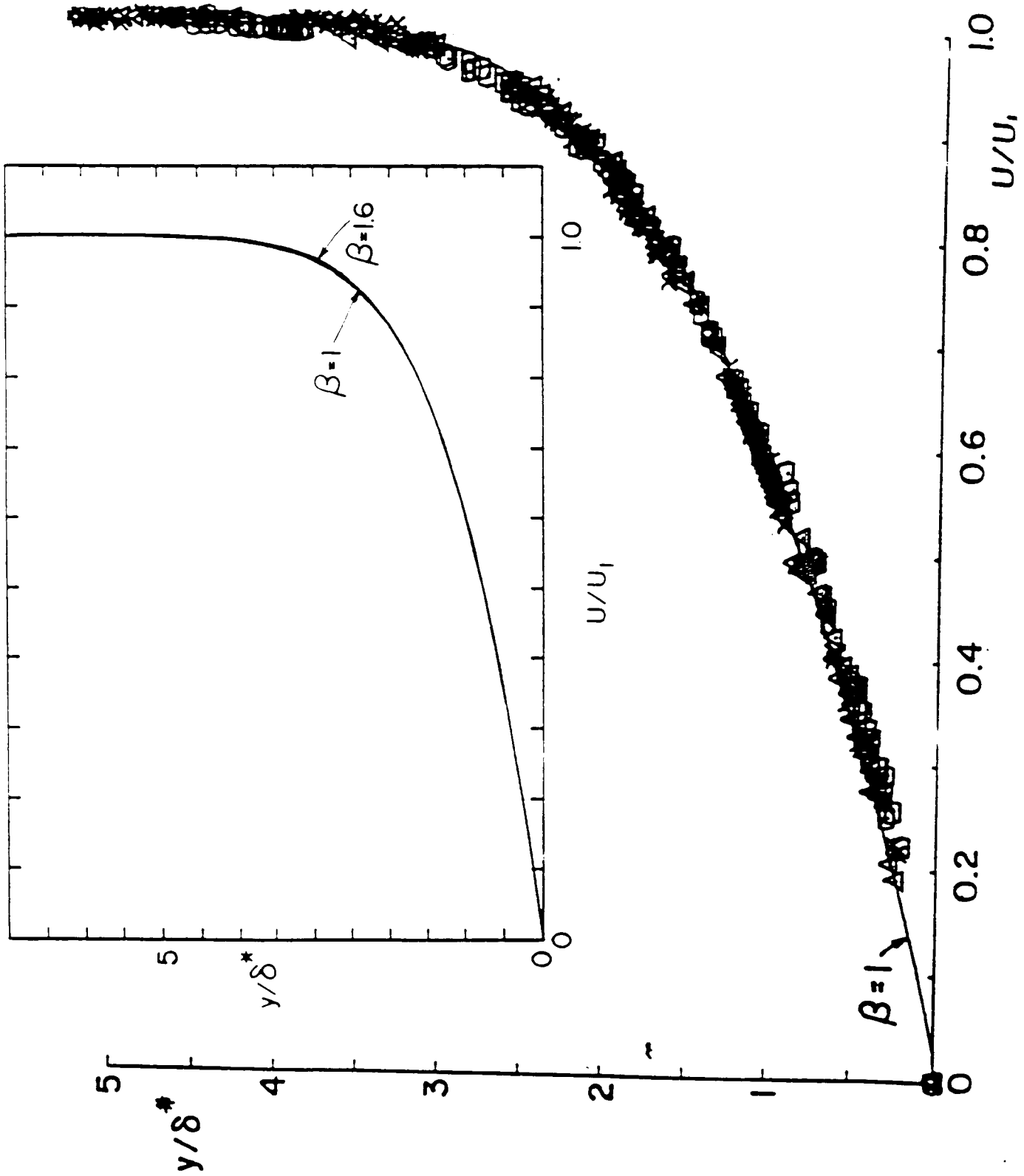
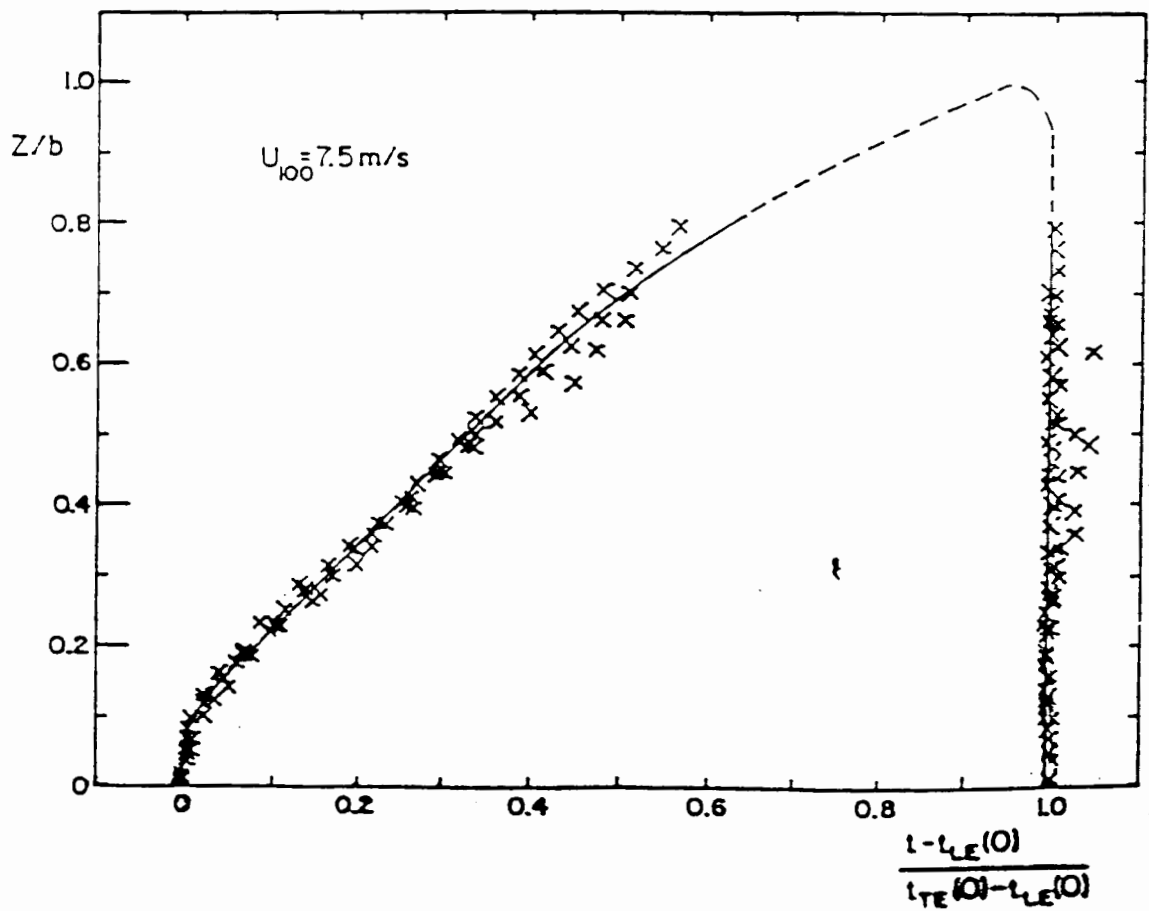
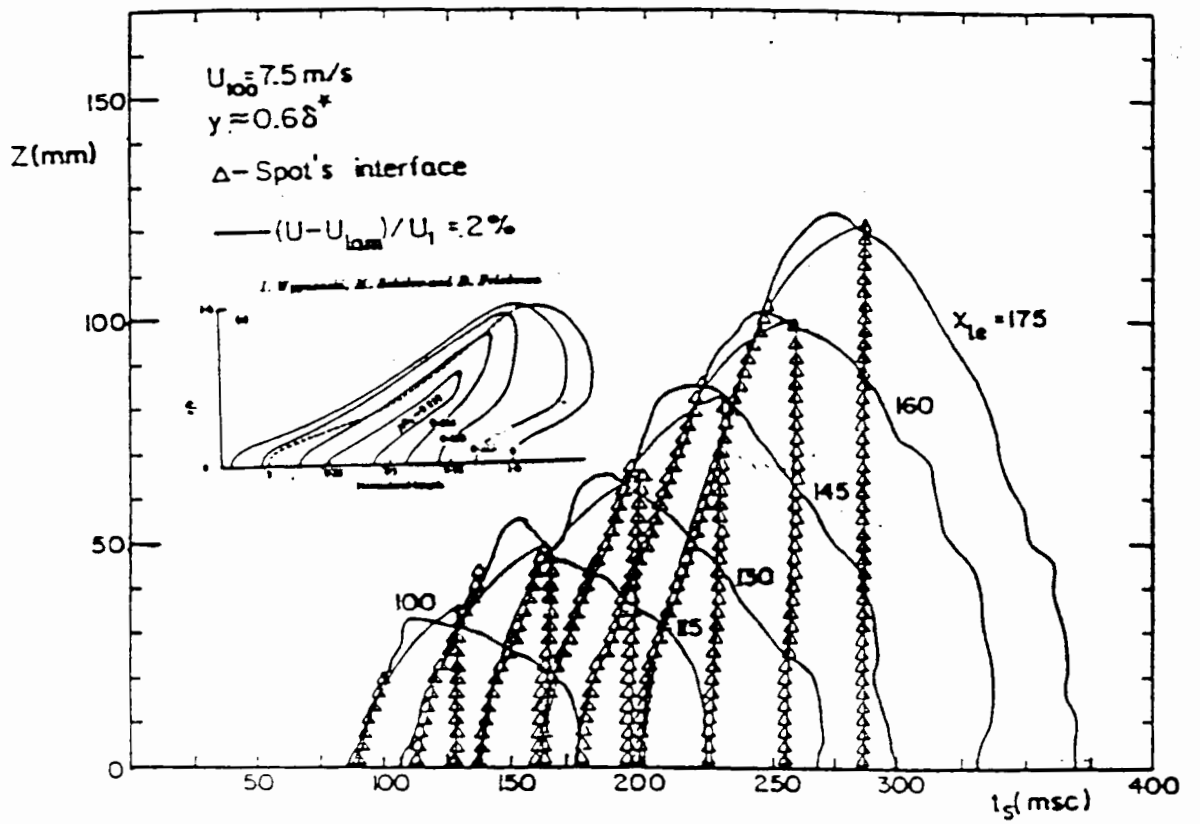
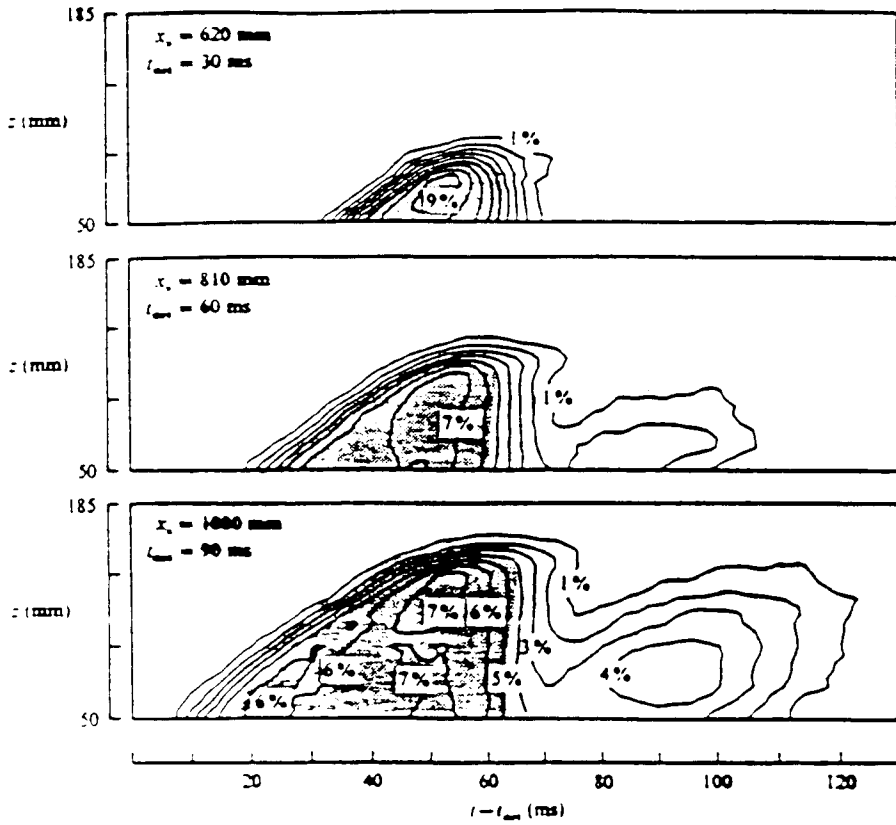


Fig. 6.7.5 Instantaneous streamwise and spanwise velocity profiles on turbule
 laminar interface, in compare with laminar profiles. $\frac{h}{X_0} = 0.149$,
 $\frac{h}{X_0} = 1.9$ mm

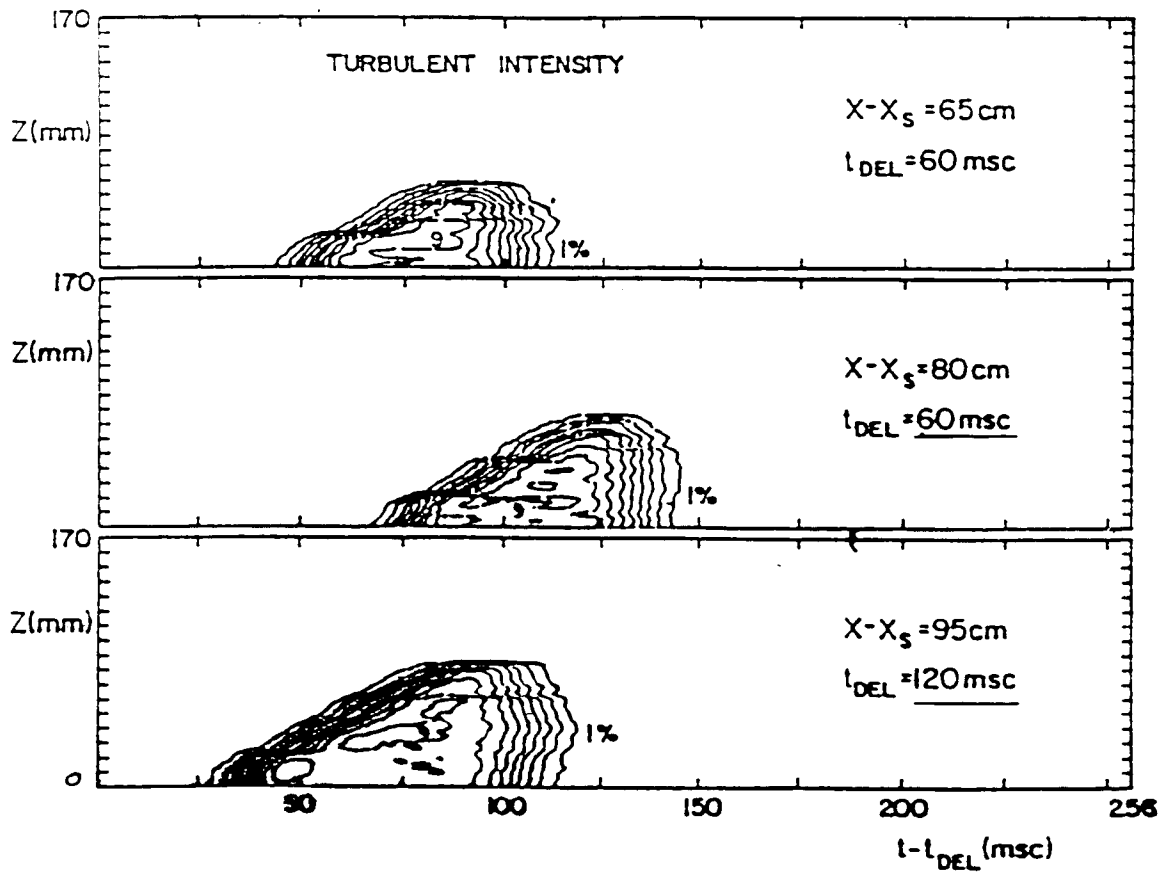




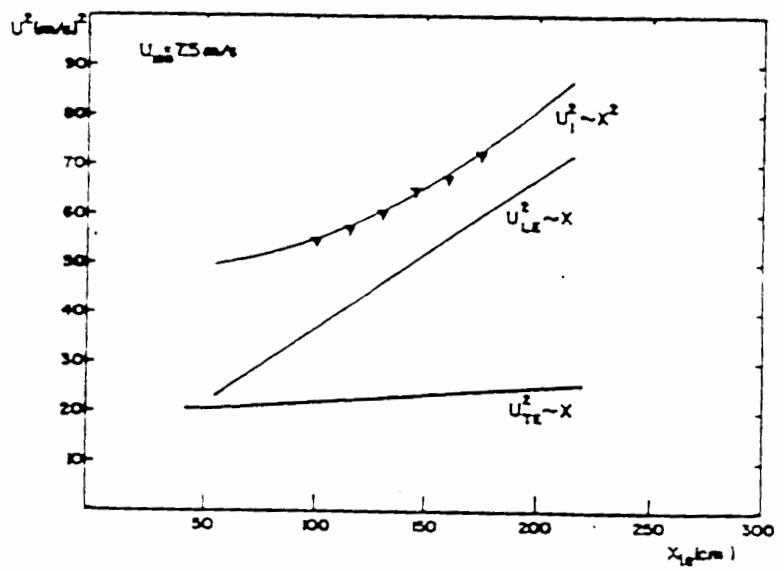
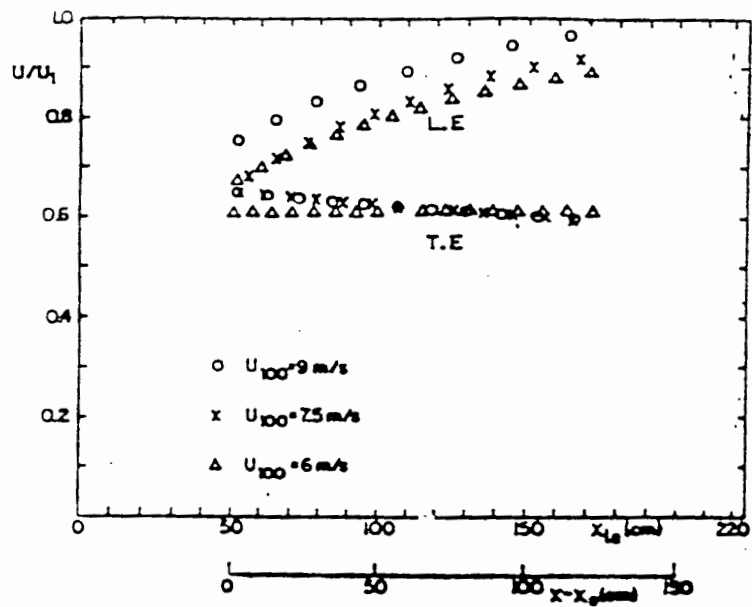


$\beta = 0$

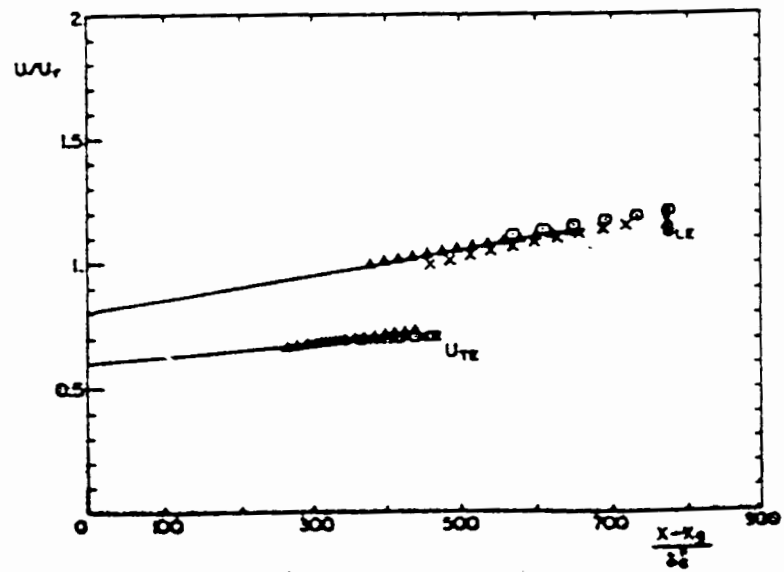
FIGURE 6. Spanwise distribution of 'true' r.m.s. contours at the same locations as shown in figure 3. Contour levels are 1%–10% at intervals of 1%. The shaded area indicates $\gamma > 50\%$.



$\beta = 1.0$



$$\frac{j_{INT.}}{U_r} = \frac{\rho \int \beta}{-j; Res^* j} \frac{x-}{-}$$



A

