

Low-Earth-Orbit and Geosynchronous-Earth-Orbit Testing of 80Ah Batteries Under Real-time Profiles

Robert J. Staniewicz, John Willson and J. Douglas Briscoe

Saft America

Cockeysville, MD 21030

and

Gopalakrishna M. Rao

NASA/Goddard Space Flight Center

Greenbelt, MD 20771

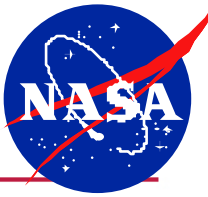

Outline

- **Battery Description**
- **Test Description**
- **Low-Earth-Orbit (LEO) Testing**
- **Geosynchronous-Earth-Orbit (GEO) Testing**
- **Conclusions**

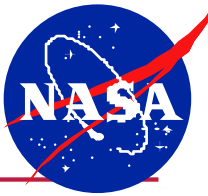

Battery Description: General

- **2P8S Design – The LEO and GEO batteries are identical, two cells in parallel, eight cells in series.**
- **Cells are cylindrical HE54245 cells**

| SAFT cell specification | Cell average for batteries |
|------------------------------------|-----------------------------------|
| C/2 capacity > 44Ah@4.1V | 50.9Ah |
| C/2 energy >160Wh@4.1V | 182Wh |
| mass <1150g | 1135g |
| impedance <1.8mΩ | 1.4mΩ |
| self-discharge <2mV/day | 0.23mV/day |

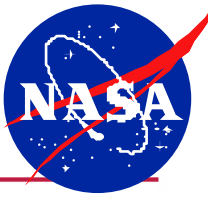

Battery Description: Design

- **Battery design weight was very conservative by intent to insure uniform temperature during cycling and was not optimized for lower specific energy.**
- **Battery electrical components are space or commercial equivalents that could be directly replaced with space qualified parts.**
- **Cells are fixed in an aluminum chassis and are electrically isolated from the chassis by one layer of kapton tape and one layer of Chootherm 1674.**
- **The batteries were tested with one layer of the Chootherm 1674 between the Aluminum battery chassis and the chill plate.**

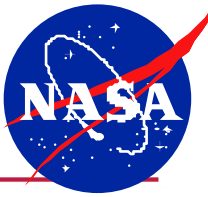

Battery Description: 16-Cell Module

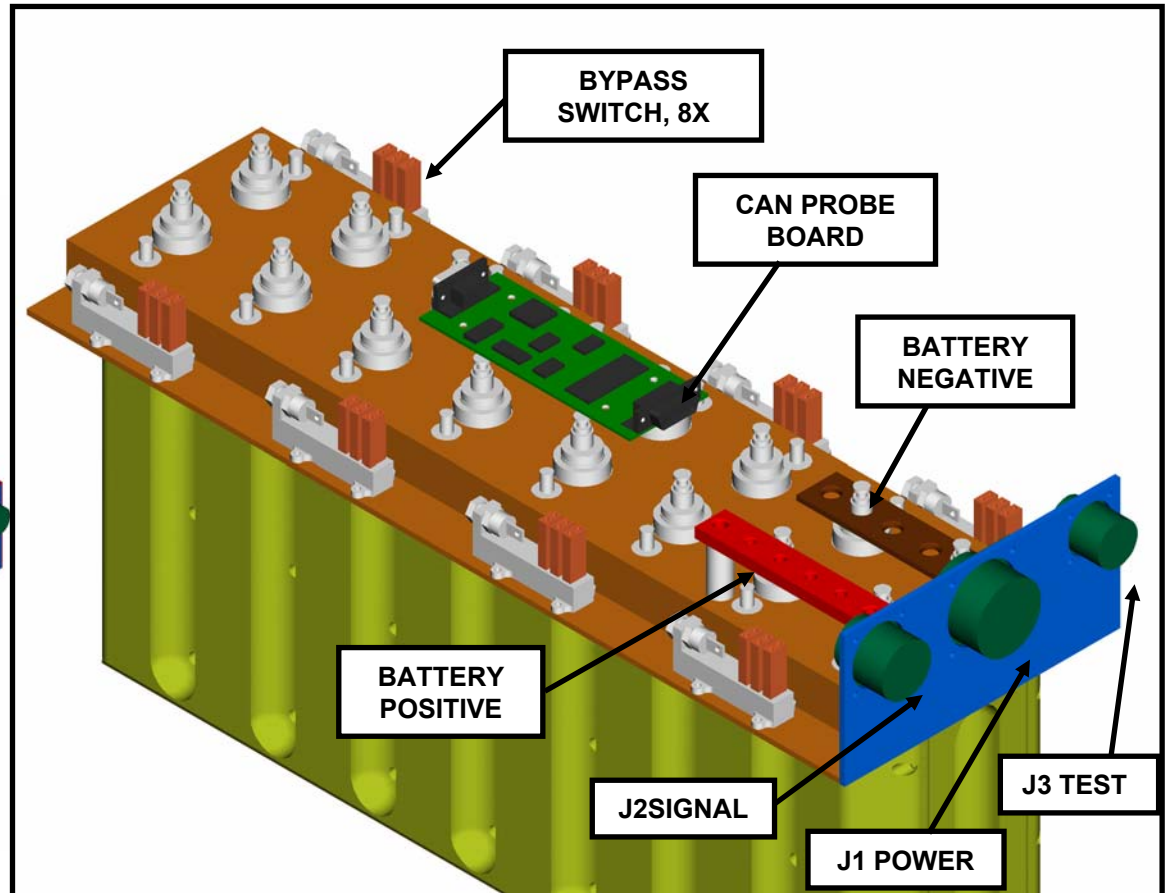
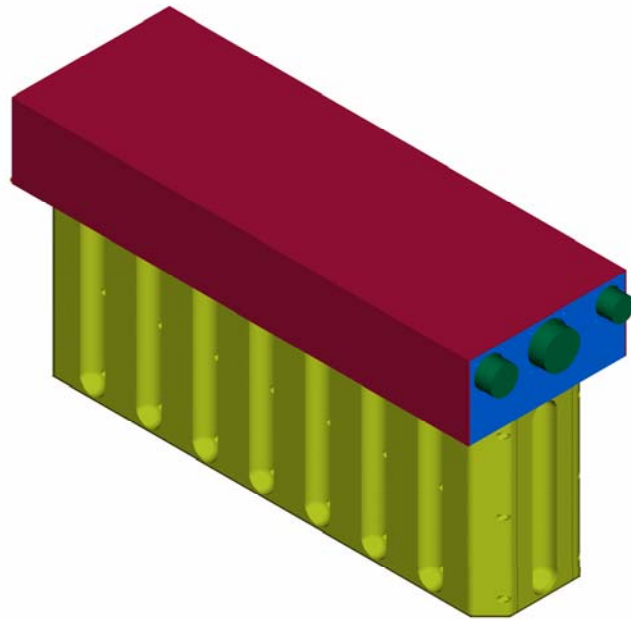

Battery Description: Batteries on Cold Plate

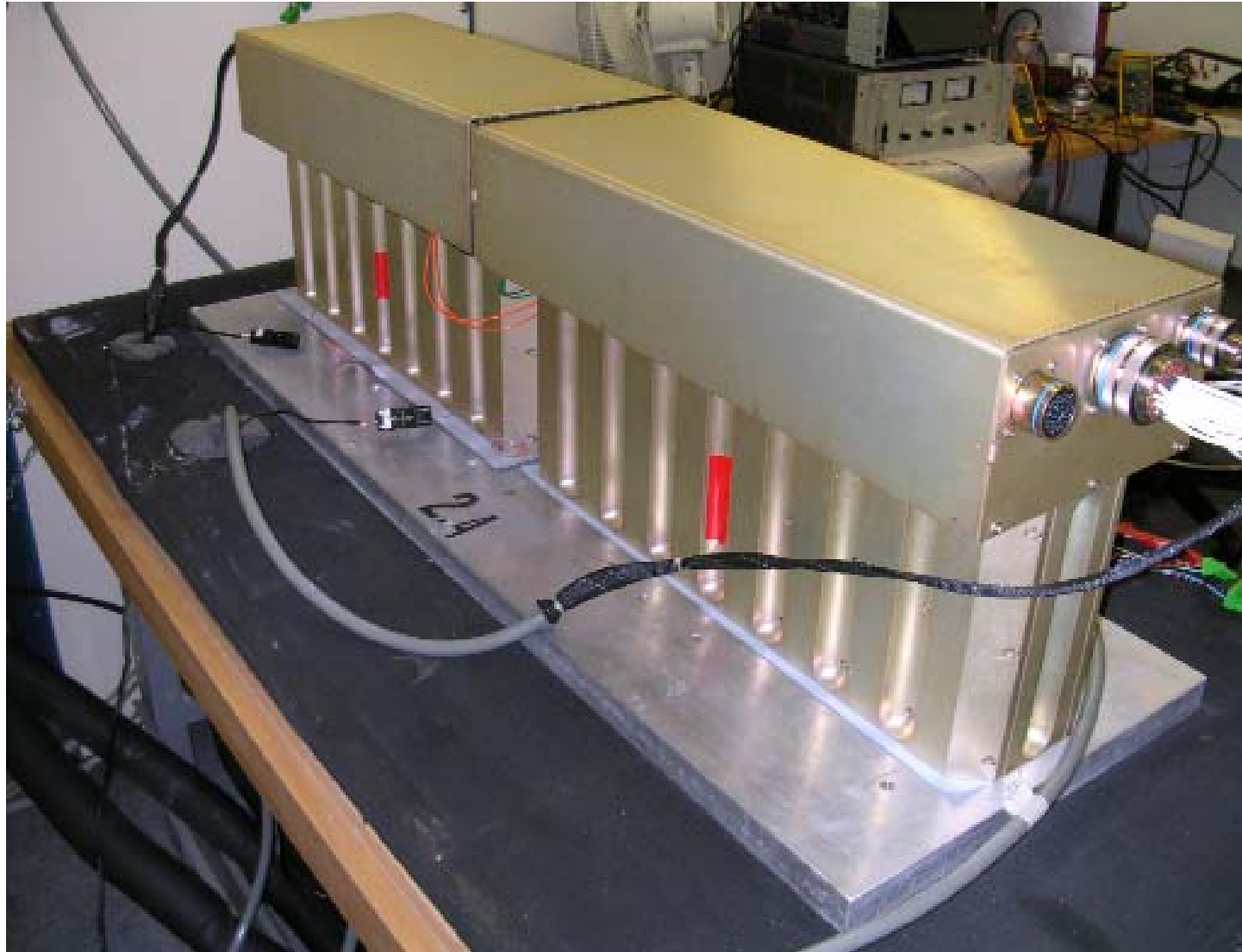

Battery Description: Close-up view

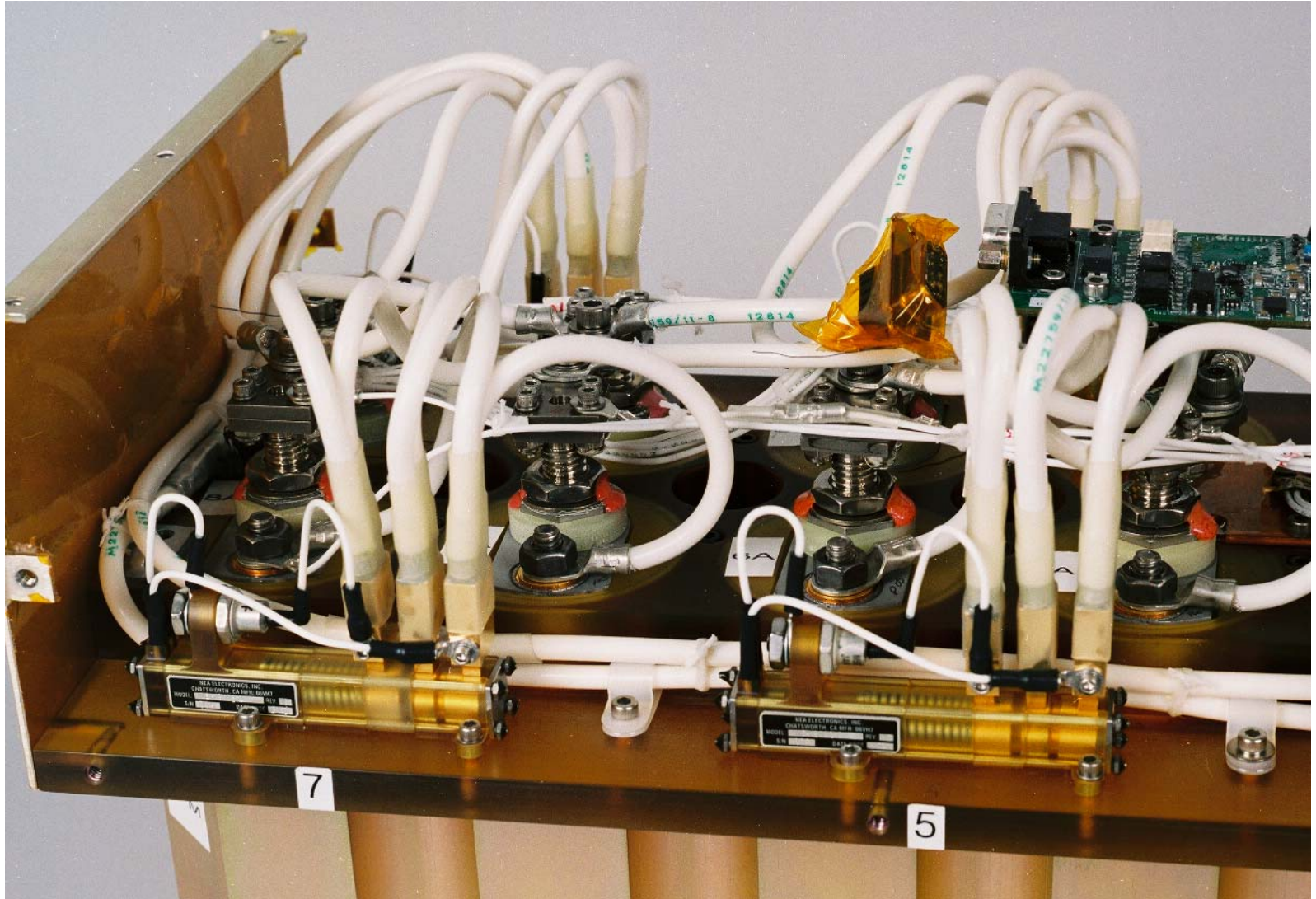

Test Description: Set-up

- **Circulating chiller at far right**
- **A Sarcophagus or cover enclosing two test batteries and chill plate**
- **Yellow relay boxes controlling Computer Assisted Network (CAN) probe electronics for upper and lower voltage safety limits**



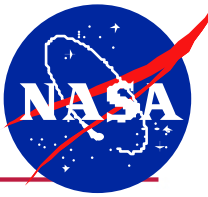

Test Description: Schematic

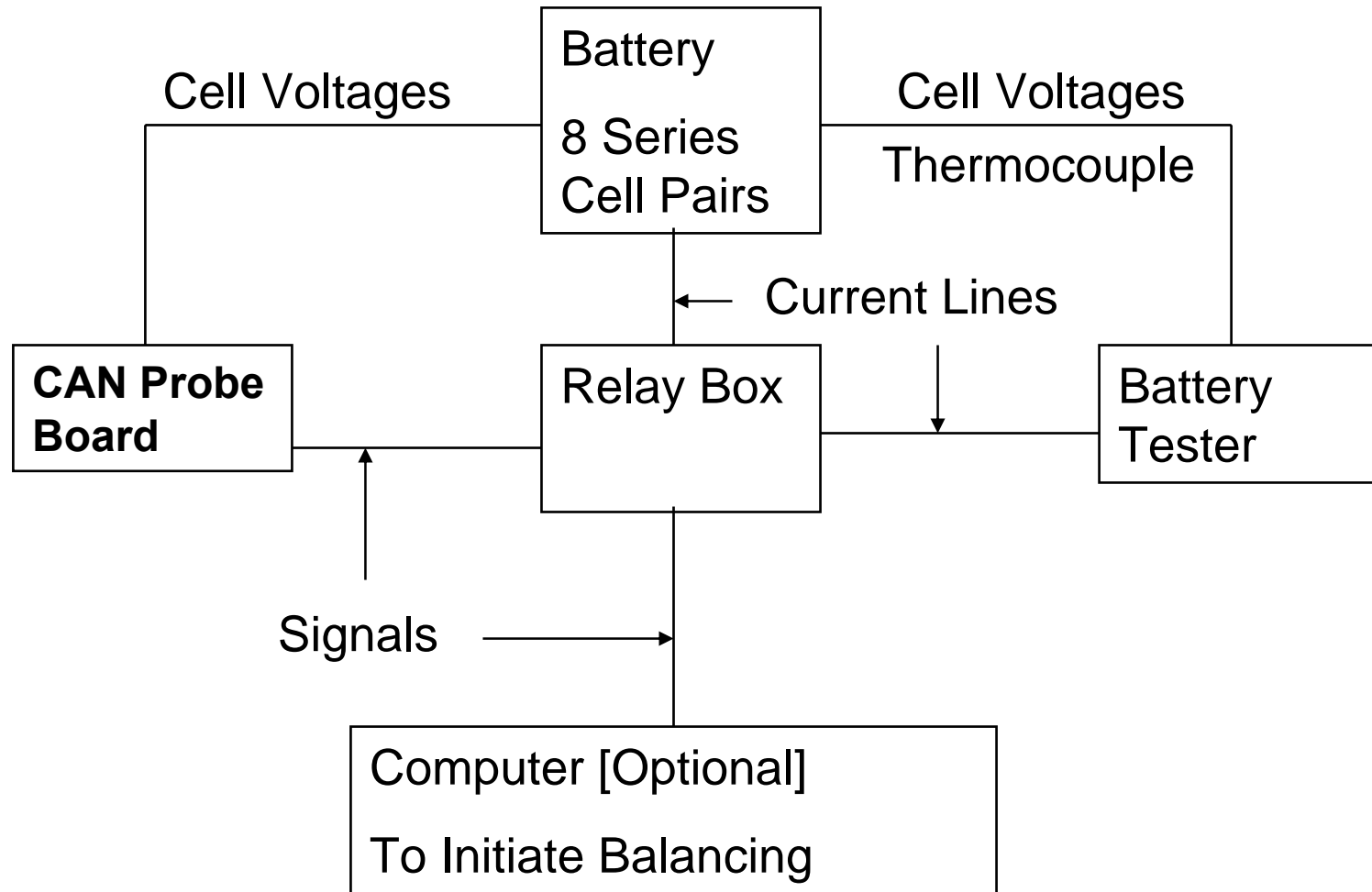

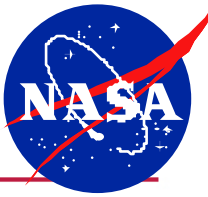

Test Description – Safety Limits

- **Firing Circuits test equipment upper limits**

- >4.2 V/cell
- <2.4 V/cell
- >33.6 V/battery
- <19.2 V/battery
- >35 °C
- <-5 °C

- **CAN probe electronics**

- >4.3 V/cell
- <3.3 V/cell

- **Sensor diode switches**

- >4.45 V to 4.75 V/cell

First

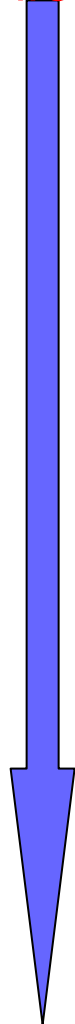

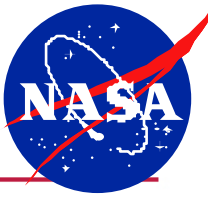

■ Test Description - Bypass Switch

- **The relay switches are activated by Zener diodes that are electrically in parallel with the cell. The diodes start passing current above 4.45V and this current, in turn, triggers the single-pole double throw switch to open.**
- **This autonomous bypass switch was added as the third level of protection against the condition of overcharge. The switch is made before break to insure battery continuity.**

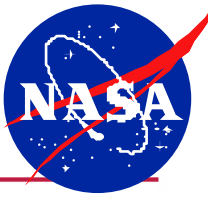

LEO Testing

- **Beginning-of-Life (BOL) capacity**
 - 20°C 98.15Ah @40A discharge from End-of-Charge Voltage (EOCV) of 32.8V to 24.0V
 - 0°C 88.93Ah @40A discharge from EOCV of 32.8V to 24.0V
- **Battery was rated as 80Ah at EOCV 32.8V and the testing was based on this capacity, thus 33% Depth-of-Discharge (DOD) represented 26.4Ah discharge.**
- **Test started at 20°C, EOCV of 31.6V**
 - 44A discharge for 36 minutes
 - Charge at roughly 22A to a voltage clamp of 31.6V followed by tapered current charge, total time of 55.5 minutes.
 - Cell balancing circuits are active.

LEO Testing:

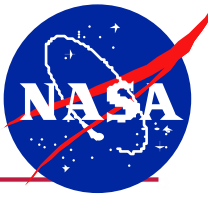

Battery End-of-Discharge Voltage (EODV) with Cycling

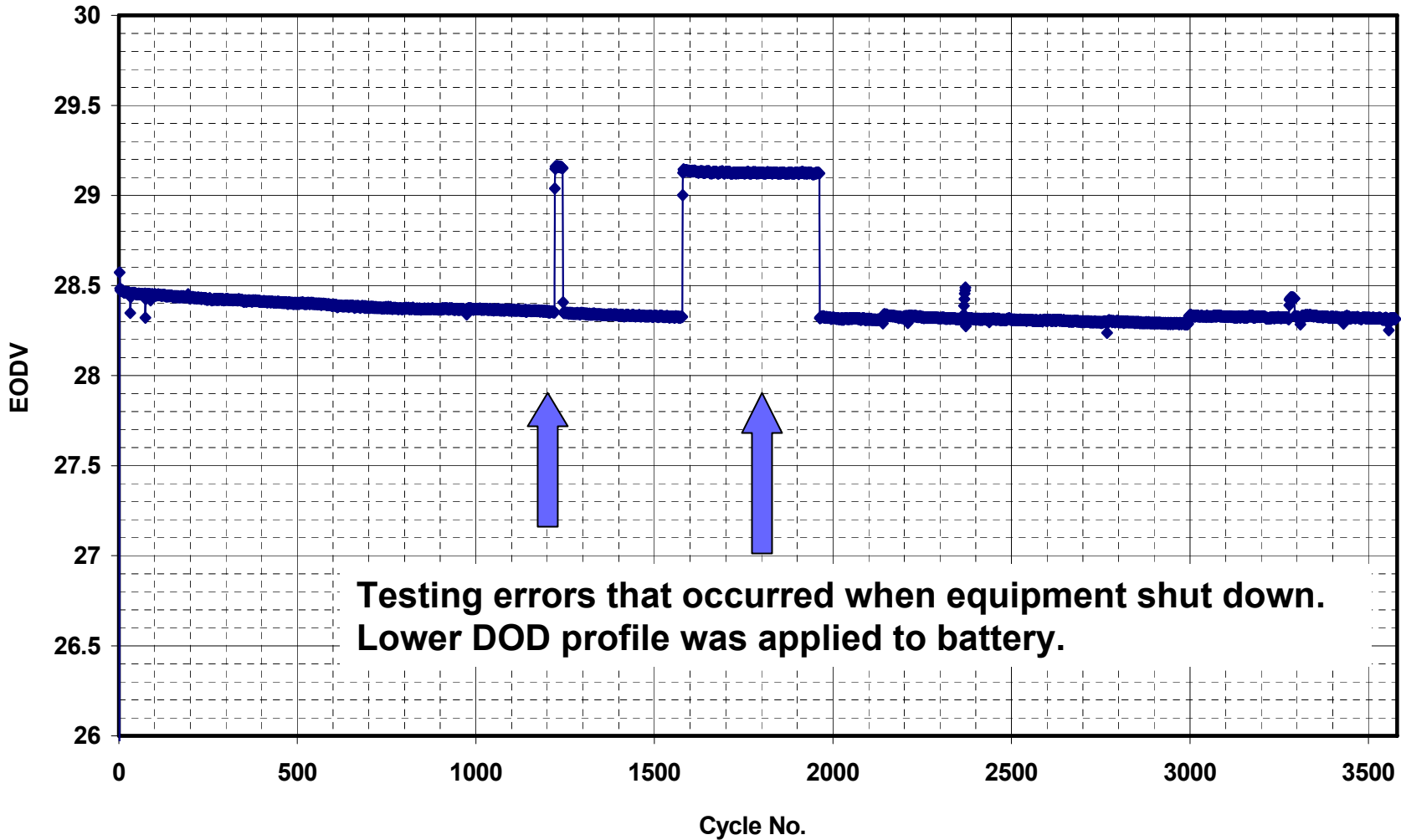

LEO Testing: Cell EODV with Cycling

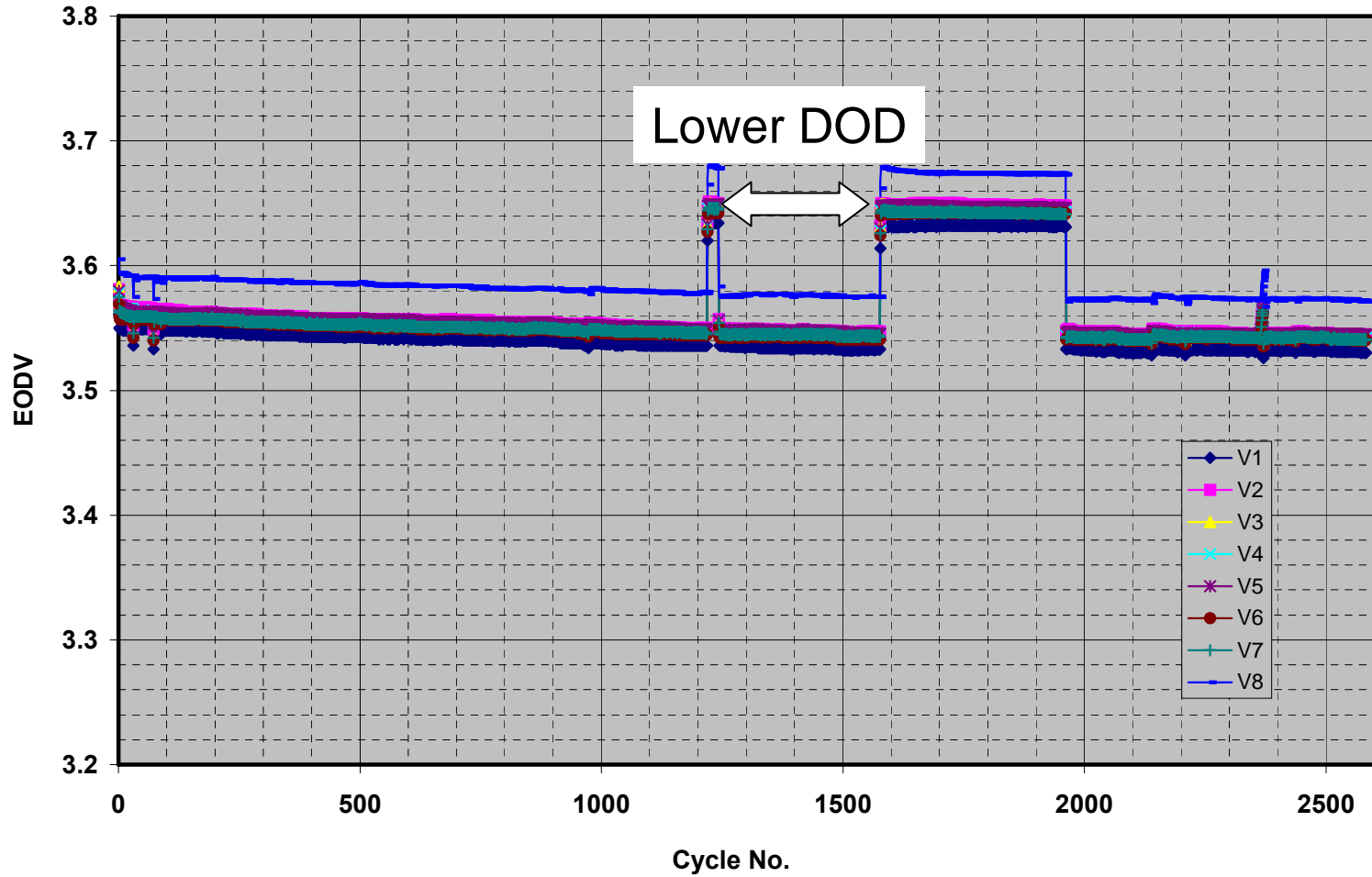
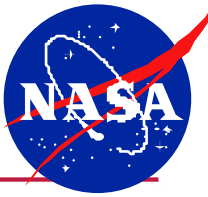

LEO Testing: EOC Current with Cycling

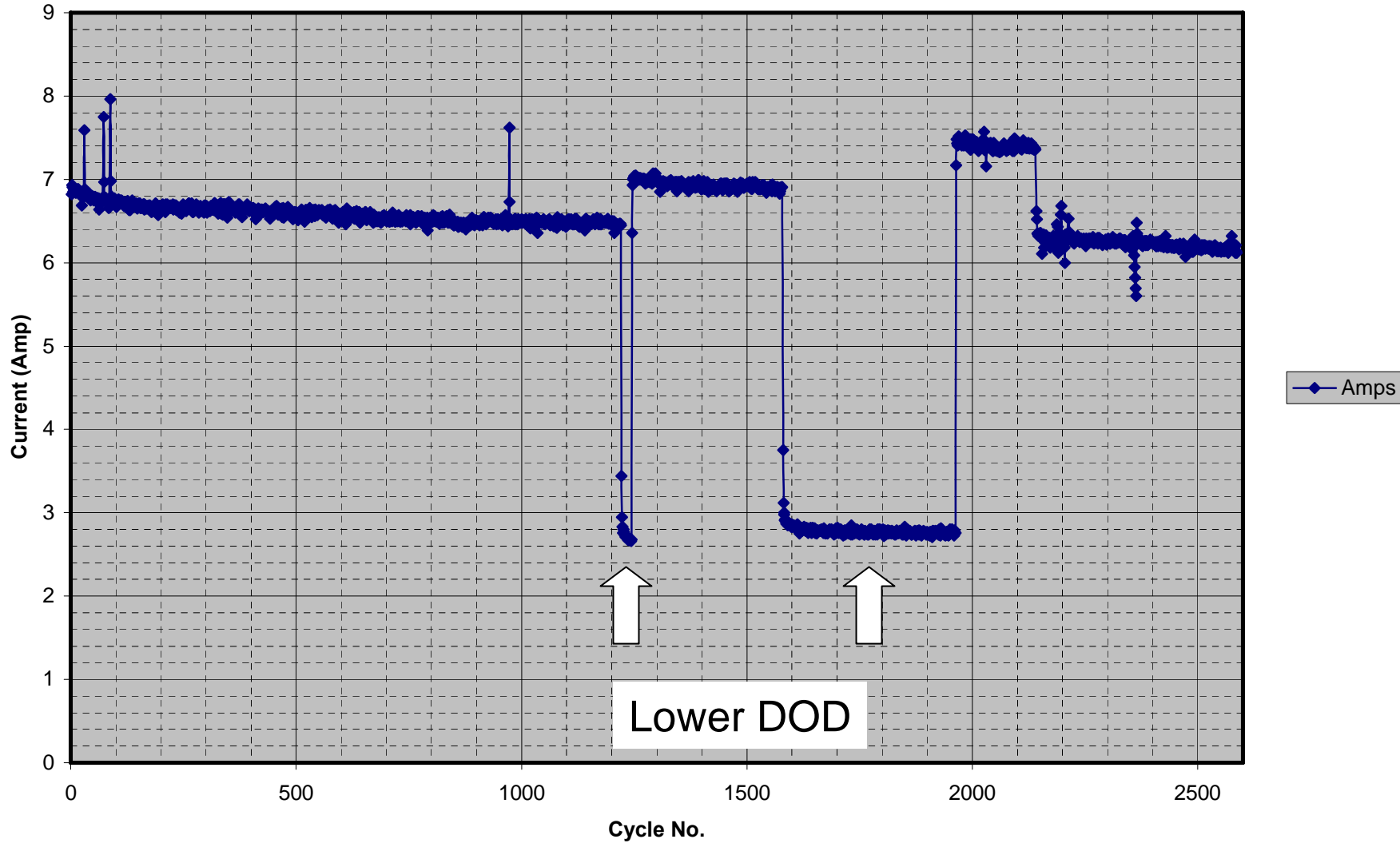
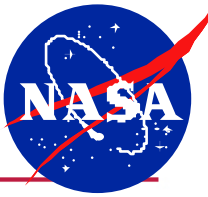

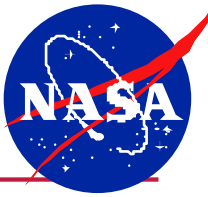

GEO Testing

- **BOL capacity checks**

- 20°C 98.29Ah @40A discharge from EOCV of 32.8V to 24.0V
- 0°C 89.5Ah @40A discharge from EOCV of 32.8V to 24.0V

- **Battery was rated as 80Ah at EOCV 32.8V and the maximum discharge during the 42 day shadow period was 72 minutes @48A or 57.6Ah (72%DOD). Sunlight periods are 140 days in length with cells clamped at 30.8V.**

- **Test started from EOCV of 32.8V**

- Charge is at C/20 or 4A to a voltage clamp of 32.8V followed by a tapered current charge. Charging time equals 24 hours minus the eclipse duration.
- Balancing circuits are installed but inactive.

GEO Testing:

Battery EODV Trend During 1st Shadow Period

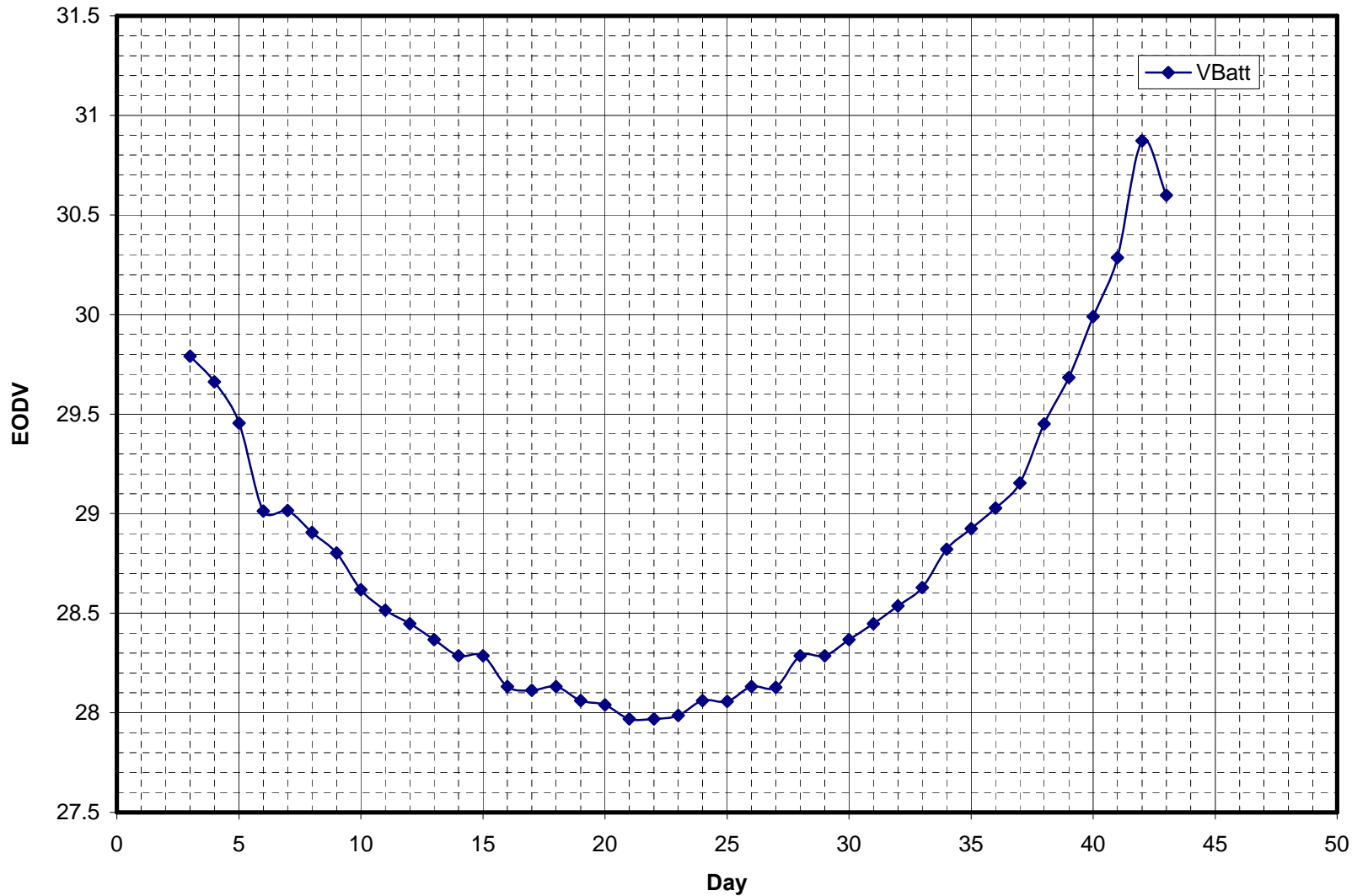
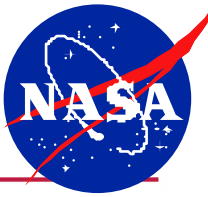

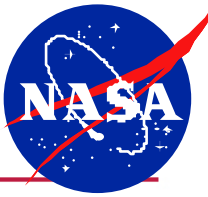

GEO Testing: Cell EODV Trend During 1st Shadow Period

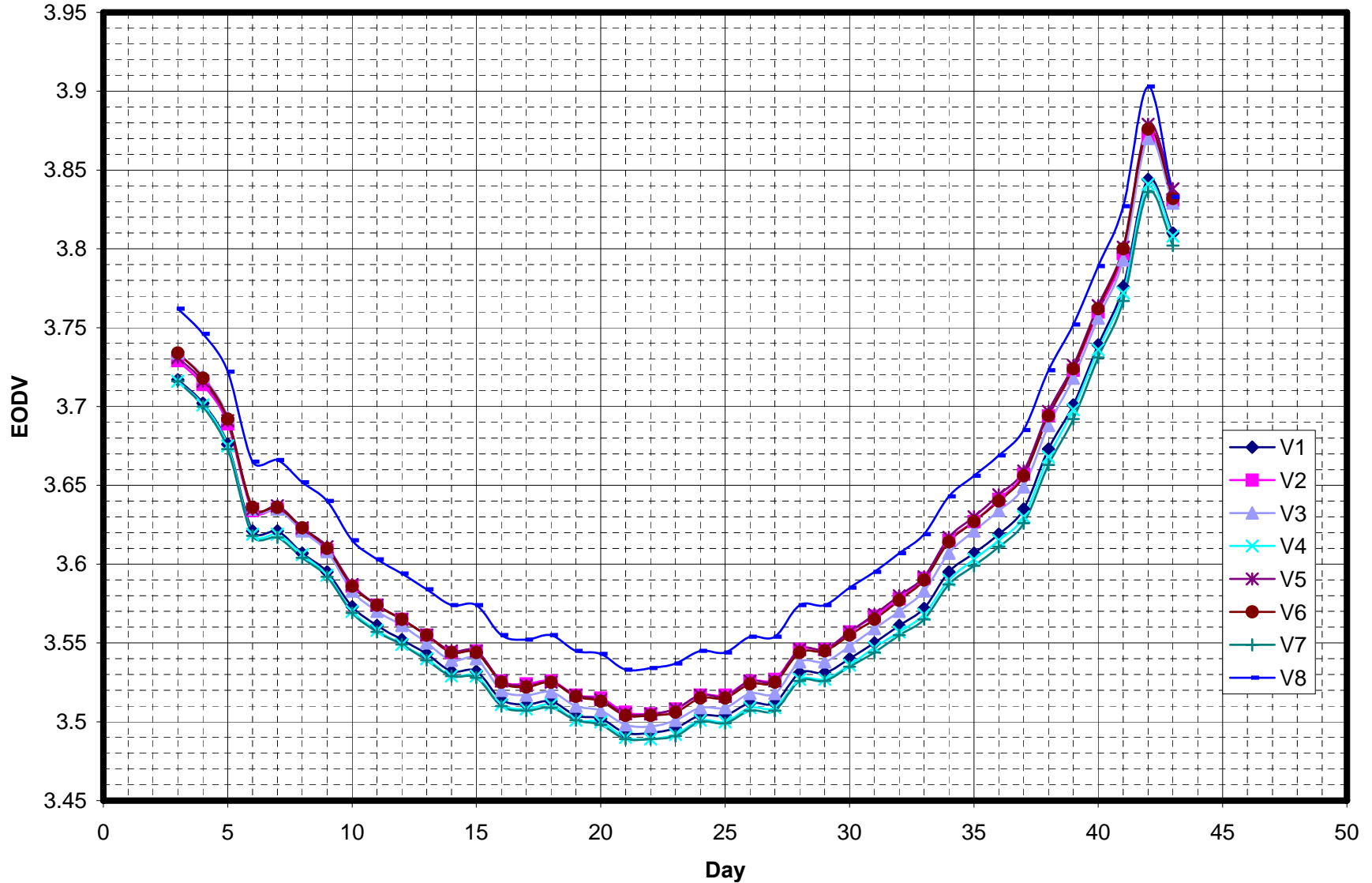

GEO Testing:

EODV Trend During 2nd Shadow Period

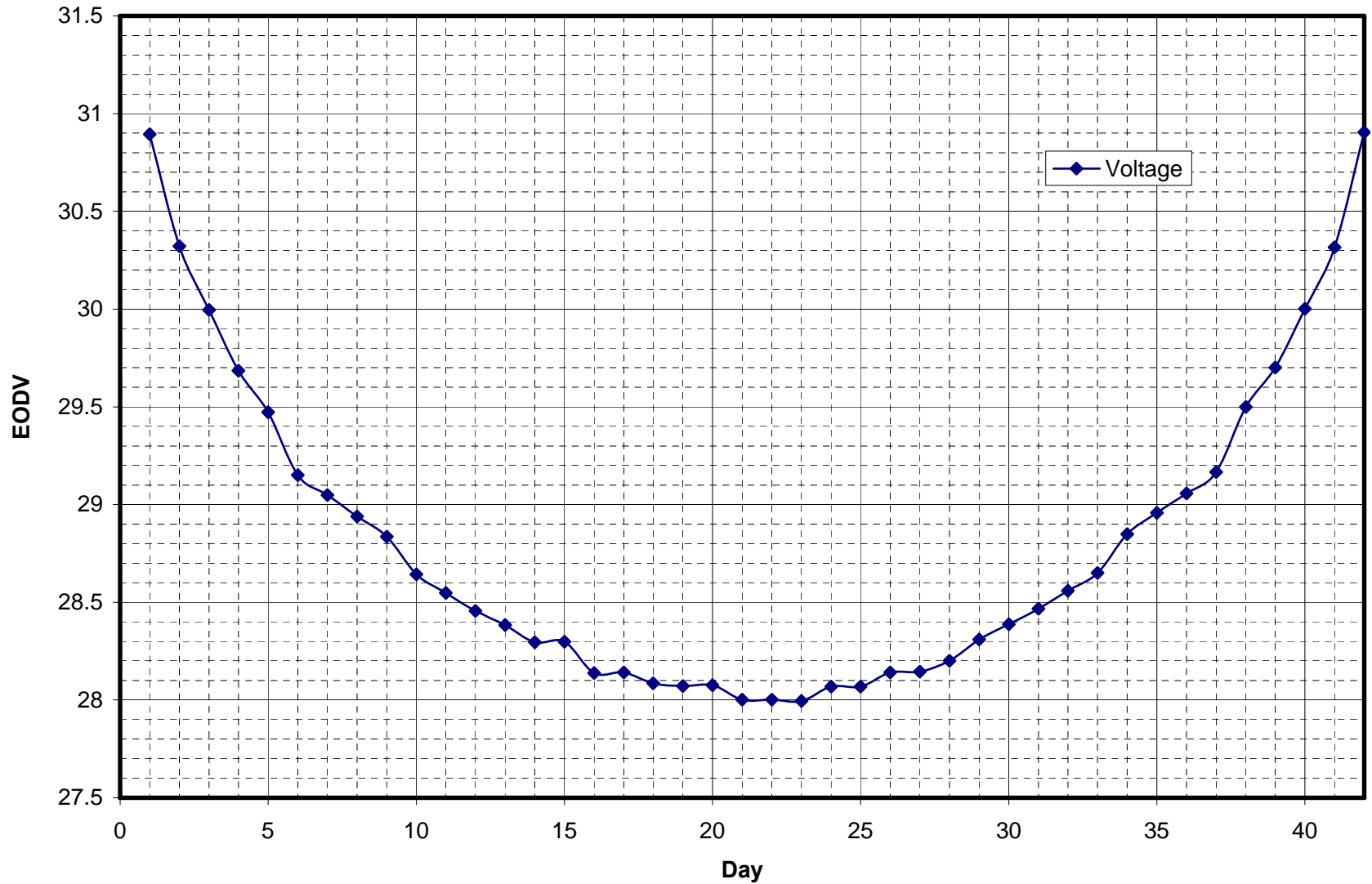
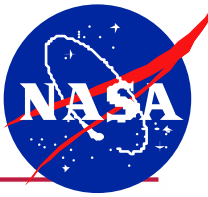

GEO Testing:

Cell EODV Trend During 2nd Shadow Period

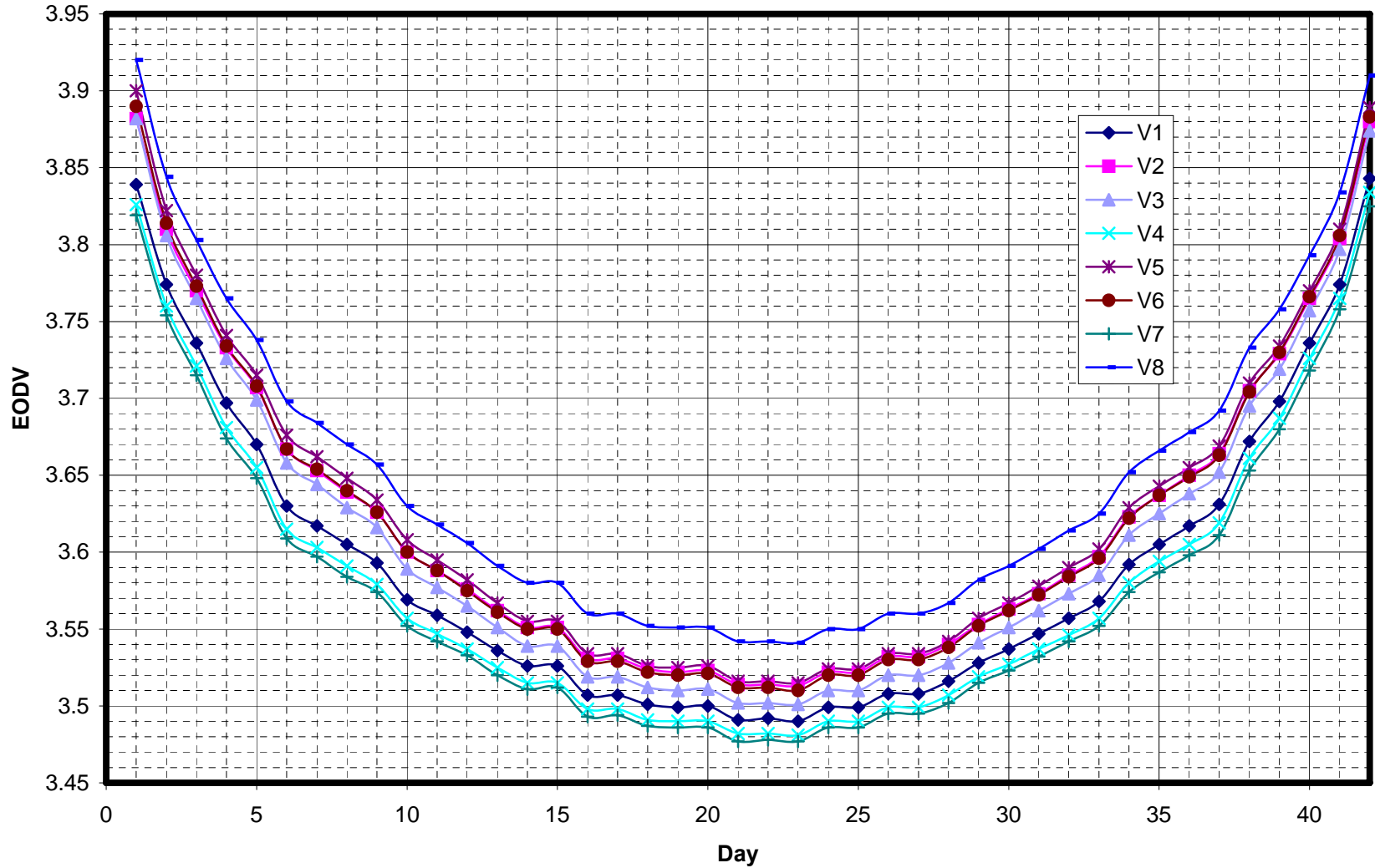
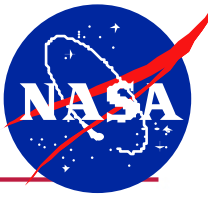

GEO Testing:

Temperature Trend During 2nd Shadow Period

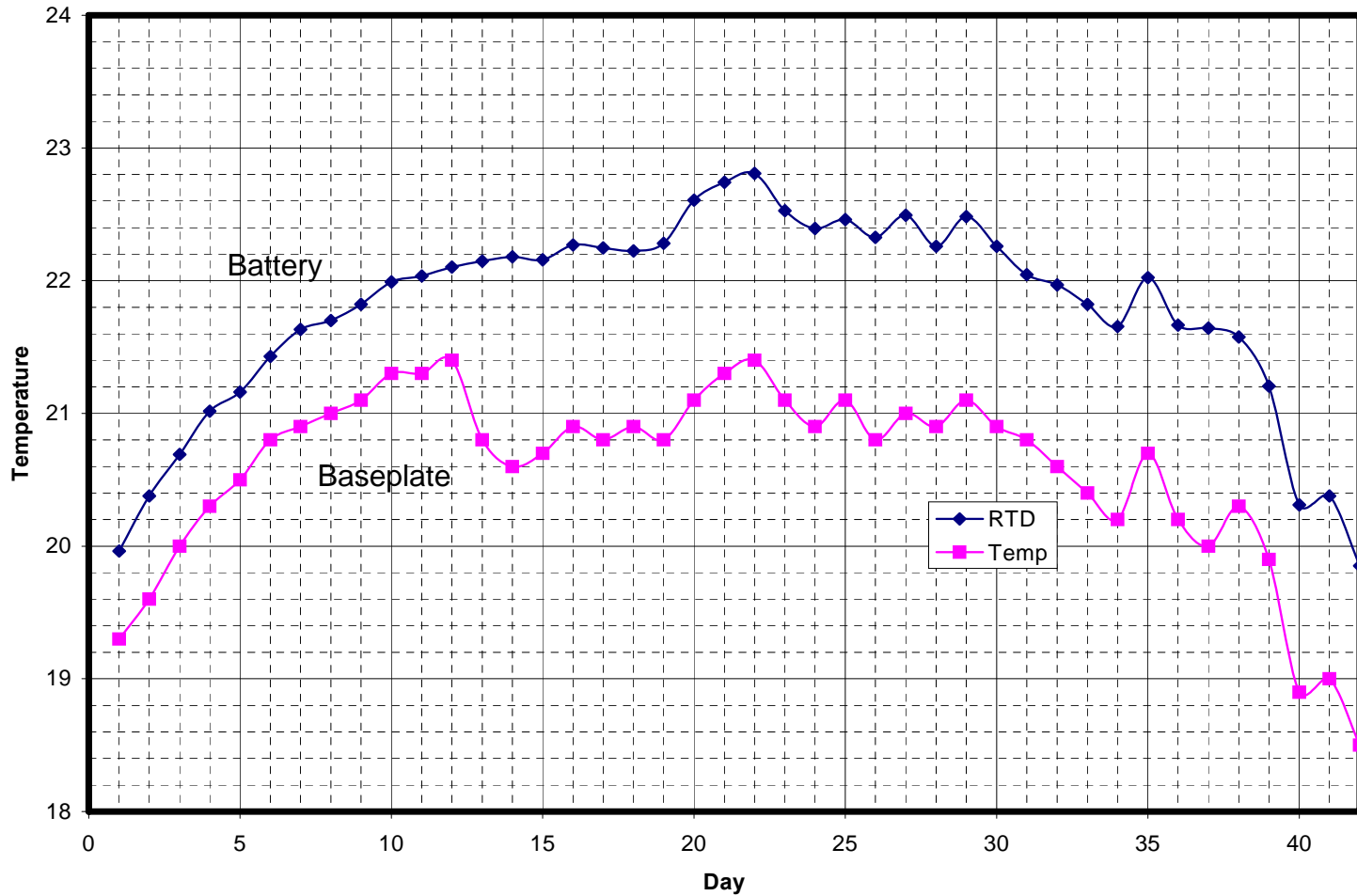
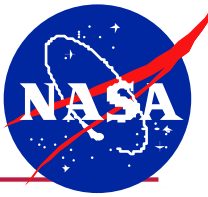

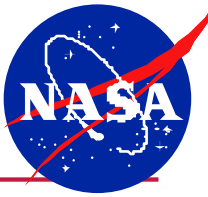

Conclusions

- **To date the LEO battery has completed 5000 nominal cycles**
 - The EODV is trending down by 50mV per 1000 cycles.
- **To date the GEO battery has completed 2 nominal shadow periods and currently in sunlight period**
- **Batteries' testing after one year looks encouraging for aerospace application.**
 - There are no discrepancies between the current data and extensive testing conducted at Saft over the past 5 years.