

ARES V: SHIFTING THE PAYLOAD DESIGN PARADIGM

Phil Sumrall, Planning Manager, Ares Projects
Steve Creech, Ares V Integration Manager, Ares Projects
NASA Marshall Space Flight Center, AL

Charles E. Cockrell, Jr.
Associate Director, Systems Engineering Directorate
NASA Langley Research Center, VA

ABSTRACT

NASA is designing the Ares V heavy-lift cargo launch vehicle to send more crew and cargo to more places on the lunar surface than the 1960s-era Saturn V and to provide ongoing support for a permanent lunar outpost. This uncrewed cargo vehicle is designed to operate together with the Ares I crew vehicle (Figure 1). In addition to this role, however, its unmatched mass and volume capability represent a national asset for exploration, science, and commerce. The Ares V also enables or significantly enhances a large class of space missions not thought possible by scientists and engineers since the Saturn V program ended over 30 years ago. Compared to current systems, it will offer approximately five times the mass and volume to most orbits and locations. This should allow prospective mission planners to build robust payloads with margins that are three to five times the industry norm. The space inside the planned payload shroud has enough usable volume to launch the volumetric equivalent of approximately 10 Apollo Lunar Modules or approximately five equivalent Hubble Space Telescopes. This mass and volume capability to low-Earth orbit (LEO) enables a host of new scientific and observation platforms, such as telescopes, satellites, planetary and solar missions, as well as being able to provide the lift for future large in-space infrastructure missions, such as space based solar power and mining, Earth asteroid defense, propellant depots, etc. In addition, payload designers may also have the option of simplifying their designs or employing Ares V's payload as "dumb mass" to reduce technical and operational risk. The Ares V team is engaging the potential payload community now, two to three years before System Requirements Review (SRR), in order to better understand the additional requirements from the payload community that could be accommodated in the Ares V design in its conceptual phase. This paper will discuss the Ares V reference mission and capability, as well as its potential to perform other missions in the future.



Figure 1: The Ares V cargo launch vehicle, shown during ascent, will provide the heavy lift capability to carry exploration beyond low Earth orbit. (NASA artist's concept)

Introduction

Ares V represents the capability to again take human exploration beyond low-Earth orbit (LEO). It is one of the major architectural components of NASA's Constellation Program. Constellation evolved from a series of events set in motion by the Space Shuttle *Columbia* accident and followed by the subsequent investigation and recommendations, the Bush administration's Vision for Space Exploration (VSE), and NASA's Exploration Systems Architecture Study (ESAS).

NASA's current mission, as set forth in National Space Policy, is to retire the Shuttle, develop its replacement, complete the International Space Station (ISS), and resume human exploration beyond LEO beginning with a permanent presence on the Moon.

As part of the Constellation architecture, Ares V is designed to launch the lunar lander into LEO. There, the Ares V upper stage, called the Earth departure stage (EDS), will be joined by the Orion crew spacecraft, launched on the Ares I launch vehicle. After crew and ground control checkouts, the EDS will ignite to send the combined Orion/lander stack to the Moon.

The Ares V design and capabilities are shaped by several goals that emerged after the loss of *Columbia*. The Columbia Accident Investigation Board (CAIB) recommended separating crew from cargo, leading to the dual launch vehicles. Crewmembers were put on the smaller, simpler Ares I, while cargo was assigned to the larger, more complex Ares V. During ESAS, NASA sought to minimize technical and programmatic risk by drawing where feasible on existing hardware, infrastructure and experience. The agency also sought to minimize development and operations costs by sharing components where possible between the Ares vehicles. As a result, the Ares I first stage and Ares V boosters are derived from the Shuttle boosters. The J-2X upper stage engine used by both Ares I and Ares V is an evolved version of the Saturn-era J-2 upper stage engine. The RS-68B engine for the Ares V core stage is an improved version of the engine now used on the Delta IV. The National Research Council noted in a report titled, *Launching Science: Science Opportunities Provided by NASA's Constellation System*, that, "Given the use of hardware and systems being developed for Ares I, the development risks of the Ares V are significantly reduced."¹ That heritage and commonality are illustrated in Figure 2.

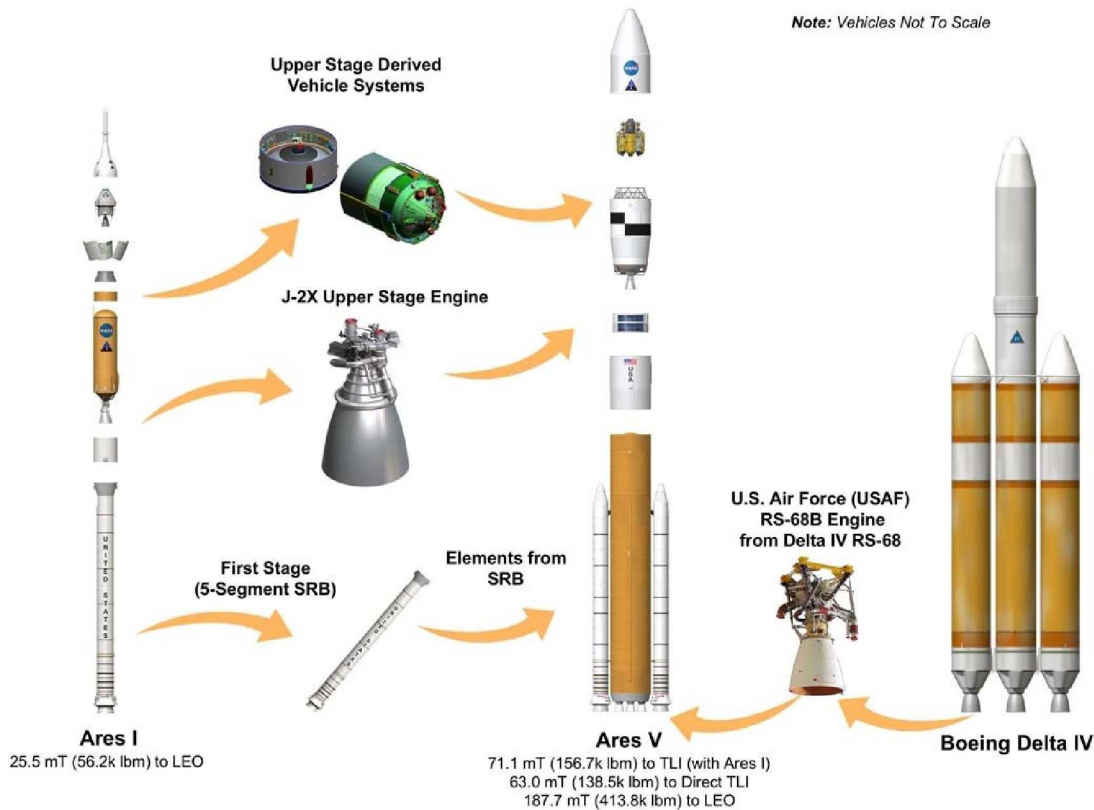

Fig. 2: Heritage hardware and commonality between Ares vehicles remains a key goal.

Current Point of Departure

More than 1,700 variants of Ares V were studied leading up to the current reference configuration. Various combinations of stages, boosters, engines, materials, lengths, diameters, etc. were traded for performance, cost, technology readiness, and other factors. The Constellation Program approved the current configuration during the Lunar Capabilities Concept Review (LCCR) in June 2008. This configuration serves as the basis for design trades since the LCCR.

The current reference configuration stands 381 feet (116 meters (m)) tall with a gross lift-off mass (GLOM) of 8.1 million pounds (3,704.5 metric tons (mT)). Its first stage can generate more than 11 million pounds of sea-level liftoff thrust. It can send 413,800 pounds (187.7 mT) to LEO, 138,500 pounds (63 mT) direct to the Moon, or 156,700 pounds (71.1 mT) to the Moon in its dual-launch architecture mode with Ares I.

For historical perspective, the Saturn V was 364 feet (111 m) tall, with a gross liftoff mass of 6.5 million pounds (2,948.4 mT), and could carry 99,000 pounds (44.9 mT) to TLI or 262,000 pounds (118.8 mT) to LEO. In conjunction with Ares I, Ares V can launch 58 percent more payload to TLI than the Saturn V.

As shown in the expanded vehicle overview (Figure 3), the Ares V core stage is powered by six commercial liquid hydrogen/liquid oxygen (LH₂/LOX) RS-68B engines that will undergo NASA-specific upgrades to decrease free hydrogen around the launch pad, decrease the use of increasingly scarce helium, and increase the life of the nozzle for the longer Ares V operating times. Flanking the core stage are two 5.5-segment solid rocket boosters (SRBs) based on the 5-segment Ares I First Stage. The boosters use the same Polybutadiene Acrylonitrile (PBAN) propellant as the Ares I and Space Shuttle. Atop the Core Stage is the Earth departure stage (EDS), powered by a single J-2X upper stage engine based on the Ares I upper stage engine.

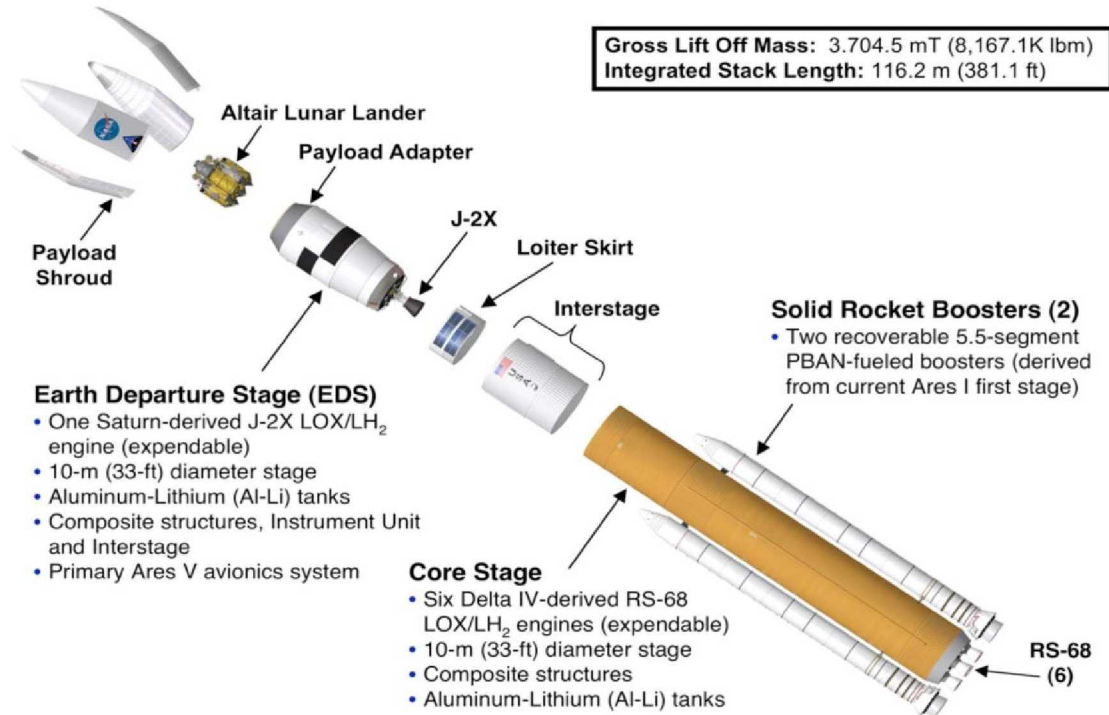

Figure 3: Expanded view of the current Ares V reference configuration.

Exploring Other Uses for Ares V

Ares V is the largest launch vehicle in history. It has unmatched payload mass and volume capability that will make it an asset, not just for human exploration, but also for science, national defense, and commercial use represent a global asset for exploration, science, and commerce. The Ares V also enables or significantly enhances a large class of space missions not thought possible by scientists and engineers since the Saturn V program ended over 30 years ago. Compared to current systems, it will offer approximately five times the mass and volume to most orbits and locations. This should allow prospective mission planners to build robust payloads with margins that are three to five times the industry norm. The space inside the planned payload shroud has enough usable volume to launch the volumetric equivalent of approximately 10 Apollo Lunar Excursion Modules or approximately five equivalent Hubble Space Telescopes. This mass and volume capability to Low Earth Orbit enables a host of new scientific and observation platforms, such as

telescopes, satellites, planetary and solar missions, as well as being able to provide the lift for future large in-space infrastructure missions, such as space-based solar power and mining, Earth asteroid defense, propellant depots, etc. Since Spring 2008, the assessment of astronomy payload requirements has indicated that Ares V has the potential to support a range of payloads and missions. Some of these missions were impossible in the absence of Ares V's capabilities.

Preliminary Payload Analyses

The availability of Ares V will change substantially the opportunities for astronomy and solar system science. Unique aspects of the Ares V include its dramatically larger payload capability (mass and volume) over existing launch vehicles. The following analysis was based on pre-LCCR configuration (LV 51.00.39). Figure 4 shows Ares V payload mass (metric tons) to LEO as a function of orbit altitude and inclination angle. The higher the orbit or greater the inclination angle, the less mass can be launched.

Ares V Payload vs. Altitude & Inclination (LV 51.00.39)

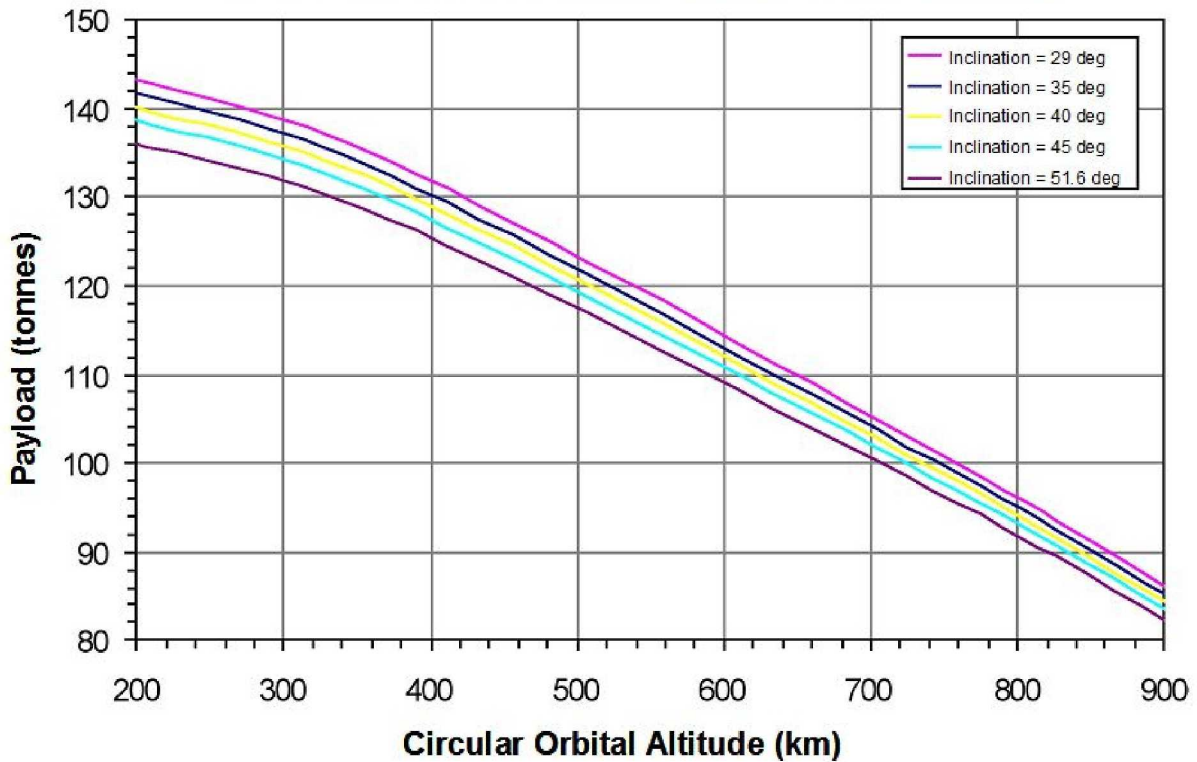

Figure 4: Payload mass vs. altitude and inclination for the 51.00.39 Ares V configuration.

Collaborative design/architecture inputs, exchanges, and analyses have already begun between scientists and payload developers. A 2008 study by a National Research Council (NRC) panel, as well as analyses presented by astronomers and planetary scientists at two weekend conferences in 2008, support the position that Ares V has benefit to a broad range of planetary and astronomy missions. This early dialogue with Ares V engineers is permitting the greatest opportunity for payload/transportation/mission synergy and the least financial impact to Ares V development. In addition, independent analyses suggest that Ares V has the opportunity to enable more cost-effective mission design.

Figure 5, again based on pre-LCCR configuration (LV 51.00.39), shows potential capability for science missions expressed as C_3 energy. C_3 is a measure of energy required for an interplanetary mission that requires achieving an excess orbital velocity over an escape velocity required for additional orbital maneuvers. Ares V, alone or with a Centaur Upper Stage, can accelerate larger payloads to large C_3 energy values, thus enabling and enhancing deep space planetary missions. For example, preliminary performance assessments indicate that an Ares V could deliver a Mars sample return mission payload approximately five times greater than the most capable current vehicles.

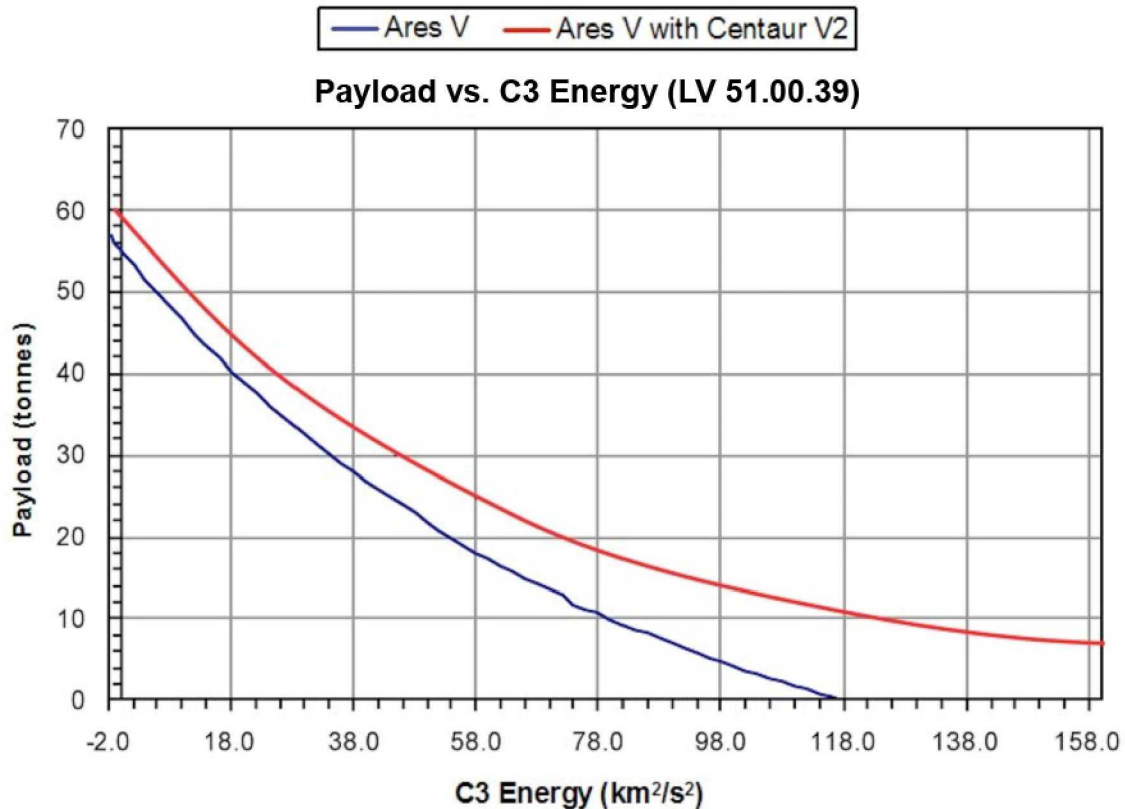

Figure 5: Payload vs. C_3 energy for the 51.00.39 Ares V configuration.

As shown in Figure 6, the Ares V can deliver tremendous payloads to a wide variety of orbital parameters. Based on the pre-LCCR analysis (LV 51.00.39), the Ares V can deliver 56.5 metric tons to a Sun-Earth L2 transfer orbit and 57 metric tons to an Earth-Moon L2 transfer orbit. It can also carry approximately 69.5 metric tons to geosynchronous transfer orbit (GTO) and 35 metric tons to geosynchronous orbit (GEO). This is approximately 6 times that of any currently manufactured launch vehicle. Payloads for additional transfer orbits are also shown. Performance is expected to improve for

the current concept (LV 51.00.48) when the performance analysis is completed.

Among the ground rules assumptions for these calculations were: no gravity assists, interplanetary trip times based on Hohmann transfers, payload mass estimates comprise spacecraft, payload adapter, and mission peculiar hardware, and a two-engine Centaur for the kick stage. The payloads shown for the extended shroud as shown in Figure 8 are a conceptual exercise. Only the POD shroud is included in the design baseline.

Mission Profile	Target	Constellation POD Shroud		Extended Shroud	
		Payload (lbm)	Payload (mt)	Payload (lbm)	Payload (mt)
1) Sun-Earth L2 Transfer Orbit Injection	C3 of $-0.7 \text{ km}^2/\text{s}^2$	124,000	56.5	123,000	56
2) Earth-Moon L2 Transfer Orbit Injection	C3 of $-1.7 \text{ km}^2/\text{s}^2$	126,000	57.0	125,000	57
3) GTO Injection	Transfer DV 8,200 ft/s	153,000	69.5	152,000	69
4) GEO	Transfer DV 14,100 ft/s	77,000	35	76,000	34.5
5) LEO (@29° inclination)	241 x 241 km	315,000	143	313,000	142
6) Cargo Lunar Outpost (TLI Direct), Reference	C3 of $-1.8 \text{ km}^2/\text{s}^2$	126,000	57	125,000	57
7) Mars Cargo (TMI Direct)	C3 of $9 \text{ km}^2/\text{s}^2$	106,000	48	105,000	48

*based on LV 51.00.39

Figure 6: Performance for selected missions using the 51.00.39 configuration.

Ares V's capabilities potentially opens up direct missions to the outer planets that are currently only achievable using indirect flights with gravity assist trajectories. An Ares V with an upper stage could perform these missions using direct flights with shorter interplanetary transfer times, which would

enable extensive in-situ investigations and potentially sample return.

As an example, a preliminary NASA Science Mission Directorate (SMD) study is under way to study the capability of the current LV 51.00.48

reference design. Results to date indicate an increase approximately 20,000 kg more – or approximately 161,000 kg – to LEO. The reference configuration also could send approximately 65,000 kg to a Sun-Earth L2. The study will be completed in the summer of 2009.

Potential for Astronomy and Planetary Science

NASA’s Ames Research Center sponsored a workshop on April 26-27 entitled “Astronomy Enabled by Ares V.”² It had the relatively simple goal of beginning the dialogue between the team designing the Ares V and key members of the astronomy community. Key questions that participants address were:

- Are there astronomy payload concepts or missions capable of breakthrough science that are either enabled or significantly enhanced by the Ares V?
- What do the envisioned payloads need from Ares V in terms of mass, volume, fairing shape, cleanliness, acoustics, access, power, etc?
- What technology and environmental issues need to be addressed to facilitate launching astronomy payloads on Ares V?

- Is there a trade-off between Ares V mass capability and payload complexity that could reduce cost and technical risk for payload designers? Consideration was given to the idea of “dumb mass,” using Ares V’s excess capability to provide dynamic or acoustic damping from launch environments or extra radiation shielding for the space environment or extra fuel for missions into planetary “gravity wells.”

While the Ares V cannot compromise its primary mission to transport the lunar lander and Orion crew vehicle to the Moon, participants agreed that Ares V offers new possibilities to enhance astronomy. Most of the concepts presented by astronomers were driven more by volume requirements than by mass and favored a taller fairing than the baseline design. Both are shown in Figure 7. Volume could be increased by increasing the diameter past the 10 meter current diameter or by increasing the length. A modular fairing design based on length seems to be the best way to increase volume and could be extended in height up to the current height permitted by the Vehicle Assembly building.

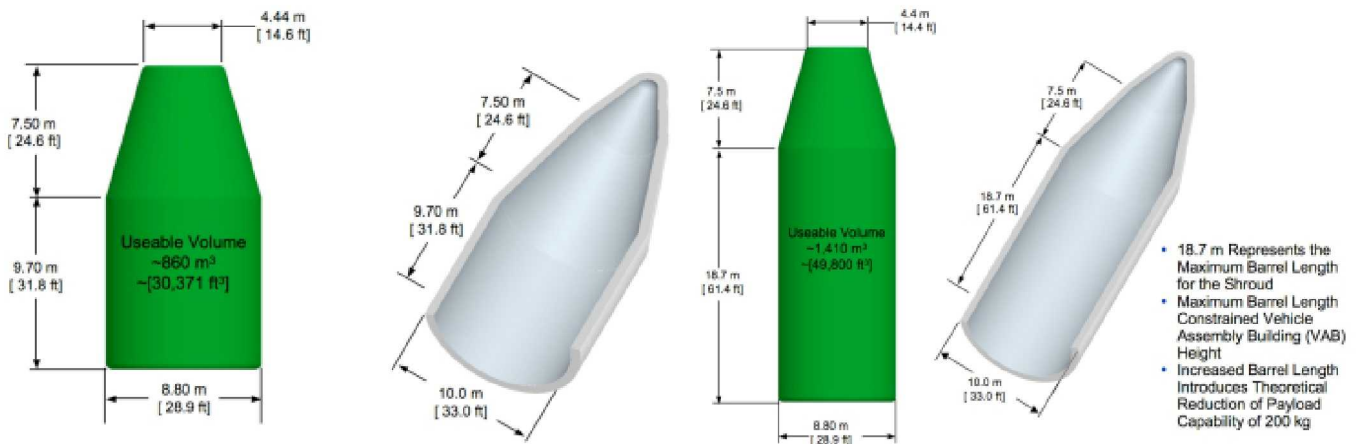

Figure 7: Payload shroud and internal volume for the current point of departure concept, left, and a notional extended shroud, right.

In addition to the emphasis on volume, the workshop also raised the importance of on-orbit servicing of astronomical payloads. The Defense Advanced Research Project Agency’s Orbital Express successfully demonstrated autonomous on-orbit servicing of the telescopes designed for it. The workshop suggested that Ares V, Ares I, and the

Orion crew exploration vehicle could play a role in serving science satellites autonomously or with human crews.

While most of the concepts presented could be launched on existing heavy launch vehicles, Ares V does enable new concepts such as large monolithic

mirrors that are simpler to build and deploy. Such telescopes offer much higher sensitivity and spatial resolution than those that can be launched with current rockets. These qualities are particularly

important for studies of the early universe and extra-solar planets. One such concept is shown in Figure 8 below.



Figure 8: Artist's concept of the Ares V launch of an 8-meter monolithic telescope visible in the cutaway depiction of the payload shroud

Ares V is too early in its design cycle to provide certain information on launch environments such as vibrations, temperature, cleanliness, etc., but payload designers agreed that an environment comparable to the Shuttle would be desirable. Because the RS-68 engines can be throttled, vehicle designers believe the acoustic and dynamic loads can be kept within acceptable limits or mitigated by other means within the payload shroud.

A similar two-day workshop entitled "Ares V Solar System Science" was held at NASA Ames Research Center on August 16-17, 2008.³ The goal again was to bring together Ares V designers with the payload community, this time planetary scientists. Presentations by Ares V designers and by payload designers again showed that Ares V significantly changes what can be done in the planetary science arena. Preliminary analyses suggested that Ares V could deliver roughly five times the payload mass to Mars compared with existing vehicles such as the Delta IV Heavy. Ares V is also capable of larger C₃. This could make possible direct missions to the outer planets that are now achievable only with flights involving gravity-assist trajectories. An Ares V with

an upper stage could perform these missions using direct flights with shorter interplanetary travel times, enabling extensive in situ science and potentially sample return options.

Planetary science is more likely than astronomy to benefit from using Ares V's unprecedented payload mass. Extra fuel for landing and sample return, extra radiation shielding, drill strings and casings for drilling, and redundancy were some of the ideas mentioned at the workshop. For instance, Ares V might enable a sample return mission to Jupiter's moon Europa by allowing propulsion maneuvers inside Jupiter's gravity well and allowing shielding for the lander on the surface. At Saturn, it might allow collection of atmospheric samples and the use of penetrators to churn up materials from the planet's moons. Concepts were also presented during the workshop for missions beyond the solar system to study the outer heliosphere and local interstellar medium. For such a mission, Ares V would launch a payload attached to an upper stage powered by radioisotope-powered ion engines.

Changing the Design Paradigm to Reduce Mission Cost

An idea discussed in both conferences that merits more study is whether the large mass and volume capabilities of the Ares V can be used to reduce technology development and mission risk. Principal investigators and mission designers now use technical complexity, exotic materials, and detailed testing to overcome the mass and volume constraints of current launch vehicles. Existing heavy lift launchers have deployed NASA science missions in the \$5 billion range. A simple extrapolation of Ares V mass capabilities would yield missions costing \$20 billion or more, which might be unaffordable with today's science budgets.

Current cost models vary in their fidelity, but they raise questions worth further investigation. While mass is commonly used to predict mission cost, complexity may be a bigger factor. NASA's Advanced Mission Cost Model, for instance, indicates that cost does rise with mass but also rated high in technical complexity. The same cost models show that historically missions of the same mass but of average difficulty would cost only about \$10 billion or about half the \$20 billion price tag suggested above by simply scaling up the mass.

Ares V enables a new paradigm – reduced cost and risk by designing less complex payloads. Both workshops had discussions on how Ares V might permit better mission performance, reduced risk, shorter schedules, and reduced cost. But doing so requires scientists and engineers to think beyond simply scaling up current designs and instead pursuing simpler, more rugged designs.

The planned James Webb Space Telescope is poised to eclipse the Hubble Space Telescope's capability by employing a fairly complex segmented deployable mirror system that must be carefully designed, built, extensively tested, stowed in a payload shroud, and finally deployed and operated in the harsh space environment. Ares V would enable the launch of a simpler 6-meter monolithic mirror with the same or better light-gathering power while producing a 30 percent savings in overall mission development cost by reducing the need for stowage and deployment hardware and testing.

The increased mass capability might also allow for more robust spacecraft structures that could save costs associated with handling fragile spacecraft; simpler, sturdier instruments; more shielding instead of typical radiation-hardened parts; and the addition

of redundant components to improve mission reliability. By such measures, Ares V can change the current rule of thumb that it costs about \$1 million per kilogram to solve problems that arise during spacecraft and instrument development.

One NASA mission provides anecdotal evidence that large mass and volume margins can enable significant cost savings. The Earth Radiation Budget Satellite (ERBS) was a free-flying Earth observing satellite launched by the Space Shuttle in 1984. As one of the early shuttle payloads, ERBS took advantage of the large mass and volume margins provided by the shuttle to use off-the-shelf components and robust design technologies. The result was a satellite bus cost that was 70% less on a per-pound basis than average for a similar Earth observing spacecraft.

While the cost performance of a single mission should not be used to set expectations within NASA and the science community, it does illustrate that the potential exists to use large mass and volume margins to achieve cost savings if requirements are carefully managed early in the program. Two studies by The Aerospace Corporation in 2008 further suggest some inherent payload-wide design issues where Ares V capabilities could help. One notes that "use of heavy, low-cost technologies was shown to decrease costs from lightweight advanced technologies. Use of existing technology was shown to reduce development costs by 54% on a pound for pound basis."⁴ The second study suggests that mass, schedule, and cost growth is common, interrelated, and significant among science payloads.⁵

While many payload cost models to date use mass to estimate cost, recent thinking notes that not all cost drivers are being addressed in existing models. Among the factors attracting more attention are "new design" and "integration complexity," a 2003 NASA paper noted.⁶ These and other factors such as management, manufacturing, and funding are being combined into analyses that plot mission complexity versus cost to provide a more refined prediction of expected mission success or failure – a tool that can greatly assist the payload community. Those calculations are complex but they can be distilled into a simpler equation: simplicity equals less technical risk and higher confidence in mission success. A May 2000 paper by The Aerospace Corporation suggested such: "A clear dependence of success rate on systems complexity was identified."⁷

In its "Launching Science..." report referenced above, the NRC echoed comments from the Ames

conference in recognizing Ares V's possibilities: "NASA should conduct a comprehensive systems engineering-based analysis to assess the possibility that the relaxation of weight and volume constraints enabled by Ares V for some space science missions might make feasible significantly a different approach to science mission design, development, assembly, integration, and testing, resulting in a relative decrease in the cost of space science missions."

Conclusions

Ares V has unprecedented capability for launching payloads that one potential user said "opens the doors of imagination." Indeed, Ares V offers a crosscutting solution to a wide range of payloads. It can launch more capable science spacecraft farther, shorten trip times, and increase scientific return on missions that otherwise might be launched on today's launchers. It could also enable certain kinds of missions, such as sample return, that would be impossible on today's fleet. Payload and mission designers certainly can use traditional technical complexity to fully exploit Ares V capabilities. Additionally, though, they stand to gain greater scientific "bang for their buck" and, conversely, less undesirable "bang" in the form of mission-jeopardizing risk, by using Ares V's mass and volume capabilities as technical margin.

Bigger/Better/Faster/Farther is always an attractive design goal to scientists with the unquenchable desire to explore beyond today's limits. Ares V allows them to do that. For those willing to explore the possibilities within the payload development universe—particularly those facing limited resources—Ares V also holds the possibility of new less costly, less risky solutions for the space science community.

References

1. Committee on Science Opportunities Enabled by NASA's Constellation System; National Research Board: *Launching Science. Science Opportunities Provided by NASA's Constellation System*, National Academies Press, ISBN: 0-309-11645-7, Washington, D.C., 2008.
2. Workshop Report on Astronomy Enabled by Ares V, *NASA/CP—2008–214588*, Ames Research Center, August 2008.
3. Workshop Report on Ares V Solar System Science, *NASA/CP—2008–214592*, Ames Research Center, December 2008.

4. Ares V Alternative Mission Study, The Aerospace Corporation, August 2008.
5. Bearden, D.: "Perspectives on NASA Mission Cost and Schedule Performance Trends," Presentation at GSFC Symposium, June 3, 2008.
6. Prince, F.A.: "Weight and the Future of Space Flight Hardware Cost Modeling," *Joint International Society of Parametric Analysts/Society of Cost Estimating and Analysis Conference*, Marshall Space Flight Center, AL, 2003.
7. Bearden, D.: "A Complexity-Based Risk Assessment of Low-Cost Planetary Missions: When is a Mission Too Fast and Too Cheap?" *Fourth IAA International Conference on Low-Cost Planetary Missions*, JHU/APL, Laurel, MD, May 2–5, 2000.

Nomenclature

BDM	booster deceleration motor
CDR	critical design review
CEV	crew exploration vehicle
CFM	cryogenic fluid management
CM	crew module
EDS	Earth departure stage
FSB	five segment booster
FTV	flight test vehicle
GN&C	guidance, navigation, and control
HAA	high altitude abort
LAS	launch abort system
LEO	low earth orbit
LH ₂	liquid hydrogen
LOX	liquid oxygen
LSC	linear shape charge
IOC	initial operational capability
ISS	international space station
ISTA	integrated stage test article
IVGVT	integrated vehicle ground vibration test
MCR	mission concept review
MECO	main engine cut-off
MLP	mobile launch platform
MPS	main propulsion system
MPTA	main propulsion test article
MSFC	Marshall Space Flight Center
m	meter
mT	metric tons
NASA	National Aeronautics and Space Admin.
OET	orbital environments test
PDR	preliminary design review
RCS	reaction control system
SA	spacecraft adapter
SM	service module

SRB solid rocket booster
SSC Stennis Space Center
TLI trans-lunar injection
TVC thrust vector control
USM ullage settling motor



Ares V: Shifting the Payload Design Paradigm

Charles E. Cockrell, Jr.
Associate Director,
Systems Engineering Directorate
NASA LaRC

IAC 2009
October 12-16, 2009





Ares V Elements

Current Point-of-Departure

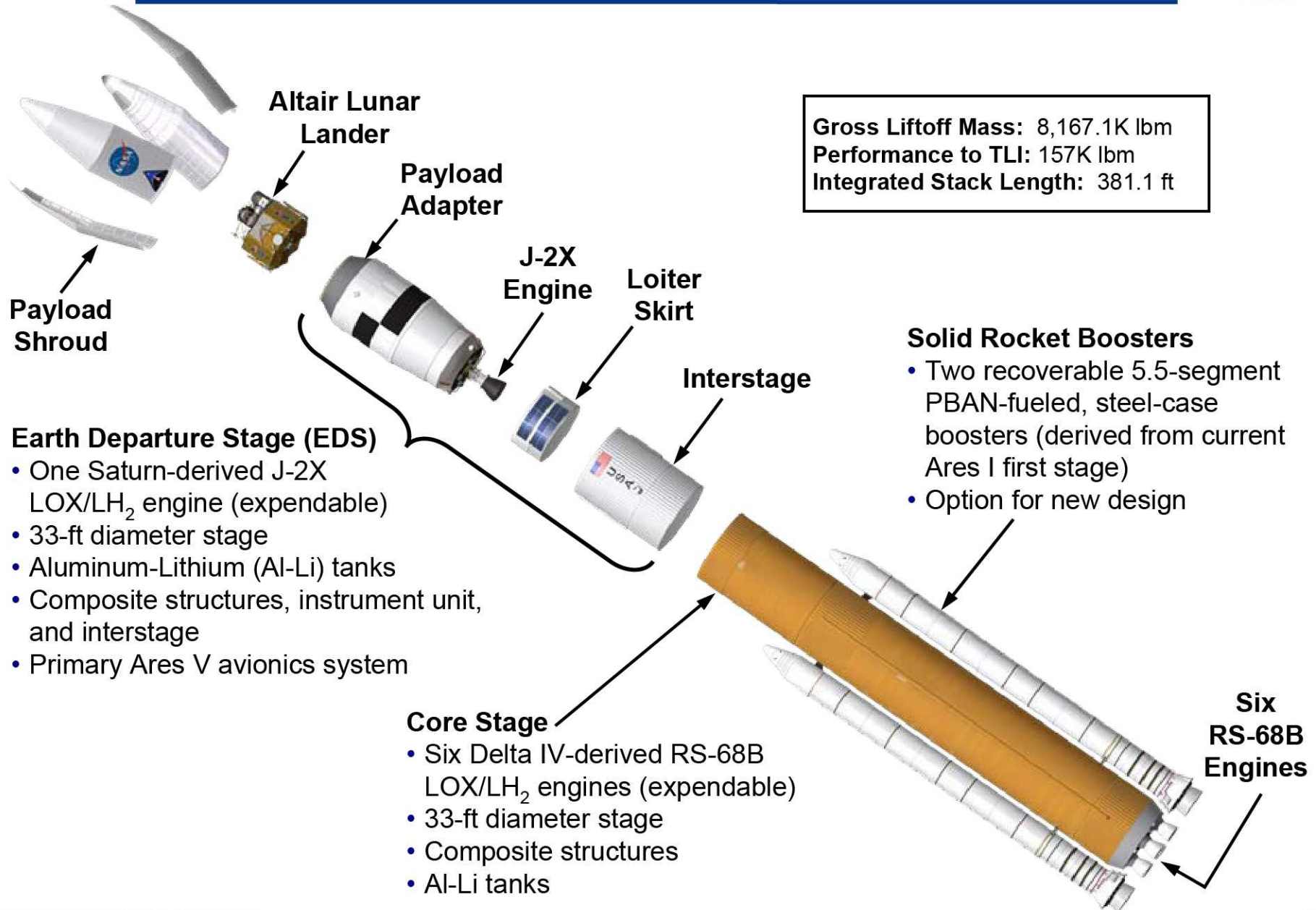



Constellation Lunar Sortie Mission

– 1.5 Vehicle Launch Solution –



◆ Current Ares V concept analyses are based on 67mt payload to TLI requirement (Lunar Lander + Crew Exploration Vehicle)

- Orbital Insertion at 130 nmi and 29.0° inclination
- Orbital decay during maximum 4-day loiter period
- Trans Lunar Injection (TLI) burn of 3175 m/s from 100 nmi

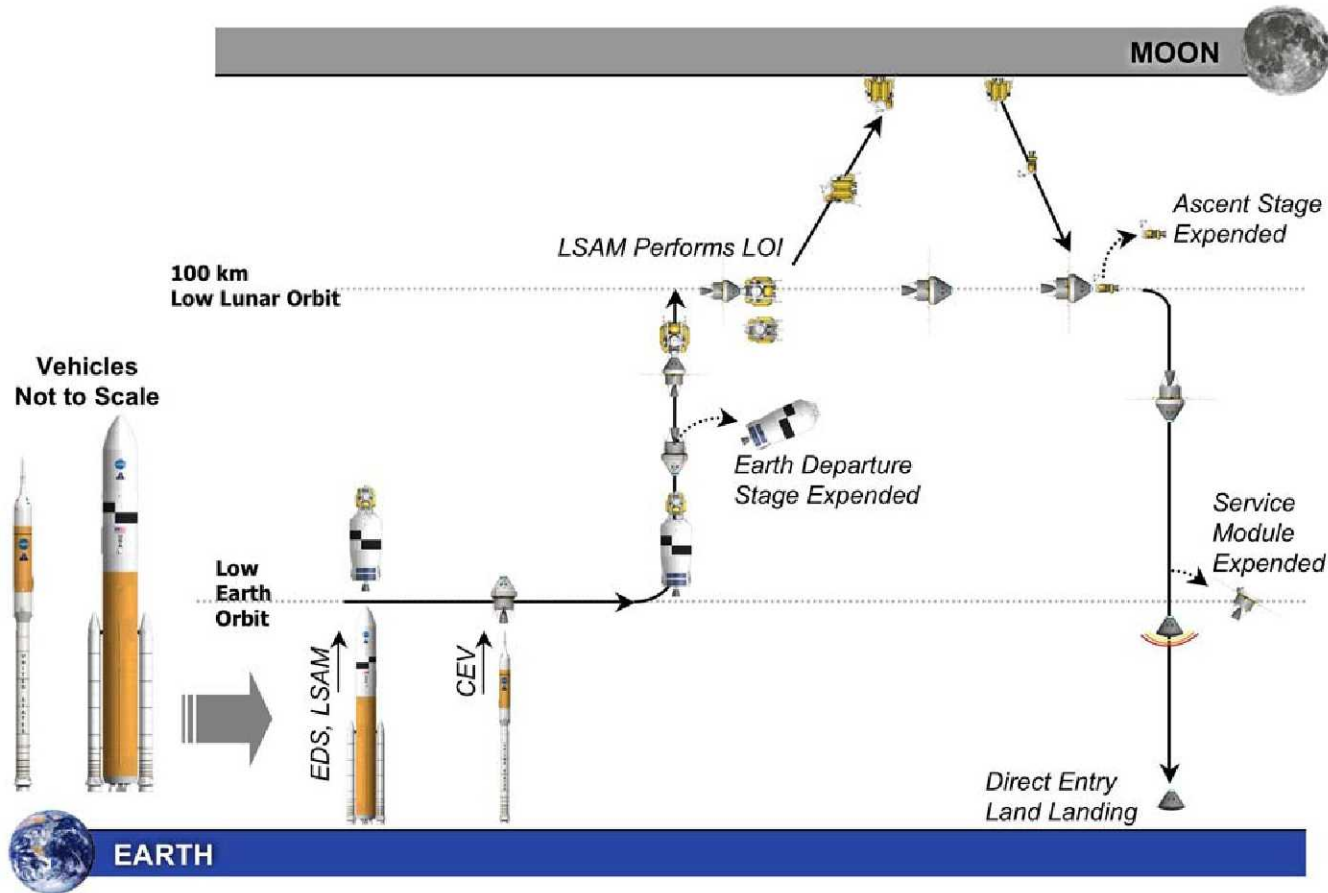



Current Ares V Shroud Concept

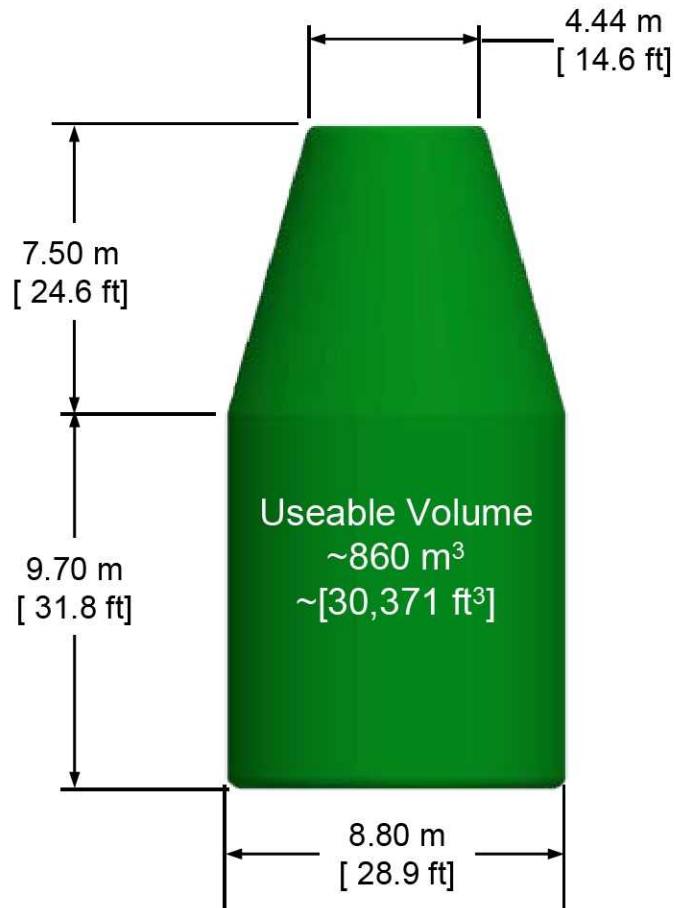



Ares V LEO Performance

– Constellation POD Shroud –



Ares V Payload vs. Altitude & Inclination

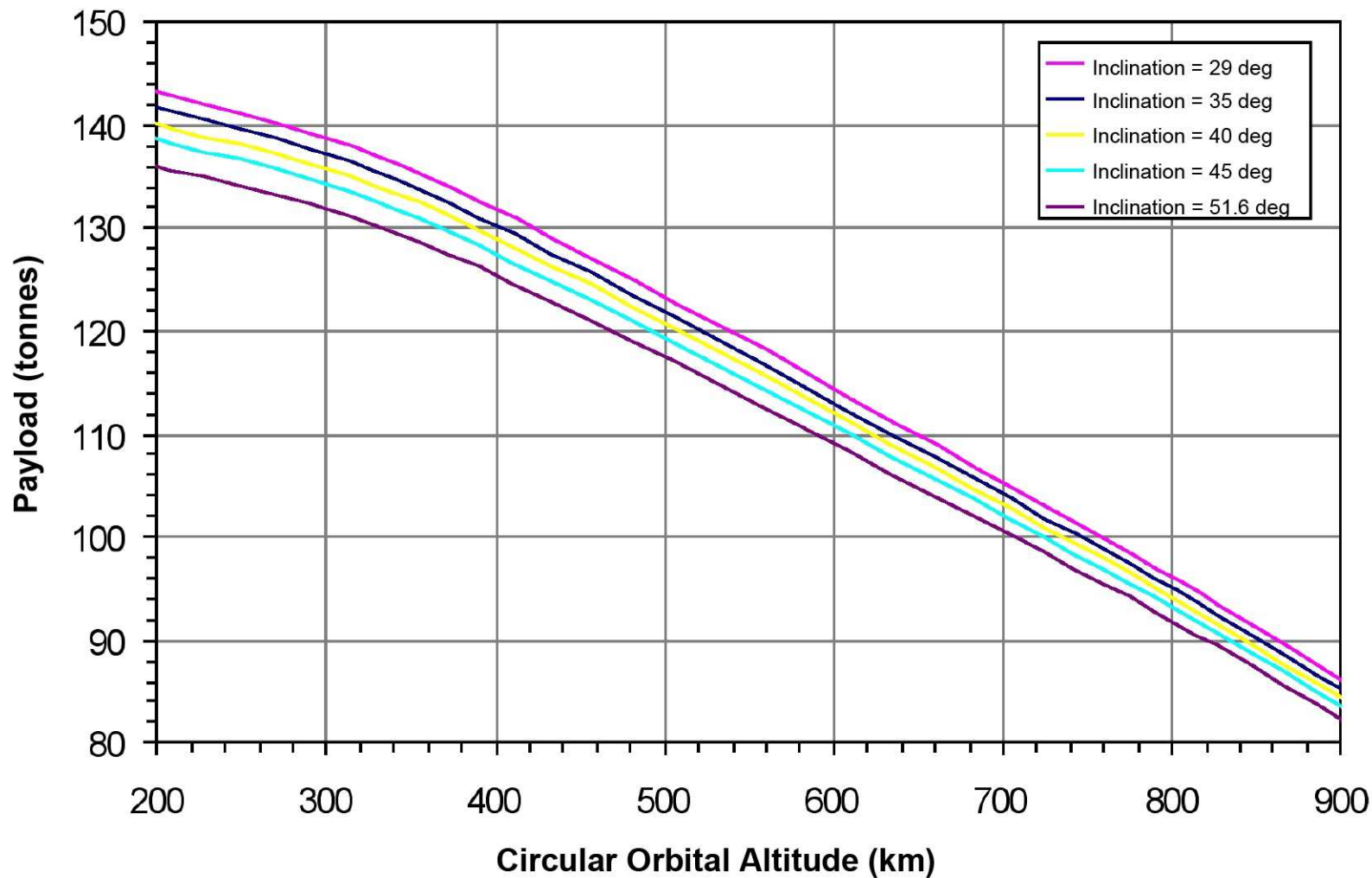



Ares V Escape Performance

– Constellation POD Shroud –



— Ares V — Ares V with Centaur V2

Payload vs. C3 Energy

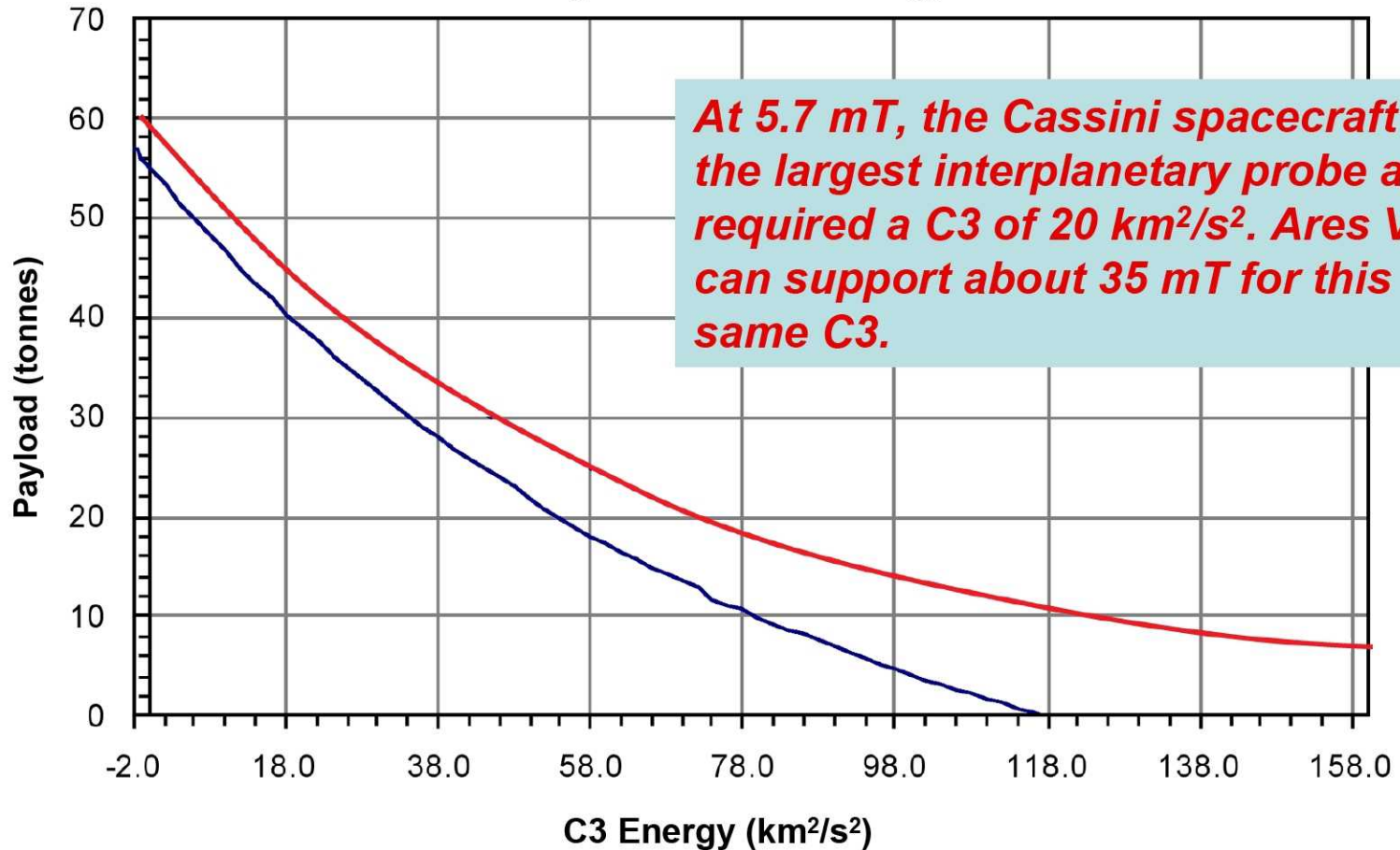

At 5.7 mT, the Cassini spacecraft is the largest interplanetary probe and required a C3 of 20 km²/s². Ares V can support about 35 mT for this same C3.



Payload vs. Trip Times for Representative Missions

– Constellation POD Shroud –

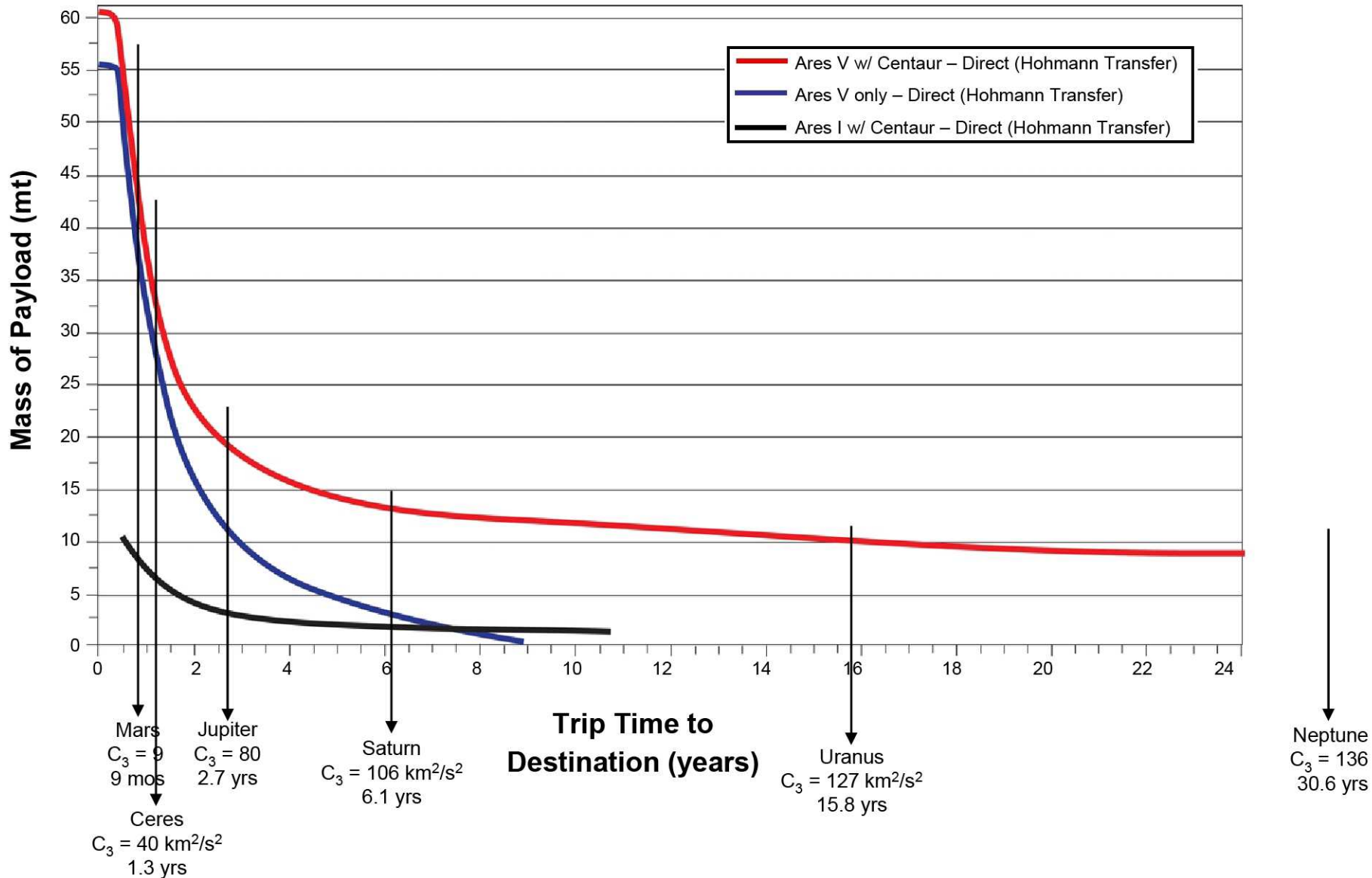



Ares V Performance for Selected Trajectories from KSC



Mission Profile	Target	Constellation POD Shroud		Extended Shroud	
		Payload (lbm)	Payload (mt)	Payload (lbm)	Payload (mt)
4) Sun-Earth L2 Transfer Orbit Injection	C3 of $-0.7 \text{ km}^2/\text{s}^2$	124,000	56.5	123,000	56
5) Earth-Moon L2 Transfer Orbit Injection	C3 of $-1.7 \text{ km}^2/\text{s}^2$	126,000	57.0	125,000	57
3) GTO Injection	Transfer DV 8,200 ft/s	153,000	69.5	152,000	69
2) GEO	Transfer DV 14,100 ft/s	77,000	35	76,000	34.5
1) LEO (@29° inclination)	241 x 241 km	315,000	143	313,000	142
6) Cargo Lunar Outpost (TLI Direct), Reference	C3 of $-1.8 \text{ km}^2/\text{s}^2$	126,000	57	125,000	57
7) Mars Cargo (TMI Direct)	C3 of $9 \text{ km}^2/\text{s}^2$	106,000	48	105,000	48

*based on LV 51.00.39



Notional Ares V Shroud for Other Missions

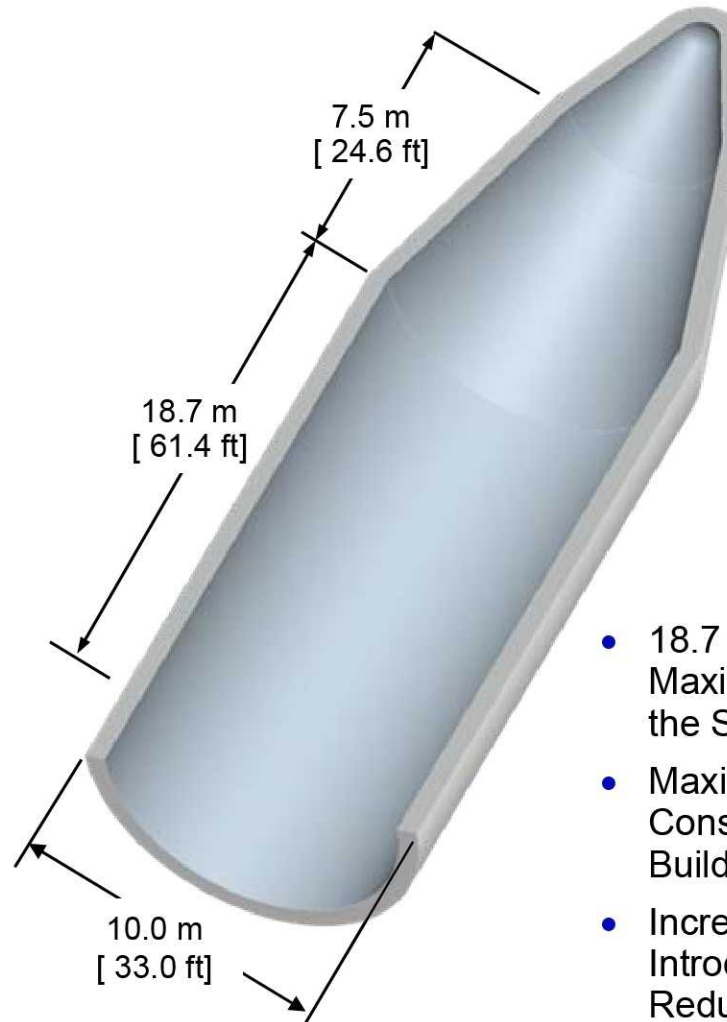
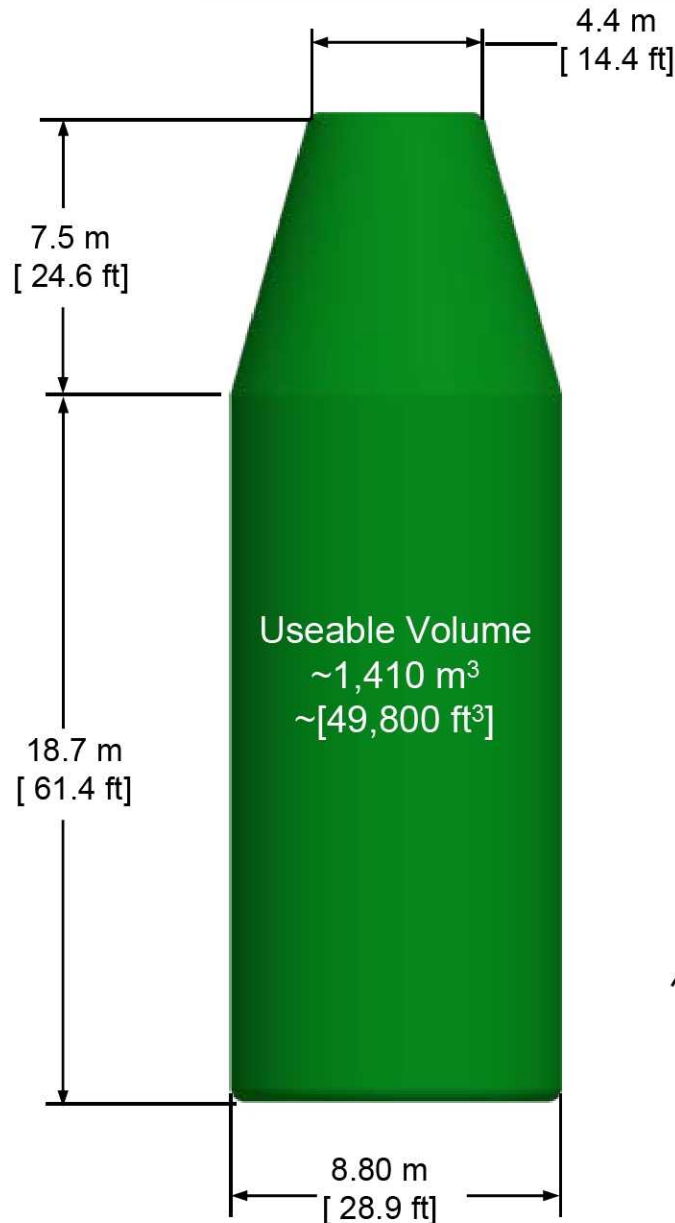

- 18.7 m Represents the Maximum Barrel Length for the Shroud
- Maximum Barrel Length Constrained Vehicle Assembly Building (VAB) Height
- Increased Barrel Length Introduces Theoretical Reduction of Payload Capability of 200 kg



Ares V LEO Performance

– Extended Shroud –



Ares V Payload vs. Altitude & Inclination

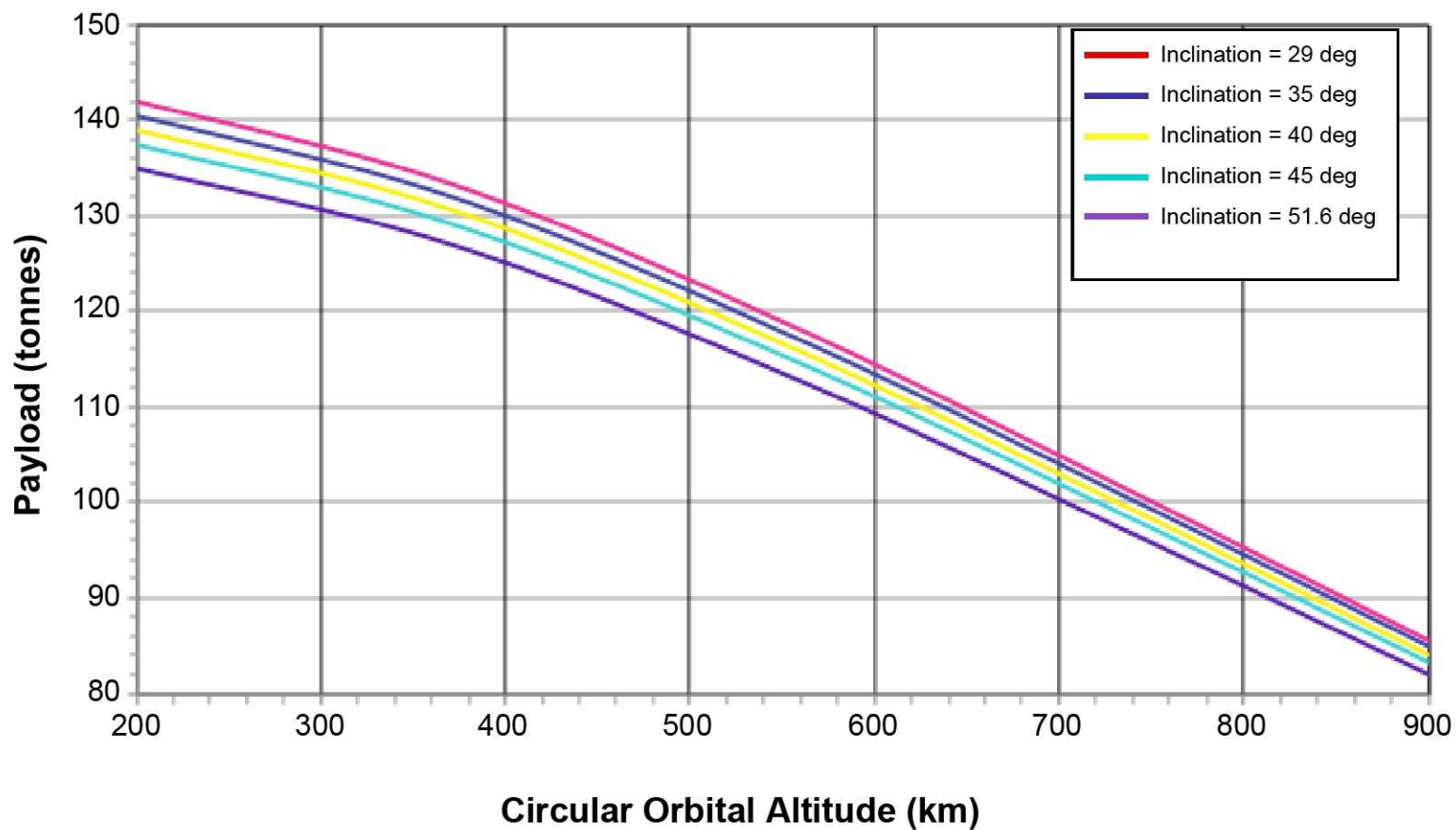



Ares V Escape Performance

– Extended Shroud –



Payload vs. C3 Energy

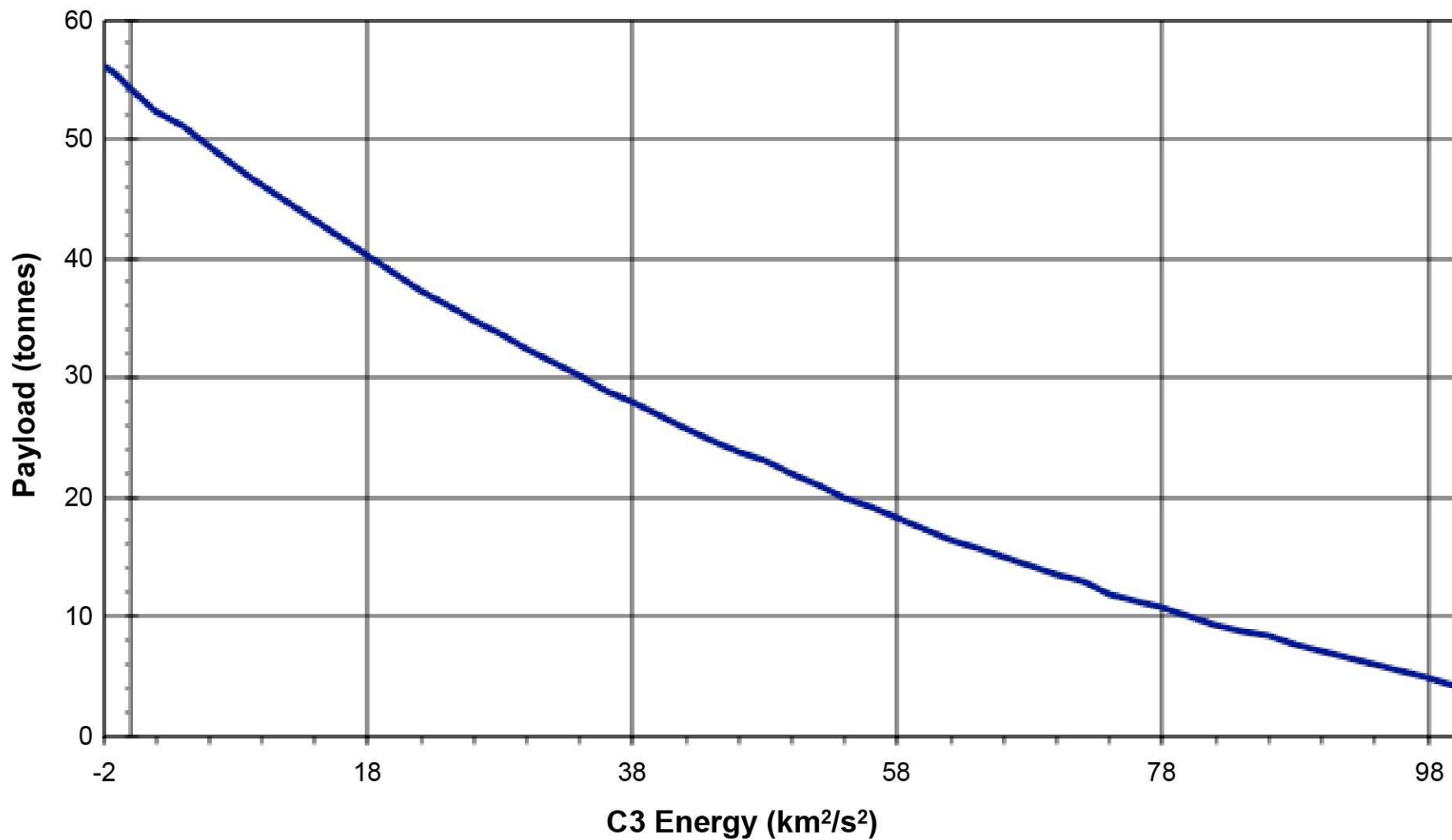



Developing Ares V Launch System Mission Planner's Guide

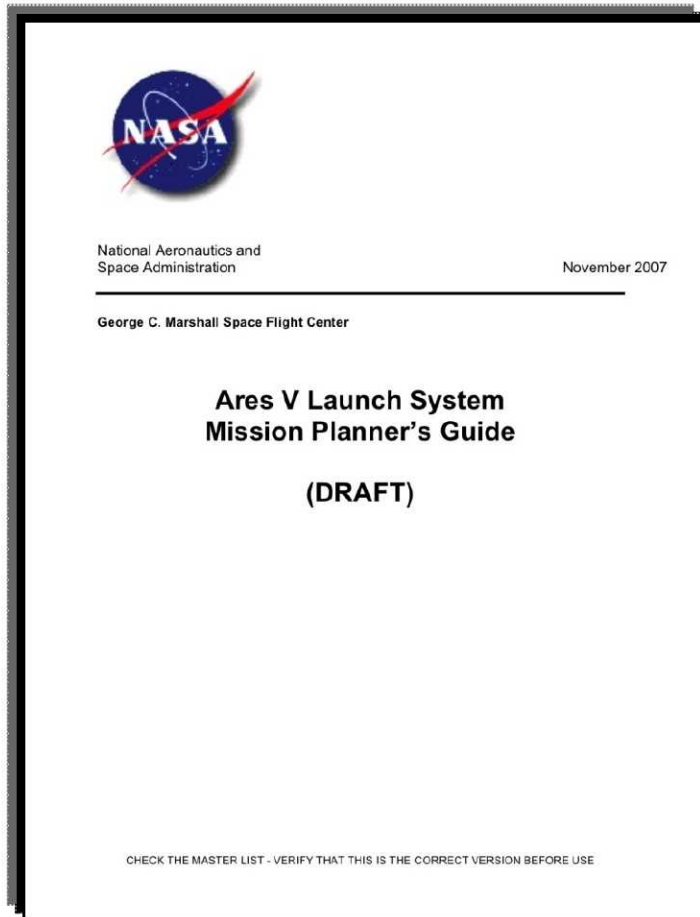

◆ Mission Planner Guide Draft Release Pending

- Interface Definitions
 - Fairings, Adapters...
- Mission Performance
- Development Timelines
- Concept of Operations
- Potential Vehicle Evolution and Enhancements
- Need Past Astronomy Mission Data



Architecture Flexibility Enables New Science Applications

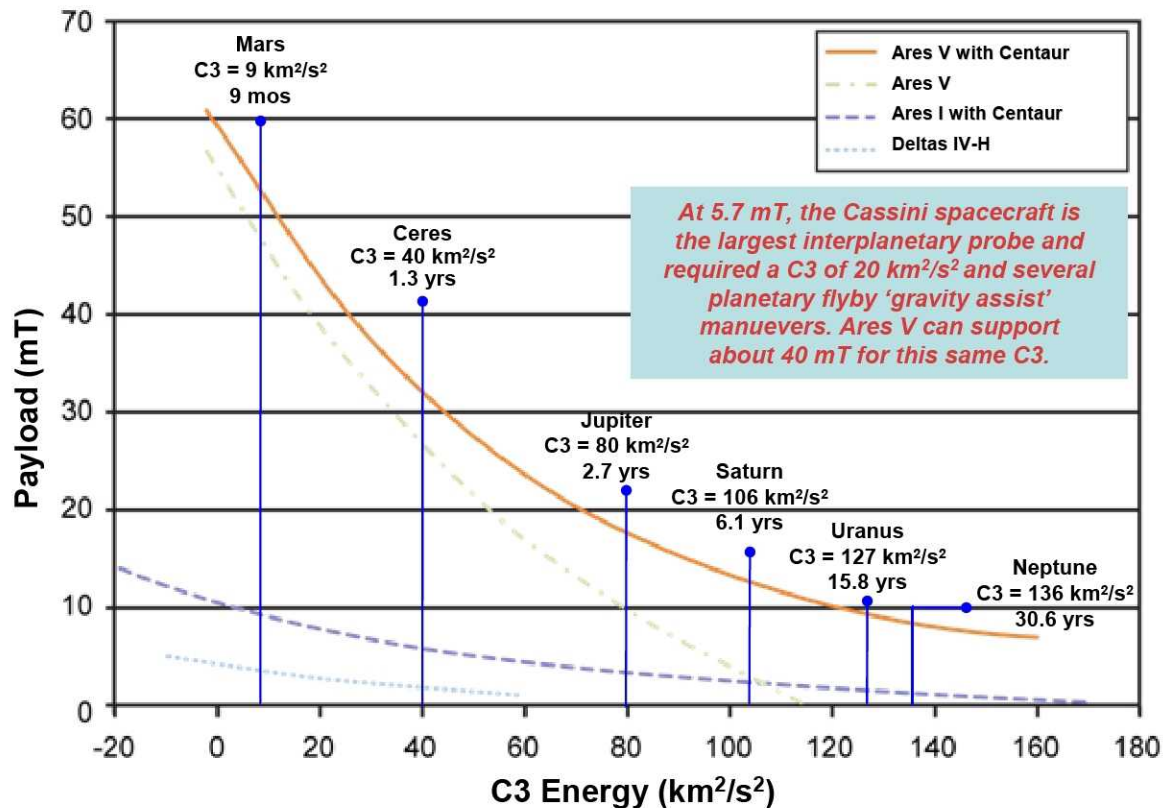

Large Payload Volume and Lift Capability



Cassini Spacecraft Approximately to scale for comparison

Ares V will have the largest payload volume capability of any existing launch system

"It is very clear from the outset that the availability of the Ares V changes the paradigm of what can be done in planetary science."
– Workshop on Ares V Solar System Science

"Exciting new science may be enabled by the increased capability of Ares V. The larger launch mass, large volume, and increased C3 capability are only now being recognized by the science community."
– National Academy of Science's
"Science Opportunities by NASA's Constellation Program"

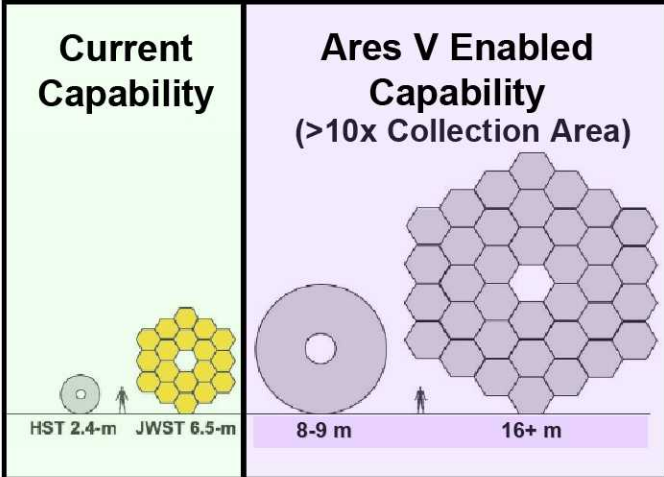



Backup





Ground Rules and Assumptions



- ◆ **All trajectories analyzed using POST3D (Program to Optimize Simulated Trajectories – 3 Dimensional)**
- ◆ **Flight performance reserve is based on the Ares V LEO mission, and is held constant for all cases**
- ◆ **No gravity assists**
- ◆ **Interplanetary trip times are based on Hohmann transfers (limited to ~24 years max.)**
- ◆ **Payload mass estimates are separated spacecraft mass, and include payload adapter and any mission peculiar hardware (if required)**
- ◆ **Ares V vehicle based on configuration 51.00.39, but w/ Upper Stage burnout mass from configuration 51.00.34 (propellant tanks not resized for high C3 missions)**



Ground Rules and Assumptions (Cont'd)



- ◆ **For cases incorporating a kick stage:**
 - Ares I and Ares V employ 2-engine Centaur from Atlas V
 - Additional adapter mass of 6,400 lbm assumed
 - No adjustments to aerodynamic data
- ◆ **Propellant mass for:**
 - Ares V LEO missions: held constant at 310,000 lbm
 - Ares I and V C3 missions and Ares I LEO missions: maximum propellant load
- ◆ **No Upper Stage propellant off-loading for Ares I and Ares V C3 cases**
- ◆ **Transfer orbit to Sun-Earth L2 point is a direct transfer w/C3= - 0.7 km²/s²**
 - Payload can be increased by using a lunar swing-by maneuver
- ◆ **All cases targeting a C3 are of longer duration than the J-2X constraint of 500 seconds**