

**NATIONAL ADVISORY COMMITTEE
FOR AERONAUTICS**

REPORT No. 474

NOMENCLATURE FOR AERONAUTICS

**By NATIONAL ADVISORY COMMITTEE
FOR AERONAUTICS**



REPRINT OF REPORT No. 474, ORIGINALLY PUBLISHED MARCH 1934

1939

REPORT No. 474

NOMENCLATURE FOR AERONAUTICS

By National Advisory Committee for Aeronautics

REPRINT OF REPORT No. 474, ORIGINALLY PUBLISHED MARCH 1934

NATIONAL ADVISORY COMMITTEE FOR AERONAUTICS

HEADQUARTERS, NAVY BUILDING, WASHINGTON, D. C.

LABORATORIES, LANGLEY FIELD, VA.

Created by act of Congress approved March 3, 1915, for the supervision and direction of the scientific study of the problems of flight (U. S. Code, Title 50, Sec. 151). Its membership was increased to 15 by act approved March 2, 1929. The members are appointed by the President, and serve as such without compensation.

JOSEPH S. AMES, Ph. D., *Chairman*,
Baltimore, Md.

VANNEVAR BUSH, Sc. D., *Vice Chairman*,
Washington, D. C.

CHARLES G. ABBOT, Sc. D.,
Secretary, Smithsonian Institution.

HENRY H. ARNOLD, Major General, United States Army,
Chief of Air Corps, War Department.

GEORGE H. BRETT, Brigadier General, United States Army,
Chief Matériel Division, Air Corps, Wright Field, Dayton
Ohio.

LYMAN J. BRIGGS, Ph. D.,
Director, National Bureau of Standards.

ARTHUR B. COOK, Rear Admiral, United States Navy,
Chief, Bureau of Aeronautics, Navy Department.

CLINTON M. HESTER, A. B., LL. B.,
Administrator, Civil Aeronautics Authority.

JEROME C. HUNSAKER, Sc. D.,
Cambridge, Massachusetts.

SYDNEY M. KRAUS, Captain, United States Navy,
Bureau of Aeronautics, Navy Department.

CHARLES A. LINDBERGH, LL. D.,
New York City.

EDWARD J. NOBLE, A. B.,
Chairman, Civil Aeronautics Authority.

FRANCIS W. REICHELDERFER, A. B.,
Chief, United States Weather Bureau.

EDWARD P. WARNER, Sc. D.,
Greenwich, Conn.

ORVILLE WRIGHT, Sc. D.,
Dayton, Ohio.

GEORGE W. LEWIS, *Director of Aeronautical Research*

JOHN F. VICTORY, *Secretary*

HENRY J. E. REID, *Engineer-in-Charge, Langley Memorial Aeronautical Laboratory, Langley Field, Va.*

JOHN J. IDE, *Technical Assistant in Europe, Paris, France*

TECHNICAL COMMITTEES

AERODYNAMICS
POWER PLANTS FOR AIRCRAFT
AIRCRAFT MATERIALS

AIRCRAFT STRUCTURES
AIRCRAFT ACCIDENTS
INVENTIONS AND DESIGNS

Coordination of Research Needs of Military and Civil Aviation

Preparation of Research Programs

Allocation of Problems

Prevention of Duplication

Consideration of Inventions

LANGLEY MEMORIAL AERONAUTICAL LABORATORY

LANGLEY FIELD, VA.

Unified conduct, for all agencies, of scientific research on the
fundamental problems of flight.

OFFICE OF AERONAUTICAL INTELLIGENCE

WASHINGTON, D. C.

Collection, classification, compilation, and dissemination of
scientific and technical information on aeronautics.

INTRODUCTION

The nomenclature for aeronautics presented in this Report No. 474 is a revision of the last previous report on this subject (Report No. 240), which was issued in 1926.

This nomenclature was prepared by a special con-

ference on aeronautical nomenclature authorized by the executive committee of the National Advisory Committee for Aeronautics. The organization of the conference was as follows:

CONFERENCE ON AERONAUTICAL NOMENCLATURE

Dr. JOSEPH S. AMES, *Chairman*

NATIONAL ADVISORY COMMITTEE FOR AERONAUTICS:

Mr. Charles H. Helms
Mr. Carlton Kemper
Mr. G. W. Lewis
Mr. H. J. E. Reid
Hon. Edward P. Warner

AIR CORPS, U.S.A.:

Capt. Karl S. Axtater, U.S.A.
Capt. Albert C. Foulk, U.S.A.
Capt. A. F. Hegenberger, U.S.A.
Maj. C. W. Howard, U.S.A.
Maj. William E. Kepner, U.S.A.
Capt. Clements MacMullen, U.S.A.
Capt. E. R. Page, U.S.A.

BUREAU OF AERONAUTICS, NAVY DEPARTMENT:

Lt. Comdr. W. S. Diehl (C.C.), U.S.N.
Commander Garland Fulton (C.C.), U.S.N.
Lt. Comdr. R. D. MacCart (C.C.), U.S.N.
Commander C. A. Pownall, U.S.N.
Commander R. D. Weyerbacher (C.C.), U.S.N.

BUREAU OF STANDARDS:

Dr. L. J. Briggs
Dr. W. G. Brombacher
Dr. H. C. Dickinson
Dr. H. L. Dryden

AERONAUTICS BRANCH, DEPARTMENT OF COMMERCE:

Col. Harry H. Blee
Mr. Richard C. Gazley
Capt. F. C. Hingsburg

The members of the conference were engaged in the preparation of the report from the time of the

appointment of the members August 11, 1931, to the date of approval of the report for publication by the executive committee of the National Advisory Committee for Aeronautics on November 14, 1933.

This report supersedes all previous publications of the Committee on this subject. The entire text has been thoroughly revised and new sketches have been inserted to replace obsolete photographs. The arrangement is alphabetical throughout and not by subjects, but the complete cross-indexing will, it is expected, make each term easily found. The definitions have been made as brief and as general as possible except in the cases where use of the term is restricted to a small specialized group. In cases where uncertainty or ambiguity is known to exist, the complete definition given herein represents the meaning ascribed to the term in the official publications of the National Advisory Committee for Aeronautics.

This report is published for the purpose of encouraging greater uniformity and precision in the use of terms relating to aeronautics, both in official documents of the Government and in commercial publications. Terms in general use in other branches of engineering have been included only where they have some special significance in aeronautics, or form an integral part of its terminology.

Page intentionally left blank

REPORT No. 474

NOMENCLATURE FOR AERONAUTICS

By the NATIONAL ADVISORY COMMITTEE FOR AERONAUTICS

REPRINT OF REPORT No. 474, ORIGINALLY PUBLISHED MARCH 1934

absolute altitude—See ALTITUDE, ABSOLUTE.

absolute ceiling—See CEILING, ABSOLUTE.

accelerometer—An instrument that measures the accelerations of an aircraft in a defined direction.

acrobatics—Evolutions voluntarily performed with an aircraft other than those required for normal flight.

adjustable propeller—See PROPELLER, ADJUSTABLE.

aerodynamic center, wing section—A point located on or near the chord of the mean line approximately one quarter of the chord length aft of the leading edge and about which the moment coefficient is practically constant. (See fig. 2.)

aerodynamics—The branch of dynamics that treats of the motion of air and other gaseous fluids and of the forces acting on solids in motion relative to such fluids.

aerodynamic volume (or air volume)—The total volume of an aerostat, including its projecting parts.

aerodyne—A generic term for aircraft that derive their lift in flight chiefly from aerodynamic forces.

aerograph—Same as METEOROGRAPH.

aeronaut—The pilot of an aerostat.

aeronautics—The science and art of flight.

aerostat—(a) A generic term for an aircraft whose support is chiefly due to buoyancy derived from aerostatic forces. The immersed body consists of one or more containers filled with a gas that is lighter than air. (b) A balloon or airship.

aerostatics—The science that treats of the equilibrium of gaseous fluids and of bodies immersed in them.

aerostation—The art of operating aerostats.

aileron—A hinged or movable portion of an airplane wing, the primary function of which is to impress a rolling motion on the airplane. It is usually part of the trailing edge of a wing. (See fig. 5.)

external aileron—A separate airfoil mounted clear of the wing surfaces of an airplane but usually attached to them and deflected for lateral control.

Frise aileron—An aileron having the nose portion projecting ahead of the hinge axis, the lower surface being in line with the lower surface of the wing. When the trailing edge of the aileron is raised, the nose portion protrudes below the lower surface of the wing, increasing the drag. (See fig. 1.)

aileron—continued

slotted aileron—An aileron having a nose and axis arrangement somewhat similar to a Frise aileron but having a smooth air passage between the nose portion of the aileron and the wing for the purpose of maintaining a smooth air flow over the upper surface of the aileron when its trailing edge is deflected downward. (See fig. 1.)

upper-surface aileron—A split flap forming the rear upper surface of a wing, deflected for lateral control.

aileron angle—See ANGLE, AILERON.

aileron linkage arrangements:

differential aileron linkage arrangement—Ailerons so interconnected that a given movement of the control stick results in the upward displacement of one aileron being greater than the downward displacement of the other.

floating aileron linkage arrangement—Ailerons so linked together and to the control stick as to "float" freely in the air stream except when displaced by the lateral motion of the control stick.

aircraft—Any weight-carrying device designed to be supported by the air, either by buoyancy or by dynamic action.

aircraft carrier—A ship designed to carry aircraft and to permit their landing and take-off.

air duct—A tube, usually of fabric, supplying air for filling or for maintaining pressure in the air-filled parts of an aerostat. (See fig. 4.)

airfoil—Any surface, such as an airplane wing, aileron, or rudder, designed to obtain reaction from the air through which it moves.

airfoil profile—The outline of an airfoil section (fig. 2).

airfoil section—A cross section of an airfoil parallel to the plane of symmetry or to a specified reference plane.

airline—The great circle route between two points.

air line—An established system of aerial transportation, its equipment, or the company owning or operating it.

airplane—A mechanically driven fixed-wing aircraft, heavier than air, which is supported by the dynamic reaction of the air against its wings (fig. 5).

canard airplane—A type of airplane having the horizontal stabilizing and control surfaces in front of the main supporting surfaces.

airplane—continued.

pusher airplane—An airplane with the propeller or propellers aft of the main supporting surfaces.

tailless airplane—An airplane in which the devices used to obtain stability and control are incorporated in the wing.

tractor airplane—An airplane with the propeller or propellers forward of the main supporting surfaces.

airport—A tract of land or water which is adapted for the landing and take-off of aircraft and which provides facilities for their shelter, supply, and repair; a place used regularly for receiving or discharging passengers or cargo by air.

air scoop—A scoop or hood designed to catch the air and maintain the air pressure in ballonets, internal-combustion engines, ventilators, etc. (See fig. 3.)

airship—An aerostat provided with a propelling system and with means of controlling the direction of motion.

nonrigid airship—An airship whose form is maintained by the internal pressure in the gas bags and ballonets (fig. 3).

pressure-rigid airship—An airship combining the principles used in both rigid and nonrigid airships to maintain shape and skin tautness.

rigid airship—An airship whose form is maintained by a rigid structure (fig. 6).

semirigid airship—An airship whose shape is maintained by means of a rigid or jointed keel in conjunction with internal pressure in the gas containers and ballonets (fig. 4).

airship shed—See DOCK.

airship station—(1) The complete assembly of sheds, masts, gas plants, shops, landing fields, and other equipment required to operate airships and supply their needs. (2) The base from which airships are operated.

air speed—The speed of an aircraft relative to the air.

air-speed head—An instrument which, in combination with a gage, is used to measure the speed of an aircraft relative to the air. It usually consists of a pitot-static tube or a pitot-venturi tube.

air volume—See AERODYNAMIC VOLUME.

airway—An air route along which aids to air navigation, such as landing fields, beacon lights, radio direction-finding facilities, intermediate fields, etc., are maintained.

airworthiness—The quality of an aircraft denoting its fitness and safety for operation in the air under normal flying conditions.

altigraph—A recording altimeter.

altimeter—An instrument that measures the elevation of an aircraft above a given datum plane.

altitude:

absolute altitude—The height of an aircraft above the earth.

altitude—continued.

critical altitude—The maximum altitude at which a supercharger can maintain a pressure in the intake manifold of an engine equal to that existing during normal operation at rated power and speed at sea level.

density altitude—The altitude corresponding to a given density in a standard atmosphere.

pressure altitude—(1) The altitude corresponding to a given pressure in a standard atmosphere. (2) The altitude at which the gas bags of an airship become full.

altitude mixture control—See MIXTURE CONTROL, ALTITUDE.

amphibian—An airplane designed to rise from and alight on either land or water.

angle:

aileron angle—The angular displacement of an aileron from its neutral position. It is positive when the trailing edge of the aileron is below the neutral position.

blade angle—The acute angle between the chord of a section of a propeller, or of a rotary wing system, and a plane perpendicular to the axis of rotation.

coning angle—The average angle between the span axis of a blade or wing of a rotary wing system and a plane perpendicular to the axis of rotation.

dihedral angle—The acute angle between a line perpendicular to the plane of symmetry and the projection of the wing axis on a plane perpendicular to the longitudinal axis of the airplane. If the wing axis is not approximately a straight line, the angle is measured from the projection of a line joining the intersection of the wing axis with the plane of symmetry and the aerodynamic center of the half-wing on either side of the plane of symmetry. (See fig. 5.)

downwash angle—The angle through which an air stream is deflected by any lifting surface. It is measured in a plane parallel to the plane of symmetry.

drift angle—The horizontal angle between the longitudinal axis of an aircraft and its path relative to the ground.

effective helix angle—The angle of the helix described by a particular point on a propeller blade as the airplane moves forward through air otherwise undisturbed.

elevator angle—The angular displacement of the elevator from its neutral position. It is positive when the trailing edge of the elevator is below the neutral position.

flapping angle—The difference between the coning angle and the instantaneous angle of the span axis of a blade of a rotary wing system relative to the plane perpendicular to the axis of rotation.

angle—continued.

flight-path angle—The angle between the flight path of the aircraft and the horizontal.

gliding angle—The angle between the flight path during a glide and a horizontal axis fixed relative to the air.

landing angle—The acute angle between the wing chord and the horizontal when the airplane is resting on level ground in its normal position; also called "ground angle."

minimum gliding angle—The acute angle between the horizontal and the most nearly horizontal path along which an airplane can descend steadily in still air when the propeller is producing no thrust.

rudder angle—The acute angle between the rudder and the plane of symmetry of the aircraft. It is positive when the trailing edge has moved to the left with reference to the normal position of the pilot.

trim angle—The angle between the horizontal and the longitudinal base line of a seaplane float or flying-boat hull. It is positive when the bow is higher than the stern.

zero-lift angle—The angle of attack of an airfoil when its lift is zero.

angle of attack—The acute angle between a reference line in a body and the line of the relative wind direction projected on a plane containing the reference line and parallel to the plane of symmetry. (See fig. 9.)

absolute angle of attack—The angle of attack of an airfoil, measured from the attitude of zero lift.

critical angle of attack—The angle of attack at which the flow about an airfoil changes abruptly as shown by corresponding abrupt changes in the lift and drag.

effective angle of attack—See ANGLE OF ATTACK FOR INFINITE ASPECT RATIO.

induced angle of attack—The difference between the actual angle of attack and the angle of attack for infinite aspect ratio of an airfoil for the same lift coefficient.

angle of attack for infinite aspect ratio—The angle of attack at which an airfoil produces a given lift coefficient in a two-dimensional flow. Also called "effective angle of attack."

angle of dead rise—The angle with the horizontal made by a transverse line joining the keel of a hull with the chine.

angle of heel—The angle between a horizontal plane and the lateral axis of a seaplane on the water.

angle of incidence—Same as ANGLE OF WING SETTING. In British terminology the angle of incidence is equivalent to the American term "angle of attack."

angle of pitch (aircraft)—The acute angle between two planes defined as follows: One plane includes the lateral axis of the aircraft and the direction of

the relative wind; the other plane includes the lateral axis and the longitudinal axis. The angle is positive when the nose of the aircraft is above the direction of the relative wind. (In normal flight the angle of pitch is the angle between the longitudinal axis and the direction of the relative wind.)

angle of pitch (propeller)—Same as ANGLE, BLADE.

angle of roll (or angle of bank)—The angle through which an aircraft must be rotated about its longitudinal axis in order to bring its lateral axis into the horizontal plane. The angle is positive when the left side is higher than the right.

angle of stabilizer setting—The acute angle between the longitudinal axis of an airplane and the chord of the stabilizer. The angle is positive when the leading edge is higher than the trailing edge. (See fig. 5.)

angle of wing setting—The acute angle between the plane of the wing chord and the longitudinal axis of the airplane. The angle is positive when the leading edge is higher than the trailing edge. (See fig. 5.)

angle of yaw—The acute angle between the direction of the relative wind and the plane of symmetry of an aircraft. The angle is positive when the aircraft turns to the right.

antidrag wire—See WIRE (AIRPLANE), ANTIDRAG.

appendix—The tube, usually located at the bottom of a balloon, used primarily for inflation and deflation. In the case of a free balloon it may also serve as an automatic-discharge opening. The term should be restricted to the various types of balloons and should not be applied to airships.

approach light—See LIGHT, APPROACH.

area, equivalent flat-plate—The area of a square flat plate, normal to the direction of motion, which offers the same amount of resistance to motion as the body or combination of bodies under consideration.

area, measurement of (performance calculations):

control-surface area, trailing—The area of a trailing control surface is the area of the actual outline projected on the plane of the surface, except that any portion of the movable surface lying forward of the hinge axis and within the fixed surface is included in the fixed surface. Auxiliary or paddle-type balance surfaces shielded by and lying outside of the fixed surface are not included in the area of either the fixed or the movable surfaces.

horizontal tail area—The horizontal tail area is measured in the same manner as the wing area, that is, with no deduction for the area blanketed by the fuselage, such blanketed area being bounded within the fuselage by lateral straight lines that connect the intersections of the leading and trailing edges of the stabilizer with the sides of the fuselage, the fairings and fillets being ignored.

area, measurement of—continued.

vertical tail area—The area of the actual outline of the rudder and the fin projected in the vertical plane, the fairings and fillets being ignored.

wing area—Wing area is measured from the projection of the actual outline on the plane of the chords, without deduction for area blanketed by fuselage or nacelles. That part of the area, so determined, which lies within the fuselage or nacelles is bounded by two lateral lines that connect the intersections of the leading and trailing edges with the fuselage or nacelle, ignoring fairings and fillets. For the purpose of calculating area, a wing is considered to extend without interruption through the fuselage and nacelles. Unless otherwise stated, wing area always refers to total area including ailerons.

area, projected propeller—Projected blade area times the number of blades.

area, projected propeller-blade—The projection of the propeller-blade area on a plane perpendicular to the axis of rotation of the propeller.

area, propeller—Blade area times the number of blades.

area, propeller-blade—The developed area of the blade face exclusive of the boss and the root; i.e., exclusive of that portion the thrust of which is negligible in comparison with the total thrust of the blade.

area, propeller-disk—The total area swept by a propeller; i.e., the area of a circle having the same diameter as the propeller.

arresting gear—The gear incorporated in aircraft and in the landing area to facilitate landing in a limited space.

artificial horizon—(1) A device that indicates the attitude of an aircraft with respect to the true horizon. (2) A substitute for a natural horizon, such as a liquid level, pendulum, or gyroscope, incorporated in a navigating instrument.

aspect ratio—The ratio of the span to the mean chord of an airfoil; i.e., the ratio of the square of the span to the total area of an airfoil.

effective aspect ratio—The aspect ratio of an airfoil of elliptical plan form that, for the same lift coefficient, has the same induced-drag coefficient as the airfoil, or the combination of airfoils, in question.

aspect ratio, propeller-blade—The ratio of the tip radius to the maximum blade width. (Obsolete.)

atmosphere:

altimeter-calibration standard atmosphere—A standard atmosphere used in calibrating aeronautic instruments. The standard now in use in the United States is completely defined in N.A.C.A. Report No. 246.

atmosphere—continued.

standard atmosphere—An arbitrary atmosphere used in comparing the performance of aircraft. The standard atmosphere in use in the United States at present represents very nearly the average conditions found at latitude 40° and is completely defined in N.A.C.A. Report No. 218.

standard international atmosphere—The atmosphere used as an international standard presumes for mean sea level and a temperature of 15° C., a pressure of 1,013.2 millibars, lapse rate of 6.5° C. per kilometer from sea level to 11 kilometers, and thereafter a constant temperature of -56.5° C.

attack, angle of—See ANGLE OF ATTACK.

attitude—The position of an aircraft as determined by the inclination of its axes to some frame of reference. If not otherwise specified, this frame of reference is fixed to the earth.

attitude of flight—Inclination of the three principal airplane axes to the relative wind.

autogiro—A type of rotor plane whose support in the air is chiefly derived from airfoils rotated about an approximately vertical axis by aerodynamic forces, and in which the lift on opposite sides of the plane of symmetry is equalized by the vertical oscillation of the blades.

automatic pilot—An automatic control mechanism for keeping an aircraft in level flight and on a set course. Sometimes called "gyro pilot," "mechanical pilot," or "robot pilot."

automatic propeller—See PROPELLER, AUTOMATIC.

aviation—The operation of aircraft heavier than air.

aviator—The pilot of an aircraft heavier than air.

axes of an aircraft—Three fixed lines of reference, usually centroidal and mutually perpendicular. The horizontal axis in the plane of symmetry, usually parallel to the axis of the propeller, is called the longitudinal axis; the axis perpendicular to this in the plane of symmetry is called the normal axis; and the third axis perpendicular to the other two is called the lateral axis. In mathematical discussions, the first of these axes, drawn from rear to front, is called the *X* axis; the second, drawn downward, the *Z* axis; and the third, running from left to right, the *Y* axis. (See page 32.)

axial cone—See CONE, AXIAL.

axis, elastic (stress analysis)—The locus of all points through which a force may be applied to a structure without causing torsional deflection.

axis, wing—The locus of the aerodynamic centers of all the wing sections.

backswept—See SWEEPBACK.

balance—A condition of steady flight in which the resultant force and moment on the airplane are zero.

balanced surface:

aerodynamic balanced surface—A control surface that extends on both sides of the axis of the hinge or pivot or that has auxiliary devices or extensions connected with it in such a manner as to effect a small or zero resultant moment of the air forces about the hinge axis.

static balanced surface—A control surface whose center of mass is in the hinge axis.

ballonet—A gas-tight compartment of variable volume constructed of fabric and placed within a balloon or airship. It is usually partly inflated with air to compensate for changes of volume in the gas contained in the envelope. (See figs. 3 and 4.)

ballonet ceiling—See CEILING, BALLONET.

balloon—An aerostat without a propelling system.

captive balloon—A balloon restrained from free flight by means of a cable attaching it to the earth.

ceiling balloon—A small free balloon, whose rate of ascent is known, used to determine the ceiling.

free balloon—A balloon, usually spherical, whose ascent and descent may be controlled by releasing ballast or gas and whose direction of flight is determined by the wind.

kite balloon—An elongated form of captive balloon, fitted with lobes to keep it headed into the wind; it usually derives increased lift from the inclination of its axis to the wind.

pilot balloon—A small balloon sent up to show the direction and speed of the wind.

sounding balloon—A small balloon used to send up a meteorograph.

balloon fabric—See FABRIC, BALLOON.

band:

mooring band—A band of tape or webbing, over the top of a kite balloon, to which the mooring ropes are attached. It forms part of the mooring harness.

suspension band—A horizontal fabric band, securely fastened to the envelope of a balloon or airship, to which are attached the main suspension lines of the basket or car, or the captive cable of a kite balloon.

trajectory band—A band of webbing carried in a special curve over the surface of the envelope of an airship to distribute the stresses due to the suspension of the car.

bank—The position of an airplane when its lateral axis is inclined to the horizontal. A right bank is the position with the lateral axis inclined downward to the right.

bank—To incline an airplane laterally; i.e., to rotate it about its longitudinal axis.

bank (or banking) indicator—See TURN-AND-BANK INDICATOR.

bar, rudder—See RUDDER BAR.

basic load—See LOAD, BASIC.

basin, towing—See TANK, SEAPLANE.

basket—The car suspended beneath a balloon for carrying passengers, ballast, etc.

basket suspension—See SUSPENSION BASKET.

beaching gear—An arrangement of wheels to be attached to the hull of a seaplane to permit handling ashore.

beacon—A light, group of lights, or other signaling device, indicating a location or direction.

airport beacon—A beacon light of high candlepower located at or near an airport for the purpose of indicating the general or specific location of the airport.

airway beacon—A beacon light of high candlepower, other than an airport or landmark beacon, located on or near an airway for the purpose of indicating the location of the airway.

auxiliary airport beacon—A beacon light, usually of lower candlepower than the main airport beacon light, located on the airport site to indicate the specific location of an airport that has a separate airport beacon visible at a greater distance to indicate the general location of the airport.

auxiliary airway beacon—A beacon light, usually of lower candlepower than the principal airway beacon lights, used to mark special features of the terrain along an airway or otherwise to supplement the principal airway beacons.

code beacon—A flashing beacon light having a recognizable characteristic of dots and/or dashes by which its individual identity can be established.

landmark beacon—A beacon light, other than an airport beacon or an airway beacon, that serves to indicate a definite geographical location.

beacon, radio-marker—See RADIO-DIRECTIVE DEVICES.

beacon, radio-range—See RADIO-DIRECTIVE DEVICES.

beam direction (stress analysis)—The direction parallel to the plane of the spar web and the plane of symmetry of an airplane (cf. *chord*, *drag*, *lift*, and *side directions*).

beam force or component (stress analysis)—A force, or component, in the beam direction; i.e., parallel to the plane of the spar web and the plane of symmetry of an airplane (cf. *chord*, *drag*, *lift*, and *side forces*).

bearing projector—A fixed directional projector used in conjunction with a landmark beacon to indicate the direction toward a landing area by means of the direction of its beam.

biplane—An airplane with two main supporting surfaces placed one above the other.

blade angle—See ANGLE, BLADE.

blade back—The side of a propeller blade that corresponds to the upper surface of an airfoil.

- blade element**—A portion of a propeller blade contained between the surfaces of two cylinders coaxial with the propeller cutting the propeller blades.
- blade face**—The surface of a propeller blade that corresponds to the lower surface of an airfoil. Sometimes called "thrust face" or "driving face."
- blade section**—A cross section of a propeller blade made at any point by a plane parallel to the axis of rotation of the propeller and tangent at the centroid of the section to an arc drawn with the axis of rotation as its center.
- blade-width ratio**—The ratio of the chord of a propeller blade section to the diameter of the propeller.
- mean blade-width ratio**—The ratio of the mean blade width to the diameter of the propeller.
- blast gate (supercharger)**—A device for controlling the pressure in the nozzle box of a turbosupercharger by discharging into the free atmosphere a portion of the exhaust gases that would otherwise pass through the turbine wheel.
- blimp**—A colloquial term for a nonrigid airship.
- blind flying**—See INSTRUMENT FLYING.
- blinker light**—See LIGHT, BLINKER.
- blister**—A sheet of clear water raised by the motion of a float or hull and separated from the free-water surface by an air space.
- boat, flying**—See FLYING BOAT.
- boom, tail**—See TAIL BOOM.
- boost**—To supply an engine with more air or mixture than it would normally induct at sea level.
- boost control, automatic**—An automatic regulator of boost pressure.
- booster magneto**—See MAGNETO, BOOSTER.
- boundary layer**—A layer of fluid, close to the surface of a body placed in a moving stream, in which the impact pressure is reduced as a result of the viscosity of the fluid.
- boundary light**—See LIGHT, BOUNDARY.
- bow cap**—See CAP, BOW.
- bowheavy**—The condition in which, in normal flight, the forward end of an airship tends to sink, and which requires correction by means of the horizontal controls. It may be due to either aerodynamic or static conditions, or to both (cf. *sternheavy*).
- bow-weighing device**—An instrument for measuring the horizontal and vertical forces between an airship and its mooring mast (cf. *stern-weighing device*).
- box girder**—See GIRDER, BOX.
- breathing**—The passage of air into or out of an aerostat, due to changing volume.
- bridle**—(a) A sling of cordage or cable which has its ends fixed at two different points, to the bight of which a single line may be attached, either movable or fixed, thus distributing the pull of the single line to two points or more in the case of a multiple bridle. (b) A towing or mooring line having two legs and intended to reduce yawing when towing or mooring.
- buffeting**—The repeated aerodynamic forces experienced by any part of an aircraft, caused and maintained by unsteady flow arising from a disturbance set up by any other part of the aircraft (cf. *flutter*).
- bump**—A sudden acceleration of an aircraft caused by a region of unstable atmosphere characterized by marked local vertical components in the air currents.
- bumper bag**—A cushion secured to the bottom of an airship to prevent damage when in contact with the ground. (See figs. 4 and 6.)
- buoyancy**:
- center of buoyancy (aerostat)**—The center of gravity of the air displaced by a balloon or airship. It is approximately the center of gravity of the contained gas.
- center of buoyancy (seaplane)**—The center of gravity of the fluid displaced.
- reserve buoyancy (excess buoyancy)**—The difference between the buoyancy of a completely submerged float and the buoyancy of the float when submerged to the normal-load water line, usually expressed as a percentage of the normal-load buoyancy.
- burble**—A term designating the breakdown of the streamline flow about a body.
- cabane**—An arrangement of struts used for bracing on an aircraft.
- cable**:
- axial cable**—The axial member sometimes fitted in a rigid airship. It is attached to the central fitting of the radial or diametral wires of each main transverse and to the hull structure at bow and stern.
- control cable**—The line of wire or stranded cable leading from the control levers to the control surfaces or interconnecting the control surfaces. (See fig. 5.)
- main mooring cable**—The wire cable by which an airship is hauled in to a mooring mast.
- camber**—The rise of the curve of an airfoil section, usually expressed as the ratio of the departure of the curve from a straight line joining the extremities of the curve to the length of this straight line. "Upper camber" refers to the upper surface; "lower camber" to the lower surface; and "mean camber" to the mean line of the section. Camber is positive when the departure is upward, and negative when it is downward. (See fig. 2.)
- canard airplane**—See AIRPLANE, CANARD.
- canopy, parachute**—The main supporting surface of a parachute.
- cap**:
- bow cap**—(1) A cap of metal or fabric used to reinforce the extreme forward end of a bow stiffener of a nonrigid or semirigid airship. (See figs. 3 and 4.) (2) The conical or cap-shaped structure at the extreme bow of a rigid

- airship to which the longitudinal girders are attached and which supports the bow mooring spindle. (See fig. 6.)
- capacity**—The volume of the gas cell or cells of an aerostat.
- nominal gas capacity**—The volume of the gas cell or cells of an aerostat under certain definite conditions of pressure and inflation.
- cap-strip**—A continuous member on the outer edge of a wing rib.
- captive balloon**—See **BALLOON, CAPTIVE**.
- car**—A structure in, or suspended from, the hull or envelope of an airship for carrying crew, engineers, passengers, etc. (See figs. 3 and 4.)
- side car**—A car suspended off the center line of an airship; also called "wing car."
- car, subcloud**—An observation car which may be lowered from an airship to a position below the clouds.
- card compass**—See **COMPASS, CARD**.
- catapult**—A device by which an airplane can be launched at flying speed.
- cat walk**—A narrow footway along the keel of a rigid airship.
- ceiling**—Height of the lower level of a bank of clouds above the ground.
- ceiling:**
- absolute ceiling**—The maximum height above sea level at which a given airplane would be able to maintain horizontal flight under standard air conditions.
- ballonet ceiling**—The altitude from which a pressure airship with empty ballonets can return to sea level without loss of operating pressure.
- service ceiling**—The height above sea level, under standard air conditions, at which a given airplane is unable to climb faster than a small specified rate (100 feet per minute in the United States and England). This specified rate may differ in different countries.
- static ceiling**—The altitude in standard atmosphere, at which an aerostat is in static equilibrium after removal of all dischargeable weight.
- ceiling balloon**—See **BALLOON, CEILING**.
- ceiling-height indicator**—A device that measures the height from the horizontal to the illuminated spot produced by a ceiling projector as seen from a fixed position.
- ceiling projector**—A projector that produces an illuminated region on the under side of a cloud for the purpose of determining the height of that part of the cloud above the indicator.
- cell, gas**—In an airship, one of the bags containing the aerostatic gas. (See figs. 4 and 6.)
- cellule (or cell)**—In an airplane, the entire structure of the wings and wing trussing of the whole airplane on one side of the fuselage, or between fuselages or nacelles, where there are more than one.
- center, aerodynamic**—See **AERODYNAMIC CENTER, WING SECTION**.
- center, elastic (stress analysis)**—A point within the wing section at which the application of a single concentrated load will cause the wing to deflect without rotation and, conversely, a point within the wing section about which rotation occurs when the wing is subjected to rotational deflection.
- center of buoyancy**—See **BUOYANCY, CENTER OF**.
- center of pressure of an airfoil**—The point in the chord of an airfoil, prolonged if necessary, which is at the intersection of the chord and the line of action of the resultant air force.
- center-of-pressure coefficient**—The ratio of the distance of the center of pressure from the leading edge to the chord length.
- center section**—The central panel of a wing; in the case of a continuous wing or any wing having no central panel, the limits of the center section are arbitrarily defined by the location of points of attachment to the cabane struts or fuselage.
- centrifugal-type supercharger**—See **SUPERCHARGER, CENTRIFUGAL-TYPE**.
- chandelle**—An abrupt climbing turn to approximately a stall in which the momentum of the airplane is used to obtain a higher rate of climb than would be possible in unaccelerated flight. The purpose of this maneuver is to gain altitude at the same time that the direction of flight is changed (fig. 8).
- chine**—The intersection of the bottom with the sides or deck of a seaplane float.
- chord**—An arbitrary datum line from which the ordinates and angles of an airfoil are measured. It is usually the straight line tangent to the lower surface at two points, the straight line joining the ends of the mean line, or the straight line between the leading and trailing edges. (See figs. 2 and 5.)
- chord, mean aerodynamic**—The chord of an imaginary airfoil which would have force vectors throughout the flight range identical with those of the actual wing or wings.
- chord, mean, of a wing**—The quotient obtained by dividing the wing area by the span.
- chord direction (stress analysis)**—The direction parallel to the intersection of the plane of the internal wing truss with the plane of symmetry of the airplane. When a wing has two internal trusses in nonparallel planes, the plane bisecting the dihedral angle between those two planes should be used (cf. *beam, drag, lift, and side directions*).
- chord force, or component (stress analysis)**—A force, or component, in the chord direction; i.e., parallel to the intersection of the plane of the internal wing truss with the plane of symmetry of the airplane (cf. *beam, drag, lift, and side forces*).
- chord length**—The length of the projection of the airfoil profile on its chord.

cockpit—An open space in an airplane for the accommodation of pilots or passengers. When completely enclosed, such a space is usually called a cabin. (See fig. 5.)

column, control—See CONTROL COLUMN.

compass:

card (or card magnetic) compass—A magnetic compass in which the magnets are attached to a pivoted card on which the directions are marked.

earth-inductor (or induction) compass—A compass the indications of which depend on the current generated in a coil revolving in the earth's magnetic field.

sun compass—A compass in which the direction of the sun is utilized instead of the direction of the magnetic north or south pole.

compression-ignition engine—See ENGINE, COMPRESSION-IGNITION.

compression ratio—The ratio of the volume of the gas in an engine cylinder at the beginning of the compression stroke to its volume at the end of the stroke.

cone:

axial cone—(1) The cone-shaped fabric fitting, in the end of a gas cell of a rigid airship, which provides a gas-tight connection of the cell to the axial cable and yet permits the cell some degree of freedom in its movements. (2) A special form of conical sleeve.

danger cone—A pennant or a hollow cone of light cloth on the wire cable of a captive balloon to warn aircraft of its presence.

entrance cone—That portion of a wind tunnel from which the air flows to the experiment chamber. (See fig. 7.)

exit cone—That portion of a wind tunnel into which the air flows from the experiment chamber. (See fig. 7.)

mooring cone—The grooved conical member at the extreme bow of an airship which engages with a hollow cone at the top of the mooring mast and provides the coupling between the airship and the mooring mast. (See fig. 6.)

wind cone—A tapered fabric sleeve pivoted on a standard to indicate the wind direction.

coning angle—See ANGLE, CONING.

control cable—See CABLE, CONTROL.

control column—A lever having a rotatable wheel mounted at its upper end for operating the longitudinal and lateral control surfaces of an airplane. This type of control is called "wheel control."

control, servo—A control devised to reinforce the pilot's effort by an aerodynamic or mechanical relay.

controllability—The quality of an aircraft that determines the ease of operating its controls and/or the effectiveness of displacement of the controls in producing change in its attitude in flight.

controllable propeller—See PROPELLER, CONTROLLABLE.

controls—A general term applied to the means provided to enable the pilot to control the speed, direction of flight, attitude, power, etc., of an aircraft.

control stick—The vertical lever by means of which the longitudinal and lateral control surfaces of an airplane are operated. The elevator is operated by a fore-and-aft movement of the stick; the ailerons, by a side-to-side movement. (See fig. 5.)

control surface—A movable airfoil designed to be rotated or otherwise moved by the pilot in order to change the attitude of the aircraft.

control-surface area, trailing—See AREA, MEASUREMENT OF.

cord, rip—See RIP CORD.

course light—See LIGHT, COURSE.

cove—The line of intersection between two surfaces of a hull, the vertex of the angle of intersection pointing inward.

cowling—A removable covering.

cockpit cowling—A metal or plywood cowling placed around a cockpit.

engine cowling—A removable covering placed around all or part of an airplane engine.

N.A.C.A. cowling—A cowling enclosing a radial air-cooled engine, consisting of a hood, or ring, and a portion of the body behind the engine so arranged that the cooling air smoothly enters the hood at the front and leaves through a smooth annular slot between the body and the rear of the hood; the whole forming a relatively low-drag body with a passage through a portion of it for the cooling air.

cowling, ring—See RING COWLING.

cradle:

building cradle—A support provided for the frame of a rigid airship or the keel of a semi-rigid airship during construction.

docking cradle—A support for the car of an airship while it is being inflated in the shed; mostly used with rigid airships.

crew, landing (or ground)—A detail of men necessary for the landing and handling of an airship on the ground.

critical altitude—See ALTITUDE, CRITICAL.

critical angle of attack—See ANGLE OF ATTACK, CRITICAL.

cross-wind force—The component perpendicular to the lift and to the drag of the total air force on a body.

crow'sfoot—(1) A system of diverging short ropes for distributing the pull of a single rope. (2) An arrangement in which the strands of a cord are opened out so that they can be effectively cemented to a fabric surface.

cyclogiro—A type of rotor plane whose support in the air is normally derived from airfoils mechanically rotated about an axis perpendicular to the plane of symmetry of the aircraft, the angle of attack of the

- airfoils being always less than the angle at which the airfoils stall.
- dead rise**—In a cross section of a float or flying-boat hull, the amount by which the height of the chine differs from that of the keel.
- dead rise, angle of**—See ANGLE OF DEAD RISE.
- decalage**—The difference between the angular settings of the wings of a biplane or multiplane. The decalage is measured by the acute angle between the chords in a plane parallel to the plane of symmetry. The decalage is considered positive if the upper wing is set at the larger angle. (See fig. 5.)
- deflation sleeve**—See SLEEVE, DEFLATION.
- density altitude**—See ALTITUDE, DENSITY.
- derivatives, resistance**—Quantities expressing the variation of the forces and moments on aircraft due to disturbance of steady motion. They form the experimental basis of the theory of stability, and from them the periods and damping factors of aircraft can be calculated. In the general case there are 18 translatory and 18 rotary derivatives.
- lateral resistance derivatives**—Resistance derivatives expressing the variation of moments and forces due to small changes in the lateral, yawing, and rolling velocities.
- longitudinal resistance derivatives**—Resistance derivatives expressing the variation of moments and forces due to small changes in the longitudinal, normal, and pitching velocities.
- rotary resistance derivatives**—Resistance derivatives expressing the variation of moments and forces due to small changes in the rotational velocities of the aircraft.
- translatory resistance derivatives**—Resistance derivatives expressing the variation of moments and forces due to small changes in the translational velocities of the aircraft.
- design load**—See LOAD, DESIGN.
- diaphragm, ballonnet**—The fabric partition between the gas and air compartments of the envelope of a nonrigid or semirigid airship or kite balloon.
- differential aileron linkage arrangement**—See AILERON LINKAGE ARRANGEMENTS.
- dihedral angle**—See ANGLE, DIHEDRAL.
- directional gyro**—A gyroscopic instrument for indicating direction, containing a free gyroscope which holds its position in azimuth and thus indicates angular deviation from the course.
- directional stability**—See STABILITY, DIRECTIONAL.
- discharge header**—The duct through which the air is conducted from the supercharger to the engine.
- displacement, engine**—The total volume swept by the pistons of all the cylinders during one complete stroke of each piston.
- displacement, float or hull**—The total volume, or total weight, of water displaced by a seaplane float or hull.
- dive**—A steep descent, with or without power, in which the air speed is greater than the maximum speed in horizontal flight.
- dive (stress analysis)**—A design condition for the wings representing a steady state of flight characterized by high speed and an angle of attack approximately that of zero lift (cf. *inverted flight* and *pull-up, sudden*).
- dock**—A large shed used for housing airships.
- dock**—To haul an airship into its dock.
- dope**:
- airplane dope**—The liquid material applied to the fabric surfaces of airplanes to increase their strength, to produce tautness by shrinking, and to act as a filler for maintaining airtightness.
- fuel dope**—Any material added to the fuel in small quantities for the purpose of preventing detonation.
- downwash**—The air deflected perpendicular to the direction of motion of an airfoil.
- downwash angle**—See ANGLE, DOWNWASH.
- drag**—The component of the total air force on a body parallel to the relative wind. (See fig. 9.)
- induced drag**—That part of the drag induced by the lift.
- parasite drag**—That portion of the drag of an aircraft exclusive of the induced drag of the wings.
- profile drag**—The difference between the total wing drag and the induced drag.
- profile drag, effective**—The difference between the total wing drag and the induced drag of a wing with the same geometric aspect ratio but elliptically loaded.
- drag direction (stress analysis)**—The direction of the relative wind (cf. *beam, chord, lift, and side directions*).
- drag force, or component (stress analysis)**—A force, or component, in the drag direction; i.e., parallel to the relative wind (cf. *beam, chord, lift, and side forces*).
- drag rope**—A long rope which can be hung overboard from a balloon so as to act as a brake and a variable ballast in making a landing. Sometimes called "trail rope" or "guide rope."
- drag strut**—A fore-and-aft compression member of the internal bracing system of an aircraft. (See fig. 5.)
- drift angle**—See ANGLE, DRIFT.
- drip flap**—A strip of fabric attached by one edge to the envelope of an aerostat so that rain runs off its free edge instead of dripping into the basket or car. It also assists in keeping the suspension ropes dry and nonconducting. Also called "drip band" or "drip strip."
- dry weight of an engine**—See ENGINE, DRY WEIGHT OF.
- dynamic factor (stress analysis)**—The ratio between the load carried by any part of an aircraft when accelerating and the corresponding basic load.

dynamic load—See **LOAD, DYNAMIC**.

dynamic pressure—The product $\frac{1}{2}\rho V^2$, where ρ is the density of the air and V is the relative speed of the air.

dynamic stability—See **STABILITY, DYNAMIC**.

dynamometer, hub—A device built into a propeller hub for measuring the engine thrust and/or torque.

earth-inductor compass—See **COMPASS, EARTH-INDUCTOR**.

edge, leading—See **LEADING EDGE**.

edge, trailing—See **TRAILING EDGE**.

efficiency, propeller—See **PROPELLER EFFICIENCY**.

efficiency, propulsive—See **PROPULSIVE EFFICIENCY**.

elastic center—See **CENTER, ELASTIC**.

elevator—A movable auxiliary airfoil, the function of which is to impress a pitching moment on the aircraft. It is usually hinged to the stabilizer. (See figs. 3, 4, 5, and 6.)

elevator angle—See **ANGLE, ELEVATOR**.

emergency flotation gear—A device attached to a landplane to provide buoyancy in case of an emergency landing on the water.

empennage—See **TAIL, AIRPLANE**.

engine:

axial-type engine—An engine having its cylinders equidistant from and parallel to the main shaft. Power is transmitted to the shaft through a wobble plate, swash plate, or gears.

cam engine—A type of engine in which the pistons are reciprocated by means of a cam-and-roller mechanism.

compression-ignition engine—A type of engine in which the fuel is sprayed into the cylinder and ignited by the heat of compression of the air charge.

double-row radial engine—An engine having two rows of cylinders arranged radially around a common crankshaft. The corresponding front and rear cylinders may or may not be in line.

left-hand engine—An engine whose propeller shaft, to an observer facing the propeller from the engine end of the shaft, rotates in a counter-clockwise direction.

right-hand engine—An engine whose propeller shaft, to an observer facing the propeller from the engine end of the shaft, rotates in a clockwise direction.

supercharged engine—An engine with a compressor for increasing the air or mixture charge taken into the cylinder beyond that inducted normally at the existing atmospheric pressure.

engine, dry weight of an—The weight of an engine exclusive of fuel, oil, and liquid coolant.

engine weight per horsepower—The dry weight of an engine divided by the rated horsepower.

entrance cone—See **CONE, ENTRANCE**.

envelope—(1) The outer covering of an aerostat, usually of fabric. (2) The bag containing the aerostatic gas of a free balloon, kite balloon, or non-rigid airship. (See fig. 3.)

equivalent monoplane—A monoplane wing equivalent as to its lift and drag properties to any combination of two or more wings.

exhaust-collector ring—A circular duct into which the exhaust gases from the cylinders of a radial engine are discharged.

exit cone—See **CONE, EXIT**.

experiment (or test) chamber—The central portion of a wind tunnel, where aircraft models or other objects are tested.

fabric:

balloon fabric—The finished material, usually rubberized, of which balloon or airship envelopes are made.

gas-cell fabric—The fabric used in making gas cells for rigid airships.

goldbeaters-skin fabric—A fabric consisting of a layer of light, fine, strong cloth, usually cotton, to which one or more layers of goldbeaters skin have been cemented.

factor, dynamic—See **DYNAMIC FACTOR**.

factor, load—See **LOAD FACTOR**.

factor of safety (stress analysis)—The ratio of the ultimate load to any applied load. This term usually refers to the probable minimum factor of safety, which is the ratio of the ultimate load to the probable maximum applied load.

fairing—An auxiliary member or structure whose primary function is to reduce the drag of the part to which it is fitted.

feather—In rotary wing systems, to periodically increase and decrease the incidence of a blade or wing by oscillating the blade or wing about its span axis.

fin—A fixed or adjustable airfoil, attached to an aircraft approximately parallel to the plane of symmetry, to afford directional stability; for example, tail fin, skid fin, etc. (See figs. 3, 4, and 5.)

fin carrier—A frame to which the inboard edge of the fin of a nonrigid or semirigid airship is attached, so as to prevent the edge of the fin from sinking into the envelope.

fineness ratio—The ratio of the length to the maximum diameter of a streamline body, as an airship hull.

fishtail—A colloquial term describing the motion made when the tail of an airplane is swung from side to side to reduce speed in approaching the ground for a landing.

fitting—A generic term for any small part used in the structure of an airplane or airship. If without qualification, a metal part is usually understood. It may refer to other parts, such as fabric fittings.

fixed light—See LIGHT, FIXED.

flap—A hinged or pivoted airfoil forming the rear portion of an airfoil, used to vary the effective camber.

split flap—A hinged plate forming the rear upper or lower portion of an airfoil. The lower portion may be deflected downward to give increased lift and drag; the upper portion may be raised over a portion of the wing for the purpose of lateral control (cf. *upper-surface aileron*).

flap, drip—See DRIP FLAP.

flap, pressure—See PRESSURE FLAP.

flapping angle—See ANGLE, FLAPPING.

flare:

parachute flare—A pyrotechnic device attached to a parachute and designed to illuminate a large area when released from an aircraft at an altitude.

signal flare—A pyrotechnic signaling device of distinctive color and characteristics.

wing-tip flare—A pyrotechnic device attached to an aircraft for illuminating the ground while landing.

flat-plate area, equivalent—See AREA, EQUIVALENT FLAT-PLATE.

flat spin—See SPIN, FLAT.

flight path—The flight path of the center of gravity of an aircraft with reference to the earth, or with reference to a frame fixed relative to the air. (See fig. 9.)

flight-path angle—See ANGLE, FLIGHT-PATH.

float—A completely enclosed watertight structure attached to an aircraft to give it buoyancy and stability when in contact with water.

float, inboard stabilizing—A stabilizing float placed relatively close to the main float or hull.

float, outboard (or wing-tip) stabilizing—A stabilizing float placed relatively far out from the main float or hull, usually at or very near the tip of the wing.

float, single—A single central float fitted under a seaplane and usually requiring two stabilizing floats to give adequate stability and complete the float system.

float, stabilizing (or side)—A float used in addition to a single float or hull and intended to provide lateral stability while the seaplane or flying boat is at rest on the water.

float system—The complete system of permanent floats, used to give buoyancy and stability to a seaplane or a flying boat while it is at rest on the water, and to provide hydrodynamic lift while it is taking off.

floating aileron linkage arrangement—See AILERON LINKAGE ARRANGEMENTS.

floodlight, landing-area—A device designed to illuminate the surface of a landing area.

floodlight system, landing-area—A complete installation of floodlighting equipment designed to illuminate a landing area.

flotation gear—See EMERGENCY FLOTATION GEAR.

flow:

laminar flow—A particular type of streamline flow. The term is usually applied to the flow of a viscous liquid near solid boundaries, when the flow is not turbulent.

streamline flow—A fluid flow in which the streamlines, except those very near a body and in a narrow wake, do not change with time.

turbulent flow—Any part of a fluid flow in which the velocity at a given point varies more or less rapidly in magnitude and direction with time.

flutter—An oscillation of definite period but unstable character set up in any part of an aircraft by a momentary disturbance, and maintained by a combination of the aerodynamic, inertial, and elastic characteristics of the member itself (cf. *buffeting*).

fly—(1) To operate an aircraft in flight. (2) To ride as a passenger in an aircraft.

flying boat—A form of seaplane whose main body or hull provides flotation.

frame, field handling—A portable frame which may be attached to an airship when it is on the ground and which is intended to provide a hold for more men than could grasp the handling rails of the cars. (See fig. 6.)

framing, stern—All framework, aft of the cruciform girder, necessary to complete the shape and contour of a rigid airship.

free balloon—See BALLOON, FREE.

free-balloon net—See NET, FREE-BALLOON.

Frise aileron—See AILERON, FRISE.

fuel bypass regulator—See REGULATOR, FUEL BYPASS.

fuselage—The body, of approximately streamline form, to which the wings and tail unit of an airplane are attached. (See fig. 5.)

monocoque fuselage—A fuselage construction which relies on the strength of the skin or shell to carry either the shear or the load due to bending moments. Monocoques may be divided into three classes (reinforced shell, semi-monocoque, and monocoque), and different portions of the same fuselage may belong to any one of these classes. The reinforced shell has the skin reinforced by a complete framework of structural members. The semimonocoque has the skin reinforced by longerons and vertical bulkheads, but has no diagonal web members. The monocoque has as its only reinforcement vertical bulkheads formed of structural members.

gap—The distance separating two adjacent wings of a multiplane. (See fig. 5.)

gas—To replenish a balloon with fresh gas, in order to increase the purity, or to make up for a loss of gas.

gas-cell fabric—See FABRIC, GAS-CELL.

gas-cell net—See NET, GAS-CELL.

gassing factor—The quantity of aerostatic gas required to maintain an aerostat for one year. It is ordinarily expressed as a percentage of the gas volume.

geared propeller—See PROPELLER, GEARED.

geometrical pitch of a propeller—See PITCH OF A PROPELLER, GEOMETRICAL.

get-away speed—See SPEED, GET-AWAY.

girder:

box girder—Any built-up girder of rectangular section. Frequently used for the rectangular longitudinal members in the keel of a rigid airship from which the fuel tanks and gas cells are suspended.

cruciform girder—The structure, consisting of vertical and horizontal transverse girders, fitted at the stern of a rigid airship for the purpose of supporting the inboard ends of the sternposts of the fins or of the rudder posts.

walkway girder—A girder supporting a walkway along the keel or other part of a rigid or semi-rigid airship.

gland—A short tube fitted to an envelope or gas bag so that a rope or line may slip through it without leakage of gas or air. (See fig. 4.)

glide—To descend at a normal angle of attack with little or no thrust.

glide landing—See LANDING, GLIDE.

glider—An aircraft heavier than air, similar to an airplane but without a power plant.

primary-type glider—A ruggedly built glider designed for use in elementary training of student glider pilots.

secondary-type glider—A glider designed to have better aerodynamic performance than the primary type, but rugged enough for the use of pilots with limited training.

performance-type glider—A glider having a high degree of aerodynamic refinement and low minimum sinking speed.

gliding angle—See ANGLE, GLIDING.

goldbeaters-skin fabric—See FABRIC, GOLDBEATERS-SKIN.

ground angle—Same as LANDING ANGLE.

ground gear—The gear, or equipment, necessary for the landing and handling of an airship on the ground.

ground loop—An uncontrollable violent turn of an airplane while taxiing, or during the landing or take-off run.

ground speed—See SPEED, GROUND.

guide rope—See DRAG ROPE.

gyro, directional—See DIRECTIONAL GYRO.

gyro horizon—A gyroscopic instrument that indicates the lateral and longitudinal attitude of the airplane by simulating the natural horizon.

gyro pilot—See AUTOMATIC PILOT.

gyroplane—A type of rotor plane whose support in the air is chiefly derived from airfoils rotated about an approximately vertical axis by aerodynamic forces, and in which the lift on opposite sides of the plane of symmetry is equalized by rotation of the blades about the blades' axes.

hangar—A shelter for housing airplanes.

head, air-speed—See AIR-SPEED HEAD.

heaviness, nose—See NOSEHEAVY.

heaviness, stern—See STERNHEAVY.

heaviness, tail—See TAILHEAVY.

heaviness, wing—See WINGHEAVY.

height, pressure—The altitude at which the gas cells of a rigid airship or the gas bag of a nonrigid airship are completely full of gas.

helicopter—A type of rotor plane whose support in the air is normally derived from airfoils mechanically rotated about an approximately vertical axis.

honeycomb—A grid of intersecting surfaces used to check lateral disturbances in a fluid stream. (See fig. 7.)

hood:

gas-shaft hood—A hood, or cowl, located on the outer cover of a rigid airship at the outer end of a gas shaft.

maneuvering-valve hood—A hood, or cowl, located on the outer cover of a rigid airship just over a maneuvering valve. It is usually made of light wood or fabric and is faced to facilitate the escape of gas.

valve hood—The appliance, having the form of a hood or parasol, which protects the valve of an airship or balloon against rain; also called "valve cover" or "bonnet." (See fig. 4.)

hood, N.A.C.A.—The ring portion of an N.A.C.A. cowling.

hook, arresting—A hook attached to an airplane which engages the arresting gear in landing.

horizon, artificial—See ARTIFICIAL HORIZON.

horn—A short lever attached to a control surface of an aircraft, to which the operating wire or rod is connected. (See fig. 5.)

horsepower of an engine, rated—The average horsepower developed by a given type of engine at the rated speed when operating at full throttle, or at a specified altitude or manifold pressure.

hub dynamometer—See DYNAMOMETER, HUB.

hull:

airship hull—The main structure of a rigid airship, consisting of a covered elongated framework which incloses the gas cells and supports the cars and other equipment.

seaplane hull—That portion of a flying boat which furnishes buoyancy when in contact with the

- surface of the water. It contains accommodations for the crew and passengers, usually combining the functions of both float and fuselage.
- hump speed**—See **SPEED, HUMP**.
- hydrofoil (or hydrovane)**—Any surface designed to obtain reaction from the water through which it moves.
- hydroplane**—See **PLANE**.
- identification light**—See **LIGHT, IDENTIFICATION**.
- Immelman turn, normal**—A maneuver made by completing the first half of a normal loop; from the inverted position at the top of the loop, half-rolling the airplane to the level position, thus obtaining a 180° change in direction simultaneously with a gain in altitude. (See fig. 8.)
- impact pressure**—The pressure acting at the forward stagnation point of a body, such as a pitot tube, placed in an air current. Impact pressure may be measured from an arbitrary datum pressure.
- incidence, angle of**—See **ANGLE OF WING SETTING**.
- inclinometer**—An instrument that measures the attitude of an aircraft with respect to the horizontal.
- induced drag**—See **DRAW, INDUCED**.
- induction compass**—See **COMPASS, EARTH-INDUCTOR**.
- induction system, rotary**—A carburetor induction system used on radial engines, in which a rotary fan assists in distributing the fuel charge to the cylinders.
- inflation net**—See **NET, INFLATION**.
- inflation sleeve**—See **SLEEVE, INFLATION**.
- inflow**—The flow of air into a propeller.
- instability, spiral**—A type of instability, inherent in certain airplanes, which becomes evident when the airplane assumes too great a bank and sideslips; the bank continues to increase and the radius of the turn to decrease.
- instrument flying**—The art of controlling an aircraft solely by the use of instruments; sometimes called "blind flying."
- intake header**—A short duct extending from outside the engine cowling to the supercharger intake.
- interceptor**—A lateral-control device consisting of a small plate placed just back of a wing slot to spoil the effect of the slot at high angles of attack. (See fig 1.) (Cf. *spoiler*.)
- interference**—The aerodynamic influence of two or more bodies on one another.
- inverted flight (stress analysis)**—A loading condition for the wings simulating the conditions of flying upside down and of commencing a dive (cf. *dive (stress analysis)*.)
- jackstay**—A longitudinal rigging provided to maintain the correct distance between various parts in the fittings of an aerostat.
- keel, airship**—The assembly of members at the bottom of the hull of a semirigid or rigid airship, which provides special strength to resist hogging and sagging and also serves to distribute the effect of concentrated loads along the hull. (See fig. 4.)
- kite balloon**—See **BALLOON, KITE**.
- laminar flow**—See **FLOW, LAMINAR**.
- landing**—The act of terminating flight in which the aircraft is made to descend, lose flying speed, establish contact with the ground, and finally come to rest.
- glide landing**—A landing in which a steady glide is maintained to the landing surface without the usual leveling-off before contact.
- level landing (stress analysis)**—A loading condition for the fuselage and landing gear, representing a two-point landing with the fuselage horizontal.
- normal (or three-point) landing**—A landing in which a path tangential to the landing surface and the loss in flying speed are attained at approximately the instant of contact.
- pancake landing**—A landing in which the leveling-off process is carried out several feet above the ground, as a result of which the airplane settles rapidly on a steep flight path in a normal attitude.
- three-point landing (stress analysis)**—A loading condition for the fuselage and landing gear, representing landing with the wheels and tail skid touching the ground simultaneously (cf. *level landing*).
- landing angle**—See **ANGLE, LANDING**.
- landing area, effective**—That portion of the landing area, with approaches clear within the allowable safe climbing and gliding angle, available for the take-off and landing of aircraft.
- landing-direction light**—See **LIGHT, LANDING-DIRECTION**.
- landing field**—Any area of land designed for the take-off and landing of aircraft. It may or may not be part of an airport.
- landing gear**—The understructure which supports the weight of an aircraft when in contact with the land or water and which usually contains a mechanism for reducing the shock of landing. Also called "undercarriage." (See fig. 5.)
- retractable landing gear**—A type of landing gear which may be withdrawn into the body or wings of an airplane while it is in flight, in order to reduce the parasite drag.
- landing light**—See **LIGHT, LANDING**.
- landing strip**—A narrow and comparatively long area forming part of a landplane airport or of an intermediate or auxiliary field, which is suitable for the landing and take-off of airplanes under ordinary weather conditions.
- landplane**—An airplane designed to rise from and alight on the land.
- lateral axis**—See **AXES OF AN AIRPLANE**.
- leading edge**—The foremost edge of an airfoil or propeller blade.
- length, chord**—See **CHORD LENGTH**.

level landing—See LANDING, LEVEL.

level-off—To make the flight path of an airplane horizontal after a climb, glide, or dive.

lift:

aerostatic lift—The difference between the weight of a volume of air and of an equal volume of a gas lighter than air under given conditions.

dynamic lift—The component of the total aerodynamic force on a body perpendicular to the relative wind. (See fig. 9.)

gross lift (aerostat)—The buoyancy under standard conditions of density, purity, and fullness.

useful lift (aerostat)—The lift available for carrying passengers, fuel, oil, supplies, cargo, etc. It is the difference between the gross lift and the fixed weight of an aerostat.

lift direction (stress analysis)—The direction in the plane of symmetry perpendicular to the relative wind (cf. *beam*, *chord*, *drag*, and *side directions*).

lift/drag ratio—The ratio of the lift to the drag of any body.

lift force, or component (stress analysis)—A force, or component, in the lift direction (cf. *beam*, *chord*, *drag*, and *side forces*).

light:

anchor light—A light, or group of clear lights carried on an aircraft to indicate its position at night while at anchor.

approach light—A light, usually green, designed to indicate a favorable direction of approach for landing an aircraft.

blinker light—A flashing light giving more than 20 flashes per minute.

boundary light—Any one of the lights designed to indicate the limits of the landing area of an airport or landing field.

ceiling light—Same as CEILING PROJECTOR.

course light—A light projected along the course of an airway so as to be visible chiefly from points on or near the airway.

fixed light—A light which is constant in luminous intensity with respect to both time and direction.

flashing light—A light which is intermittent as viewed from a single direction.

identification light—A group of lights, clear and colored, carried on the rear part of an airplane for identification at night.

landing-direction light—A light designed to indicate, either by itself or in conjunction with other lights, the direction in which landings are to be made.

landing light—A light carried by an aircraft to illuminate the ground while landing.

navigation light—Same as POSITION LIGHT.

obstruction light—A red light designed to indicate the position and height of an object hazardous to the operation of aircraft.

light—continued.

position light—Any one of a group of lights—red, green, and clear—used aboard an aircraft to indicate its position and direction of motion.

line:

control line—One of the lines leading from the control car or compartment to the various parts of an airship and operating (either through mechanisms or directly) the rudders, valves, etc., which control the speed, altitude, etc., of the airship.

handling line (aerostat)—A line attached to the side of an airship or balloon for use by the ground crew in handling the aerostat. (See fig. 3.)

handling line (airplane)—Two lines of steel strand attached to the upper wings of a seaplane for steadying it when hauled out of the water aboard ship.

main mooring line—The line dropped from the bow of an airship to be coupled to the main mooring-mast line.

main mooring-mast line—A line leading from the main winch of a mooring mast through the mooring attachment at the top of the mast for the purpose of attaching the main mooring line of an airship.

mast yaw line—One of the two lines leading from the winches at the base of the mooring mast through snatch blocks and carried to the leeward of the mast 60° from the wind direction. The airship's yaw lines are coupled to these lines. The snatch blocks are fixed to anchorages selected so that the joined lines tend to keep the bow of the airship into the wind and prevent its overriding the mast. These lines are sometimes called "mast yaw guys" or "mast bow-steadying lines." (The main mooring line and the yaw guys, when taut, establish a fixed point in space.)

mooring line—A line attached near the bow of an aircraft for securing it to the ground, buoy, anchor, or to a mooring mast.

sandbag line—A rope extending along the line of suspension ropes or bridles of a kite balloon to which are hooked the sandbags used in mooring the balloon. The purpose is to prevent wear on the suspension cordage.

shroud line—The suspension cords of a parachute which attach the harness to the canopy.

suspension line—A line attached to the hull or envelope of an airship for supporting an appendage, such as a car or fin.

yaw line—A line dropped from the bow of an airship, when mooring to the mast, to be coupled to the mast yaw line and act as a steadying line to prevent yawing and overriding the mast.

load:

basic load (stress analysis)—The load on a structural member or part in any condition of static equilibrium of an airplane. When a specific basic load is meant, the particular condition of equilibrium must be indicated in the context.

design load (stress analysis)—A specified load below which a structural member or part should not fail. It is the probable maximum applied load multiplied by the factor of safety. Also, in many cases, an appropriate basic load multiplied by a design load factor.

full load—Weight empty plus useful load; also called *gross weight*.

normal load (stress analysis)—The load on that part of a wing assumed to be unaffected by tip losses or similar corrections. In any given case, it may be a basic, design, gross, net, or ultimate load, depending on the context.

pay load—That part of the useful load from which revenue is derived, viz, passengers and freight.

ultimate load (stress analysis)—The load that causes destructive failure in a member during a strength test, or the load that, according to computations, should cause destructive failure in the member.

useful load—The crew and passengers, oil and fuel, ballast other than emergency, ordnance, and portable equipment.

load factor (stress analysis)—The ratio of two loads (the second being a basic load) that have the same relative distribution. The first load may be the load applied during some special maneuver, the maximum probable load on the airplane or part, the design load, or the ultimate load. Whenever a load factor is mentioned, the context should indicate clearly what load is being compared with the basic load. If the context does not so indicate, the load factor is usually the ratio of the design load to the weight of the airplane.

loading:

power loading—The gross weight of an airplane divided by the rated horsepower of the engine computed for air of standard density, unless otherwise stated.

span loading—The ratio of the weight of an airplane to its equivalent monoplane span.

unsymmetrical loading (stress analysis)—A design loading condition for the wings and connecting members, representing the conditions as in a roll.

wing loading—The gross weight of an airplane divided by the wing area.

longeron—A principal longitudinal member of the framing of an airplane fuselage or nacelle, usually continuous across a number of points of support. (See fig. 5.)

longitudinal:

intermediate longitudinal—A light longitudinal girder between main longitudinals of a rigid airship, primarily intended for support of the outer cover.

main longitudinal—A main longitudinal strength member of a rigid airship, which connects the various transverse frames. (See fig. 6.)

loop—A maneuver executed in such a manner that the airplane follows a closed curve approximately in a vertical plane.

inverted normal loop—A loop starting from inverted flight and passing successively through a dive, normal flight, climb, and back to inverted flight.

inverted outside loop—An outside loop starting from inverted flight and passing successively through a climb, normal flight, dive, and back to inverted flight.

normal loop—A loop starting from normal flight and passing successively through a climb, inverted flight, dive, and back to normal flight. (See fig. 8.)

outside loop—A loop starting from normal flight and passing successively through a dive, inverted flight, climb, and back to normal flight, the pilot being on the outside of the flight path.

loop, ground—See GROUND LOOP.

loop, radio—A specified number of turns of wire located in the wings or wound around the fuselage of an airplane. Small portable loops on a rectangular frame are also used.

loop, safety—A loop formed in a rip cord of an aerostat and attached to a securing patch by a breakable cord or a spring clip.

loop, sandbag—A system of cordage loops on the envelope of a balloon for suspending sandbags.

magneto, booster—An auxiliary magneto used for starting.

maneuver—(a) To operate an aircraft in a skillful manner, so as to cause it to perform evolutions out of the ordinary. (b) To perform tactical or acrobatic evolutions with aircraft.

maneuverability—That quality in an aircraft which determines the rate at which its attitude and direction of flight can be changed.

maneuvering valve—See VALVE, MANEUVERING.

manhole, appendix—A short appendix of large diameter used for access to the interior of the envelope of an aerostat.

manometer pressure (aerostat)—See PRESSURE, MANOMETER.

margin of safety (stress analysis)—The difference between the ultimate load and any applied load.

marker, boundary—A painted cone, solid circle, disk, or other device used to mark the boundary of the available landing area on an airport or landing field.

marker, circle—A circular band marking the approximate center of the landing area or the intersection of the principal landing strips on an airport or landing field.

mast, mooring—See **MOORING MAST**.

mast, radio—See **RADIO MAST**.

mean line (of an airfoil profile)—An intermediate line between the upper and lower contours of the profile. (See fig. 2.)

mechanical pilot—See **AUTOMATIC PILOT**.

meteorograph—A recording instrument for obtaining meteorological information above the earth's surface.

It contains elements to record temperature, pressure, and humidity. (Also called *aerograph*.)

mixture control, altitude—A device on the carburetor for regulating the weight proportions of air and fuel supplied to the engine at different altitudes.

moment, trimming—See **TRIMMING MOMENT**.

monocoque fuselage—See **FUSELAGE, MONOCOQUE**.

onoplane—An airplane with but one main supporting surface, sometimes divided into two parts by the fuselage.

high-wing monoplane—A monoplane in which the wing is located at, or near, the top of the fuselage.

low-wing monoplane—A monoplane in which the wing is located at, or near, the bottom of the fuselage.

midwing monoplane—A monoplane in which the wing is located approximately midway between the top and bottom of the fuselage.

parasol monoplane—A monoplane in which the wing is above the fuselage.

monoplane, equivalent—See **EQUIVALENT MONOPLANE**.

mooring band—See **BAND, MOORING**.

mooring cone—See **CONE, MOORING**.

mooring-cone outrigger—See **OUTRIGGER, MOORING-CONE**.

mooring drag—Same as **TAIL DRAG**.

mooring harness—A system of webbing bands, fitted over the top of a balloon, to which the mooring ropes are attached; usually found only on kite or observation balloons.

mooring mast—A mast or tower at the top of which there is a fitting to which the bow of an airship may be secured.

multiplane—An airplane with two or more main supporting surfaces placed one above another.

nacelle—An enclosed shelter for personnel or for a power plant. A nacelle is usually shorter than a fuselage, and does not carry the tail unit.

navigation light—See **LIGHT, NAVIGATION**.

net:

free-balloon net—A rigging made of ropes and twine shaped to fit the upper surface of the envelope, which supports the weight of the basket, etc., and distributes the load over the entire upper surface of the envelope.

gas-cell net (rigid airship)—A small-mesh netting of cord, intended to assist the fabric of the gas

net—continued.

cells in transmitting the gas force to a wire netting of coarser mesh and to the longitudinals, both being fitted between the longitudinals. It may be compared to the net of a free balloon. Sometimes called "gas-cell netting" or "cord netting." (See fig. 6.)

inflation net—A rectangular net of cordage, used to restrain the envelope of a kite balloon or nonrigid airship during inflation. Also applied to a free-balloon net designed to be removed after inflation.

net weight—See **WEIGHT, NET**.

nonrigid airship—See **AIRSHIP, NONRIGID**.

nose-down—To depress the nose of an airplane in flight.

noseheavy—The condition of an airplane in which the nose tends to sink when the longitudinal control is released in any given attitude of normal flight (cf. *tailheavy*).

nose-over—A colloquial expression referring to the accidental turning over of an airplane on its nose when landing.

nose-up—To elevate the nose of an airplane in flight.

Number, Reynolds—See **REYNOLDS NUMBER**.

obstruction light—See **LIGHT, OBSTRUCTION**.

octant—A variation of the aircraft sextant which measures angles up to 90°. Its artificial horizon is usually the bubble type.

oleo gear—A type of oil-damping device that depends on the flow of oil through an orifice for its shock-absorbing effect in a landing gear.

ornithopter—A form of aircraft heavier than air, deriving its chief support and propelling force from flapping wings.

oscillation:

phugoid oscillation—A long-period oscillation characteristic of the disturbed longitudinal motion of an aircraft.

stable oscillation—An oscillation whose amplitude does not increase.

unstable oscillation—An oscillation whose amplitude increases continuously until an attitude is reached from which there is no tendency to return toward the original attitude, the motion becoming a steady divergence.

outrigger, mooring-cone—The member, usually tubular, which supports the mooring cone at the bow of an airship; sometimes referred to as the "mooring spindle." (See fig. 6.)

over-all length—The distance from the extreme front to the extreme rear of an aircraft, including the propeller and the tail unit.

overhang—(1) One half the difference in span of any two main supporting surfaces of an airplane. The overhang is positive when the upper of the two main supporting surfaces has the larger span. (See fig. 5.) (2) The distance from the outer strut attachment to the tip of a wing.

- overshoot**—To fly beyond a designated mark or area, such as a landing field, while attempting to land on the mark or within the area.
- pancake landing**—See LANDING, PANCAKE.
- panel (aerostat)**—(1) The unit piece of fabric of which the envelope or outer cover of an aerostat is made. (2) In rigid airships, the area bounded by two consecutive longitudinals and two consecutive transverses.
- panel (airplane)**—A portion of an airplane wing constructed separately from the rest of the wing to which it is attached.
- panel, rip**—A strip of fabric, inserted or fitted in the upper part of the envelope of a balloon or semirigid or nonrigid airship, which is torn or ripped open when immediate deflation is desired. (See fig. 3.)
- parachute**—An umbrella-like device used to retard the descent of a falling body by offering resistance to its motion through the air.
- pilot parachute**—A small auxiliary parachute attached to the apex of the main parachute, designed to pull the latter out of its pack when the rip cord is pulled.
- parachute flare**—See FLARE, PARACHUTE.
- parachute harness**—A combination of straps, buckles, and fastenings used to attach a parachute to the wearer.
- parachute pack**—A parachute and its container.
- parachute rigger**—A person who packs, repairs, and inspects parachutes.
- parasite drag**—See DRAG, PARASITE.
- parasol monoplane**—See MONOPLANE, PARASOL.
- patch**—A strengthened or reinforced flap of fabric of special shape and construction cemented to the envelope or gas cell of an aerostat. It usually forms an anchorage by which some portion of the structure may be attached to the envelope, or by which the positioning lines controlling the gas cell may be attached to the cell.
- channel patch**—A channel-shaped fabric fitting secured to the envelope of an aerostat to allow a rod or spar to be laced to the envelope.
- finger patch**—A special form of patch having "fingers" extending from the central portion to distribute the load more widely to the fabric of an envelope or gas cell.
- suspension patch**—A patch, secured to the envelope or to a gas cell of an aerostat, to which a suspension line may be attached.
- path, flight**—See FLIGHT PATH.
- pay load**—See LOAD, PAY.
- pendant, sighting**—A vertical wire on the center line and forward of the control car of an airship, used as a guide in steering and to assist in determining the direction of the wind.
- permeability**—The measure of the rate of diffusion of a gas per unit area of any material used in the construction of a gas container.
- pilot**—One who operates the controls of an aircraft in flight.
- pilot, automatic**—See AUTOMATIC PILOT.
- pilot balloon**—See BALLOON, PILOT.
- pilot parachute**—See PARACHUTE, PILOT.
- pilot plane**—An auxiliary airfoil pivoted near the leading edge of a main airfoil and free to take up a position in line with the wind.
- pitch**—An angular displacement about an axis parallel to the lateral axis of an aircraft.
- pitch, angle of**—See ANGLE OF PITCH.
- pitching**—Angular motion about the lateral axis (fig. 12).
- pitch (or pitching) indicator**—An instrument for indicating the existence and approximate magnitude of the angular velocity about the lateral axis of an aircraft.
- pitch of a propeller:**
- effective pitch**—The distance an aircraft advances along its flight path for one revolution of the propeller.
- geometrical pitch**—The distance an element of a propeller would advance in one revolution if it were moving along a helix having an angle equal to its blade angle.
- zero-thrust pitch**—The distance a propeller would have to advance in one revolution to give no thrust. Also called "experimental mean pitch."
- pitch ratio (propeller)**—The ratio of the pitch to the diameter.
- pitot-static tube**—A parallel or coaxial combination of a pitot and a static tube. The difference between the impact pressure and the static pressure is a function of the velocity of flow past the tube.
- pitot tube**—A cylindrical tube with an open end pointed upstream, used in measuring impact pressure.
- pitot-venturi tube**—A combination of a pitot and a venturi tube.
- plane (or hydroplane)**—To move through the water at such a speed that the support derived is due to hydrodynamic and aerodynamic rather than to hydrostatic forces.
- plan form, developed**—The plan of an airfoil as drawn with the chord lines at each section rotated about the airfoil axis into a plane parallel to the plane of projection and with the airfoil axis rotated or developed and projected into the plane of projection.
- plan form, projected**—The contour as viewed from above.
- platform, observation**—A small deck fitted on the top of an airship for a lookout and defense or for making observations used in navigating the airship.
- plowing**—Taxying a seaplane at low speed before rising on the step.
- pontoon**—Obsolete as applied to aircraft. (See FLOAT.)
- porpoising**—An undulatory movement of a seaplane consisting of a combination of a vertical oscillation and an oscillation about its transverse axis, which occurs at certain stages of planing.

position light—See LIGHT, POSITION.

power loading—See LOADING, POWER.

pressure, altitude—See ALTITUDE, PRESSURE.

pressure, dynamic—See DYNAMIC PRESSURE.

pressure, impact—See IMPACT PRESSURE.

pressure, manometer (aerostat)—The excess pressure inside the envelope of an aerostat over the atmospheric pressure at a standard reference point. The point of reference for the excess pressure is usually the bottom of the envelope or gas cell on airships and the level of the basket on kite balloons.

pressure flap—A flap valve fitted in the outer cover or envelope of a rigid airship and arranged to permit the rapid flow of air in and out—particularly inward. The purpose is to facilitate the rapid equalization of the pressure of the air in the envelope with that of the surrounding air.

pressure height—See HEIGHT, PRESSURE.

primary structure (stress analysis)—The main framework, including fittings and attachments. Any structural member, the failure of which would seriously impair the safety of the airplane, is a part of the primary structure.

profile drag—See DRAG, PROFILE.

profile thickness—The maximum distance between the upper and lower contours of an airfoil, measured perpendicularly to the mean line of the profile. (See fig. 2.)

projected propeller-blade area—See AREA, PROJECTED PROPELLER-BLADE.

projector—A device for projecting a beam of light, as a searchlight projector.

projector, bearing—See BEARING PROJECTOR.

projector, ceiling—See CEILING PROJECTOR.

projector, traffic-control—See TRAFFIC-CONTROL PROJECTOR.

propeller—Any device for propelling a craft through a fluid, such as water or air; especially a device having blades which, when mounted on a power-driven shaft, produce a thrust by their action on the fluid.

adjustable propeller—A propeller whose blades are so attached to the hub that the pitch may be changed while the propeller is at rest.

automatic propeller—A propeller whose blades are attached to a mechanism that automatically sets them at their optimum pitch for various flight conditions.

controllable propeller—A propeller whose blades are so mounted that the pitch may be changed while the propeller is rotating.

geared propeller—A propeller driven through gearing, generally at some speed other than the engine speed.

pusher propeller—A propeller mounted on the rear end of the engine or propeller shaft.

tractor propeller—A propeller mounted on the forward end of the engine or propeller shaft.

propeller area—See AREA, PROPELLER.

propeller-blade area—See AREA, PROPELLER-BLADE.

propeller-disk area—See AREA, PROPELLER-DISK.

propeller efficiency—The ratio of the thrust power to the input power of a propeller.

propeller radius—See TIP RADIUS.

propeller rake—The mean angle which the line joining the centroids of the sections of a propeller blade makes with a plane perpendicular to the axis.

propeller root—That part of the propeller blade near the hub. (See fig. 5.)

propeller thrust—The component of the total air force on the propeller which is parallel to the direction of advance.

propeller thrust, effective—The net driving force developed by a propeller when mounted on an aircraft, i.e., the actual thrust exerted by the propeller, as mounted on an airplane, minus any increase in the resistance of the airplane due to the action of the propeller.

propeller thrust, static—The thrust developed by a propeller when rotating without translation.

propeller tipping—A protective covering of the blade of a propeller near the tip. (See fig. 5.)

propulsive efficiency—The ratio of the product of the effective thrust and flight speed to the actual power input into the propeller as mounted on the airplane.

pull-out—The maneuver of transition from a dive to horizontal flight.

pull-up—A maneuver, in the vertical plane, in which the airplane is forced into a short climb, usually from approximately level flight. (cf. *zoom*).

sudden pull-up (or sudden pull-out) (stress analysis)—A loading condition for the tail surfaces resulting from a sudden application of up-elevator (cf. *dive*).

purity (of gas)—The ratio of the partial pressure of the aerostatic gas in the container to the total pressure of all the contained gases.

push-down—The opposite of *pull-up*.

pusher airplane—See AIRPLANE, PUSHER.

pusher propeller—See PROPELLER, PUSHER.

radial engine—See ENGINE, RADIAL.

radio-directive devices:

landing beam—A beam projected from the field to indicate to the pilot his height above the ground and the position of the airplane on the proper path for a glide landing.

radio-marker beacon—A radio transmitter of low power emitting a characteristic aural signal to indicate course positions with respect to a landing field or an airway.

radio-range beacon—A radio transmitter supplying directive radio waves that provide a means of keeping an aircraft on its proper course.

runway localizing beacon—A small radio-range beacon giving accurate lateral direction along the runway of an airport or landing field and a few miles beyond.

radio loop—See LOOP, RADIO.

radio mast—A mast attached to an aircraft which serves as part of the radio-antenna structure.

rail, docking—A rail or guide, installed on the landing field and extending into the shed, which affords a means for resisting the lateral pull of an airship's docking or handling lines.

rake, propeller—See PROPELLER RAKE.

ram—The combination of tubes and springs mounted in gimbals at the top of a mooring mast to ease the shock when the moor is made.

ramming—The effect obtained when the air intake to the engine is placed in the slipstream in such a manner as to take advantage of the difference in velocity of this air intake and the slipstream, in order to increase the pressure in the induction system.

range, maximum—The maximum distance a given aircraft can cover under given conditions, by flying at the economical speed and altitude at all stages of the flight.

range at maximum speed—The maximum distance a given aircraft can fly at full speed at the altitude for maximum speed under given conditions.

rated horsepower of an engine—See HORSEPOWER OF AN ENGINE, RATED.

rate-of-climb indicator—An instrument that indicates the rate of ascent or descent of an aircraft.

recovery, water—See WATER RECOVERY.

reference area—The area used in the equations defining the coefficient of the air force acting upon a body or the coefficients of the components of the air force. This area is logically or conveniently chosen in different manners for different types of bodies.

regulator, fuel bypass—A device placed in the fuel line of a supercharged engine for regulating the fuel pressure in the carburetor float chamber so that it will be a fixed amount above the carburetor air pressure.

relative efficiency of biplane wings (stress analysis)—The ratio of the normal load per square foot on the upper wing to that on the lower.

relative wind—See WIND, RELATIVE.

renversement—A maneuver consisting of a half roll and a half loop in the order named.

resistance derivatives—See DERIVATIVES, RESISTANCE.

retractable landing gear—See LANDING GEAR, RETRACTABLE.

Reynolds Number—A nondimensional coefficient used as a measure of the dynamic scale of a flow. Its usual form is the fraction $\rho \frac{Vl}{\mu}$, in which ρ is the density of the fluid, V is the velocity of the fluid, l is a linear dimension of a body in the fluid, and μ is the coefficient of viscosity of the fluid (cf. *scale effect*).

rib, wing—See WING RIB.

rig:

(aerostat)—To attach and adjust the car, rudders, valves, controls, etc., of an airship, i.e., to erect.

(airplane)—To assemble, adjust, and aline the parts of an airplane.

rigger—One who rigs aircraft.

righting or restoring moment—A moment that tends to restore an aircraft to its previous attitude after any small rotational displacement.

rigid airship—See AIRSHIP, RIGID.

ring, concentration:

airship concentration ring—A ring to which several rigging lines are led from the envelope and from which one or more lines also lead to the car.

free-balloon concentration ring—A ring to which are attached the ropes suspending the basket and to which the net is also secured; sometimes called "load ring."

ring, exhaust-collector—See EXHAUST-COLLECTOR RING.

ring cowling—A ring-shaped cowling placed around a radial air-cooled engine to reduce its drag and improve cooling.

rip cord—(1) The rope running from the rip panel to the car or basket, the pulling of which tears off or rips the panel and causes immediate deflation of a balloon or a nonrigid airship. (See fig. 3:) (2) The cord, together with the handle and fastening pins, which, when pulled, releases a parachute from its container.

roach—A heavy jet or vertical sheet of water thrown above the water surface behind a seaplane float.

roll—A maneuver in which a complete revolution about the longitudinal axis is made, the horizontal direction of flight being approximately maintained.

aileron roll—A roll in which the motion is largely maintained by forces arising from the displacement of the aileron (fig. 8).

outside roll—A roll executed while flying in the negative angle-of-attack range.

snap roll—A roll executed by a quick movement of the controls, in which the motion is largely maintained by autorotational couples on the wings (fig. 8).

roll—An angular displacement about an axis parallel to the longitudinal axis of an aircraft.

rolling—Angular motion about the longitudinal axis (fig. 10).

root, propeller—See PROPELLER ROOT.

Roots-type supercharger—See SUPERCHARGER, ROOTS-TYPE.

rotor—The complete rotating portion of a rotary wing system.

rotor plane—A form of aircraft whose support in the air is chiefly derived from the vertical component of the force produced by rotating airfoils.

rudder—A hinged or movable auxiliary airfoil on an aircraft, the function of which is to impress a yawing moment on the aircraft. (See figs. 3, 4, 5, and 6.)

rudder angle—See ANGLE, RUDDER.

rudder bar—The foot bar by means of which the control cables leading to the rudder are operated. (See fig. 5.)

rudder pedals—The foot pedals by means of which the controls leading to the rudder are operated.

runway—An artificial landing strip permitting the landing and take-off of airplanes under all weather conditions.

safety, factor of—See FACTOR OF SAFETY.

sailplane—A performance-type glider.

scale effect—The change in any force coefficient, such as the drag coefficient, due to a change in the value of Reynolds Number.

school, ground—A school in which instruction is given to a student undergoing flight training.

scoop, air—See AIR SCOOP.

seaplane—An airplane designed to rise from and alight on the water.

semirigid airship—See AIRSHIP, SEMIRIGID.

separation—The phenomenon in which the flow past a body placed in a moving stream of fluid separates from the surface of the body.

separation point—The point at which the separation of the boundary layer begins.

service ceiling—See CEILING, SERVICE.

servo control—See CONTROL, SERVO.

sesquiplane—A form of biplane in which the area of one wing is less than half the area of the other.

shaft:

climbing shaft—A shaft, fitted with a ladder, which leads from the bottom to the top of an airship hull to provide access to the upper portion. (See fig. 4.)

gas shaft—A passageway between the gas cells of an airship to permit the escape of gas which has been discharged from the cells.

shed, airship—See DOCK.

shipboard plane—A landplane designed to rise from and alight on the deck of a ship.

side direction (stress analysis)—The direction perpendicular to the plane of symmetry.

side force or component (stress analysis)—A force, or component, perpendicular to the plane of symmetry.

sideslipping—Motion of an aircraft relative to the air, in which the lateral axis is inclined and the airplane has a velocity component along the lateral axis. When it occurs in connection with a turn, it is the opposite of *skidding*. (See fig. 11.)

signal flare—See FLARE, SIGNAL.

sinking speed—The vertical downward component of velocity that an aircraft would have while descending in still air under given conditions of equilibrium.

skid, tail—See TAIL SKID.

skid, wing—See WING SKID.

skidding—Sliding sidewise away from the center of curvature when turning. It is caused by banking insufficiently, and is the opposite of *sideslipping*.

skid fin—A longitudinal vertical surface, usually placed above the upper wing to increase the lateral stability.

skin friction—The tangential component of the fluid force at a point on a surface.

sky writing—The act of emitting from an aircraft a trail of smoke or other visible substance, the flight of the aircraft being so directed as to cause the trail to assume the form of letters or symbols.

slat—A movable auxiliary airfoil, attached to the leading edge of a wing, which when closed falls within the original contour of the main wing and which when opened forms a slot. (See fig. 1.)

sleeve:

deflation sleeve—(1) A sleeve or appendix made of fabric provided for the special purpose of facilitating the deflation of an aerostat. (2) The sleeve or appendix fitted in the lower lobe of a kite balloon and used to permit the rapid escape of the air in the lobes when the balloon is hauled down.

inflation sleeve—A tubular fabric attachment to an envelope or gas bag, serving as a lead for the inflation tube. (See figs. 3 and 4.)

towing sleeve—A tubular fabric envelope towed by an aircraft and used as a target.

slip—The difference between the geometrical pitch and the effective pitch of a propeller. Slip may be expressed as a percentage of the mean geometrical pitch, or as a linear dimension.

slip function—The ratio of the speed of advance through the undisturbed air to the product of the propeller diameter and the number of revolutions per unit time; i.e., V/nD .

slipstream—The current of air driven astern by a propeller.

slot—The nozzle-shaped passage through a wing whose primary object is to improve the flow conditions at high angles of attack. It is usually near the leading edge and formed by a main and an auxiliary airfoil, or *slat*. (See fig. 1.) (Cf. *slat*.)

slotted aileron—See AILERON, SLOTTED.

soar—To fly without engine power and without loss of altitude, as does a glider in ascending air currents.

solidity—The ratio of the total blade area of a rotor to the area of the disk swept by the blades.

sounding balloon—See BALLOON, SOUNDING.

span—The maximum distance, measured parallel to the lateral axis, from tip to tip of an airfoil, of an airplane wing inclusive of ailerons, or of a stabilizer inclusive of elevator. (See fig. 5.)

effective span—The true span of a wing less corrections for tip loss.

span loading—See **LOADING, SPAN**.

spar, wing—See **WING SPAR**.

speed:

air speed—See **AIR SPEED**.

get-away speed—The air speed at which a seaplane becomes entirely air-borne.

ground speed—The horizontal component of the velocity of an aircraft relative to the ground.

hump speed—The speed of a seaplane during take-off at which the float resistance reaches a maximum.

landing speed—The minimum speed of an airplane at the instant of contact with the landing area in a normal landing.

minimum flying speed—The lowest steady speed that can be maintained, with any throttle setting whatsoever, by an airplane in level flight at an altitude above the ground greater than the span of the wings.

operating speed—The speed in level flight corresponding to 87.5 percent of the rated speed of the engine.

pitch speed—The product of the mean geometrical pitch and the number of revolutions of the propeller in unit time.

rated engine speed—The rotative speed of an engine at which its reliability has been determined for continuous performance.

sinking speed—See **SINKING SPEED**.

slip speed (supercharger)—The supercharger speed necessary to maintain a given pressure difference between intake and discharge when there is no air delivery.

stalling speed—The speed of an airplane in steady flight at its maximum coefficient of lift.

take-off speed—The air speed at which an airplane becomes entirely air-borne.

terminal speed—See **VELOCITY, TERMINAL**.

spin—A maneuver in which an airplane descends along a helical path of large pitch and small radius while flying at a mean angle of attack greater than the angle of attack at maximum lift (cf. *spiral*).

flat spin—A spin in which the longitudinal axis is less than 45° from the horizontal.

inverted spin—A maneuver having the characteristics of a normal spin except that the airplane is in an inverted attitude.

normal spin—A spin which is continued by reason of the voluntary position of the control surfaces, recovery from which can be effected within two turns by neutralizing or reversing all the controls. Sometimes called "controlled spin" (fig. 8).

uncontrolled spin—A spin in which the controls are of little or no use in effecting a recovery.

spinner—A fairing of approximately conical or paraboloidal shape, which is fitted coaxially with the

propeller hub and revolves with the propeller. (See fig. 5.)

spiral—A maneuver in which an airplane descends in a helix of small pitch and large radius, the angle of attack being within the normal range of flight angles (fig. 8) (cf. *spin*).

split S—A maneuver consisting of a half snap roll followed by a pull-out to normal flight, thus obtaining a 180° change in direction accompanied by a loss of altitude (fig. 8).

spoiler—A small plate arranged to project above the upper surface of a wing to disturb the smooth air flow, with consequent loss of lift and increase of drag. (See fig. 1.) (cf. *interceptor*.)

squat—A downward, or negative, displacement of the center of gravity of a seaplane while running on the water.

spray strip—A strip projecting from the hull of a seaplane to change the manner in which the spray is thrown.

spoonson—A protuberance from a seaplane hull designed to increase the beam or give lateral stability at rest.

stability—That property of a body which causes it, when its equilibrium is disturbed, to develop forces or moments tending to restore the original condition.

automatic stability—Stability dependent upon movable control surfaces automatically operated by mechanical means.

directional stability—Stability with reference to disturbances about the normal axis of an aircraft, i.e., disturbances which tend to cause yawing.

dynamic stability—That property of an aircraft which causes it, when its state of steady flight is disturbed, to damp the oscillations set up by the restoring forces and moments and gradually return to its original state.

inherent stability—Stability of an aircraft due solely to the disposition and arrangement of its fixed parts; i.e., that property which causes it, when disturbed, to return to its normal attitude of flight without the use of the controls or the interposition of any mechanical device.

lateral stability—Stability with reference to disturbances about the longitudinal axis; i.e., disturbances involving rolling or sideslipping. The term lateral stability is sometimes used to include both directional and lateral stability, since these cannot be entirely separated in flight.

longitudinal stability—Stability with reference to disturbances in the plane of symmetry, i.e., disturbances involving pitching and variation of the longitudinal and normal velocities.

static stability—That property of an aircraft which causes it, when its state of steady flight is disturbed, to develop forces and moments tending to restore its original condition.

- stabilizer (airplane)**—Any airfoil whose primary function is to increase the stability of an aircraft. It usually refers to the fixed horizontal tail surface of an airplane, as distinguished from the fixed vertical surface. (See fig. 5.)
- stabilizer (aerostat)**—Same as FIN.
- stabilizer, stub-wing**—A projection from the side of the central hull of a flying boat intended to increase the buoyancy and stability of a flying boat while the boat is at rest and to increase the hydrodynamic lift during the take-off. It is an integral part of the hull, and usually takes the form of a stumpy airfoil or a stub wing.
- stagger**—A term referring to the longitudinal position of the axes of two wings of an airplane. Stagger of any section is measured by the acute angle between a line joining the wing axes and a line perpendicular to the upper wing chord, both lines lying in a plane parallel to the plane of symmetry. The stagger is positive when the upper wing is in advance of the lower. (See fig. 5.)
- stall**—The condition of an airfoil or airplane in which it is operating at an angle of attack greater than the angle of attack of maximum lift.
- stalling speed**—See SPEED, STALLING.
- standard atmosphere**—See ATMOSPHERE, STANDARD.
- static ceiling**—See CEILING, STATIC.
- static pressure**—The force per unit area exerted by a fluid on a surface at rest relative to the fluid.
- static stability**—See STABILITY, STATIC.
- static tube**—A cylindrical tube with a closed end and a number of small openings normal to the axis, pointed upstream, used to measure static pressure.
- station, airship**—See AIRSHIP STATION.
- step**—A break in the form of the bottom of a float or hull, designed to diminish resistance, to lessen the suction effects, and to improve control over longitudinal attitude.
- stern-droop**—A deformation of an airship in which its longitudinal axis bends downward at the after end.
- sternheavy**—The condition in which, in normal flight, the after end of an airship tends to sink and which requires correction by means of the horizontal controls. It may be due to either aerodynamic or static conditions, or to both (cf. *bowheavy*).
- stern-weighing device**—An instrument located near the stern of an airship for measuring its buoyancy (cf. *bow-weighing device*).
- stiffener, bow**—A rigid member attached to the bow of a nonrigid or semirigid envelope to reinforce it against the pressure caused by the motion of the airship. (See figs. 3 and 4.)
- sting**—A light rod attached to and extending backward from a body for convenience of mounting when testing in a wind tunnel.
- streamline**—The path of a particle of a fluid, supposedly continuous, commonly taken relative to a solid body past which the fluid is moving; generally used only of such flows as are not eddying.
- streamline flow**—See FLOW, STREAMLINE.
- streamline form**—The form of a body so shaped that the flow about it tends to be a streamline flow.
- stresses, breathing**—Stresses produced in an aerostat by breathing. They are of importance in the envelope and keel of a semirigid airship, due to the interaction of the envelope and keel when the envelope breathes.
- strut**—A compression member of a truss frame. (See fig. 5.)
- oleo strut**—A shock-absorbing telescopic strut in which an oleo gear is incorporated.
- stub plane**—See STABILIZER, STUB-WING.
- sun compass**—See COMPASS, SUN.
- supercharge**—To supply an engine with more air or mixture than would be inducted normally at the prevailing atmospheric pressure. The term supercharged is generally used to refer to conditions at altitudes where the pressure in the intake manifold is partly or completely restored to that existing under normal operation at sea level (cf. *boost*).
- supercharger**—A pump for supplying the engine with a greater weight of air or mixture than would normally be inducted at the prevailing atmospheric pressure.
- centrifugal-type supercharger**—A high-speed rotary blower equipped with one or more multi-blade impellers which, through centrifugal action, compress the air or mixture in the induction system.
- positive-driven-type supercharger**—A supercharger driven at a fixed speed ratio from the engine shaft by gears or other positive means.
- reciprocating-type supercharger**—A positive-displacement reciprocating pump in which the air or mixture is compressed by a piston working in a cylinder.
- Roots-type supercharger**—A positive-displacement rotary blower consisting of two double-lobed impellers turning in opposite directions on parallel shafts within a housing, the impellers rolling together except for a small clearance, meanwhile alternately trapping incoming air or mixture in the ends of the housing and sweeping it through to the outlet.
- vane-type supercharger**—A positive-displacement rotary blower having an eccentrically located rotor provided with one or more vanes.
- supercharger control: bypassing (Roots)**—Regulating the pressure of the air supplied to the carburetor by discharging into the free atmosphere the excess delivered by the supercharger.

- superheat**—The amount by which the temperature of the gas in the envelope or gas cells of an aerostat exceeds the temperature of the surrounding air. If the gas has a lower temperature, the superheat is said to be negative.
- superpressure**—The excess of pressure at the bottom of an airship gas cell or envelope over the outside atmospheric pressure.
- suspension band**—See **BAND, SUSPENSION**.
- suspension bar (or ring)**—A bar to which the suspension ropes of the balloon basket are secured. It is also fitted with ropes and toggles for attachment to the basket suspensions from the envelope or net; also called "trapeze bar."
- suspension, basket**—The suspension by means of which the basket of a kite balloon is supported beneath the balloon body proper. It is independent of the winch suspension.
- suspension, winch**—The rigging by means of which the lift and drag of a kite balloon are transmitted from the envelope to the towing or traction cable.
- sweepback**—The acute angle between a line perpendicular to the plane of symmetry and the plan projection of a reference line in the wing. (See fig. 5.)
- tab**—An auxiliary airfoil attached to a control surface for the purpose of reducing the control force or trimming the aircraft.
- tachometer**—An instrument that measures in revolutions per minute the rate at which the crankshaft of an engine turns.
- tail, airplane**—The rear part of an airplane, usually consisting of a group of stabilizing planes, or fins, to which are attached certain controlling surfaces such as elevators and rudders; also called "empennage."
- tail area**—See **AREA, MEASUREMENT OF**.
- tail boom**—A spar or outrigger connecting the tail surfaces and the main supporting surfaces.
- tail drag**—A movable or variable weight suspended from the after part of an airship moored to a mast, to aid in restraining the vertical and lateral motions of the stern of the airship.
- tailheavy**—The condition of an airplane in which the tail tends to sink when the longitudinal control is released in any given attitude of normal flight (cf. *noseheavy*).
- tail skid**—A skid for supporting the tail of an airplane on the ground. (See fig. 5.)
- tailless airplane**—See **AIRPLANE, TAILLESS**.
- tail slide**—Rearward motion, relative to the air of an aircraft in flight.
- tail surface**—A stabilizing or control surface in the tail of an aircraft.
- tail wheel**—See **WHEEL, TAIL**.
- take-off**—The act of beginning flight in which an airplane is accelerated from a state of rest to that of normal flight. In a more restricted sense, the final breaking of contact with the land or water.
- take-off distance**—The distance in which an airplane will finally break contact with the land or water, starting from zero speed. Take-off distance is considered in a calm or at a specified wind velocity.
- tank, seaplane**—An elongated tank filled with water through which models of seaplane floats, boat hulls, hydrovanes, etc., are towed, and the forces and moments on the model are measured.
- tank, service**—A fixed fuel tank near each power unit, into which fuel from other tanks is pumped and from which the fuel supplying the engine is drawn.
- taper in plan only**—A gradual change (usually a decrease) in the chord length along the wing span from the root to the tip, with the wing sections remaining geometrically similar.
- taper in thickness ratio only**—A gradual change in the thickness ratio along the wing span with the chord remaining constant.
- taxi**—To operate an airplane under its own power, either on land or on water, except as necessarily involved in take-off or landing.
- taxiway**—A specially prepared area over which airplanes may taxi to and from the landing area of a landing field.
- tee, wind**—See **WIND TEE**.
- terminal velocity**—See **VELOCITY, TERMINAL**.
- test chamber**—See **EXPERIMENT CHAMBER**.
- thickness ratio**—The ratio of the maximum thickness of an airfoil section to its chord.
- three-point landing**—See **LANDING, THREE-POINT**.
- thrust, effective propeller**—See **PROPELLER THRUST, EFFECTIVE**.
- thrust, propeller**—See **PROPELLER THRUST**.
- thrust, static propeller**—See **PROPELLER THRUST, STATIC**.
- tip radius (or propeller radius)**—The distance of the outermost point of a propeller blade from the axis of rotation.
- torque stand**—A test stand on which the engine torque is measured.
- towing sleeve**—See **SLEEVE, TOWING**.
- tractor airplane**—See **AIRPLANE, TRACTOR**.
- traffic-control projector**—A projector designed to give light signals to an aircraft pilot.
- trailing edge**—The rearmost edge of an airfoil or of a propeller blade.
- trail rope**—See **DRAG ROPE**.
- trajectory band**—See **BAND, TRAJECTORY**.
- transition strip**—A section of the landing area adjacent to a runway or other hard-surfaced area, constructed of crushed stone, or other suitable material, properly bound, to insure the safe landing and taxiing of airplanes across such a runway or area in any direction.
- transverse**:
- intermediate transverse**—An open unbraced transverse frame of a rigid airship between two main or braced transverse frames.

transverse—continued.

main transverse—One of the main transverse strengthening frames of a rigid airship provided with wire or girder bracing and spaced at regular intervals throughout the length of the airship.

trim:

(airplane) **trim**—The attitude with respect to wind axes at which balance occurs in rectilinear flight with free controls.

(airship) **trim**—The attitude of the longitudinal axis of an airship with respect to the horizontal.

(seaplane) **trim**—The angle with the horizontal surface of the water assumed by the float or hull under given conditions.

trimming moment—The moment about a reference point, usually the center of gravity, exerted by the seaplane hull or float when held at a fixed trim angle. It is considered positive when the bow tends to rise.

tunnel, water—See WATER TUNNEL.

tunnel, wind—See WIND TUNNEL.

turbulent flow—See FLOW, TURBULENT.

turn, Immelman—See IMMELMAN TURN.

turn-and-bank indicator—An instrument combining in one case a turn indicator and a lateral inclinometer.

turn indicator—An instrument for indicating the existence and approximate magnitude of angular velocity about the normal axis of an aircraft.

turnmeter—An instrument that measures the rate of turn of an aircraft about any predetermined axis.

ultimate load—See LOAD, ULTIMATE.

undercarriage—See LANDING GEAR.

undock—To remove an airship from its dock.

useful load—See LOAD, USEFUL.

valve—To release air or supporting gas from an aerostat into the atmosphere.

valve:

automatic valve—(1) A spring-loaded relief valve fitted to the envelope, ballonnet, or gas cell of an aerostat and set to open at a predetermined pressure for the purpose of preventing excessive internal pressure. (See figs. 4 and 6.)

(2) A type of valve, used on some aerostats, which opens at a predetermined volume or hull dimension.

maneuvering valve—A manually operated valve fitted to the envelope, ballonnet, or gas cell of an aerostat for the purpose of releasing gas or air from within the envelope or gas cell as desired.

valve petticoat—A special sleeve between the valve and gas container making it possible to tie off the sleeve and change valves without loss of gas.

valve seal—A fabric cover used to seal the automatic valves of a rigid airship while it is docked

vane-type supercharger—See SUPERCHARGER, VANE-TYPE.

velocity, terminal—The hypothetical maximum speed that an airplane could attain along a specified straight flight path under given conditions of weight

and propeller operation, if diving an unlimited distance in air of specified uniform density. If the term is not qualified, a vertical path angle, normal gross weight, zero thrust, and standard sea-level air density are assumed.

vent:

fuel-tank vent—A small tube used to conduct surplus fuel from a fuel tank, overboard clear of the airplane, and to equalize pressures.

oil-tank vent—A large tube used to conduct oil vapors from the engine to the oil tank.

parachute vent—A distendable opening in the apex of the canopy of a parachute designed to relieve excess pressure and to stabilize the parachute in descent.

venturi tube (or venturi)—A short tube of varying cross section. The flow through the venturi causes a pressure drop in the smallest section, the amount of the drop being a function of the velocity of flow.

visibility—The greatest distance at which conspicuous objects can be seen and identified.

volume, aerodynamic—See AERODYNAMIC VOLUME.

volume, gas (airship)—The volume of the contained gas (cf. *capacity*).

walkway girder—See GIRDER, WALKWAY.

warp—To change the form of a wing by twisting it. Warping was formerly used to perform the function now performed by ailerons.

wash—The disturbance in the air produced by the passage of an airfoil. Also called the "wake" in the general case for any solid body.

washin—A warp of an airplane wing giving an increase of the angle of attack toward the tip.

washout—A warp of an airplane wing giving a decrease of the angle of attack toward the tip.

water recovery—The process and the equipment used on an airship for condensing and recovering the water contained in the exhaust gases of internal-combustion engines, in order to avoid the valving of gas as the fuel is consumed.

water tunnel—A device similar to a wind tunnel, but using water as the working fluid.

weight:

dischargeable (or consumable) weight (airship)—

All weight that can be consumed or discharged and still leave the airship in safe operating condition with a specified reserve of fuel, oil, water ballast, and provisions, and with the normal crew.

empty weight—The structure, power plant, and fixed equipment of an aircraft. Included in this fixed equipment are the water in the radiator and cooling system, all essential instruments and furnishings, fixed electric wiring for lighting, heating, etc. In the case of an aerostat, it also includes the amount of ballast that must be carried to assist in making a safe landing.

weight—continued.

fixed weight (airship)—The weight of the machinery and all equipment and parts that are fixed in position and nonconsumable. Liquids in the cooling systems of the engines are included.

fixed power plant weight for a given airplane weight—The weight of the power plant and its accessories, exclusive of fuel and oil and their tanks.

gross weight (airplane)—The total weight of an airplane when fully loaded. (cf. *load, full.*)

net weight (stress analysis)—The gross weight, less some specific partial weight. Very often the partial weight is the dead weight of the wings, but it may be the useful load. The partial weight in question should always be clearly indicated by the context.

wheel control—See CONTROL COLUMN.

wheel, tail—A wheel used to support the tail of an airplane when on the ground. It may be steerable or nonsteerable, fixed or swiveling.

winch suspension—See SUSPENSION, WINCH.

wind cone—See CONE, WIND.

wind indicator—A device that indicates the direction and velocity of the surface wind.

wind, relative—The velocity of the air with reference to a body in it. It is usually determined from measurements made at such a distance from the body that the disturbing effect of the body upon the air is negligible.

window, inspection—A small transparent window fitted in the envelope of a balloon or airship, or in the wing or fuselage of an airplane, to allow inspection of the interior. (See figs. 3 and 5.)

wind tee—A large T-shaped weather vane located on a landing field or on the top of an adjacent structure to indicate the direction of the wind. It may have the form of an airplane and may be illuminated for night landings. Also called "landing tee."

wind tunnel—An apparatus producing an artificial wind or air stream, in which objects are placed for investigating the air flow about them and the aerodynamic forces exerted on them (fig. 7).

wing—A general term applied to the airfoil, or one of the airfoils, designed to develop a major part of the lift of a heavier-than-air craft.

equivalent wing (stress analysis)—A wing of the same span as the actual wing, but with the chord at each section reduced in proportion to the ratio of the average beam load at that section to the average beam load at the section taken as the standard.

wing area—See AREA, MEASUREMENT OF.

wing axis—See AXIS, WING.

wingheavy, right or left—The condition of an airplane whose right or left wing tends to sink when the lateral control is released in any given attitude of normal flight.

wing loading—See LOADING, WING.

wing-over—A maneuver in which the airplane is put into a climbing turn until nearly stalled, at which point the nose is allowed to fall while continuing the turn, then returned to normal flight from the ensuing dive or glide in a direction approximately 180° from that at the start of the evolution (fig. 8).

wing profile—The outline of a wing section.

wing rib—A chord-wise member of the wing structure of an airplane, used to give the wing section its form and to transmit the load from the fabric to the spars.

compression wing rib—A heavy rib designed to perform the function of an ordinary wing rib and also to act as a strut opposing the pull of the wires in the internal drag truss.

former (or false) wing rib—An incomplete rib, frequently consisting only of a strip of wood extending from the leading edge to the front spar, which is used to assist in maintaining the form of the wing where the curvature of the airfoil section is sharpest. (See fig. 5.)

wing section—A cross section of a wing parallel to the plane of symmetry or to a specified reference plane.

wing section, aerodynamic center of—See AERODYNAMIC CENTER.

wing skid—A skid placed near the wing tip to protect the wing from contact with the ground.

wing spar—A principal span-wise member of the wing structure of an airplane. (See fig. 5.)

wing tip—The outer end of an airplane wing.

wing-tip flare—See FLARE, WING-TIP.

wing-tip rake—A term referring to the shape of the tip of the wing when the tip edge is sensibly straight in plan but is not parallel to the plane of symmetry. The amount of rake is measured by the acute angle between the straight portion of the wing tip and the plane of symmetry. The rake is positive when the trailing edge is longer than the leading edge.

wire (airplane):

antidrag wire—A wire intended primarily to resist the forces acting forward in the chord direction. It is generally enclosed in the wing. (See fig. 5.)

drag wire—A wire intended primarily to resist the forces acting backward in the chord direction. It is generally enclosed in the wing. (See fig. 5.)

landing wire—A wire or cable which braces the wing against the forces opposite to the normal direction of the lift. (See fig. 5.)

lift wire—A wire or cable which braces the wings against the lift force; sometimes called "flying wire." (See fig. 5.)

stagger wire—A wire connecting the upper and lower wings of an airplane and lying in a plane substantially parallel to the plane of symmetry; also called "incidence wire." (See fig. 5.)

wire (airship):

antiflutter wire—A wire in the plane of the outer cover for local reinforcement and for reducing flutter due to variations in air pressure or propeller wash.

chord wire—A wire joining the vertices of a main transverse frame.

diametral wire—A chord wire that passes through or near the center of a main transverse frame. It is usually attached to the axial fitting.

fairing wire—A wire provided as a point of attachment for the outer cover to maintain the contour lines of the envelope of an airship.

main shear wire—A diagonal wire taking up main shear loads in the structure of a rigid airship.

netting wire—Diagonal or circumferential wire netting fitted between the longitudinals over the entire hull of a rigid airship to transmit the lift of the gas cells to the structure.

wire—continued.

radial wire—A wire that extends from an axial fitting at the center of a transverse frame of a rigid airship to one of the vertices of the frame.

secondary shear wire—An additional reinforcing shear wire.

yaw—An angular displacement about an axis parallel to the normal axis of an aircraft.

yawing—Angular motion about the normal axis (fig. 13.)

yaw line—See **LINE, YAW**.

yawmeter—An instrument that measures the angle of yaw of an aircraft.

zero-lift angle—See **ANGLE, ZERO-LIFT**.

zoom—To climb for a short time at an angle greater than the normal climbing angle, the airplane being carried upward at the expense of kinetic energy.

AERONAUTIC SYMBOLS

1. FUNDAMENTAL AND DERIVED UNITS

	Symbol	Metric		English	
		Unit	Abbreviation	Unit	Abbreviation
Length.....	<i>l</i>	meter.....	m	foot (or mile).....	ft. (or mi.)
Time.....	<i>t</i>	second.....	s	second (or hour).....	sec. (or hr.)
Force.....	<i>F</i>	weight of 1 kilogram.....	kg	weight of 1 pound.....	lb.
Power.....	<i>P</i>	horsepower (metric).....		horsepower.....	hp.
Speed.....	<i>V</i>	{kilometers per hour.....	k.p.h.	miles per hour.....	m.p.h.
		{meters per second.....	m.p.s.	feet per second.....	f.p.s.

2. GENERAL SYMBOLS

- W*, Weight = mg
- g*, Standard acceleration of gravity = 9.80665 m/s² or 32.1740 ft./sec.²
- m*, Mass = $\frac{W}{g}$
- I*, Moment of inertia = mk^2 . (Indicate axis of radius of gyration *k* by proper subscript.)
- μ*, Coefficient of viscosity
- ν*, Kinematic viscosity
- ρ*, Density (mass per unit volume)
Standard density of dry air, 0.12497 kg-m⁻⁴-s² at 15° C. and 760 mm; or 0.002378 lb.-ft.⁻⁴ sec.²
- Specific weight of "standard" air, 1.2255 kg/m³ or 0.07651 lb./cu. ft.

3. AERODYNAMIC SYMBOLS

- S*, Area
- S_w*, Area of wing
- G*, Gap
- b*, Span
- c*, Chord
- b²*, Aspect ratio
- S'*, Aspect ratio
- V*, True air speed
- q*, Dynamic pressure = $\frac{1}{2}\rho V^2$
- L*, Lift, absolute coefficient $C_L = \frac{L}{qS}$
- D*, Drag, absolute coefficient $C_D = \frac{D}{qS}$
- D₀*, Profile drag, absolute coefficient $C_{D_0} = \frac{D_0}{qS}$
- D_i*, Induced drag, absolute coefficient $C_{D_i} = \frac{D_i}{qS}$
- D_p*, Parasite drag, absolute coefficient $C_{D_p} = \frac{D_p}{qS}$
- C*, Cross-wind force, absolute coefficient $C_C = \frac{C}{qS}$
- R*, Resultant force
- i_w*, Angle of setting of wings (relative to thrust line)
- i_s*, Angle of stabilizer setting (relative to thrust line)
- Q*, Resultant moment
- Ω*, Resultant angular velocity
- $\rho \frac{Vl}{\mu}$, Reynolds Number, where *l* is a linear dimension (e.g., for a model airfoil 3 in. chord, 100 m.p.h. normal pressure at 15° C., the corresponding number is 234,000; or for a model of 10 cm chord, 40 m.p.s., the corresponding number is 274,000)
- C_p*, Center-of-pressure coefficient (ratio of distance of c.p. from leading edge to chord length)
- α*, Angle of attack
- ε*, Angle of downwash
- α₀*, Angle of attack, infinite aspect ratio
- α_i*, Angle of attack, induced
- α_a*, Angle of attack, absolute (measured from zero-lift position)
- γ*, Flight-path angle

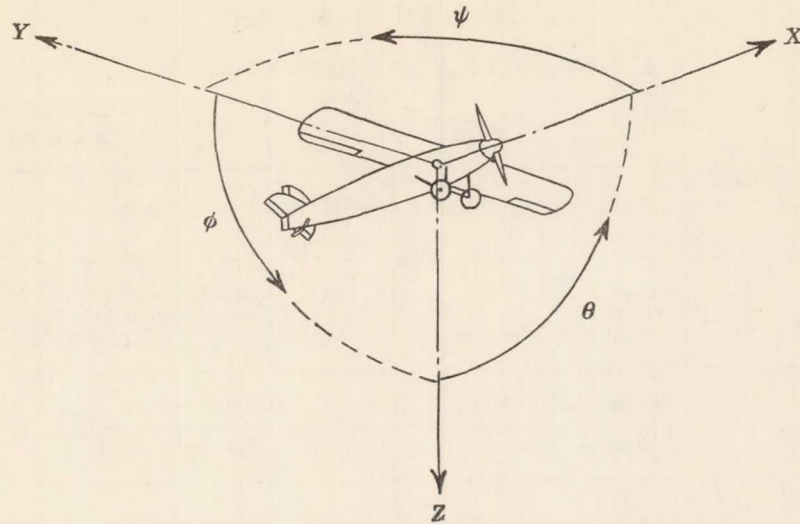

Positive directions of axes and angles (forces and moments) are shown by arrows

Axis		Force (parallel to axis) symbol	Moment about axis			Angle		Velocities	
Designation	Symbol		Designation	Symbol	Positive direction	Designation	Symbol	Linear (component along axis)	Angular
Longitudinal	X	X	Rolling	L	Y → Z	Roll	φ	u	p
Lateral	Y	Y	Pitching	M	Z → X	Pitch	θ	v	q
Normal	Z	Z	Yawing	N	X → Y	Yaw	ψ	w	r

Absolute coefficients of moment

$$C_l = \frac{L}{qbS}$$

(rolling)

$$C_m = \frac{M}{qcS}$$

(pitching)

$$C_n = \frac{N}{qbS}$$

(yawing)

Angle of set of control surface (relative to neutral position), δ. (Indicate surface by proper subscript.)

4. PROPELLER SYMBOLS

- D, Diameter
- p, Geometric pitch
- p/D, Pitch ratio
- V', Inflow velocity
- V_s, Slipstream velocity

T, Thrust, absolute coefficient $C_T = \frac{T}{\rho n^2 D^4}$

Q, Torque, absolute coefficient $C_Q = \frac{Q}{\rho n^2 D^5}$

P, Power, absolute coefficient $C_P = \frac{P}{\rho n^3 D^5}$

C_s, Speed-power coefficient = $\sqrt[5]{\frac{\rho V^5}{P n^2}}$

η, Efficiency

n, Revolutions per second, r.p.s.

Φ, Effective helix angle = $\tan^{-1}\left(\frac{V}{2\pi r n}\right)$

5. NUMERICAL RELATIONS

- 1 hp. = 76.04 kg-m/s = 550 ft-lb./sec.
- 1 metric horsepower = 1.0132 hp.
- 1 m.p.h. = 0.4470 m.p.s.
- 1 m.p.s. = 2.2369 m.p.h.

- 1 lb. = 0.4536 kg.
- 1 kg = 2.2046 lb.
- 1 mi. = 1,609.35 m = 5,280 ft.
- 1 m = 3.2808 ft.

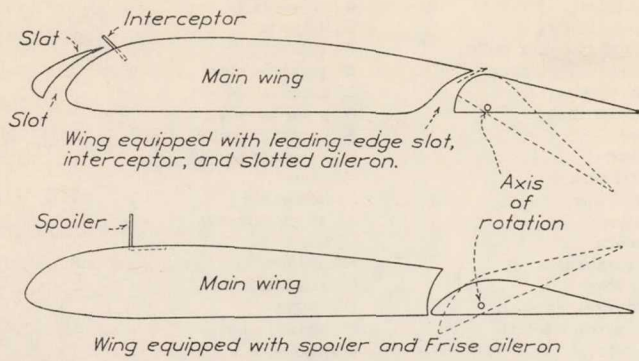
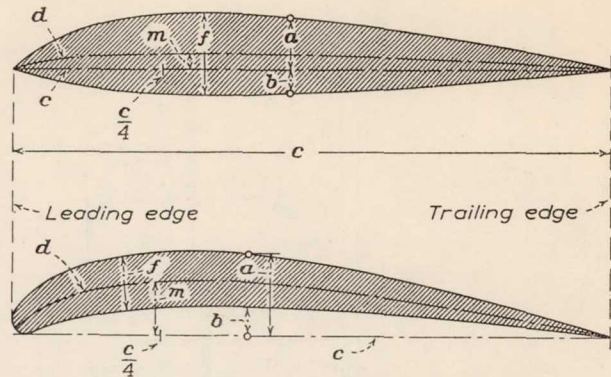

FIGURE 1.—Wing equipped with special control devices.



a/c, upper camber
b/c, lower camber
m/c, mean camber
c, chord length

d, mean line of the airfoil profile
c/4, aerodynamic center (quarter-chord point)
f, profile thickness

FIGURE 2.—Dimensions of an airfoil profile.

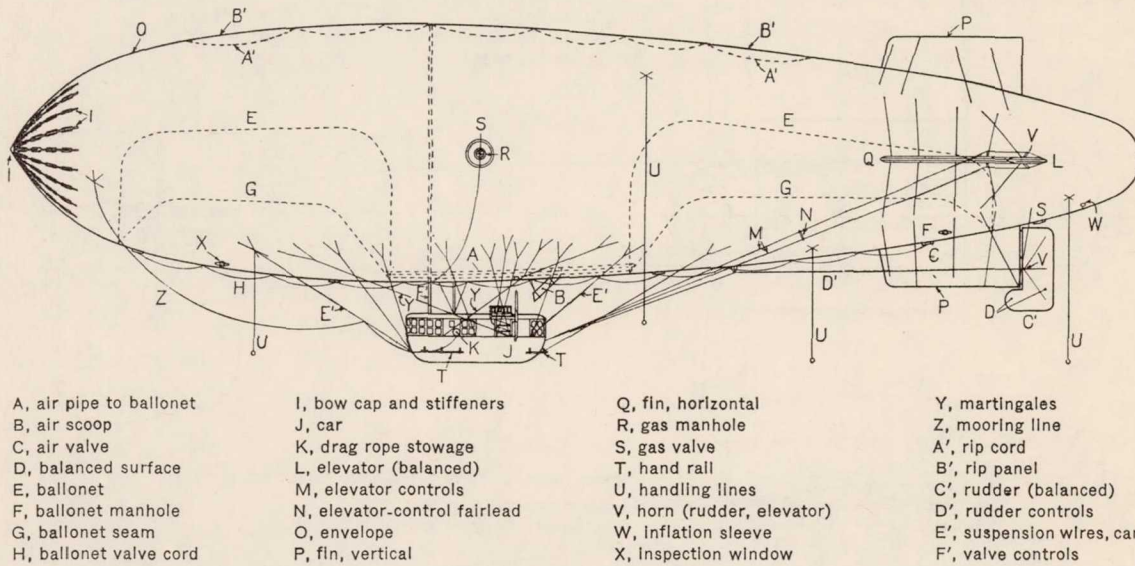

- | | | | |
|-------------------------|------------------------------|----------------------------|---------------------------|
| A, air pipe to ballonet | I, bow cap and stiffeners | Q, fin, horizontal | Y, martingales |
| B, air scoop | J, car | R, gas manhole | Z, mooring line |
| C, air valve | K, drag rope stowage | S, gas valve | A', rip cord |
| D, balanced surface | L, elevator (balanced) | T, hand rail | B', rip panel |
| E, ballonet | M, elevator controls | U, handling lines | C', rudder (balanced) |
| F, ballonet manhole | N, elevator-control fairlead | V, horn (rudder, elevator) | D', rudder controls |
| G, ballonet seam | O, envelope | W, inflation sleeve | E', suspension wires, car |
| H, ballonet valve cord | P, fin, vertical | X, inspection window | F', valve controls |

FIGURE 3.—A nonrigid airship.

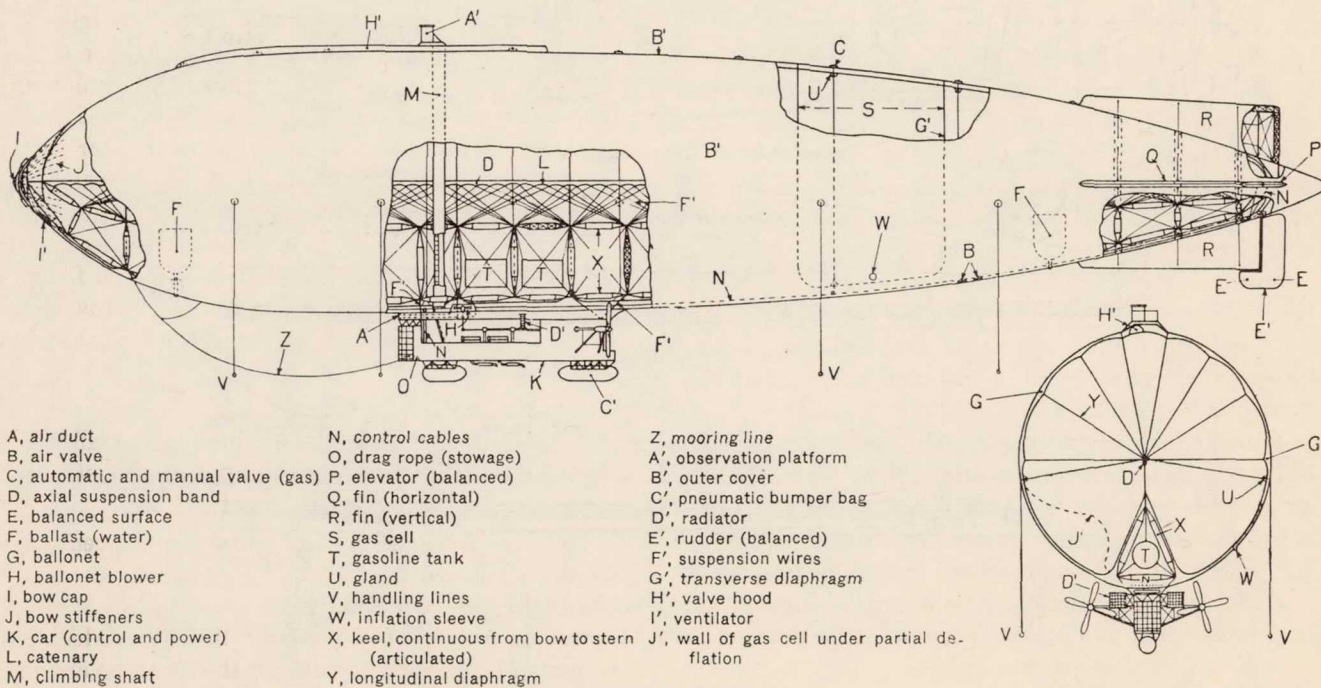

- | | | |
|-------------------------------------|---|--|
| A, air duct | N, control cables | Z, mooring line |
| B, air valve | O, drag rope (stowage) | A', observation platform |
| C, automatic and manual valve (gas) | P, elevator (balanced) | B', outer cover |
| D, axial suspension band | Q, fin (horizontal) | C', pneumatic bumper bag |
| E, balanced surface | R, fin (vertical) | D', radiator |
| F, ballast (water) | S, gas cell | E', rudder (balanced) |
| G, ballonet | T, gasoline tank | F', suspension wires |
| H, ballonet blower | U, gland | G', transverse diaphragm |
| I, bow cap | V, handling lines | H', valve hood |
| J, bow stiffeners | W, inflation sleeve | I', ventilator |
| K, car (control and power) | X, keel, continuous from bow to stern (articulated) | J', wall of gas cell under partial deflation |
| L, catenary | Y, longitudinal diaphragm | |
| M, climbing shaft | | |

FIGURE 4.—A semirigid airship.

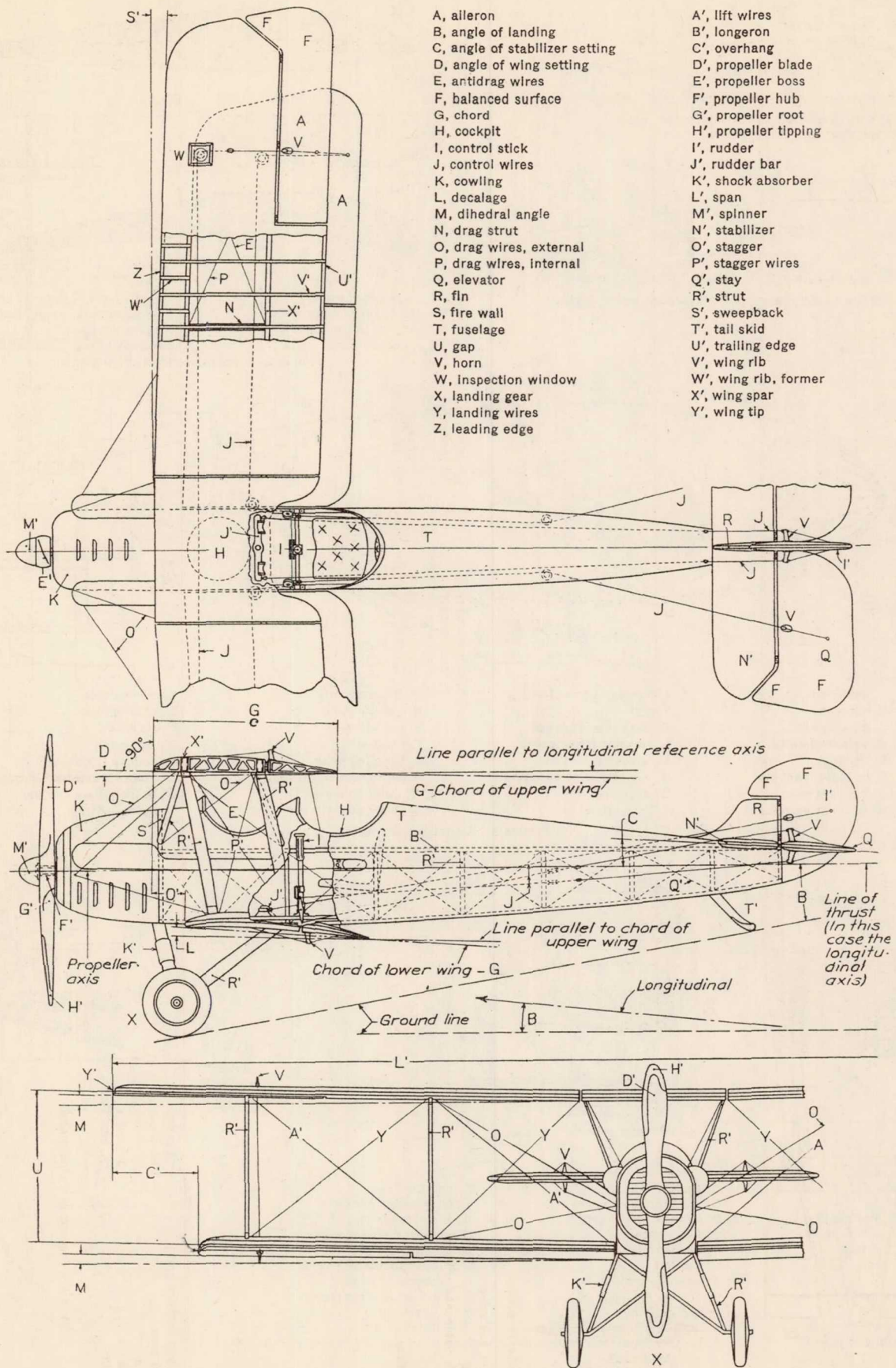

FIGURE 5.—An airplane.

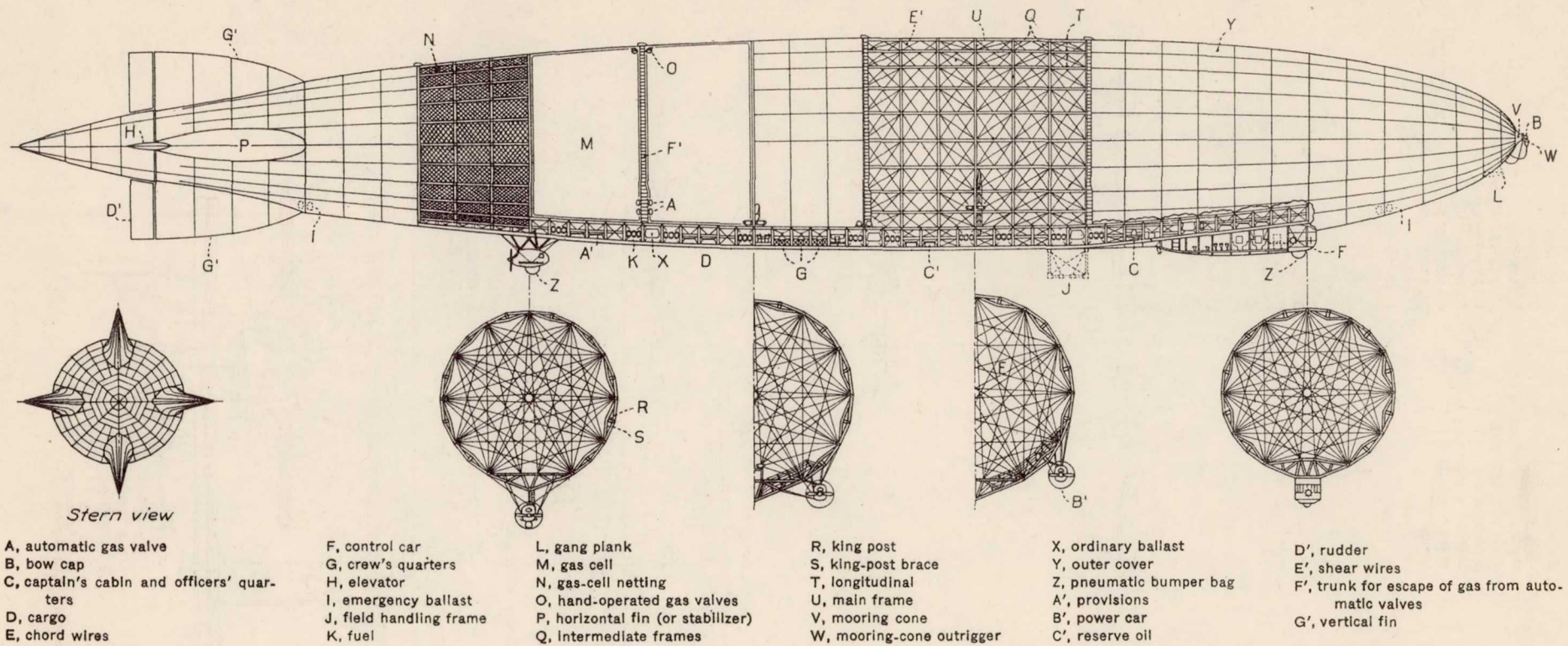
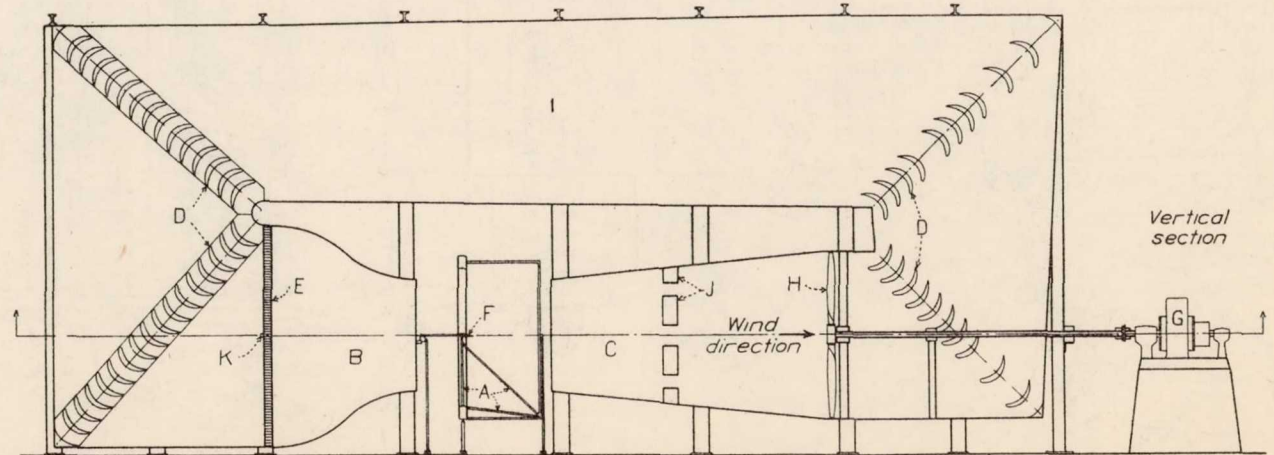

FIGURE 6.—A rigid airship.

- | | |
|------------------------------|-------------------|
| A, balance and model support | G, motor |
| B, entrance cone | H, propeller |
| C, exit cone | I, return passage |
| D, guide vanes | J, slots |
| E, honeycomb | K, static plate |
| F, model | |

FIGURE 7.—Diagram of a wind tunnel.



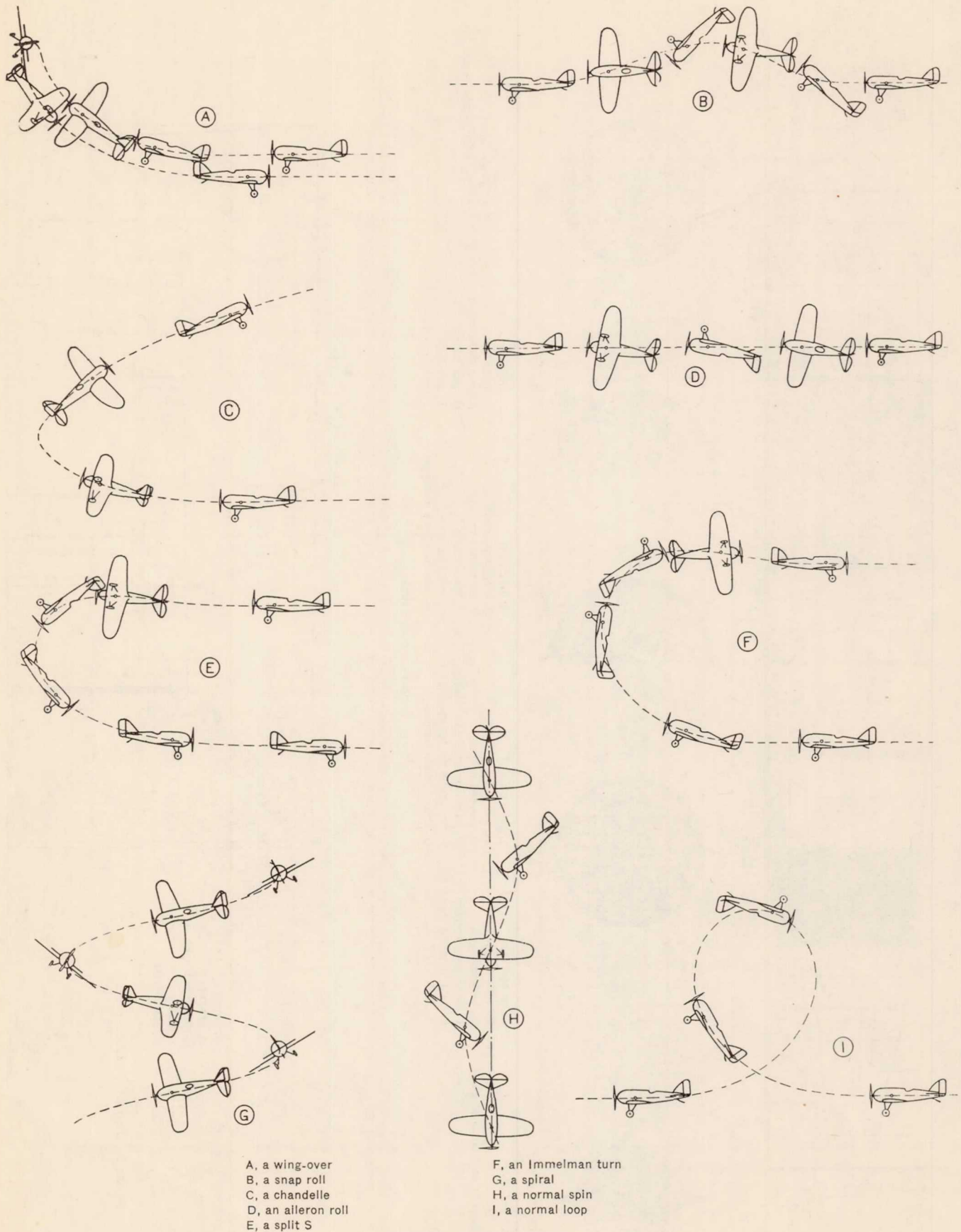
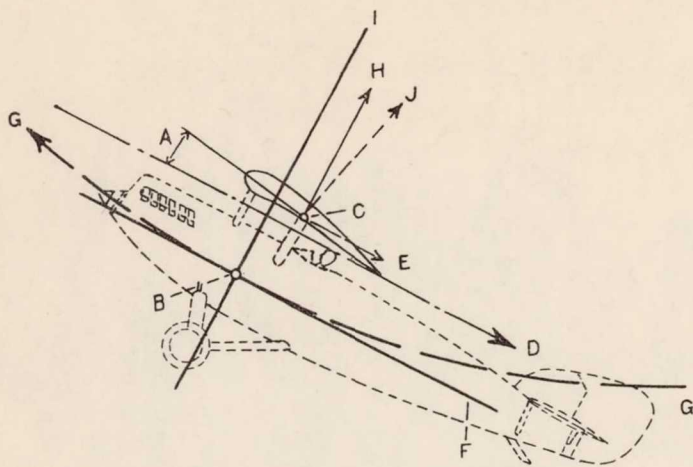
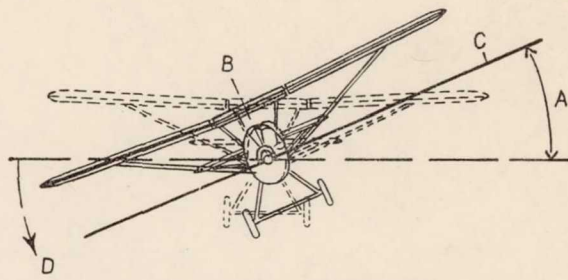

FIGURE 8.—Airplane maneuvers.



A, angle of attack
 B, center of gravity
 C, center of pressure
 D, direction of relative wind
 E, drag
 F, drag axis
 G, flight path
 H, lift, dynamic
 I, positive lift axis
 J, resultant force

FIGURE 9.—Lift and drag axes.



A, angle of roll
 B, c.g. and longitudinal axis
 C, lateral axis
 D, positive direction of roll

FIGURE 10.—Rolling.

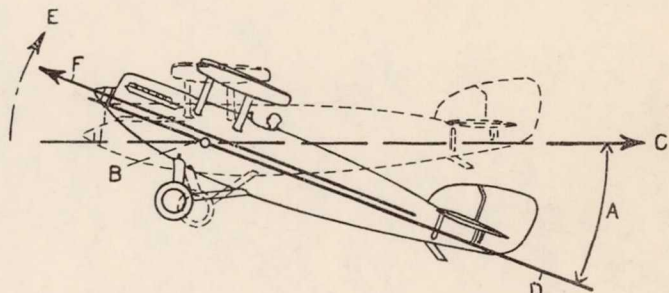

A, angle of pitch
 B, c.g. and lateral axis
 C, direction of relative wind
 D, longitudinal axis
 E, positive direction of pitch
 F, propeller thrust

FIGURE 12.—Pitching.

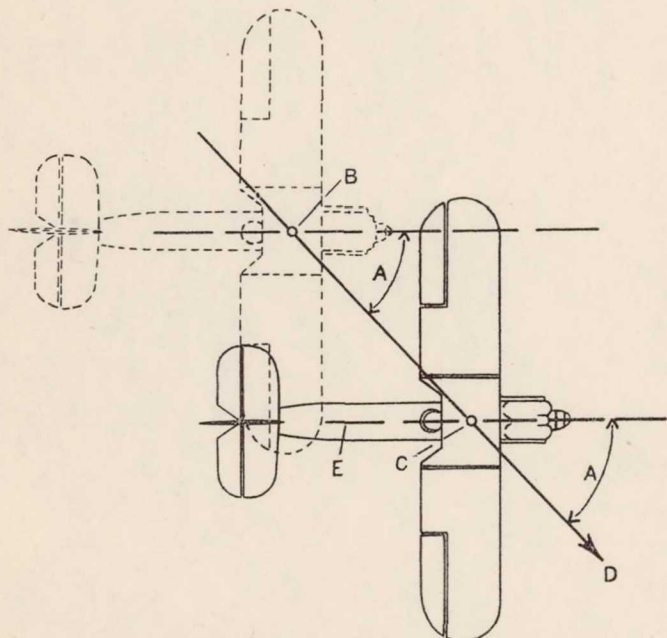

A, angle of sideslip
 B, center of gravity
 C, c.g. and normal axis
 D, direction of motion of aircraft
 E, longitudinal axis

FIGURE 11.—Sideslipping.

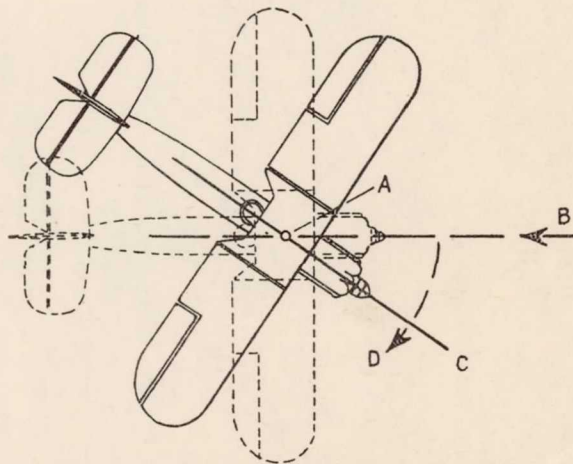

A, c.g. and normal axis
 B, direction of relative wind
 C, longitudinal axis
 D, positive direction of yaw

FIGURE 13.—Yawing.