

NASA/TM—2011–216458

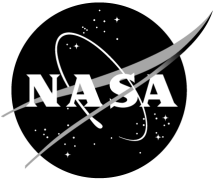

Executive Summary of Ares V: Lunar Capabilities Concept Review Through Phase A-Cycle 3

J.B. Holladay

Marshall Space Flight Center, Marshall Space Flight Center, Alabama

K.E. Baggett and S.M. Feldman

Zero Point Frontiers Corp., Huntsville, Alabama

February 2011

The NASA STI Program...in Profile

Since its founding, NASA has been dedicated to the advancement of aeronautics and space science. The NASA Scientific and Technical Information (STI) Program Office plays a key part in helping NASA maintain this important role.

The NASA STI Program Office is operated by Langley Research Center, the lead center for NASA's scientific and technical information. The NASA STI Program Office provides access to the NASA STI Database, the largest collection of aeronautical and space science STI in the world. The Program Office is also NASA's institutional mechanism for disseminating the results of its research and development activities. These results are published by NASA in the NASA STI Report Series, which includes the following report types:

- **TECHNICAL PUBLICATION.** Reports of completed research or a major significant phase of research that present the results of NASA programs and include extensive data or theoretical analysis. Includes compilations of significant scientific and technical data and information deemed to be of continuing reference value. NASA's counterpart of peer-reviewed formal professional papers but has less stringent limitations on manuscript length and extent of graphic presentations.
- **TECHNICAL MEMORANDUM.** Scientific and technical findings that are preliminary or of specialized interest, e.g., quick release reports, working papers, and bibliographies that contain minimal annotation. Does not contain extensive analysis.
- **CONTRACTOR REPORT.** Scientific and technical findings by NASA-sponsored contractors and grantees.
- **CONFERENCE PUBLICATION.** Collected papers from scientific and technical conferences, symposia, seminars, or other meetings sponsored or cosponsored by NASA.
- **SPECIAL PUBLICATION.** Scientific, technical, or historical information from NASA programs, projects, and mission, often concerned with subjects having substantial public interest.
- **TECHNICAL TRANSLATION.** English-language translations of foreign scientific and technical material pertinent to NASA's mission.

Specialized services that complement the STI Program Office's diverse offerings include creating custom thesauri, building customized databases, organizing and publishing research results...even providing videos.

For more information about the NASA STI Program Office, see the following:

- Access the NASA STI program home page at <<http://www.sti.nasa.gov>>
- E-mail your question via the Internet to <help@sti.nasa.gov>
- Fax your question to the NASA STI Help Desk at 443-757-5803
- Phone the NASA STI Help Desk at 443-757-5802
- Write to:
NASA STI Help Desk
NASA Center for AeroSpace Information
7115 Standard Drive
Hanover, MD 21076-1320

NASA/TM—2011–216458



Executive Summary of Ares V: Lunar Capabilities Concept Review Through Phase A-Cycle 3

J.B. Holladay

Marshall Space Flight Center, Marshall Space Flight Center, Alabama

K.E. Baggett and S.M. Feldman

Zero Point Frontiers Corp., Huntsville, Alabama

National Aeronautics and
Space Administration

Marshall Space Flight Center • MSFC, Alabama 35812

February 2011

Available from:

NASA Center for AeroSpace Information
7115 Standard Drive
Hanover, MD 21076-1320
443-757-5802

This report is also available in electronic form at
<<https://www2.sti.nasa.gov>>

TABLE OF CONTENTS

1. INTRODUCTION	1
2. ARES V VEHICLE EVOLUTION	4
3. TRADE SPACE SUMMARY AND CONCEPT EVOLUTION	12
3.1 Lunar Capabilities Concept Review Trade Space	12
3.2 Phase A-Cycle 1 Trade Space	14
3.3 Phase A-Cycle 2 Trade Space	14
3.4 Phase A-Cycle 3 Trade Space	15
3.5 Phase A-Cycle 3 Prime Trade Space	16
3.6 Phase A-Cycle 3 Double Prime Trade Space	20
3.7 Overall Trades Assessment	22
4. POINT-OF-DEPARTURE DESCRIPTION	23
4.1 Family-of-Vehicle Concept	23
4.2 Phase A-Cycle 3D—Description of the Candidate Point-of-Departure Vehicle	25
4.3 Ares V Point-of-Departure Performance Capability	33
5. ARES V MARS EXTENSIBILITY	34
5.1 Mars Transfer Vehicle Options: Nuclear Thermal Propulsion, Chemical, and Earth Departure Stage as Mars Transfer Vehicle Stage	34
5.2 In-Space Earth Departure Stage	37
5.3 Docking Adaptor and Propellant Transfer	38
5.4 Lunar and Mars Synergy	43
REFERENCES.....	45

LIST OF FIGURES

1.	Components of the Cx architecture	1
2.	Heritage systems utilized on Ares V	3
3.	Development history of Ares V from ESAS to LCCR	4
4.	Recent Ares V vehicle concepts leading to the 51-series concept	7
5.	Minimum performance assessed	10
6.	Ares V LCCR trade space (51-series vehicles)	13
7.	Shroud separation analysis: (a) Quad sector, (b) trisector, and (c) bisector	15
8.	Ares V CS base engine layout trade	16
9.	PA-C3D CS with horizontal engines	17
10.	Mass and volume requirements for multiple missions	21
11.	Maximum dynamic pressure versus vehicle payload	22
12.	Family of vehicles POD configuration for PA-C3''	24
13.	PA-C3D candidate POD vehicle (PA-C3')	25
14.	Expanded view of PA-C3D booster concept	26
15.	Ares V POD booster: Five-segment, PBAN propellant, steel case	27
16.	CS and booster sizing	28
17.	Ares V CS element view	29
18.	CS aft end expanded view	29
19.	Ares V EDS element view	31
20.	Ares V shroud element view	32

LIST OF FIGURES (Continued)

21.	Ares V avionics and software	33
22.	NTP launch sequence and payload mass requirements	35
23.	Chemical propulsion module option	36
24.	Propellant delivery and transfer option (EDS-as-MTV-stage)	37
25.	EDS concept for (a) lunar and (b) Mars architecture	38
26.	N-point docking mechanism with (a) and (c) latching claw, and (b) probes	39
27.	EDS-as-MTV model for loads and stress analysis	41
28.	Chemical propulsion model for loads and stress analysis	42
29.	Dedicated in-space chemical propulsion stage and truss detail	42
30.	Docking adaptor mechanism and ring structure	43

LIST OF TABLES

1.	Ares V VI major trades summary	18
2.	Family of vehicles concept comparison	23
3.	Performance analysis for candidate POD configurations	24
4.	Phasing trajectory sample functions	40

LIST OF ACRONYMS AND SYMBOLS

3DOF	three degrees of freedom
ACO	Advanced Concepts Office
ACU	actuator control unit
Al-Li	aluminum-lithium
APO	Ares Project Office
ATP	authority-to-proceed
BCPDU	booster control and power distribution unit
BDM	booster deceleration motors
BSM	booster separation motors
CAD	computer aided design
CARD	Constellation Architecture Requirements Document
CEV	Crew Exploration Vehicle
CFD	computational fluid dynamics
CFM	cryogenic fluid management
CLV	Crew Launch Vehicle
CS	core stage
CSB	core stage bulkhead
CSCU	core stage control unit
CSE	core stage engine
CVS	Concept Validation Study
Cx	Constellation
CxAT	Constellation Architecture Team
CxP	Constellation Program
DACU	data acquisition and control unit
DARU	data acquisition and record unit
DDT&E	design, development, test, and evaluation
DFIS	development flight instrumentation system
DoD	Department of Defense

LIST OF ACRONYMS AND SYMBOLS (Continued)

DRA 5.0	Design Reference Architecture 5.0
DRM	Design Reference Mission
EDS	Earth Departure Stage
EELV	evolved expendable launch vehicle
EPS	electrical power system
ESAS	Exploration Systems Architecture Study
ET	external tank
ETO	Earth-to-orbit
FEM	finite element model
FOM	figures of merit
FPR	flight performance reserve
FSS	flight safety system
GLOM	gross liftoff mass
GN&C	guidance, navigation, and control
HLLV	heavy-lift launch vehicle
HTPB	hydroxyl-terminated polybutadiene
IDA	integrated design and analysis
IDAC	integrated design and analysis cycle
IDAWG	integrated design and analysis working group
IMLEO	initial mass in low-Earth orbit
IOP	ignition overpressure
IS	imaging system
IS1	interstage 1
IS2	interstage 2
IS3	interstage 3
ISS	International Space Station
KSC	Kennedy Space Center
LCCR	Lunar Capabilities Concept Review
LEO	low-Earth orbit
LH ₂	liquid hydrogen

LIST OF ACRONYMS AND SYMBOLS (Continued)

LOI	lunar orbit insertion
LOX	liquid oxygen
LRB	liquid rocket booster
LV	launch vehicle
MAF	Michoud Assembly Facility
MCR	Mission Concepts Review
MER	mass estimating relationship
MGA	mass growth allowances
MMOD	micrometeoroids and orbital debris
MOI	Mars orbit insertion
MPS	main propulsion system
MTV	Mars transfer vehicle
NEO	near-Earth orbit
NTP	nuclear thermal propulsion
OD	outer diameter
OFI	operational flight instrumentation
OML	outer mold line
OMS	orbital maneuvering system
PA-C1	Phase A-Cycle 1
PA-C2	Phase A-Cycle 2
PA-C3	Phase A-Cycle 3
PA-C3'	Phase A-Cycle 3 prime
PA-C3''	Phase A-Cycle 3 double prime
PA-C3A	Phase A-Cycle 3A (launch vehicle)
PA-C3B	Phase A-Cycle 3B (launch vehicle)
PA-C3C	Phase A-Cycle 3C (launch vehicle)
PA-C3D	Phase A-Cycle 3D (launch vehicle)
PA-C3E	Phase A-Cycle 3E (launch vehicle)
PA-C3F	Phase A-Cycle 3F (launch vehicle)
PA-C3G	Phase A-Cycle 3G (launch vehicle)

LIST OF ACRONYMS AND SYMBOLS (Continued)

PA-C3H	Phase A-Cycle 3H (launch vehicle)
PA-C4	Phase A-Cycle 4
PBAN	polybutadiene acrylonitrile
POD	point-of-departure
RFCS	radio frequency communication system
RS	recovery system
RSRB	reusable solid rocket booster
S&A	safe and arm
SBKF	shell buckling knockdown factor
SFA	Shortfall Assessment
SRB	solid rocket booster
SRR	Systems Requirements Review
SSME	Space Shuttle Main Engine
STS	Space Transportation System
TCS	thermal control system
TEI	trans-Earth injection
TLI	translunar injection
TMI	trans-Mars injection
TPS	thermal protection system
TransHab	transit habitat
TVC	thrust vector control
TVEC	thrust vector control electronics
U.S.	United States
USAF	United States Air Force
VI	vehicle integration
ZBO	zero boiloff

NOMENCLATURE

dV	delta velocity
I_{sp}	specific impulse
Q	dynamic pressure

TECHNICAL MEMORANDUM

EXECUTIVE SUMMARY OF ARES V: LUNAR CAPABILITIES CONCEPT REVIEW THROUGH PHASE A-CYCLE 3

1. INTRODUCTION

This Technical Memorandum (TM) is intended to provide an overview of the current Ares V heavy-lift launch vehicle (HLLV) including its mission, role, and interfaces within the Constellation (Cx) architecture. It is meant to act as both a stand-alone record and a supplemental summary, such that follow-on appendices might be coupled with the Executive Summary to form a narrative. Each appendix will function independently of the others (Detailed Element Description, Payload Integration, etc.)

The Ares V HLLV provides the heavy lift capability for the Cx Program's (CxP's) exploration architecture. To use proven technologies, components, and infrastructure from the Saturn, Space Shuttle, and contemporary launch vehicle (LV) programs was a goal established during the Exploration Systems Architecture Study (ESAS) for Ares V and the Ares I Crew LV (CLV). Also where feasible, the Ares V project is directed to seek commonality between the Ares LVs to minimize development and operational costs and improve safety and reliability. The vehicle components of the Cx architecture are shown in figure 1.

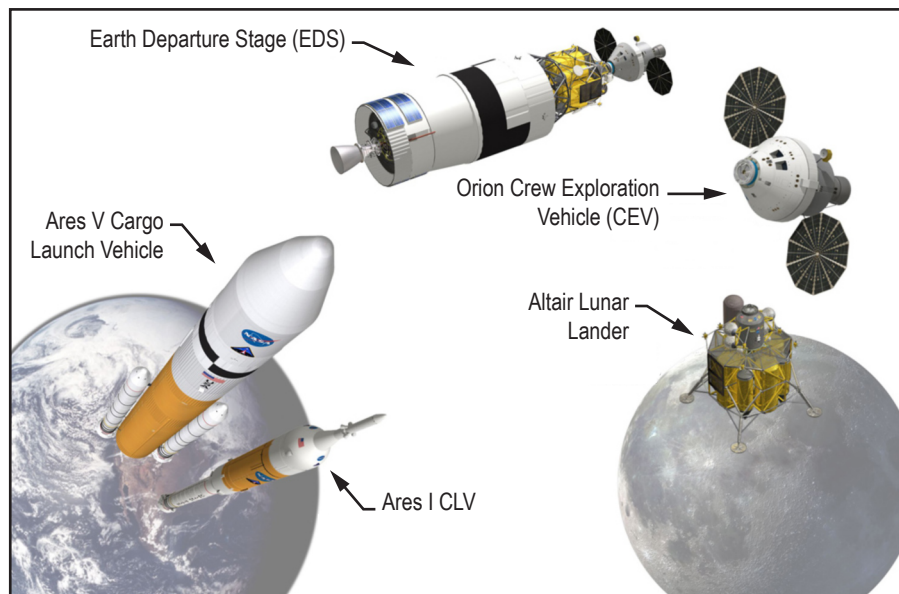

Figure 1. Components of the Cx architecture.¹

In order to carry out the National Space Policy directive to replace the Space Shuttle and complete the International Space Station (ISS), the Constellation development plan focuses on developing the Ares I and making it operational by 2015. Ares V is scheduled for a 2011 authority-to-proceed (ATP) decision that would enable it to make its first flight in 2018 and support lunar exploration in 2020.

The primary mission of the Ares V is to launch the Altair lunar lander into low-Earth orbit (LEO) and then send the lander and the Orion CEV into a translunar injection (TLI) trajectory to the Moon. (The Orion CEV is launched separately on Ares I.) In addition to crewed missions, Ares V will also launch automated cargo landers into LEO and then to specific lunar destinations. While retaining the goals of heritage hardware and commonality, the Ares V configuration continues to be refined through a series of internal trades to be discussed later in this TM. The previous Ares V point-of-departure (POD) configuration was an iteration of a study recommended by the Ares projects and approved by the CxP during the Lunar Capabilities Concept Review (LCCR)/Ares V Mission Concept Review (MCR) in June 2008.

In the current mission profile, the Ares V is launched from Kennedy Space Center (KSC) in Florida. Following booster and core stage (CS) separation, the Ares V EDS engine ignites at altitude, followed by separation of the payload shroud. Shroud separation occurs last in the staging sequence prior to reaching LEO to avoid recontact with the LV stack. The EDS delivers the EDS/Altair stack into a stable LEO loiter orbit. Concurrently, the Orion CEV, launched by the Ares I, performs a rendezvous-and-dock maneuver with the EDS/Altair stack. After successful docking, ground controllers complete a system checkout of the EDS before it reignites its engine to perform the TLI burn and send the mated EDS/Altair/Orion stack to the Moon. The EDS is discarded after completion of the TLI burn, which marks the end of the Ares portion of the lunar mission. The current concept of operations calls for an Ares V launch as early as 90 min after Ares I, with three subsequent launch opportunities over the following 3 days, one launch opportunity per day. Ares V is currently designed for a 4-day loiter with TLI on the fourth day.

The design of Ares V shapes, and is shaped by, the requirements and designs of the other Cx components. The Ares V first stage booster is designed to share hardware, technologies, and manufacturing and operational facilities found in the Shuttle boosters. The Ares V EDS will share the J-2X engine and various subsystems now being developed for the Ares I upper stage. The Ares V CS design also employs five or six commercial RS-68 engines now used on the Delta IV. In the case of all those common components (shown in fig. 2), the Ares V application will require modifications for the Ares V mission that requires interface with the relevant hardware and management organizations. Ares V must also interface with the Orion and Altair projects regarding basic weight and volume requirements and numerous other design parameters such as the payload adapter and utilities supplied to Altair; structural, thermal, and acoustic loads; on-orbit power and thermal requirements; etc.

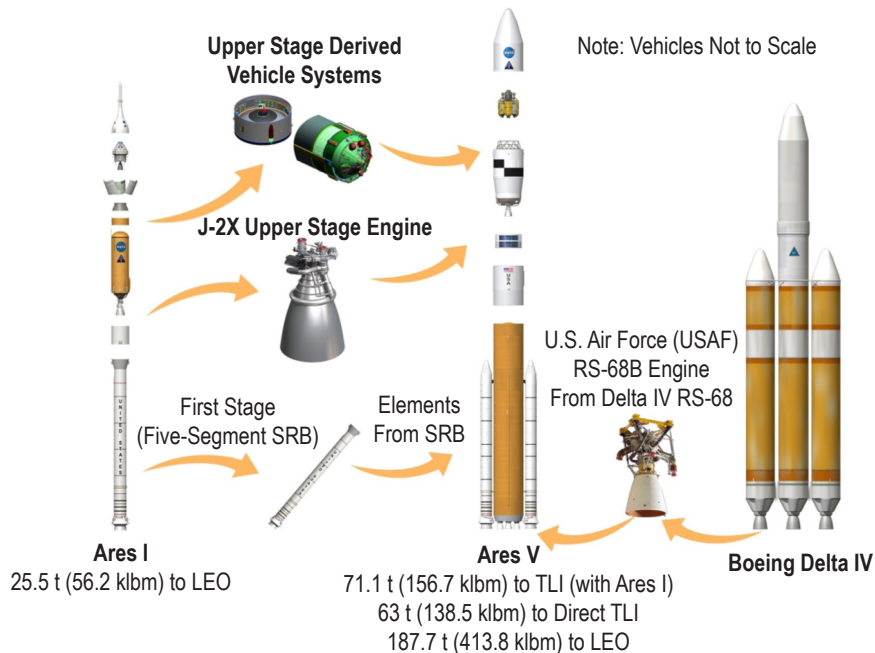

Figure 2. Heritage systems utilized on Ares V.

The Constellation Architecture Requirements Document (CARD) provides the mass requirements for both the lunar sortie (crewed) and lunar cargo design reference missions (DRMs).²

For the lunar sortie mission, the CARD specifies an Orion control mass of 20.2 t (44,500 lbm) and a lunar lander control mass of 45 t (99,208 lbm). The sortie mission assumes a LEO destination orbit of 242 km (130 nmi) at a 29° inclination. The CARD loiter duration is not specified but has continued to evolve with program trades from 95 days to 14 days. For the LCCR trades, it was further reduced to 4 days. The TLI maneuver begins at a minimum 185-km (100-nmi) altitude with a delta velocity (dV) requirement of 3,175 m/s (10,417 ft/s) plus gravity loss.

For the cargo mission, the CARD specifies a cargo lander control mass of 53.6 t (118,168 lbm) and a total TLI payload mass of 54.6 t (120,372 lbm). The cargo mission assumes a phasing orbit Earth-to-orbit (ETO) destination. A loiter requirement is unnecessary because Orion is not part of the cargo mission operations concept; however, a few revolutions in LEO are anticipated to allow for system checkout prior to the TLI burn. It is worth noting that the Saturn V TLI payload capability was 48.6 t (107,445 lbm) for the Apollo 17 mission.

The CARD also imposes additional requirements on the Ares V such as the use of the five-segment solid rocket booster (SRB) and five RS-68B engines in the CS and the Mars mission mass requirements.

2. ARES V VEHICLE EVOLUTION

The first designs for a heavy lift capability that would eventually be named Ares V were studied during ESAS, which began in 2005.³ From ESAS to the concept approved during LCCR as the Ares V MCR POD concept, NASA studied more than 1,700 configurations of the Ares V. Following the LCCR POD, several trade studies were performed that resulted in an updated POD known as the Phase A-Cycle 3D (PA-C3D) concept. This section will summarize the evolution of Ares V from the ESAS trades up to the PA-C3D concept, including the 51.00.39 concept that served as the entry point to the LCCR trade study. An overview of the Ares V development history is shown in figure 3, including the LCCR trade space options and recommended POD concept approved by CxP, both of which will be detailed in later sections. A description of the major trades leading to the pre-51.00.39 concept follows.

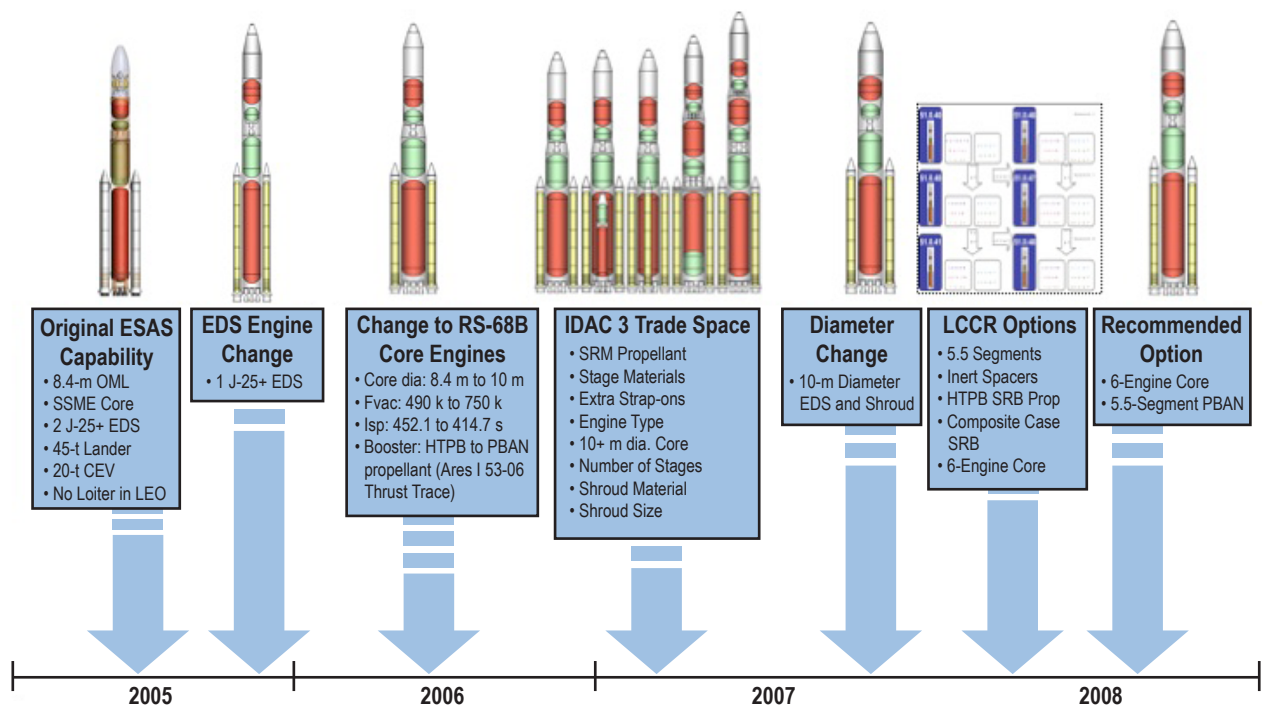

Figure 3. Development history of Ares V from ESAS to LCCR.

NASA studied commercial, government, and concept LV architecture systems prior to 2005, culminating in the release of the ESAS final report. In a trade tree pruning exercise, the ESAS team evaluated the following eight options:

- (1) Nonassisted versus assisted takeoff.

- (2) Vertical versus horizontal takeoff.
- (3) In-flight propellant tanking versus no tanking.
- (4) Rocket versus rocket and air breathing versus air breathing propulsion.
- (5) Expendable versus partially reusable versus fully reusable systems.
- (6) Single-stage versus two-stage versus three-stage concepts.
- (7) 'Clean-sheet' versus derivative systems.
- (8) Evolved expendable LV- (EELV-) derived vehicles versus both side-mount and in-line Space Shuttle-derived vehicles versus clean-sheet LV architectures.

Figures of merit (FOMs) used in the studies were: Cost, reliability, safety, programmatic risk, mission performance, and schedule. These FOMs were applied to drive out the best option in the analysis. Additional considerations included legal requirements from the NASA Authorization Act of 2005, workforce skills, and industrial capabilities. After a thorough analysis of the entire exploration architecture requirements, EELV solutions were decided to be less safe, less reliable, and more costly than the Space Shuttle-derived solutions. The ESAS concluded that NASA should pursue the Space Shuttle-derived architecture for exploration due to several advantages relating to safety, reliability, and cost. The Space Shuttle-derived approach also allowed NASA to leverage significant existing ground infrastructure investments and personnel with significant human space flight experience. Overall, the Space Shuttle-derived approach was found to be the most affordable, safest, and reliable, both by leveraging proven human-rated vehicles and infrastructure elements and by using common elements across the architecture.

The ESAS-recommended Ares V vehicle, designated Concept 27.3, included two five-segment steel-case SRBs with hydroxyl-terminated polybutadiene (HTPB) propellant, which has a higher specific impulse (I_{sp}), density, and better mechanical properties than the polybutadiene acrylonitrile (PBAN) fueled Space Shuttle SRB. This Ares V concept had an 8.4-m (27.5-ft) diameter Space Shuttle external tank (ET) derived CS powered by five RS-25 Space Shuttle Main Engines (SSME) redesigned to be low cost and expendable. The 8.4-m (27.5-ft) diameter EDS was powered by two liquid oxygen (LOX)/liquid hydrogen (LH₂) J-2S+ engines. Based on the 1970s era J-2S development program, the J-2S+ was intended to be a simplified version of the J-2 engine used for the Saturn upper stages. Both the CS and EDS had aluminum-lithium (Al-Li) structures and propellant tanks. The Ares V variant had a gross liftoff mass (GLOM) of nearly 2,900 t (6.4 Mlbm). It was based on a 45-t (99,000-lbm) lunar lander, a 20-t (44,000-lbm) CEV, and no loiter capability in LEO.

In the subsequent NASA studies to refine the ESAS recommendations, the architecture was simplified to reduce the number of new development programs. Further analysis of EDS performance showed that using a single J-2S+ engine provided more performance than two J-2S+ engines because the additional thrust provided by two engines during the ascent burn did not make up for

the second engine's mass during the less-thrust-to-weight-sensitive TLI burn. When Ares I propulsion changed from a four-segment booster to a five-segment booster for the first stage and from the RS-25 to a more powerful evolution of the J-2 (dubbed J-2X) for the upper stage, it opened the trade space on Ares V. A single J-2X replaced the J-2S+ engine on the Ares V EDS. The RS-68B, a variant of the commercial engine flying on the Boeing Delta IV vehicle, was leveraged for the Ares V CS. The RS-68 was designed as a simple, expendable engine with a high production rate. Using the RS-68 offered the opportunity to partner with the Department of Defense (DoD) to lower unit costs and gain flight maturity on Delta IV engine upgrades prior to Ares V flights. Program savings were estimated to be approximately \$4.25 billion over the RS-25 SSME-based ESAS concept due to the high cost of producing a nonrecovered, nonrefurbished SSME.

Because of the RS-68B's lower efficiency, the CS was enlarged from 8.4 m (27.5 ft) to 10 m (33 ft) in diameter to hold the additional propellants needed and to accommodate the larger nozzle and exhaust clearances needed for the larger engine cluster. The lower initial and recurring costs of the RS-68B and the cost, technical, schedule, and reliability risks involved with redesigning the RS-25 for altitude start, outweighed the cost of developing Saturn-class tooling and facilities needed to manufacture and process the larger CS. The booster design also reverted from HTPB to PBAN solid propellant for its better technical maturity and commonality with Ares I. The resulting Ares V configuration, designated Concept 33.8.64, had a GLOM of 3,300 t (7.3 Mlbm) and was nearly 110 m (362 ft) tall. It exceeded the payload performance of the RS-25 solution by approximately 4 t (8,800 lbm) to TLI and enhanced the commonality between the Ares vehicles, improving both development and operational efficiencies.

Concept 33.8.64 evolved in a series of configuration trades involving shroud diameter, direct lunar missions, CEV and upper stage on the Ares V, added gravity losses on TLI burns, and Flight Performance Reserve (FPR) allocation change. The resulting POD was the 45.0.2 concept vehicle. Nearly 111 m (365 ft) tall, the new concept served as a benchmark to determine the effects of engine upgrades, SRB variations, alternate materials, added stages, added boosters, added engines, and increased stage diameter. The effort established the impact of several changes that would be important to later trades including composite tanks and structures, additional CS engines (CSEs), additional SRBs or liquid rocket boosters (LRBs), and the addition of an S-II-class second stage as a third liquid stage.

However, the study also concluded that composite propellant tanks carried a high technical risk. HTPB boosters and a third stage carried undesirably high design, development, test, and evaluation (DDT&E) costs (the third stage was a cost and reliability issue). Additional SRBs incurred undesirable high launch pad modification costs, and vehicles more than 122 m (400 ft) tall led to prohibitive KSC facility costs.

The 46 and 47 series were both studies of three-stage vehicles with four and five J-2X engine second stages and shortened and lengthened CSs, respectively. Variants within those series traded the use of the commercial RL-10B2 engine on the third stage, six RS-68B core engines, nested tanks, and other changes. The three-stage designs offered higher performance and reduced loads through the TLI phase. They also allowed the lunar orbit insertion (LOI) and TLI maneuvers to be performed by the third stage, which would reduce the size of Altair. However, the addition

of a second stage with four to five J-2X engines (instead of one) and a unique third stage added significant costs. The cost benefits to the Altair project resulting from Ares V, assuming the LOI functionality, were shown to be minimal. Propulsion systems, particularly the number of engines, are primary contributors to LV reliability, and the increased number of engines for these three-stage options resulted in an overall lower vehicle reliability.

The 45 series then served as the starting point for trades that became the 51 series of Ares V concepts, which, in turn, served as the basis of the LCCR trade space formally assessed in June 2008. This LCCR also acted as the Ares V MCR, ultimately identifying a POD vehicle and satisfying MCR criteria. Figure 4 shows the common features and notable variants of the 45-, 46-, 47-, and 51-series concepts.

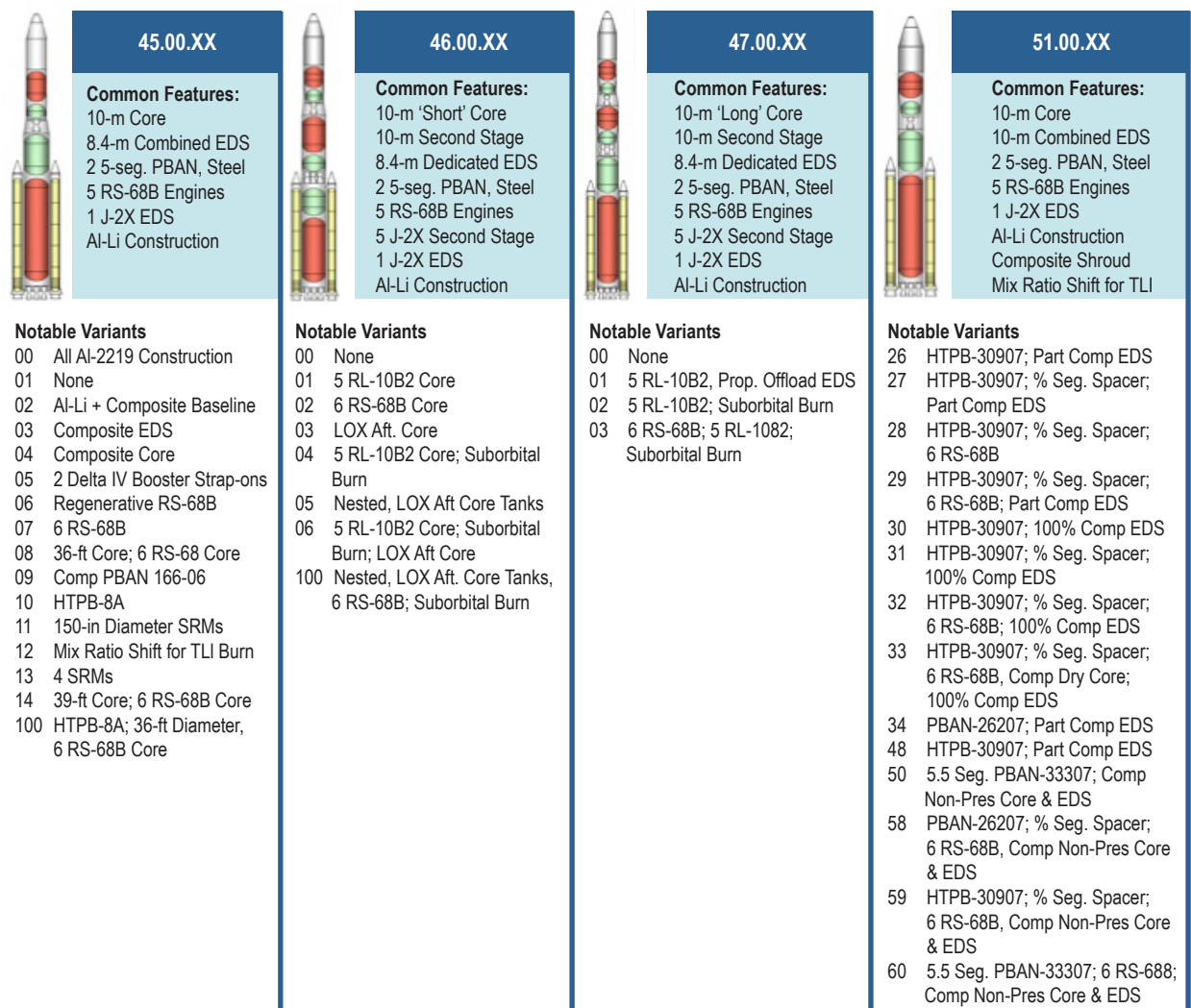

Figure 4. Recent Ares V vehicle concepts leading to the 51-series concept.

Common features to all 51-series configurations are a 10-m (33-ft) diameter outer mold line (OML), composite materials for the payload shroud and all dry structures, and metallic (Al-Li) propellant tanks for the EDS and CS. The 51-series vehicles reflect the following changes in ground rules and assumptions to the 45.0.2 concept:

- 4-day to 14-day loiter period.
- 222-km (120-nmi) to 242-km (130-nmi) injection orbit.
- 8.4-m (27.5-ft) to 10-m (33-ft) EDS diameter.
- 8.4-m (27.5-ft) to 10-m (33-ft) payload shroud.

The 51-series trades were driven by the Performance Enhancement Study findings regarding increased CS propellant load, SRB propellant and length, and the addition of a sixth CSE. The 51.00.39 concept was selected as the entry POD for the LCCR and is characterized by its 10-m (33-ft) standard CS with five RS-68B engines and two five-segment steel-case PBAN-propellant reusable SRBs. Its TLI payload capability, in conjunction with Ares I, was 63.6 t (140,214 lbm). As a direct result of the 51.00.39 vehicle falling short of the CARD performance requirement for the Ares V vehicle, other concepts were presented at the LCCR that met or exceeded the derived 65.2-t (143,741-lbm) TLI requirement (Altair 45 t (99,028 lbm) + Orion 20.2 t (44,553 lbm)). These options are discussed further in section 3.1, LCCR Trade Space. Notably, the 51.00.48 concept was the preferred option as the new Ares V POD. It was characterized by longer SRBs (five and a half segments as opposed to five segments on the 51.00.39), which in turn allowed the CS to increase in length. Furthermore, the additional propellant load in this longer CS benefited greatly from the addition of a sixth RS-68B. This configuration provided about 71.1 t (156,749 lbm) to TLI, exceeding the 65.2 t (143,741 lbm) requirement by almost 6 t (13,227 lbm). While not meeting the desired LCCR goal of 75 t (165,347 lbm) to TLI, this provided about 6 t (13,227 lbm) of margin to the program, and it allowed for closure of the overall mission architecture.

Following the LCCR, the Ares Project Office (APO) desired a bottoms-up engineering assessment of the LCCR vehicle. What came to be known as the Concept Validation Study (CVS) followed, allowing the engineering expertise from across the Agency to focus on specific design traits of the Ares V vehicle and provide confidence in the LCCR POD vehicle. Several areas of focus were identified including the functionality required during the loiter period, restartability of the EDS engine, a new aerodynamic model of the POD utilizing the Agency wind tunnel assets, the development of a computational fluid dynamics (CFD) model, and several others. Overall, this more detailed analysis provided the initial step from an advanced conceptual design using basic structural analysis, three degrees of freedom (3DOF) physics-based trajectory tools, and subsystem design using mass estimating relationships (MERs) to an engineering-based model using Agency assets in several engineering disciplines. This more detailed analysis assessed the performance of the LCCR/MCR vehicle at 68.3 t (150,576 lbm), approximately 4% different from the concept assessed for the LCCR. This reduced the project margin from almost 6 t (13,227 lbm) to slightly over 3 t (6,614 lbm).

Following the CVS, the APO established formal operating cycles for the Ares V vehicle with a plan for proceeding to the next project milestone—the Ares V Systems Requirements Review (SRR). The vehicle was divided into seven Level 4 elements (reusable SRB (RSRB), CS, CSE, EDS, EDS engine, shroud, and avionics/software), which were integrated by the vehicle integration (VI) team. The establishment of formal analysis cycle products, interim checkpoints, and working technical interchange meetings characterized these cycles. The first of these was Phase A-Cycle 1 (PA-C1) that ran from January 2009 through the end of April 2009. This cycle built upon the knowledge gained during the CVS but put it in the framework of an overall operating rhythm. While the analysis team further developed the models needed to assess the performance of the vehicle, products were established that focused on requirements of the system, the concept of operations of the system, and functional analysis. Additional analysis of the vehicle resulted in the TLI performance of the vehicle to drop from 68.3 t (150,576 lbm) down to 66.8 t (147,269 lbm), a reduction of 1.5 t (3,307 lbm), and resulting in the loss of half of the remaining project margin.

This reduction in TLI payload caused the APO to focus Phase A-Cycle 2 (PA-C2) on establishing lower and upper bounds on the performance of the Ares vehicle while continuing the development of the products focused on requirements, operability, and functional analysis. This cycle ran from May 2009 through the end of September 2009. First, the shortfall assessment (SFA) was an effort to establish a lower bound on performance by using additional margins and mass growth allowances (MGA) where appropriate, assessing the vehicle at higher loads, increasing reserves and required TLI dV , decreasing engine performance, and varying other design criteria such as propellant density, propellant boiloff rates during the loiter period, etc. The SFA came to the conclusion that a reasonable lower bound for Ares V performance would be in the range of 58 t (127,868 lbm) to TLI, over 13 t (28,660 lbm) less than the LCCR POD and 7 t (15,432 lbm) less than the CARD requirement.

The upper bound was established by focusing the PA-C2 study configuration on a vehicle with evolved performance characteristics, such as a regeneratively cooled nozzle RS-68 (known as the RS-68B-E/0) with an increased I_{sp} and a five-segment RSRB with shared commonality with the Ares I booster (same case lengths, propellant, avionics, TVC, nozzle length, etc.) but a more optimized propellant grain design for use on the Ares V. To maintain the propellant loading of the CS without increasing the diameter, an inert (empty steel case) spacer was added to the top of the booster. This provided the height necessary to attach the booster between the LOX and LH₂ tanks of the CS. In addition, design assumptions that increased performance (or decreased loads on the vehicle) were the constraining of maximum dynamic pressure (Q) to 800 psf, increasing the knock-down factor used for global buckling calculations, utilizing the pressure inside the tank to alleviate flight loads for the purposes of tank design/analysis, and others. Overall, these changes resulted in an upper bound of 73.7 t (162,481 lbm), 8.5 t (18,739 lbm) (more than the CARD requirement). The establishment of the bounds, ranging from 58 t (127,868 lbm) to almost 74 t (163,142 lbm), provided confidence that as the design analysis maturity increased (and design uncertainty decreased) the Ares V had options available to meet the 65.2 t (143,741 lbm) CARD requirement.

While PA-C2 was underway, there was a great deal of uncertainty surrounding the architecture with respect to the Presidential Commission to assess the progress of the CxP and provide alternatives for space exploration, known as the United States (U.S.) Human Space Flight Plans Committee or the Augustine Committee. Thus, the APO management team approached Phase A-Cycle 3 (PA-C3) in a flexible manner. PA-C3 study configurations were established that would optimize the Ares V vehicle with respect to multiple key FOMs—specifically the shortest development time (and likely lowest cost) and maximum performance—with a combination of either. In this manner, specific recommendations from the Augustine Committee could be implemented based on the key drivers that those recommendations were derived from. Figure 5 shows the specific study configurations for PA-C3, in addition to the LCCR Study, PA-C1, and PA-C2 vehicles that were previously assessed. A process was established to conceptually size a vehicle based on trajectory modeling, loads characterization, mass properties best practices, and element trades/analysis input. This provided a key understanding of vehicle options and performance trade space. PA-C3 ultimately assessed eight vehicles, and the characteristics of each may be seen in figure 5.

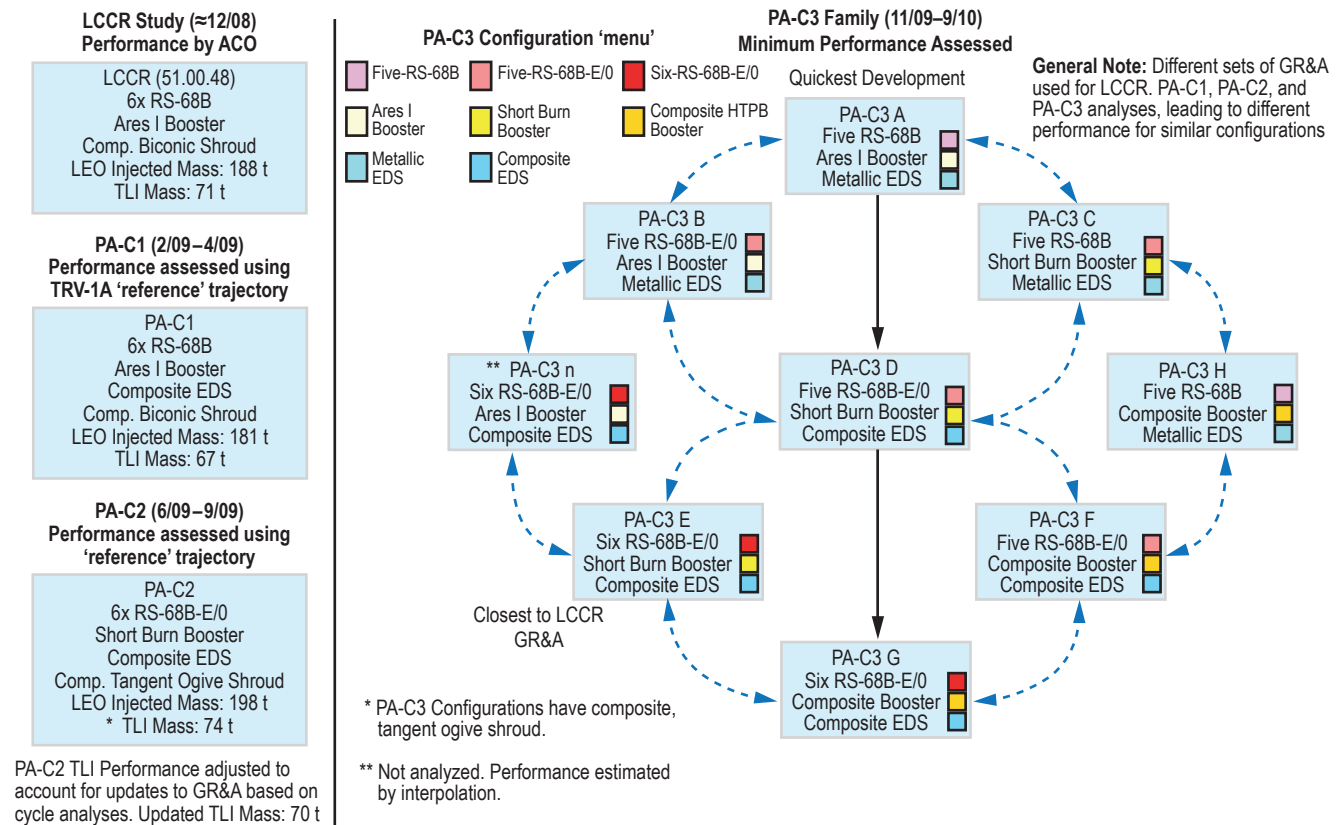

Figure 5. Minimum performance assessed.

The overall vehicle maintained common attributes from the previous PA-C2 vehicle: The 33-ft OML, two SRBs, one J-2X on the EDS, etc. The number of CSEs was reduced from six to five for the Phase A-Cycle 3D (PA-C3D) vehicle based on the increased performance assessed during PA-C2. However, the types of CSEs and RSRB were varied, which are currently thought to be the critical path items for the Ares V vehicle development. Phase A-Cycle 3A (PA-C3A) was perceived to be the shortest development time, utilizing the Ares I booster directly (and the resulting development schedule and cost savings from doing so) and the NASA/Air Force upgraded RS-68B CSE. If more performance were recommended, then the regeneratively cooled, enhanced- I_{sp} RS-68B-E/0 CSE would be used, along with an RSRB grain design tailored for use on the Ares V. This vehicle configuration was dubbed PA-C3D. A combination of these RSRB and CSE options made up Phase A-Cycle C3B (PA-C3B) and PA-C3C.

Following the analyses performed for the B and C vehicles, Phase A-Cycle 3E (PA-C3E) through Phase A-Cycle 3H (PA-C3H) vehicles were identified as extensions of the POD family concept. The descriptions of these vehicles are detailed in section 4.1 along with their resulting performances.

During PA-C3, which ran from approximately October 2009 through early March 2010, analysis was completed on the PA-C3A and PA-C3D configurations with the assumption that performance for the PA-C3B and PA-C3C configurations would fall in between those values. With the less efficient RS-68B, reduction of one CSE, and the less optimized Ares I booster, the performance of the PA-C3A configuration was about 55.2 t (121,695 lbm) to TLI. With the more efficient RS-68B-E/0 engine and a more optimized thrust trace on the SRB, the PA-C3D configuration delivered about 64.8 t (142,860 lbm) to TLI, less than 0.5 t (1,102 lbm) from the CARD requirement. This is near the center of the performance distribution found during PA-C2, mainly due to the reduction of one CSE, the use of minimum guaranteed performance values on the engines, increased flight performance reserves, and other design assumptions. With the performance of this vehicle near the CARD performance requirement, it was decided that this vehicle would serve as the new Ares V POD design. This vehicle is further detailed in section 4.2.

3. TRADE SPACE SUMMARY AND CONCEPT EVOLUTION

This section focuses on the trade space and the primary concept vehicles assessed during the LCCR/Ares V MCR through PA-C3. The first trade space discussed is based on the 51.00.39 concept used as the entry point for the LCCR and is briefly described in section 3.1. PA-C1 analysis allowed for the full transition from an advanced conceptual design to an engineering-based model with established analysis products, to include assessment of the POD concept approved at the LCCR/Ares V MCR in June 2008. Architecture evolution from the LCCR (51.00.48) led to the more detailed configuration discussed in section 3.2. PA-C2 focused on verifying the design process, validating performance requirements, and assessment of key Ares V sensitivities until September 2009. Trade studies performed during this time are described in section 3.3. Following PA-C2, refined performance targets were matched to programmatic cost and schedule requirements resulting in a PA-C3 configuration. Multiple iterations of this configuration were performed producing the current POD LV employed, called the PA-C3D vehicle. The following descriptions highlight the cycles and introduce the trades associated with each. More detailed descriptions of the major trades performed for the Mars extensibility study (Phase A-Cycle 3 Prime (PA-C3') through Phase A-Cycle 3 Double Prime (PA-C3'')) are also given since this served as the umbrella analysis for other trades and studies.

3.1 Lunar Capabilities Concept Review Trade Space

At the beginning of the Cx lunar study, the Ares V LCCR trade space focused on six vehicles based on the 51-series configuration. The 51-series configuration established a set of features common to all vehicles within the trade space, specifically:

- 10-m (33-ft) diameter OML for the central stack.
- Composite dry structures for the CS, EDS, and shroud.
- Metallic propellant tanks for the CS and EDS.
- A single J-2X EDS engine.
- At least five CS RS-68B engines.
- 9.7-m (31.8-ft) shroud barrel length.

The trade space was created by combining variations of both the CS and booster into different configurations of the Ares V vehicle. As one dimension of the trade space, two variations of the CS were considered. The first variation consists of a standard size CS with five RS-68B engines, and the second variation represents an extended CS with six RS-68B engines. As the second dimension of the trade space, three booster variations were leveraged to fully define the Ares V trade

space. These booster variations were the five-segment, PBAN steel booster; the 5.5-segment, PBAN steel booster; and the five-segment, HTPB composite booster. As was discussed in the introduction, numerous vehicle permutations were analyzed leading up the 51.00.39 concept. The other five concepts that made up the LCCR trade space were the 51.00.40, 51.00.41, 51.00.46, 51.00.47, and 51.00.48. Figure 6 summarizes the common features to the 51-series trade space and the distinguishing elements of each trade space concept.

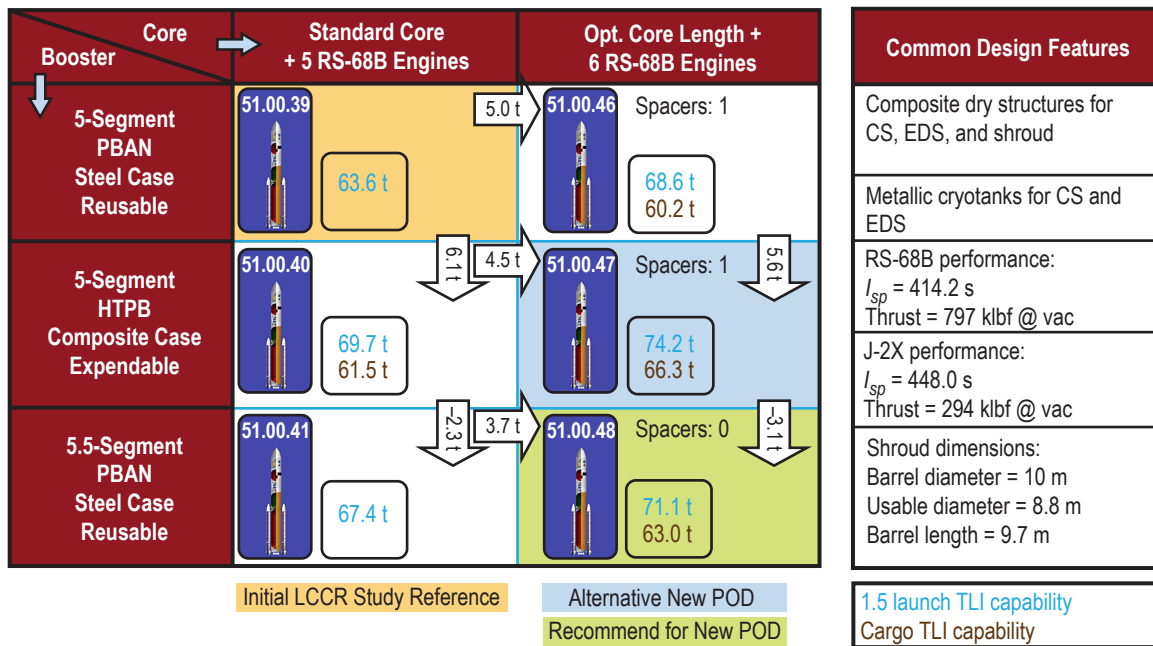

Figure 6. Ares V LCCR trade space (51-series vehicles).

The 51.00.39 concept vehicle is the entry POD to the Cx Architecture Team (CxAT) lunar study. This vehicle features a standard CS with five RS-68B engines and a five-segment, PBAN steel booster. It offers 63.6 t (140,200 lbm) of payload to TLI for crewed missions. The 51.00.39 does not meet the minimum performance requirement.

The 51.00.40 concept vehicle features a standard CS with five RS-68B engines and a five-segment, HTPB composite booster. The 51.00.40 concept can deliver 69.7 t (153, 700 lbm) of payload to TLI for crewed missions. While this concept surpasses the minimum performance requirement, two other concepts within the trade space offer greater performance. The 51.00.40 was therefore eliminated from the trade space.

The 51.00.41 concept vehicle is a variant of the 51.00.39 concept. It has the same CS configuration and features an additional half-segment, PBAN steel booster. Given that the 51.00.41 provides 67.4 t (148,600 lbm) of TLI payload performance, it was removed from the final consideration.

The 51.00.46 concept vehicle features the optional, extended CS with six RS-68B engines. It employs the standard five-segment, PBAN steel booster. The TLI payload capability is 68.6 t (151,200 lbm).

The 51.00.47 concept vehicle was chosen as an alternate concept during the LCCR. Its design features the extended CS with six RS-68B engines and the five-segment, HTPB composite booster. This particular combination of CS and booster option offers the greatest TLI payload performance for crewed missions of 74.2 t (163,600 lbm). While this concept delivers the most payload to TLI, its design is dependent upon a successful infusion of composite technology development and incurs significant cost increases.

The 51.00.48 concept vehicle was chosen as the new POD concept at the LCCR. Its primary attributes were the extended CS and the 5.5-segment, PBAN steel booster. The 51.00.48 did not require significant funding for technology development nor did it incur the largest production and DDT&E costs. The 51.00.48 vehicle met the CARD performance requirements plus some margin, but it did not fully meet the desired TLI payload goal of 75 t (165,300 lbm). Following the LCCR, further HLV design iterations were performed in order to reach a desired POD for the PA-C1 concept.

3.2 Phase A-Cycle 1 Trade Space

In order to achieve a higher fidelity design and mission analysis, the transition from the LCCR/MCR vehicle to the PA-C1 vehicle was marked by the development of key driving requirements, establishment of integration and element teams with associated analysis products through an integrated design and analysis (IDA) working group (IDAWG), processes for conducting trade studies and other analysis, requirements/functional analysis/operational concepts development and verification/validation efforts, etc.

The PA-C1 vehicle was a variant of the 51.00.48 concept with the same LOX/LH₂ CS configuration, two 5.5-segment, PBAN steel-case boosters; the LOX/LH₂ EDS; and the payload shroud. At a height of 116.74 m (383 ft), the PA-C1 vehicle configuration necessarily added height to the CS to match a 0.3-m (1-ft) increase in length to the SRBs (to satisfy the ground rule of keeping the exit of the nozzles coplanar). In addition, performance dictated an EDS length increase of 0.24 m (0.8 ft) using updated ground rules and assumptions, while the payload shroud was increased by 0.03 m (0.1 ft). These extensions resulted in an overall vehicle height increase of 0.58 m (1.9 ft) over the LCCR/Ares V MCR vehicle.

Trades during the PA-C1 timeframe were performed mainly at the element level. These include the SRB length (five-segment Ares I/five-segment optimized for Ares V versus 5.5 segments), EDS and CS material trades, shroud geometry trades, etc.

3.3 Phase A-Cycle 2 Trade Space

PA-C2 was meant to provide the technical basis for both engineering and optimizing the Ares V concept. This cycle demonstrated an increasing focus on detailed analysis with sensitivity

to analytical assumptions and hardware decisions. Trades at vehicle and element levels resulted in modifications from the PA-C1 configuration. The PA-C2 configuration featured two five-segment, PBAN steel boosters optimized for use on the Ares V (shorter burn time without a ‘throttle bucket’) and a new vehicle height of 116.37 m (381.8 ft). Analysis showed that opportunities for mass savings existed with the CS and EDS LH₂ tank design, mainly from the use of pressure within the tank for relief of flight loads, an increase in the shell buckling knockdown factor (SBKF), an evolved Al-Li alloy (Al-Li 2050 versus Al-Li 2195), and/or an isogrid design versus an orthogrid design to reduce the material thickness required. Other trades focused on specific design criteria such as CS ullage value increases from 2% to 3% nominal, and the averaged propellant boiloff value for LOX reduced from 0.35% per day down to 0.25% per day based on updated analysis. As the PA-C1 study investigated both the biconic and tangent ogive shroud geometries, the PA-C2 utilized the tangent ogive configuration and explored shroud internal acoustic treatment effects, shroud barrel length and payload packaging, and shroud separation options, which are depicted in figure 7.

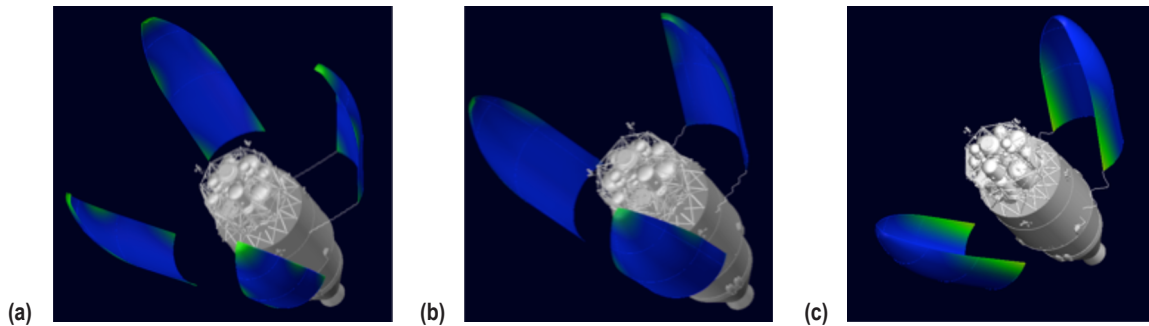

Figure 7. Shroud separation analysis: (a) Quad sector, (b) trisector, and (c) bisector.

3.4 Phase A-Cycle 3 Trade Space

As the PA-C2 configuration acted to identify vehicle performance sensitivities, PA-C3 sought to optimize the system by integrating DDT&E/performance sensitivities. Vehicle configurations chosen for PA-C3 included options for reducing cost and schedule and achieving more performance. The modifications made to the PA-C2 configuration include changes to develop an Ares V vehicle more quickly but with reduced payload to TLI. Featured changes include increasing the nominal ullage to 4% and other mass impacts such as deletion of shroud acoustic blankets and additional CS thermal protection. A separation study was performed to characterize booster-stage clearance based on a variable number of booster deceleration motors and failure criteria. As part of an integrated propellant tank study, several trades initially thought to be critical were ultimately removed and held as opportunities. Such trades included the shell-buckling knockdown factor, the effects of using an isogrid pattern as opposed to orthogrid, and multiple material options with thickness limitations.

In addition, the number of CSEs was reduced from six to five and a detailed trade of the CSE/SRB geometric arrangement was performed, as shown in figure 8. This study assessed the realized decrease in radiation and plume impingement concerns from PA-C2. A CS engine element trade was performed to characterize RS-68 option trades (e.g., RS-68B, RS-68 regeneratively-cooled nozzle with 21.6:1 and 30:1 expansion ratios, and RS-68B-E/0) to determine performance. This trade also assessed controllability with various engine gimbal and engine-out scenarios. The results showed vehicle effects assuming different engines and layouts.

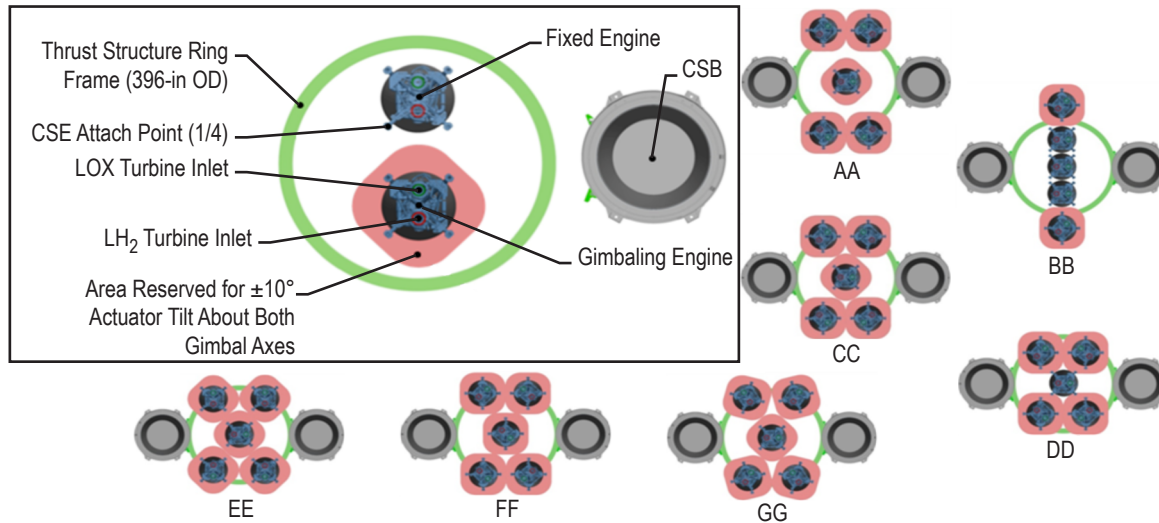

Figure 8. Ares V CS base engine layout trade.

As mentioned, two configurations known as PA-C3A and PA-C3D were analyzed during the PA-C3 trade studies. Both configurations maintain a 10-m (33-ft) diameter tangent ogive shroud, EDS, and CS. PA-C3A utilizes five RS-68B CSEs with a lower I_{sp} (due to the decreased nozzle expansion ratio and ablative nozzle relative to the RS-68B-E/0), and two five-segment, steel-case Ares I boosters. PA-C3D employs five RS-68B-E/0 CSEs with a higher I_{sp} , and two five-segment, steel-case Ares V short burn boosters. These combinations would allow for further evolution of the Ares V vehicle from a lower performing, quicker-to-construct configuration (PA-C3A) to a higher-performing configuration (PA-C3D).

3.5 Phase A-Cycle 3 Prime Trade Space

An intermediate cycle followed PA-C3, as the analysis was not yet suited for Phase A-Cycle 4 (PA-C4). The Mars extensibility study was born during this cycle and answered four primary questions:

- (1) What is Ares V PA-C3D IMLEO capability as a function of altitude and inclination?
- (2) What are the IMLEO growth potential/options for Ares V PA-C3D?

- (3) What is the impact of in-space ‘pre-TMI burn’ functions on EDS design?
- (4) What are the extensibility options for Ares V EDS to Mars TMI vehicle?

Several other trades were performed as part of this prime cycle, including the initial mass in LEO (IMLEO) trajectory study. This trade helped to characterize the Ares V PA-C3D vehicle’s capability to deliver mass to various insertion orbits, including elliptical and circular orbits. Additionally, dV budgets were determined for the circularization and deorbit burns.

Barge transportation and storage were also assessed for the CS during this cycle. Transportation by water was deemed a feasible solution due to volume and mass of the PA-C3D CS. This trade asked whether the assets still exist to transport such a structure, since water transportation has been utilized for Saturn V, EELVs, and Shuttle. The only operational covered barge is the Pegasus, once used for transporting ETs from Michoud Assembly Facility (MAF) to KSC. The Ares V PA-C3D CS is too large for transport on the Pegasus barge, both in length and diameter. Similarly, the Delta Mariner was considered but it cannot fit a 10-m (33-ft) diameter stage on a transporter into its cargo bay. Figure 9 shows the CS with horizontal engines positioned on a Pegasus-like barge. This barge has a 1.5-m (4.5-ft) wider opening to the cargo bay than the Pegasus and allows the engines to have a reasonable clearance at the top of the opening. This orientation allows the barge height to be no larger than the Pegasus and is therefore good for transportation purposes.

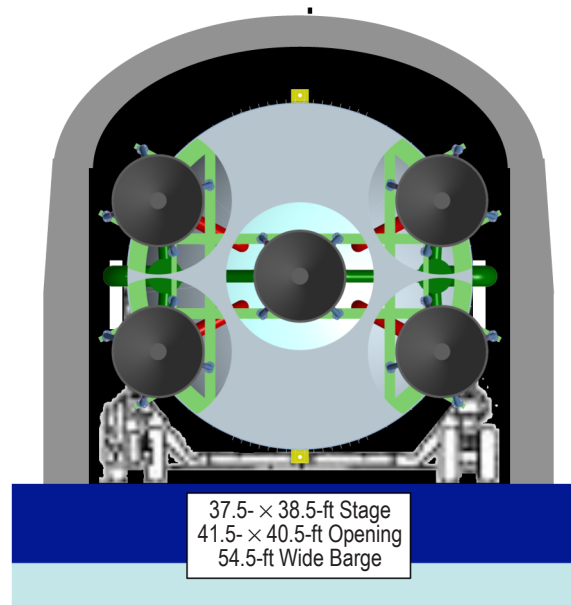

Figure 9. PA-C3D CS with horizontal engines.

Another trade assessed during PA-C3’ was throttle optimization. The primary objective of this effort was to produce a better estimate of optimum maximum Q , knowing that the vehicle gains performance with increasing allowable maximum Q assuming fixed mass. Another analysis

was completed to determine the payload that the current Ares V vehicle can deliver to different C3 values. The results of these trades are summarized in table 1 (Ares V Configuration Analysis Take-Aways, Private Communication, October 2010).

Table 1. Ares V VI major trades summary.

	Trade	Problem	Results
IDA	Aerothermal		
	Base heating	Determine significance of base heating given various nozzle configurations.	PA-C3 RS-68 nozzle heating reduced when compared with six in a circle configuration because distance from SRB plumes is greater; radiation slightly more severe for PA-C3D versus PA-C3A; PA-C3 base heating is generally high compared with historical launch vehicles due to RS-68B engines, but determined to not be significant issue.
	Plume impingement	Identify the implications of low-altitude SRB separation.	Recontact of the SRB with the continuing stage as a result of plume impingement and subsequent rotation is unlikely given the following conditions, assuming high dynamic pressure and offset Core: Below 150 kft if RS-68 nozzle exit is 5 ft forward of SRB nozzle; Below 100 kft altitude if RS-68 nozzle exit is 10 ft forward of SRB nozzle; Below 80 kft altitude if RS-68 nozzle exit is 15 ft forward of SRB nozzle (based upon PA-C3D CSE arrangement).
	Acoustics		
	Ignition over pressure (IOP)	Comparison of PA-CA and PA-C3D vehicle configurations to predict transient overpressures.	IOP environment for both PA-C3A and PA-C3D vehicle configurations is high; PA-C3A SRB IOP environment is higher while PA-C3D CSE IOP environment is higher. Strongest IOP response at Shroud. Sound suppression system is recommended. Subscale testing for suppression system and unsteady pressure CFD model is needed.
	Liftoff analysis	Comparison of PA-CA and PA-C3D vehicle configurations.	No significant differences in acoustic levels between vehicles; PA-C3D environment about 1 dB lower than PA-C2 environments. Scale model testing recommended to quantify water suppression benefits.
	Acoustics CFD for IOP	Average pressure values at several locations are used to compare steady and unsteady procedures.	Steady State: Larger variations between the turbulence models were found in the jet, MLP, and flame trench regions. Unsteady State: Initial comparison shows that unsteady analysis may be necessary in noise generating regions.
	Layout Studies		
	Engine base layout	Determine most viable options by working engine layouts in parallel.	Each examined option could be workable, but some were not viable because CSE fuel and oxidizer intake ports were blocked by structural ring frames. A five-engine configuration with a centered bell was chosen for PA-C3, with a 10° control pattern, assuming RS-68B-E/0 nozzle geometry.
	Booster-to-CS study	Identify impact on the geometry/design of the CS thrust structure, with engine count and gimbal limits.	Integrated trade study was performed to determine optimal engine layout and associated thrust structure (based on engine proximity to booster nozzle). Separation study characterized booster-stage clearance based on variable number of booster deceleration motors and failure critiers.
	CS transportation and storage	Compare current transportation and storage to proposed approach for PA-C3D vehicle. Road, rail, and air transportation cannot support the size/mass of PA-C3D CS.	Transportation by water is seemingly the only realistic way to transport the PA-C3D CS hundreds of miles at a time. Could alleviate congestion by transporting several at once for missions with high launch rates (thus transportation rates).

Table 1. Ares V VI major trades summary (Continued).

	Trade	Problem	Results
IDA	Performance Studies		
	Study configuration performance characterization	Establish process to conceptually size vehicle based on trajectory modeling, loads characterization, mass properties best practices, and element trades/analysis input.	Provided key understanding of vehicle options and performance trade space and determined vehicle geometry based on optimal propellant loading.
	Vehicle-to-ground system	Identify potentially significant impact on launch vehicle design, launch structure(s), and/or ground ops assumptions.	Found early impacts of the vehicle to existing ground systems that helped to reduce the potential for significant design changes later with CFD models that are directly extensible to other HLV configurations. Analysis was performed to determine the need and location of mobile launcher stays and dampers. Rollout and wind-shear loads modeling was also performed to identify potential solutions for reducing these effects.
	Performance versus C3 curves	Characterize Ares V PA-C3D vehicle's capability to deliver mass to different C3 energies.	Preliminary conclusions were that there were no show stoppers with the nominal separation case. More aero data is required for failure cases.
	Delta V split	Determine dV budgets for circularization and deorbit burns.	A single burn at apogee is required to circularize the orbit from the elliptical delivery orbit. For disposal from the circular orbit, a single burn can be performed to lower perigee to 30 nm, allowing the spacecraft to enter Earth's atmosphere near perigee.
	Other Studies		
	LOC/LOM analysis	Assess loss of crew probability from crewed Ares V failures.	Improved failure models for crewed risk assessment for LOC. Reduced conservatism in failure propagation. Baseline PA-C3A/D LOC probability estimate decreased since PA-C2. A & D nearly the same. MMOD strike ranked 4th cause of LOC (5% of total).
	Booster separation study	Perform sensitivity study of separation dynamics.	
	Throttle optimization	Improve fidelity of throttle profile analysis. Produce better estimate of optimum max Q point for PA-C3D vehicle configuration.	Second max Q event occurs at higher altitude for lower max Q cases. SRB propellant load decreases noticeably with decreasing max Q. Small increase in core propellant load with decreasing max Q. Highest nominal max Q approximately 1,000 psf with no throttle used. Minimum analyzed max Q approximately equal to 650 psf (similar to PA-C3A vehicle nominal max Q).
	Mars	Tank Mass Study	
Pressure relief of flight loads		Determine potential mass savings available from consideration of internal tank pressure in structural analyses.	CS showed greater sensitivity to the in-flight pressure relief of flight loads rather than an increase in SBKF.
Shell buckling knockdown factor		Evaluate mass savings for application of 0.65, 0.75, and 0.85 SBKFs.	SBKF was assessed during PA-C2 but deemed not critical for continued evaluation into PA-C3.
Alternative materials		Evaluate potential of thick plate Al-Li alloy to provide mass savings on buckling-critical cryotank structure.	Al-Li 2195 is adequate for worst case analysis assumptions on the EDS LH ₂ barrel. Al-Li 2195 shows a mass savings over Al-2219. Al-Li 2050 shows a mass savings in the CS LH ₂ tank due primarily to the thickness limitations associated with Al-Li 2195.

Table 1. Ares V VI major trades summary (Continued).

	Trade	Problem	Results
Mars	Transfer Vehicle Options		
	NTP	Assess trade space with various propulsion elements: NTP.	Using the Ares V as a heavy launch vehicle, the NTP option delivers the necessary components for cargo and crewed MTVs in nine launches (assuming an additional Ares I launch for crew).
	Chemical	Assess trade space with various propulsion elements: Dedicated in-space stage.	Using the Ares V as a heavy launch vehicle, the chemical option that utilizes dedicated in-space stages (as opposed to EDS modules) delivers the necessary components for cargo and crewed MTVs in 11 launches (assuming an additional Ares I launch for crew).
	EDS-as-MTV-stage	Assess trade space with various propulsion elements using EDS as TMI.	Using the Ares V as a heavy launch vehicle, the chemical option that utilizes EDS modules as TMI stages delivers the necessary components for cargo and crewed MTVs in seven launches (assuming an additional Ares I launch for crew).
	Other Transfer Vehicle Options		
	Propellant boiloff	Assess boiloff technology since all in-space transportation assessed by the Ares V team rely on this fundamental technology development to enable the missions.	NTP MTV Option: 1.3-t–27-t ZBO potential impact for cargo MTV; 1.9-t–41.5-t ZBO potential impact for crewed MTV. Chemical MTV Option: 2.1-t–46-t ZBO potential impact for cargo MTV; 2.7-t–60-t ZBO potential impact for crewed MTV. The chemical option may also be impacted due to its required in-space cryogenic propellant transfer, accounting for 1% – 5% mass loss. Both NTP and chemical options would thereby accrue vehicle performance but would require at least one additional launch per MTV.
	Launch spacing sensitivity	Determine if more launches allow for less sensitivity to ZBO for the chemical propulsion option.	Cargo MTV: For five launches (2.5 each), EDS can have about 10 t of boiloff and still meet dV requirement. This increases to about 70 t of allowed boiloff for six launches. Crewed MTV: For five launches, 90+ t of boiloff would be allowed to meet the dV requirement. Therefore, an additional launch to assemble the cargo MTVs could reduce the sensitivity to the boiloff rate required for cargo MTV EDS, especially for the initial Mars missions, and similarly for the crewed MTV.
Propellant transfer feasibility	Assess EDS positioning during fuel transfer.	Nose-to-tail was recommended at the conclusion of the study assuming separation from the MTV stack and centrifugal acceleration.	
Mars shroud study — loads	Illustrate effects of heavier LEO payloads on vehicle loads.	Large shroud and heavy payload significantly change vehicle loads. May need additional throttling in trajectory to reduce moment.	

3.6 Phase A-Cycle 3 Double Prime Trade Space

To complement the Mars study, a few spinoff trades were assessed such as identifying the aerodynamic effects for the Mars shroud, propellant boiloff, and launch spacing sensitivity. The fundamental technology developments that enable a mission such as Mars are zero boiloff (ZBO) cryogenic propellant thermal control systems (TCSs). The trade described the sensitivity of the MTVs to these technologies. For either the NTP or chemical option, large quantities of cryogenic propellants would be in LEO for extended periods of time. This would require a dedicated TCS to keep the propellants below the boiling point to reduce boiloff to a reasonable level. This introduces the possibility of having dedicated launches to make up for significant losses. The sensitivity to ZBO was found by assessing the impact of various boiloff rates (0.01%, 0.1%, and 0.25%) for propellant delivery flights assuming launch spacing intervals of 30, 45, and 60 days.

In late 2010, several more studies were performed and they added fidelity to the PA-C3 package. One such study acted as a supplemental part of the Mars extensibility study conducted during PA-C3'. The docking adaptor trade assessed the functionality and design of an automated rendezvous and docking system. Using the chemical scavenger nine-launch option (fig. 24) as a reference baseline for the analysis, the objective was to add detail to the docking adaptor and propellant transfer required for the crewed MTV concept.

A payload survey was also conducted to identify potential HLLV payloads for the purposes of building a robust advocacy for HLLVs. This approach included payload mass estimates, physical characteristics, accommodation requirements, and launch dates. Shrouds were identified to support the study efforts and vehicle configurations were evaluated to ensure that the launch capability would meet payload needs. The heavy-lift payload survey is shown in figure 10.

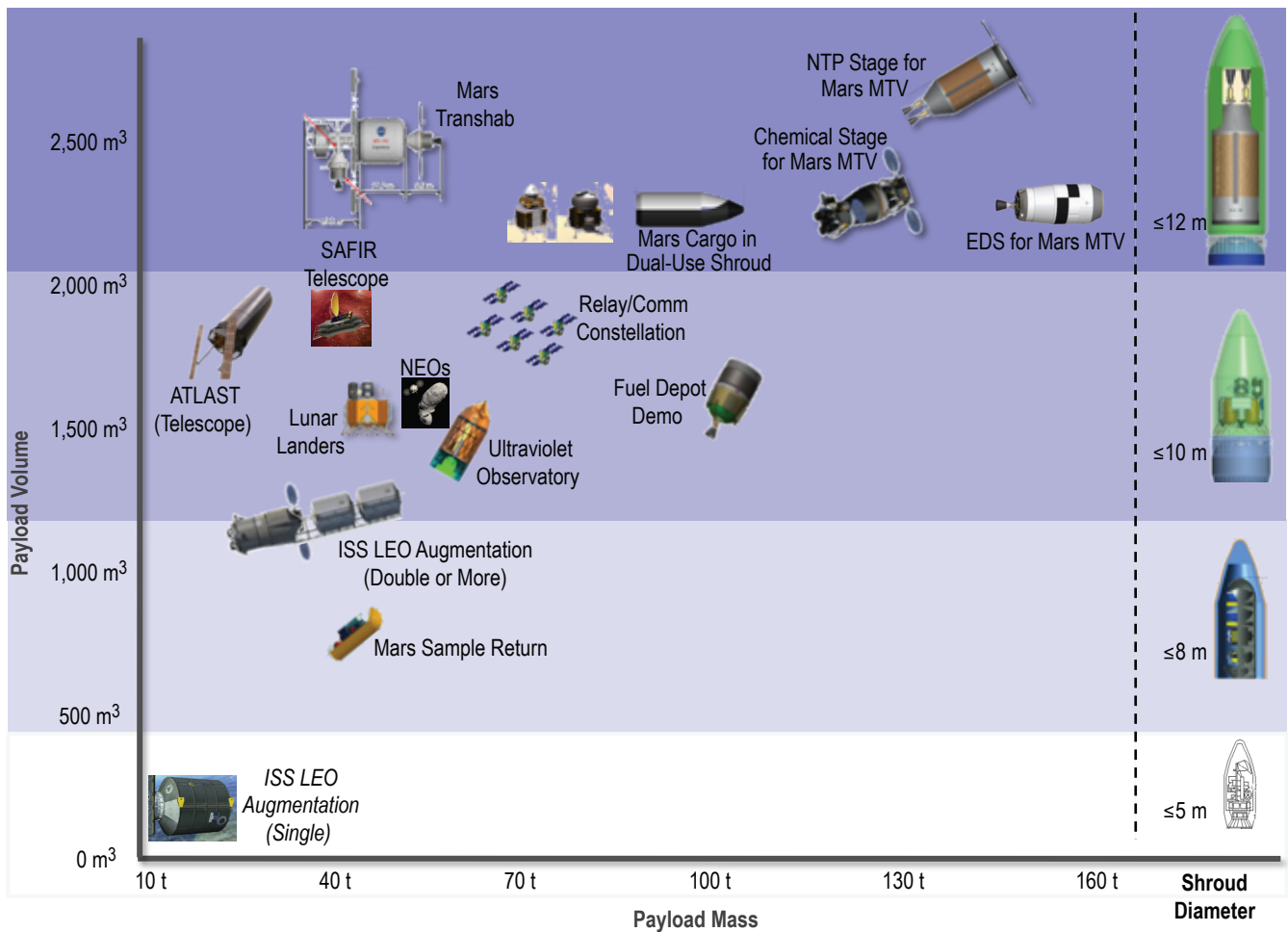

Figure 10. Mass and volume requirements for multiple missions.

Another trade that was performed during PA-C3'' was an assessment of maximum Q versus the vehicle payload. Injected TLI and TMI payload mass were compared to maximum dynamic pressure assuming a 100-psf dispersion between nominal and design maximum Q , as seen in figure 11.

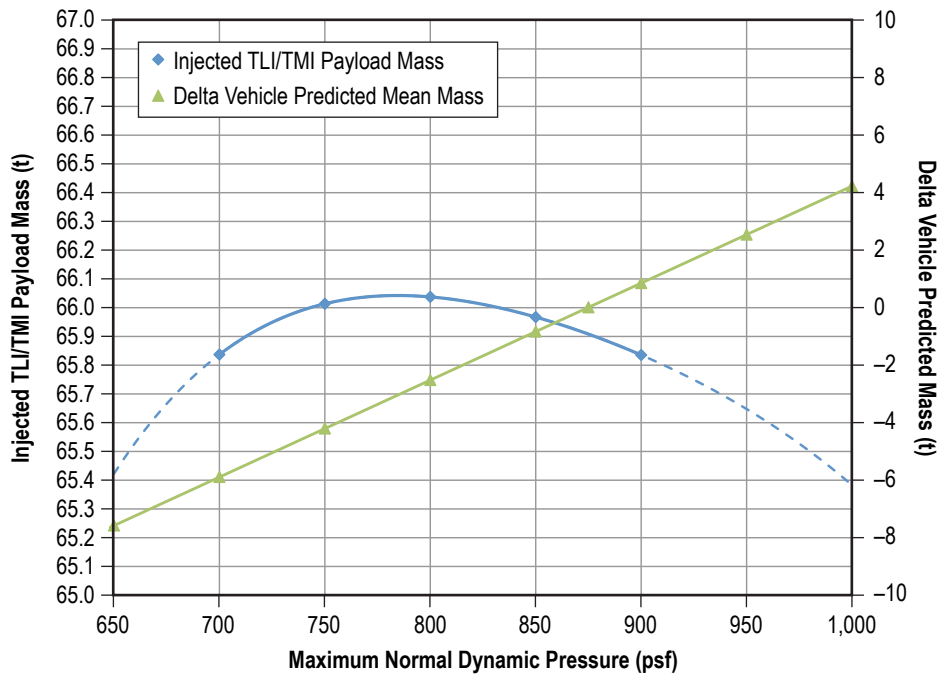

Figure 11. Maximum dynamic pressure versus vehicle payload.

3.7 Overall Trades Assessment

Table 1 highlights major trades that were assessed as part of the cycles previously mentioned (PA-C1 through PA-C3'') (Ares V Configuration Analysis Take-Aways, Private Communication, October 2010). The results given reflect the latest status of the trades. Table 1 is intended for summarizing purposes only. For more details, please refer to the original packages.

4. POINT-OF-DEPARTURE DESCRIPTION

4.1 Family-of-Vehicle Concept

The intent of a POD vehicle is to identify a baseline configuration that can be carried forth for analysis purposes. The lunar transportation POD was meant to provide crew and cargo delivery to and from the Moon, provide capacity and capabilities consistent with candidate surface architectures, provide sufficient performance margins, remain within program constraints, and result in acceptable levels of risk.

During the initial stages of PA-C3, the candidate POD vehicle was identified as the PA-C3D Ares V vehicle. Since then, shorter cycles have been added, namely PA-C3' and PA-C3''. These additional cycles have allowed the VI team to further its efforts in defining a reference POD before delving into PA-C4. A family-of-vehicles concept was introduced in PA-C3'' and incorporates vehicles PA-C3A through PA-C3H. The differences between these Ares V vehicles may be seen in table 2. Table 3 presents the performance analysis for candidate POD configurations. Figures 12 and 13 show the evolved family-of-vehicle concept, and the PA-C3D vehicle respectively.

Table 2. Family of vehicles concept comparison.

	Family of Vehicles							
	A	B	C	D	E	F	G	H
Propulsion								
Five engines								
Six engines								
RS-68B								
RS-68B-E/O								
Booster								
Ares I booster								
Short burn booster								
Composite/HTPB								
EDS								
Metallic EDS								
Composite EDS								

Table 3. Performance analysis for candidate POD configurations.

	Mass (t)	
	TLI	LEO
LCCR	71	188
PA-C1	67	181
PA-C2	70	198
PA-C3A	55.22	161.3
PA-C3D	64.80	180.3
PA-C3B	59.46	170.4
PA-C3C	58.96	169.5
PA-C3E	68.86	188.8
PA-C3F	70.23	191.8
PA-C3G	73.72	199.06
PA-C3H	64.19	180.8

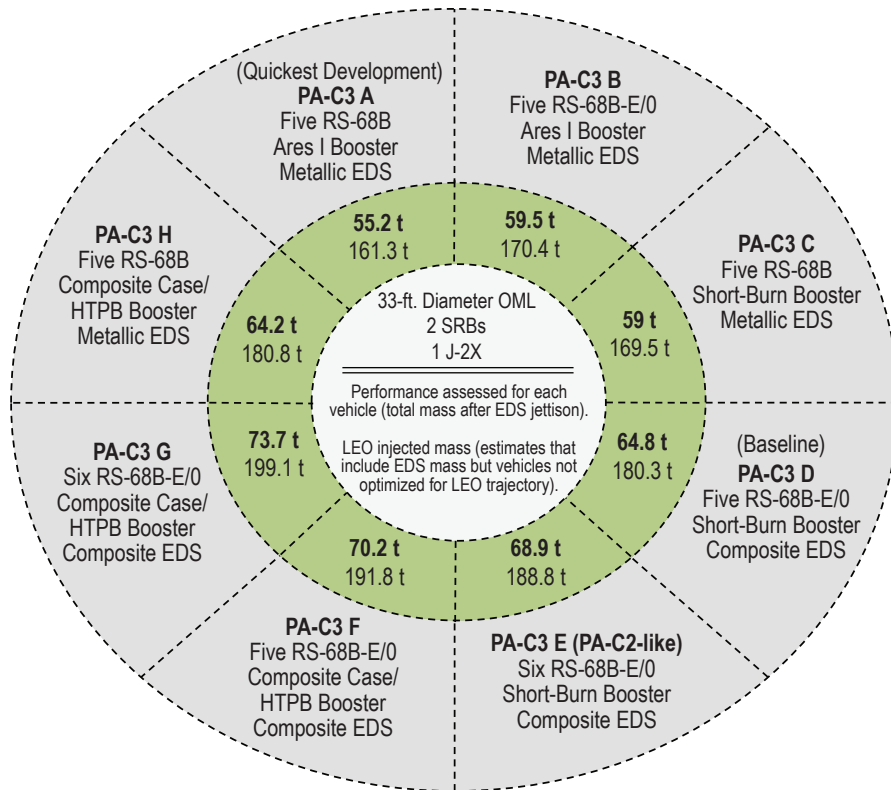

Figure 12. Family of vehicles POD configuration for PA-C3''.

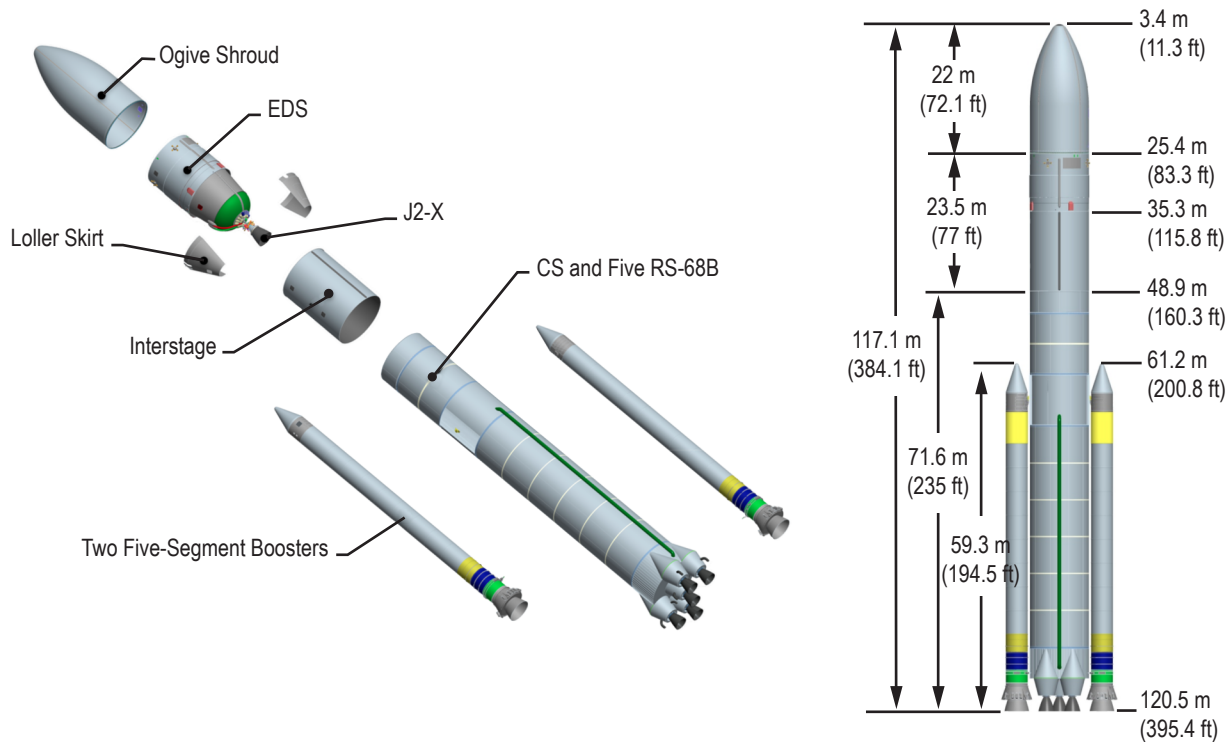

Figure 13. PA-C3D candidate POD vehicle (PA-C3').

4.2 Phase A-Cycle 3D—Description of the Candidate Point-of-Departure Vehicle

This section describes the physical features and performance capability of the integrated vehicle and the individual elements.

4.2.1 Ares V Candidate Point-of-Departure Physical Descriptions

The Ares V LV concept PA-C3D is a two-and-a-half stage LV that delivers the Altair lunar lander and the EDS to LEO for rendezvous with the Orion crew vehicle system. The major components comprising the PA-C3D concept are the five-segment, PBAN-propellant SRBs, the LOX/LH₂ CS, the LOX/LH₂ EDS, and the tangent ogive payload shroud. Figure 13 highlights the elements and major features.

For the purposes of PA-C3'', the dimensions for the PA-C3B, C, E, F, and G vehicles remain the same as the respective vehicles from which they are derived (i.e., PA-C3A and PA-C3D). PA-C3A was modified during this cycle to share a common booster with the PA-C3D vehicle and, as such, the vehicles all have the same overall length. However, it should be noted that the CS length for PA-C3A is still shorter than PA-C3D because the RS-68B-E/0 engine nozzle length differs from the RS-68B engine nozzle by 0.34 m (1.1 ft). Also, configurations that include a composite booster (i.e., PA-C3F and PA-C3G) may slightly alter vehicle dimensions and the OML. The thrust trace for the boosters is currently being revisited and will ultimately dictate the expansion ratio and duration of the booster burn.

4.2.2 Ares V Point-of-Departure Core Stage Booster

4.2.2.1 Ares V POD Steel Booster Description. The POD booster configuration for the Ares V vehicle is designated as the five-segment steel case configuration (fig. 14). The OML of the five-segment steel case configuration is similar to the Ares I SRB, which is based on the four-segment Shuttle SRB. The propellant is the heritage space transportation system (STS)/Ares I PBAN propellant, with a propellant grain design that is optimized for use on the Ares V. Furthermore, an inert spacer (steel case only, no propellant) is used at the forward end of the booster to permit a longer CS with additional CS propellant.

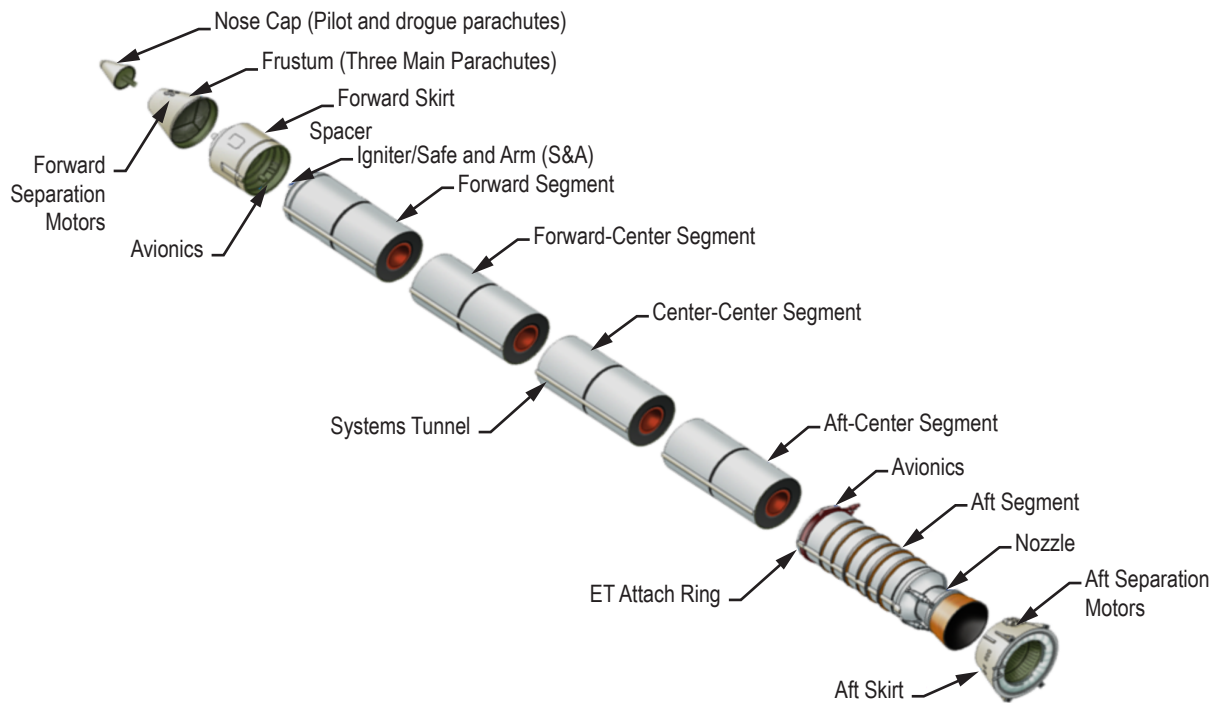

Figure 14. Expanded view of PA-C3D booster concept.

The Ares V booster configuration uses heritage steel case cylinders and domes. The aft skirt, forward skirt, frustum, and nose cone are Shuttle SRB heritage configurations. The CS-to-booster attach cylinder of the aft segment and the attach ring/struts are Shuttle SRB heritage. The thrust vector control (TVC) system is Shuttle SRB heritage. Boosters would be separated similar to the Shuttle with STS/Ares I forward and aft booster separation motors (BSMs).

The Ares V booster is planned for recovery to refurbish components similar to the Shuttle SRB. The parachutes and all equipment required for reentry, splashdown, and recovery are included in the configuration.

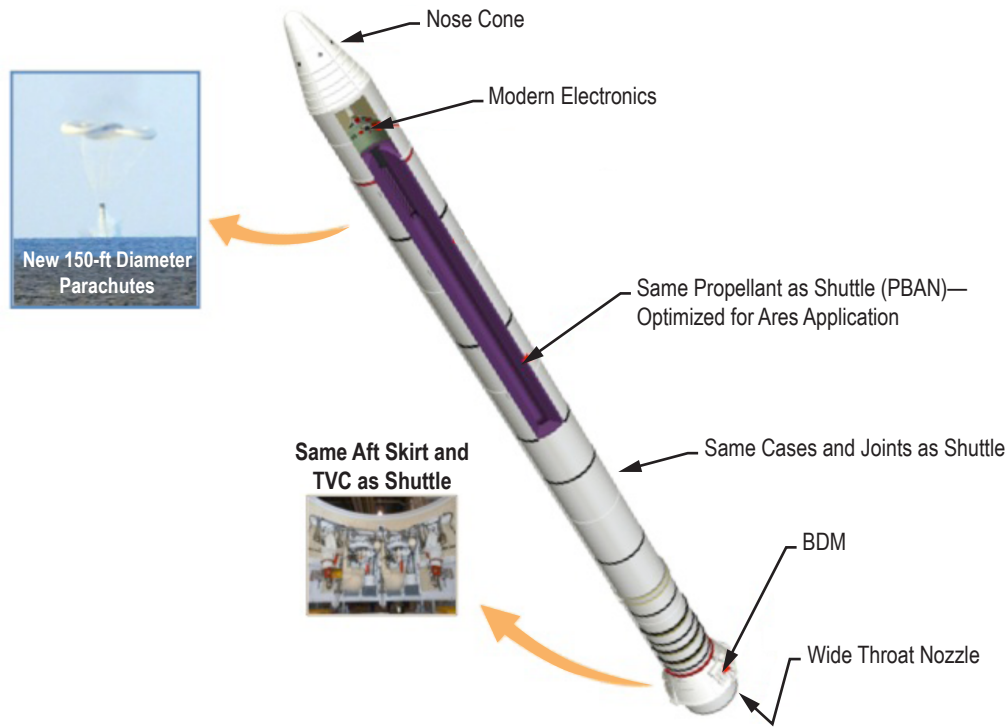

Figure 15. Ares V POD booster: Five-segment, PBAN propellant, steel case.

4.2.2.2 Steel Booster Evolution. The initial five-segment steel case booster configuration for the Ares V vehicle used the identical motor design (five-segment RSRMV) as defined for the Ares I booster. The aft skirt, forward skirt, frustum, nose cone, and other hardware were used as defined on Shuttle SRB heritage configurations.

The subsequent booster configuration started with the Ares I booster design. The grain and nozzle designs were reoptimized to assist in satisfying the payload performance requirements for Ares V. The Ares V vehicle needs substantially more impulse during the atmospheric phase of flight than the CS and the Ares I booster can provide. More impulse equates to higher thrust traces versus time and larger propellant weight capacities.

Initially, the Ares V vehicle CS configuration was lengthened to provide more impulse by adding an empty (no propellant) one-half segment to the booster design. This length change to the booster permitted the CS to be lengthened to add more propellant. The second iteration added propellant to the empty one-half segment and, with the addition of the longer CS tanks, provided a substantial additional impulse during the first phase of ascent. Thus, the LCCR configuration was composed of five normal-sized booster segments and one-half segment. The last iteration leading to the current five-booster segment configuration was driven by the results of the CSE and booster combination trade studies performed. The five-segment booster is utilized on the PA-C3D POD to allow for commonality with the Ares I, but the propellant grain design is optimized for use on the Ares V. An optimized-length inert spacer replaced the empty one-half segment inert space to allow for a 71.6-m (235-ft) CS length, as seen in figure 16. The Ares V booster nozzle configuration has an expansion ratio of 7.22, which is currently the same as the Ares I for lunar missions.

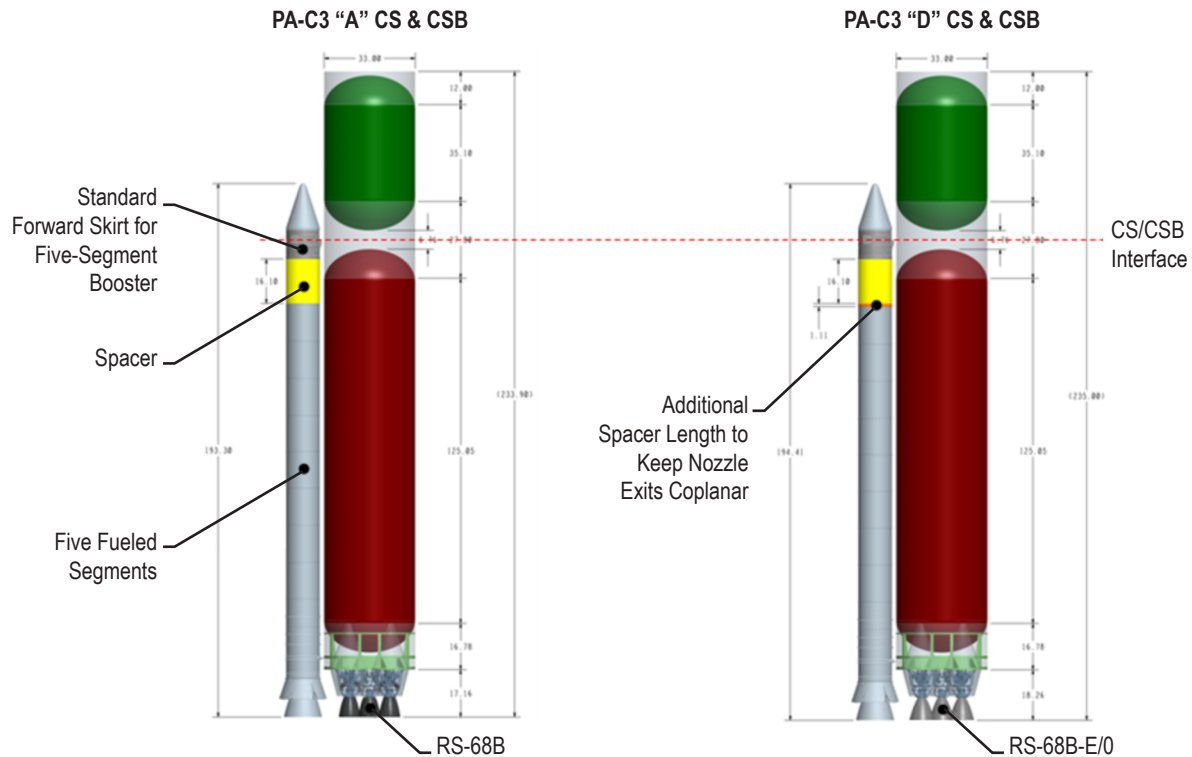

Figure 16. CS and booster sizing.

4.2.3 Ares V Point-of-Departure Core Stage

The Ares V CS is a liquid propulsion element that provides thrust during the first 5 min of powered ascent. The CS utilizes a LOX/LH₂ oxidizer/fuel combination that leverages much of the Space Shuttle ET design. This element is 71.6 m (235 ft) long, has a constant OML diameter of 10 m (33 ft), and consists of both Al alloy dry structures and Al-Li 2195 propellant tanks. The subsystems that make up the CS are the main propulsion system (MPS), aft skirt/thrust structure, LH₂ tank, intertank, LOX tank and forward skirt, avionics and power, purge, thermal protection systems (TPSs), range safety, and development flight instrumentation for early flight vehicles (figs. 17 and 18). The CS has a dry mass of 149.7 t (330,108 lbm) and can carry a propellant mass of 1,520.2 t (3,351.7 klbm) of useable impulse propellant when fully loaded for ascent. At CS burnout, this element has a mass of 170.4 t (375.7 klbm).

To support the CS's five RS-68 engines, its MPS system consists of systems for fill/drain, LOX/LH₂ propellant measurement and feed lines, tank pressurization, engine prechill, propellant valves, helium purge, pogo suppression, and hydraulics. An option is being considered to create a new RS-68B-E/0 that outputs 3,603 kN (810,000 lbf) of thrust operating at 108% in vacuum; it also provides an I_{sp} of 423 s. This engine also dumps its gas generator exhaust into a new regeneratively cooled nozzle.

The CS aft skirt is an Al cylindrical structure that joins the MPS/thrust structure to the LH₂ tank.

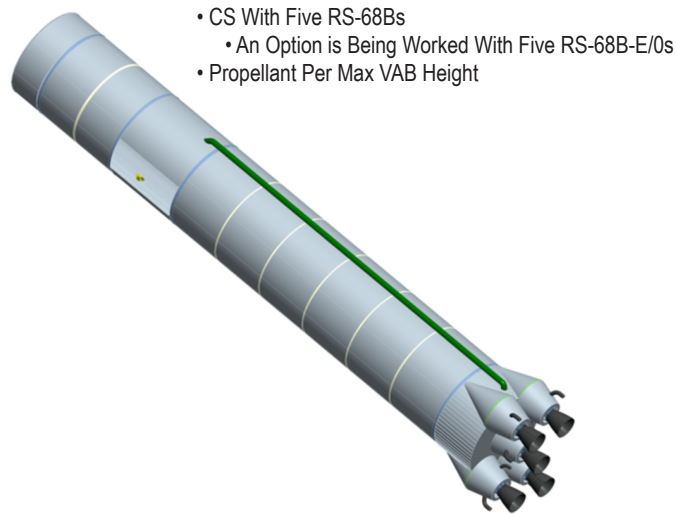

Figure 17. Ares V CS element view.

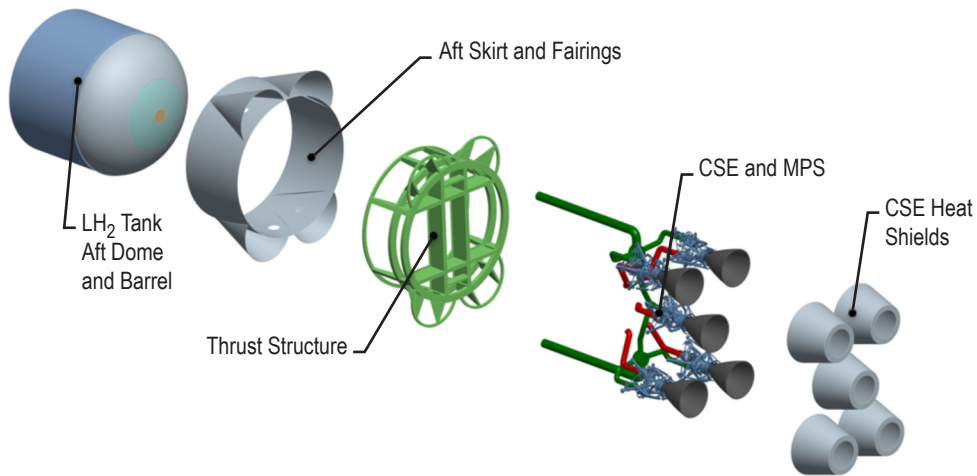

Figure 18. CS aft end expanded view.

The LH₂ tank is 44.5 m (146.1 ft) long and is constructed of Al-Li barrels and domes (end-caps on domes may be Al 2219). Pressure relief valves are located on both forward and aft domes to assist in propellant settling. A sump at the bottom of the aft dome drains the fuel through a single feed line that goes to the MPS LH₂ manifold.

The intertank physically separates the CS LH₂ and LOX tanks and provides a physical interface to the solid boosters. Built with Al alloy 2090, the intertank carries the weight of the structures above and provides the structural interface for the SRB forward attach points. There are two attach fittings on opposite sides of the intertank that interface with the SRB forward attach mechanisms; an internal crossbeam joins these two attach fittings and provides structural support for the high loads induced by the SRBs.

The LOX tank is 17.1 m (56.1 ft) long and is constructed of Al-Li barrels and domes. Pressure relief valves are located on both the forward and aft domes to assist in propellant pressurization. A sump at the bottom of the aft dome drains the oxidizer through two feed lines that go to the two aft LOX manifolds.

The CS forward skirt is the forward-most component on the CS and is attached to the aft end of the interstage. This component houses the CS avionics used to monitor and control the CSEs and both SRBs and to communicate with the avionics system on the EDS instrument unit. The forward skirt also supports CS separation. Retrorockets may be evenly distributed around the circumference of the forward skirt to support a clean separation from the EDS; alternate locations for these separation motors are on the aft compartment or intertank.

4.2.4 Ares V Point-of-Departure Earth Departure Stage

The PA-C3D EDS is an upper stage propulsion element that provides the sole source of thrust once the solid boosters and CS have separated from the EDS-Altair stack. The EDS has a 10-m (33-ft) outer diameter, measures approximately 23.5 m (77 ft) long, and is comprised of composite (graphite epoxy IM7) dry structures and Al-Li 2195 propellant tanks. The primary functions of the EDS are to insert the EDS-Altair stack into LEO, provide resources as needed to Altair through the launch phase, perform loiter operations for up to 4 days in LEO, dock with Orion, and perform the TLI burn for the EDS-Altair-Orion stack. The EDS is pressurized to condition the propellant and restart the J-2X engine for the TLI burn. The primary EDS structures are the interstage, loiter skirt, EDS MPS, aft skirt/thrust structure, LOX tank, intertank, LH₂ tank, and forward skirt. See figure 19 for a view of the major EDS components and design. The EDS has a dry mass of 36.1 t (79.5 klbm) including the loiter equipment and carries 240.4 t (530.1 klbm) of useable impulse propellant mass, of which 143.7 t (316.8 klbm) is burned during ascent. At EDS burnout, this element has a mass of 25.4 t (56.1 klbm).

The interstage is a composite cylindrical structure that interfaces with the CS. Together with the loiter skirt, the interstage houses the J-2X engine and its extended nozzle. While segmented to the EDS, the interstage remains attached to the CS throughout launch. A separation ring at the forward end is activated during CS separation, allowing the CS and interstage to separate together from the EDS-Altair stack.

The loiter skirt is a cylindrical structure that encompasses the J-2X engine. It is located between the interstage and aft skirt/thrust structure. This composite structure contains fuel cells/batteries and other subsystem resources to maintain the EDS and Altair during its loiter operations in LEO. The PA-C3D POD concept assumes that the loiter skirt is jettisoned just prior to the TLI maneuver.

The EDS MPS provides the needed propulsion for the LEO insertion and TLI insertion burns. The MPS consists of the J-2X engine and the associated feed system, which interfaces with the EDS LOX and LH₂ tanks.

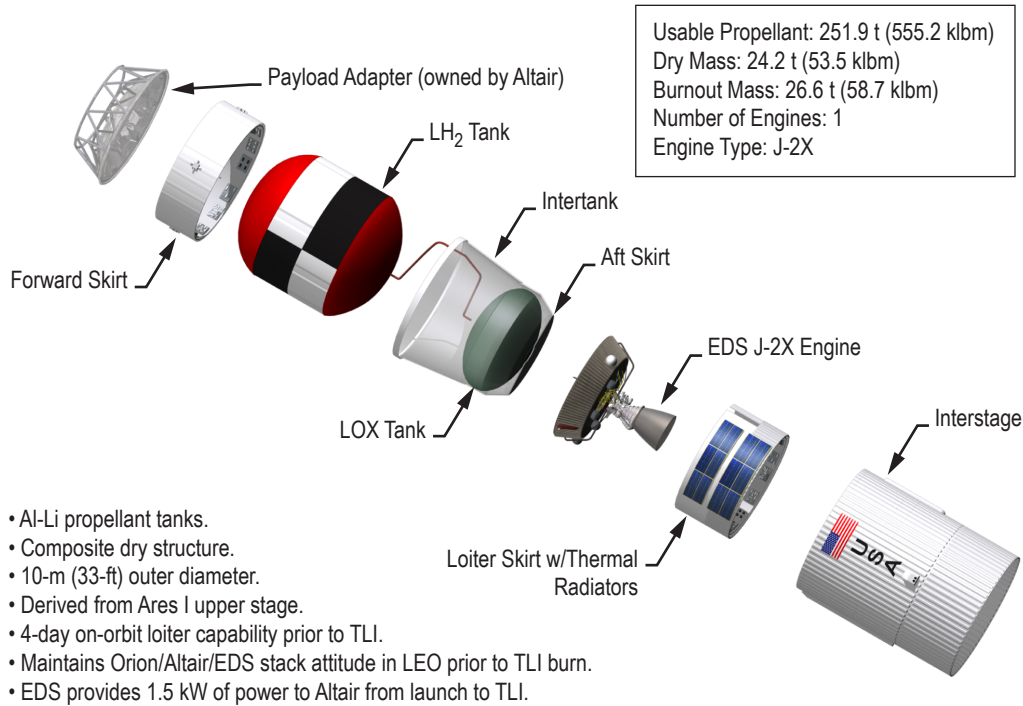

Figure 19. Ares V EDS element view.

The aft skirt and thrust structure provide the structural interface between the J-2X engine and the EDS. The aft skirt is a short, tapered, conical section constructed from composite material and accommodates the small diameter of the EDS LOX tank. The thrust structure provides the attach points for rigidly mounting the J-2X engine.

The LOX tank is constructed from aft and forward Al-Li domes, which together measure 6 m (18 ft) long and 8 m (26 ft) in diameter. The LOX tank can hold up to 206.7 t (455,800 lbm) of oxidizer. The tank interior contains slosh baffles and a vortex baffle at the outlet. Unlike the CS propellant tanks, the EDS LOX tank must manage its cryogenic propellant to eliminate undesirable propellant loss during the 4-day loiter period. To this end, cryogenic fluid management (CFM) technologies will be incorporated into the tank to preserve propellant.

The EDS intertank separates the LOX and LH₂ propellant tanks. It is manufactured from composite materials and tapers from the 10-m EDS outer diameter (at the LH₂ tank) down to the diameter of the LOX tank.

The LH₂ tank aft skirt is a short-barrel section that joins the intertank to the LH₂ tank. It measures approximately 0.61 m (2 ft) long and is made from composite material.

The LH₂ tank is comprised of one barrel section and two domes, which together measure approximately 10 m (33 ft) in length. The LH₂ tank can hold 42.1 t (92,800 lbm) of LH₂ fuel. The tank is an Al-Li metallic structure. The tank interior also leverages CFM technologies to prevent propellant boiloff during the 4-day loiter period. Micrometeoroids and orbital debris (MMOD)

shielding is integrated into the external side of the barrel section to protect against the debris environment during loiter.

In the POD, the EDS forward skirt houses the avionics system that provides primary data and command and control for the Ares V integrated vehicle throughout all phases of flight. The forward skirt provides the primary interface to the payload shroud and adapter.

4.2.5 Ares V Point-of-Departure Payload Shroud

The PA-C3D shroud is a composite structure consisting of a cylindrical barrel section and a nose cone. The shroud measures 22 m (72 ft) in length and 10 m (33 ft) in diameter across the barrel section. The POD vehicle exhibits a tangent ogive nosecone with a rounded tip. This baseline configuration features a quad-petal design for effective shroud separation, as seen in figure 20. The material construction consists of a composite sandwich with an Al honeycomb core and a painted cork TPS bonded to the outside. The shroud weighs a total of 6.7 t (14,839 lbm). This includes the structure, TPS, and separation mechanisms, of which approximately 6.5 t (14,268 lbm) is jettisoned during the ETO ascent.

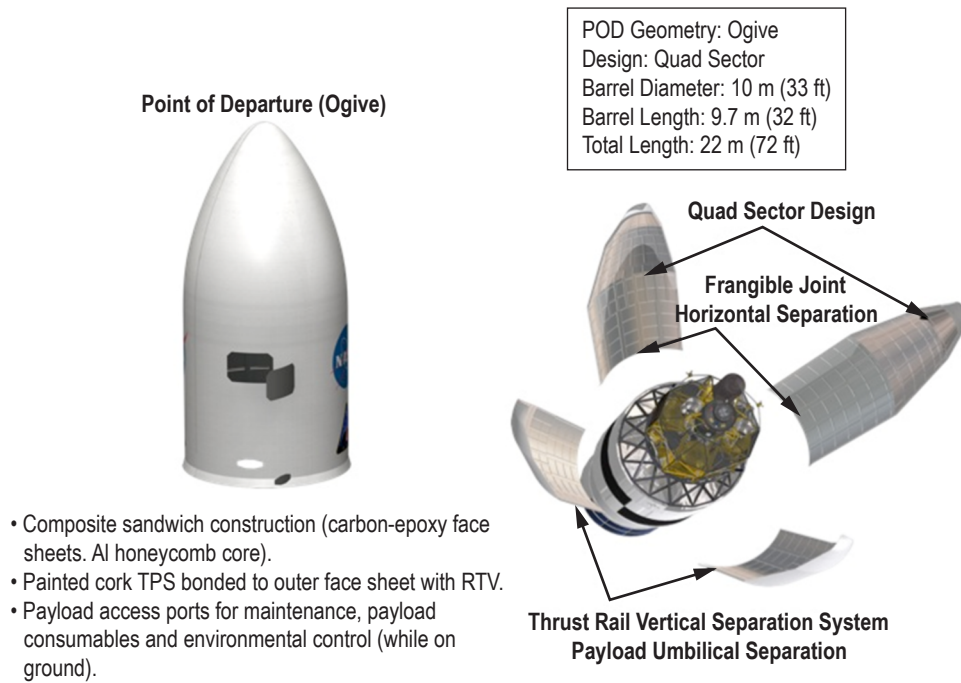

Figure 20. Ares V shroud element view.

Preliminary sizing of the TPS, structures, and subsystems was performed during previous assessments. This PA-C3 trade study considers all identified driving factors including mass, payload volume, performance, cost, manufacturing, transportation, etc., with a focus on acoustic impacts and assessment of shroud shape refinement.

4.2.6 Ares V Point-of-Departure Avionics and Software

The Ares V avionics and software maintain control over the entire vehicle stack throughout the entire launch profile. The avionics control all aspects of flight including fault recovery, abort conditions, and any data interfaces to Altair or Orion. Avionics provides three-axis attitude control for CS flight phases. Roll control stability is maintained by the SRBs and CSEs while attached. Figure 21 identifies the Ares V avionics and software.

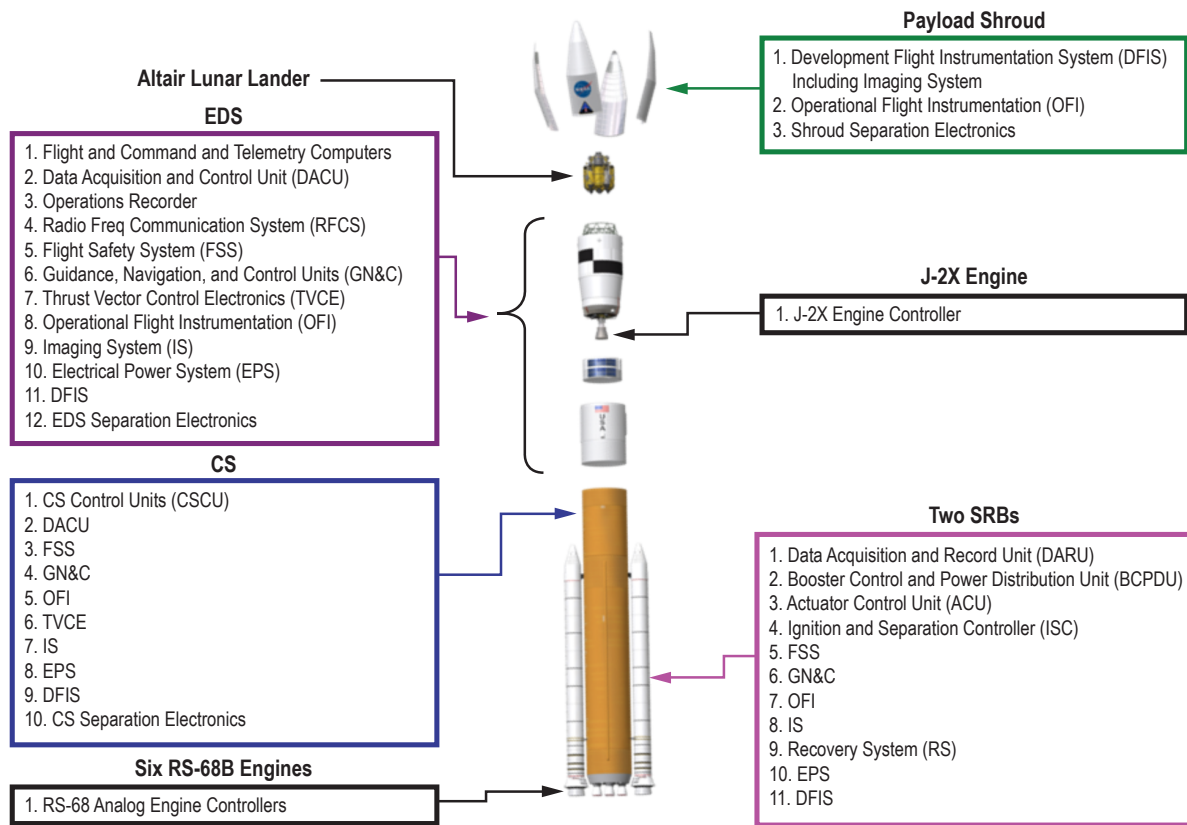

Figure 21. Ares V avionics and software.

4.3 Ares V Point-of-Departure Performance Capability

The performance capability was optimized for the PA-C3D vehicle by sizing the EDS while maintaining the extended CS size. The CS remained fixed because the structural attach point of the five-segment booster (with the inert spacer) constrained the position of the intertank thrust beam, thereby constraining the size of the propellant tanks. The mission profile is to launch Altair and a partially loaded EDS into a 240-km (130-nmi) circular orbit for rendezvous with Orion, which has been launched on Ares I. After docking, the integrated stack (i.e., Orion, Altair, and EDS) assumes to leave from a 185-km (100-nmi) circular orbit for TLI. The J-2X engine operates for this burn at the lower propellant mixture ratio of 4.5, which lowers the thrust from 1.31 MN (294 klbf) used on the ETO portion of the mission to 1.06 MN (238 klbf) for TLI, while the I_{sp} is currently assumed to stay approximately constant at 448 s. The TLI payload capability for the lunar sortie DRM using the PA-C3D concept for a 1.5-launch scenario (rendezvous in LEO with Orion launched on Ares I) is 64.8 t (142,800 lbm).

5. ARES V MARS EXTENSIBILITY

5.1 Mars Transfer Vehicle Options: Nuclear Thermal Propulsion, Chemical, and Earth Departure Stage as Mars Transfer Vehicle Stage

The reference HLLV (Ares V) for NASA's CxP served as the POD for the Mars Design Reference Architecture 5.0 (DRA 5.0).⁴ The assessment of the Ares V vehicle as it pertains to Mars missions remained locked to the architecture presented in the Mars DRA 5.0, consisting of two cargo MTVs that are predeployed (utilizing aerocapture for Mars orbit insertion (MOI)) before a crewed MTV departs on the following synodic opportunity (utilizing propulsive capture for MOI). As such, MTV options were chosen within that architecture that were intended to reduce the number of flights to a reasonable and sustainable level. These options included nuclear thermal propulsion (NTP) and chemical propulsion. The Ares V LV was employed to deliver components for these MTVs, such as payload and propellant. Each propulsion option required a different number of flights (e.g., NTP consisted of a seven-launch campaign as presented in the Mars DRA 5.0 and a competitive chemical option consisted of a nine-launch campaign).

The chemical options assessed can be broadly categorized as those that use the EDS for TMI and those that do not use the EDS (propulsion modules are delivered to LEO). Figures 22 through 24 illustrate the launch sequencing for the NTP option, chemical option (as presented in the Mars DRA 5.0), and EDS-as-MTV-stage option, respectively.

The Ares V contributions to a Mars campaign are highlighted in this work with the goal of understanding the Ares V capability within the trade space. Using the EDS as the in-space transportation element was more fully characterized and was of special interest during the assessment.

This work consisted of characterizing LEO performance as a function of insertion and final assembly altitudes, number of launches required for the campaign, and EDS functionality evaluated against the lunar configuration (e.g., as additional loiter duration, on-orbit capabilities required, and payload operations).

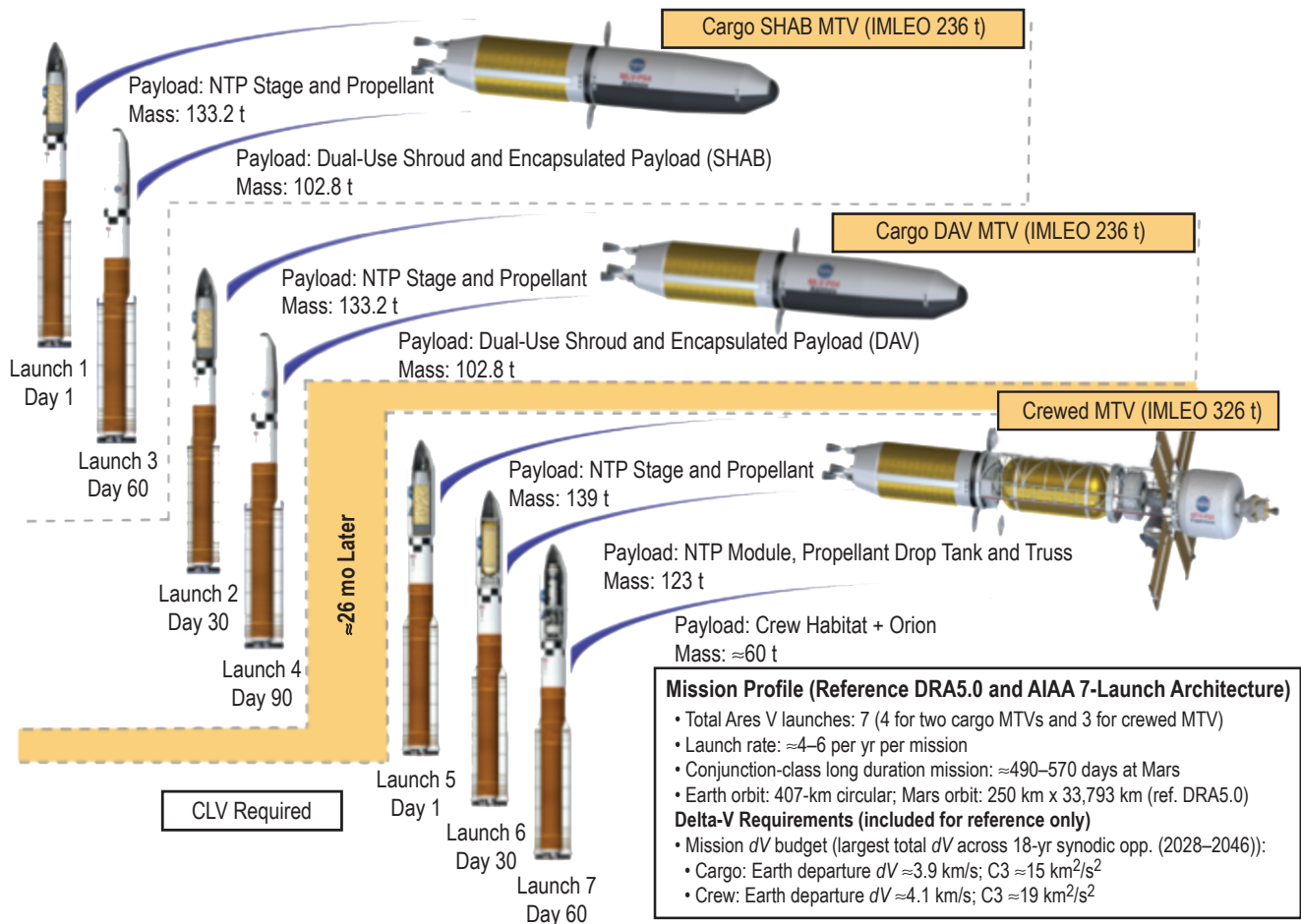

Figure 22. NTP launch sequence and payload mass requirements.

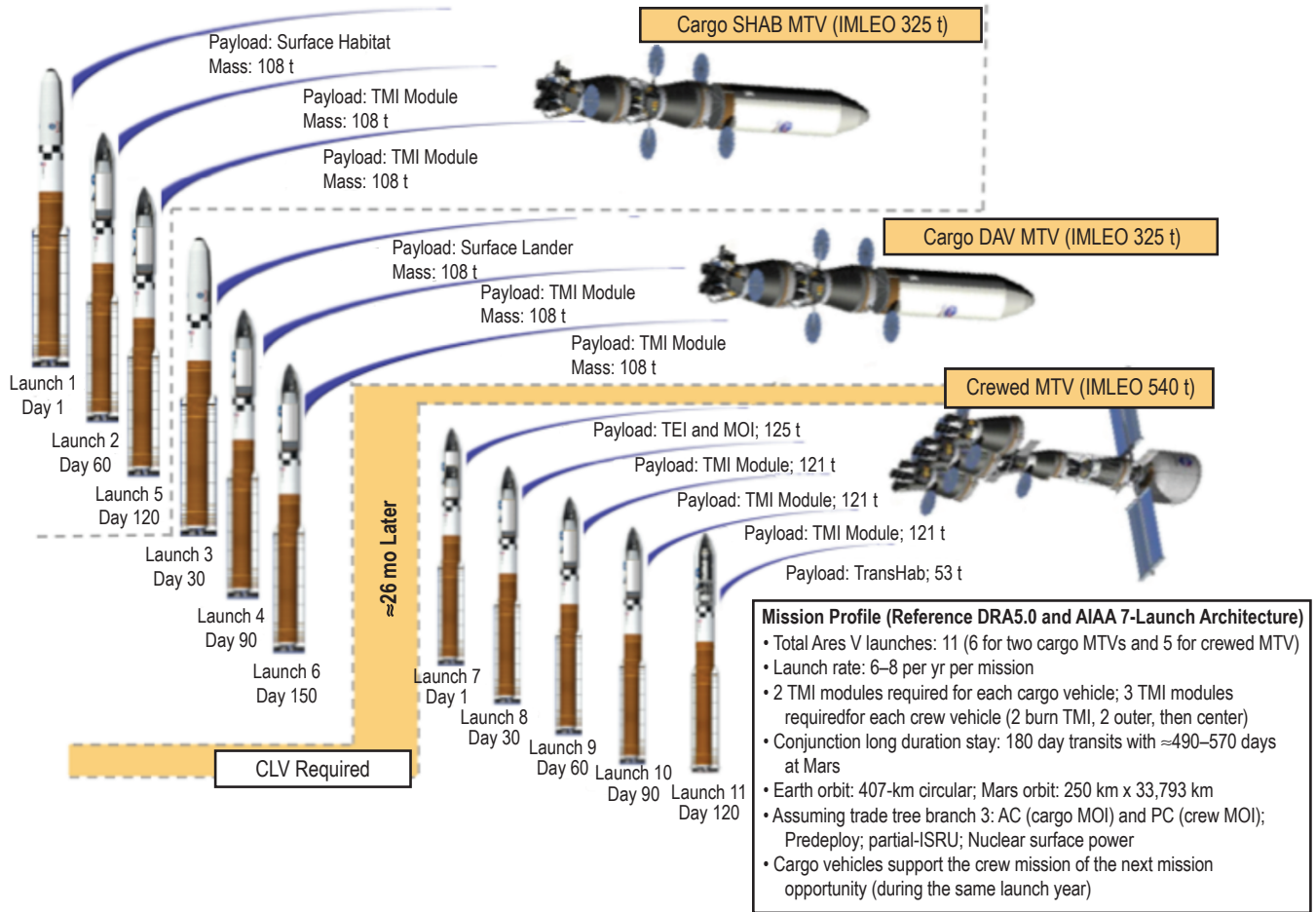

Figure 23. Chemical propulsion module option.

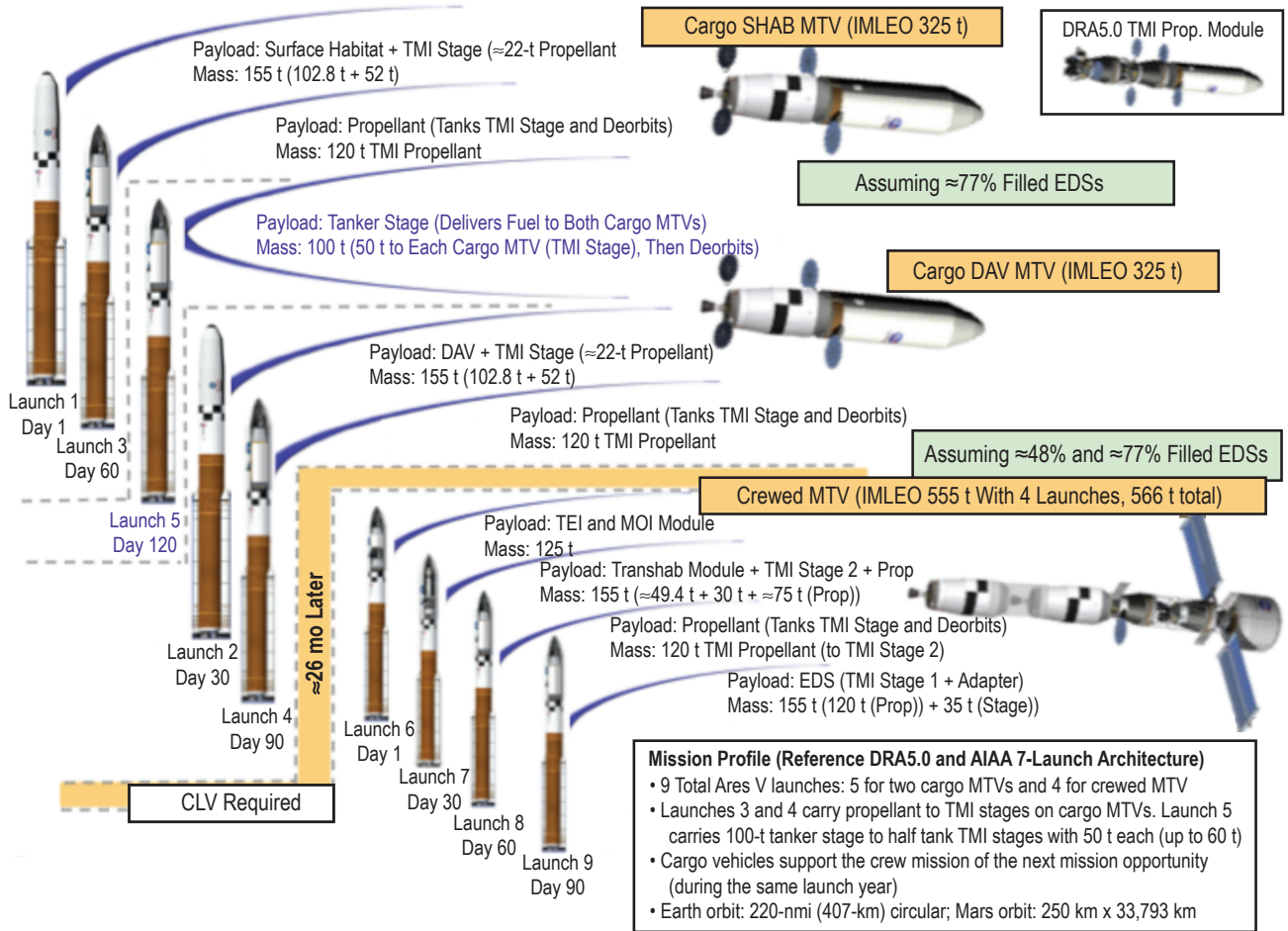

Figure 24. Propellant delivery and transfer option (EDS-as-MTV-stage).

5.2 In-Space Earth Departure Stage

The EDS Mars Extensibility team assessed the NTP, chemical, and EDS-as-MTV-stage campaigns for Mars exploration. There are also many benefits associated with employing an EDS as the TMI module. Eliminating the need to develop a new propulsive stage for TMI would have considerable benefits. The Mars DRM requires near-ZBO technology to allow the cryogenic fluid management system to function during the TMI maneuvers. This technology development would prevent otherwise necessary modifications to EDS propellant tanks or MPS. Figure 25 illustrates upgrades made to the lunar EDS if it were to serve as a multiarchitecture stage.

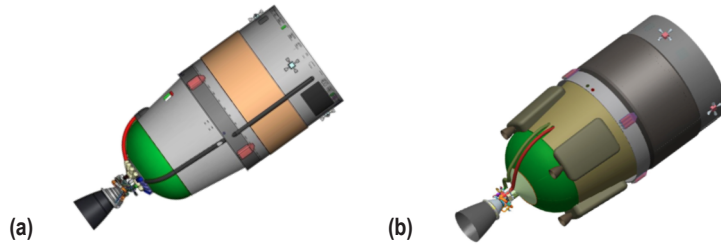

Figure 25. EDS concept for (a) lunar and (b) Mars architecture.

The EDS-as-MTV-stage has several challenges that are specific to this campaign. These are summarized as follows:

- J-2X not available for circularization burn because the second burn must be TMI.
- Cooperative debris avoidance of multiple EDS modules.
- EDS-to-EDS interfaces, including structural and communication.
- Disposal of stages providing the second part of TMI.
- Propulsive settling for multiple EDS modules.
- Propellant transfer between stages.
- Propellant transfer between drop tanks and main tanks.
- Disposal of drop tanks.
- Multiple passes (at least two, perhaps four) through the Van Allen radiation belts.
- Restart conditioning of multiple J-2Xs.
- Staging for multiple J-2Xs during TMI.
- Longer single-burn duration and total burn time duration for J-2X.
- Assured nuclear disposal (surface fission reactor power source).

5.3 Docking Adaptor and Propellant Transfer

As a supplemental part of the Mars extensibility study conducted during PA-C3, the functionality and design of an automated rendezvous and docking system was identified and assessed. Using the chemical scavenger nine-launch option (fig. 24) as a reference baseline for the analysis,

the objective was to add detail to the docking adaptor and propellant transfer required for the crewed MTV concept. Despite several docking mechanism options, the representative docking mechanism baselined for this effort was referred to as the N-point docking mechanism and is illustrated in figure 26.

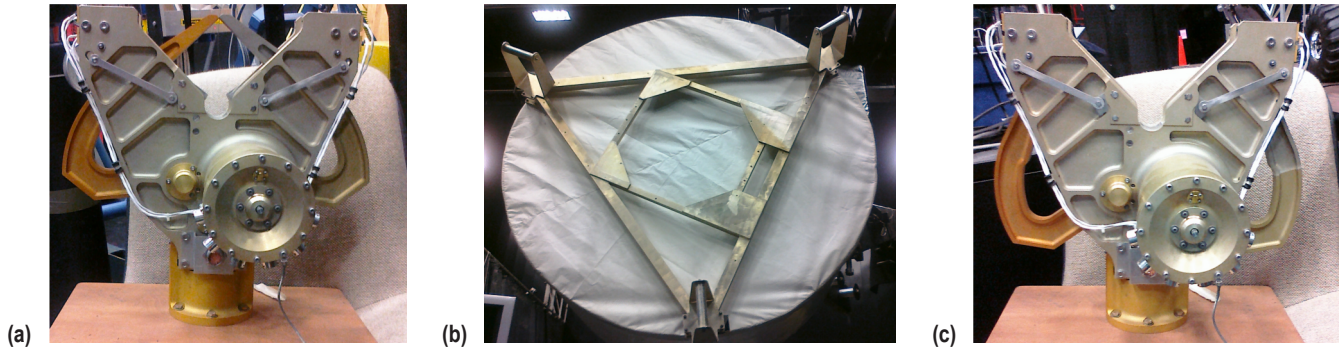

Figure 26. N-point docking mechanism with (a) and (c) latching claw, and (b) probes.

This mechanism allows for docking, undocking, and redocking capabilities, providing dV upon undocking if required. Telemetry supports precision capture and there may be several points for docking for redundancy or fail-safe contingency planning.

A timeline was required in order to assess the functional analysis of the docking sequence. The docking adaptor sequence of events was carried during the effort as follows:

- (1) Phasing trajectory.
- (2) Far-range rendezvous.
- (3) Close-range rendezvous.
- (3) Mating.
- (4) Propellant transfer.
- (5) Demating and separation.
- (6) Disposal.

Once this sequence was defined, a list of functions was generated then vetted among team members. The functions were established with the assumptions that the MTV integrated stack undocked in orbit from the stages involved with transferring propellant and that the propellant was transferred using centrifugal acceleration. A sample matrix of operations and functions is given in table 4 and shows the performers, functions, needs, and suppliers necessary for the phasing trajectory event during in-space docking.

Table 4. Phasing trajectory sample functions.

Event, Action	Performer	Functions	Needs	Supplier
Phasing Trajectory				
Reduction of orbital phase angle between rendezvous vehicle and target spacecraft	Tanker rendezvous vehicle	In-space movement	Propulsion thrust, vectorable, magnitude, varying	Onboard reaction control system or Orbital Maneuvering System (OMS)
	Tanker rendezvous vehicle	In-space navigation	Gyroscope, GPS, radar, sensors, star trackers	Avionics (flight computer, software)
	Tanker rendezvous vehicle	In-space communications	Telemetry, data, commands	Avionics, ground data system, space network
	Tanker rendezvous vehicle	In-transit cryo propellant management	Delivery proper prop load to target spacecraft	
Perform navigation updates	Tanker rendezvous vehicle	Communications	Telemetry, data, commands	Avionics, ground data system, space network
	Tanker rendezvous vehicle	Computations	State vectors etc.	Avionics (flight computer, software)
EDS perform alignments	EDS target spacecraft			
EDS begin free drift	EDS target spacecraft			
MTV undocks, assumes its own attitude control, goes into passive mode.	MTV payload	(Go to payload OPS)		
EDS assumes its own attitude control, performs backaway maneuver.	EDS target spacecraft			
EDS perform station keeping maneuvers	EDS target spacecraft	Propulsion	Propulsion thrust, vectorable, magnitude, varying	Onboard reaction control system
EDS go to docking attitude	EDS target spacecraft	Propulsion	Propulsion thrust, vectorable, magnitude, varying	Onboard reaction control system
	EDS target spacecraft	Navigation	Gyroscope, GPS, radar	Avionics (flight computer, software)
	EDS target spacecraft	Communication	Telemetry, data, commands	Avionics, ground data system, space network

The owners of these functions were then identified. Despite focus on Ares V vehicle components, this functional analysis has laid the groundwork for future work on HLLVs, regardless of specific stages such as the EDS used here.

Propellant transfer was also investigated for the chemical scavenger nine-launch option. A functional analysis was performed that included a feasibility study recommending a nose-to-tail configuration for the EDS in-space positioning during fuel transfer. This analysis identified the trade space for a fuel transfer scenario; however, higher fidelity analysis is necessary to assess the best stage-positioning choice, considering length of feed lines, MPS plumbing location and accessibility, etc. Six refueling positions were considered: Nose-to-tail, nose-to-nose, side-to-side (in parallel), tail-to-tail, side mount (nose-to-side perpendicular), and side mount (tail-to-side perpendicular). A propellant transfer trade tree was generated that incorporated such stage orientations, propellant settling types, and propellant transfer types.

A preliminary mass estimate of the docking adaptor was given with support from the design analysis team. The requested mass of the docking adaptor included the docking mechanism (N-point docking mechanism), truss structures, and any additional avionics. The computer aided design (CAD) models of the integrated vehicle (figs. 27–29) and the N-point docking mechanism (fig. 30) allowed for a structural loads assessment that preceded a stress analysis. The stress analysis performed for the truss structures assumed 7075-T6 Al, 4- × 0.25-in round tubing and heights of approximately 5.79 m (19 ft).

The thinnest skins were assumed for these analyses and only axial loads were assessed. Primary and secondary structure masses were assumed, but no mass was built-in to account for fault tolerances or uncertainty factors for structures or mechanisms. Forward work would include additional margin, material trades (composites), moment assessment, and finite element models (FEM) of the integrated MTV stack.

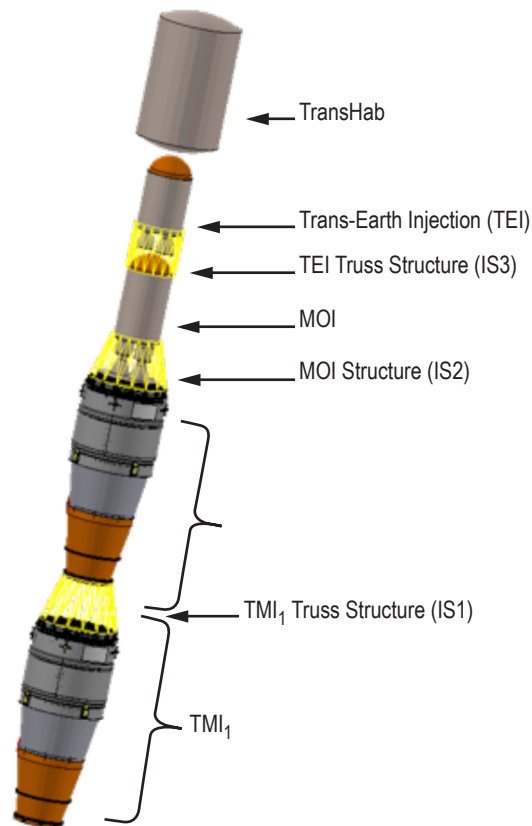

Figure 27. EDS-as-MTV model for loads and stress analysis.

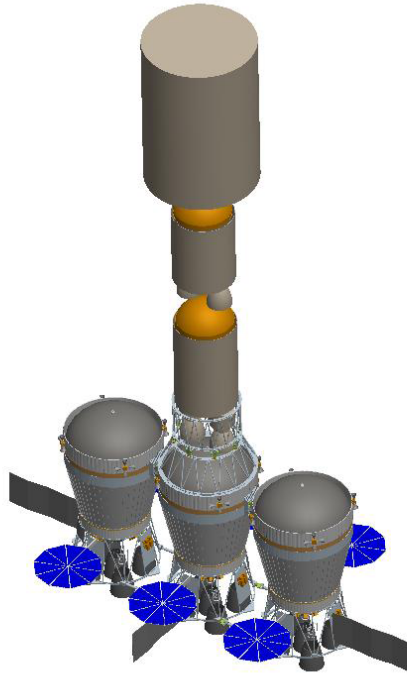

Figure 28. Chemical propulsion model for loads and stress analysis.

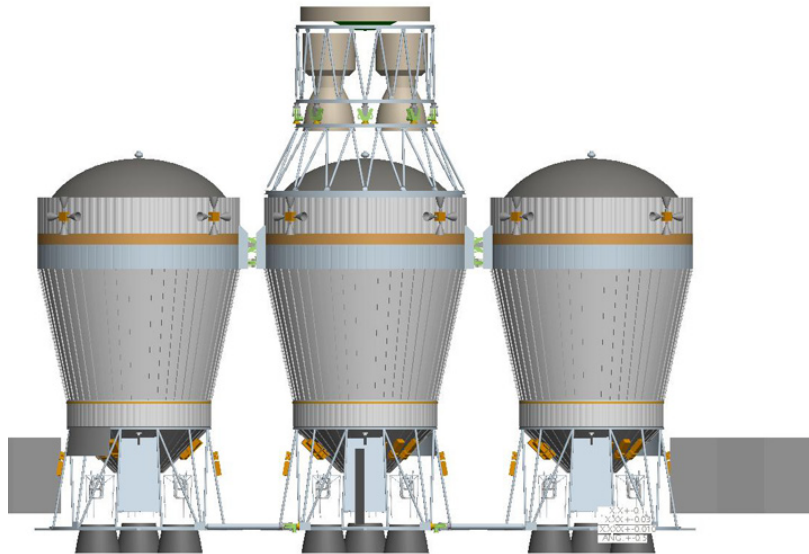

Figure 29. Dedicated in-space chemical propulsion stage and truss detail.

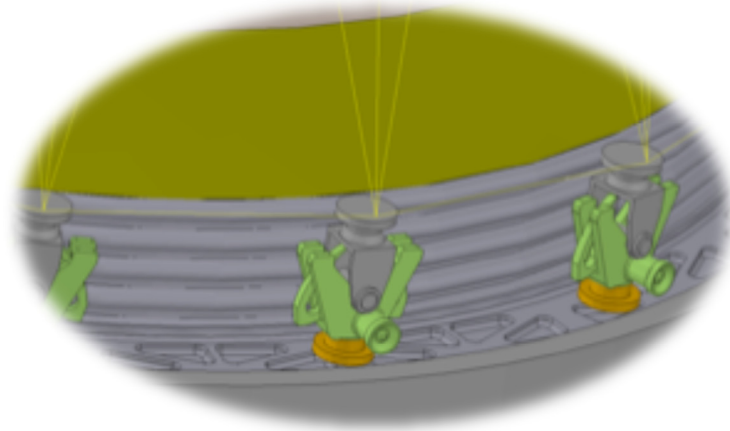

Figure 30. Docking adaptor mechanism and ring structure.

5.4 Lunar and Mars Synergy

Identifying the Mars architecture depended in large part on the commonalities between that and the lunar architecture already being assessed. It has been highly desirable to maintain as many commonalities as possible between the two transportation architectures in order to maximize the synergy, thereby reducing cost and complexity. As the Mars DRA 5.0 specifies, this synergy is defined by the subsystem technologies (i.e., trajectory and mission analyses, propulsion, structures, thermal, power, and avionics), space transportation, elements, and the use of common ETO LVs.

If systems are independently developed for Moon and Mars architectures, multiple obstacles may need to be addressed (e.g., delayed Mars operations due to a technology gap between the two missions). Similar to the impending Space Shuttle gap, the ability (cost and labor) to curtail lunar operations to enable Mars missions would likely occur postlunar missions. Even with a renewed investment in a Mars mission, there would be no heritage technology or experience with systems designed for independent Moon and Mars architectures.

In order to develop a sustainable architecture and resulting space program, technologies developed for lunar missions should carry considerable commonalities to those needed for Mars missions. Several aspects of the architecture offer potential for such synergy. This includes a common EDS module acting as either a TLI or TMI stage. Based on driving requirements, common lunar-Mars systems may be decomposed into such elements with similar capabilities. This synergy would allow for opportunities to directly validate Mars elements during lunar missions while encouraging advanced technological development for use on the Moon, instead of postponing development for Mars missions. The technologies employed herein may also have real-world applications. There is experience to be gained in routine manufacturing and system operation that would decrease risk and improve reliability. Technologies that would be developed for lunar and Mars DRMs may also prove compatible with other alternative missions, such as near-Earth orbit (NEO) destinations or missions that extend even beyond Mars.

REFERENCES

1. “Ares V Operational Concepts Document,” *CxP 72336*, Marshall Space Flight Center, AL, 2010.
2. “Constellation Architecture Requirements Document,” *CxP 70000*, Marshall Space Flight Center, December 2006.
3. “NASA’s Exploration Systems Architecture Study—Final Report,” *NASA/TM—2005–214062*, November 2005.
4. “Human Exploration of Mars Design Reference Architecture 5.0 Addendum,” B.G. Drake (ed.), *NASA/SP—2009–566*, Johnson Space Center, Houston, TX, July 2009.

REPORT DOCUMENTATION PAGE

Form Approved
OMB No. 0704-0188

The public reporting burden for this collection of information is estimated to average 1 hour per response, including the time for reviewing instructions, searching existing data sources, gathering and maintaining the data needed, and completing and reviewing the collection of information. Send comments regarding this burden estimate or any other aspect of this collection of information, including suggestions for reducing this burden, to Department of Defense, Washington Headquarters Services, Directorate for Information Operation and Reports (0704-0188), 1215 Jefferson Davis Highway, Suite 1204, Arlington, VA 22202-4302. Respondents should be aware that notwithstanding any other provision of law, no person shall be subject to any penalty for failing to comply with a collection of information if it does not display a currently valid OMB control number.

PLEASE DO NOT RETURN YOUR FORM TO THE ABOVE ADDRESS.

1. REPORT DATE (DD-MM-YYYY) 01-02-2011			2. REPORT TYPE Technical Memorandum			3. DATES COVERED (From - To)		
4. TITLE AND SUBTITLE Executive Summary of Ares V: Lunar Capabilities Concept Review Through Phase A-Cycle 3						5a. CONTRACT NUMBER		
						5b. GRANT NUMBER		
						5c. PROGRAM ELEMENT NUMBER		
6. AUTHOR(S) J.B. Holladay, K.E. Baggett,* and S.M. Feldman*						5d. PROJECT NUMBER		
						5e. TASK NUMBER		
						5f. WORK UNIT NUMBER		
7. PERFORMING ORGANIZATION NAME(S) AND ADDRESS(ES) George C. Marshall Space Flight Center Marshall Space Flight Center, AL 35812						8. PERFORMING ORGANIZATION REPORT NUMBER M-1307		
9. SPONSORING/MONITORING AGENCY NAME(S) AND ADDRESS(ES) National Aeronautics and Space Administration Washington, DC 20546-0001						10. SPONSORING/MONITOR'S ACRONYM(S) NASA		
						11. SPONSORING/MONITORING REPORT NUMBER NASA/TM-2011-216458		
12. DISTRIBUTION/AVAILABILITY STATEMENT Unclassified-Unlimited Subject Category 15 Availability: NASA CASI (443-757-5802)								
13. SUPPLEMENTARY NOTES Prepared by the Ares Projects Office *Zero Point Frontiers Corporation, Huntsville, Alabama								
14. ABSTRACT This Technical Memorandum (TM) was generated as an overall Ares V summary from the Lunar Capabilities Concept Review (LCCR) through Phase A-Cycle 3 (PA-C3) with the intent that it may be coupled with separately published appendices for a more detailed, integrated narrative. The Ares V has evolved from the initial point of departure (POD) 51.00.48 LCCR configuration to the current candidate POD, PA-C3D, and the family of vehicles concept that contains vehicles PA-C3A through H. The logical progression from concept to POD vehicles is summarized in this TM and captures the trade space and performance of each. The family-of-vehicles concept was assessed during PA-C3 and offered flexibility in the path forward with the ability to add options deemed appropriate. A description of each trade space is given in addition to a summary of each Ares V element. The Ares V contributions to a Mars campaign are also highlighted with the goal of introducing Ares V capabilities within the trade space. The assessment of the Ares V vehicle as it pertains to Mars missions remained locked to the architecture presented in Mars Design Reference Authorization 5.0 using the PA-C3D vehicle configuration to assess Mars transfer vehicle options, in-space EDS capabilities, docking adaptor and propellant transfer assessments, and lunar and Mars synergistic potential.								
15. SUBJECT TERMS Executive Summary, PA-C3, Ares V, trade space, point-of-departure, Mars extensibility								
16. SECURITY CLASSIFICATION OF:			17. LIMITATION OF ABSTRACT		18. NUMBER OF PAGES		19a. NAME OF RESPONSIBLE PERSON	
a. REPORT	b. ABSTRACT	c. THIS PAGE	UU		58		STI Help Desk at email: help@sti.nasa.gov	
U	U	U					19b. TELEPHONE NUMBER (Include area code) STI Help Desk at: 443-757-5802	

National Aeronautics and
Space Administration
IS20

George C. Marshall Space Flight Center
Marshall Space Flight Center, Alabama
35812