

DESIGN AND DEMONSTRATION OF A MINIATURE LIDAR SYSTEM FOR ROVER APPLICATIONS

Benjamin Robinson
Old Dominion University, Norfolk, VA 23529

Abstract

Public awareness of harmful human environmental effects such as global warming has increased greatly in recent years and researchers have increased their efforts in gaining more knowledge about the Earth's atmosphere. Natural and man-made processes pose threats to the environment and human life, so knowledge of all atmospheric processes is necessary. Ozone and aerosols are important factors in many atmospheric processes and active remote sensing techniques provide a way to analyze their quantity and distribution.

A compact ground-based lidar system for a robotic platform meant for atmospheric aerosol measurements was designed, tested, and evaluated. The system will eventually be deployed for ozone and aerosol measurements in Mars and lunar missions to improve our knowledge and understanding of atmospheres on Mars and the Moon. Atmospheric testing was performed to test the operability of the receiver system to acquire the lidar return signal from clouds and aerosols.

Background

Many research studies and reports have been published in recent years that seek to describe the negative effect that humans have on the environment. Whether it is global warming or ozone depletion, public awareness of such harmful environmental effects has increased greatly. With the influx of widespread atmospheric observations, researchers also have a greater knowledge and understanding of the Earth's atmosphere. Many natural and man-made processes pose threats to not only the environment, but human life. This makes it vitally important to improve our knowledge of any and all atmospheric processes. The quantity and distribution of ozone and aerosols are the most important factors for many atmospheric processes.

Ozone (O₃) is extremely important since stratospheric ozone protects us from harmful ultraviolet solar radiation. Although it is beneficial in the stratosphere, it is harmful in the troposphere because it acts as an air pollutant that damages human health and vegetation. This makes the buildup of ozone in the troposphere an important area of study for atmospheric

researchers. Aerosols are minute suspensions of solid or liquid particles in air. They are ever-present in air and are often observable as dust, smoke, and haze. Aerosols directly affect the Earth's energy budget by scattering and absorbing radiation and indirectly affect it by modifying amounts and microphysical radiative properties of clouds.

Since World War II, aerosols have been recognized as an important topic of applied science [1]. They play a significant role in the atmosphere and are involved in many atmospheric processes. On a global basis, aerosols derive predominantly from natural sources such as sea salt and dust. However, manmade aerosols, which come primarily from sources of combustion, can dominate highly populated or industrialized regions.

The addition of aerosols to the atmosphere alters the intensity of sunlight backscattered to space, absorbed in the atmosphere, and arriving at Earth's surface. This perturbation of sunlight by aerosols is called aerosol radiative forcing (RF) [2]. On a global average, the sum of direct and indirect aerosol RF calculated at the top of the atmosphere is negative (cooling effect), which offsets some of the positive (warming) aerosol RF in the lower atmosphere caused by manmade greenhouse gases [2]. Due to spatial and temporal non-uniformity of aerosol RF, the net effect is not equal and thus measuring and studying aerosols becomes an important scientific practice.

The troposphere, starting from the Earth's surface and ending at approximately 10 km, is the lowest portion of the atmosphere. The troposphere can be divided into the planetary boundary layer, extending from the surface to approximately 1 km, and the free troposphere, extending from 1 km to 10 km [1]. Aerosols are typically a dominant component of the boundary layer, and they continue to increase as cities become more industrialized.

Aerosol residence times in the troposphere are about 1 to 2 weeks, meaning that anthropogenic aerosols would disappear from the planet in 2 weeks if all SO₂ sources were shut off today [1]. On the other hand, greenhouse gases last for decades to centuries, but they take much longer to be fully transformed into equilibrium climate warming because of the great inertia of the climate system. As a result, if both CO₂ and aerosol emissions were to cease today, the Earth

would continue to warm as the climate system continues to respond to the accumulated amount of CO₂ already in the atmosphere [1]. In any case, the measurement of aerosols, especially in the troposphere, is important to atmospheric researchers since it provides information on their quantity and distribution.

A variety of techniques are available that are capable of obtaining valuable information about aerosols. The main approach that is used today involves active remote sensing, in which radiation is used to interact with various molecules and aerosols to obtain information such as quantity, size, or distribution of the particles. Satellite remote sensing allows measurement-based characterization of aerosols on a global scale [2].

In remote sensing, radiation is produced by the transmitter and emitted in the form of light, radio waves, microwaves, or acoustic waves. The emitted radiation is backscattered by the atmospheric constituents and collected with a receiver system that includes a telescope, optics, and detectors. The collected light is then analyzed. This type of sensing has the advantage of being independent of time of day and natural radiation sources. Lidar, which has been deployed on various platforms and missions, is an example of an active remote sensing system, and it has the advantage of displaying high vertical resolution profiles at various altitudes [3].

Lidar, which stands for light detection and ranging, is an active remote-sensing technology that measures the properties of scattered light with respect to the distance or range of a target. Lidar systems are based upon the same principles that are used in radar and sonar systems. A radar system uses radio waves for detection and ranging, but a lidar system has the distinct advantage of using light for detection and ranging. Lidar is much better for certain applications because very small particles, such as aerosols, can be easily detected due to the fact that a lidar uses much shorter wavelengths in the electromagnetic spectrum. Radar systems use radio waves that may not detect small particles because the wavelength of radio waves is too large for accurate detection of small particles [4].

The operation of a lidar system is fairly simple. A light pulse is transmitted into the atmosphere and that light is scattered in all directions by various atmospheric constituents such as molecules, atoms, aerosols, clouds, or dust particles. Some of the scattered light is reflected back to the lidar system, where it is focused by a telescope into a photodetector. The photodetector usually is connected to a data acquisition system and a computer that can measure the amount of backscattered light as a function of distance. From that description, it is clear that any basic lidar system will require four main components: a laser, a telescope

assembly, a photodetector (APD or PMT), and a computer system for data acquisition [5]. A typical lidar system block diagram can be seen below in Figure 1.

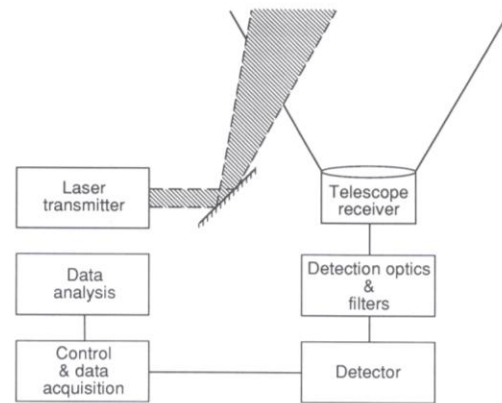

Figure 1 – Typical Lidar System Block Diagram

Rover Lidar System

A picture of the physical rover lidar system can be seen in Figure 2. The actual rover system consists of numerous components for both raman spectroscopy and lidar, but only lidar will be discussed. The rover subsystem components necessary for lidar consist of the following: the laser (transmitter), the telescope assembly, the receiving optics (including components such as mirrors, filters, etc.), the photomultiplier tube (PMT), the power distribution unit (PDU), and the data acquisition system. Each of these subsystems will be briefly discussed.

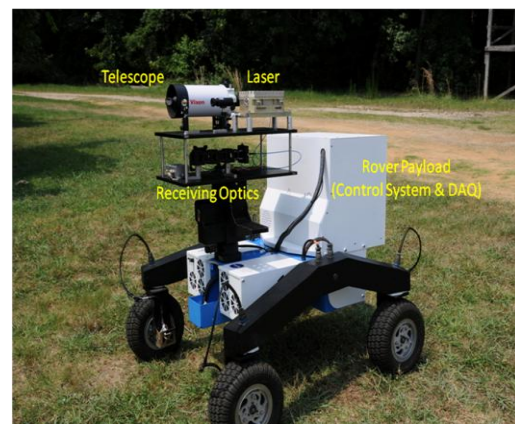

Figure 2 – Picture of Rover Lidar System

The lidar transmitter consists of an all solid-state diode pumped Q-switched Nd:YAG laser mounted on the mast on the front of the rover, along with all of the associated power and lidar control units which are supported in the rover's rear payload. The main component of the laser transmitter is the Nd:YAG ($\text{Nd}^{3+}:\text{Y}_3\text{Al}_5\text{O}_{12}$) crystal slab, which produces intra-cavity second harmonic (532 nm) and third harmonic (355 nm) generation when combined with the Type I LBO doubler and Type II LBO tripler. In order to achieve the required temperatures for non-critical phase matching, the two LBO crystals are mounted in temperature controlled ovens. Temperature tuning of the ovens is used for the final fine tuning of both the second and third harmonic generation efficiencies to achieve the desired energies at each wavelength. The Type I LBO doubler temperature is maintained at 128.93 ± 1 degrees Fahrenheit and the Type II LBO tripler temperature is maintained at 133.18 ± 1 degrees Fahrenheit.

The Nd:YAG laser also utilizes a $\text{Cr}^{4+}:\text{YAG}$ crystal to achieve passive Q-switching and produce a pulsed laser output at a repetition rate of 20 Hz. Passive Q-switching is an alternative technique to active Q-switching, where an acousto-optic modulator is incorporated into the laser resonator and acts as a shutter by blocking and unblocking the laser beam. In passive Q-switching, the acousto-optic modulator is replaced with a saturable absorber. The saturable absorber ($\text{Cr}^{4+}:\text{YAG}$ crystal) initially introduces a high optical loss. Once the gain reaches this loss level and the pulse begins to build up, the absorber is saturated. This means that the optical loss is reduced and the pulse buildup is accelerated. A short pulse is emitted shortly after the laser gain exceeds the resonator losses. After the pulse, the absorber returns to its high loss state before the gain recovers so that the next pulse is delayed until the gain medium's energy is replenished.

The output beam of the Nd:YAG laser, which consists of three separate wavelengths (355 nm, 532 nm, and 1064 nm), is directed towards a beam expander to reduce beam divergence. The 5x beam expander is designed to keep the transmitted beam to a diameter of approximately 20 mm with a beam divergence of <0.5 mrad. The expanded beam is then directed towards a moveable mirror, which can be adjusted to direct the laser beam towards a second fixed mirror that is attached directly to spider cage on the front of the telescope. Since the telescope and second beam-steering mirror are stationary, it is vital to adjust the first beam-steering mirror so that the axes of the beam and telescope are parallel with one another.

The lidar receiver system consists of a Vixen VMC110L Telescope, along with various receiving

optics. The telescope has a 110 mm primary mirror diameter and a focal length of 1035 mm. An optical schematic of the telescope assembly and transmitter optics is shown in Figure 3. The telescope is connected to the receiving optics assembly by a 1-mm Polymicro Technologies fiber optic cable with a numerical aperture of 0.22 that transmits the received signal from the telescope to the receiver assembly, which houses the PMT and beam dumps.

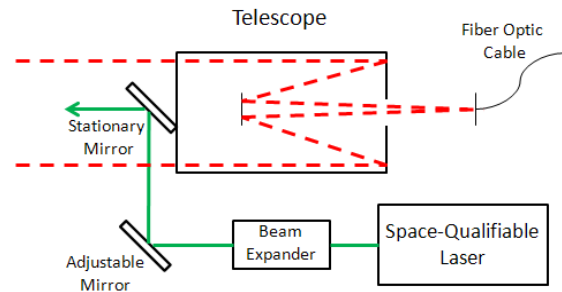

Figure 3 - Optical schematic of telescope assembly and transmitter optics

An optics plate mounted on the rover contains all of the receiving optics used to detect atmospheric return signals. A simple optical schematic of the receiving optics is shown in Figure 4. The PMT that is being used to measure the 532 nm return signal was based on a circuit designed by Don Silbert (GFSC) and modified by Terry Mack (Lockheed Martin). This design supports the Hamamatsu R7400 metal package photomultiplier series tube. By using a small telescope as a receiver, the lidar return signal will be very weak, so we need an extremely sensitive PMT with low noise and high gain. This makes the Hamamatsu PMTs an ideal choice for detectors since they have low noise, high gain, and excellent response times, making them perfect for any light detection application. The PMT requires voltages of 15 V and ± 5 V for power, and it receives the power signals from the power distribution unit.

The output of the 1 mm fiber optic cable immediately passes through a collimating lens. Next, the beam passes through a notch filter that effectively splits the 355 nm beam from the rest of the signal and sends it to a beam dump. The signal then passes through another notch filter that splits the 532 nm beam from the rest of the signal. The 532 nm beam passes through a focusing lens and a narrowband pass filter before reaching the PMT. Next, the signal passes through a third notch filter that splits the 1064 nm beam from the rest of the signal. The 1064 nm is sent to a

beam dump and the rest of the signal is focused into a 100 μm fiber optic cable by a focusing lens. The other end of the cable is connected to a Raman spectrometer.

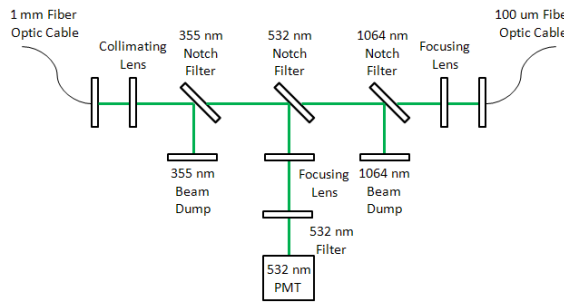

Figure 4 - Optical schematic of receiving optics

The power distribution unit (PDU) is the most vital part of not only the lidar system, but the entire rover system. The PDU receives power from 2 12 V DC batteries connected serially (24 V DC total) and distributes it appropriately to the data acquisition system (NI PXI Chassis), the laser driver module, and the 532 nm PMT. The 24 V DC supply power is split and routed through EMI filters, relays, DC-DC convertors, and current sensing modules before being distributed to individual system components. It also routes control signals from the NI PXI Chassis to individual system components. The custom-built PCB board and the case to house it were populated so that jacks and connectors could be used to route signals to the appropriate system components.

The data acquisition system consists of a NI PXI chassis (NI PXI-1031DC) that uses four cards: a NI PXI-8106 Embedded Controller, a NI PXI-6115 Multifunction I/O card for input and output signals, a NI PXI-6259 Multifunction DAQ card for input and output signals, and a NI PXI-1428 Image Acquisition card for the ICCD camera (for a separate Raman spectrometry application being used on the rover). The NI PXI-6115 card performs high-speed, analog data acquisition for the 532 nm atmospheric return signal and has 12 bit resolution along with a 10 MS/s sample rate. The card acquires 50 ms of data (each individual laser shot), processes the data, and saves it in a text file. Each individual shot is saved in a separate text file, but the LabVIEW program that controls all of the signals contains an option to save any number of averaged shots to reduce the amount of data. The data acquisition system runs from a master LabVIEW program that controls input/output signals, control signals, power signals, and steering on the rover.

The rover system requires assorted components for lidar and rover control. All of the components necessary for control are located on the rear payload of the rover. The main component for control is the NI PXI chassis, which handles lidar control and data acquisition. The PXI has been set up with a router so that it can be remotely accessed from a laptop computer. The entire rover system can be controlled from this remote connection. One LabVIEW program controls rover movement and allows the user to control the movement of the rover and the mast (for lidar or raman mode of operation) with a USB joystick. Another LabVIEW program, which is shown in Figure 5, controls the power relays, I/O signals, and lidar experimental values.

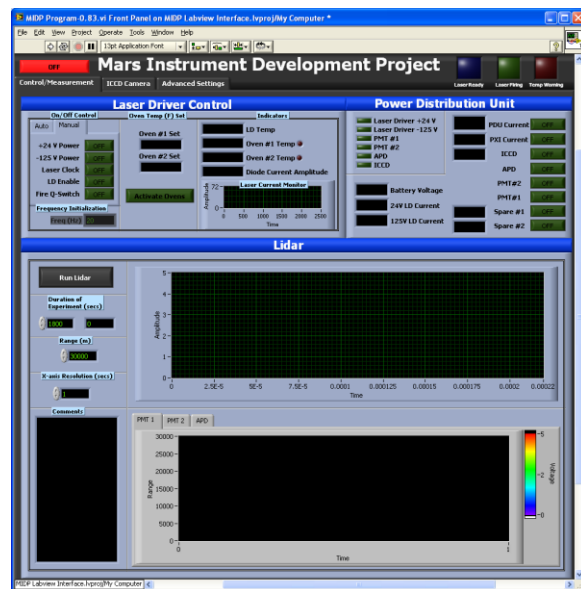

Figure 5 - LabVIEW Control Panel

The LabVIEW program has a built in automatic power up setting that will automatically turn on the laser and set the oven temperatures. The control panel also contains various indicators such as laser diode current and battery voltage. The PXI chassis samples at a 10 MHz rate, and therefore we have a resolution of 15 meters. Since each shot is saved in a text file, the size of the text file will depend on the desired range. For example, if the range was set to 150 meters, then there would be 10 rows of data in a saved shot text file. Therefore, there is an option for Range to reduce file size (which is normally set to 10 km). By clicking the “Run Lidar” button on the control panel, a lidar experiment will begin and each laser shot text file is saved to an external hard drive connected to the

remote laptop. During the experiment, a live view of the lidar return signal can be seen on the two display graphs. All data analysis is also done on the remote laptop using MATLAB software. Different files have been created to perform background correction and range squared correction.

Lidar Experimental Setup

A diagram of the basic setup for the lidar experiment is shown in figure 6. The space-qualifiable laser sends 20 Hz laser pulses into the atmosphere during a lidar experiment. The 355 nm, 532 nm, and 1064 nm laser outputs are always transmitted and give returns from the atmosphere, but this research is only interested in the atmospheric aerosol and cloud returns from the 532 nm laser output. The telescope collects the return pulses from the atmosphere and focuses them into a 1 mm fiber optic cable, which is connected to the receiving optics. As part of the receiving optics, a PMT is used to detect the atmospheric return signals.

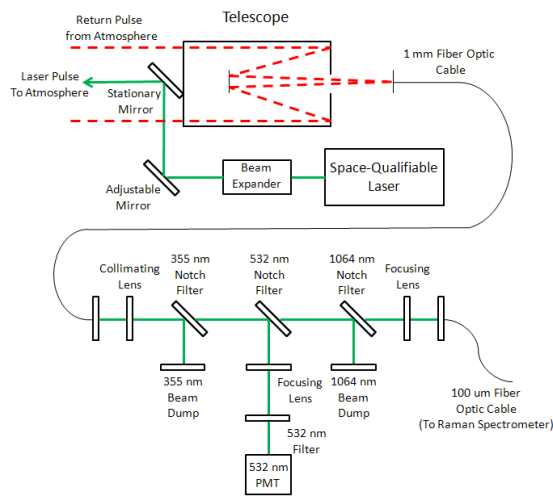

Figure 6 - Rover lidar setup for aerosol and cloud measurements

532 nm Atmospheric Aerosol Test

For the atmospheric test, the 532 nm laser beam was transmitted into the atmosphere at a repetition rate of 20 Hz with a pulse energy of about 14 mJ. The test was performed on August 20, 2010 from about 10:00 AM to 12:00 PM. Figure 7 shows a plot of a raw single return signal and Figure 8 illustrates the return signal intensity for the two hours of testing. For data analysis, the data must be corrected for

background noise and range. To determine the DC voltage offset created by atmospheric and system noise, the PMT is triggered to take data 200 μ s before the laser is pulsed. This data is averaged for each shot and subtracted from the entire signal to account for noise correction. Since the lidar return signal decreases by $1/R^2$, the range-corrected signal is defined by multiplying the raw return signal by R^2 . Figures 9 and 10 show the background range-corrected lidar return signal and the background range-corrected return signal intensity, respectively. These two figures are 1 minute averages (1200 shot) as well. It was extremely humid and foggy on this particular day, so the boundary layer of the troposphere can easily be seen from 0 to 1500 m in Figure 23. Also, a thin cloud layer can be seen at approximately 2000 m and a thin plume layer can be seen at approximately 2500 m.

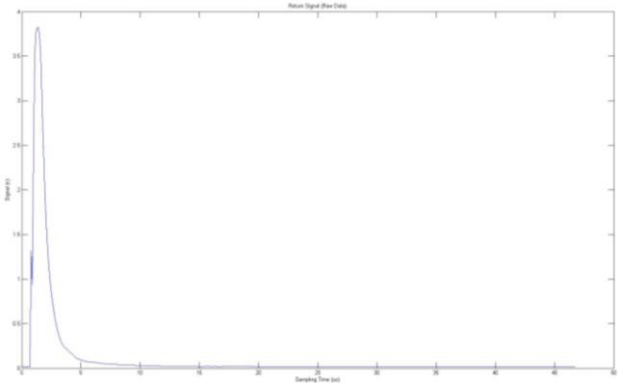

Figure 7 - Raw lidar return signal

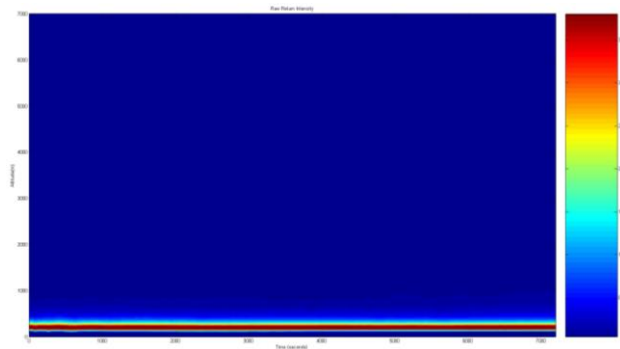

Figure 8 - Raw lidar signal image

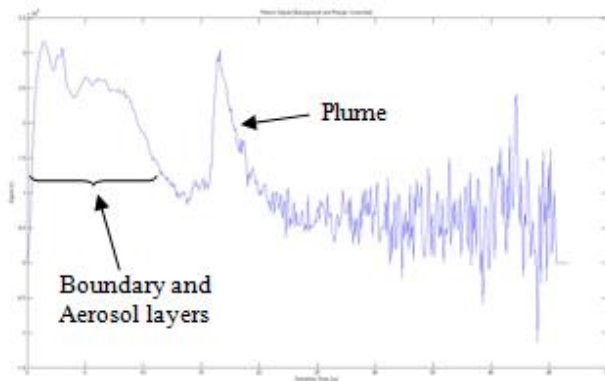

Figure 9 - Background range-corrected lidar return signal

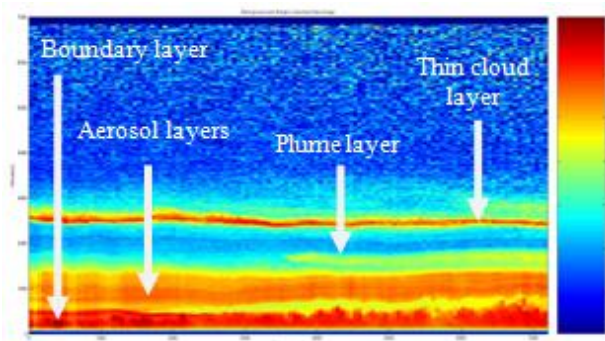

Figure 10 - Background range-corrected lidar signal image

Future Work

Due to the nature of work, further future work can be done to provide better results and to increase the capabilities of the lidar rover system. The laser that is used, which is manufactured by Fibertek, is capable of providing three separate wavelengths of 355 nm, 532 nm, and 1064 nm. By adding another PMT or APD to the 355 nm and 1064 nm channels, more lidar return data could be obtained. By using data from all three wavelengths, ozone measurements and further data analysis could be performed. Also, the current notch filters have relatively poor efficiency, so replacing them with more efficient filters may improve the overall system efficiencies.

Conclusion

In this research, a compact rover lidar transmitter and receiver system for atmospheric aerosol measurements was designed and tested. The purpose and need for such a system was discussed, and all of the major subsystems (transmitter and receiver) were described. The 532 nm laser beam was transmitted to the atmosphere and the backscattered signals were gathered by the lidar receiver system. The backscattered signal was directed to a PMT and voltage signals were received by a NI PXI data acquisition system that processed the data. The receiver and data acquisition system operated as expected. An atmospheric aerosol measurement was carried out on August 20, 2010. The measured results showed excellent aerosol and plume distributions. The data showed that the rover lidar system was working properly and that it could be used to perform atmospheric aerosol lidar measurements.

Acknowledgements

This work has been performed in Remote Sensing Flight Systems Branch, Engineering Directorate, NASA Langley Research Center, Hampton, VA 23681. The author would like to thank Dr. M. Nurul Abedin (LaRC), NASA technical monitor, for giving him the opportunity to work in his Raman Lidar. In addition, he would like to thank the entire MIDP team at NASA Langley Research Center for all of their support. Finally, he would like to thank his supervisor, Dr. Hani Elsayed-Ali (ODU), for his support and guidance.

References

- [1] J. H. Seinfeld and S. N. Pandis, *Atmospheric Chemistry and Physics – From Air Pollution to Climate Change*, John Wiley & Sons, Inc., New Jersey (2006).
- [2] CCSP 2009: *Atmospheric Aerosol Properties and Climate Impacts*, A Report by the U.S. Climate Change Science Program and the Subcommittee on Global Change Research. [Mian Chin, Ralph A. Kahn, and Stephen E. Schwartz (eds.)]. National Aeronautics and Space Administration, Washington, D.C., USA, 128 pp.
- [3] J. Reagan, M. McCormick, and J. Spinhirne, "Lidar Sensing of Aerosols and Clouds in the Troposphere and Stratosphere," *Proceedings of the IEEE* **77**(3), 433-448 (1989).
- [4] C. Billings, *Lasers, The New Technology of Light*, Oxford, New York (1992).
- [5] V. Kovalev and W. Eichinger, *Elastic Lidar*, John Wiley & Sons, Inc., New Jersey (2004).