



Electrostatic Discharge Issues in International Space Station Program EVAs

John B. Bacon, Ph.D.
ISS Program Integration Office
NASA Johnson Space Center, Mail Code OM3
2101 NASA Parkway
Houston, TX 77058 USA
(+1) 281-244-7086
john.bacon-1@nasa.gov

Photo credit: NASA



Thanks and content credits to:

- Dr. Douglas Hamilton/ Wyle Labs
- Dr. Steven Koontz/NASA
- Dr. Leonard Kramer/Boeing
- William Spetch/NASA
- Ron Mikatarian/Boeing



Spacecraft Charging

- Low altitude plasma - Subject of this talk
 - Cold, dense plasma that most often suppresses satellite surface charging
 - Roughly similar to an air ionizer
 - Can also **cause** charging by interaction with spacecraft voltage sources
 - Encountered at orbital speeds (8 km/sec)
- High altitude plasma
 - A problem at Geostationary, polar orbits, and radiation belts
 - Many charging anomalies including loss of spacecraft
 - Energetic, rarified plasma, able to charge satellites to high voltages directly
 - Encountered at variety of speeds (trapped plasma, solar wind)
- Particle Radiation
 - Trapped radiation and auroral arcs
 - Encountered over range of speeds up to relativistic



The Plasma

- Our natural plasma varies with altitude, past and current solar activity, Earth's variable geomagnetic index, latitude, longitude, and local time
- Cold dense plasma in low earth orbit (LEO) gives rise to different problems than hot, rarified plasma at Geostationary orbit (GEO)



Photo credit: NASA



International Space Station

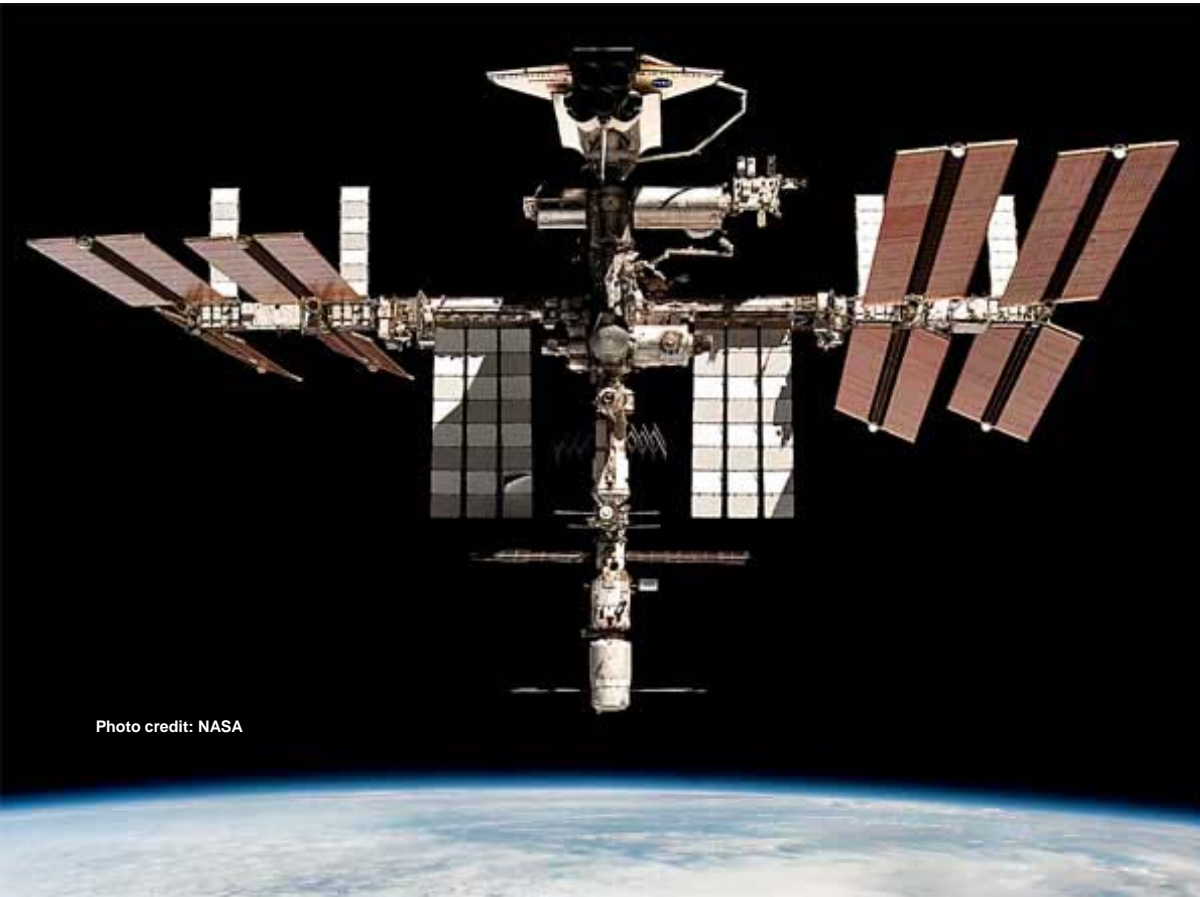

Photo credit: NASA

- 440+ tons, mostly aluminum
- 100 meters wide
- 160 VDC primary power from 8 wings (120VDC secondary) is grounded to hull
 - “S” bonding or better between all elements
- Russian System (28VDC) is not grounded
- Oxide and other insulators cover outer surface
- Flies in “F” region of ionosphere at 400km



Is ESD a problem to ISS?

- A hazard occurs whenever one disturbs an equilibrium: i.e., while passing any sort of energy into anything of value to you.
- ESD: the act of passing electricity through something of value to you.
==A hazard
- We have non-bonded conducting objects (especially including crew) in plasma with B fields and E fields
 - Lots of ways to make an electrostatic discharge
== Lots of hazards



Therefore:

- The risk of electrostatic discharge through EVA crew was elevated in 2001 to be one of the top ISS program risks
 - Only recently downgraded.
 - This presentation shows why



The Players:

- The EVA crewperson (the potential victim...)
- The Potential Antagonists:
 - The ISS metallic structure
 - The ISS thin oxide and insulating coatings
 - The ISS high voltage solar power arrays
 - The natural plasma
 - (and sun/earth influences on it)
 - The artificial plasma created by ISS PCUs
 - The Earth's magnetic field ("B")
 - The EVA suit(s) and tools/tethers



The crewperson is not bonded to structure

- Anodized surfaces

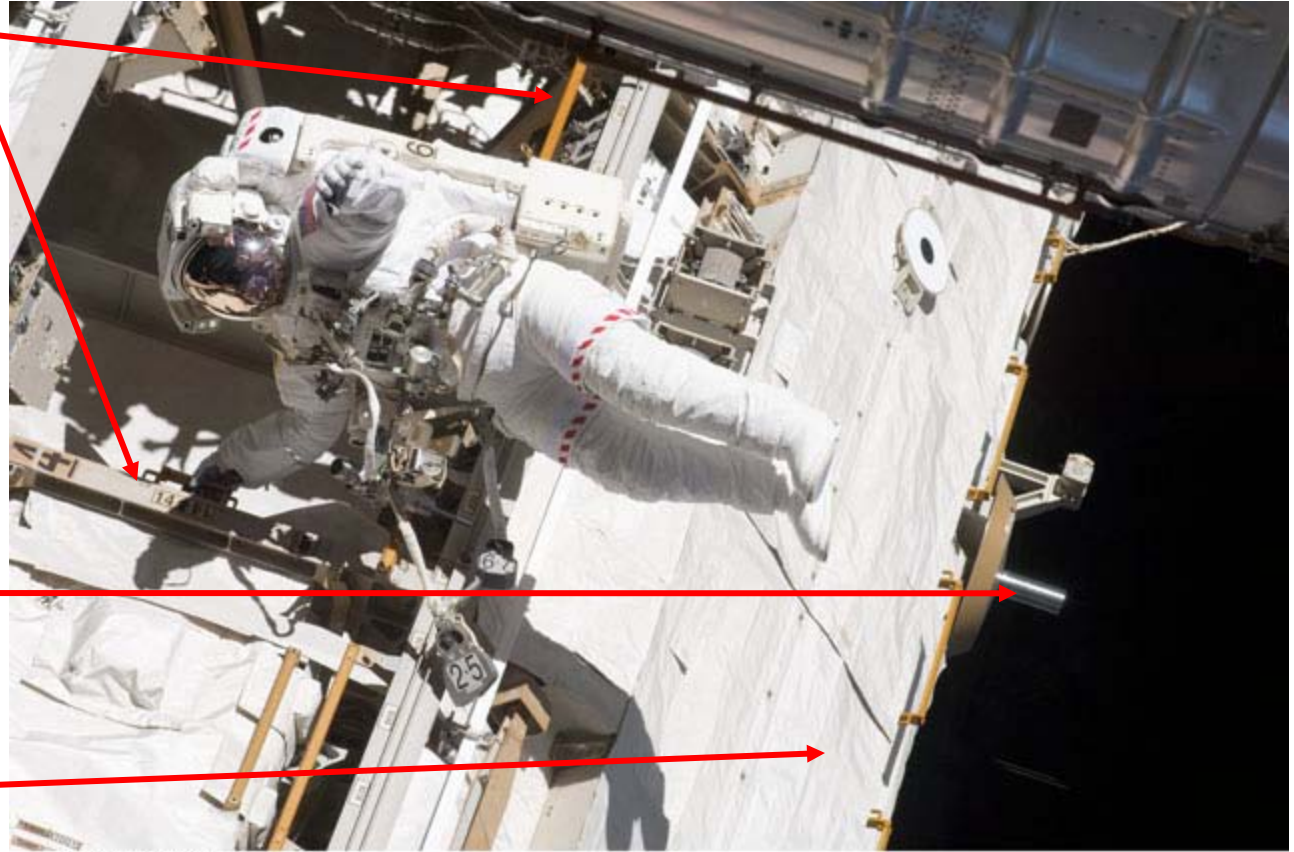

- Some very-well grounded exposed conductors exist

- Insulating blankets

Photo credit: NASA



Worrisome Features:

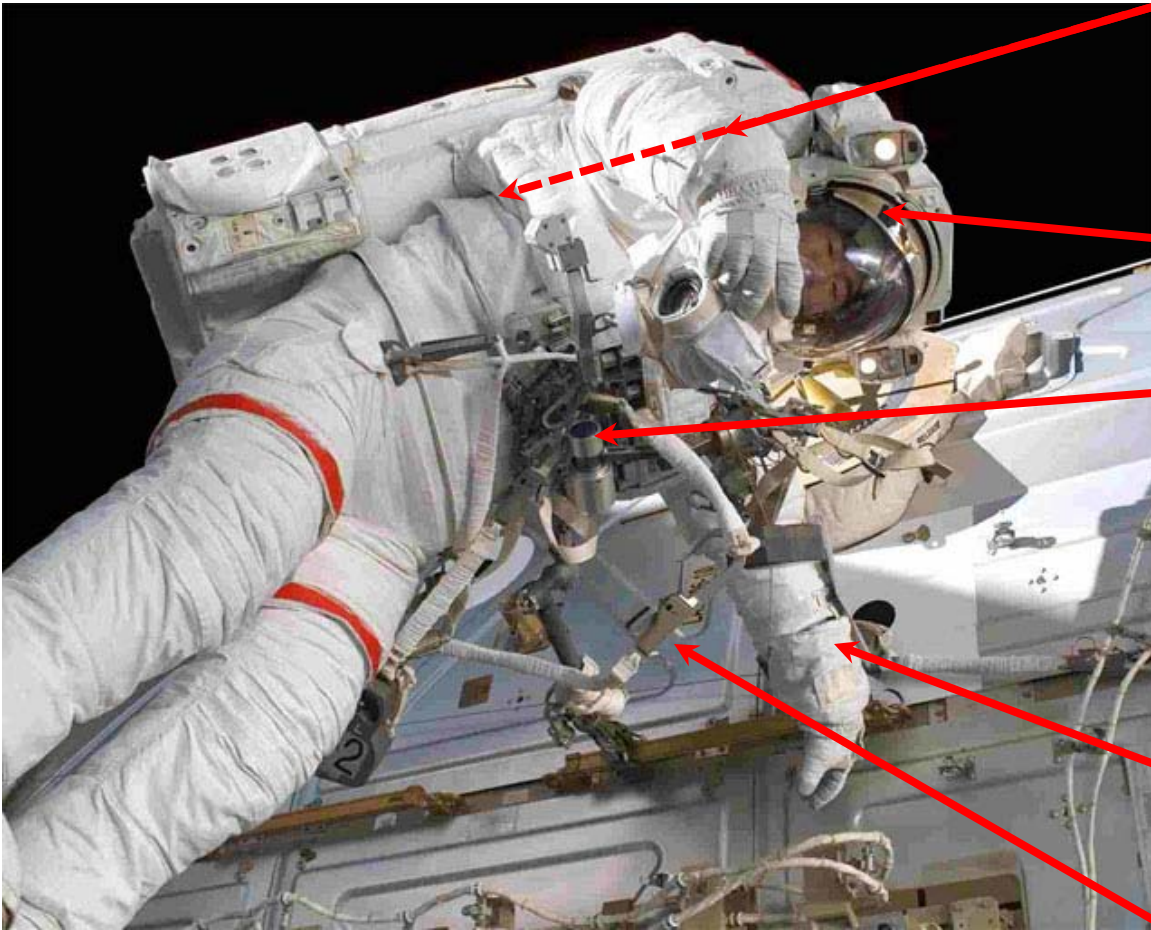

Photo credit: NASA

- Medical sensors with metal connector shells inside suit

- Sweat-soaked crew

- Metal tools and caddy that bolts to isolated metal components of suit and are connected only by the crewman inside

- Exposed joints/bearings

- Metal tethers





Russian “Orlan” suit



- Single-piece construction has sewn covers over most metal fittings
- Rarely (never) far from ISS centerline (neutral potential)

Photo credit: NASA



People



- Only recently modeled with sufficient accuracy to predict true neuro-physiological responses
 - 335 million 1x1x1mm voxels define the expected internal conductance/ impedance
 - Consistent E-fields at every 1mm² interface sought throughout body in 3D
 - =Weeks in a supercomputer
- THEN the result is fed to a neural model
- =Many more weeks in a supercomputer

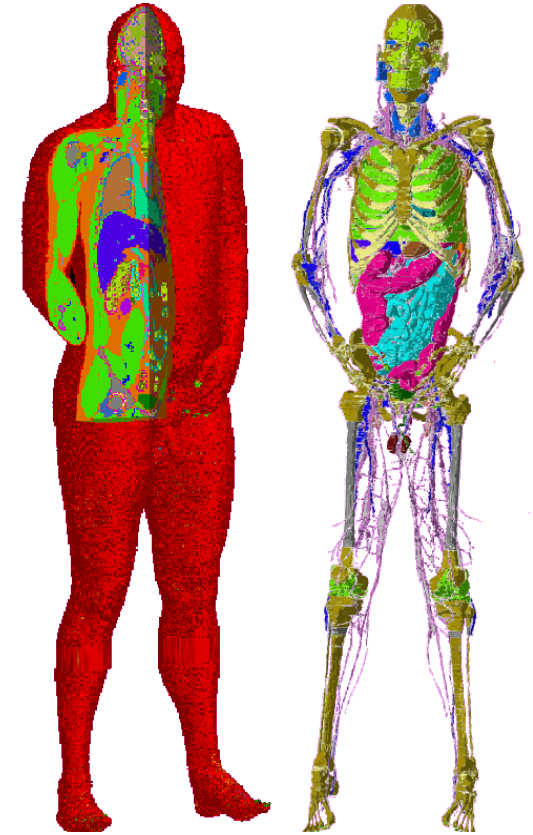

Brooks Man anatomical model with a cutout (left image) and with skin, fat and muscles removed (right image).



Locate Skin Contact Areas to Analyze Worst Case

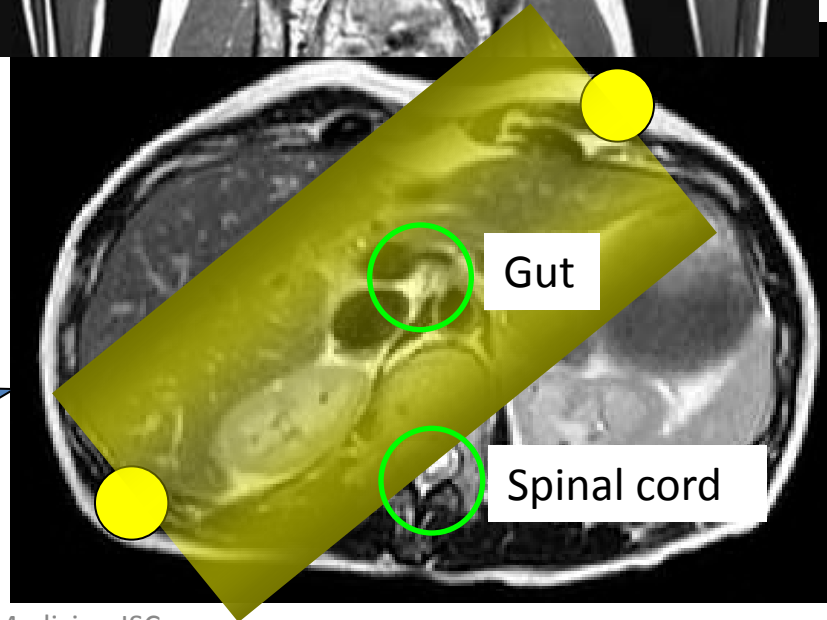
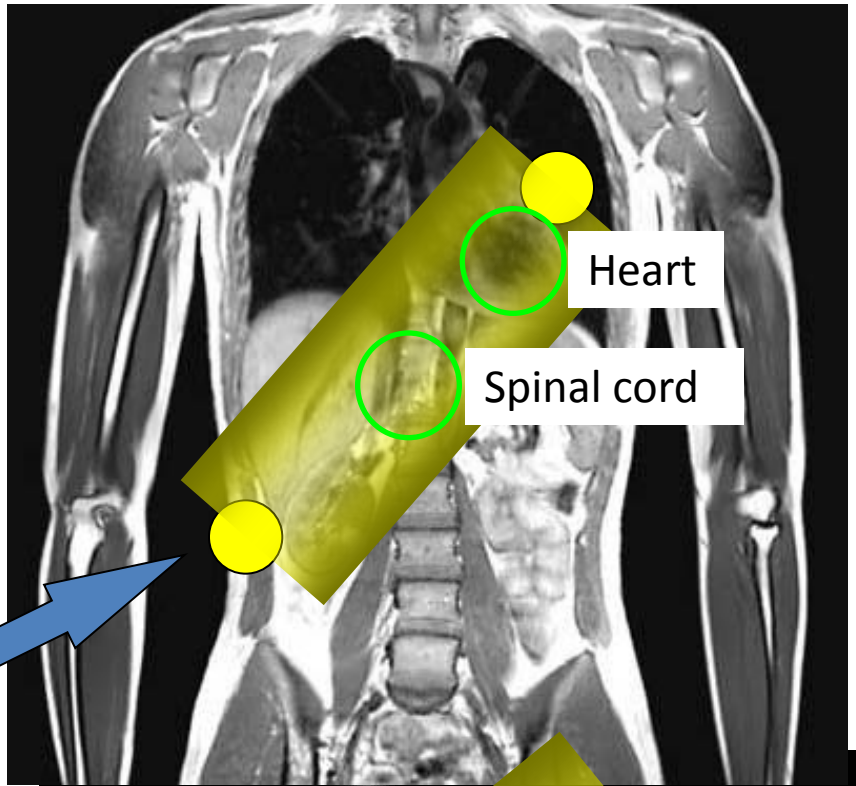
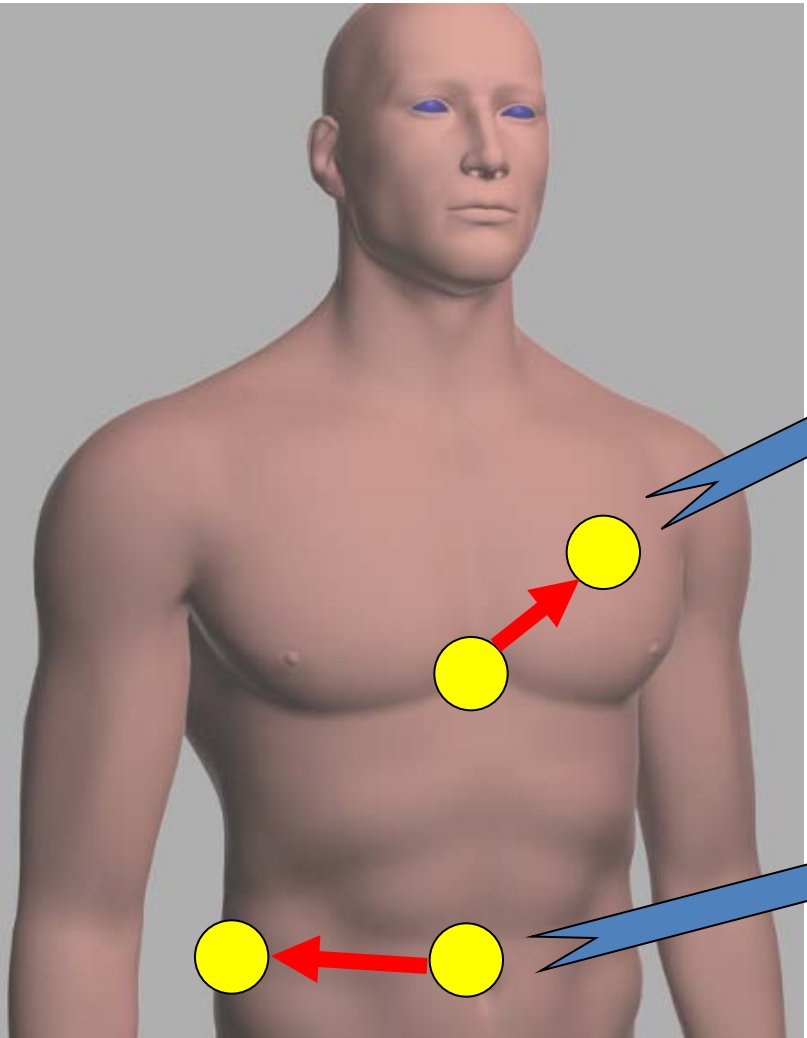

August 24th, 2009



The Hazards: Simplest spacecraft charging hazard causes in low earth orbit:

- Un-encapsulated high voltage PV power systems, with negative end grounded to spacecraft conducting structure, that can collect electrons from the cold dense ionospheric plasma
- Large metallic spacecraft structures that generate motional EMF when flying through earth's magnetic field at orbital speed ($V \times B \cdot L$) and also collect electrons for the plasma.

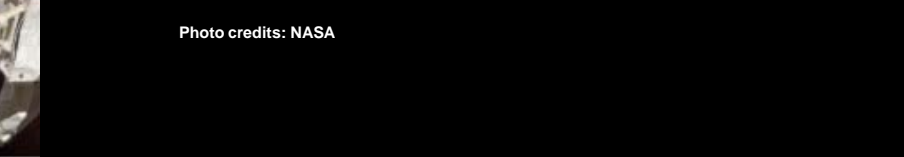
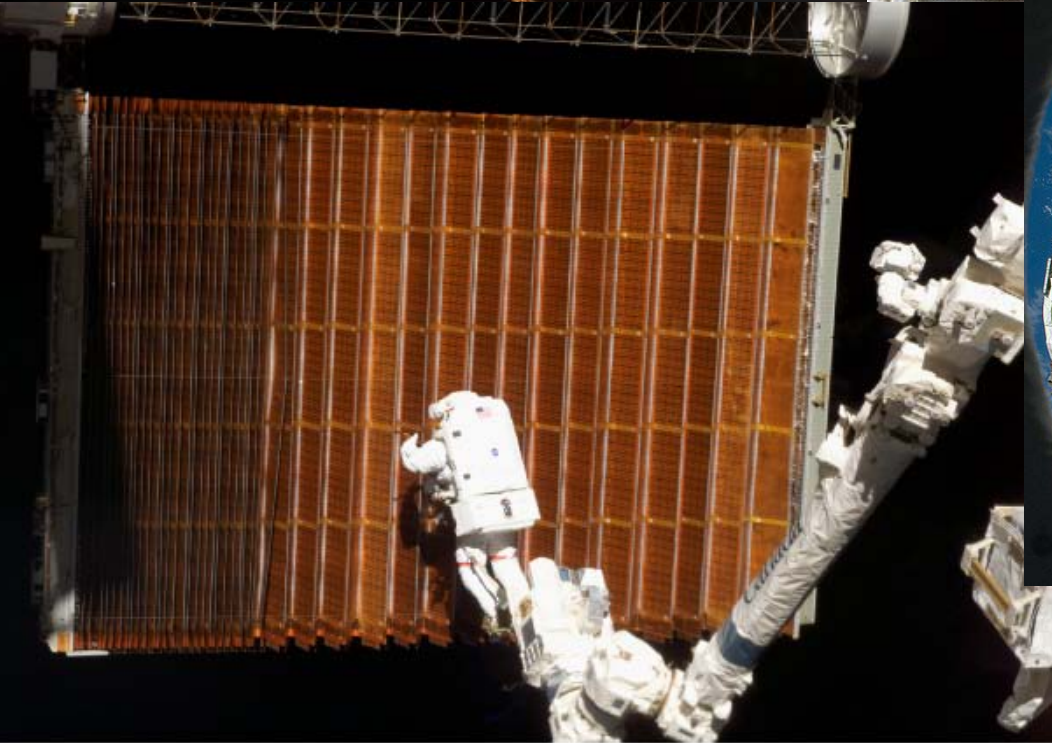
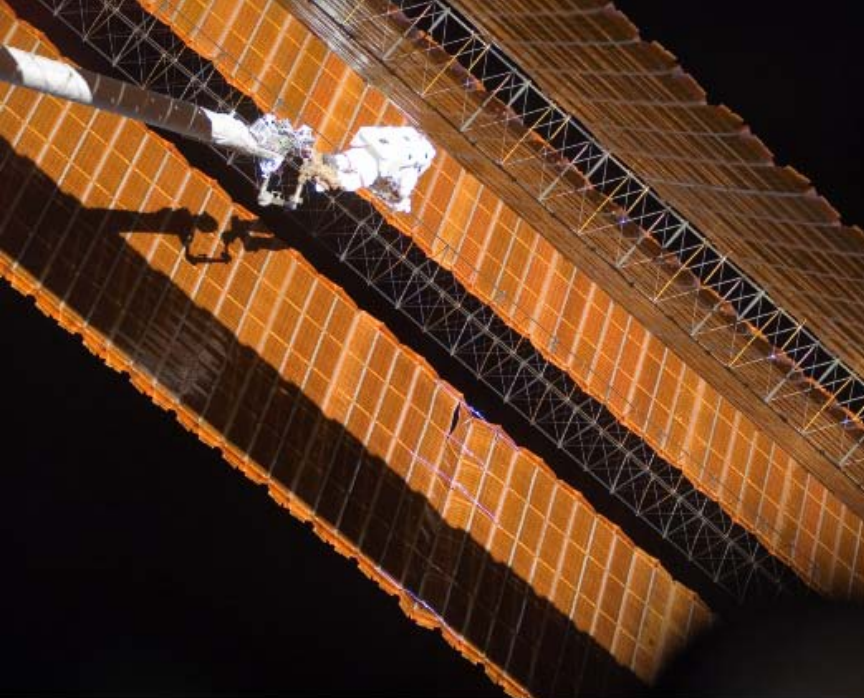

Photo credits: NASA



The “Negative” Plasma Hazard:

- Electrons preferentially attracted to exposed positive conductors, while ions not as mobile.
 - Cold dense plasma problem: not seen at GEO
 - “High side” circuit potential moves down, toward neutral
- Voltage regulation causes the return side (equipotential with hull) to move below neutral
- Oxide layers prevent ion neutralization of negative plane.
- Un-bonded crew then at one potential while ISS Structure moves to another
 - Surface dielectric breakdown can make a highly-localized, large discharge (ISS is 0.01 Farad capacitance)



Negative Plasma Solutions

- This is not just a crew problem: Discharge can break down dielectrics, create EMI, if too high
- Solved with plasma contactor unit (PCU) to make slow neutral plasma “bath” around ISS.
 - Essentially forces the collected electrons back into the environment in the form of charged particles.



And if the PCU fails?

- Redundant PCUs
- Point the active solar array surfaces to wake
 - Potentially significant power loss to ISS
- Monitor the plasma environment
 - If weak enough, can live with worst-case potential
 - Crew susceptible earlier than dielectrics: we live with some dielectric risk and generally only turn on PCUs during EVAs



ISS Plasma Contactor Unit (1 of 3)

Photo credit: NASA



How do we know what the environment is?

- The Plasma Interaction Model (PIM)
- FPMU on ISS
- The Floating Potential Measurement Unit (FPMU) was developed by Utah State University's Space Dynamics Laboratory (USU-SDL) to study surface charging of the International Space Station (ISS).
- The charging of the ISS is a function of ambient plasma density and temperature, the active state of PV solar array, as well as $V_{ISS} \times B$ induced potentials. A model of ISS surface charging, the Plasma Interaction Model (PIM), has traditionally used plasma densities and temperatures derived from the IRI model to predict the ISS charging levels. The IRI empirical model is an international project that provides users with global and temporal variations of electron density, electron temperature, ion temperature, ion composition (O^+ , H^+ , He^+ , NO^+ , O_2^+), ion drift, and Total Electron Content. However, the model only provides average climatologies of the ionosphere parameterized by solar activity, season and geomagnetic activity indices. Due to the nature of parameters the model is based upon the actual day-to-day variability of the ionosphere can approach up to 30% of the model provided averages. Thus, in situ instrumentation becomes important for high spatial and temporal resolution observations of local plasma parameters that will eventually be used to validate the ISS surface charging model PIM.

From: NASA Technical Report: "Data Analysis of the Floating Potential Measurement Unit aboard the International Space Station": Aroh Barjatya, Charles M. Swenson, Donald C. Thompson, Kenneth H. Wright, 2009



Photo credit: Utah State University Space Dynamics Laboratory

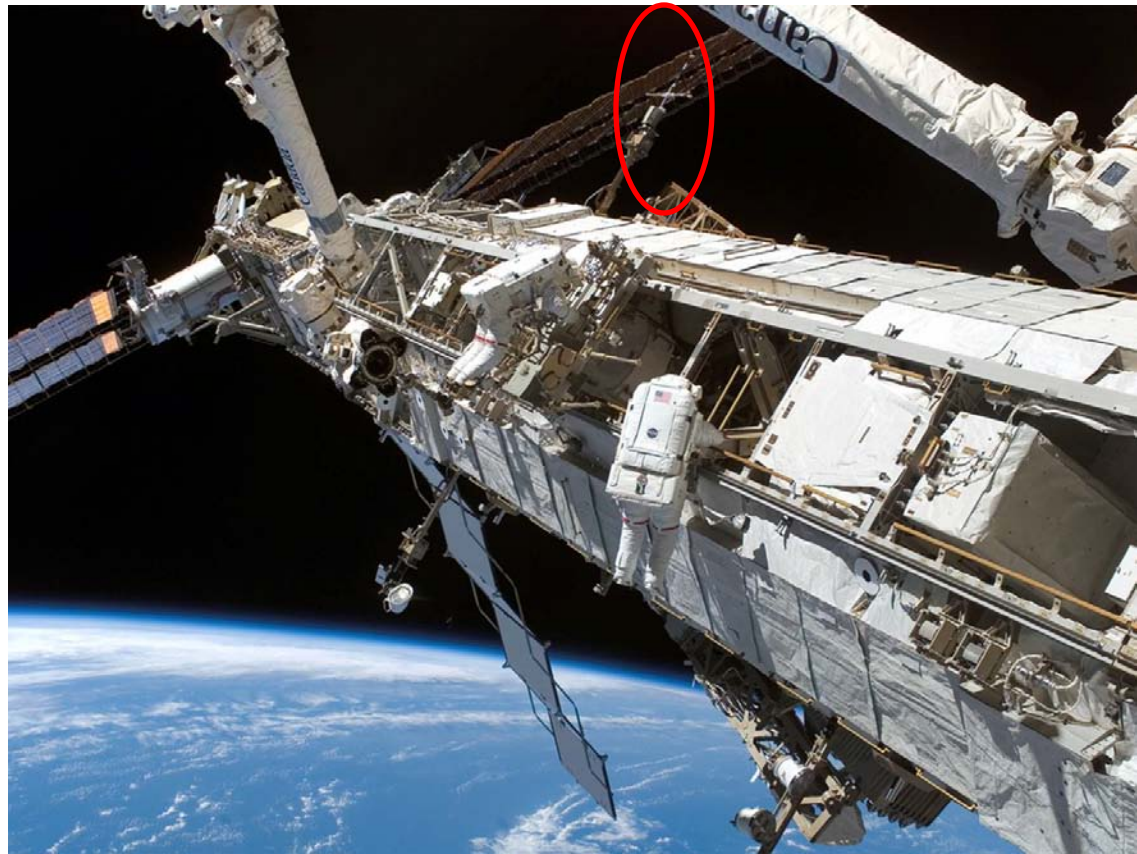

Photo credit: NASA



We worry about Positive, too

- This is a $V \times B \cdot L$ problem with a long metal boom perpendicular to B field lines, moving at high speed
- Amplifies in concentrated field near Earth's poles
 - Local potential at truss tip changes rapidly from the last time the crew made contact
 - Renewed ground contact makes a capacitive inrush:
 - an “AC” momentary shock hazard
 - Some conducting surfaces on suit can act like a collector, giving electrons a path through crewperson to local ground
 - A “DC” hazard.



Irony:

- Ironically, the positive hazard is exacerbated when the plasma contactor removes the negative hazard.
 - Tries to keep the ground plane from suppressing
 - pushes the end of truss over the top in positive potential hazard



Illustration

- ISS operates in electrically conductive plasma environment
- PCU's provide ISS ground to plasma
- As truss flies through the magnetic field a voltage is created along it
 - Combined with PCU's creates positive potentials on ISS conducting structure
 - High potentials only seen outboard of rotating truss joint
 - Plasma acts as a common ground

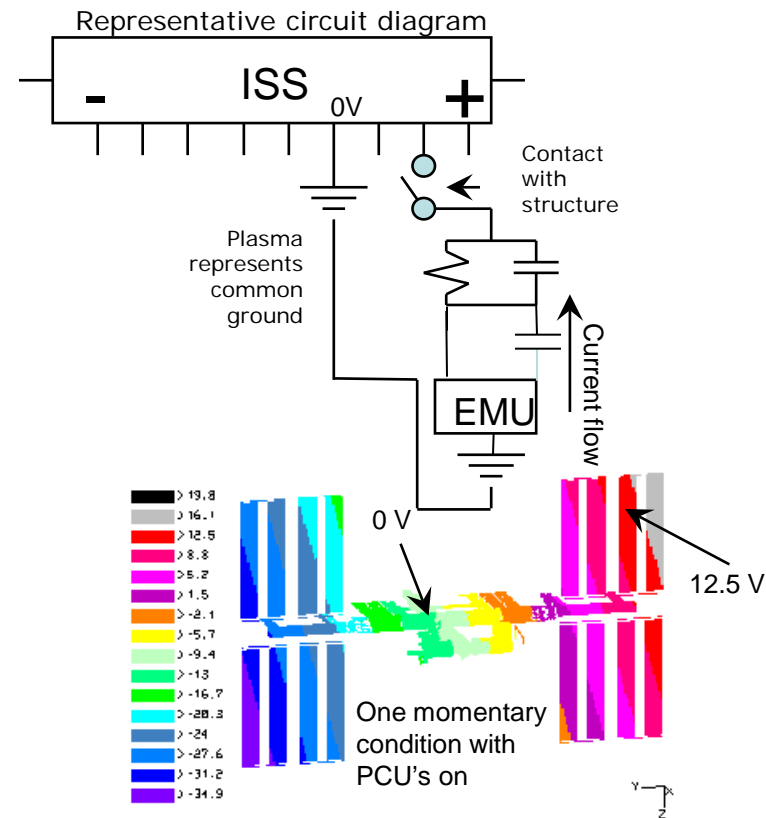
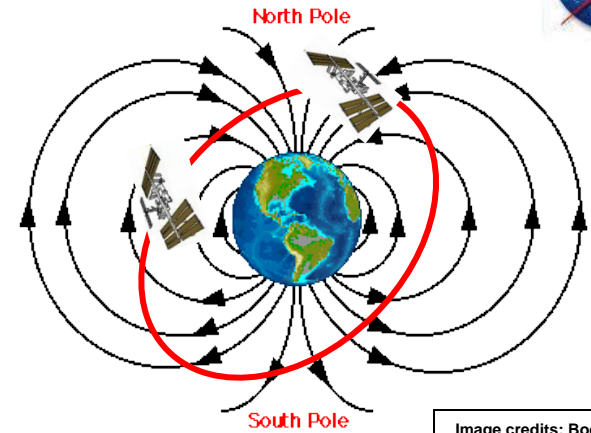



Positive Risk Mitigation

• The ISS Program has enacted all of the following:

1. Revisit probabilistic risk assessment

- **Result:** Crew severe Injury Risk is $1.94E-4$ per 5.5 hrs of EVA outboard of rotary joint in un-modified suit, **$1.54E-4$** with sensor cable modified as listed below, vs. $5.99E-5$ for a 6.5 hour EVA when not in positive plasma region of concern. Risk downgraded from catastrophic consequence to severe injury consequence.

2. Isolation of US Suit external conductive pathways

- **Result:** MMWS can be electrically isolated from the EMU and coated to prevent electrical contact
 - **Approved** at Program review 10/15/ 2009. Now available on-orbit
 - Isolates the most probable plasma charging/contact area
 - Other isolations not practical without major suit contract mods & recertification

3. Isolation of US Suit internal conductive pathways

- **Result:** Safety panel approved a temporary taping of the connections inside the US suit when needed for EVAs that include activity in the positive charge region.
 - Fixes the most probable conducting path to the crewperson & dramatically reduces the AC portion of the risk cause
 - Now available on-orbit . First implemented 2010
 - Other isolations not practical without major suit contract mods & recertification

4. Adjustment of plasma potential via ISS attitude

- **Result:** “sideways” attitude removes the $V \times B$ component . The +/-YVV-Znadir **stage attitudes are approved** within NASA & Boeing for overlapping ranges from zero to +/-55 deg Beta.(85% of all days)
- No critical ops in problem area have been identified requiring immediate high-beta EVA: at worst a nuisance of waiting for right conditions, operating in degraded conditions.

5. Refine study of neuro-physical pathways, impedances, and responses

- **Result:** Detailed model shows neuro-physical startle/strong-reflex/pain response (not death) is still possible
 - Corroborated with new International standards for shock exposure
 - Permanent injury is still credible



Risk Mitigation Continued



- Program has examined and rejected the following:
 1. Intentional grounding of US Suit to bypass crewperson in circuit
 - Result: May 2010 Program Control Board concurred with “no action” recommendation. Confirmed that such intentional grounding induces the AC portion of the hazard, and also introduces new tangling risks to the crewmember
 2. Adjustment of plasma potential via selective use of PCUs
 - Result: Not adopted. Explored during 2010 hazard discussion. Dependent upon plasma density at the time, which in theory could enable the removal of unnecessary PCU control. Removing PCU clamping when not necessary will drop outboard potentials to acceptable levels, but this solution is variable on a daily basis, gambles slightly the negative plasma hazard, and is not reliably available for planning an EVA.



Additional Mitigations

- Worked with partners to encapsulate arrays
- Developed Plasma Interaction Model (PIM)
- Launched Floating Potential Measurement Unit (FPMU)
- Built and launched Plasma Contactor Units (PCUs)
- Created real-time forecast method for Pre-EVA plasma effects
- Created array off-pointing logic for PCU failures



Conclusion

- **EVA activity in the ISS program encounters several dangerous ESD conditions**
- **The ISS program has been aggressive for many years to find ways to mitigate or to eliminate the associated risks**
- **Investments have included:**
 - Major mods to EVA tools, suit connectors & analytical tools
 - Floating Potential Measurement Unit
 - Plasma Contactor Units
 - Certification of new ISS flight attitudes
 - Teraflops of computation
 - Thousands of hours of work by scores of specialists
 - Monthly management attention at the highest program levels
- **The risks are now mitigated to a level that is orders of magnitude safer than prior operations.**



Backup: Space Station Electrical Bonding Requirements

Documented #SSP 30245:

3.2.1.1 CLASS H BONDING (SHOCK HAZARD)

Class H bonds shall be applied to electrical and electronic equipment, assembled elements or structure and between mated, docked or berthed spacecraft. ...A low resistance bond of less than 0.1 ohm to conducting structure at each termination and breakpoint. The bonding path may be through the equipment at which the conduit terminates.

3.2.1.2 CLASS R BONDING (HIGH FREQUENCY POTENTIALS, ANTENNAS)

A Class R bond shall be applied where electronic devices require a low noise, near equipotential environment, a minimum potential drop or where the bond is part of a safety mandated, high frequency (minimum delay time) function such as fault clearing in the presence of an Intervehicular Activity (IVA) or Extravehicular Activity (EVA).

3.2.1.2.2 NEARBY CONDUCTORS

All conducting items having any linear dimension of 30 centimeters (cm) or more installed within one-fourth of the wavelength of the highest operating frequency of wiring carrying signals with frequencies that exceed 10 MHz, such as transmitting or receiving antenna lead-ins, shall have a bond to structure at least every interval that is one-fourth the wavelength of the highest operating frequency. Direct metal-to-metal contact is preferred. If a jumper/strap is used, the jumper/strap shall comply with the requirements of Class R bonds.

3.2.1.2.3 SPACE STATION STRUCTURE

Space Station structure shall be so designed that the conducting members provide a uniform low impedance path through inherent bonding during construction. Structure bond design shall include accommodation of the effects of operational vibration and resultant breakdown of insulating finishes or intermittent electrical contact.

3.2.1.3 CLASS S BONDING (STATIC CHARGE)

3.2.1.3.1 CONDUCTING STRUCTURAL ITEMS

All isolated structural conducting items having an area greater than 100 square centimeters which carry fluids in motion, or otherwise are subject to frictional charging or plasma-induced current flow or charging, shall have a mechanically secure conducting connection to conductive structure. The resistance of the connection shall be less than 1 ohm...