



Degradation of Multi-Layer Insulation (MLI) Retrieved from the Hubble Space Telescope



2011 Contamination, Coatings, &
Materials Workshop

Jelila S. Mohammed
Materials Engineering Branch
NASA Goddard Space Flight Center

Kim K. de Groh
Space Environment & Experiments Branch
NASA Glenn Research Center



Presentation Agenda

- HST Insulation Overview
- HST Environment
- SM4 Material Retrieved for Analysis
- Materials Characterization and Test results
- Summary
- Acknowledgements



Insulation on HST

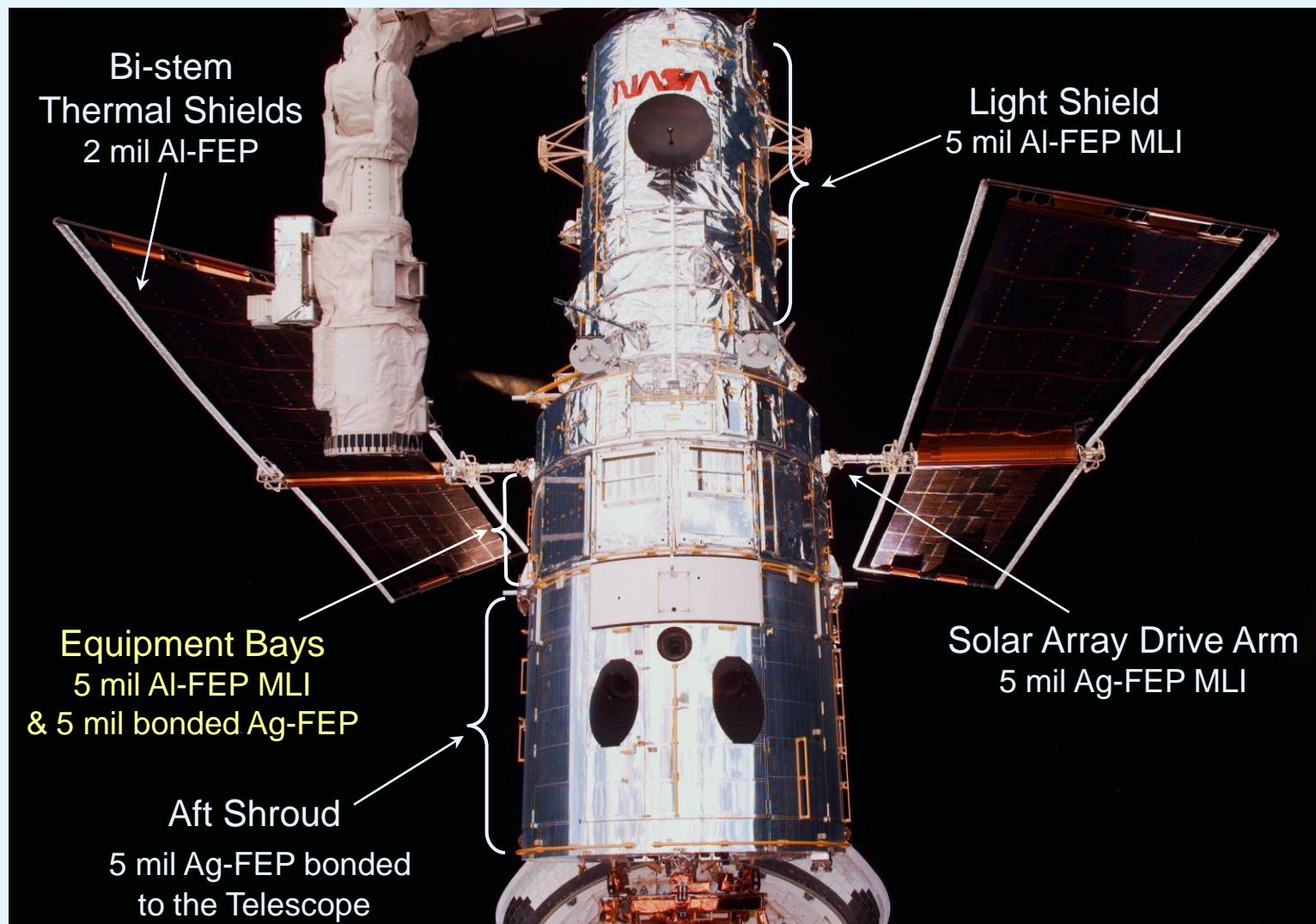

**Current analysis: 5-mil thick aluminized-Teflon® fluorinated ethylene propylene (Al-FEP)
Top layer of MLI from equipment bays 5 and 8**

HST On-orbit Orientation

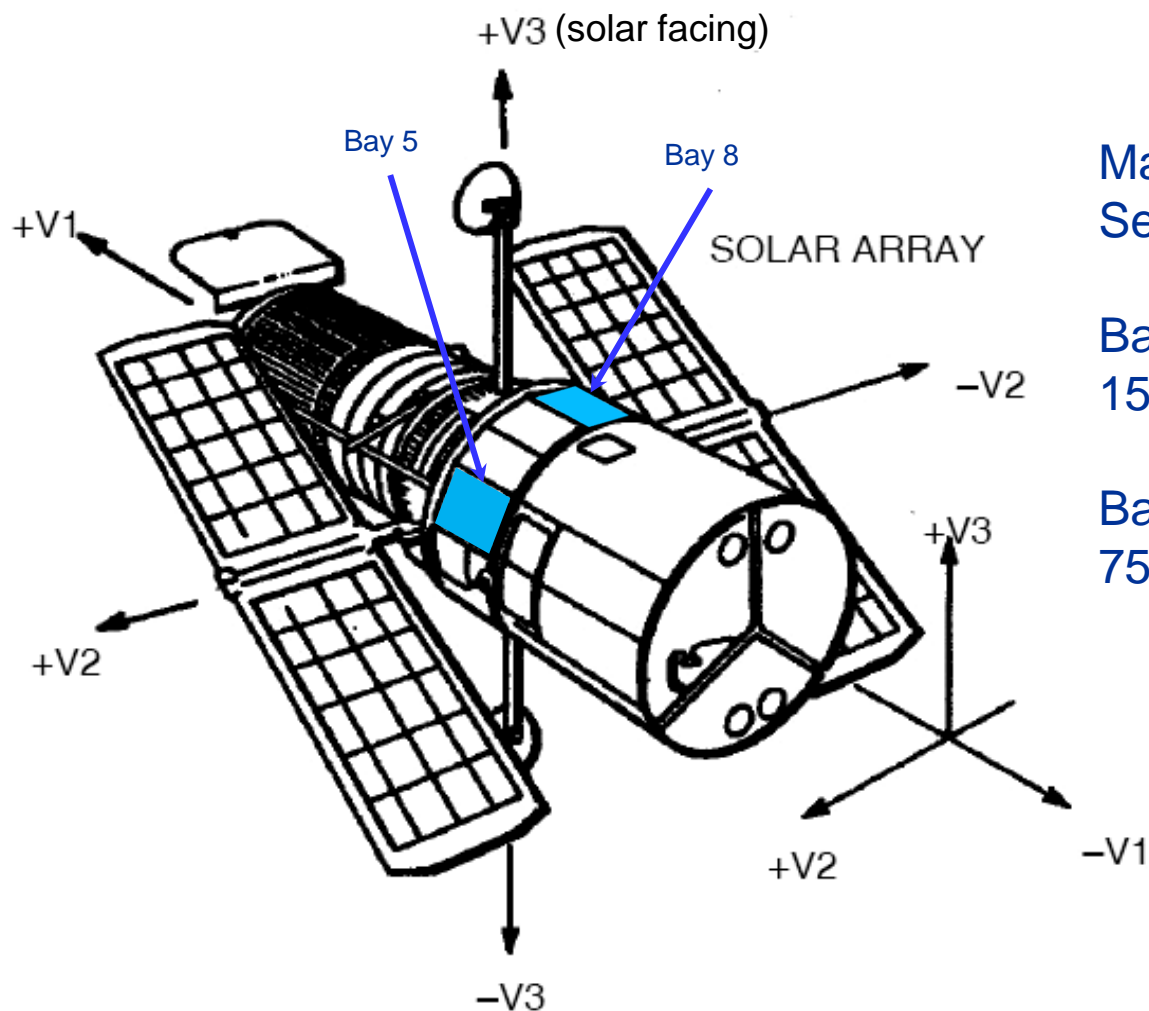

Material returned from Servicing Mission 4:

Bay 8 MLI – sun facing
15° from the +V3 direction

Bay 5 MLI – grazing sunlight
75° from the +V3 direction

Space Environment

Threats to Al-FEP Insulation

- Sun's radiation (ultraviolet (UV), x-rays)
- "Solar wind" particle radiation (electrons, protons)
- Thermal cycling (hot & cold cycles)
- Micrometeoroids & debris impacts (space particles)
- Atomic oxygen (single oxygen atom)



On-orbit insulation degradation and embrittlement

Previous analyses of returned HST Al-FEP from SM1 to SM3B indicate that material properties degrade due to combined effects of radiation and thermal cycling.



SM4 Environmental Exposure

- Time on-orbit: 19 years, 3.4 weeks
 - Deploy date: April 25, 1990
 - SM4 MLI retrieval: May 18, 2009
- Thermal cycles and temperature ranges: 110,000 cycles overall
 - Bay 5: -175°C to 0°C
 - Bay 8: -175°C to 40°C
- Equivalent Sun Hours (ESH): 111,000 overall
 - Bay 5: 24,300 ESH
 - Bay 8: 89,300 ESH
- Atomic Oxygen fluence:
 - 2010 LS MLI: $<1.1 \text{ E}21 \text{ atoms/cm}^2$

Bay 5 MLI (Solar “Grazing”, +V2)

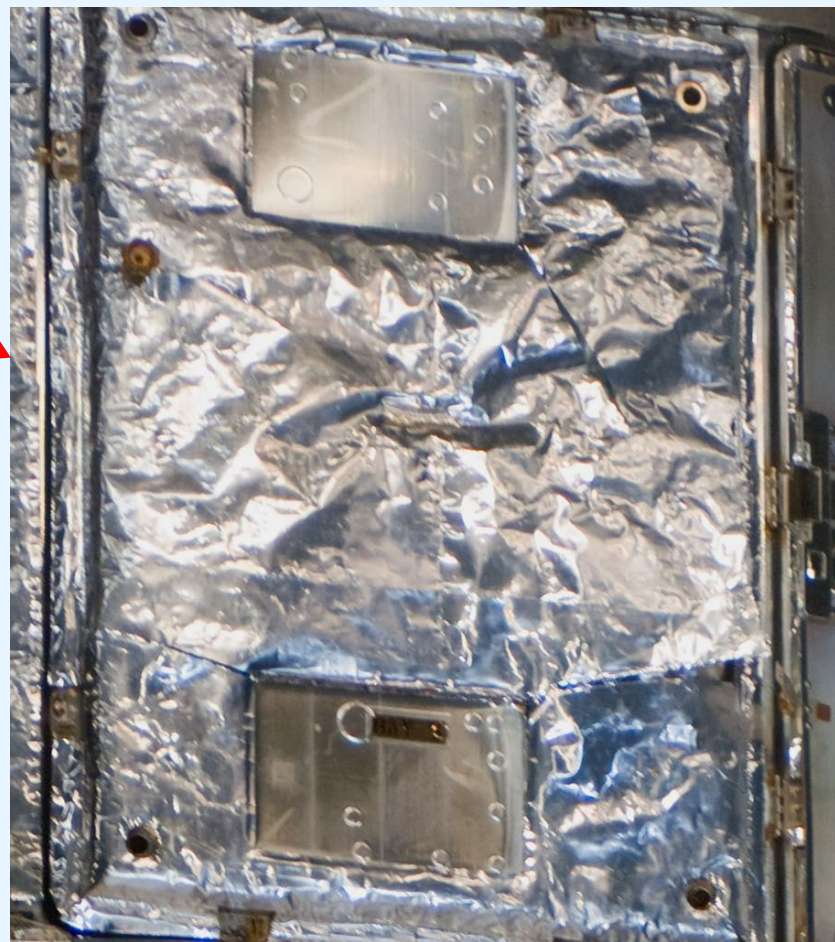

Bay 8 MLI & Patches (Solar Facing, +V3)



Severely damaged areas were patched with single layer Al-FEP during SM2 (1997). These became damaged as well, but some areas remained patched until SM4 (2009).

Insulation Test Samples

Bay 8 MLI in the lab for sectioning

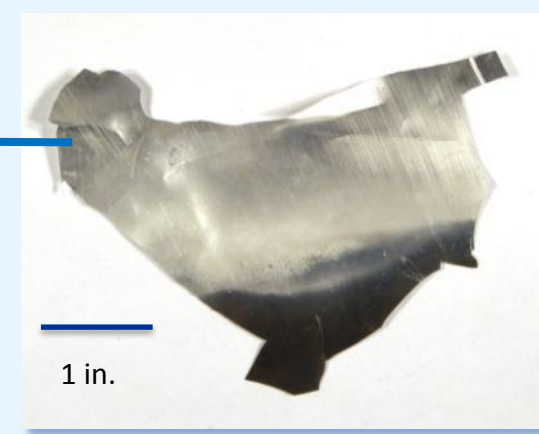
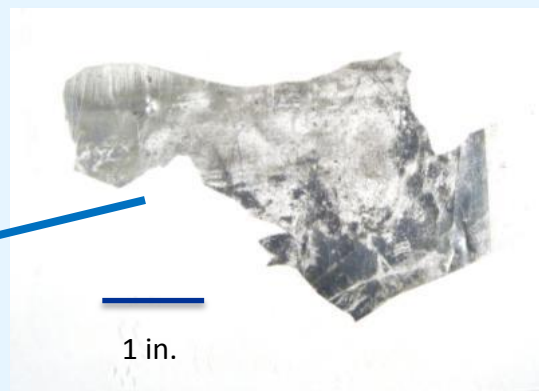
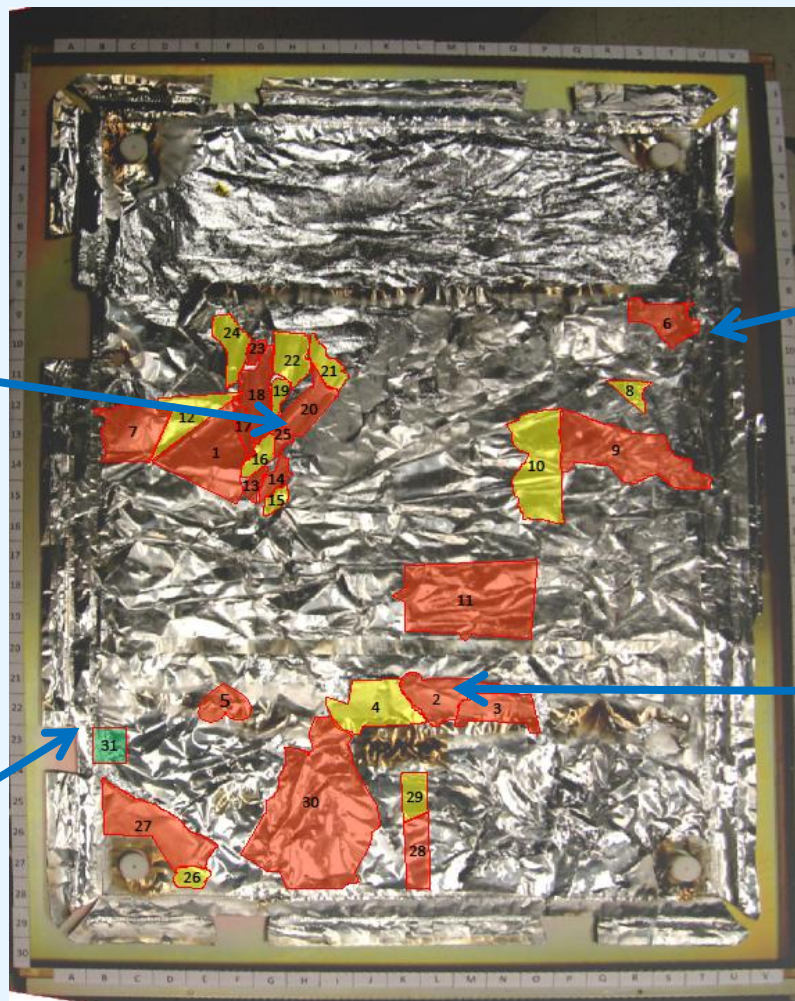
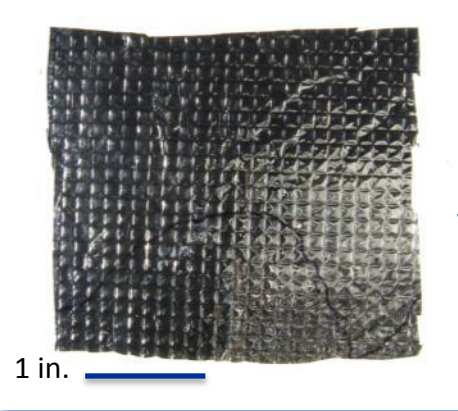

The blankets had received a wide range of environmental exposure levels on orbit, based on alignment with the sun and whether or not the material was patched.

Analysis Techniques

Regions were tested for various materials properties, and these were compared to pristine Al-FEP material to assess the extent of degradation after over 19 years on-orbit.

- Optical/Thermal Properties
 - Solar Absorptance
 - Thermal Emittance
- DSC
 - Enthalpy of Melting
 - Melting Temperature
- XPS - Surface Chemistry
- SEM Analysis
 - Thickness
 - Crack Morphology

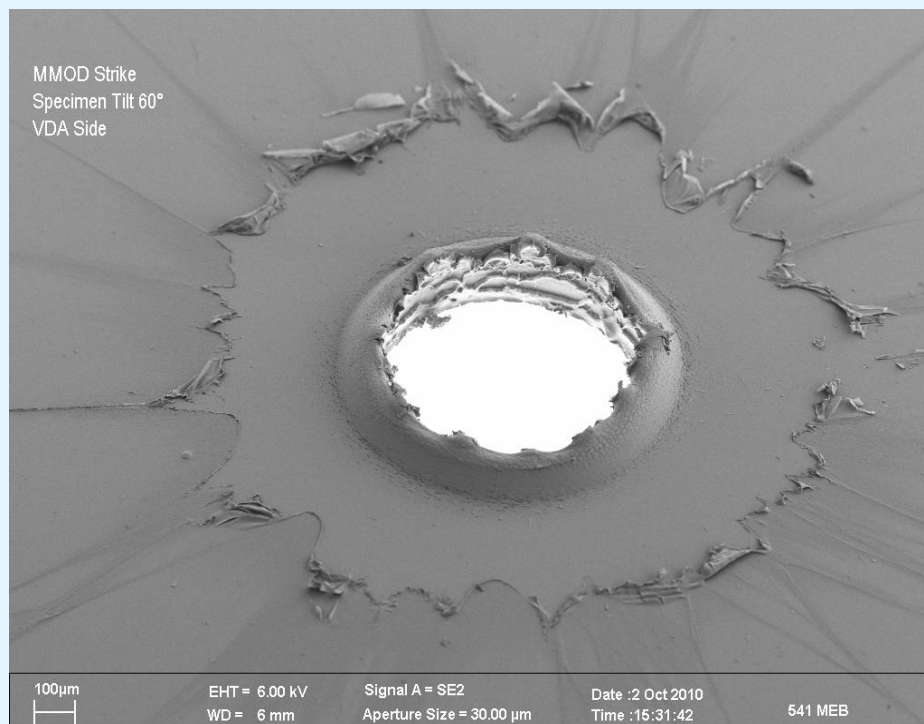

Mechanical properties, density, and mass loss were also evaluated and analyzed.

Optical and Thermal Properties

Bay 8, Shiny +V3

(Sample 12B Region 1)

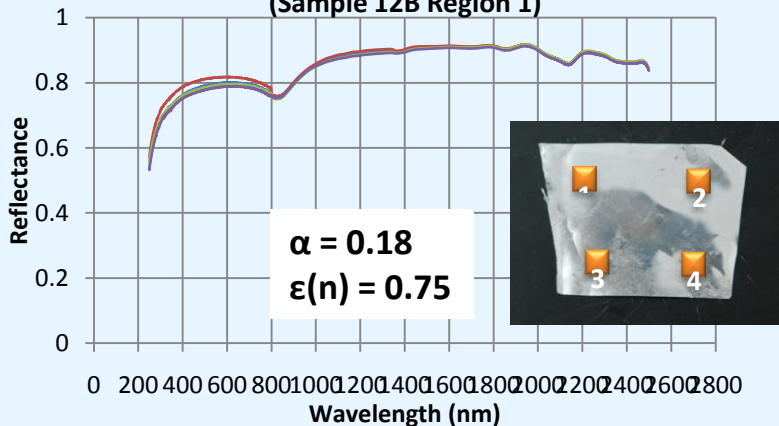

Bay 8, White hazy +V3

(Sample 4B Region 2)

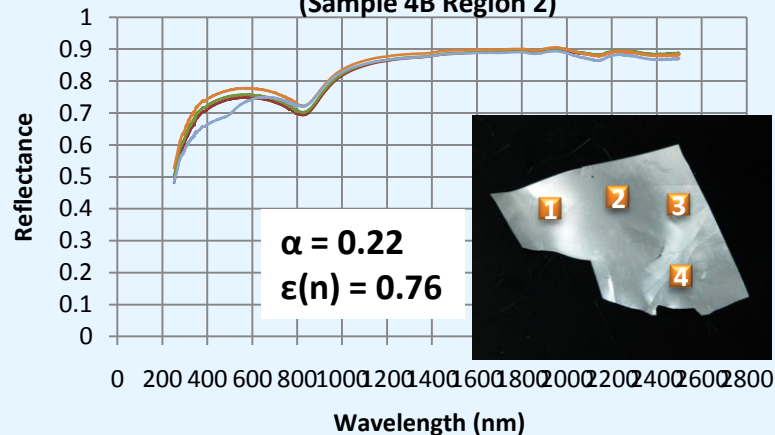

Bay 5, Shiny +V2

(Sample 7C Region 1)

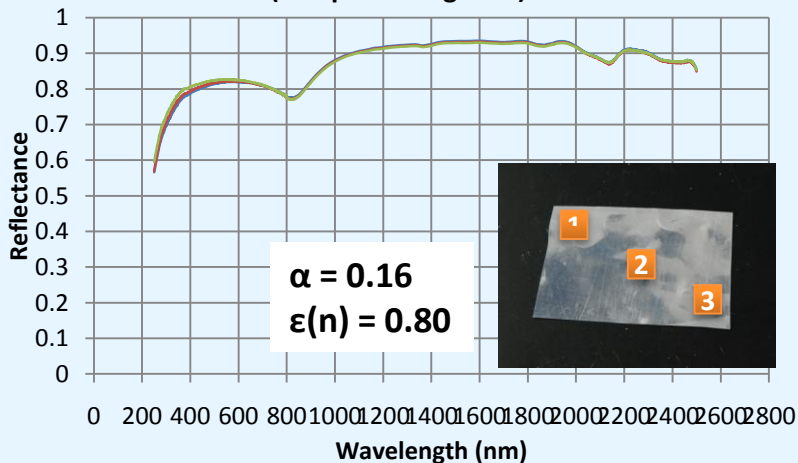

Pristine

(Sample 50B Region 20)

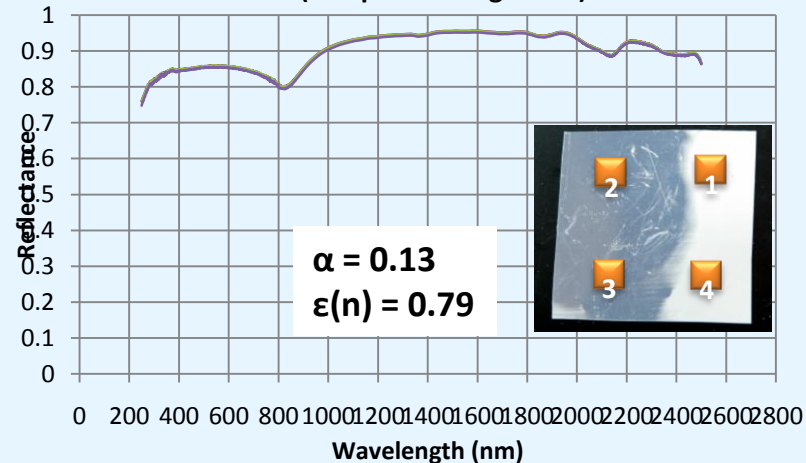

Reflectance Graphs showing thermal property calculations



Optical and thermal properties (2)

Bay #	Region	Description	Solar Absorptance α	% change from Pristine	Normal emittance $\epsilon(n)$	% change from Pristine
8	1	Shiny+V3	0.18	41.35	0.75	-5.52
8	2	white hazy +V3	0.22	66.67	0.76	-4.10
8	3	Al delaminated FEP +V3	0.13	0.00	0.74	-6.62
8	7	Tight curl	0.19	43.59	0.75	-5.36
8	8	Loose curl	0.23	76.92	0.73	-8.10
8	11	MLI Area patched during SM2 - stayed covered	0.26	102.20	0.79	-0.32
8	13	MLI patched during SM2, then exposed at SM3B	0.27	110.26	0.77	-2.84
5	1	Shiny +V2	0.16	23.08	0.80	1.37
Pristine	Pristine	Pristine	0.13	0.00	0.79	0.00

High solar absorptance (α) of curl indicates that it got hotter on orbit, consistent with previous analysis of curled MLI. The aluminized side was facing outward, causing the curled MLI to reach a higher temperature on-orbit than the nominal facing MLI.

High solar absorptance (α) of patched material may be due to contamination from patch material, and may not indicate higher on-orbit temp.



Differential Scanning Calorimetry (DSC)

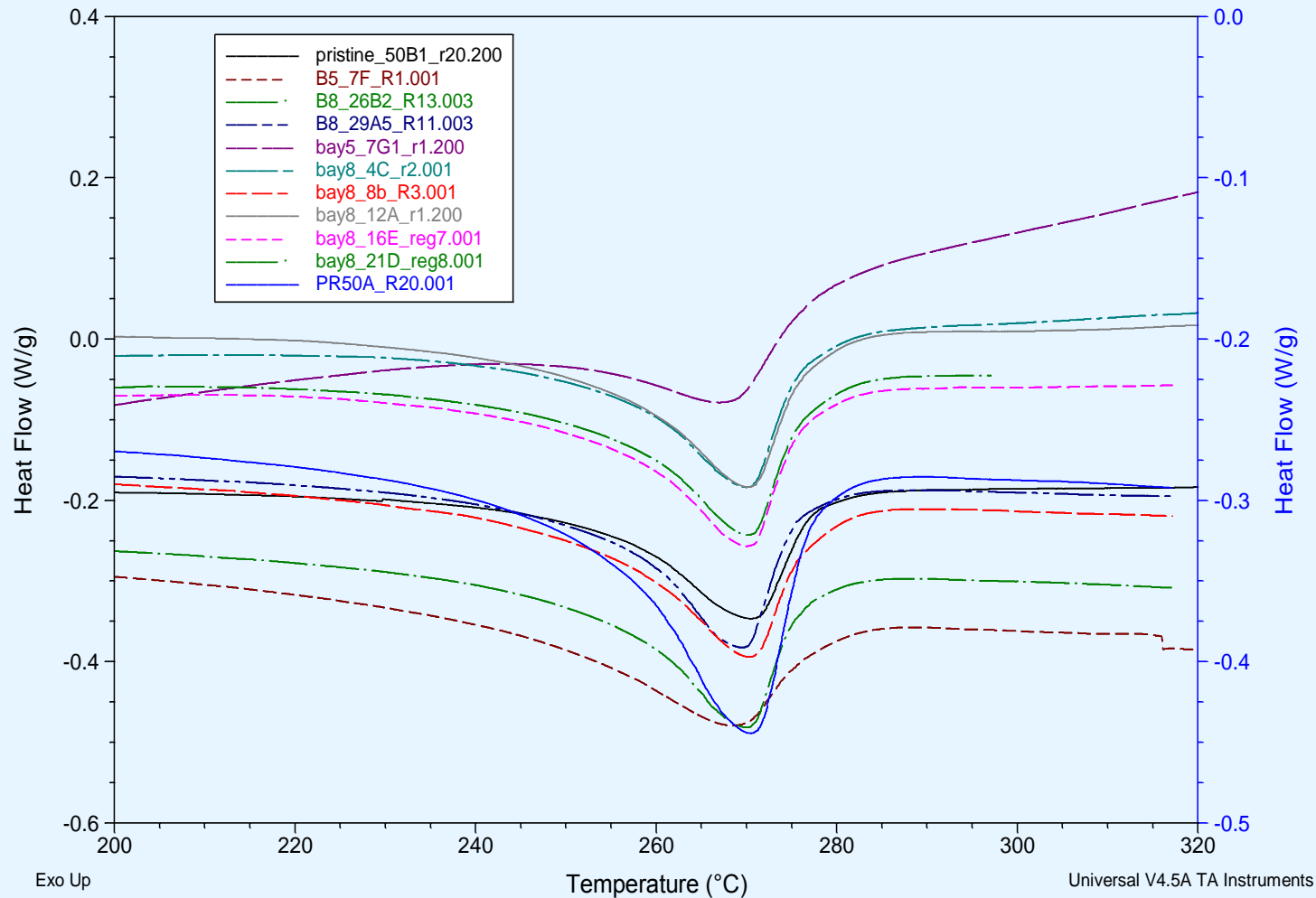



Differential Scanning Calorimetry (DSC)

Bay #	Abbreviation	Description	ΔH_m , cal/g	Melt T, °C
8	B8 MOL N S	Shiny+V3	6.24	251.36
	B8 MOL NH (hazy)	white hazy +V3	6.12	252.62
	B8 MOL N D	Al delaminated FEP +V3	6.41	251.82
	B8 MOL TC	Tight curl	8.13	253.07
	B8 MOL LC	Loose curl	6.45	253.24
	B8 MOL P	MLI Area patched during SM2 - stayed covered - mostly under velcro	5.62	254.42
	B8 MOL P SM3B	MLI patched and exposed at SM3B	5.88	254.60
5	B5 MOL N S	Shiny +V2	5.50	243.06
			5.57	244.28
Pristine	Pristine	5-mil Al FEP	2.75	272.59
			2.60	271.23

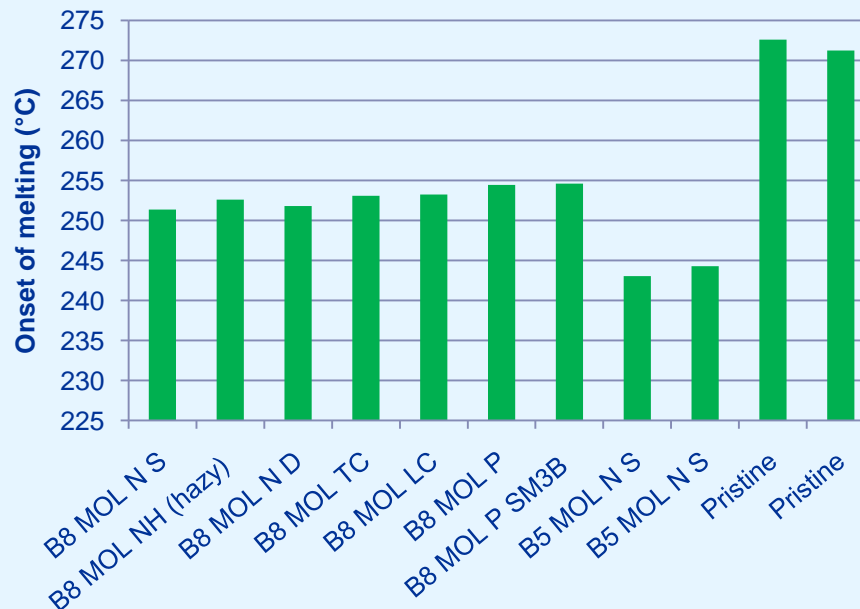
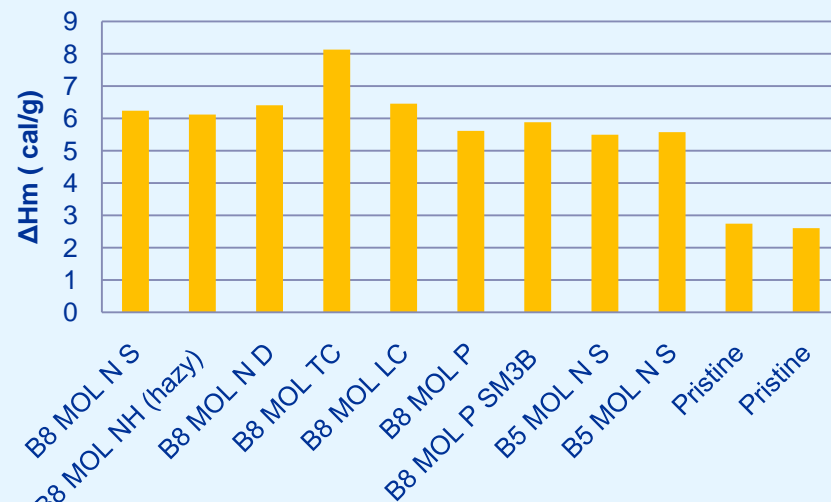

- Enthalpy of melting correlates with crystallinity**

- Bay 8 has increased crystallinity over Bay 5.
- Exposed aluminum due to the curl resulted in increased temperatures on orbit for that material that was curled – higher crystallinity.

- Reduction in melting temperature indicates shortened polymer chains due to radiation effects.**

- Bay 5 may exhibit more chain scission than Bay 8 (due to radiation).



Surface Chemistry (XPS)

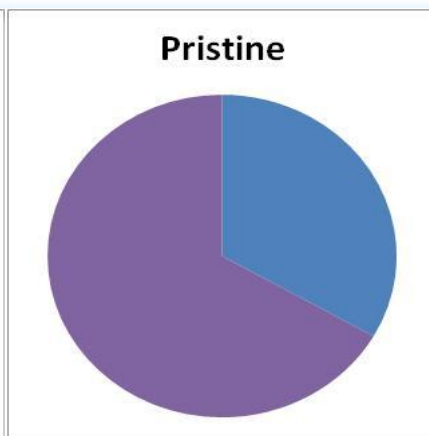
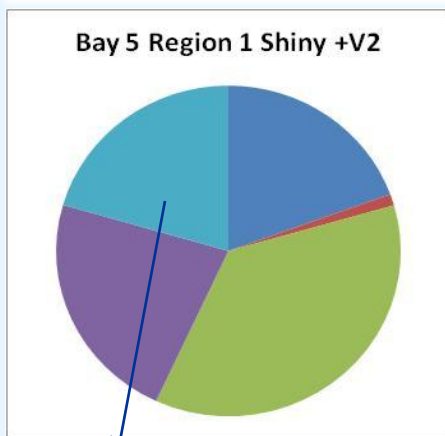
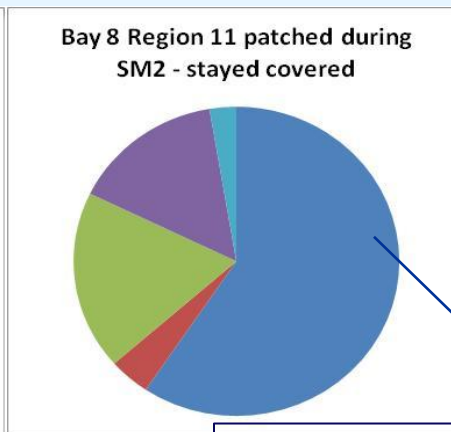
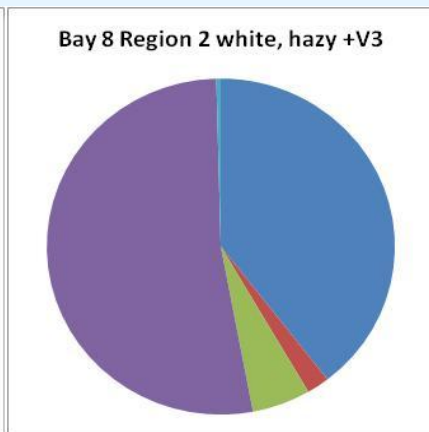
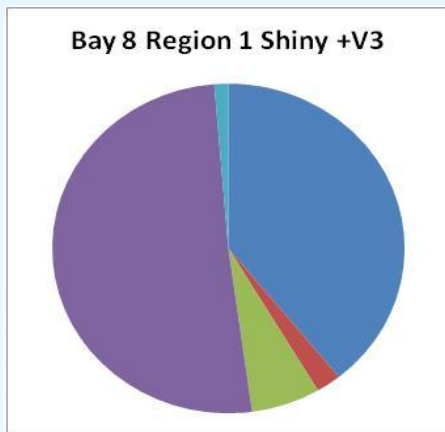

High C concentration may indicate contamination from patch velcro, in agreement with the large degradation in optical properties observed for the patched Bay 8 MLI.

High Si may be due to contamination from astronaut gloves.

Bay #	Description	C	N	O	F	Si	F/C Ratio
8	Shiny+V3	39.19	2.31	6.35	50.87	1.29	1.30
8	white hazy +V3	39.50	2.12	5.43	52.55	0.41	1.33
8	MLI Area patched during SM2 - stayed covered	59.41	4.10	18.70	15.14	2.65	0.25
5	Shiny +V2	19.44	1.12	36.36	22.56	20.52	1.16
Pristine	Pristine	33.27	0.00	0.00	66.73	0.00	2.01

Lower F/C ratio indicates damage to the MLI

When Teflon is subjected to radiation damage and the polymer chains are broken, F is expelled from the chain



SEM Thickness

Measurements were taken by micro-sectioning epoxy mounted samples.

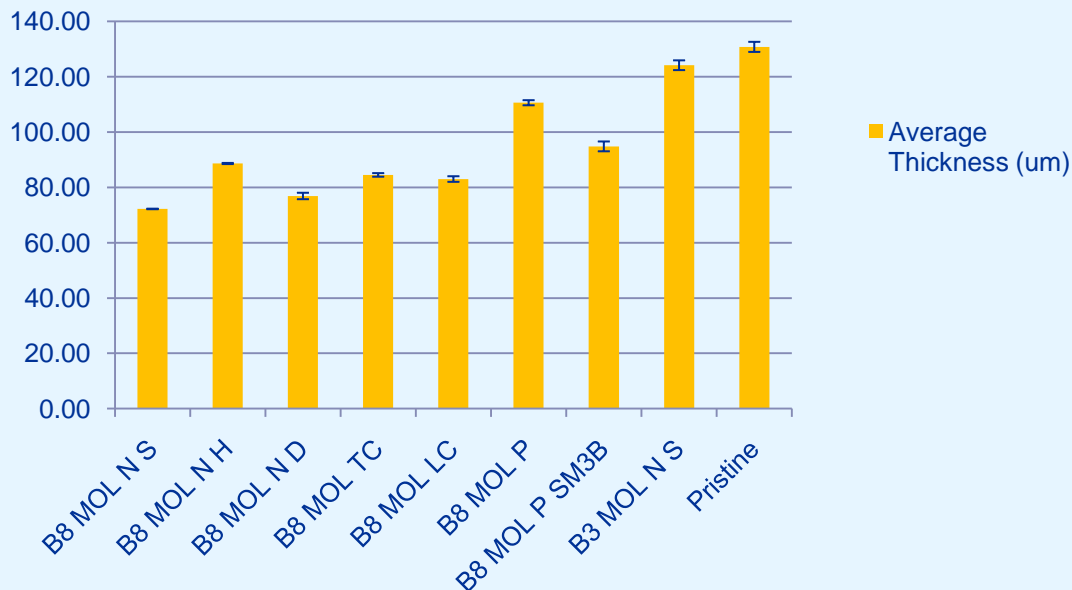

Bay	Abbreviation	Description	Average Thickness (um)
8	B8 MOL N S	Shiny+V3	72.19
	B8 MOL N H	White hazy +V3	88.61
	B8 MOL N D	Al delaminated FEP +V3	76.87
	B8 MOL TC	Tight curl	84.49
	B8 MOL LC	Loose curl	83.00
	B8 MOL P	MLI Area patched during SM2 - stayed covered - mostly under velcro	110.58
	B8 MOL P SM3B	MLI patched and exposed at SM3B	94.80
5	B5 MOL N S	Shiny +V2	124.13
Pristine	Pristine	5-mil Al FEP	130.77

Teflon on Bay 8 was overall more eroded than on Bay 5.

Patches protected underlying material from erosion.

SEM Crack Analysis

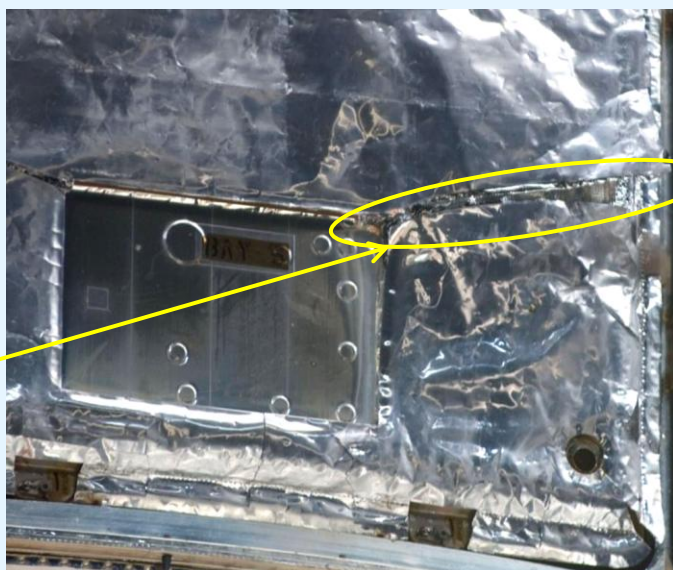
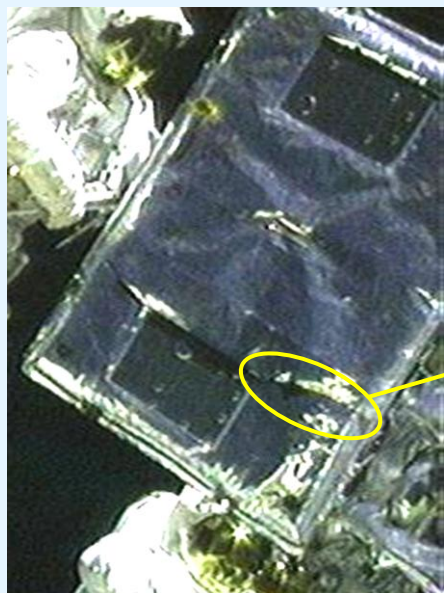

Images of Bay 5 on-orbit crack taken during SM2 (1997) and SM4 (2009)

- Smoother crack features are consistent with slow crack growth mechanism.
- Fibril features are associated with ductile tearing.
- This morphology is not consistent with on-orbit crack analyses from MLI returned during SM2(only showed a smooth, flat crack surface).
- The crack surface may have been altered by the effects of the space environment on the exposed polymer surface.

SEM images of on-orbit crack edge

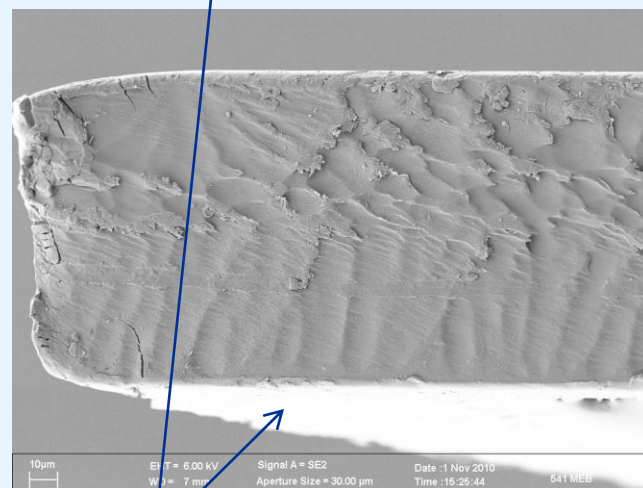
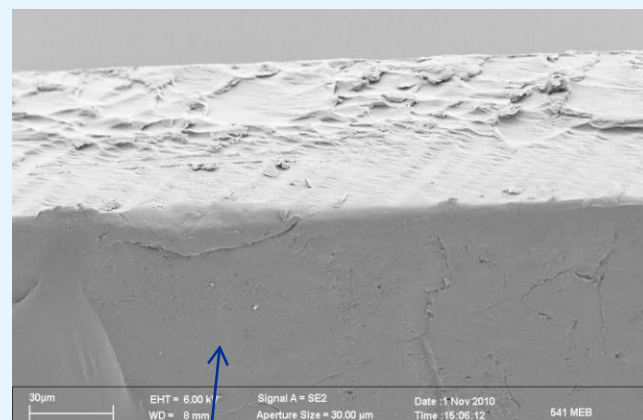

Aluminized side

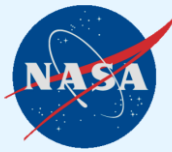

Summary

- Bay 5 & 8 MLI insulation returned at SM4 are still being analyzed.
- Analysis has revealed degradation of optical, thermal, and mechanical properties, increased crystallinity, and reduction in fluorine/carbon ratio of FEP.
- These material properties can be affected by high temperatures on orbit, increased radiation exposure, and in some cases contamination from materials in close proximity to the insulation on orbit.
- Preliminary results support conclusions of previous studies: areas of Al-FEP that received higher levels of solar exposure show more degradation (high temperatures and radiation combined).



Acknowledgements

- Aparna Boddapati
- David Hughes
- Mark McClendon
- Kristin McKittrick
- Alex Montoya
- Mollie Powell
- Ben Reed
- Matthew Shacka
- Debbie Thomas
- Michael Viens