

Low Cost Space Demonstration for a Single-Person Spacecraft



Brand Griffin

Gray Research/NASA, MSFC Engineering, Science, and Technical Services Contract

Charlie Dischinger

NASA, MSFC

41st ICES, 17–21 July 2011, Portland, Oregon

JACOBS





What is a Single-Person Spacecraft?

1954



Bottle Suit

1968

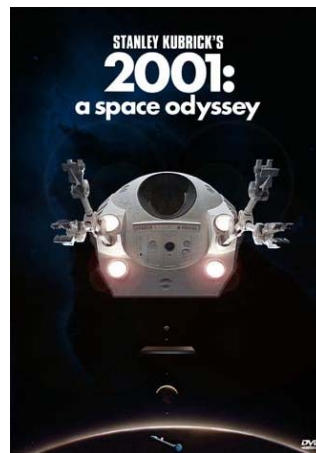

Pod

1985



MAWS

2003

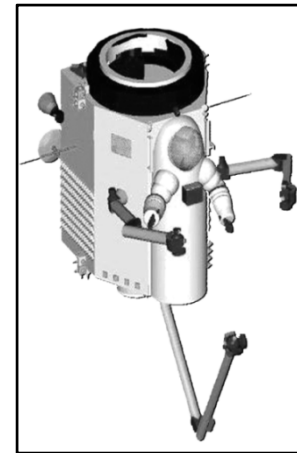

SCOUT

2010

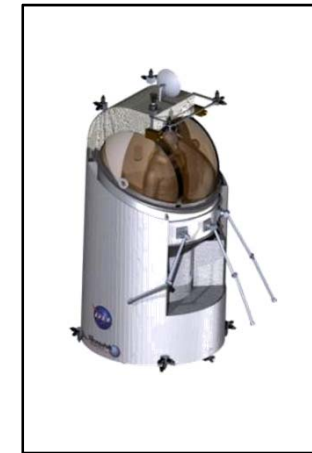

FlexCraft
(née MAWS)

Baseline: FlexCraft (Multiple Venues with Human and Robotic Operations)

Key attributes of baseline concept:

- Operates with a host spacecraft
- Cabin atmosphere is the same as the host
- Includes a propulsion system
- Uses manipulators

Idea is not new and there are many configurations



FlexCraft Configuration

Multiple Venues with Human and Robotic Operations

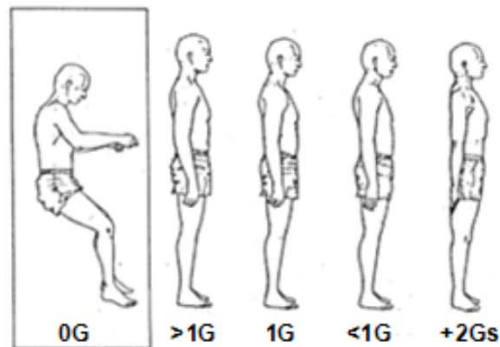

Zero-g Anthropometry for FlexCraft

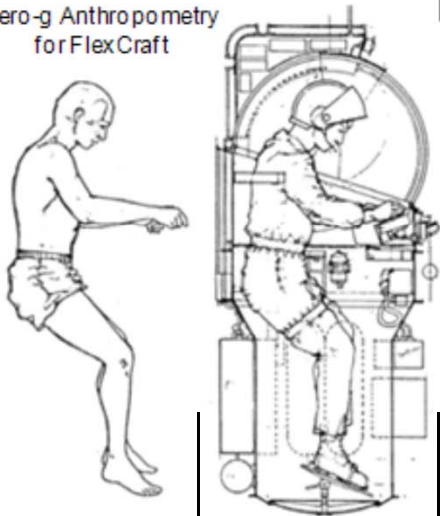

1.28 m (50 in.)
ISS Hatch Opening



Venues



Operations

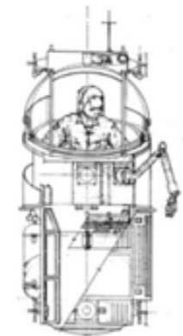

Human or Robotic

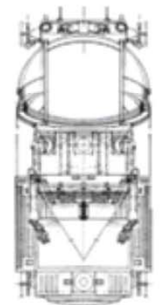



Mission and Launch Vehicle

Bare bones Demonstrator

REMOVED/SIMPLIFIED

1. Simplified Canopy Closure
2. Demonstrator Manipulators
3. No Displays and Controls
4. No ECLSS
5. Heaters, but no active thermal control
6. No experiment/sample bin
7. No internal outfitting
8. No Hatch
9. No docking mechanism

ADDED

1. Test instrumentation
2. Test Communications

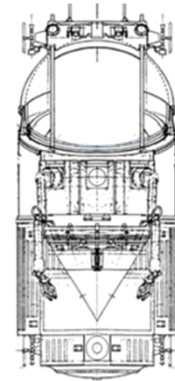

Two Launch Vehicle Options

Within mass and cg limits

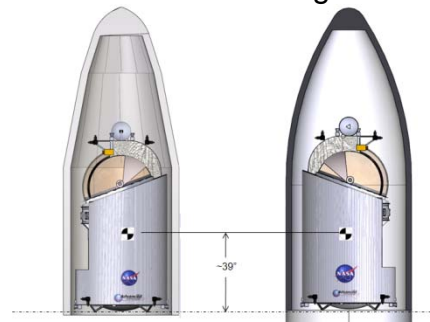

Minotaur 1

Falcon 1e

Significant Margin to 350 km

Vehicle	Falcon 1e	Minotaur 1 w/ 61" fairing
Data source	Guide	Guide
Launch Site	RTS	CCAFS*
Inclination	9.1	28.5
Notes:	1,3,4	1,2
Circular Orbit Alt (km)	Payload to orbit (kg)	
200	1005	577
250	970	565
300	975	553
350	955	541
400	940	527
Max longitudinal CG offset for 500kg payload (m)	1[8]	1.0 [7]

Short Mission (Reduced Cost)

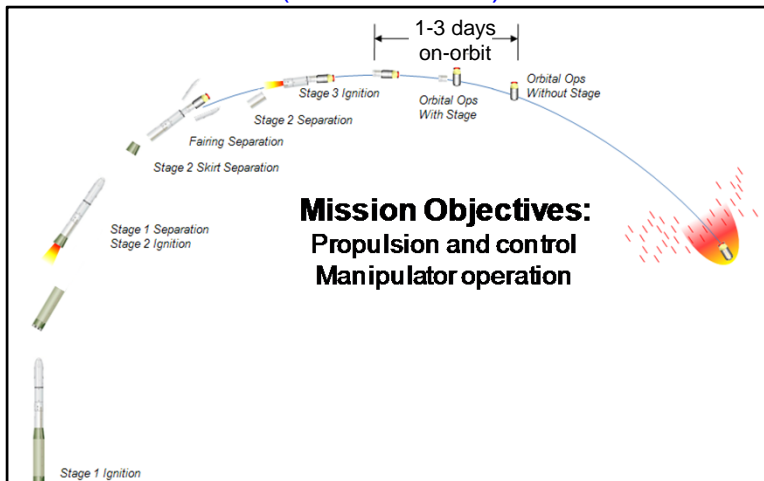

Upper Stage Target ISS, NEO and Satellite tasks

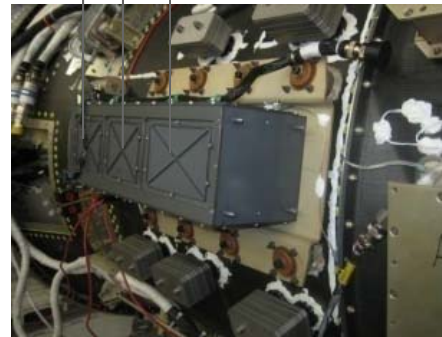

Safe Re-entry
 Falcon 1e 30 days
 Minotaur 1 20 days

DAS estimate for frontal area		
	Area (m ²)	Area/Mass
Fixed	3.04	0.00869
Grav grad	3.03	0.00866
Tumbling	2.83	0.00809
Addnl area protrusions (m ²)		0.1
Area/Mass for analysis		0.00897



Configuration



Pressure Vessel



Secondary Structure

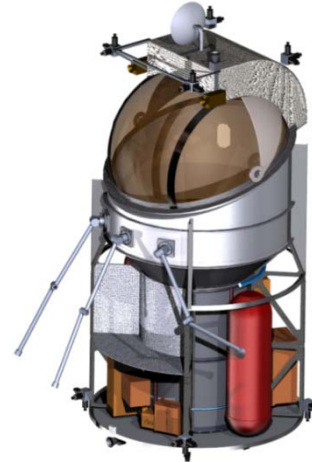

Subsystem Packaging



MMOD Shield

Mature Technologies

System	Demonstrator TRL								
	1	2	3	4	5	6	7	8	9
Structures	█	█	█	█	█	█	█	█	█
Electrical	█	█	█	█	█	█	█	█	█
Thermal	█	█	█	█	█	█	█	█	█
Propulsion	█	█	█	█	█	█	█	█	█
GN&C	█	█	█	█	█	█	█	█	█
Comm	█	█	█	█	█	█	█	█	█
Robotics	█	█	█	█	█	█	█	█	█

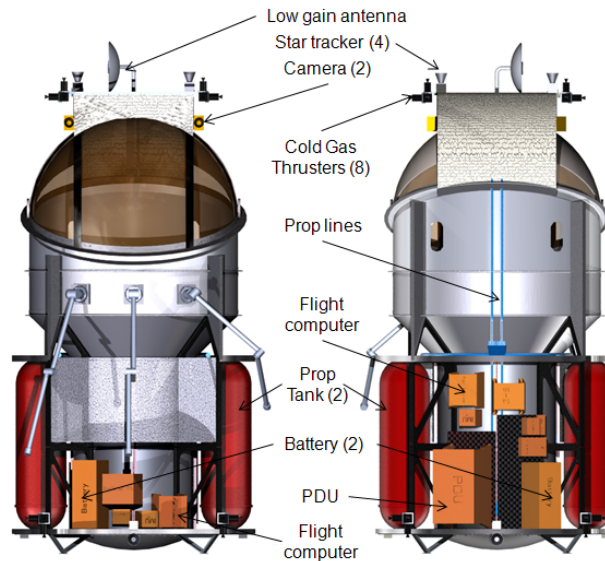

AIAA Standards for MGA

FlexCraft	Predicted Mass (kg) inc MGA
1.0 Structures	123.86
2.0 Propulsion	52.20
3.0 Power	46.78
4.0 Avionics	53.13
5.0 Thermal	23.38
6.0 Separation Ring	8.87
Dry Mass	309.26
7.0 Non-Prop Fluids	1.22
8.0 Cargo/Payload	65.49
Inert Mass	59.22
Total Less Propellant	368.48
9.0 Propellant	14.25
Total Gross Mass	382.73



Mockups

Sizing Mockup

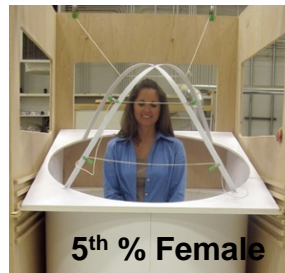
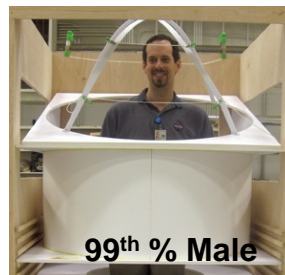
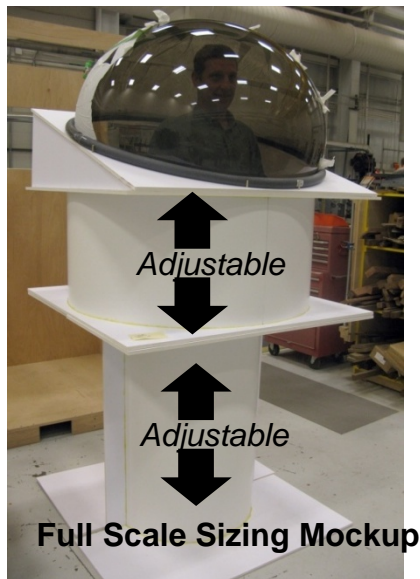

Pressure Vessel Enclosure



MMU and FlexCraft





Systems are Available to Support Launch in 3 yrs.

“Design to Availability”

Subsystem	Options	Source	Availability?
Attitude Control System	Sun Sensor (and electronics)	Sinclair Intr, SS-411 MSS	1 Available now (2 weeks), otherwise 4-6 months lead time.
	Star Tracker WFOV	AeroAstro Mini tracker	Waiting for a response
	Star Tracker	Sinclair Intr	2011
	IMU Assy	Northrop LN200	Waiting for a response
Thermal System	Same as MMU – Some located in SRC	NASA/Space Rocket Center	Now.
	Heaters - Heater tape and wire, Kapton covered	Clayborn Labs	Couple of weeks
	Thermostats	TBD	Assumed a couple of weeks
	Temperature Sensors - RTDs layered in adhesive backed Kapton sheet	Minco/Rockwell	Waiting for a response
Propulsion System - Thrusters	Same Thrusters as MMU - Triad Thrusters	Vacco Space Products	10-12 months
	Cold Gas Thruster (Larger Thrust)	MOOG	~11 months
	Cold Gas Thruster (Smaller Thrust)	MOOG	~11 months
	Cold Gas Thruster Triad	MOOG	~11 months
Propulsion System - Plumbing	Made in House	NASA	Need Manufacturer Estimation.
Propulsion System - Tanks	Shorter Tanks (OAL: 64.3 - 88.9cm)	Structural Composite Industries (A company of Worthinton Cylinders)	2-12 weeks. Depending if model selected is popular.
	Longer Tanks (OAL: ~187.2cm)	Structural Composite Industries (A company of Worthinton Cylinders)	2-12 weeks. Depending if model selected is popular.
	Same as MMU - (would have to be created, none currently matches the exact spec.)	Structural Composite Industries (A company of Worthinton Cylinders)	2-12 weeks. Depending if model selected is popular.
Robotic Arms (7 DoF)	Mars 7-DOF Manipulator (New Development)	TRAC Labs, Inc. http://traclabs.com/mars7dof.html	Mid 2011 - may be longer due to needed modifications
Communication System from Ground	TDRSS data link from:	GRGT (Guam), GSFC (Goddard MD), WSGT (White Sands)	Now - May need modifications.
	UHF link with ISS	NASA	Now - May need modifications.
Structure	Materials the same as MMU, Aluminum (2219). Needs to be custom manufactured.	Manufacturers of the materials used for the structure include Martin Marietta Corp., Hugson, Carpenter, Honeywell and Bray Oil Co.	Need to be manufactured. Estimate from manufacturer.
	One-Pilot Submarine	Argo-A-Security or Trisektor	TBD

- Longest Lead Times:**
 Flight Computer (up to 16 months)
 Thruster Triads (12 months)
 Primary Battery (12 months)
 GPS System (12 months)

★ Chosen System



Propulsion System (Repackaged MMU)

Overview

- Cold gas (nitrogen) propulsion system
- Eight thruster triads
 - Provides rotational and translational control
 - Redundant A and B sets
- Total maneuver propellant = 14.2 kg (31.4 lbm)
 - Assumes tank drain from 3400-to-250 psi
 - Total loaded nitrogen = 15.5 kg (34.1 lbm)

Key Features

- VACCO 2 lbf thrusters (same as MMU)
- COTS tank: 1900 in³, 3400 psi
 - Structural Composites Industries
(*Worthington Cylinders Company*)
- Redundant A and B systems
- High TRL

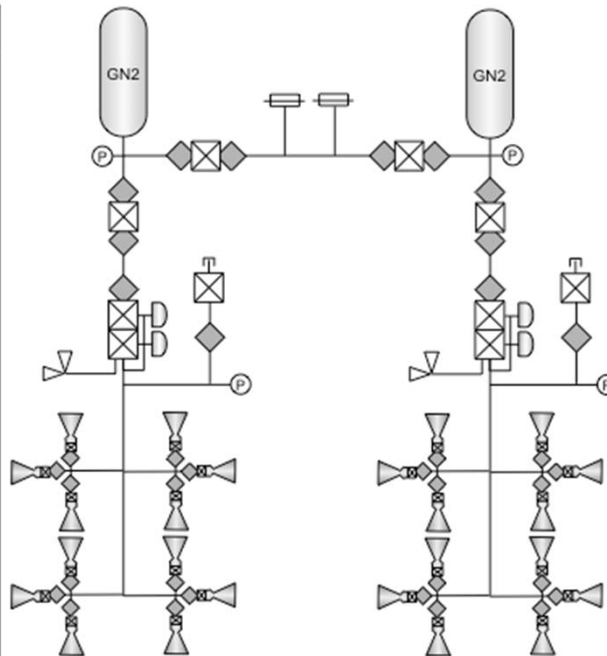
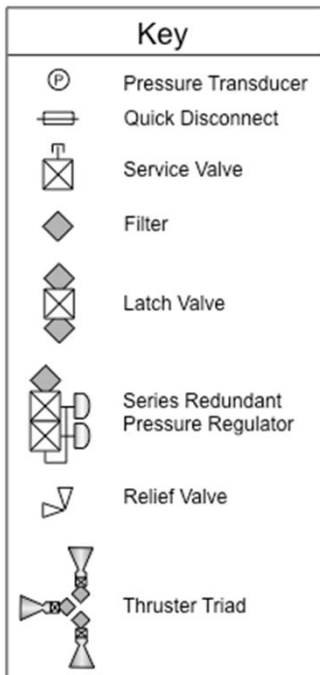

Component	Qty	Unit Mass (kg)	Basic Mass (kg)	AIAA Category & Code	MGA	Predicted Mass (kg)	Comments/Information
Thruster Triad	8	1.41	11.28	A5	2%	11.51	VACCO 2 lbf cold gas thruster triad
Pressure Vessel	2	15.65	31.30	A5	2%	31.93	Worthington Cylinders Tank
Regulator/Relief Valve	2	0.36	0.72	C4	4%	0.75	MMU component
Crossfeed Valve	2	0.45	0.90	E2	12%	1.01	MMU component
Isolation Valve	2	1.20	2.40	C4	4%	2.50	MMU component
Quick Disconnect	2	0.41	0.82	C4	4%	0.85	MMU component
Filter	2	0.25	0.50	E1	18%	0.59	Estimate
Pressure Transducer	2	0.20	0.40	C4	4%	0.42	Typical Value
Pressure Gauge	2	0.08	0.16	C3	8%	0.17	MMU Component
Service Valve	2	0.21	0.42	C4	4%	0.44	MOOG Low Pressure Valve
Lines & Fittings	1	1.74	1.74	E1	18%	2.05	Estimate

Total Dry Mass: 50.64 kg

3.1% 52.20 kg



Structures

Minotaur Launch Loads

TABLE 4-1. PAYLOAD CG PARAMETRIC DESIGN LIMIT LOADS	Payload Mass	
	1600 lbm (725.7 kg)	
	Axial (G) max/min	Lateral (G)
Liftoff	3.83/0.27	0.62
Pre-Transonic Resonant Burn	5.05/0.83	0.02
Transonic	5.13/1.52	1.23
Supersonic	3.41/3.40	1.96
Stage 2 Ignition	3.93/-0.35	4.05
Stage 3 Ignition	6.79/0.00	0.78
Stage 3 Burnout	See Figure 4-3	TBS
Stage 4 Burnout	See Figure 4-3	TBS

Pressure Vessel Stress Plot

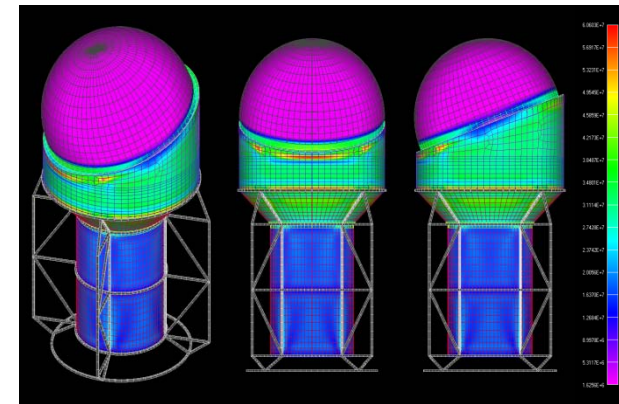
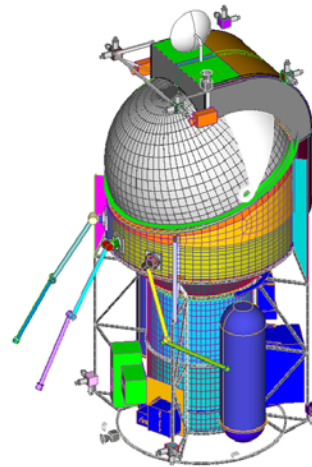

Launch Vehicle & Loads:

Minotaur loads from Payload Planner's Guide
 Integrate with standard Payload Attach Fairing
 Minimum Natural Frequency > 25Hz

Factors of Safety

Yield: 1.25
 Ultimate: 1.4
 Pressure Vessel: 2.0

Materials:

AL 2219 – T87: Pressure Vessel Structure
 AL 7075 – T651: Ringframes & Spars
 Lexan 1500 Polycarbonate: Dome

Component	Qty	Unit Mass (kg)	Basic Mass (kg)	AIAA Category & Code	MGA (%)	Predicted Mass (kg)	Comments/Information
Dome	1	29.48	29.48	E1	18.00%	34.79	Lexan 1500 Polycarbonate
Dome Collar	1	3.23	3.23	E1	18.00%	3.81	AL7075 – T651
Mid Cylinder	1	11.46	11.46	E1	18.00%	13.52	AL2219 – T87
Frustum	1	4.68	4.68	E1	18.00%	5.52	AL2219 – T87
Lower Cylinder	1	7.91	7.91	E1	18.00%	9.33	AL2219 – T87
Bottom Plate	1	8.21	8.21	E1	18.00%	9.69	AL2219 – T87
Lower Spar	4	5.00	20.00	E1	18.00%	23.60	AL7075 – T651
Secondary Structure	1	7.00	7.00	E1	18.00%	8.26	TBD
Joints & Fittings	1	13.00	13.00	E1	18.00%	15.34	TBD

Total Dry Mass: 104.97 kg

18% 123.86 kg



Avionics

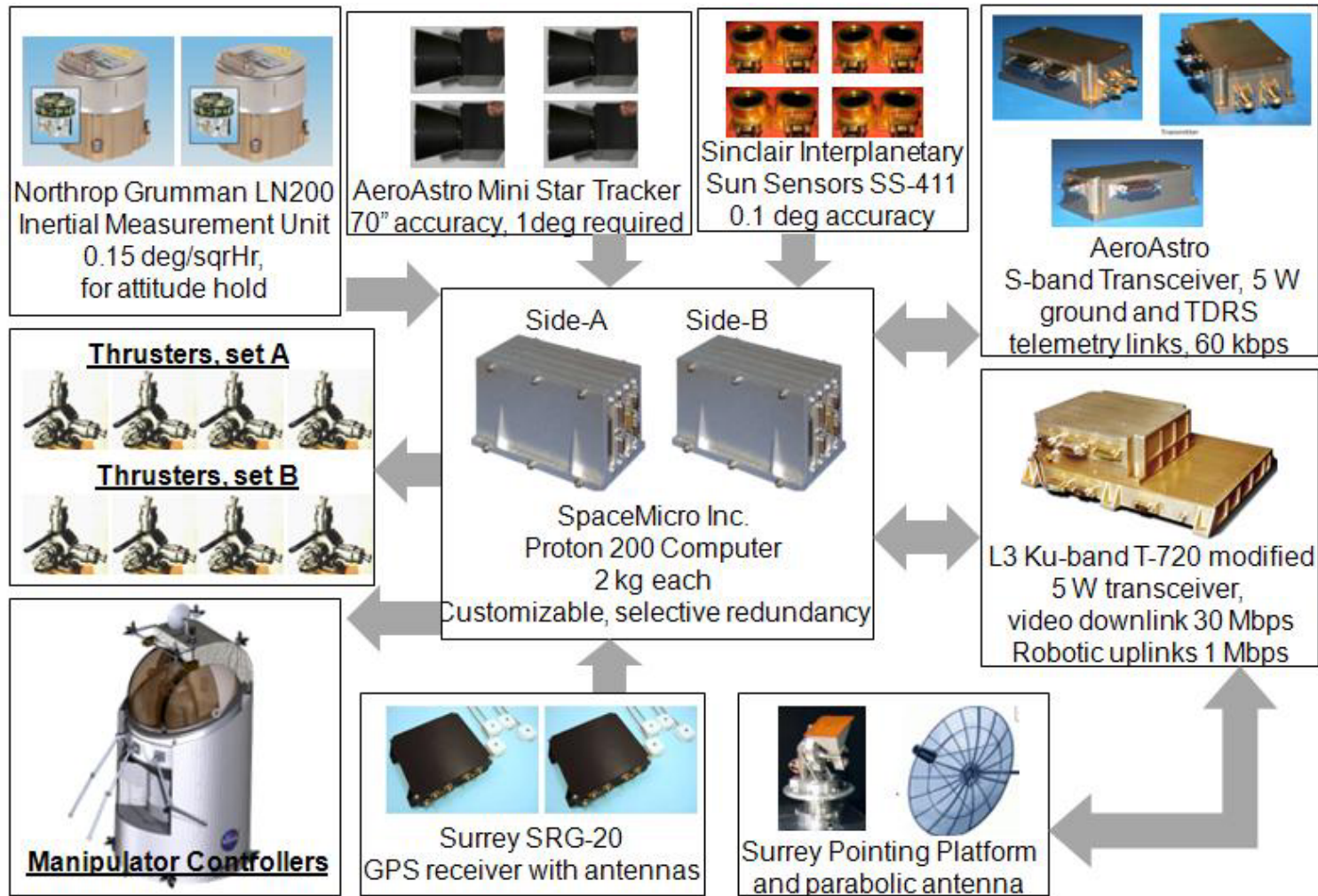



After the Demonstration





Acknowledgement

The authors wish to thank the technical contributions from Jerod Andrews, Mike Baysinger, Pete Capizzo, Leo Fabisinski, Terrie Gardner, Randy Hopkins, Linda Hornsby, David Jones, Dauphne Maples, Andy Philips, Clay Robertson, David Reynolds, Dan Thomas, John Smith, David Smitherman, and Janet Washington.

In addition, the authors wish to acknowledge Reggie Alexander and Don Krupp for management guidance throughout the study.