

Two-Phase Flow Research on the ISS *for* Thermal Control Applications



Dr. Brian J. Motil, *NASA Glenn Research Center*

Fluids in Space

1957: The same year that Sputnik-1 orbited the planet – Robert Siegel (GRC) conceived a drop tower experiment to study a force often masked by gravity yet critical to almost every life form.

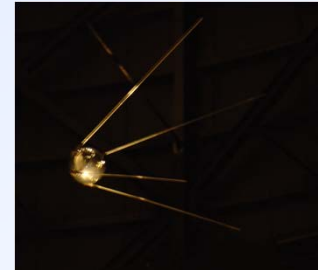

1962: The first “fluids” experiment was conducted in space on the Mercury-Atlas 07 by Scott Carpenter to study the liquid-vapor interface in a baffled tank in weightlessness. (NASA TN D-1577, 1963).



1995: The Colloidal Disorder-Order Transition (CDOT) shuttle flight experiment tested fundamental theories that model atomic interactions in USML-2 on Columbia.

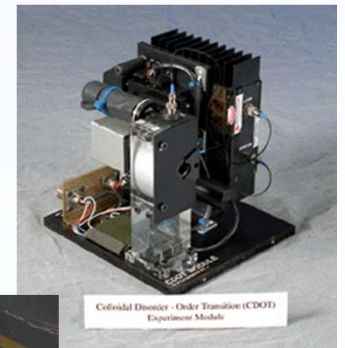

2001: Physics of Colloids in Space (PCS) flew as the first US Rack Level experiment on the ISS.



TODAY....

Fluid Physics and Complex Fluids Today

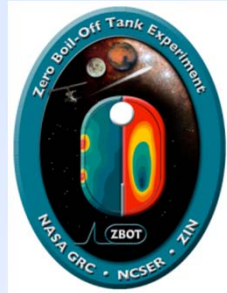
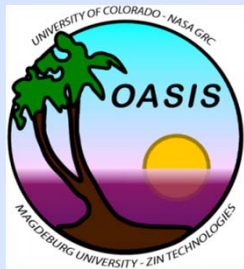

Fluid Physics

- Two-phase flow
- Phase separation
- Boiling, condensation
- Capillary and interfacial phenomena

Complex Fluids

- Colloids
- Liquid crystals
- Foams
- Granular flows

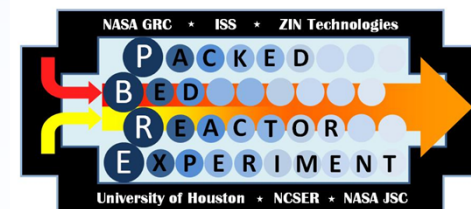
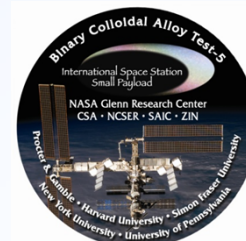

Complex Fluids on ISS

Complex Fluids

- Colloids
- Liquid crystals
- Foams
- Granular flows

Colloids and Rheology:

- Physics of Colloids in Space (PCS)
- Binary Colloidal Alloy Test (BCAT)
- Advanced Colloids Experiment (ACE)
- Investigating Structures of Paramagnetic Aggregates from Colloidal Emulsions (InSPACE)
- Shear History Extensional Rheology Experiment (SHERE)

Liquid Crystals:

- Observation and Analysis of Smectic Islands in Space (OASIS)

Foams:

- Foam Optics And Mechanics (FOAM)
- Particle STAbilised Emulsions and Foams (PASTA)

Granular Flows:

- Compaction and Sound in Granular Matter (COMPGRAN)

Fluid Physics on ISS

Fluid Physics

- Two-phase flow
- Phase separation
- Boiling, condensation
- Capillary and interfacial phenomena

Two-phase flow (without heat transfer)

- Packed Bed Reactor Experiment (PBRE)

Phase separation

- Two-Phase Flow Separator Experiment (TPFSE)

Boiling, Condensation

- Constrained Vapor Bubble (CVB)
- Dynamics Of Liquid Film/complex wall Interaction (DOLFIN)
- Heat Pipe Experiment (HPE)
- Boiling eXperiment Facility (BXF)
 - Microheater Array Boiling Experiment (MABE)
 - Nucleate Pool Boiling Experiment (NPBX)
- Flow Boiling and Condensation Experiment (FBCE)
- Multiphase Flow and Heat Transfer Experiment (MFHT)
- Electro-Hydrodynamic Device (EHD)
- Zero Boil-Off Tank (ZBOT)

Capillary and interfacial phenomena

- Capillary Channel Flow (CCF)
- Capillary Flow Experiment (CFE)

Gas-Liquid Separation Devices



Pumped Separator for PBRE

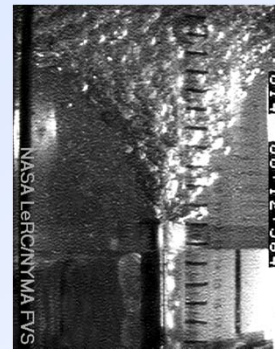

Reduced Gravity
Bubble Vortex

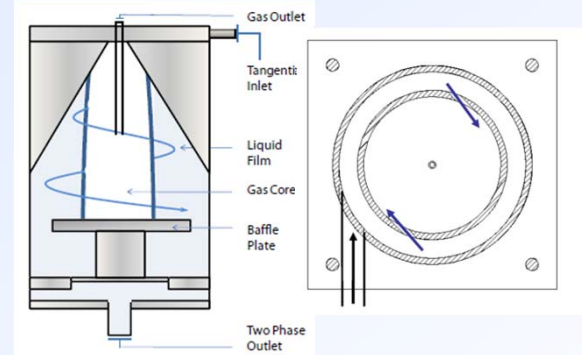

Cyclonic Concepts
Conical and Annular Injection

PI: Dr. George Chahine, DynaFlow, Inc.

PI: Prof. Yasuhiro Kamotani, Case Western Reserve University

Co-I: Prof. Jaikrishnan Kadambi, Case Western Reserve University

Two-Phase Flow Separator Experiment (TPFSE) – 2018

- Two PI Teams will share common test hardware to study different aspects.
- Will address the design and performance of passive two-phase flow separator technologies.
- Determine range of flow rates for acceptable performance.
- Quantify the effect of fluid properties and separator geometry.
- Determine separator response and stability envelope to startup, shutdown and liquid slugs.
- Passive separation is critical to high reliability and low power gas-liquid systems for used in thermal control and life support.
- Holding SCR May 14, 2013

Boiling and Condensation



1-g Flow Boiling (heating from the bottom)



0-g Flow Boiling

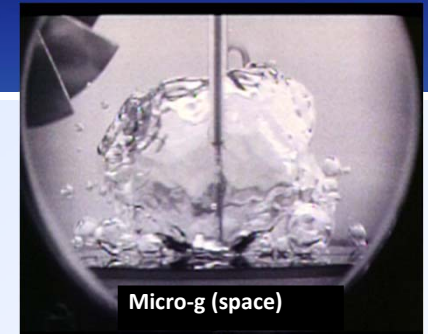

Micro-g (space)

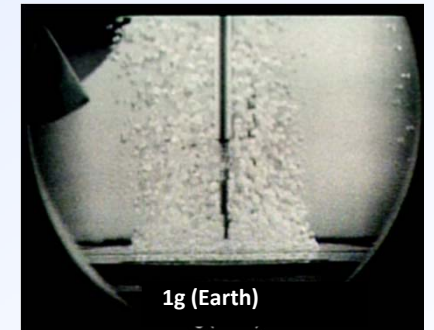

1g (Earth)

Pool Boiling

- Devices in the next generation of space systems are projected to dissipate heat fluxes that far exceed the capabilities of today's cutting-edge thermal management schemes.
- Phase change thermal control systems offer tremendous increases in heat transfer coefficients (~ order of magnitude).
- Challenge in 0-g is to maintain CHF conditions as high as possible.
- Exceeding CHF can lead to permanent damage, including physical burnout, of the heat-dissipating device.

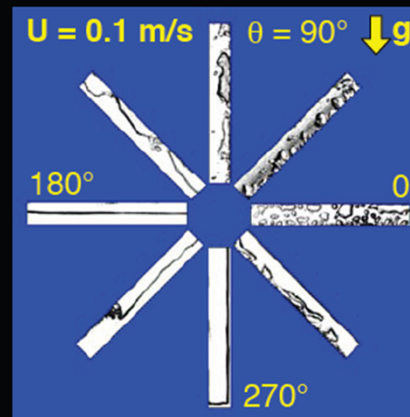

(a)

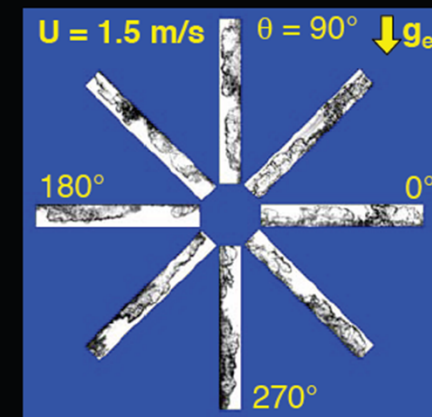

(b)

FIG. 6 Vapor behavior just prior to CHF for different orientation at (a) $U = 0.1$ m/s and (b) $U = 1.5$ m/s (Zhang, Mudawar and Hasan, 2002).

Boiling and Condensation

Constrained Vapor Bubble (CVB) Experiment – 2009 & 2013

- Prototype for a wickless heat pipe in microgravity – based on corner flows.
- Pure Pentane as operating fluid for first set of experiments.
- Provided fundamental transport data including the overall stability, flow characteristics, average heat transfer coefficient in the evaporator, and heat conductance as a function of heat flow rate and vapor volume.
- Interferometry technique obtained direct measurements of fluid curvature and thickness.
- Bank of thermocouples measured the temperature gradients.
- Visualized film stability and shape of dry out regions with a microscope in detail never obtained before in microgravity.
- CVB-2 (2013) will extend data to a *binary mixture* rather than a pure fluid (Pentane – Isohexane).
- Results from CVB-1:
 - There is more internal fluid flow in microgravity.
 - Dryout could not be observed in microgravity.
 - Heat pipes run “hotter” and at higher pressure in microgravity, while the surface intended to be cooled, runs cooler.
 - Unexpected phenomena were observed and enhanced in microgravity including meniscus oscillations and single bubble nucleation phenomena.

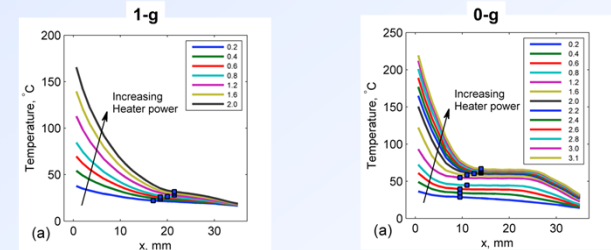

Comparison of heating power (1-g vs 0-g).

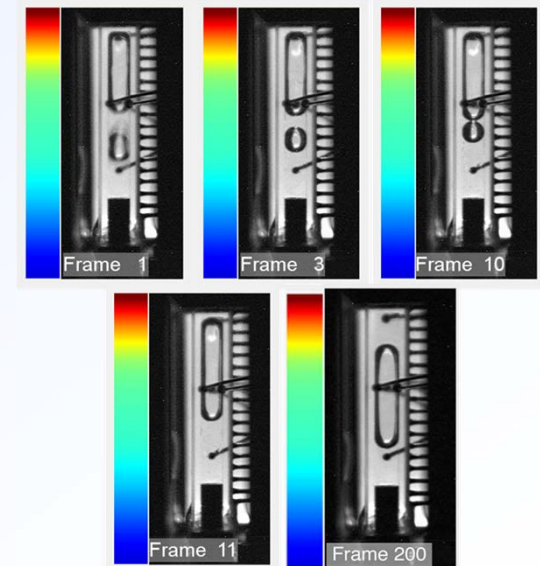

Unexpected Explosive Nucleation in 0-g.

PI: Prof. Joel L. Plawsky, Rensselaer Polytechnic Institute

Co-I: Prof. Peter C. Wayner, Jr., Rensselaer Polytechnic Institute

Boiling and Condensation

US Co-I: Prof. Alexander Yarin, University of Chicago

ESA PI: Prof. Cameron Tropea, Institute of Fluid Mechanics and Aerodynamics (SLA)
Technische Universität Darmstadt

Dynamics of Liquid Film/Complex Wall Interaction (DOLFIN II)

- ESA led experiment to develop continuum models to describe interactions between spreading fluids and chemically and/or morphologically complex surfaces using 0-g environment.
- Developing the ability to manipulate surface flows in microgravity is a key to thermal management solutions in space exploration.
- US PI will perform experiments on spray cooling over specially patterned surfaces.

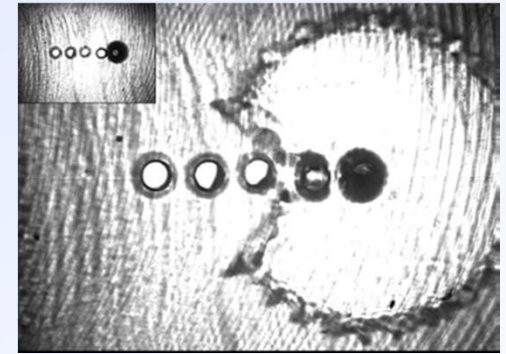

Drop impact onto a porous target



ESA Fluids Science Lab

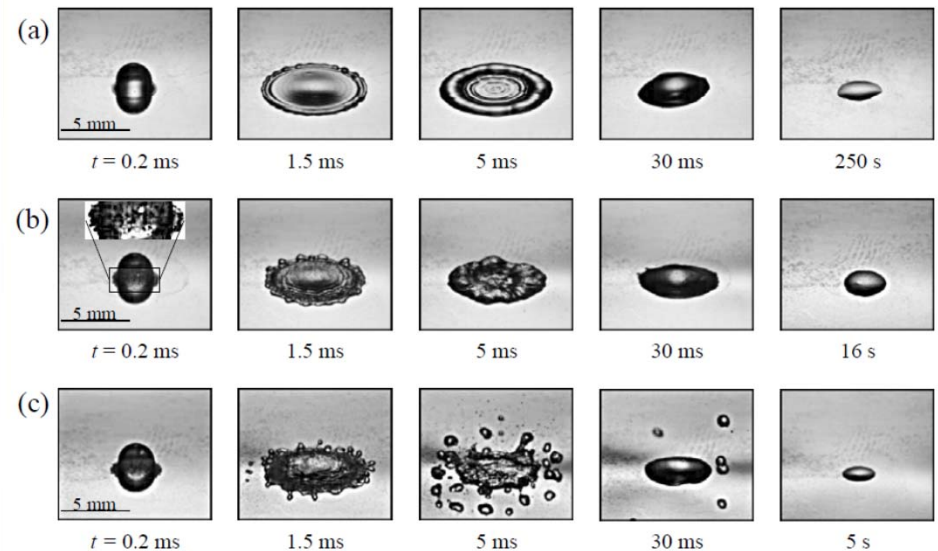

Water drop impact on a bare steel foil at different initial foil temperatures. The initial foil temperature $T_{foil,init}$ is equal to (a) 60 °C, (b) 220 °C, and (c) 300 °C.

Droplet is fragmented at higher temperatures greatly reducing heat transfer.

Boiling and Condensation

PI: TBD

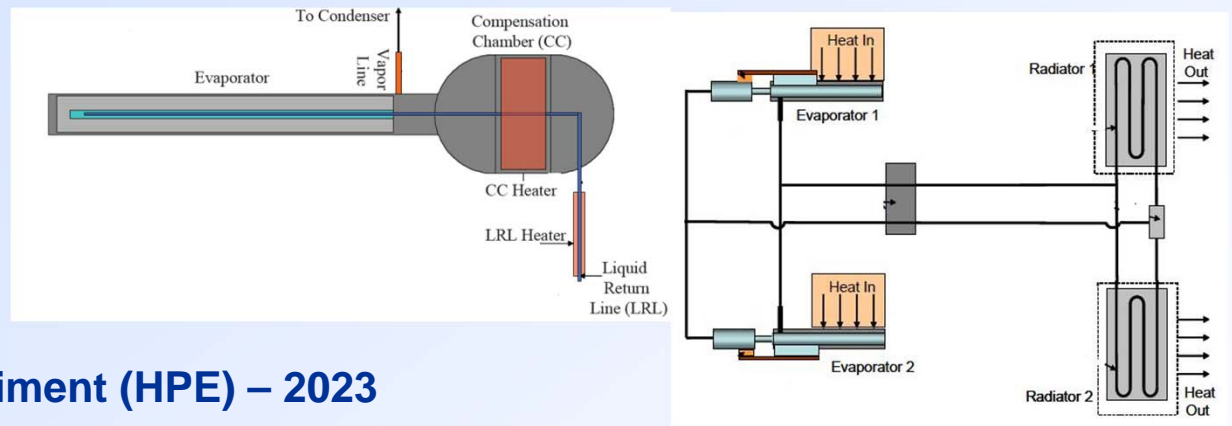

Heat Pipe Experiment (HPE) – 2023

Heat Pipe configurations.

- Determine the maximum heat transport capability of a heat pipe in microgravity.
- A direct correlation between performance in 1-g vs. 0-g will be developed and verified.
- Leverage results of CVB and CVB-2 to develop a fast, low cost, low-gravity flight experiment for ISS.
- Candidate heat pipe variants include loop heat pipes, capillary pumped loops, oscillating heat pipes, variable, and fixed conductance heat pipes.
- Start in 2019 or sooner if budget is available.

Boiling and Condensation

Boiling eXperiment Facility (BXF) – 2011

- BXF included two separate pool boiling investigations:
 - **Microheater Array Boiling Experiment (MABE)**
 - **Nucleate Pool Boiling Experiment (NPBX).**
- Advanced understanding of local boiling heat transfer mechanisms & critical heat flux in microgravity for nucleate and transition pool boiling.
- Detailed measurements of bubble growth, detachment and subsequent motion of single and merged (larger) bubbles.
- Enhanced the development of two-phase thermal management systems, which provide isothermal control with reduced radiator area and mass.
- MABE (Kim) recently published results in J. of Heat Transfer on two regimes for predicting pool boiling behavior: buoyancy and surface tension dominated boiling regimes.

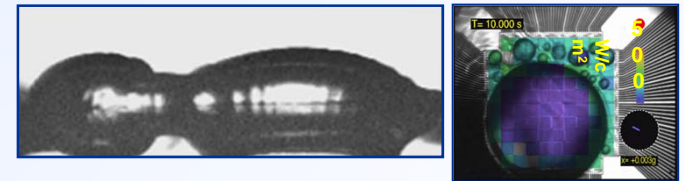

(Top) Paulo Nespoli installing BXF in MSG. (Above left) Coalescence of vapor bubbles on NPBX wafer. (Above right) MABE subcooled nucleate boiling in μ g colorized to illustrate actual heat flux.

PI: (MABE) Prof. Jungho Kim, University of Maryland
PI: (NPBX) Prof. Vijay Dhir, University of California, LA

Boiling and Condensation

Flow Boiling and Condensation Experiment (FBCE) – 2017

- Will develop mechanistic models for microgravity flow boiling Critical Heat Flux (CHF) and dimensionless criteria to predict minimum flow velocity required to ensure gravity-independent CHF.
- Will develop mechanistic model for microgravity annular condensation and dimensionless criteria to predict minimum flow velocity required to ensure gravity-independent annular condensation; also develop correlations for other condensation regimes in microgravity.
- PI is building partial data base from 0-g aircraft testing.
- Approach will be to develop an integrated flow boiling/condensation experiment to facility follow-on researcher.

PI: Prof. Issam Mudawar, Purdue University
Co-I: Dr. Mojib Hasan, NASA GRC

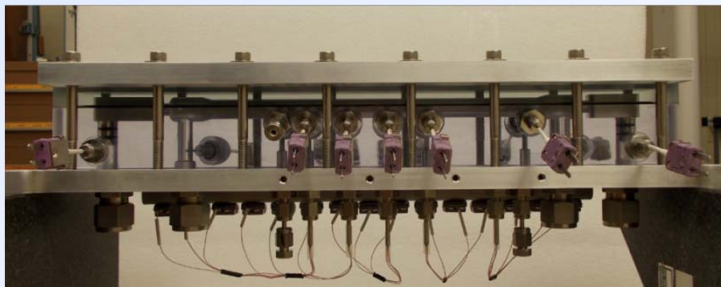

Recently completed one-third scale condensation module.

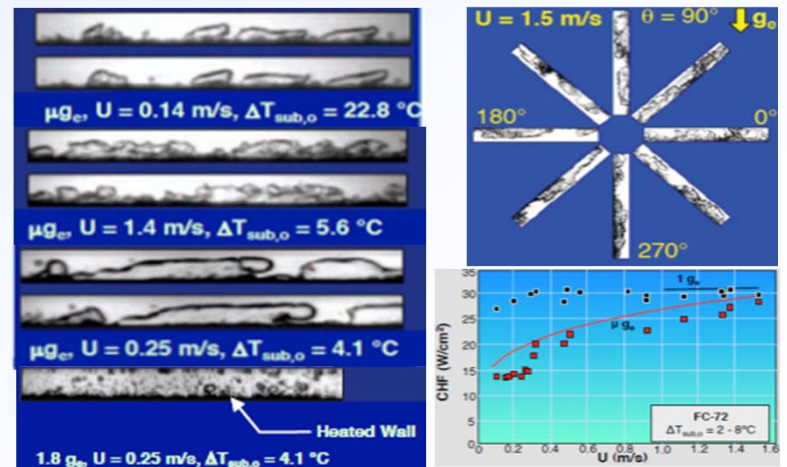

Critical Heat Flux (CHF) data and model predictions for microgravity and Earth gravity for flow boiling.

Boiling and Condensation

PI: Prof. Jungho Kim, University of Maryland

Multiphase Flow and Heat Transfer Experiment (MFHT) - 2020

- Will develop models that incorporate two-phase flow regimes and fluid conditions to predict local heat transfer coefficients from subcooled nucleate boiling through critical heat flux (CHF) and dryout.
- Will obtain local measurements of the wall heat transfer coefficient with high temporal and spatial resolution using an infrared video (IR) camera to study heat transfer mechanisms for various flow regimes.

- Doping of silicon tube is controlled to make it transparent to IR yet be able to electrically heat it
- Deposit an IR opaque thin film locally to measure temperature distribution

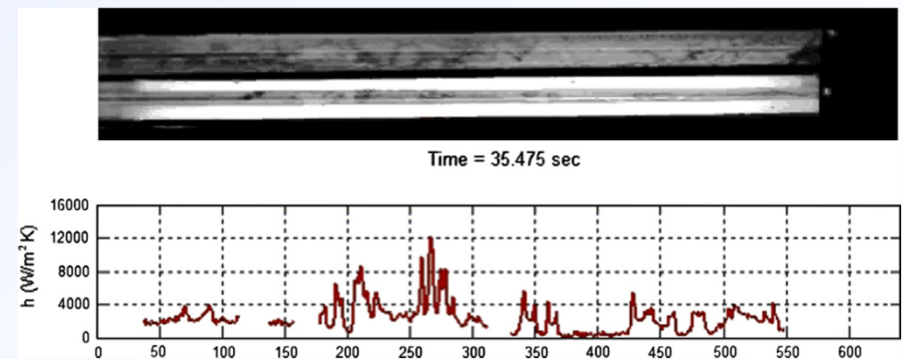

Top: Example of flow boiling FC-72 within a silicon tube visualized using an IR camera.

Bottom: Heat transfer coefficient distribution at a representative time during low-g on Aircraft

Boiling and Condensation

Electro-Hydrodynamics Device (EHD) – 2020

- Will develop fundamental understanding and physical models to characterize the effects of gravity on the interaction of electric and flow fields in the presence of phase change.
- Will characterize electrowetting effect on boiling and CHF in the absence of gravity.
- Electro-wetting of the boiling section will repel the bubbles away from the heated surface in microgravity environment.
- Micro-scale devices have extremely high heat fluxes due to the small heat transfer surface area.
- Provides a robust, non-mechanical, lightweight, low-noise and low-vibration device.
- Recently concluded successful 0-g aircraft testing demonstrating EHD pump works well in 0-g.

PI: Prof. Jamal Seyed-Yagoobi, Worcester Polytechnic Institute
Co-I: Jeffrey Didion, NASA GSFC

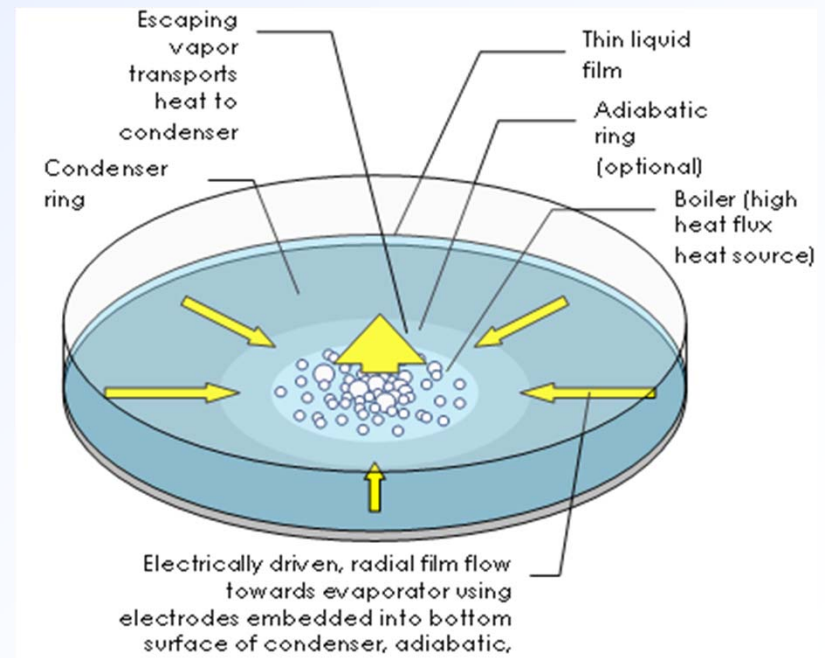

State of the Art in Two-Phase Flow

- Reasonably good (useful) models in two-phase flow have been developed for terrestrial applications such as nuclear reactors.
- Regardless of the particular situation, multiphase flows are generally complicated and to a large extent models are empirically based.
- However models developed for specific industries still provide a good starting point to motivate further research into model development for two-phase flows for low gravity applications.
- Still use simple models which include lumped parameter and one-dimensional models such as homogeneous equilibrium models, phase-slip models and drift-flux models.
- Computational Multiphase Fluid Dynamic (CMFD) models are also available such as the two-fluid, four-field model developed by Lahey and Drew [2001, 2005].
- CMFD models predict the velocity and pressure fields in each phase and the volumetric fractions of the continuous liquid and vapor fields and the dispersed liquid and vapor fields.
- CMFD models rely heavily on empiricism and experimental data is a vital source of input for such models.



State of the Art in Two-Phase Flow

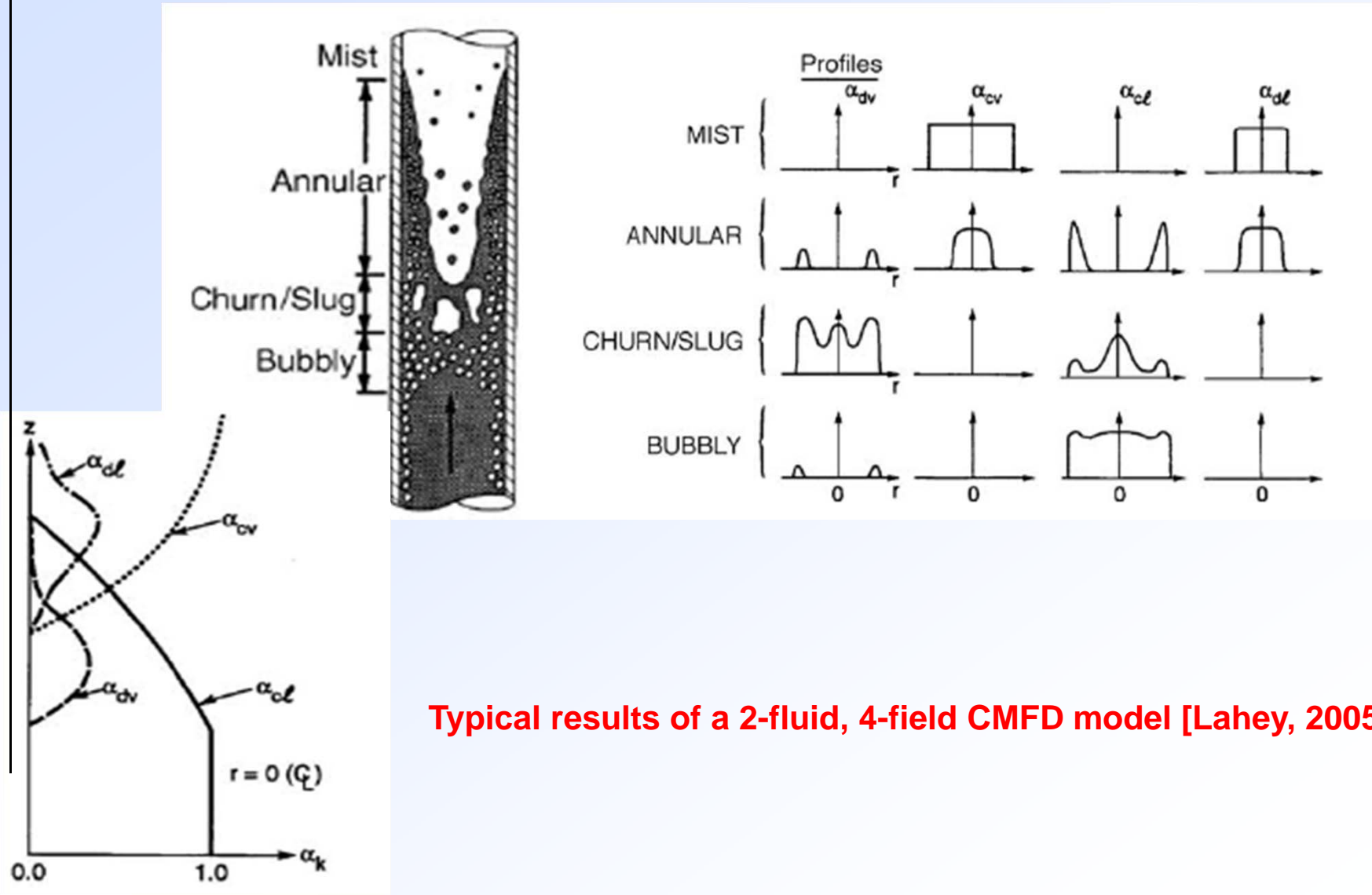

Typical results of a 2-fluid, 4-field CMFD model [Lahey, 2005]

State of the Art in Two-Phase Flow

- 2-Fluid, 4-Field CFMD models have the form:

$$\frac{\partial \phi_{ij} \rho_j}{\partial t} + \nabla \cdot (\phi_{ij} \rho_j \mathbf{v}_{ij}) = \Gamma_{ij} + \dot{m}_{ij}''' , \quad (1)$$

$$\begin{aligned} \frac{\partial (\phi_{ij} \rho_j \mathbf{v}_{ij})}{\partial t} + \nabla \cdot (\phi_{ij} \rho_j \mathbf{v}_{ij} \mathbf{v}_{ij}) + \nabla (\phi_{ij} p_j) - \nabla \cdot (\phi_{ij} [\mathbf{T}_{ij} + \mathbf{T}_{ij}^T]) \\ - \phi_{ij} \rho_k \mathbf{g} - \mathbf{M}_{ij} - \mathbf{M}_{ij}^W = \Gamma_{ij} \mathbf{v}_k + \dot{m}_{ij}''' \mathbf{v}_{ij}^{\sim} , \end{aligned} \quad (2)$$

$$\begin{aligned} \frac{\partial (\phi_{ij} \rho_j h_{ij})}{\partial t} + \nabla \cdot (\phi_{ij} \rho_j \mathbf{v}_{ij} h_{ij}) + \nabla \cdot (\phi_{ij} \rho_j \mathbf{v}_{ij} h_{ij}) - \nabla \cdot (\phi_{ij} [\mathbf{q}_{ij}'' + \mathbf{q}_{ij}''^T]) \\ - D_{ij} - \phi_{ij} q_{ij}''' - \frac{Dp_{ij}}{Dt} - q_{Iij}'' A_I''' = \Gamma_{ij} u_{Iij} + \dot{m}_{ij}''' u_{ij}^{\sim} \end{aligned} \quad (3)$$

State of the Art in Two-Phase Flow

- Direct Numerical Simulation (DNS) can be used to provide input to CMFD type models, reducing (but not eliminating) the dependence of experiments, Lahey [2009].
 - DNS can be used to develop closure laws for two-fluid CMFD models.
 - Interfacial force densities in Momentum Eqn. (2), can be determined from the DNS results by partitioning the interfacial force density into “drag” and “non-drag” components (e.g., virtual mass, lift, and dispersion).

$$\mathbf{M}_{ij}^{(D)} = 0.125 \rho_{ij} C_D (v_{dv} - v_{cl})$$

$$\mathbf{M}_{ij}^{ND} = \phi_{ij} \rho_{ij} \left[\frac{D_v \mathbf{v}_{jv}}{Dt} - \frac{D_l \mathbf{v}_{jl}}{Dt} \right] + \phi_{ij} \rho_{ij} C_L |\mathbf{v}_{dv} - \mathbf{v}_{cl}| (\mathbf{v}_{dv} - \mathbf{v}_{cl}) A_{Iij}'''$$

- DNS can be used to supplement the results of carefully chosen space experiments so that multi-phase flow models can be developed and applied to space systems to reduce the number and cost of experiments.
- **Has not been applied to 0-g two-phase flow yet.**

State of the Art in Two-Phase Flow

- The nature of low-gravity applications and limited access to the low-gravity environment creates unique difficulties in the creation of reliable predictive (CMFD) models.
- Integrating modeling and experiment provides a potentially productive approach, especially if DNS is included as a supplement to experiments.
- Unique opportunity exists for limited experiments on ISS in this decade to resolve microgravity two-phase flow challenges. These are critical to many areas of spaceflight (power, propulsion, life support, thermal control, etc.).
- There is also a strong need to simply build a quality database of operating parameters for the most common components particularly those that can either operate in a more efficient manner in 0-g or those that solve common anomalies faced in 0-g fluids systems that frequently bring an entire system off-line until it can be fixed or replaced.



Horizontal pipe on Earth.



Aboard the Space Shuttle.

The radically different flow morphologies require different theoretical models in order to be able to predict these flows.

