



NASA Space Launch System (SLS) Development: *Challenges and Solutions*

Garry M. Lyles
SLS Chief Engineer
NASA Marshall Space Flight Center
July 15, 2013

Space Launch System



Agenda



- ◆ **Opening Remarks**
- ◆ **RS-25 Engine**
- ◆ **Core Stage**
- ◆ **Booster**
- ◆ **Interim Cryogenic Propulsion System**

The Future of Exploration

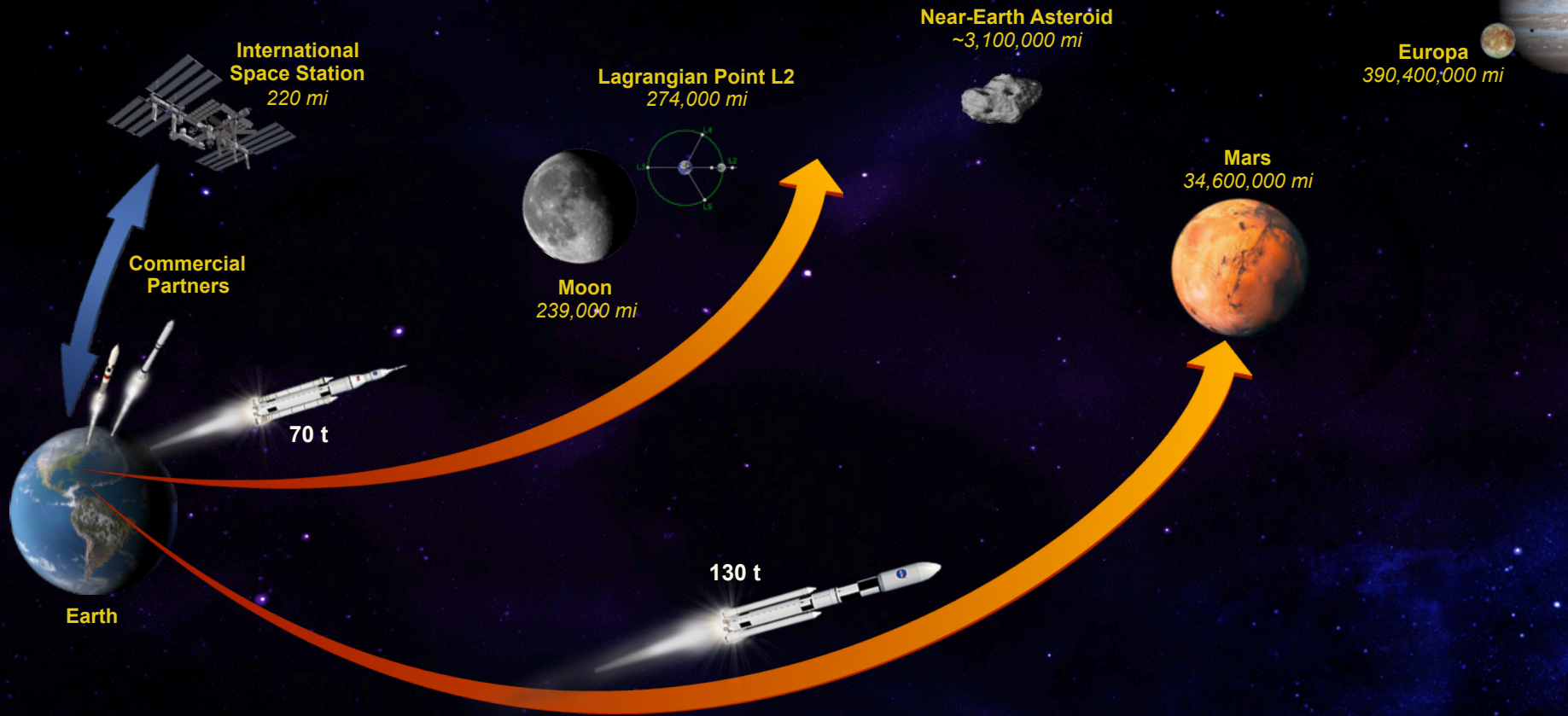

*The Space Launch System [will] be the **backbone** of its manned spaceflight program for decades. It [will] be the most **powerful** rocket in NASA's history...and puts NASA on a more **sustainable** path to continue our tradition of **innovative** space exploration.*

President Obama's Accomplishments for NASA
May 22, 2012

SLS Driving Objectives



◆ Safe

- Human-rated to provide safe and reliable systems
- Protecting the public, NASA workforce, high-value equipment and property, and the environment from potential harm

◆ Affordable

- Maximum use of common elements and existing assets, infrastructure, and workforce
- Constrained budget environment
- Competitive opportunities for affordability on-ramps

◆ Sustainable

- Initial capability: 70 metric tons (t), 2017–2021
 - Serves as primary transportation for Orion and human exploration missions
- Evolved capability: 105 t and 130 t, post-2021
 - Offers large volume for science missions and payloads
 - Reduces trip times to get science results faster
 - Minimizes risk of radiation exposure and orbital debris impacts

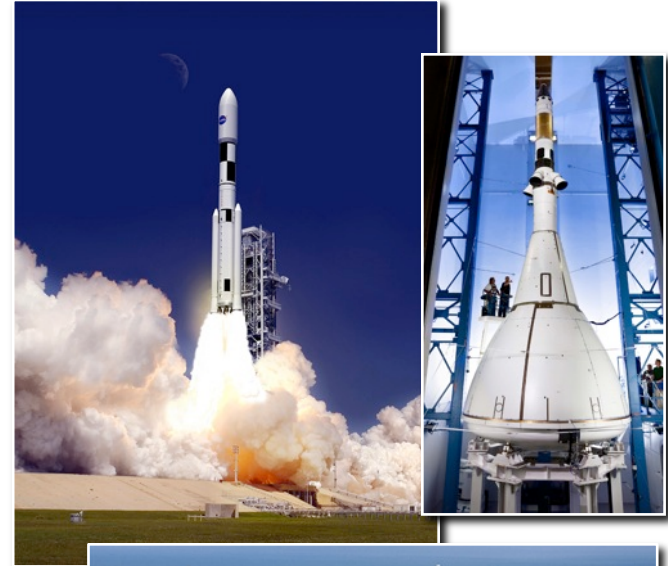

Platform for Missions Beyond Earth's Orbit

Potential SLS Mission Capture and Evolution

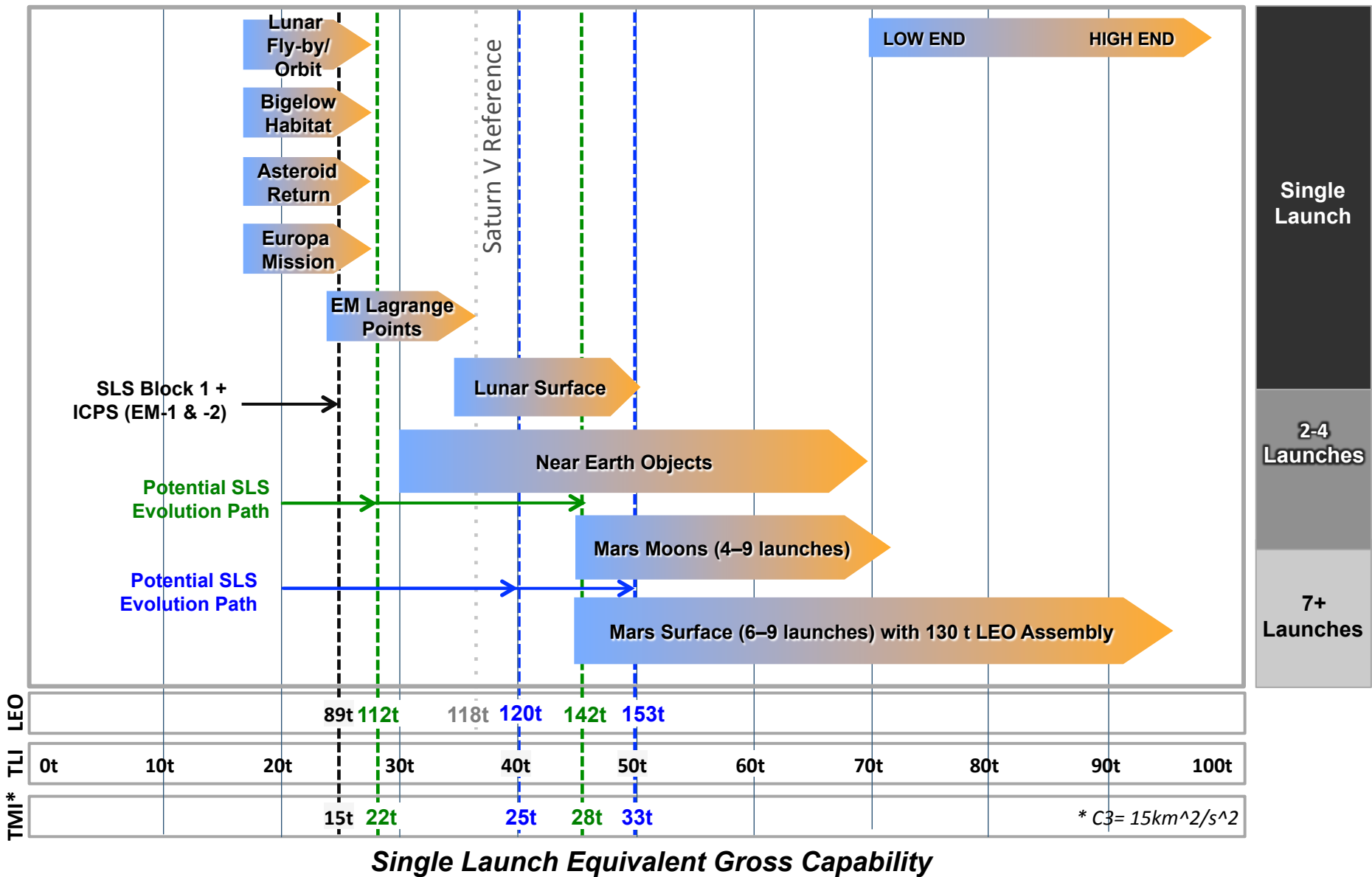

SLS Launch Schedule

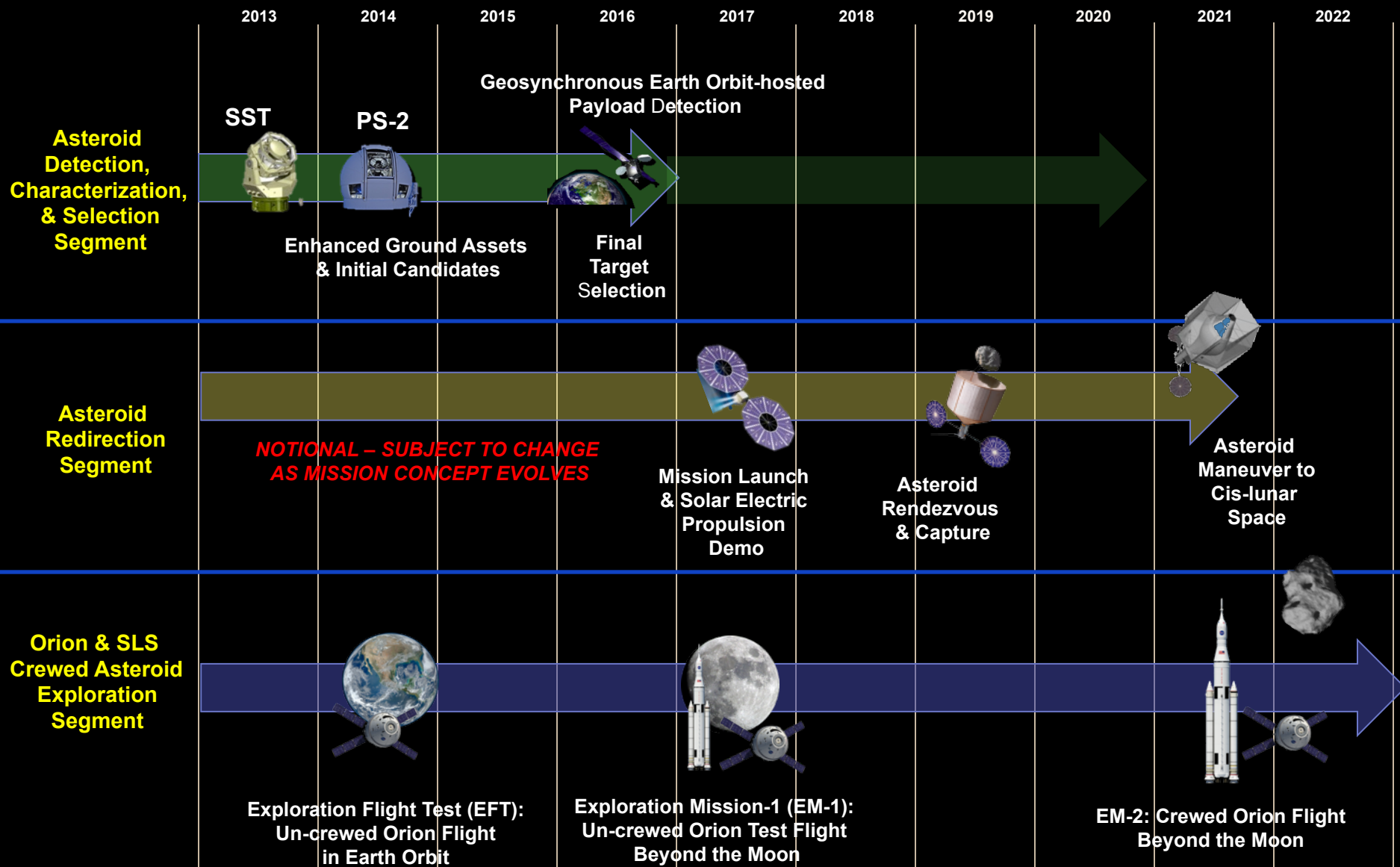

70 Metric Ton Expanded View

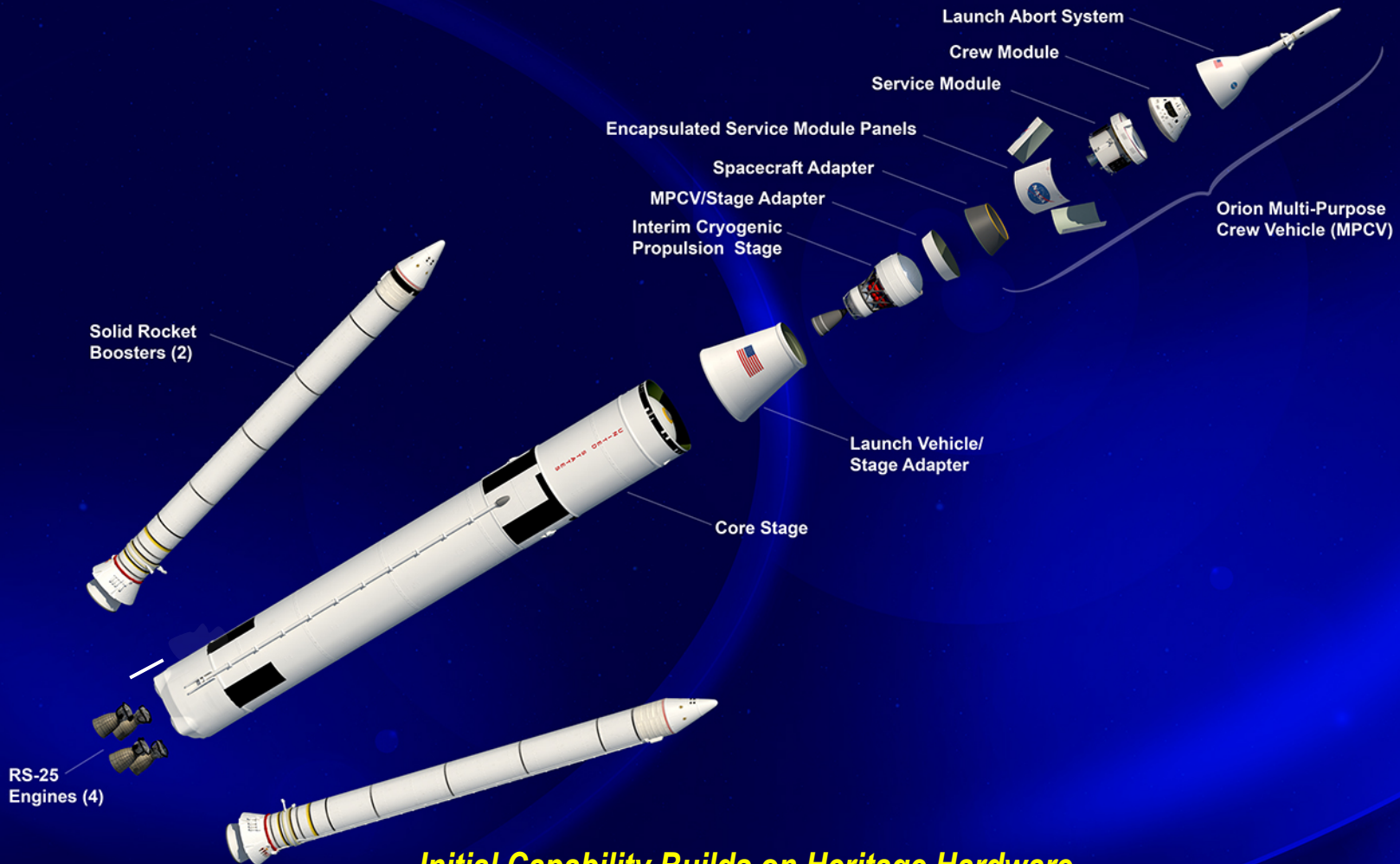

Initial Capability Builds on Heritage Hardware

Heritage Hardware Considerations



Contractual

- Existing contracts may provide a fast start
- Contracts clearly define scope
- Hardware capabilities and people/processes are typically intertwined with contractual considerations

Hardware

- Heritage hardware comes with all of the heritage capabilities
- Heritage hardware also comes with all of the heritage limitations

People/Processes

- Capabilities of heritage hardware typically tightly coupled with heritage processes
- Heritage processes are often tightly coupled with the people operating the processes

Cost

- Appropriate usage of heritage hardware, existing assets and infrastructure, and existing contracts is an important part of the overall approach for affordability
- Heritage hardware typically comes with legacy costs

Technical integration focused on interfaces (structural, electrical, and organizational) between individually procured hardware elements

The Road to First Flight in 2017



NASA Life Cycle Phases	Approval for Formulation ▼	FORMULATION			Approval for Implementation ▼	IMPLEMENTATION		
Program Life Cycle Phases	Pre-Phase A: Concept Studies	Phase A: Concept & Technology Development	Phase B: Preliminary Design & Technology Completion	Phase C: Final Design & Fabrication	Phase D: System Assembly, Int. & Test, Launch & Checkout	Phase E: Operations & Sustainment	Phase F: Closeout	
Program Life Cycle Gates and Major Events	Key Decision Point A ▼ ✓	KDP B ▼ ✓	KDP C ▼	KDP D ▼	KDP E ▼	KDP F ▼		
				EFT-1 Launch ▼	EM-1 Launch ▼	EM-2 Launch ▼		
Human Space Flight Project Reviews	MCR ▼ ✓	SRR/SDR ▼ ✓	PDR ▼	CDR ▼	SR ▼	FRR ▼		
	2011	2012	2013	2015	2016	2017	2021	

FOCUSED ON

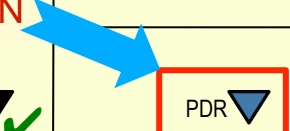

[A] monumental effort ... has gone into this Program.... I don't think anyone would have thought in September [2011] that this Program might be this far so fast.

CDR: Critical Design Review	MCR: Mission Concept Review
EM: Exploration Mission	PDR: Preliminary Design Review
EFT: Exploration Flight Test	SIR: System Integration Review
FRR: Flight Readiness Review	SDR: System Definition Review
KDP: Key Decision Point	SRR: System Requirements Review

LeRoy Cain, Chair
Standing Review Board
June 29, 2012

SLS Partnerships Nationwide

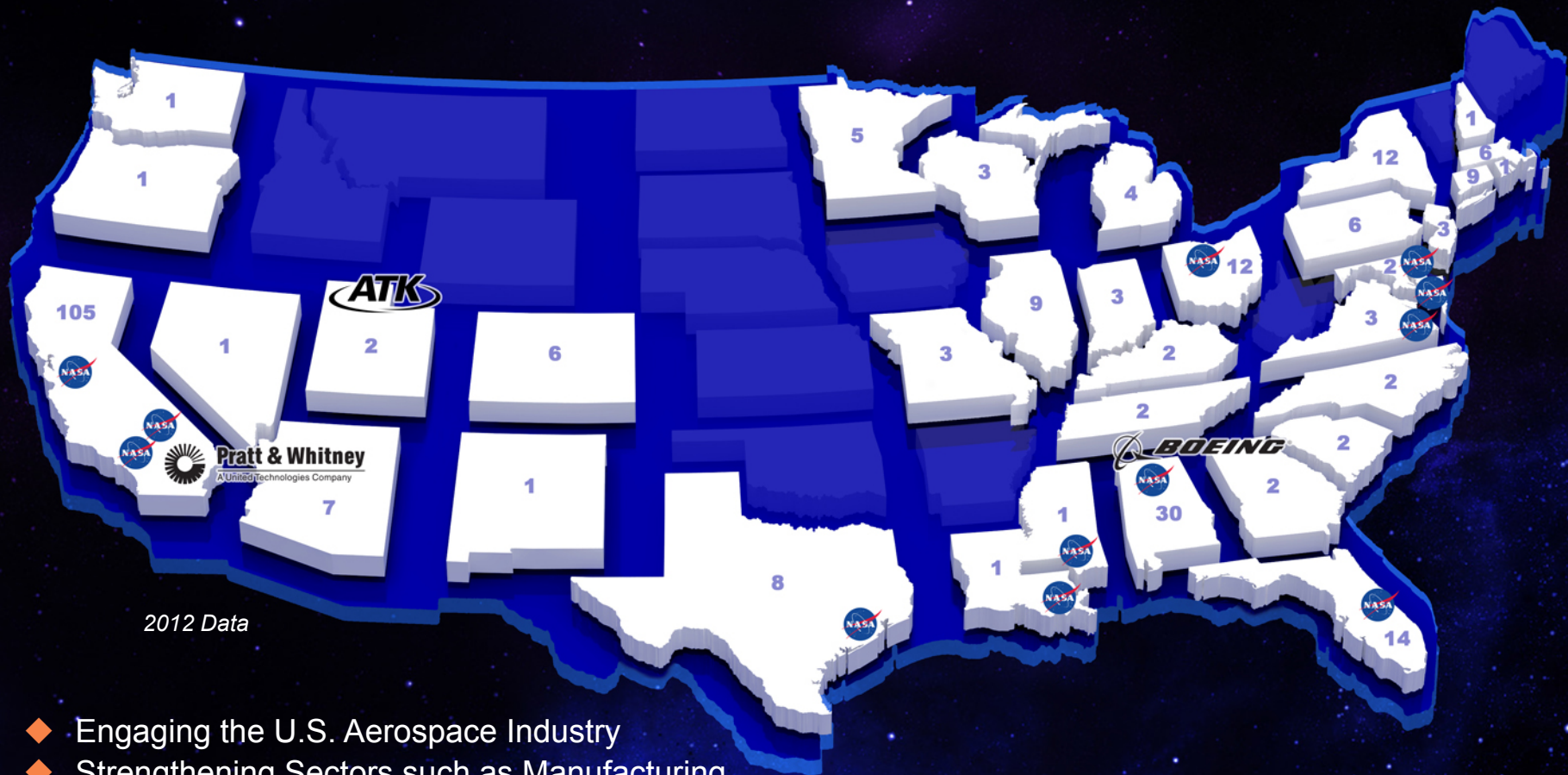

2012 Data

- ◆ Engaging the U.S. Aerospace Industry
- ◆ Strengthening Sectors such as Manufacturing
- ◆ Advancing Technology and Innovation

208 Subcontracts in 28 States

NASA's Space Launch System



On Course for First Flight in 2017

Engines

Tested selective laser melted part on J-2X at Stennis Space Center (March 2013)



Boosters

Conducted Thrust Vector Flight Control Test at ATK in Promontory, UT (Jan 2013)

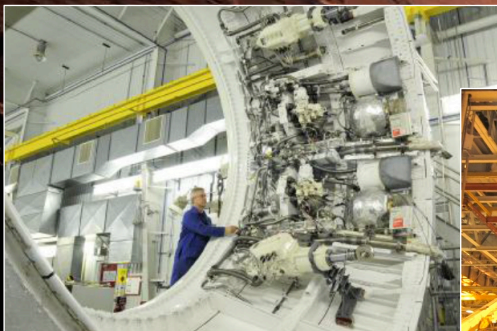

Core Stage

Produced Core Stage test panel at AMRO Fabricating Corp. in South El Monte, CA (Dec 2012)

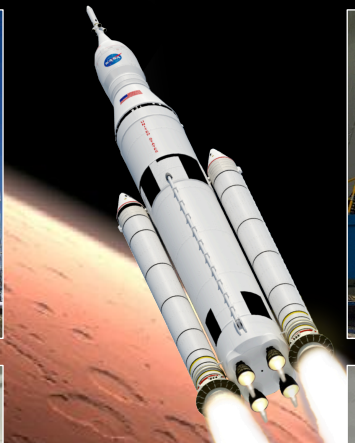

Preparing segmented ring tool for Core Stage construction at the Michoud Assembly Facility in New Orleans

Spacecraft & Payload Integration

Produced Multi-Purpose Crew Vehicle Stage Adapter for 2014 Exploration Flight Test at the Marshall Space Flight Center (Feb 2013)

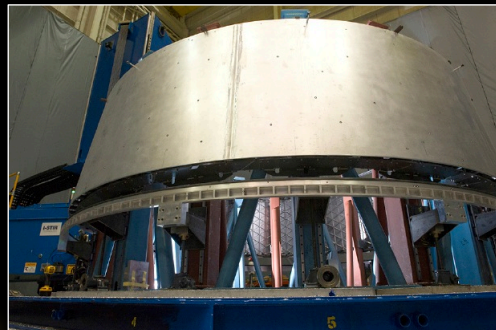

Advanced Development

Conducted F-1 engine hot-fire testing at Marshall (Jan 2013)



Systems Engineering & Integration

Tested buffet model in Langley Research Center's Transonic Dynamics Wind Tunnel (Nov 2012)



SAFE, AFFORDABLE, SUSTAINABLE

Powering the Future of Exploration





RS-25 Engine Development Challenges and Solutions

Katherine P. Van Hooser
SLS Engines Chief Engineer
NASA Marshall Space Flight Center

Doug Bradley
RS-25 Core Stage Engine Chief Engineer
Aerojet Rocketdyne

July 15, 2013

Space Launch System



Agenda



◆ Opening Remarks

◆ **RS-25 Engine**



◆ Core Stage

◆ Booster

◆ Interim Cryogenic
Propulsion System

- **Challenge:** Long Term Storage
Solutions: Transfer to Stennis Space Center; Identify/optimize storage options
- **Challenge:** Heritage engine Controller Unit incompatible with new vehicle
Solutions: Design new controller; leverage J-2X design
- **Challenge:** Higher Liquid Oxygen (LOX) inlet pressure
Solutions: Modify engine; Limit maximum pressure; Modify start sequence
- **Challenge:** Lower LOX temperatures
Solutions: Add heat; Reduce pre-start bleed flows; Modify start sequence

NASA's Space Launch System RS-25 Development Challenges and Solutions



- ◆ **RS-25 Support to SLS**
 - Proven
 - Flexible
 - Affordable

- ◆ **Heritage engine integration into new vehicle**
 - Interfaces, environments – external and internal

- ◆ **Specific challenges and solutions**
 - Asset management
 - Obsolescence - controller
 - Integration – LOX inlet conditions

- ◆ **Accomplishments**



RS-25/Space Shuttle Main Engine



Proven – Flexible - Affordable

- ◆ **Proven safety and reliability**
- ◆ **Man-rated**
- ◆ **Versatile high performance capability demonstrated**
- ◆ **Significant hardware availability at end of program**
 - 16 flight engines
 - 2 development engines



Selected for Space Launch System Core Stage



RS-25 Asset Management



◆ SLS mission assessment

- Power level capability demonstrated in Space Shuttle Main Engine (SSME) program
- Life limits reassessed, updated to meet SLS mission requirements

◆ Challenge: Long term storage

- Protect from damage, deterioration

◆ Solutions

- Transferred engines from Kennedy Space Center (KSC) to Stennis Space Center (SSC)
- Options for storage identified and optimized
 - Containers
 - Bags
 - Purges
 - Monitoring



Engines at KSC at End of Shuttle Program



Engines at SSC

Engine Integration into Vehicle



◆ Heritage engine designed for Shuttle must be integrated into SLS vehicle

◆ Physical interfaces

- Mechanical interfaces: Defined and coordinated with Stages Element
- Electrical interfaces: Engine controller in work

◆ Exterior environments

- Aft compartment conditions
- Reduced distance between Booster plume and RS-25 nozzles

◆ Internal environments

- Gases, hydraulics: Defined
- Propellant inlet conditions

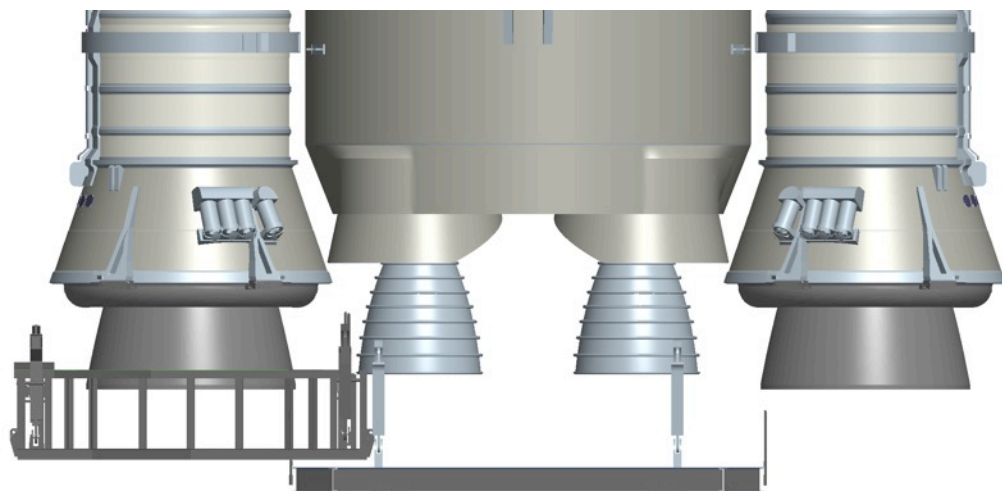

Engine Controller Unit (ECU)



◆ ECU function

- Controls thrust and mixture ratio
 - Open and closed loop
- Continuously monitors engine health
- Provides electric power to control elements, sensors, and effectors
- Accepts commands from and reports data to vehicle computers

◆ **Challenge:** Heritage controller incompatible with new vehicle

◆ **Solutions**

- Design new controller rather than adapt old
- Leverage J-2X design for “universal controller”

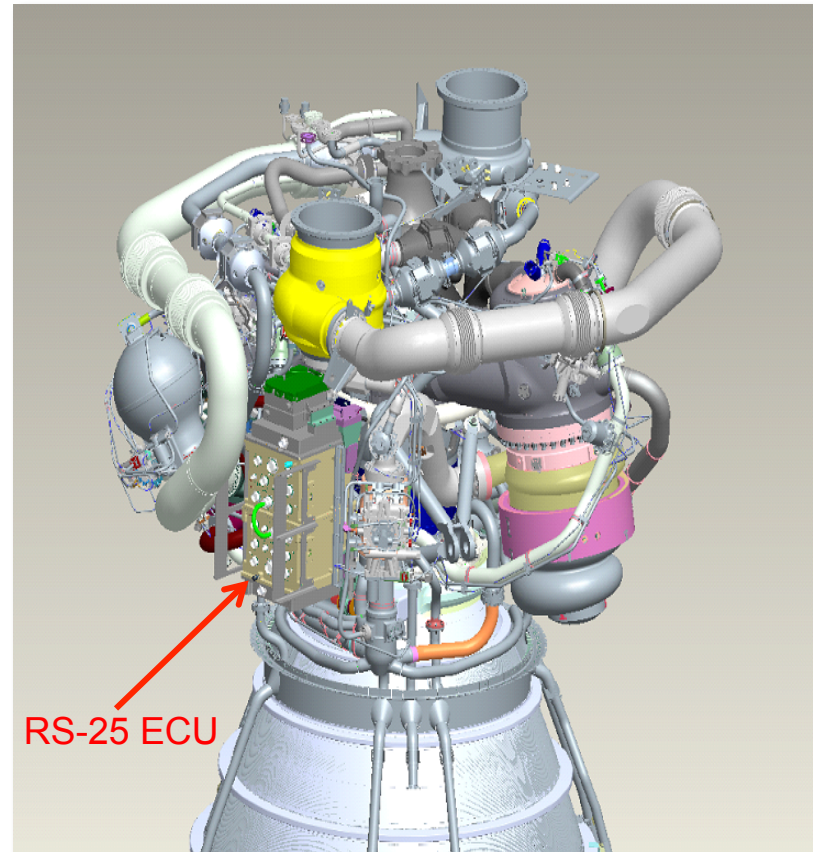

Engine Controller Unit (ECU) (Continued)

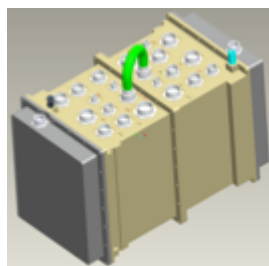
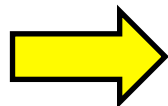

RS-25 ECU
Basic design supports
RS-25 and J-2X

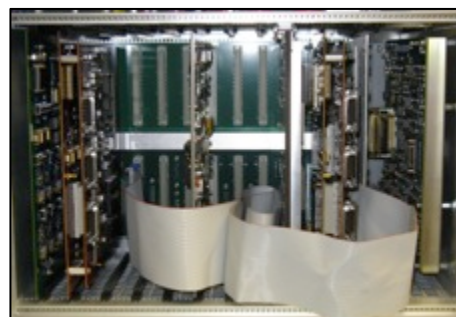
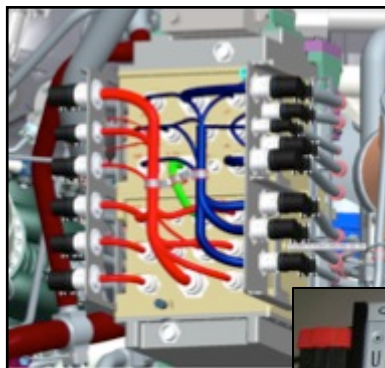
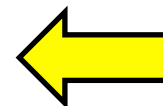

- ◆ Hardware Critical Design Review (CDR) May 2013 ✓
- ◆ Software Preliminary Design Review (PDR) June 2013 ✓
- ◆ ECU Demo #2 / Operational Flight Program (OFP) functionality Dec 2013
- ◆ Software CDR Dec 2013
- ◆ **First Engineering Controller (EM1) Mar 2014**

Propellant Inlet Conditions



◆ **Challenge:** Higher LOX inlet pressure

- Elevation and configuration of vehicle

◆ **Solutions**

- Modify engine to adapt to pressure
- Limit maximum pressure with mission profile changes
- Modify start sequence

◆ **Status**

- Leverage SSME experience to establish start sequence
- Verify start and mainstage characteristics during ground testing

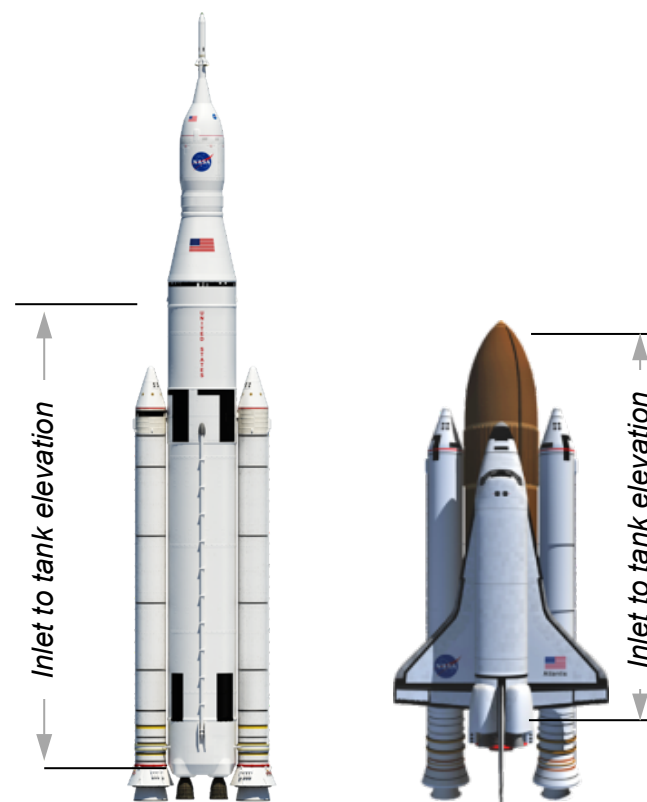

Propellant Inlet Conditions (Continued)



- ◆ **Challenge:** Lower LOX temperatures
 - Configuration of vehicle
 - Potential for damage induced by temperature spikes during start

- ◆ **Solutions**
 - Add heat
 - Reduce pre-start bleed flows
 - Modify start sequence

- ◆ **Status**
 - Leverage SSME experience to establish bleed flows and start sequence
 - Engine and vehicle experts developing combined solution
 - Verify start characteristics during ground testing



Top Accomplishments - Engines

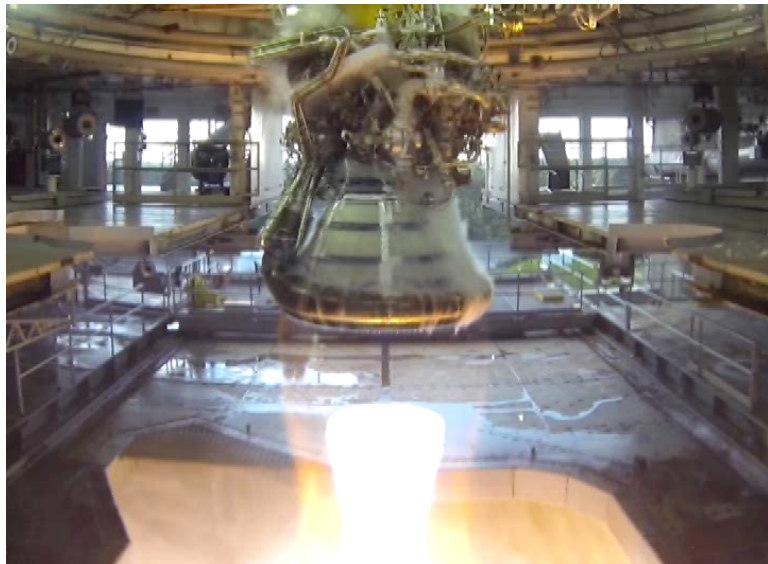

**1st Gimbaling Test for J-2X
June 14, 2013**

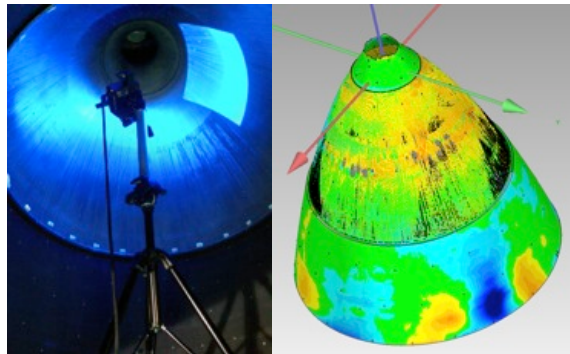

Structured light used in various applications to reduce development time



J-2X has completed 50 tests on 2 engines and 2 powerpacks as of June 20, 2013



**RS-25 Ready to Support Vehicle Preliminary Design Review
June, 2014**



Core Stage Challenges and Solutions

Mike Wood

SLS Chief Engineer

Boeing

July 15, 2013

Space Launch System



Agenda



◆ Opening Remarks

◆ RS-25 Engine

◆ **Core Stage**

◆ Booster

◆ Interim Cryogenic
Propulsion System



- **Challenge:** Vibroacoustic environment
Solutions: Direct part re-use; Design re-use
- **Challenge:** Shock and random vibration loads
Solutions: Direct part re-use; Design re-use
- **Challenge:** Engine interface Control Document GO_2 interface temperature;
maximum interface pressure
Solutions: Design re-use

SLS Core Stage Development On Track for Mid-2014 Critical Design Review

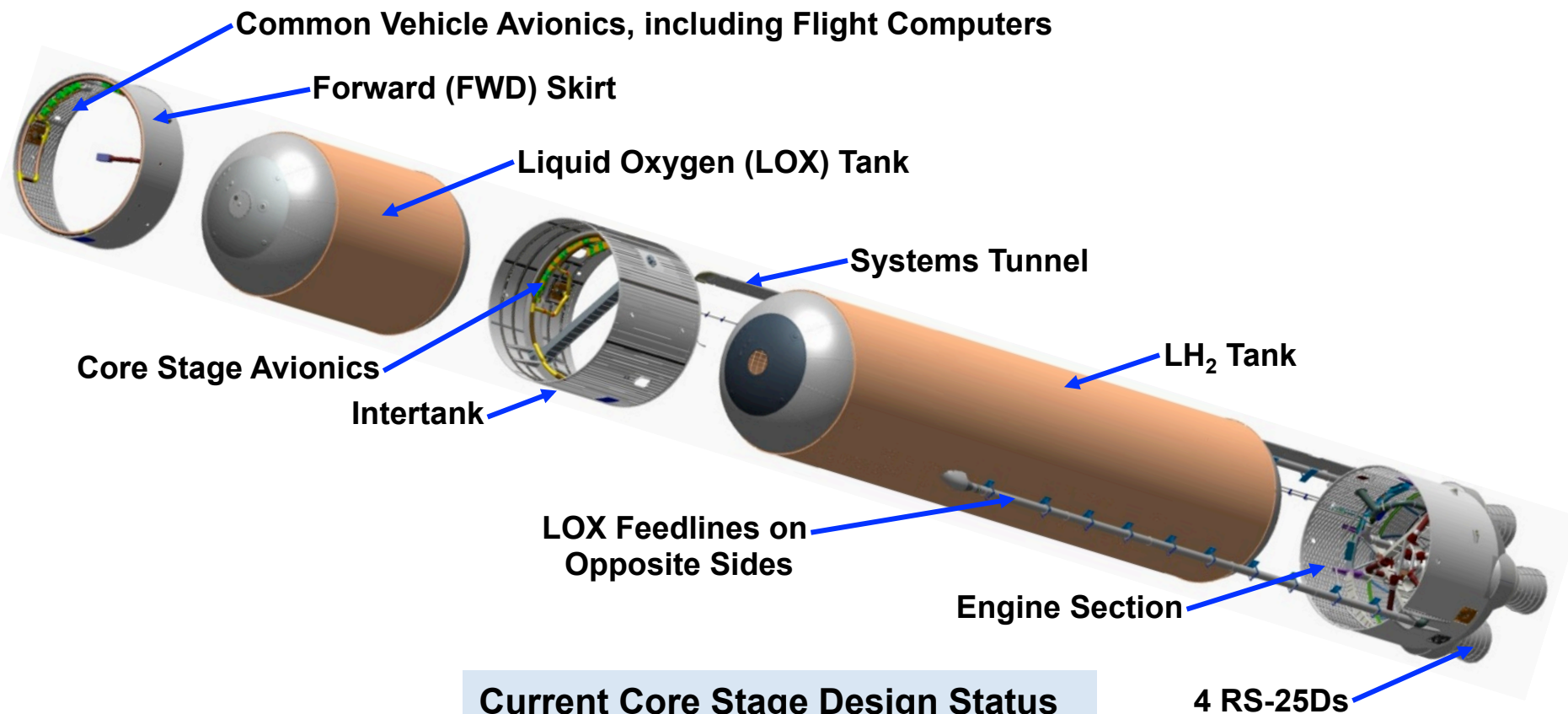

Current Core Stage Design Status

- ◆ Post-PDR (Dec 2012)
- ◆ Drawing release well underway
- ◆ Leveraging heritage components
 - Atlas, Delta, Shuttle
 - Cost and schedule opportunities
- ◆ Major tooling nearing completion

Component Re-Use Reduces Technical Risk Provides Cost & Schedule Benefits



◆ Core stage propulsion design based heavily on heritage programs

- LOX/LH₂ Subsystems
 - Atlas, Delta, Shuttle Heritage
- Gaseous Oxygen (GO₂)/Gaseous Hydrogen (GH₂) Pressurization Systems
 - Delta Heritage
- Pneumatic Systems
 - Delta, Shuttle Heritage

◆ Leveraging analytical and heritage design strengths to develop subsystem design

◆ New rocket design and environments create additional challenges



MPS Shuttle Prevalve



MPS Shuttle
Pneumatic Regulator

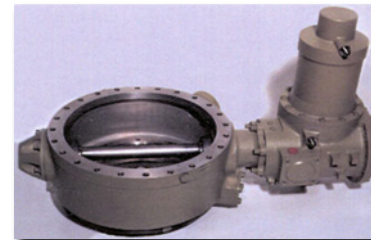

Shuttle Fill & Drain Valve



Delta IV Pressurization
Solenoid Valve

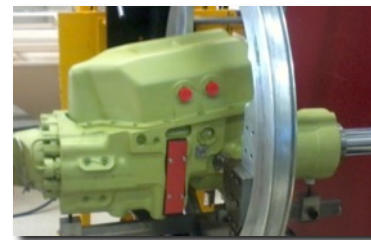

Shuttle Thrust Vector
Control Actuator



Shuttle Hydraulic
Recirculation Pump

Component Reuse Reduces Technical Risk LOX Prevalve Opportunity Testing Underway



◆ Reuse Opportunity

- Shuttle LOX Prevalve
 - Direct part reuse
 - Design reuse

◆ Challenge: Vibroacoustic environment

◆ Solutions

- Direct part reuse
 - Development test to validate direct part reuse
- Design reuse
 - Structurally enhanced prevalve

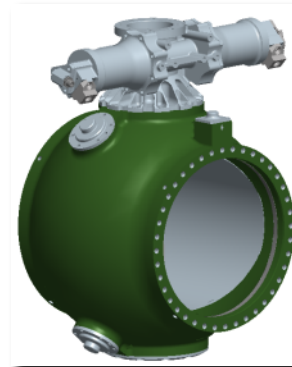

Design Reuse



Direct Part Reuse
(Testing In Work)



Prevalve with Test
Plate



Prevalve Bench
Testing on Common
Cryo Test Stand

Component Reuse Reduces Technical Risk

LH₂/LOX Fill and Drain Valve



◆ Reuse Opportunity

- Shuttle LH₂/LOX Fill & Drain Valve
 - Direct part reuse
 - Design reuse

◆ Challenge: Shock and random vibration loads

◆ Solutions

- Direct part reuse
 - Shock testing to higher SLS g-levels
 - Random vibration testing to SLS levels
 - Increase proof pressure testing
- Design reuse
 - More robust valve body for design reuse

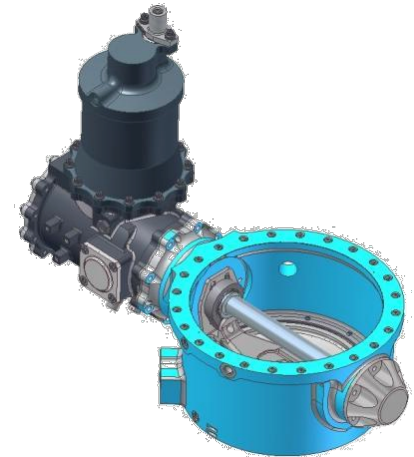

LH₂/LOX Fill & Drain Valve

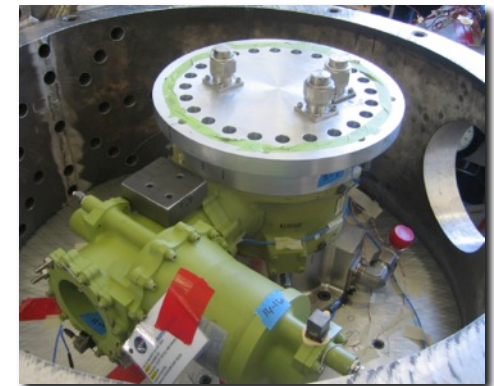

Fill & Drain Valve Test Setup

Component Reuse Reduces Technical Risk Tank Pressurization Valve (TPV)



- ◆ **Reuse Opportunity**
 - Delta IV Tank Pressurization Valve (TPV)
 - Design reuse

- ◆ **Challenges**
 - Engine Interface Control Document (ICD) GO₂ interface temperature
 - Maximum interface pressure

- ◆ **Solutions**
 - Design reuse
 - Seal material thermal and pressure testing
 - Non-metallic to metallic materials
 - Fixed orifice



Delta IV Pressurization
Solenoid Valve

SLS Core Stage On Track for 2017 Launch On-Cost, Ahead of Schedule, On-Target



Michoud Assembly Facility



Gore and Dome Weld Tools



Segmented Ring Tool



Vertical Weld Center

Milestone Reviews



Early Completion of SRR/SDR and PDR



Avionics

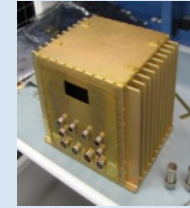

Flight Computers

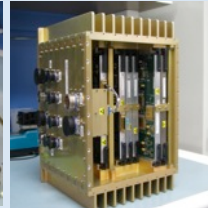

Lithium Ion Battery

Structures

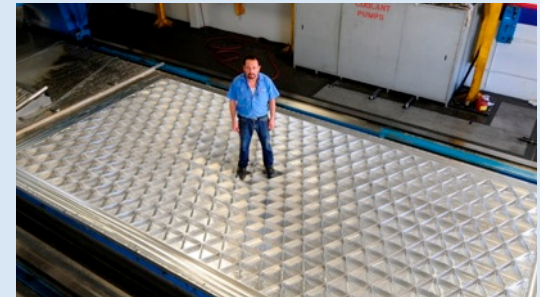

Barrel Panels

Propulsion



SLS Thrust Vector Control



Booster Development Challenges and Solutions

Ellis M. (Mat) Bevill
Boosters Deputy Chief Engineer
NASA Marshall Space Flight Center

Dale B. Nielsen
SLS Deputy Chief Engineer
ATK Space Systems

July 15, 2013

Space Launch System



- ◆ Opening Remarks
- ◆ RS-25 Engine
- ◆ Core Stage
- ◆ **Booster**
- ◆ Interim Cryogenic Propulsion System



- **Challenge:** SLS loads at Forward Separation Bolt exceed heritage loads
Solution: Separation bolt modified
 - **Challenge:** SLS Core Stage required attach ring movement 240 inches aft
Solutions: Tooling, processes, and non-structural hardware modifications
 - **Challenge:** Threat of Booster Separation Motor (BSM) seal debris to Core Stage Engines
Solutions: Utilize heritage seals from forward BSMs
 - **Challenge:** Nozzle After Exit Cone Joint closeout labor intensive, non-verifiable, and uses obsolete materials
Solutions: Replace backfill thermal barrier with thermal barrier O-ring
 - **Challenge:** SLS program cost reductions
Solutions: Multiple value stream mapping initiatives
- Future Challenges/Solutions:**
- **Challenge:** Ascent and liftoff loads reduce forward skirt safety factors
Solutions: Evaluate skirt modification options and structural testing to failure
 - **Challenge:** Acoustic load levels may exceed capability of avionics boxes
Solutions: Box isolation, relocation, additional testing options
 - **Challenge:** SLS thermal and structural ignition pressure loads exceed heritage thermal curtain capabilities
Solutions: Test, analysis, and potential curtain modification

SLS Booster Configuration (Block 1)

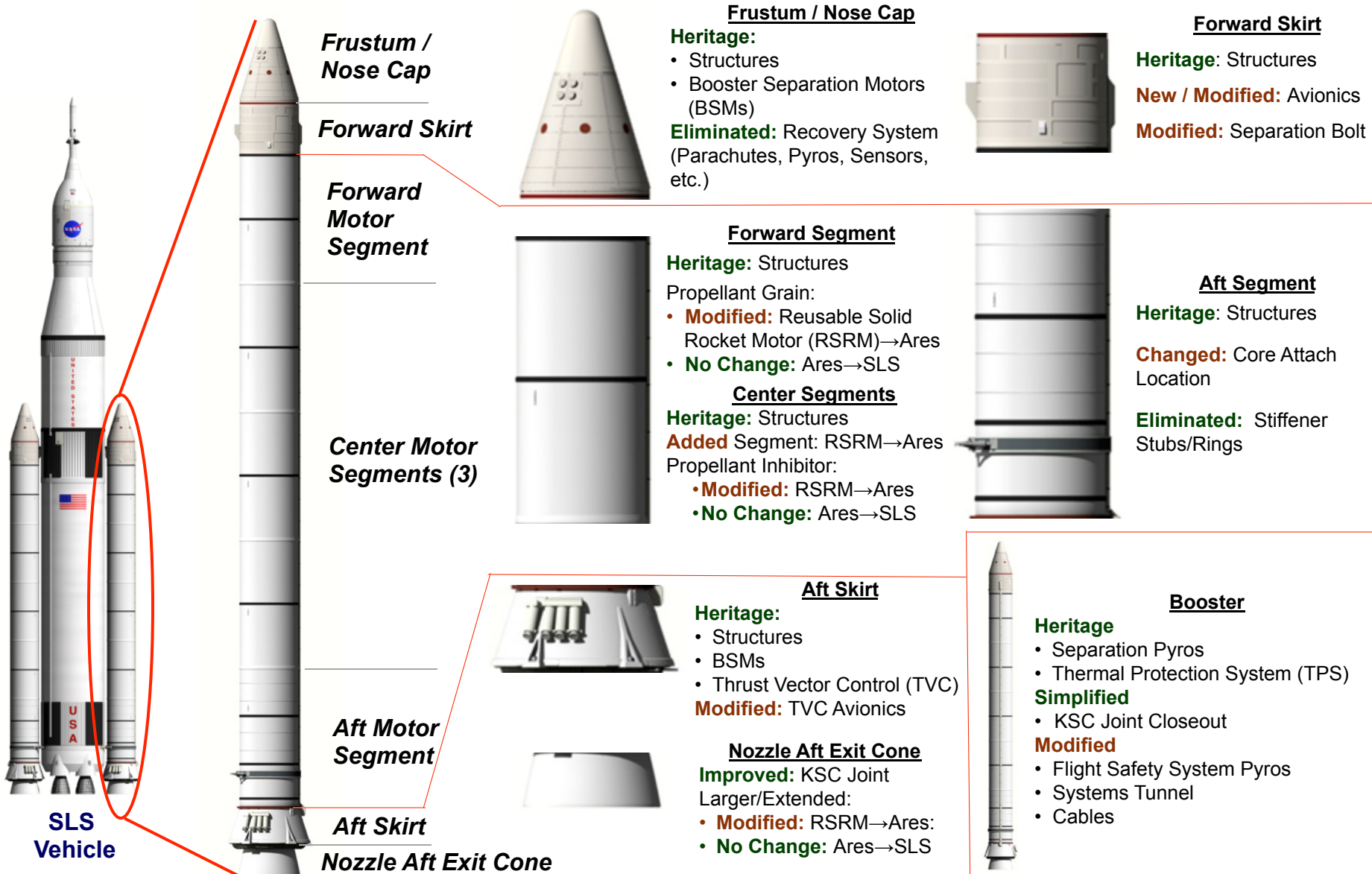

Heritage and Modified Hardware Utilized for Optimal Design

SLS Booster Performance Confidence



Space Shuttle SRB

Extensive Flight & Static Test Motor Experience Base



Number of RSRM Launched & Static Tested per Year

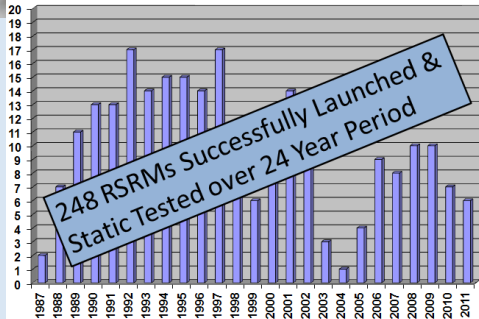

Ares 1st Stage

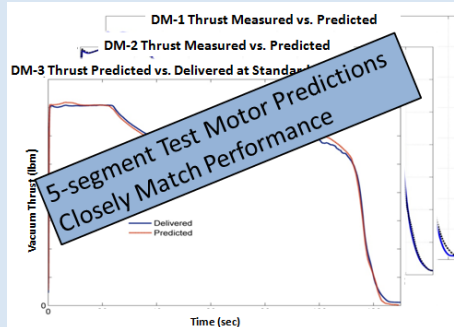

Excellent Prediction-to-Performance Correlation

SLS Booster

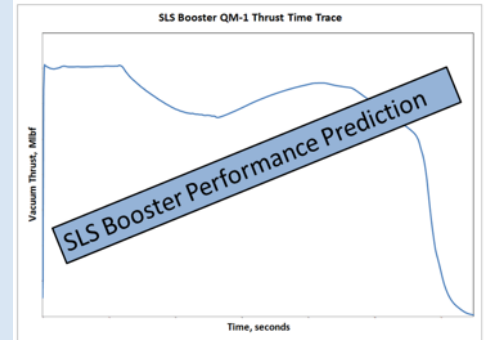

Assembly of Qualification Motor (QM) -1 Static Test

All Performance Parameters Well Within Specification Limits

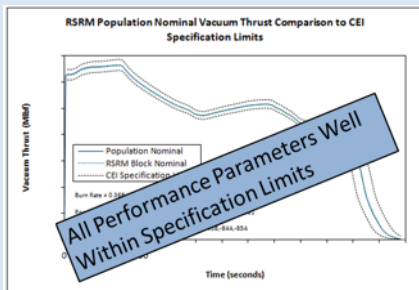

Demonstrated Performance Consistency Over Life of Program



Three Successful 5-Segment Development Motor (DM) Static Tests Conducted



QM-1 & QM-2 Static Tests & Experience Base Provide High Confidence SLS Boosters Meet All SLS Vehicle Needs

Design Challenges/Solutions: Loads & Configuration Driven



Forward Separation Bolt

Challenge: SLS loads at the Forward Separation Bolt exceed heritage Shuttle (STS) loads

Solution: Separation bolt modified to accommodate SLS loads

- Housing groove and pyrotechnic charge changes verified through testing

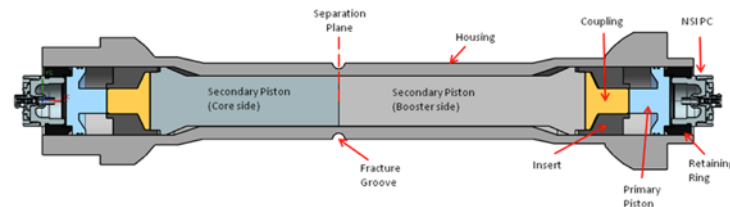

Challenge: SLS Core Stage required attach ring movement 240 inches aft (from heritage Shuttle ET location)

Solution: Tooling, processing, and non-structural hardware modifications (system tunnel, linear shape charge, etc.)

- Changes demonstrated on pathfinder aft segment build

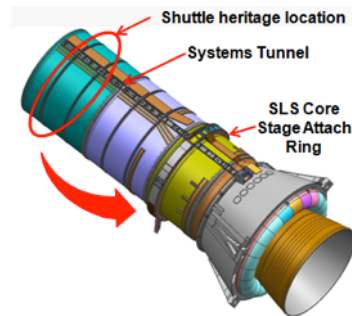

Core Attach Ring

Challenge: Threat of BSM seal debris impact to Core Stage Engines (at Booster separation)

Solution: Utilize (heritage) seals from forward BSMs.

- Forward BSM seal design does not liberate debris



Forward BSM Heat Seal

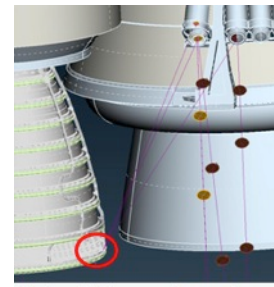

Potential Impact Zone from Current Aft Heat Seal

Aft Booster Separation Motors (BSMs)

Multiple Challenges Continue to be Successfully Addressed

Design Challenges/Solutions: Improvement Opportunities



Challenge: Nozzle Aft Exit Cone Joint (mated at Kennedy Space Center (KSC)) closeout labor intensive, non-verifiable, and utilizes obsolete materials

Solution: Replace backfill thermal barrier with thermal barrier O-ring

- Joint design reliability increase with significant simplification of KSC closeout

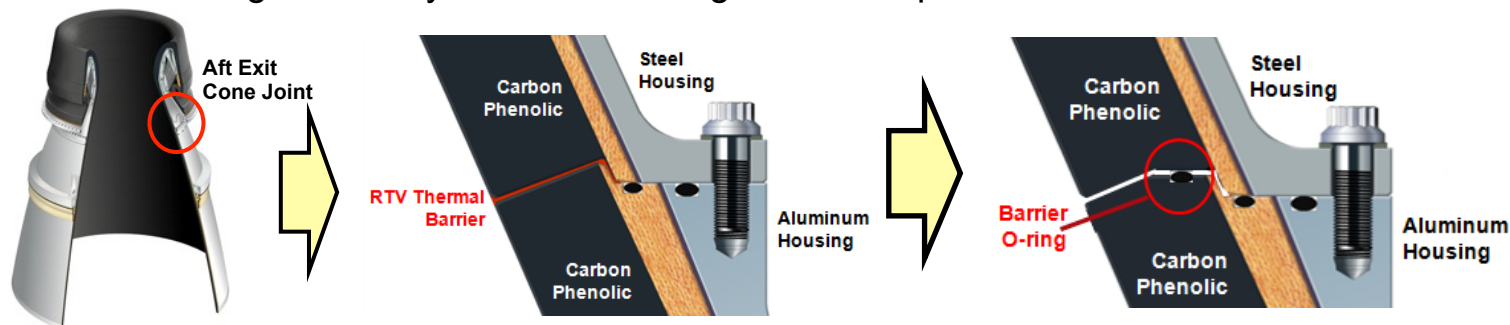

Challenge: SLS program to implement significant cost reductions over previous man-rated space flight programs

Solution: Multiple value stream mapping (VSM) initiatives result in ~46% reduction in SLS Booster production timeline

Nozzle Phenolic and Bondline Inspections

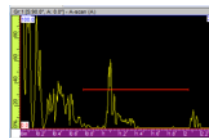
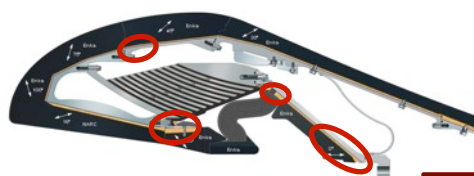

Practical Handling Improvements

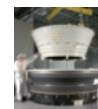

Relatively small implementation costs leading to substantial cost savings.

Booster Nozzle

Multiple Improvement Opportunities Incorporated

Future Challenges: Loads Driven



Forward Skirt

Challenge: Ascent and liftoff loads result in reduced forward skirt safety factors and potential thrust post yielding and/or panel buckling.

Solution: Evaluate skirt modification options and structural testing (to failure) for additional model correlation.

Challenge: Acoustic load levels may exceed capability of avionics boxes mounted near forward skirt thrust post.

Solution: Box isolation, relocation, or additional testing options being evaluated.

Challenge: SLS thermal and structural (ignition pressure) loads exceed heritage thermal curtain capabilities.

Solution: Test, analysis, and potential curtain modification options in work.

Thermal Curtain

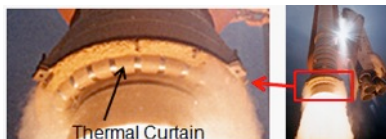

STS SRB Thermal Curtain

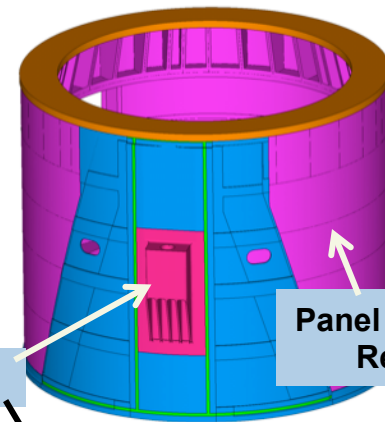

Thrust Post

Panel Buckling Region

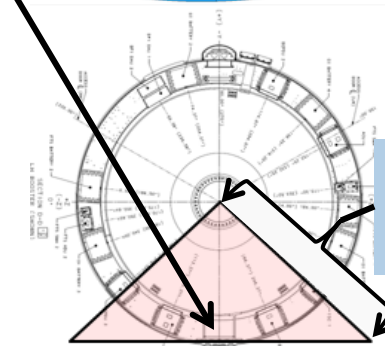

Acoustic Load Area of Concern



SLS Main Engine proximity to Booster Thermal Curtain results in increased loads (over SSME loads)

Technical Resolution Plans in Place to Address Challenges

Accomplishments: From Development to Qualification



Successfully accomplished 3 static tests to evolve and confirm motor configuration while providing technology maturation for next-generation systems

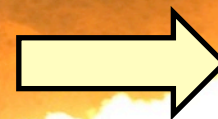

QM-1 & QM-2



◆ The 3 static tests demonstrated the robustness of the 5-segment design over the full range of potential operating conditions and in potential design configuration options:

- Propellant Mean Bulk Temperature (PMBT) ranging from 42 °F (DM-2) to 92 °F (DM-3)
- Field joint performance including cold joints (DM-2), hot joints (DM-3), and intentional channels (DM-2 and DM-3)
- Increased technical understanding and calibration of models from expanded instrumentation

The current 5-segment motor provides opportunity for expansion and further optimization to provide up to 130 metric tons of payload capacity.



Accomplishments: From Development to Qualification (Continued)



- ◆ Avionics system development and maturation support for SLS Vehicle simulation tests and full scale static tests (QM-1 & -2)

Subsystem level testing
Completed Sep 2011



Flight Controls Test 1
Completed Mar 2012

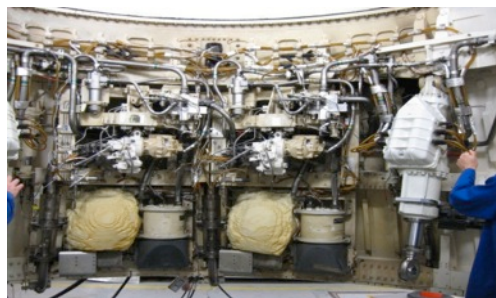

Flight Controls Test 2
Completed Feb 2013



- ◆ SLS Booster Element successfully completed the Preliminary Design Review (PDR) Board 2 April 2013
 - Integrated Booster development on target for CDR maturity

SLS Booster Element is postured for a successful CDR and the booster design is on track to support a 2017 SLS first flight.





Interim Cryogenic Propulsion System (ICPS) Challenges and Solutions

René Ortega

**Spacecraft and Payload Integration Office (SPIO) Chief
Engineer**

NASA Marshall Space Flight Center

July 15, 2013

Space Launch System



◆ Opening Remarks

◆ RS-25 Engine

◆ Core Stage

◆ Booster

◆ **Interim Cryogenic Propulsion System**



- **Challenge:** SLS vehicle design lateral loads imparted at liftoff and ascent mission phases

Mitigations

- For liftoff, incorporate T-zero stabilizer liftoff restraint and release, and additional system damping.
- For ascent, incorporate additional RL 10B-2 system damping and vehicle test derived aero-buffeting factors.

- **Challenge:** Implementation of NASA Technical Specifications and Standards could impact the configuration and construction of the ICPS departing from configuration/construction which has successfully flown over 20 flight.

Mitigations

- The SLS program tasked a team of experts to assess the risk associated with the use of the existing ULA design and construction methods for ICPS.
- The team of experts will make recommendations to the SLS/Program on what deviations/waivers and/or mitigations are to be use.

SLS Integrated Spacecraft and Payload Element (ISPE) Configuration (EM1)

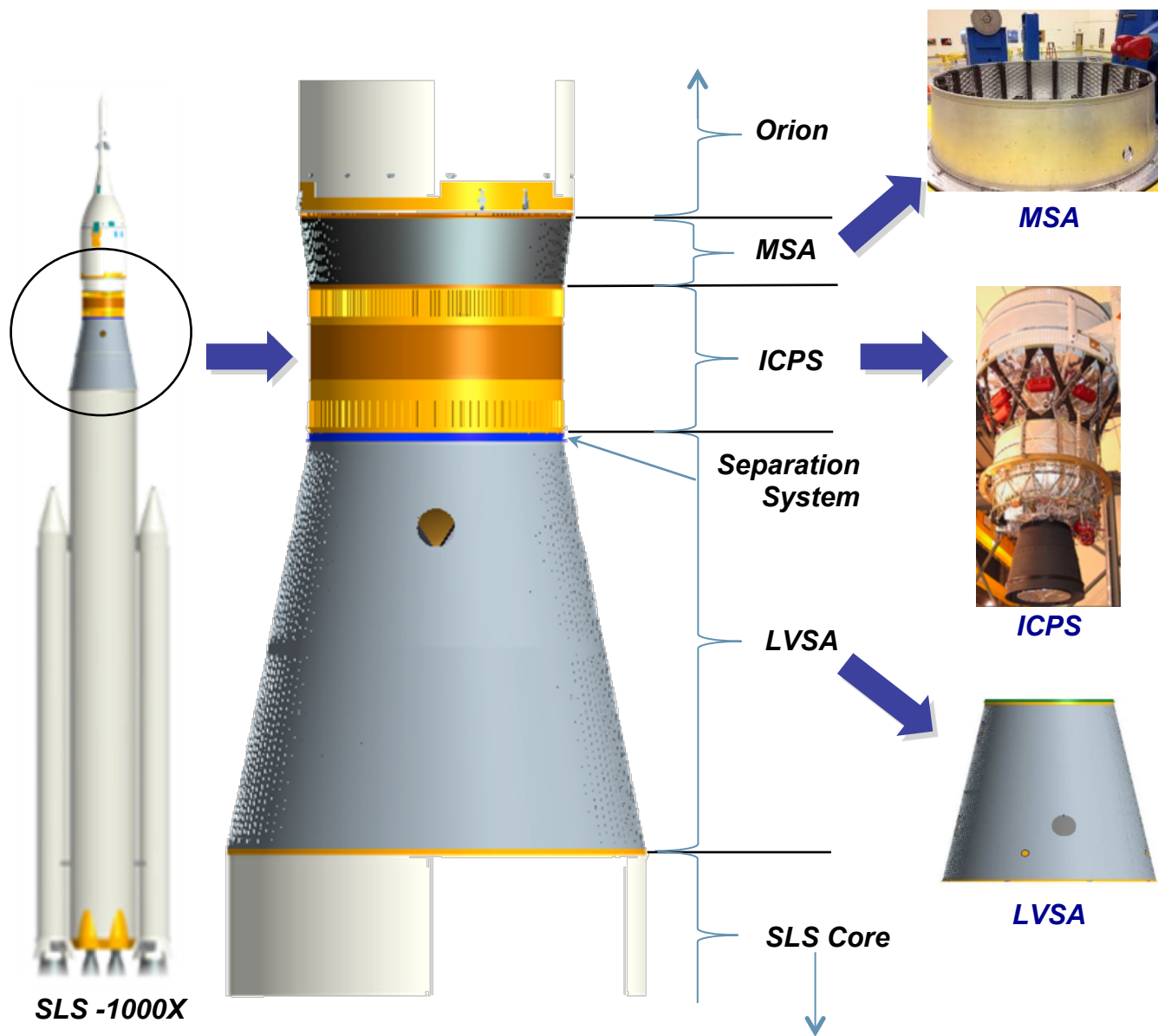

ISPE

- ◆ ISPE for SLS-1000X is comprised of the Multi-Purpose Crew Vehicle (MPCV) Stage Adapter (MSA), Interim Cryogenic Propulsion Stage (ICPS), Separation System, and the Launch Vehicle Stage Adapter (LVSA)
- ◆ Managed by the Spacecraft and Payload Integration Office (SPIO) at NASA/MSFC, AL

MSA

- ◆ Manufactured by NASA Engineering/MSFC, AL
- ◆ Connects ICPS to Orion adapter

ICPS

- ◆ Designed by Boeing/United Launch Alliance (ULA); ULA manufactured in Decatur, AL
- ◆ Modified 2016 production version of Delta Cryogenic Second Stage (DCSS) with RL10B-2 Engine
- ◆ Provides Perigee Raise and Trans-Lunar Injection and Disposal for EM1 & EM2

Separation System

- ◆ Manufactured by Chemring Energetic Devices/ULA
- ◆ Releases Orion/ICPS from SLS

LVSA

- ◆ Manufacturer TBD
- ◆ Connects ICPS to SLS and houses the separation system
- ◆ Preliminary design completed by NASA Engineering/MSFC, AL

Challenges Associated with Adapting Existing Delta IV Stage (DCSS) to the SLS ICPS



Delta IV
Cryogenic
Second
Stage
(DCSS)

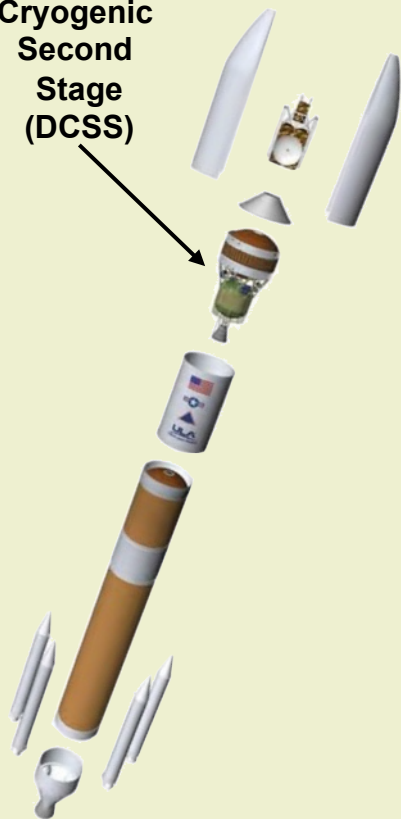

Delta IV

DCSS to ICPS Considerations

- Payload mass (Orion)
- Vehicle physical fit and orientation
- Vehicle design loads
- Performance requirements
- Acoustic Environments
- Thermal Environments
- Range Safety communication frequency
- State vector correction
- Vehicle Integration Ground Operations
- Launch Pad Operations
- Ground Systems Support
- Mission Operations Flow
- In-Space Guidance Commands
- Interface Requirements & Definition
- Human rating
- Safety Hazards Management
- Reliability Requirements
- NASA vs. Contractor Standards
- Protection of Intellectual Property
- Incorporation and reliance of ongoing DCSS Avionics updates

SLS Interim
Cryogenic
Propulsion Stage
(ICPS)

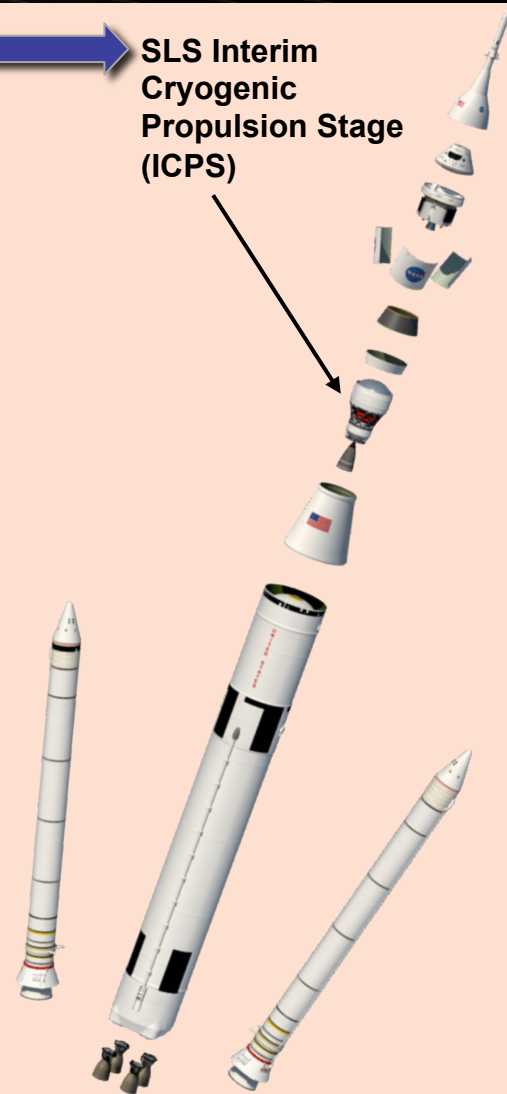

SLS-1000X

Major On-going DCSS to ICPS Challenges



◆ SLS vehicle design loads that meet the ICPS RL10B-2 Electro-mechanical actuator (EMA) and engine qualification limits

- Design iterations usually include loads reduction and hardware capability iterations. For ICPS, being mostly heritage hardware, capability design iterations are limited.

Challenge: SLS vehicle design lateral loads imparted at liftoff and ascent mission phases are challenging

- Liftoff lateral loads primarily driven by North/South winds
- Ascent lateral loads primarily driven by aero-buffeting

Mitigations for Design Cycle Iteration

- For the liftoff event, the SLS vehicle incorporated a T-zero stabilizer (liftoff restraint and release), and additional Boeing/ULA ICPS recommended system damping into the vehicle loads model.
 - Additional liftoff wind limitations may be considered in further iteration
- For the ascent event, the SLS vehicle incorporated the additional RL 10B-2 system damping and vehicle test derived aero-buffeting factors into the vehicle loads model
 - An SLS aero-buffets team continues to study potential for vehicle loads reductions
 - Potential additional ICPS mitigation include exploring additional damping from active electro-mechanical actuators (EMAs) and other more complicated options

In a typical conservatively-derived design cycle, loads decrease and capability improves as the design matures. The challenge with using heritage hardware is that the capability is mostly fixed.

Major On-going DCSS to ICPS Challenges (Continued)



◆ Implementation of NASA Technical Specifications and Standards for ICPS may result in costly redesigns for ICPS.

- The ICPS is a modification to the existing DCSS which was developed under United Launch Alliance (ULA) technical specifications and standards for commercial and military applications.
 - Intent was to implement modifications to a 2016 version of DCSS following contractor specifications.

Challenge: Implementation of NASA Technical Specifications and Standards could impact the configuration and construction of the ICPS departing from the basic DCSS configuration/construction which has successfully flown in Delta IV greater than 20 flights.

Mitigations

- The SLS program tasked a team of experts to review the related ULA and NASA Technical Specifications and Standards to assess the risk associated with the use of the existing ULA design and construction methods for ICPS.
- The team of experts will make recommendations to the SLS/Program on what deviations/waivers and/or mitigations are to be used for the ICPS design and construction standards.

Implementing NASA specifications while buying off-the-shelf type manufactured hardware results in a challenging specifications process

Future DCSS to ICPS Challenge



ICPS Interface Context Diagram

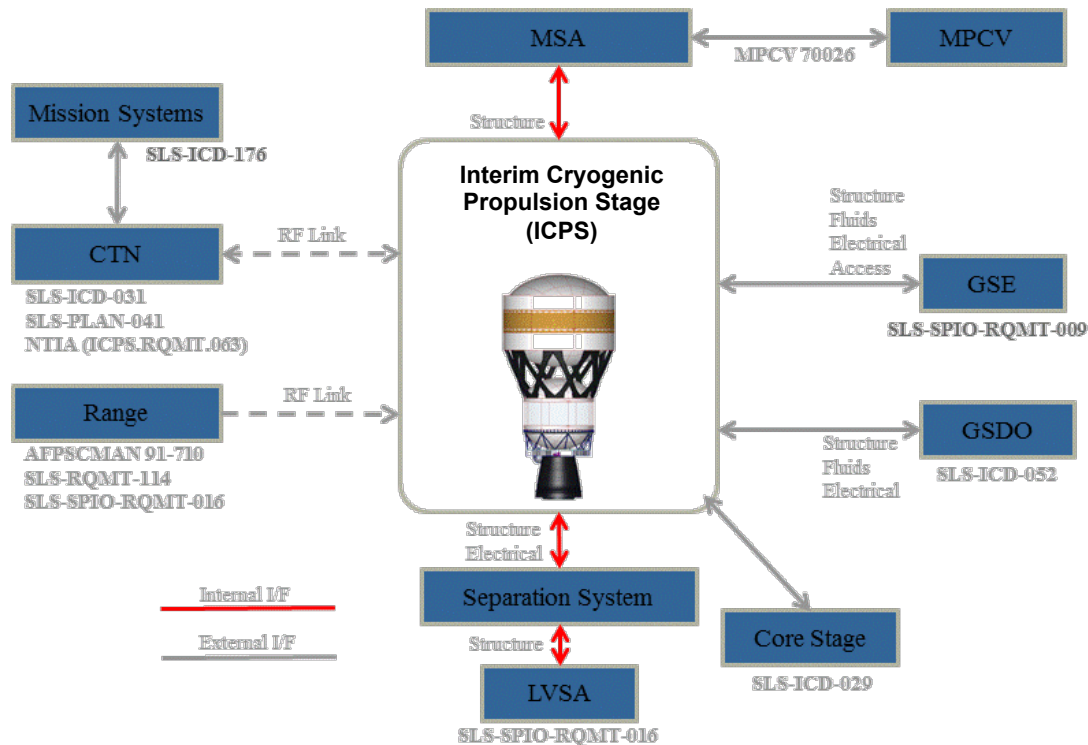

◆ **New and Existing ICPS Interface requirements mapping to the various SLS vehicle interface controlling requirements will require close detailed scrutiny as the design matures**

- Effort may be workforce intensive
- Involve various interface elements including SLS, Orion, Ground, SPIO, and Range
- Effort will require a detailed verification process

Large number of interfaces may result in a challenging validation and verification process.

Accomplishments

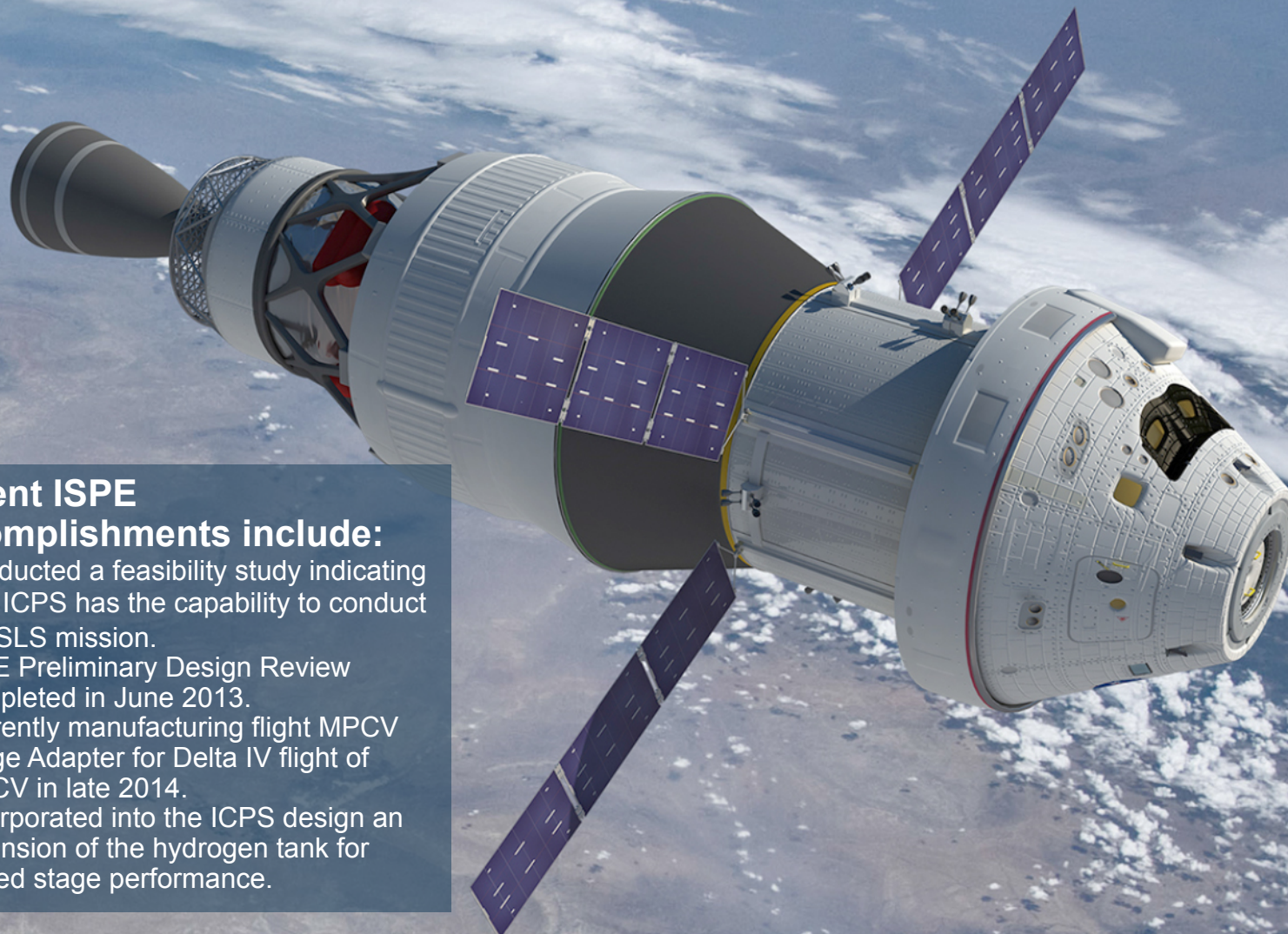
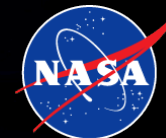

◆ Recent ISPE accomplishments include:

- Conducted a feasibility study indicating that ICPS has the capability to conduct the SLS mission.
- ISPE Preliminary Design Review completed in June 2013.
- Currently manufacturing flight MPCV Stage Adapter for Delta IV flight of MPCV in late 2014.
- Incorporated into the ICPS design an extension of the hydrogen tank for added stage performance.

SPIO has an experienced committed team working to resolve all challenges.

America's Rocket



www.nasa.gov/sls