

NASA/TP—2013-217818



NASA Glenn's Contributions to Aircraft Engine Noise Research

Dennis L. Huff
Glenn Research Center, Cleveland, Ohio

December 2013

NASA STI Program . . . in Profile

Since its founding, NASA has been dedicated to the advancement of aeronautics and space science. The NASA Scientific and Technical Information (STI) program plays a key part in helping NASA maintain this important role.

The NASA STI Program operates under the auspices of the Agency Chief Information Officer. It collects, organizes, provides for archiving, and disseminates NASA's STI. The NASA STI program provides access to the NASA Aeronautics and Space Database and its public interface, the NASA Technical Reports Server, thus providing one of the largest collections of aeronautical and space science STI in the world. Results are published in both non-NASA channels and by NASA in the NASA STI Report Series, which includes the following report types:

- **TECHNICAL PUBLICATION.** Reports of completed research or a major significant phase of research that present the results of NASA programs and include extensive data or theoretical analysis. Includes compilations of significant scientific and technical data and information deemed to be of continuing reference value. NASA counterpart of peer-reviewed formal professional papers but has less stringent limitations on manuscript length and extent of graphic presentations.
- **TECHNICAL MEMORANDUM.** Scientific and technical findings that are preliminary or of specialized interest, e.g., quick release reports, working papers, and bibliographies that contain minimal annotation. Does not contain extensive analysis.
- **CONTRACTOR REPORT.** Scientific and technical findings by NASA-sponsored contractors and grantees.

- **CONFERENCE PUBLICATION.** Collected papers from scientific and technical conferences, symposia, seminars, or other meetings sponsored or cosponsored by NASA.
- **SPECIAL PUBLICATION.** Scientific, technical, or historical information from NASA programs, projects, and missions, often concerned with subjects having substantial public interest.
- **TECHNICAL TRANSLATION.** English-language translations of foreign scientific and technical material pertinent to NASA's mission.

Specialized services also include creating custom thesauri, building customized databases, organizing and publishing research results.

For more information about the NASA STI program, see the following:

- Access the NASA STI program home page at <http://www.sti.nasa.gov>
- E-mail your question to help@sti.nasa.gov
- Fax your question to the NASA STI Information Desk at 443-757-5803
- Phone the NASA STI Information Desk at 443-757-5802
- Write to:
STI Information Desk
NASA Center for AeroSpace Information
7115 Standard Drive
Hanover, MD 21076-1320

NASA/TP—2013-217818



NASA Glenn's Contributions to Aircraft Engine Noise Research

Dennis L. Huff
Glenn Research Center, Cleveland, Ohio

National Aeronautics and
Space Administration

Glenn Research Center
Cleveland, Ohio 44135

December 2013

Acknowledgments

Thanks goes to the hundreds of people at the NASA Glenn Research Center who, have dedicated their professional careers to improving the quality of life near the world's airports by developing technologies for reducing engine noise since the early 1950s. What is often not obvious to the general public is the amount of time needed to conduct tests over multiple shifts, months, and years without taking breaks. The dedication of the test teams comes with a sacrifice to their personal and family lives. The analytical work has attracted the finest theoreticians in the world to either work directly at Glenn or to visit the Center to collaborate on cutting-edge research. Thanks also go to the academic and industry partners who have helped Glenn advance the state of the art by incorporating the technologies into their products.

Trade names and trademarks are used in this report for identification only. Their usage does not constitute an official endorsement, either expressed or implied, by the National Aeronautics and Space Administration.

Level of Review: This material has been technically reviewed by expert reviewer(s).

Available from

NASA Center for Aerospace Information
7115 Standard Drive
Hanover, MD 21076-1320

National Technical Information Service
5301 Shawnee Road
Alexandria, VA 22312

Available electronically at <http://www.sti.nasa.gov>

Contents

Summary.....	1
Introduction	1
History and Key Issues Overview	1
Early Years (The NACA).....	1
NASA.....	2
Noise Reduction Trends	2
Regulations.....	4
Facilities and Measurement Methods	4
Altitude Wind Tunnel.....	4
Engine Test Stands	4
Large-Scale Fan Rig.....	4
Hot Jet Rig.....	7
Engine Tests With ICDs.....	7
Anechoic Chamber for Fan Noise	8
9- by 15-Foot Low-Speed Wind Tunnel.....	8
The Aero-Acoustic Propulsion Laboratory	10
Flight Test Aircraft.....	12
Noise Prediction Methods.....	13
ANOPP Engine Modules.....	13
Rice Equations.....	13
Theoretical Aeroacoustics	13
Jet Noise Prediction Code (JeNo).....	13
RSI Fan Noise Code	14
Computational Aeroacoustics.....	14
Programs, Partnerships, and Impact	15
Turbojet Noise Reduction.....	16
Quiet Engine Program (QEP).....	16
Quiet, Clean, Short-Haul, Experimental Engine (QCSEE) Program.....	17
Refan Program.....	17
Quiet, Clean, General Aviation Turbofan (QCGAT) Program.....	18
Aircraft Energy Efficiency (ACEE) Program.....	18
Advanced Turboprop (ATP) Program	19
High-Speed Research (HSR) Program	20
Advanced Subsonic Technology (AST) Program	20
Aeroacoustics Research Consortium (AARC)	28
Quiet Aircraft Technology (QAT) Program.....	28
Fundamental Aeronautics Program (FAP)	30
Integrated Systems Research Program (ISRP)	32
Collaboration and Outreach.....	34
The Future	34
Concluding Remarks	35
Appendix—Acronyms	37
References	38

NASA Glenn's Contributions to Aircraft Engine Noise Research

Dennis L. Huff
National Aeronautics and Space Administration
Glenn Research Center
Cleveland, Ohio 44135

Summary

This report reviews all engine noise research conducted at the NASA Glenn Research Center over the past 70 years. This report includes a historical perspective of the Center and the facilities used to conduct the research. Major noise research programs are highlighted to show their impact on industry and on the development of aircraft noise reduction technology. Noise reduction trends are discussed, and future aircraft concepts are presented. Since the 1960s, research results show that the average perceived noise level has been reduced by about 20 decibels (dB). Studies also show that, depending on the size of the airport, the aircraft fleet mix, and the actual growth in air travel, another 15 to 17 dB reduction will be required to achieve NASA's long-term goal of providing technologies to limit objectionable noise to the boundaries of an average airport.

Introduction

Aircraft noise reduction was a research topic long before the NASA Glenn Research Center was established.¹ Fundamental studies on jet flows and propellers had been carried out at the NASA Langley Aeronautical Laboratory in Hampton, Virginia, when many of the senior researchers were transferred to Glenn. A close working relationship aimed at improving aircraft and engines continued between the two centers that still exists today. Glenn established itself as an air-breathing, and later a rocket propulsion center working on fundamental and applied research.

Throughout the entire history of Glenn, common themes for aeronautics research have been to increase efficiency and to reduce the environmental impact of aircraft engines. Aircraft noise is a quality of life issue near airports and noise regulations were established by, and are enforced by the U.S. Federal Aviation Administration (FAA) and the other member states

of the International Civil Aviation Organization (ICAO). According to a report from the ICAO Committee on Aviation Environmental Protection (CAEP), the purpose of noise certification is "to ensure that the latest noise reduction technology is incorporated into aircraft design demonstrated by procedures which are relevant to day to day operations, to ensure that noise reduction offered by technology is reflected in reductions around airports (Ref. 1)." Funding for noise research has varied depending on how important it was viewed compared to other research areas such as fuel consumption and emissions reduction. It became an important role for government since industry did not give priority to noise research and because it can take many years to realize benefits from investments.

This review provides a brief summary of the work done at Glenn on aircraft engine noise. More detail is given for recent years, but all of the major work that has been highlighted dates back to the beginning of the Center. Many of the Center's accomplishments required collaboration with industry, other government organizations, and universities. This review is focused on Glenn contributions, but much credit also needs to go to partnering organizations and the independent research done throughout the world. This review includes a historical perspective of the Center and the facilities used to conduct the research, including development of measurement methods, data analysis and analytical predictions. Major research program accomplishments are highlighted and show their impact on industry and aircraft noise reduction technology development. Noise reduction trends are discussed and some candidate future low-noise aircraft concepts are presented based on studies sponsored by NASA. Acronyms are defined in the appendix.

History and Key Issues Overview

Early Years (The NACA)

Under the NACA, Glenn focused primarily on engine performance research so that aircraft engines could operate at higher altitudes and faster speeds. During World War II, while Germany and Great Britain were developing the jet engine, the United States focused its research on piston engines and was significantly behind in the development of jet propulsion systems. When the war ended, the U.S. research emphasis changed from propellers and reciprocating engines to turbojet development.

¹The Center has had different names during its 70-year history. It began operating in 1942 under the National Advisory Committee for Aeronautics (NACA) as the Aircraft Engine Research Laboratory. The name changed to the NACA Flight Propulsion Laboratory in 1947 and to the NACA Lewis Flight Propulsion Laboratory in 1948. When the NACA became part of the new National Aeronautics and Space Administration (NASA) in 1958, the name changed to the NASA Lewis Research Center. Finally, the name was changed to the NASA John H. Glenn Research in 1999.

The first time that the media and public were allowed inside the gates of the Center, in June 1945, they were eager to learn more about jet engines. An excellent history book about Glenn (Ref. 2) states that visitors “experienced the earsplitting roar of a ramjet and other jet propulsion performances....” During this same time, Glenn obtained a V-1 “buzz bomb” from Germany to study and test. “The noise rattled the windows of nearby houses like that of the Guerin family, who lived in the valley below the laboratory [Glenn] on what is now the southwest portion of the laboratory property....” (This house was acquired later by Glenn and used for many social events.) Jet engine testing startled the residents surrounding Glenn and led to noise complaints that would impact tests at the Center for many years.

The author had the pleasure of communicating with Dr. Leo Beranek, a pioneer in acoustics, in 2006 when he was writing his autobiography (Ref. 3). Dr. Beranek wrote “I was in Washington, DC, on Wednesday, January 18, 1950, testifying before a congressional committee about aviation noise at military bases, when I was handed a note from my office. I must call the Director of the NACA Lewis Flight Propulsion Laboratory in Cleveland as soon as possible. He was frantic. At about midnight two days earlier,” he said, “the Laboratory had put into operation a new jet engine in a supersonic wind tunnel. The noise produced was so intense that switchboards in police and fire stations, radio stations, and public offices lit up nonstop with complaints from neighbors....”

That test facility was the 8- by 6-Foot Supersonic Wind Tunnel (8×6 SWT), built in 1949, and was testing a ramjet for the first time. According to Beranek what happened next put Bolt, Beranek, and Newman, Inc. (BBN), on the map. He was asked by Glenn to conduct sound measurements and to determine a way to quiet the tests so they could continue without community complaints. Glenn did not have any in-house expertise in acoustics at that time and had to rely on external contractors. BBN designed the world’s largest Helmholtz resonator by adding a concrete enclosure around the wind tunnel diffuser to reduce the 5- to 300-Hz range low-frequency noise. The low-frequency sound/vibration that propagated through the ground for miles turned out to be the source of the noise disturbances. The muffler that Dr. Beranek developed was successful and subsequently was used in a well-known acoustics textbook as an example for resonator muffler design (Ref. 4). Glenn resumed tests within 1 year without further complaints.

When turbojet-powered aircraft were introduced, airports around the world received many complaints about aircraft noise. Turbojet noise was very different from propeller-driven aircraft noise because it had a longer duration with a distinct low-frequency rumble. Glenn’s acoustic work started in the 1950s with noise research using the Altitude Wind Tunnel (AWT) and several full-scale engine test stands to evaluate nozzle suppressors. This was the beginning of acoustics research at Glenn.

NASA

During the 1960s, after Glenn became part of NASA, aeronautics research was reduced in favor of supporting the space program. Some of Glenn’s aeronautics researchers began working on solutions for rocket combustor instabilities, which also required expertise with unsteady fluid mechanics. By 1966, a significant portion of the technology development for Apollo spacecraft was completed and Glenn’s focus shifted back to aeronautics research. Air traffic was growing rapidly and more research was needed to address problems with airport congestion, noise, and pollution. Glenn concentrated on developing quieter engines and engines for short takeoff and landing (STOL) aircraft. Glenn researchers also worked on jet noise in support of the Supersonic Transport (SST) while Europe developed the Concorde aircraft.

During the 1970s, aeronautics research focused on developing technologies for fuel-efficient aircraft while acoustics research shifted away from turbofans and towards advanced, high-speed propeller noise reduction. Fundamental jet noise research to investigate screech, sonic fatigue, and flow injection to control jets was carried out as well as reducing helicopter transmission gear noise.

In the late 1980s, Glenn combined people performing aerodynamic and acoustics research into one branch recognizing there was an advantage to having aerodynamicists and acousticians working together to develop noise reduction technologies that could be incorporated into aircraft engines with acceptable performance. The scope of the work in the Acoustics Branch has included experimental and analytical research for propellers, turbomachinery (fans, compressors, and turbines), and jets.

The aeronautics research programs emphasized working on noise, emissions, and fuel burn together as a system. This approach helped bring multidisciplines together to look at new ways to solve problems. This was recognized in the late 1940s as important by one of Glenn’s most influential leaders, Dr. Abe Silverstein: “The use of panels to cross division and disciplinary lines was one of the distinguishing marks of Silverstein’s management style. By drawing talent from the entire laboratory, Silverstein encouraged greater flexibility and interaction between groups.” (Ref. 2).

Noise Reduction Trends

Engine noise has always been the major source of aircraft flyover noise levels. Primary sources of propeller-driven aircraft noise are blade thickness, loading noise, and engine exhaust. Blade thickness noise is the volumetric displacement of the air by the blade and the loading noise is associated with lift forces. Strategies to reduce propeller noise focus on decreasing the strength of these sources by reducing the propeller rotational speed and increasing the number of blades to reduce the aerodynamic loading per blade. Exhaust noise can be reduced by using mufflers, mixers, and decreasing exhaust jet velocity.

Turbofan engine noise sources include the fan, jet, core turbomachinery (compressor and turbine), combustor, and sometimes bleed valves. Fan noise can be reduced by decreasing the rotational speed and the fan pressure ratio (FPR). The nacelle enclosing the fan rotor and stator usually includes acoustic treatment (i.e., liners) to absorb the fan noise. Jet noise can be reduced by using mixing devices or by lowering exhaust velocity. Turbomachinery noise can be reduced by careful selection of the blade and vane numbers to prevent sound radiation; spacing blade rows to decrease interaction noise; and adding sound-absorbing acoustic treatment to duct walls. Combustion noise is usually not a major source on modern turbofan engines, but noise can be further reduced by adding Helmholtz resonators or by adjusting fuel injector staging.

In general, significant aircraft engine noise reduction has been realized by changing cycle parameters in a way that lowers jet exhaust velocities and lowers the pressure rise across the fan or propeller blades. Moving large amounts of air at lower velocities to provide the required thrust and increase propulsion efficiency, while meeting cruise speed and range requirements, is preferred. Turbojets have such a high exhaust

velocity that jet noise is the major noise source. This is why early researchers focused only on improving nozzle-mixer designs and suppressors. With the introduction of high-bypass turbofan engines, jet exhaust velocities were lowered, but the fan and jet noise still needed to be addressed. Small reductions in the jet velocity provide significant jet noise reduction (jet noise is proportional to the eighth power of the jet velocity). Figure 1 shows the overall aircraft noise reduction trends since the turbofan engine was introduced. Noise levels for several high-performance military aircraft and the Concorde are included to show what the noise levels would be if the jet exhaust velocities were not reduced. Noise reduction for supersonic aircraft presents a unique challenge since high exhaust velocities are needed for cruise and low exhaust velocities are needed for low noise at takeoff.

One of the engine parameters used to correlate engine noise is the bypass ratio (BPR). Increasing a turbofan engine BPR (ratio of the air mass flow through the bypass fan duct to the air mass flow through the core gas generator), has been shown to correlate with reduced engine noise. This is due to the reduction of jet exhaust velocities, lower fan rotational speeds, and lower blade loading associated with increasing BPR.

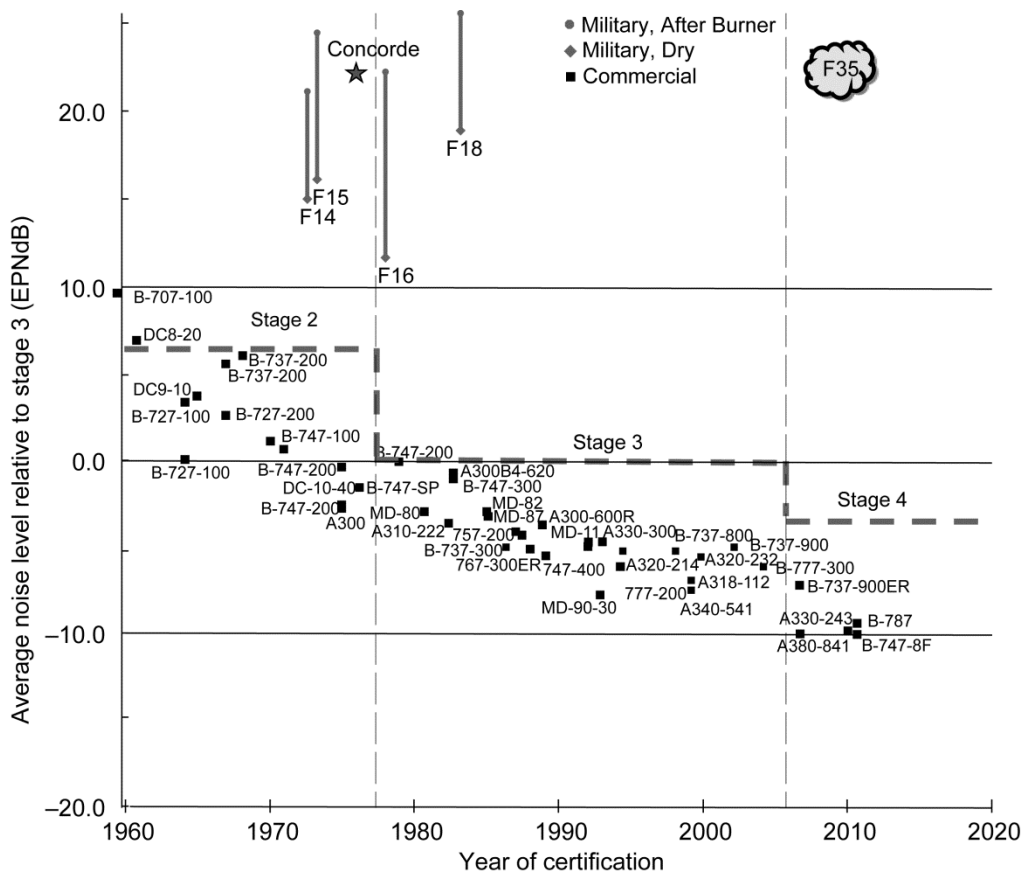

Figure 1.—Aircraft noise reduction trends.

Early turbofan engines had BPRs of about 1.5. Increasing the BPR has also helped reduce fuel burn due to higher propulsion efficiencies, but requires engine weight optimization as the engine diameter increases with increasing BPR. This synergistic relationship between noise and fuel burn reduction has led to even higher BPR engines with today's high-thrust engine values exceeding 10. Noise reduction technologies such as improved acoustic treatment and low-loss exhaust mixers, coupled with better knowledge of turbomachinery noise sources, and subsequent improved design methods have all helped reduce engine noise.

Regulations

Concerns about aircraft noise started shortly after airplanes first flew. An editorial from AERO magazine in 1911 entitled "On the Fitting of Silencers" noted that "the tremendous racket that is presently associated with the aero plane plays a considerable part in prejudicing the public against these machines." (Ref. 5). Hearings were held about noise during the 1940s, especially near military bases (see earlier discussion by Beranek (Ref. 3)). While noise from military jets was generally accepted as "the sound of freedom," commercial jet noise became a problem that peaked in the 1960s as the increasing number of flights and noise levels started to impact the quality of life near airports. Lectures at schools near airports were routinely interrupted by the roar of the jets.

In 1969, regulations were introduced to limit aircraft noise levels. The first noise regulation, called Stage 2, was introduced and is still enforced today by the FAA under Federal Aviation Regulations (FAR) Part 36. Specific guidelines were established for how to measure noise levels at three certification points called lateral (takeoff rotation at high engine power, also called sideline), takeoff flyover (also called cutback), and approach. Allowable noise levels vary with aircraft weight and the number of engines. The measured noise margins relative to the allowable levels are arithmetically summed across the three certification points to determine the "cumulative" noise reduction relative to the rule. More stringent Stage 3 regulations were introduced in 1977 and included a schedule to phase out noisier aircraft. In 1999, the United States joined the ICAO to coordinate aircraft noise internationally through the ICAO Annex 16 Noise Certification Standards. The terminology changed from Stage to Chapter, although the two are often used interchangeably. In 2006, Chapter 4 noise regulations were introduced (Fig. 1). Regulations are based on what is technically feasible and economically viable at the time as well as the need to reduce the impact of aviation noise on the community. NASA's role has been to help develop the needed technologies to reduce aircraft noise and provide independent technical assessments, but not to get involved with establishing regulations. Negotiations are currently being coordinated by the ICAO for the next level of noise requirements and NASA has participated as a member of Independent Expert Panels.

Facilities and Measurement Methods

Altitude Wind Tunnel

Under the NACA, noise suppressors were evaluated for turbojet noise reduction. The AWT, one of the first facilities at Glenn, was built to simulate high-altitude conditions. It shared refrigerated air capabilities with the Icing Research Tunnel and could simulate Mach 0.50 at 40 000 ft (12 192 m). The test section diameter was 20 ft (6 m) and a vertical strut was mounted to a turbojet engine with thrust measurement capability. Near-field measurements of several nozzle suppressors were taken (Ref. 6) to investigate jet noise reduction methods. Microphones were mounted on the strut. The facility was reverberant and noise was evaluated by near-field overall, relative sound level measurements for nozzle configurations. Figure 2 shows samples of noise suppressors installed in the AWT.

Engine Test Stands

Researchers recognized that jet noise directivity was important and testing in a reverberant tunnel was inadequate. An outdoor engine test stand was built to obtain free-field noise measurements that complemented the AWT results (Ref. 7). The test stand was located near the Cleveland airport away from other buildings (Fig. 3(a)). A moveable microphone was used to survey the near-field noise (Fig. 3(b)).

An aircraft with a turbojet engine was modified to perform near-field static jet noise tests of various nozzles. Thrust measurements were taken using a cable with a strain gage link. One of the more interesting tests was a slot nozzle that had a 100:1 aspect ratio. Results showed that the overall sound power level (PWL) was only reduced by 3 dB compared to a standard nozzle, but the directivity of the sound pressure level measurements varied by as much as 30 dB over the nozzle circumferential direction (Ref. 8). This was determined by rotating the nozzle from a horizontal position (Fig. 4(a)) to a vertical position (Fig. 4(b)). A jet flap nozzle was the intended application, as shown conceptually in Figure 4(c).

Large-Scale Fan Rig

A large-scale fan test rig was located next to the drive motor building for the 10- by 10-Foot Supersonic Wind Tunnel (10×10 SWT). A shaft was extended from the wind tunnel drive motors to a concrete pad with a polar array of microphones (Fig. 5(a)). Fans from the Quiet Engine Program (QEP) were tested there to help isolate fan noise sources. By testing the fan in isolation, no core or core jet noise could contaminate the fan acoustic spectra. Acoustic splitter rings mounted in the inlet were investigated to reduce inlet radiated fan noise (Fig. 5(b)). Although this facility was useful, reflection problems from the side of the building made data interpretation a challenge, so absorptive material was added on the side of the building.

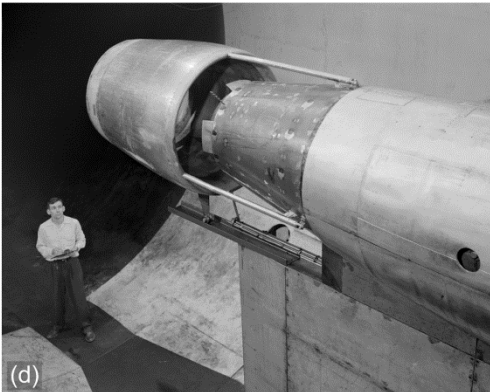
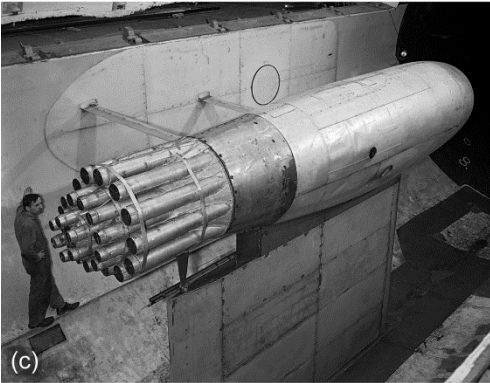
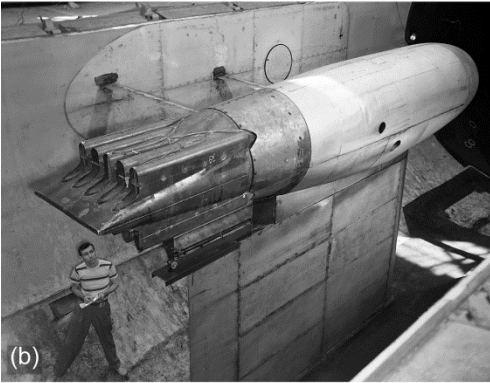
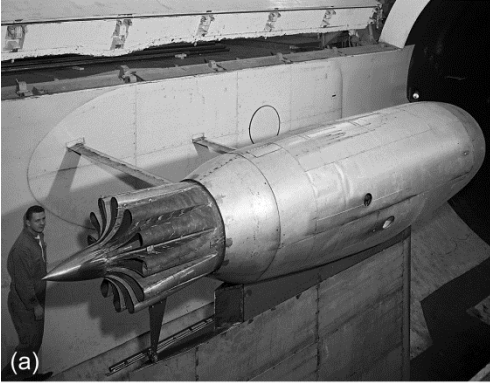

Figure 2.—Turbojet noise suppressors in the Altitude Wind Tunnel (AWT) in 1958.
 (a) Round. (b) Rectangular. (c) Multitube.
 (d) Mixer-ejector.

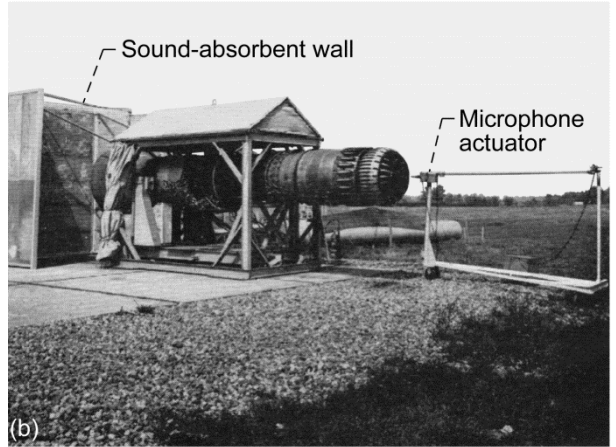
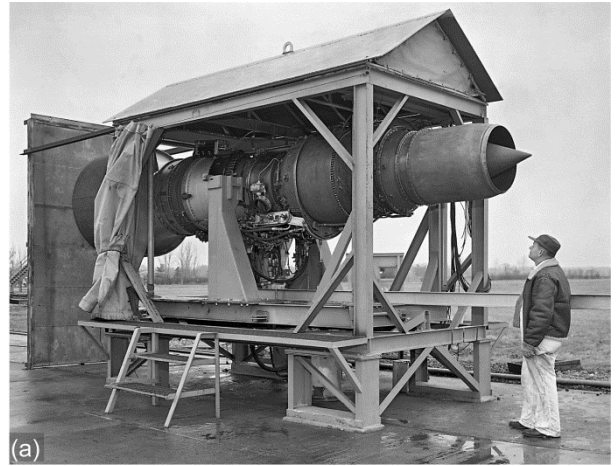

Figure 3.—Early engine test stand for free-field noise surveys. (a) Engine test stand. (b) Near-field microphone survey.

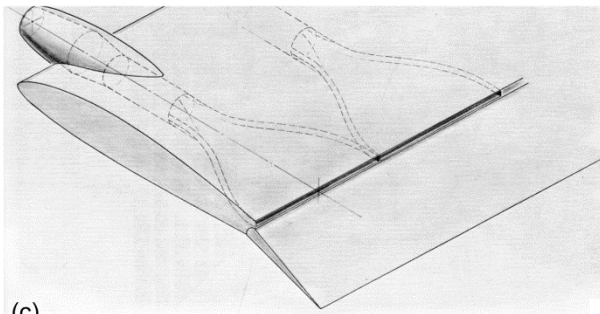

Figure 4.—100:1 aspect ratio nozzle test. (a) Horizontal. (b) Vertical. (c) Jet flap concept.

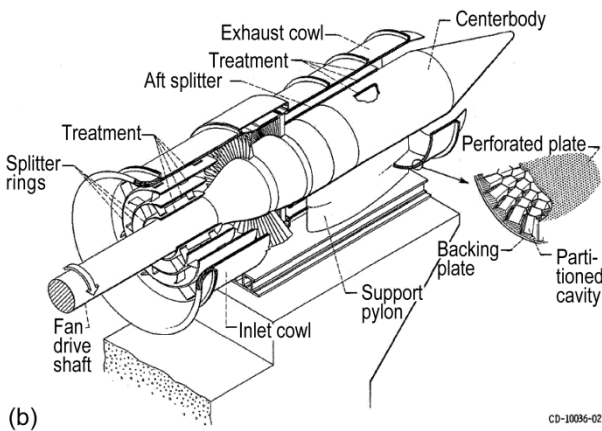
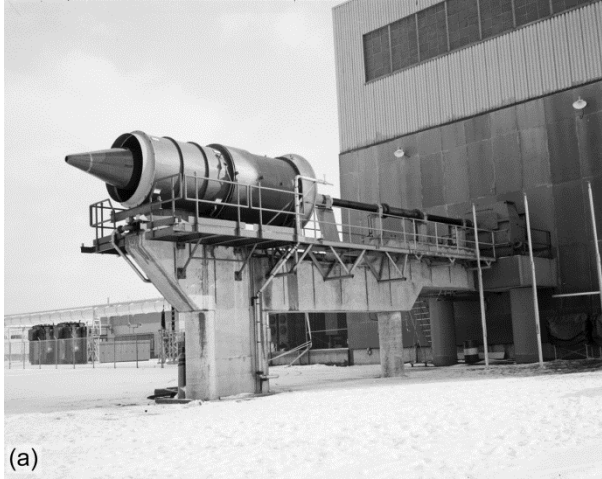
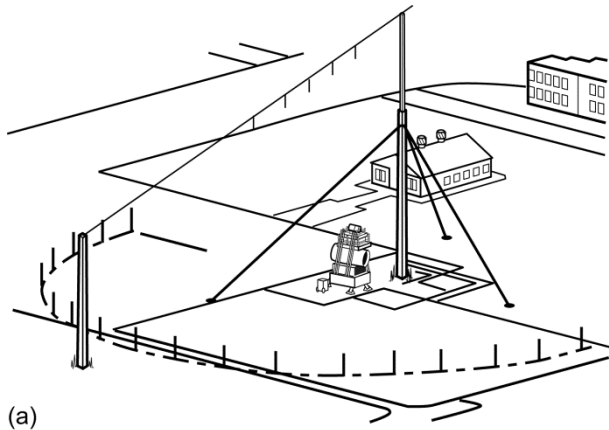

Figure 5.—Quiet Engine Program (QEP) fan tests. (a) Drive motor shaft. (b) Test hardware.

One of the lessons learned from this type of static testing was the importance of using an inflow conditioner called an inflow control device (ICD). Early static ground test measurements ingested vortices from the ground that were not representative of undisturbed inlet flow in flight. The ICD broke up inlet flow vortices and turbulence to better simulate fan noise under flight conditions. Static fan noise measurements that did not use an ICD produced extraneous fan tones and overestimated the fan noise (Ref. 9). An engine test stand was erected on the airport property next to the hangar (Fig. 6). An array of microphones was mounted on poles surrounding the engine for polar directivity measurements every 10°. The test stand supported the Quiet, Clean, Short-Haul, Experimental Engine (QCSEE) program (Ref. 10) and investigated high lift systems for the Short Takeoff and Vertical Landing program. Wing simulations could also be included to assess the noise from jets impinging on wing and flap systems. In addition to polar microphones, overhead microphones were used by suspending them on a cable between two poles.



(a)



(b)

Figure 6.—Outdoor full-scale Quiet, Clean, Short-Haul, Experimental Engine (QCSEE) tests. (a) Microphone array. (b) Engine test stand.

Hot Jet Rig

A large jet noise facility (Fig. 7) was built to test potential suppressors for the SST. The facility had instrumentation to set the nozzle temperature and pressure ratio, and far-field microphones to measure directivity. The nozzle, shown in Figure 7(a), called the divergent lobed suppressor, reduced jet noise by 12 PNdB. Many other nozzles were tested and screened for further testing in other facilities that could simulate forward flight and measure nozzle performance. The SST program was cancelled before the nozzles could be refined

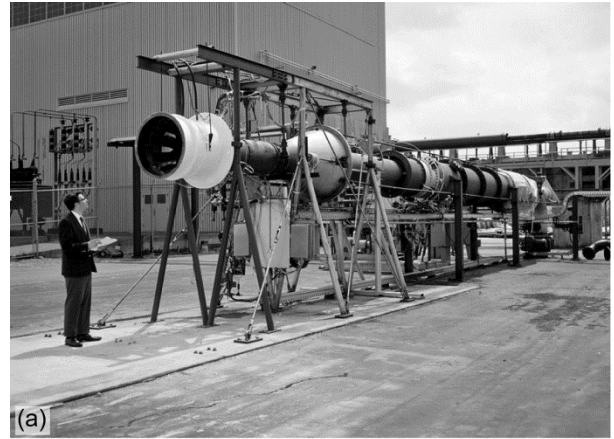

(a)

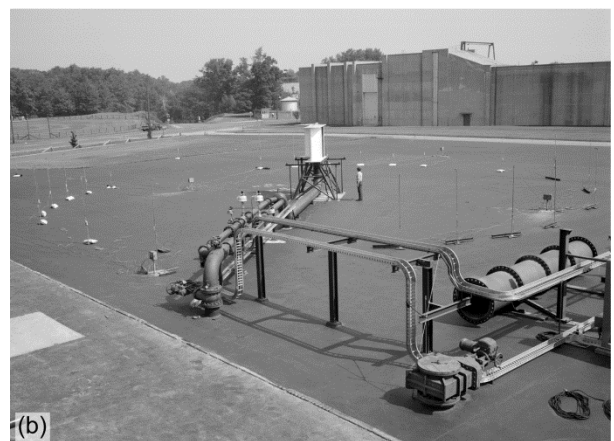

(b)

Figure 7.—Hot Jet Rig. (a) Divergent lobed suppressor. (b) Blown flap with augmentor wing.

for flight applications. Blown flap tests were done where a nozzle was placed near an augmentor wing (Fig. 7(b)) to assess the jet and impingement noise for STOL aircraft applications (Ref. 11). A combustion noise rig, located next to the hot jet, shared the microphone arena.

Engine Tests With ICDs

Smaller engines could be tested on the Vertical Lift Fan facility (Fig. 8). The JT15D, YF-102, TF-34, and engines from the Quiet, Clean, General Aviation Turbofan (QCGAT) program were tested on this stand for noise evaluations. Engines could be fitted with ICDs and large mufflers mounted to the exhaust to separate jet noise and engine turbomachinery noise. Polar microphone arrays were standard for engine tests and were also used for this facility. Circumferential rings of microphones surrounding the exhaust exit plane, semi-infinite tubes with microphones attached to the combustor, and far-field microphones were correlated using coherence methods to develop combustion noise empirical models. This facility was useful for engine source diagnostics experiments aimed at better understanding of the noise generation mechanisms.



Figure 8.—Outdoor engine facility with JT15D test engine and inflow control device (ICD).

Anechoic Chamber for Fan Noise

Inlet noise levels for 20-in.- (51-cm-) diameter model fans were measured in an anechoic chamber in the Engine Research Building (Fig. 9(a)) (Ref. 12). Acoustic treatment was added to the walls, floor, and ceiling to make the chamber anechoic. An exhaust collector drew the air out of the test cell while an electric motor powered a model fan. An ICD was used to control the inlet flow (Fig. 9(b)), and microphones were arranged on an arc in the test cell to measure the fan noise. Aft-radiated fan noise measurements were not possible in this facility. Aerodynamic performance measurements were made on the same fans in another test cell.

9- by 15-Foot Low-Speed Wind Tunnel

The 9- by 15-Foot Low-Speed Wind Tunnel (9×15 LSWT) was added in the return leg for the 8×6 SWT in the late 1960s. Acoustic treatment was added to the 9×15 LSWT test section so that propeller (Fig. 10(a)) and fan (Fig. 10(b)) acoustic tests could be done with the proper flight simulation. Acoustically treated boxes were added with perforated metal face sheets on the wind tunnel wall and dissipative material inside the boxes to absorb sound. Airflows in the test section could reach speeds of about Mach=0.22. Simultaneous measurement of inlet- and aft-radiated noise allowed tone interference to be determined in the near field, and was useful for noise prediction validation.

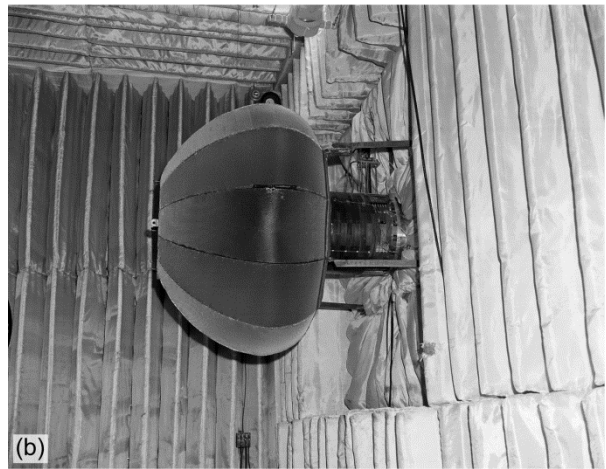
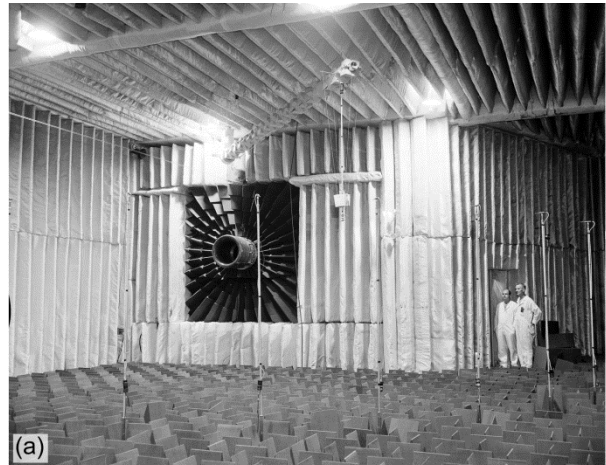

Figure 9.—Anechoic chamber for inlet fan noise measurements. (a) Microphone array. (b) ICD.

The 9×15 LSWT has been used for many years to evaluate new turbofan and turboprop designs. The fan and nacelle models look like small engines that typically scale between 1/3 and 1/6 depending on the application, and included multiple components such as the fan stage, inlet, nacelle, nozzle, and sometimes a powered core that simulates the compressor booster stage (Fig. 10(b)). Propeller research investigated highly swept blades for increasing cruise speeds beyond conventional turboprops. It was important to measure both the aerodynamics and acoustics so a complete assessment of noise reduction concepts could be made along with performance penalties. Force balances were used to measure axial thrust and torque. For ducted-fan configurations, a calibrated bell mouth and variable area nozzle were added to measure fan operating maps (Fig. 10(c)). Microphones have been placed at various locations over the years including mounted to walls, on a traverse, and on a ring to obtain circumferential directivity. Advanced flow measurement methods such as laser Doppler velocimetry (LDV), particle image velocimetry (PIV), and hot-wire (HW)

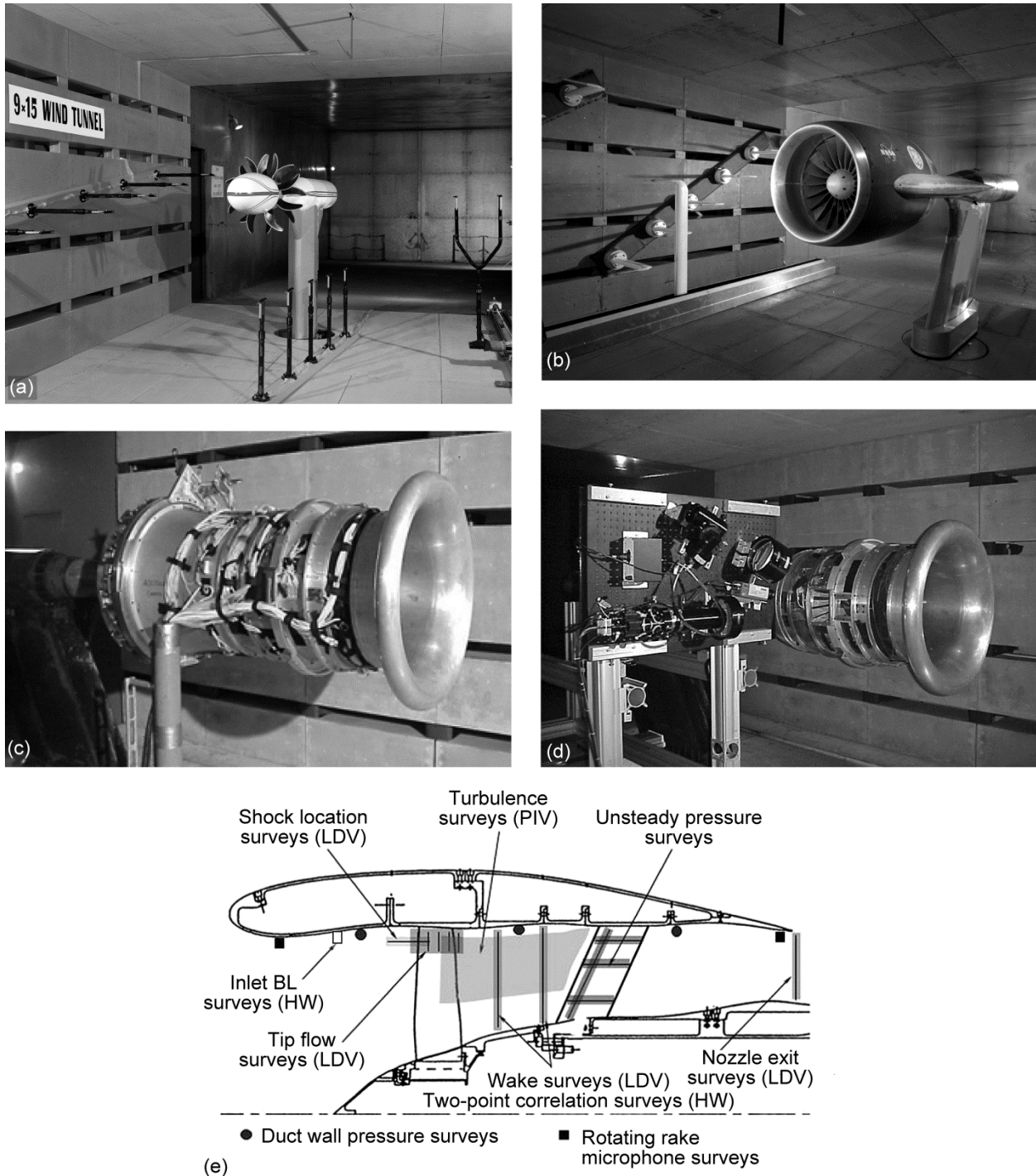

Figure 10.—Model tests in the 9- by 15-Foot Low-Speed Wind Tunnel (9x15 LSWT). (a) Counterrotation propfan, acoustic configuration. (b) Ducted fan, acoustic configuration. (c) Aerodynamic configuration. (d) Laser Doppler velocimetry. (e) Suite of flow and noise measurements.

anemometry have been used to measure blade wakes, boundary layers, turbulence, and other important flow features needed to understand noise generation (Figs. 10(d) and (e)). Phased microphone arrays have been used to help locate noise sources. A barrier wall extending from the test section floor to the ceiling was added to isolate the inlet and aft-radiated noise when needed.

Another measurement method developed in the 9×15 LSWT was called the rotating microphone rake system (Ref. 13) (Fig. 11(a)). The original idea was conceived by Pratt & Whitney (P&W), but it was developed and tested for the first

time at Glenn. Acoustic duct modes associated with fan noise are measured by separating the circumferential and radial orders of the spinning modes to take advantage of a Doppler shift when the measurements are taken in relative frames of reference. Previous methods used a fixed probe that made it impossible to separate the fan modes from the modes caused by the wake of the probe interacting with the fan. The results were useful for validating fan noise prediction and propagation methods. The rotating microphone rake system built and tested on a Honeywell TFE731 engine at their San Tan test facility in Arizona is shown in Figure 11(b).

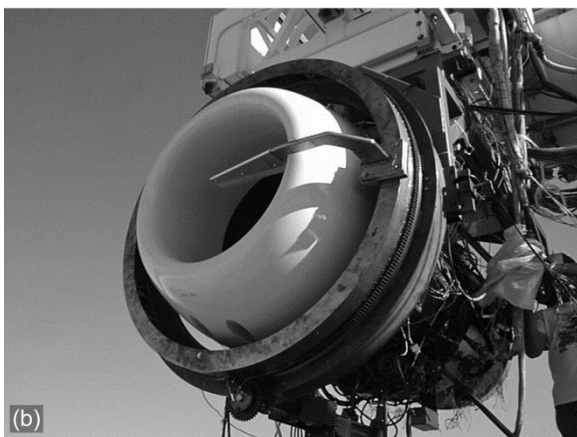
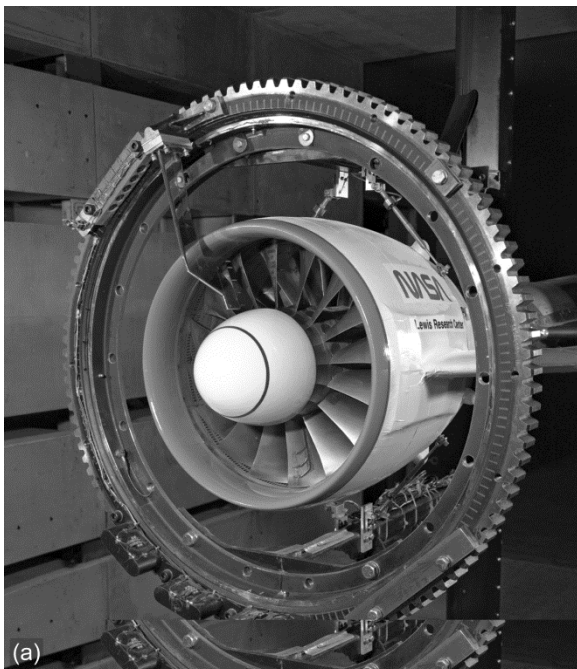

Figure 11.—Rotating microphone for fan inlet acoustic mode measurements. (a) Test in the 9×15 LSWT. (b) Honeywell engine test.

The Aero-Acoustic Propulsion Laboratory

The Aero-Acoustic Propulsion Laboratory (AAPL) (known as the Dome) was built in 1991 to protect the residential community on the south and west sides of Glenn from noise produced from the Power Lift Facility and a new jet facility being built for the High-Speed Research (HSR) program called the Nozzle Acoustic Test Rig (NATR). The original concept was to use noise barrier walls, but engineers realized that enclosing the entire area with a 130-ft- (39.6-m-) diameter geodesic dome was better at containing noise and protecting test equipment from the weather. This same area was the location of the Hot Jet Rig during the 1970s, where many test runs were cancelled due to bad weather or noise complaints. The AAPL interior walls were covered with acoustic wedges and the large far-field microphone distance was ideal for jet noise research. Currently there are several test facilities located inside the AAPL (Fig. 12).



Figure 12.—Aero-Acoustic Propulsion Laboratory (AAPL).

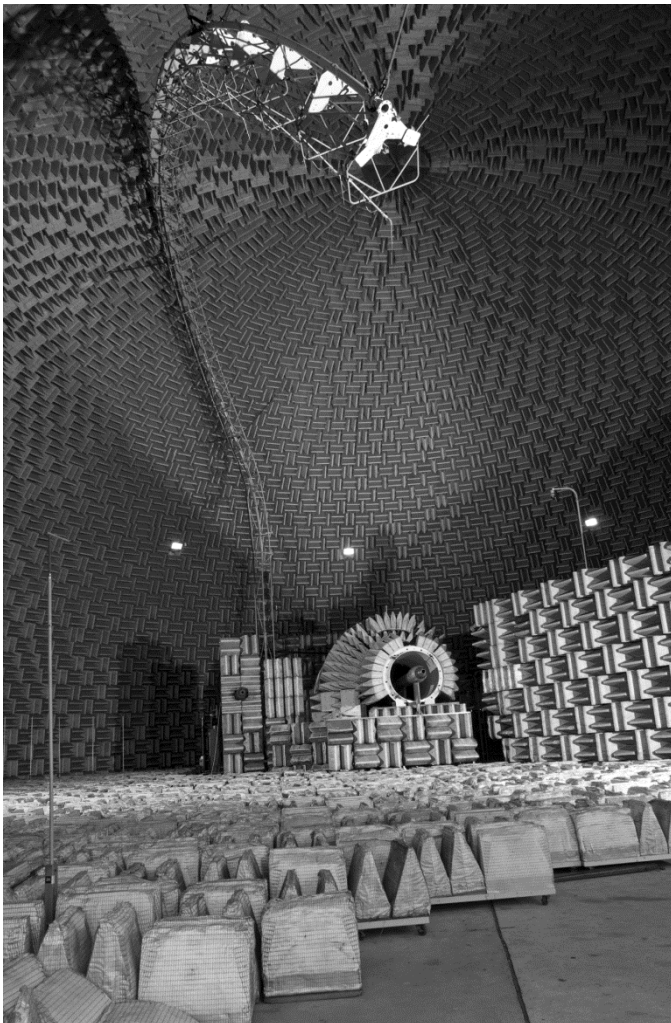

Figure 13.—Nozzle Acoustic Test Rig (NATR).

The NATR (Fig. 13) was used extensively by the Advanced Subsonic Technology (AST) and HSR programs for jet noise research. Its 53-in.- (135-cm-) diameter free jet simulates forward flight for takeoff and landing ($M \sim 0.30$). Recall that earlier Glenn facilities did not include this important feature. Early jet noise suppressors that showed significant noise reduction under static conditions were much less effective under flight conditions therefore it was important to simulate flight to truly assess the effectiveness of jet suppressor designs. The NATR has been used mostly for acoustic and flow diagnostic measurements. Single-, dual-, and three-stream exhaust flows can be tested at temperatures up to 1425 °F (774 °C). Since industry relied on ASE FluidDyne for nozzle thrust measurements, NASA commonly sent the nozzles to the FluidDyne facility once a good nozzle configuration was identified. This added to the credibility of the results and expedited the transfer of technology to industry. The first successful test of chevron nozzles was completed in the NATR in 1997. Phased microphone arrays, LDV, PIV, and a large traverse for temperature and pressure measurements have been used to help characterize the flow and acoustics for nozzles tested in the NATR. In addition, pioneering research has been done using PIV to measure turbulence (Fig. 14) and phased microphone arrays to locate the noise sources.

A smaller jet rig called the Small Hot Jet Acoustic Rig (SHJAR) was added to the AACL to test smaller nozzles and because it would be less expensive than testing in the NATR. The SHJAR (Fig. 15), comparable to university facilities, provided a way to directly compare test results and screen concepts before more expensive tests were undertaken in the NATR. It also provided an anechoic test environment to test nozzles from other Glenn facilities where fundamental physics and flow control experiments were performed. A simple thrust measurement method used by an earlier small jet facility in the 1970s was implemented on the SHJAR to provide first-order thrust measurements.

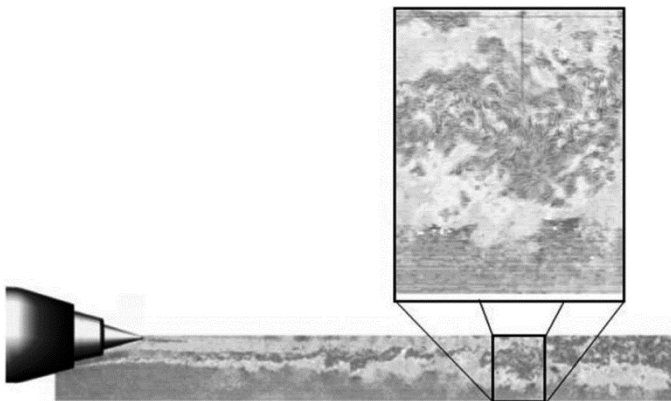

Figure 14.—Jet turbulence measurements using particle image velocimetry (PIV).

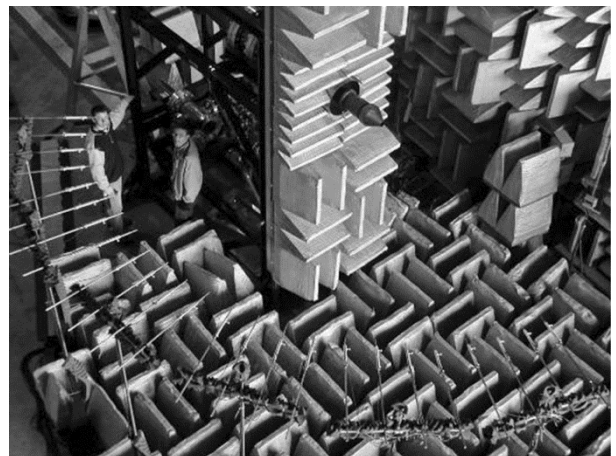

Figure 15.—Small Hot Jet Acoustic Rig (SHJAR).

The Advanced Noise Control Fan (ANCF) rig (Ref. 14) was initially added to the AAPL (Fig. 16(a)) to study active noise control (Fig. 16(b)). This rig was used in many test programs that studied acoustic liners and fan noise generation fundamentals. A rotating microphone was embedded in the nacelle for duct mode measurements. The rotor could be tested in isolation or with stators that could be moved or changed easily within the duct. HW anemometry and microphone array measurements complemented the far-field microphone measurements. The ANCF could be moved in the AAPL using air pads so the far-field microphones could be shared with NATR.

Flight Test Aircraft

Glenn had several aircraft that supported acoustics research. The OV-10 Bronco (Fig. 17) was used for propeller noise research. Researchers investigated controlling the relative position of the two propellers to reduce cabin noise (active noise control).

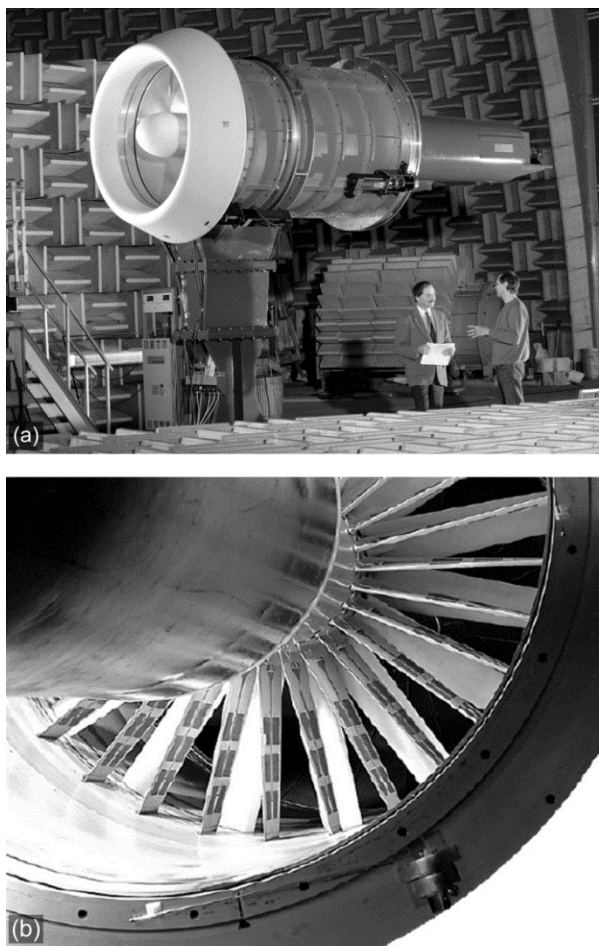

Figure 16.—Advanced Noise Control Fan (ANCF) rig. (a) Installation in the AAPL. (b) Array of actuators mounted in stator vanes for active noise control (inlet with ICD and fan are located behind the stators).

A Lear 25 aircraft (Fig. 18(a)) powered by General Electric (GE) CJ610 turbojet engines was used as a chase plane for near-field flight measurements of propeller noise from the GE Unducted Fan (UDF) and the Lockheed Propfan Test Assessment (PTA) aircraft. The UDF was installed on a Boeing 727 and an MD-80 in the late 1980s to validate the propfan concept. Pilots from Glenn flew the Learjet around the UDF with a boom microphone mounted on the wing to measure propeller tones. The measurements reinforced earlier 8×6 SWT wind tunnel data. In 2000, the Learjet was modified with chevron nozzles to investigate jet noise reduction (Fig. 18(b)).



Figure 17.—OV-10 Bronco test aircraft.

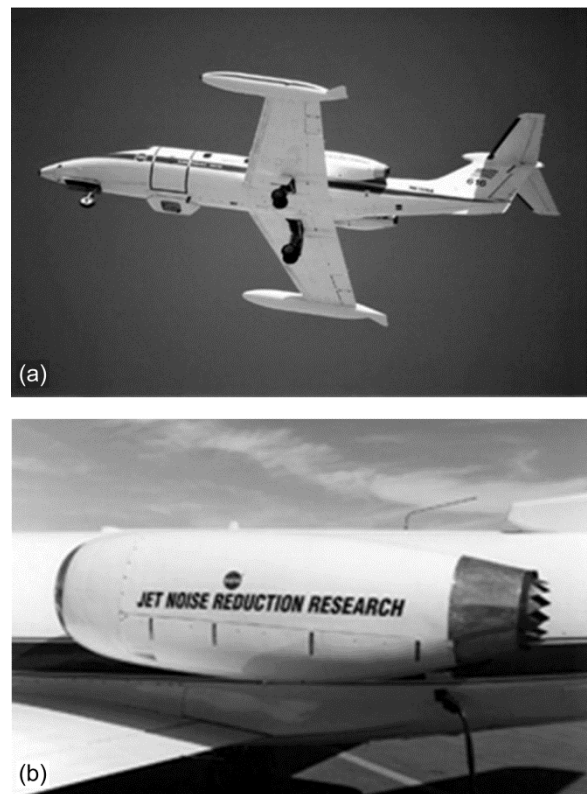

Figure 18.—Learjet test aircraft. (a) Flyover for acoustic measurements. (b) Chevron nozzle.

Noise Prediction Methods

ANOPP Engine Modules

The Aircraft Noise Prediction Program (ANOPP) was initiated at Langley in 1973 to develop a computer program for predicting aircraft system noise. A need developed to evaluate benefits from noise reduction research programs that could be used by the government for independent analyses. Glenn took responsibility for the engine modules by developing empirical and semiempirical prediction methods. The jet, core, fan, and turbine noise models were developed in-house based on data from NASA and industry. Reports for the engine noise modules (Refs. 15 to 18) were designated “interim” but the final reports were never written. This turned out to be appropriate since the modules have been continuously updated and improved using data from newer engines. The jet noise modules have been updated several times as the noise sources have become better understood. Tests sponsored by Glenn revealed that using an inverted velocity profile for coannular nozzles reduces jet noise. (An inverted velocity profile occurs when the outer flow stream velocity is greater than the primary core flow stream.) The jet noise modules were modified based on source distribution assumptions that helped provide insight into the physics (Ref. 19) and further refinements were made as more data became available from various engine tests (Ref. 20). This module is still used today for empirical jet noise prediction in ANOPP and is referred to as the “Stone Jet Noise” code. The fan noise module by Heidmann was updated for modern fans and is also used today (Ref. 17).

Rice Equations

When fan noise research started at Glenn in the 1970s, analytical methods were pursued in conjunction with experimental work to provide physical insight. There was an observation that each fan duct spinning mode (mentioned earlier for rotating microphone development), has a unique directivity pattern in the far field. Experimental data from the QEP was used to show that the directivity could be predicted assuming equal energy per mode (Ref. 22). Dr. Edward Rice observed that acoustic modes with similar cutoff ratios also had similar directivity patterns (Ref. 23). Cutoff ratios determine whether or not fan duct modes within a given frequency (i.e., tone) are propagating or decaying. When all modes within a given tone (e.g., blade passing tone) are decaying, the tone is considered cut off. Rice developed an approximation for predicting the far-field directivity of fan noise using the cutoff ratio, duct geometry, and simple flow parameters. Theoretical calculations based on the Wiener-Hopf method were considered the benchmark for comparisons with other prediction methods. Figure 19 (Ref. 24) shows how well the Rice approximations compare to the theory. Rice also recognized that the optimum impedance for acoustic treatment could be correlated with cutoff ratio (Ref. 25).

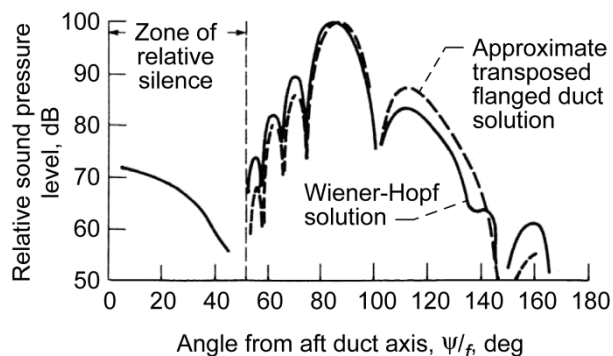

Figure 19.—Fan noise directivity prediction using Rice equations.

A method for designing acoustic liners for fan ducts was developed by Glenn. P&W and other engine companies used the method to predict the far-field sound levels for their engines and to design acoustic treatment. Computations took much less time than methods that directly computed sound propagations. The acoustic treatment research initially done at Glenn moved to Langley, where it still resides today.

Theoretical Aeroacoustics

One publication from Glenn that stands out for the guidance provided to many noise prediction methods (Ref. 26) first came out as a NASA Special Publication, and was later published as a book by the McGraw-Hill Company in several different languages. Dr. M.E. Goldstein derived fundamental equations for aeroacoustics starting with classical acoustics and adding the effects of mean flow, solid boundaries, compressibility, nonuniform flow, and the direct calculation of sound. Portions of the work build on Lighthill’s famous acoustic analogy. The equations have been used throughout the world to develop fan and jet noise prediction codes.

Jet Noise Prediction Code (JeNo)

Early methods to predict jet noise from first principles were only relevant for round jets. Acoustic analogy methods based on Lighthill’s theory were popular, but approaches based on Lilley’s formulation of the convective wave equation showed promise for being more computationally efficient. The problem was divided into first determining the mean flow and then radiating source terms in the governing equations using an appropriate Green’s function. NASA further developed this approach using computational fluid dynamics (CFD) to define the mean flow and turbulence, modify source terms, and develop a Green’s function for nonaxisymmetric nozzles (Ref. 27).

A recent noise prediction assessment compared the Stone Jet Module in ANOPP and the JeNo code (Ref. 28) to experimental data taken at NASA’s jet noise facilities. Neither model predicted all of the test cases within the

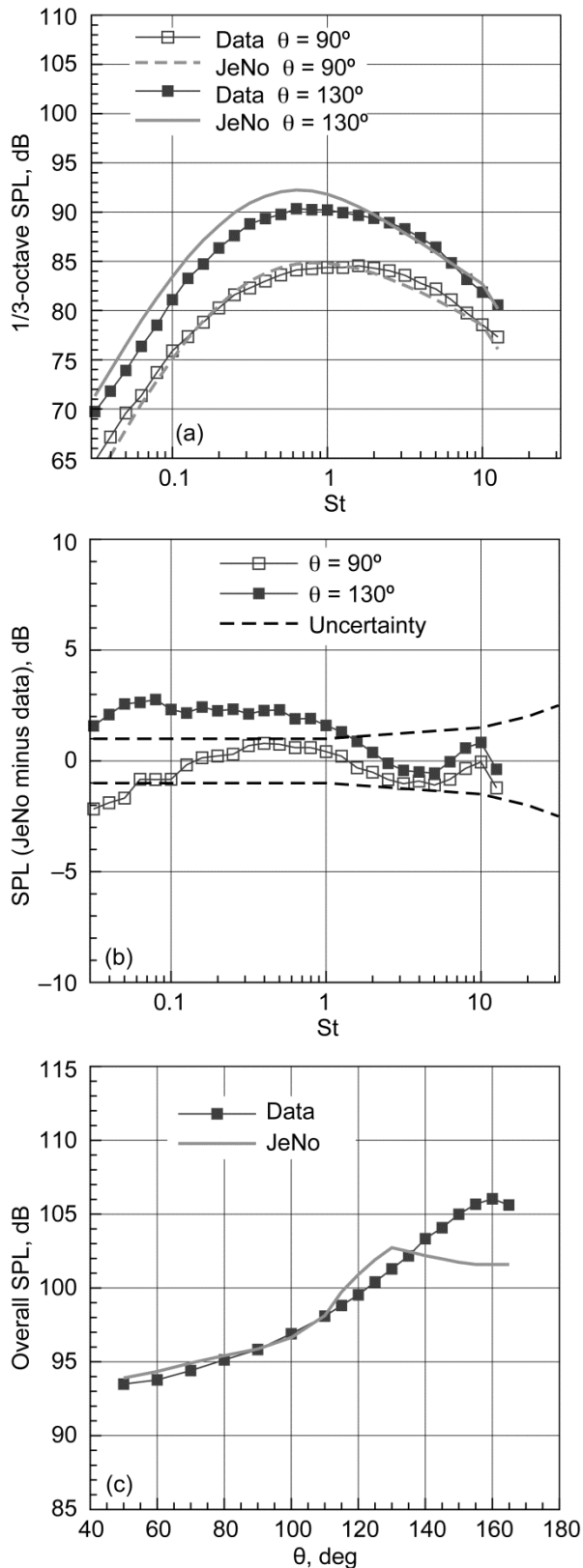

Figure 20.—Cold subsonic jet predictions. (a) Sound pressure level (SPL). (b) SPL (predicted minus data). (c) Overall SPL directivity.

experimental uncertainties. Component effective perceived noise level (EPNL) predictions could be off by several decibels using the Stone Jet module. Acoustic spectra and directivity were predicted accurately by JeNo for cold subsonic jets (Fig. 20), but they were less accurate for hot, high-speed jets (Fig. 21). Sample predictions compared to experimental data were also presented for nonaxisymmetric cases like chevrons and offset nozzles. While there had been great improvement in jet noise prediction methods that include geometry and mean flow, considerable work was still needed in cases where flows became more complex.

RSI Fan Noise Code

Glenn developed the Rotor-Stator Interaction (RSI) fan noise prediction code based on an acoustic analogy approach (Ref. 29). Several tone prediction methods were developed with companies under contracts with Glenn. The methods included coupling between the inlet, fan, stator, and bypass nozzle. Tone levels for fans had been reduced to the point where emphasis was placed on the development of fan broadband noise prediction. The RSI code has been used for broadband noise prediction using CFD input for mean flow and turbulence parameters, and solving for the unsteady response on stator vanes to simulate the interaction with a turbulent fan wake. Total duct PWLs were computed and compared to experimental data. A recent fan noise prediction assessment compared the RSI code accuracy to experimental data from the 9×15 LSWT (Ref. 30). The assessment showed that the RSI code could predict fan broadband noise within 4 dB of the experimental uncertainty band (gray bar) based on total PWLs over a range of frequencies (Fig. 22). Other contributions to fan noise such as rotor alone would need to be computed using a different code. The assessment also compared predictions from ANOPP and the LINFLUX code, developed in the 1990s, as a computational approach based on the linearized Euler equations. The error was larger when more sophisticated prediction codes were compared to the empirical methods.

Computational Aeroacoustics

Computational aeroacoustics (CAA) are numerical methods for direct computation of sound and are distinguished from CFD used for predicting aerodynamics. When CAA is fully developed, it will be the ultimate prediction method for describing sound sources and propagating acoustic waves through complex flows and to the far field. NASA has been instrumental in supporting pioneering work in CAA. Langley sponsored the first CAA workshop on Benchmark Problems in 1994. Two of the three subsequent workshops were hosted by Glenn and held at the Ohio Aerospace Institute (OAI) in 1999 (Refs. 31 and 32). NASA researchers defined model problems that have analytical solutions for comparisons with CAA predictions. Figure 23 shows one of the benchmark problems

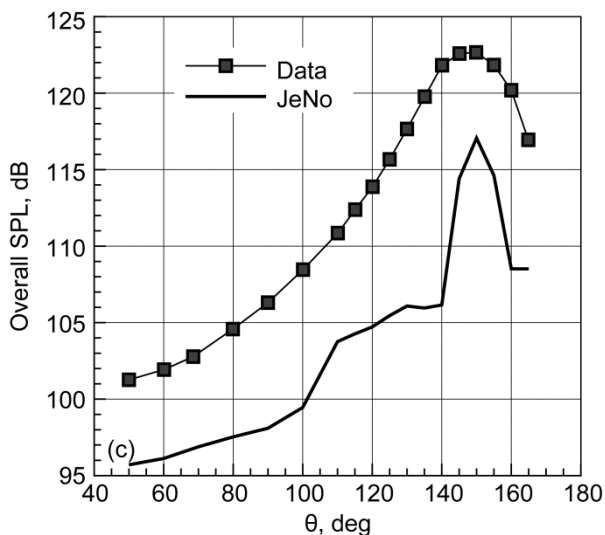
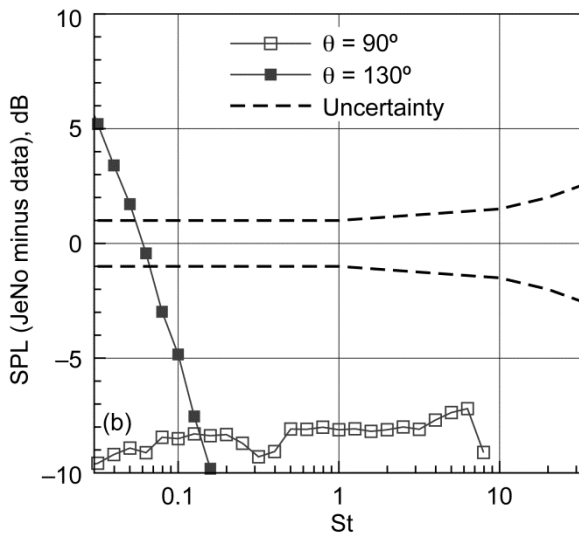
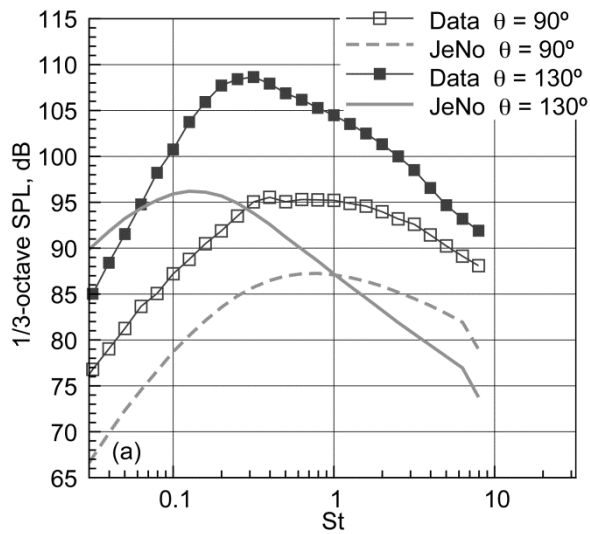

Figure 21.—Hot high-speed jet predictions: (a) SPL. (b) SPL (predicted minus data). (c) Overall SPL directivity.

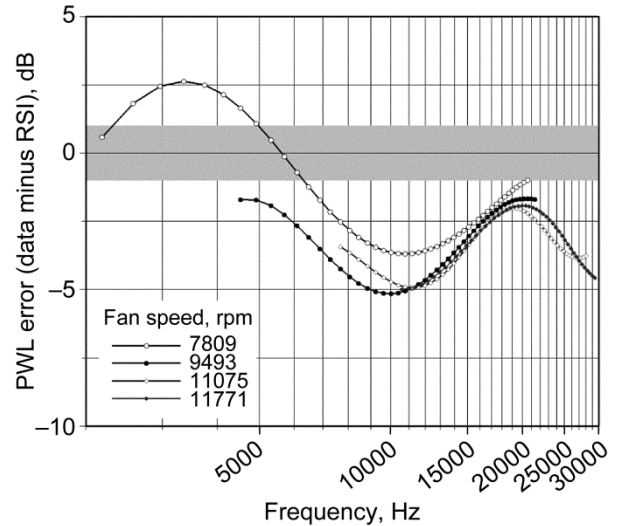

Figure 22.—Fan broadband noise prediction using Rotor-Stator Interaction (RSI) code for various rotational speeds. Gray shaded regions shows experimental error.

posed by Dr. Edmane Envia to compute the unsteady pressure response of a stator cascade interacting with a blade wake simulating the third harmonic of the blade passing frequency. Perturbation pressures are shown in Figure 23(a), and perturbation velocities are shown in Figure 23(b). The problems were presented as “blind” test cases and participants, both U.S. and international, were invited to test their latest CAA algorithms for comparisons with each other and with the theory. Each workshop showed improvements with methods and computational efficiencies. CAA is still an active research topic and, depending on the application, it could take many years before it can be applied to real life situations. CAA does hold promise, however, for currently being able to predict noise from aircraft and engines with arbitrary geometry and flow conditions. ANOPP, while very useful, is limited to predicting noise from aircraft and engines similar to past applications. NASA intends to develop ANOPP2 that will begin to incorporate CAA methods as they mature.

Programs, Partnerships, and Impact

As noted by Dawson (Ref. 2), Glenn has always struggled with finding its role between fundamental research and the need to show progress through practical applications. World War II forced the Center to work on specific projects in response to national security needs. After the war, Glenn returned to basic research on engine components, and restructured the organization into corresponding divisions and branches. New programs and projects focused on specific goals, provided funding, and led with industry through contracts and partnerships.

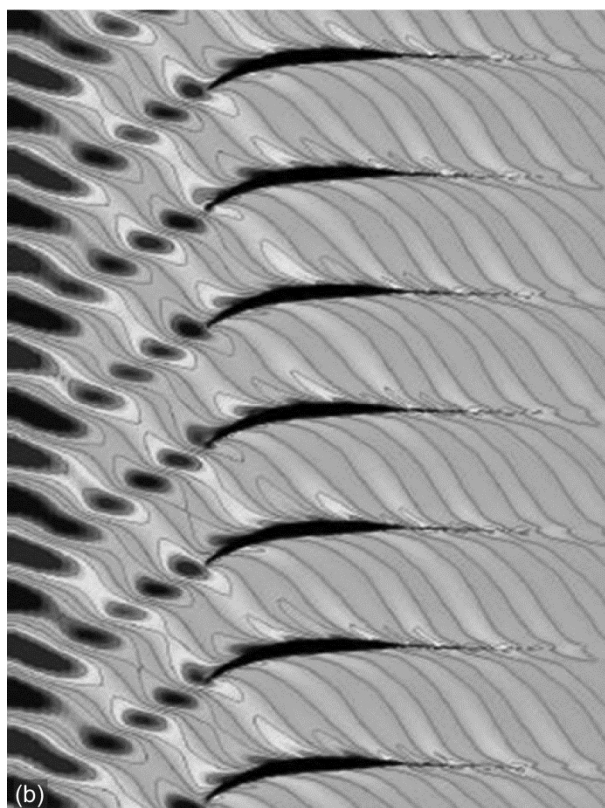
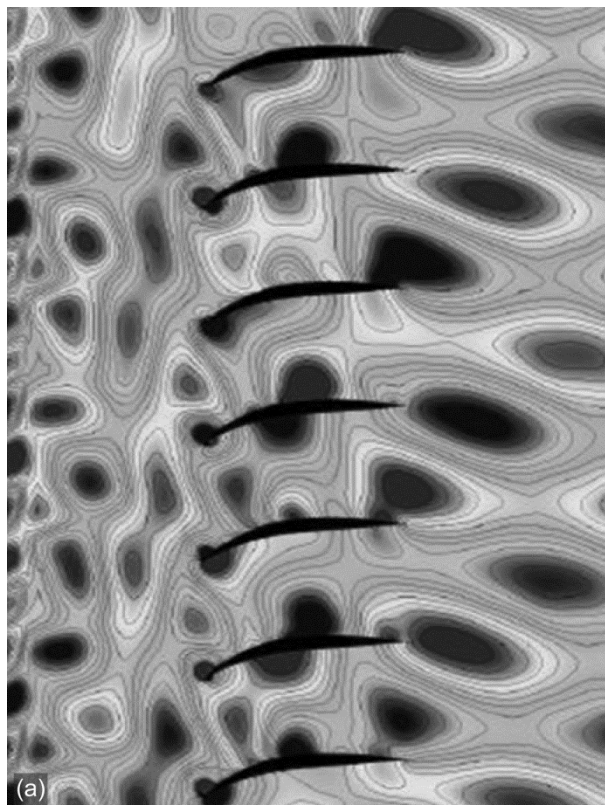

Figure 23.—Benchmark problem for the fourth CAA workshop. (a) Contours of perturbation pressure. (b) Contours of perturbation velocity.

Turbojet Noise Reduction

In the first major noise reduction project at Glenn, researchers investigated ways to reduce jet noise from turbojets. The number of complaints around airports were rising as the thrust from turbojets was increasing due to improved gas turbine engine technologies. Work at the NACA focused on full-scale tests on engines with nozzle suppressors. In addition to community noise issues, structural fatigue of surfaces near the nozzles due to high-amplitude acoustic pressure waves (sonic fatigue) presented additional problems. Research during this time was exploratory with no specific noise reduction goals in mind. Many different nozzles were tested without much analytical guidance beyond the work of Lighthill (Refs. 33 and 34). It was known that reducing the jet exhaust velocity was the most beneficial to reducing jet noise. Converting the primary jet into smaller jets was beneficial since the peak noise level was a function of Strouhal number (St). Smaller diameter jets would shift the peak levels to higher frequencies that had higher atmospheric attenuation and to a less annoying region of the sound spectra.

Several nozzles shown in Figure 2 used multiple tubes and chutes to shift frequencies, however, significant thrust loss from these nozzles hampered their implementation on aircraft. Ejectors were added to help recover some of the performance losses, but the ejectors were heavy and required variable geometry to operate between takeoff and cruise. The NACA investigation concluded that a 12-lobe nozzle caused the least thrust loss (3.2 percent at a flight Mach number of 0.50) and could provide 5 to 6 dB reduction in peak noise during takeoff (Ref. 6).

Glenn resumed work on nozzle suppressors for the SST in the late 1960s. The mixer-ejector concept was considered the most promising since thrust loss was the primary suppressor concern and ejectors could be used to help recover portions of thrust loss. Many nozzles were tested for acoustics and performance. Cruise performance was found to be acceptable, but the low-speed performance during subsonic flight fell short of the requirements (Ref. 35).

Quiet Engine Program (QEP)

The turbofan engine introduced in the 1960s reduced the noise levels compared with turbojets, but a dramatic increase in the number of flights resulted in aircraft noise regulations and consequently, the need for additional engine noise reduction research. The QEP was initiated to reduce turbofan engine noise by 15 to 20 PNdB below the levels from Boeing 707s or McDonnell-Douglas DC-8s. Noise reduction technologies were developed and applied to an experimental engine that was designed, built, and tested under contract by GE on a CF6 engine. Three fans, designated A, B, and C, had distinct low-noise design features and were delivered to Glenn for tests with acoustically treated nacelles (Ref. 36). This was the

first time that Glenn became involved with fan noise research. The FAA requested that the program be expanded to include full-scale engine demonstrator tests.

Quiet, Clean, Short-Haul, Experimental Engine (QCSEE) Program

The QCSEE program was established to apply QEP technology to short-haul configurations. GE was tasked with developing fans that could be added to a core engine for full-scale acoustic tests. The engines were designed using lower pressure ratio fans for STOL aircraft and could operate from smaller airports to help relieve airport congestion. The QCSEE program had three specific goals (Ref. 10):

- Develop short-haul propulsion technologies that are environmentally and economically acceptable.
- Provide government with data for future rule making.
- Transfer data and technologies to industry.

Research carried out at Glenn used model scale and full-scale tests. Many of the advanced technologies that are being considered for turbofans today were initially developed under these programs. They include high-bypass-ratio engines (10 to 12), variable pitch fans with low-pressure ratios (1.27 to 1.34), variable area fan nozzles, advanced acoustic liners, the high-Mach inlet concept, digital electronic controls, clean combustors, reduction gearing, and composite components including fan blades, fan frames, and nacelles.

Two QCSEE demonstration engines built and tested at Glenn, incorporated short-haul installations. One was the under-the-wing (UTW) engine (Fig. 24(a)) and the other was the over-the-wing (OTW) engine (Fig. 24(b)). Both engines were significantly quieter than the Boeing 707 and Douglas DC-8 engines. The OTW technologies were used for modified YF-102 engines on an experimental airplane (Quiet Short-Haul Research Aircraft (QSRA)) that was first flown in 1978 (Fig. 25) and managed by the NASA Ames Research Center in California. Shovlin and Cochrane provide a summary of the QSRA program (Ref. 37), and video was taken at a 1987 air show at Ames (Ref. 38).

Refan Program

The Refan program, started in 1972, aimed at advancing technologies to reduce noise and smoke by retrofitting P&W's JT3D and JT8D engines. Funding cuts in 1973 forced the program to focus only on the JT8D since it would impact longer service aircraft such as the newer 727, 737, and DC-9. After the initial design phase, contracts were awarded for engine design, fabrication, and full-scale testing, and component tests (Ref. 39). Fan noise reduction technologies included increased fan diameters resulting from increased BPRs; a

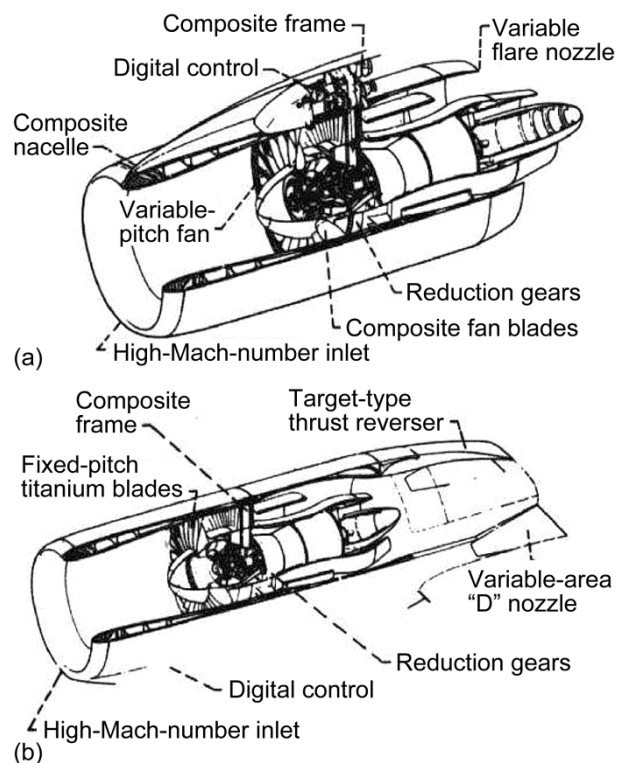

Figure 24.—Quiet, Clean, Short-Haul Experimental Engines (QCSEE). (a) Under the wing (UTW). (b) Over the wing (OTW).



Figure 25.—Quiet Short-Haul Research Aircraft (QSRA).

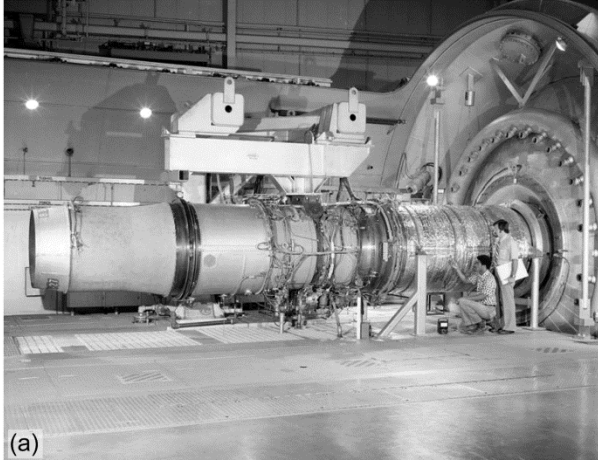

Figure 26.—Refan tests. (a) Altitude engine tests in the Propulsion Systems Laboratory (PSL). (b) Flight test on a DC-9.

single-stage fan to replace the two-stage fan; increasing the spacing between the inlet guide vanes, fan, and the stator blades; and optimizing the number of blades to reduce noise. Three different nacelles were designed with varying amounts of acoustic treatment to determine which configuration would be built for full-scale tests. Each design used a long duct with an acoustically treated tailpipe to reduce the exhaust noise. The B727-200 and a DC9-200 aircraft were tested after the new engines were modified, but the 737 flight test was dropped.

Predictions indicated that aircraft noise could be reduced by 5 to 7 effective perceived noise in decibels (EPNdB) on approach, about 9 EPNdB on takeoff, and 14 to 15 EPNdB on sideline. This would provide a cumulative margin of 28 to 31 EPNdB under FAR-36, Stage 2 for a 727 aircraft, or an average of 10 dB at each certification point. Static engine tests were performed at industry facilities and altitude tests were carried out at the Glenn Propulsion System Laboratory (Fig. 26(a)). Flight tests were conducted by Boeing and McDonnell-Douglas

in 1975. Test results showed an average reduction of 6 to 10 EPNdB for the DC-9 (Fig. 26(b)) and 7 EPNdB for the 727 at each certification point (Ref. 40). The older 727 and DC-9 aircraft went out of production before either aircraft were retrofitted with improved engines, however, the noise reduction technologies were introduced on the 737-300 and the MD-80. Figure 1 shows that the noise levels from these aircraft were about 9 to 11 dB below Chapter 2 limits and also met the new Chapter 3 regulations with sufficient margin.

Quiet, Clean, General Aviation Turbofan (QCGAT) Program

The QCGAT program was initiated in 1976 to determine if the noise reduction technologies developed for larger engines could be successfully applied to smaller turbofan engines. Program goals included both noise and emissions reductions. Noise reduction goals depended on the aircraft weight and followed closer to the slope of the regulated limits for heavier aircraft. The way the regulations are written, aircraft below about 100 000 lb (45 359 kg) takeoff gross weight have a constant value noise limit for each certification point, meaning the margin is easier to meet as the aircraft becomes lighter. NASA's noise goals were intended to determine if further noise reduction was possible without significant performance loss (Ref. 41). Once the aircraft application was selected, the effective noise reduction goals ended up being 15 to 20 PNdB below Stage 3 at each certification point.

Contracts were awarded to Garrett-AiResearch Company and Avco-Lycoming Corporation (both are now part of Honeywell Aerospace, Inc.) to develop candidate engines that were tested at both Glenn and their own static engine facilities. In addition to applying many of the noise reduction technologies from the QEP and Refan programs, use of internal exhaust mixers and elimination of fan inlet guide vanes were investigated. The Avco-Lycoming engine was tested statically and the predicted noise levels, accounting for flight effects, were shown to exceed NASA goals at all three certification points (Fig. 27) (Ref. 42). The Garrett-AiResearch engine was also tested and found to meet the goals on a cumulative basis (Ref 43).

Aircraft Energy Efficiency (ACEE) Program

In the 1970s, after a few very lean years for aerospace because the Apollo space program ended, Glenn returned to working on aircraft engine efficiency in response to threats to the availability of oil used to produce aircraft fuel. The price of fuel tripled from 1973 to 1975 and Congress authorized NASA to work on ways to conserve fuel. The ACEE program brought the Energy Efficient Engine (EEE) and the Advanced Turboprop (ATP) programs to Glenn. Information on the history of these programs is included in Reference 44.

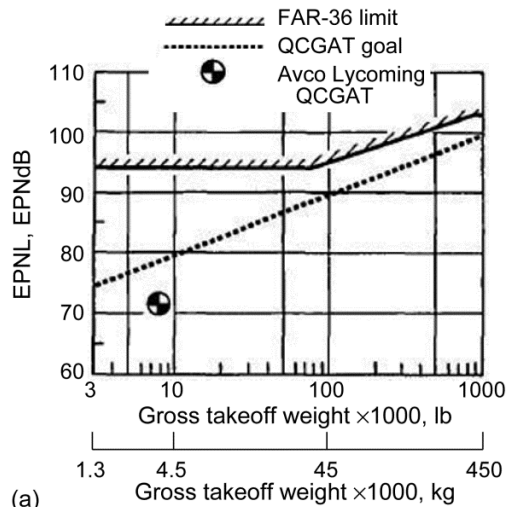

(a)

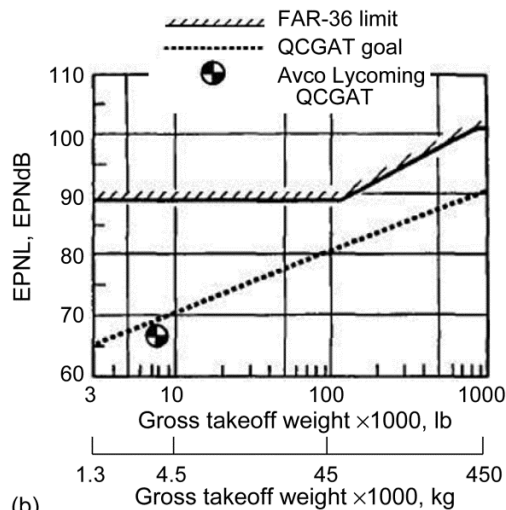

(b)

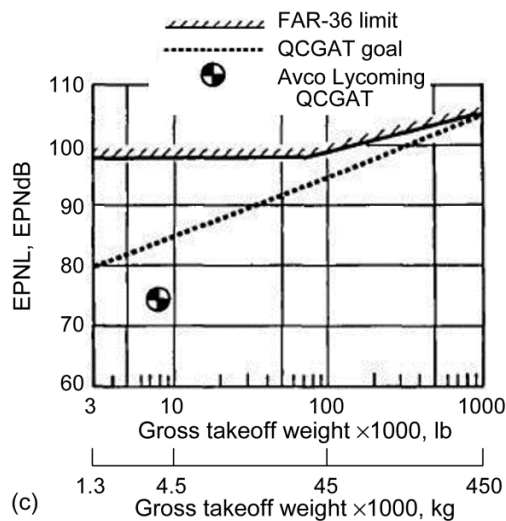

(c)

Figure 27.—Noise levels from Avco-Lycoming engine relative to QCGAT noise goals.
(a) Sideline. (b) Takeoff. (c) Approach.

The ATP program started in 1978 after Glenn spent several years studying propfans and working with Hamilton-Standard on advanced propellers under the Reducing Energy Consumption of Commercial Air Transportation (RECAT) program. The EEE program awarded large contracts to GE and P&W to develop advanced higher BPR turbofan engines, while the ATP program developed technologies to further reduce fuel consumption using propfans.

Advanced Turboprop (ATP) Program

The ATP's program objective was to find ways to reduce aircraft fuel burn. The program projected 25 to 30 percent less fuel burn over equivalent technology turbofans (Ref. 45). Glenn started research in propeller acoustics and aerodynamics, structures for very thin and highly swept composite blades, and gearboxes to transmit power from the core engine to the propeller. Propfans were selected over conventional turboprops because of their ability to fly at a faster cruise Mach number than older propeller designs. This required making blades thinner and adding sweep to reduce shock losses. Unfortunately noise levels increased both inside aircraft cabins and for the community. There were also concerns about en-route noise since the low-frequency tones from the propfans could propagate to the ground even from cruise altitudes. People living in quiet areas and never exposed to aircraft noise could notice the high-altitude flyovers.

Two basic concepts were investigated during the ATP program: the first involved single-rotation propellers and the second involved counterrotating blades. Single-rotation propellers were investigated by Hamilton-Standard and tested in model scale (Fig. 28(a)) and flight tested on a Lockheed-modified Gulfstream aircraft called the Propfan Test Assessment aircraft that first flew in 1987 (Fig. 28(b)). Counterrotating propellers were investigated by both GE and a team from Hamilton-Standard, Allison and P&W. GE started to work with NASA in 1983 to advance their UDF concept that used a gearless drive system and counterrotating turbines. The Hamilton-Standard, Allison, and P&W concept was also counterrotating, but used a gearbox to drive the rotors.

The UDF engine, also known as the GE-36, flew on modified 727 and MD-80 test aircraft (Fig. 29(a)). Near-field noise measurements, taken using the Glenn Learjet, confirmed that the cruise tone levels correlated with prior 8x6 SWT data. Model-scale acoustic data derived in the 9x15 LSWT were shown to correlate with near-field flight data for both single-rotating and counterrotating propfans (Fig. 29(b)). The UDF just met Stage 3 regulations for community noise levels. Even though improvements were possible by increasing the number of blades and optimizing the designs, interest in the program waned after the price of fuel plummeted from its 1970s highs. As a result, NASA stopped all work on propfans in 1991.

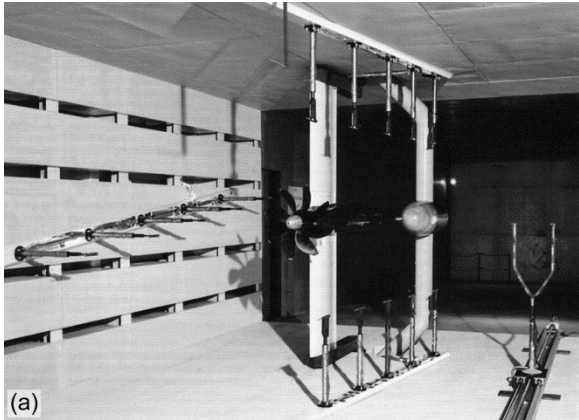

Figure 28.—Single-rotation propfan. (a) SR-7A in the 9×15 LSWT. (b) Propfan Test Assessment (PTA) aircraft with wing-mounted propfan.

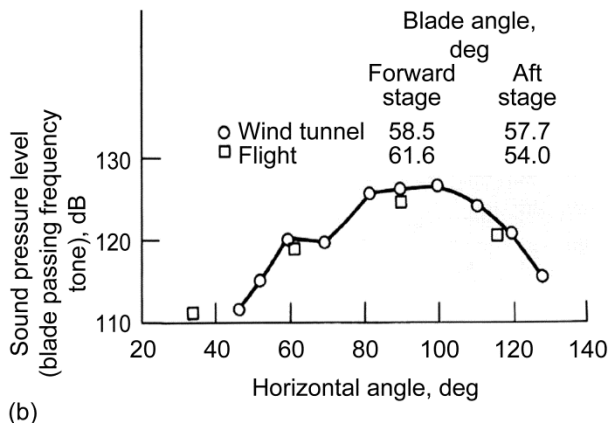
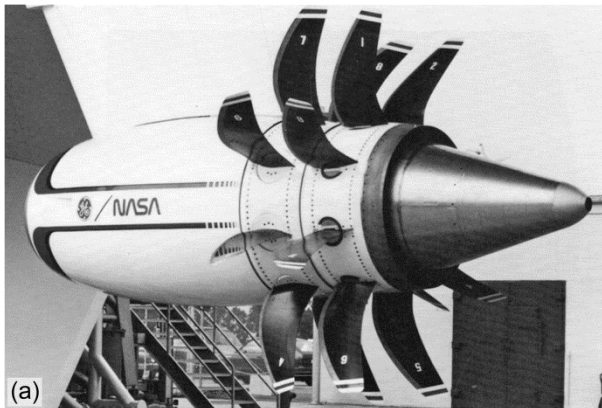

Figure 29.—Counterrotation propfan. (a) Unducted fan (UDF) engine. (b) Near-field acoustic data.

High-Speed Research (HSR) Program

The SST program abruptly ended in 1971, but NASA resumed work on supersonic aircraft for the HSR program in 1990. Noise levels for subsonic commercial aviation were lower, so the target noise levels had to be set even lower than they were for the SST program. Figure 30 shows a comparison of sideline noise suppression versus gross thrust loss for suppressors developed during the SST time period with the High-Speed Civil Transport time period for the HSR program. Model scale results from the best mixer-ejector nozzle concepts that were tested by the end of the program in 1999 are also shown. The noise reduction goal was 20 dB with acceptable thrust loss for supersonic cruise and subsonic operations. Significant progress was made with the help of CFD and lighter weight materials (mixer-ejector nozzles add weight and complexity to the engine). Figure 31 shows one of the nozzle concepts that was tested in model scale. Notice that substantial variable geometry is still required to make this concept work.

As U.S. industry lost interest in large SSTs, new interest grew in smaller supersonic business jets. NASA started the Supersonics project in 2006 and continues today with the goal of beginning with a smaller aircraft and developing the technologies to enable larger aircraft in the future. The European Concorde was taken out of service in 2003 because it was not economically viable anymore. Studies show that this could change if supersonic flight over land becomes acceptable to the public (currently it is not allowed except for designated corridors reserved for military aircraft). Therefore a major research activity in the Supersonics project is the sonic boom reduction in addition to jet noise reduction.

Advanced Subsonic Technology (AST) Program

Turbofan noise research resumed at Glenn with the AST Noise Reduction program in 1994. NASA's contracts with industry to develop engine technologies for AST and HSR kept most of the acoustic facilities across government, industry, and universities working in fan and jet noise research. A high-power air turbine drive rig was built by GE and Boeing for the wind tunnels to test turbofan models.

A Technical Working Group (TWG), consisting of representatives from industry and NASA, was formed to provide input on noise reduction technology needs. The TWG approach worked very well and helped transition the technologies to industry by keeping NASA aware of research areas that needed the most attention and reduced work duplication or overlap between companies.

Reference noise levels were defined using four classes of aircraft of different sizes and designated "1992 Technology" (Ref. 46). Noise reduction goals requiring technologies to reduce aircraft noise by 10 dB relative to 1992 technology were set. NASA developed the Technology Readiness Level (TRL) scale to help identify and track the maturity of technologies.

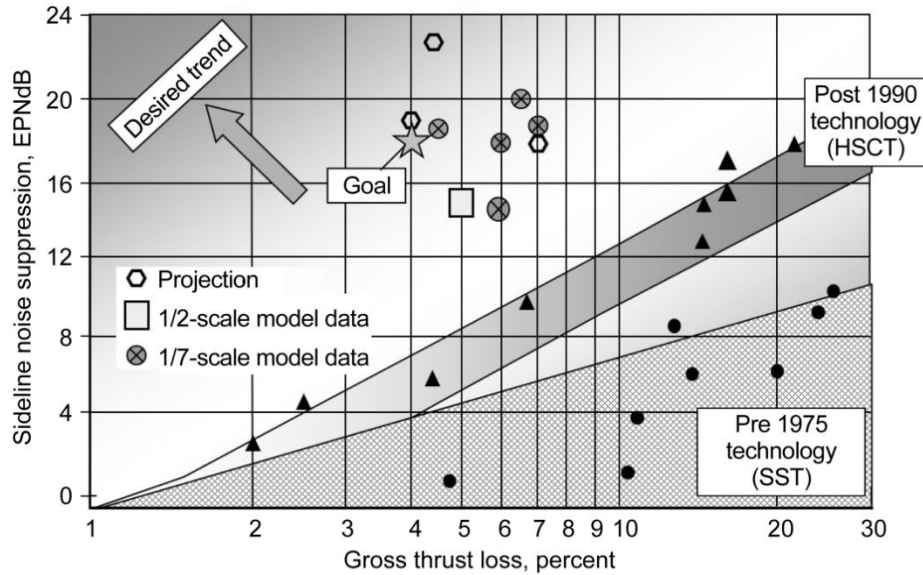

Figure 30.—Noise reduction and thrust loss projections for large supersonic aircraft.

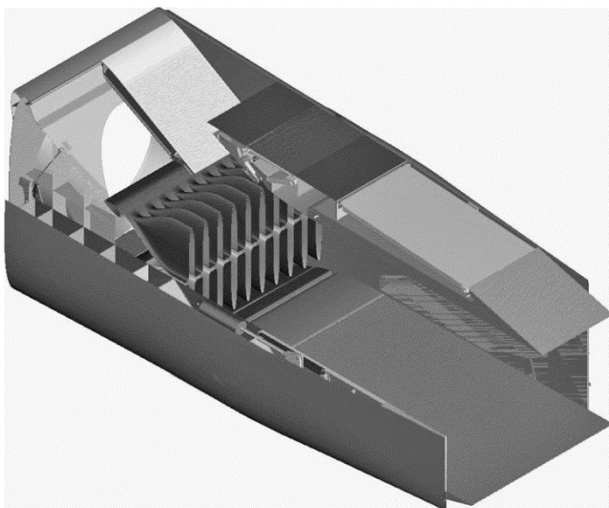

Figure 31.—High-Speed Research (HSR) mixer-ejector nozzle concept.

Levels range from 1 to 9, with TRL 1 meaning conceptual research and TRL 9 meaning that technologies are fully implemented into products. Utilizing the TRL scale requires that each discipline define what they mean for their own development sequence. For engine noise research, TRLs 1 to 3 takes a concept through fundamental tests and simulations in a laboratory. TRLs 4 to 5 validate the concept at the component level followed by a system or subsystem level in a relevant environment (e.g., a scale model wind tunnel test). TRL 6 means a static engine validation test or a flight demonstration test.

NASA’s role is to develop technologies from TRLs 1 through 6, and then it is up to industry to decide if the

technologies can be used in their products, raising the TRL to 9. NASA awarded contracts to GE, P&W, and Allison to identify noise reduction technologies needed to achieve the AST noise reduction goals without sacrificing performance (Refs. 47 to 49).

Early in the program, jet noise research was excluded since NASA worked on future ultrahigh bypass (UHB) engines with low enough exhaust velocities that fan noise was the dominant source. Because industry and the FAA wanted solutions for existing engines, both NASA and the FAA agreed to fund a jet noise research project with goals to identify technologies for reducing fan and jet noise by 3 EPNdB by 1996. The jet noise work ended and work focused on fan noise and engine validation tests. It was thought that the only promising solution for jet noise, after reducing the velocity, was to use long duct internal mixers with acoustic treatment to absorb the resulting high-frequency mixing noise. Initial tests were done on mixers from the EEE program and JT8D mixers intended for hushkits. At one TWG meeting, Boeing urged NASA to consider separate flow nozzles with short fan ducts since most of their aircraft did not have long duct mixers. NASA issued a competitive request for proposals and combined ideas from GE, P&W, and Allison into one test that was conducted in the AAPL in early 1997. Several concepts were tested including “tabs” and “chevrons.” Jet noise was reduced by about 3 EPNdB by adding chevrons to the core nozzle and bypass duct nozzle (Fig. 32(a)), and the core nozzle for short fan ducts (Fig. 32(b)). The results came as a pleasant surprise to the test team. They repeated reference nozzle tests daily to make sure all temperature and humidity corrections were properly accounted for and that the “delta” noise reduction

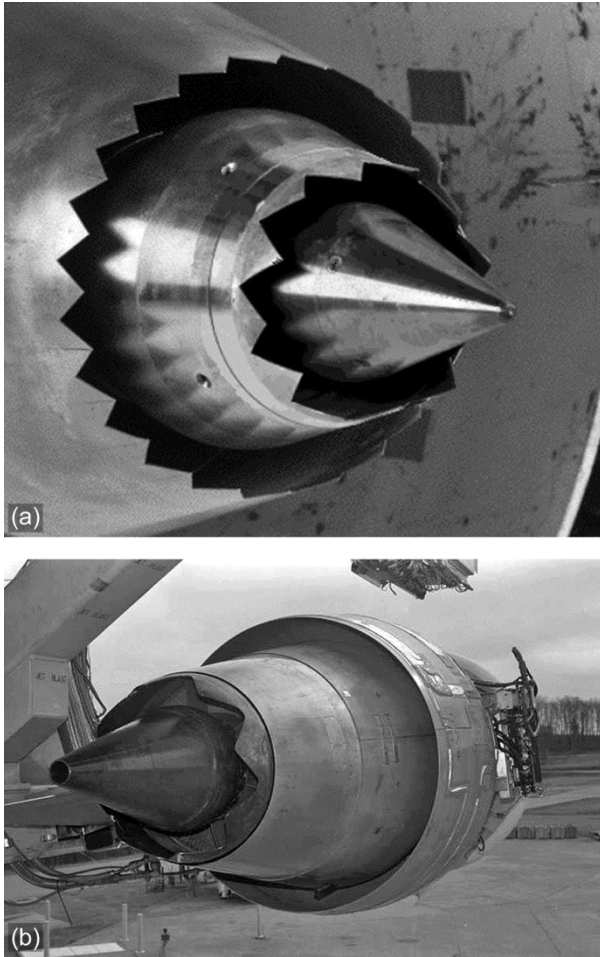

Figure 32.—Chevron nozzles. (a) First test in AAPL.
(b) GE CF-34 engine test.

from chevron nozzles was real. This was the first successful test of chevron nozzles with minimal thrust loss.

Previous tests of similar mixing devices for separate flow nozzles used higher penetration angles into the flow resulting in high-frequency noise penalties that negated the overall noise reduction. The concept introduced by GE kept the tip of the chevron within the nozzle-shear layer to introduce sufficient streamwise vorticity to mix the core and bypass flow downstream of the nozzle with minimum high-frequency mixing noise. NASA knew that industry would not acknowledge the test results unless thrust measurements were completed and also showed acceptable performance. The AST program manager (Mr. William Willshire) added funding to send the nozzles to ASE Fluidyne. Results showed that the performance losses were less than 0.25 percent for chevron nozzles with noise reduction ranging from 2.5 to 3 EPNdB. This was a major breakthrough for jet noise research since many of the previous methods depended on engine cycle changes to reduce the exhaust velocities. Chevron nozzles provided significant noise reduction with no change to the

engine cycle parameters. A workshop was held at Glenn in September 1997 to share the results with all TWG members. Several companies pursued their own versions of the chevron nozzle and GE introduced the first production implementation on a CF-34 engine in 2003. Several other aircraft have been introduced with chevron nozzles including the Boeing 787 and 747-8. NASA has continued chevron nozzle research to better understand the flow physics and apply the idea to turbojets. Since analytical methods were not sufficiently reliable to guide nozzle designs, NASA focused on flow measurement methods to characterize the turbulence using PIV to provide the quality of data needed to validate jet noise prediction codes. Subsequent publications have shown better correlation between predicted noise reduction and experimental data (Ref. 28). Another incentive for turbojet applications was to see if chevrons could be applied to tactical aircraft for the military. The Glenn Learjet (Fig. 18(b)) was used to demonstrate up to a 4-EPNdB reduction in jet noise. A summary of the chevron nozzle development has been recently published and provides more details (Ref. 50).

Fan noise research during the AST program included model scale tests and development of fan noise prediction methods. There was more success with these methods to guide experiments than there was for jet noise research. Rotating microphone measurements and detailed flow measurements were used to define the needed key input parameters for the prediction methods. Many fan tests were conducted in the Glenn 9×15 LSWT starting in 1994. NASA purchased a slightly modified version of the Universal Propulsion Simulator (UPS) drive rig from GE and Boeing that became the workhorse for the fan tests. NASA and all of the participating companies built fan and nacelle hardware to fit onto the rig using a 22-in.- (56-cm-) nominal fan diameter. The following list summarizes the most significant tests and their results:

(1) GE UPS tests—Since the NASA drive rig had not been completed by 1994, GE’s UPS rig and several sets of fan blades intended for improvements to the GE-90 engine were used and served as a baseline for NASA.

(2) P&W Advanced Ducted Propulsor (ADP) tests—Several tests were conducted from 1995 through 1997 to investigate the ADP concept for UHB engines with lower fan tip speed and lower FPRs (Fig. 33). Earlier tests had been conducted at Glenn using P&W’s 17-in.- (43-cm-) fan rig. These tests used Glenn’s 22-in.- (56-cm-) fan rig aimed at further fan noise reduction. Advanced acoustic liners were evaluated with the knowledge of fan noise source characteristics from previous tests to optimize the liner impedance. For lower speed fans where broadband noise dominated, the noise correlated better with FPR than with fan tip speed. Sufficient spacing between the fan and stator could lower the noise and the fan efficiency improved to about 95 percent due to lower aerodynamic losses for low-pressure ratio fans (Refs. 51 to 53).



Figure 33.—Advanced Ducted Propulsor (ADP) fan test in 1995.

A variable pitch fan with casing treatment was used to optimize the performance between takeoff and cruise operations, and to provide reverse thrust on landing. (Reverse thrust was needed from the engines to back the aircraft out of the passenger loading gates, but this changed due to concerns with engine emissions getting into the terminal area. Now all aircraft are towed.) However, losses associated with the larger hub and tip gaps needed to reverse the pitch of the blades were high and the amount of reverse thrust fell short of the goals. P&W would later go to a fixed-pitch fan, a variable-area nozzle, and an alternative reverser to address these problems.

(3) Allison Low Noise Fan tests—One of the fan noise reduction concepts identified by the Allison Engine Company (now Rolls-Royce) in their study contract, was to sweep and lean the fan stators to reduce the rotor-stator interaction noise. NASA conducted studies with fan noise prediction codes showing that sweeping vanes by 30° and leaning vanes in the direction of rotation of the fan provided favorable acoustic phase cancellation from hub to tip as the fan wakes passed the stators (Ref. 54). It also increased the distance for the wake strengths to decay before they reached the stator. The concept was tested in 1996 and was found to reduce the fan noise by 3 dB (Ref. 55). A forward-swept fan was also tested (Fig. 34(a)). This was the first known verification that swept and leaned stators were a viable way to reduce fan noise (Fig. 34(b)). Previous attempts in the 1960s were tested without an ICD, and any possible noise benefits were likely masked by extraneous noise caused by inflow distortion.

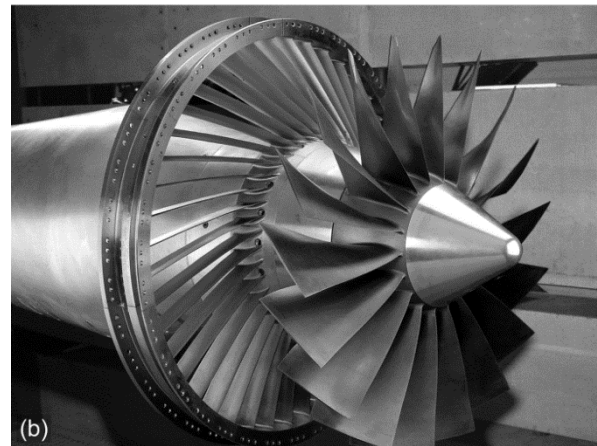

Figure 34.—Allison low-noise fan. (a) Forward-swept fan (counter-clockwise rotation). (b) Swept and leaned stators.

(4) GE High-Speed Fan tests—The TWG expressed concern that all of the technologies being pursued by NASA were only relevant for UHB engines and noise reduction was still needed from moderate bypass ratio engines in the 5 to 6 range. Glenn conducted tests with GE to investigate swept and leaned stators on a higher speed fan, and to investigate forward sweep on the fan to help the aerodynamic performance and noise. Fan tests used a baseline model representative of a current CF-6 engine, and the models used new designs for the fan and stator. The tests influenced the design of a newer CFM-56 engine with swept and leaned stators and successfully reduced the fan noise (Ref. 56) (Fig. 35).



Figure 35.—GE swept and leaned stators tested on CFM-56 engine.

(5) Honeywell Quiet High Speed Fan (QHSF) tests—One of the challenges to address for fan noise with higher rotational speeds was multiple pure tones (MPTs), also known as a “buzz saw” noise because of the distinct sound during takeoff or cruise. Even slight variations in blade geometry cause the bow shocks radiating forward of the fan to be unevenly spaced, which causes the sound spectra tonal portion to shift from blade-passing frequencies and higher harmonics to shaft-order frequencies. Noise can be reduced by adding acoustic treatment to the inlet, but it is more desirable to reduce noise at the source with alternative blade designs. Work done during QEP by BBN (Ref. 57) was revisited to design a fan with highly swept blades to reduce the shock strength. Honeywell started with this design philosophy and made improvements for their baseline TFE731-60 engine fan and stator design (Refs. 58 and 59). The QHSF tested in 1998 (Fig. 36(a)) confirmed that the onset of MPT noise can be delayed to higher rotational speeds by using forward sweep (Fig. 36(b)). The overall reduction in fan noise was also attributed to a reduction in the blade passing frequency tone level that was prevalent in the baseline fan (Refs. 60 to 62). The technologies were used to guide the design of Honeywell’s HTF7000 engine.

(6) NASA Alternative Low Noise Fan (ALNF) tests—A different approach was investigated to see if increasing the number of fan blades and reducing the number of stator vanes (long chord stators) could reduce fan noise. Long chord stators were previously used for fan noise reduction during the QEP. By increasing the number of fan blades, the blade passing frequency tone and its higher harmonics could be shifted to higher frequencies to reduce human annoyance. Long chord stators could be made large enough to add acoustic treatment inside the vanes, and the unsteady surface pressure response to the rotor wake interaction could be reduced resulting from more phase cancellations due to shorter acoustic wavelengths across the stator. In addition, the individual fan wake strengths

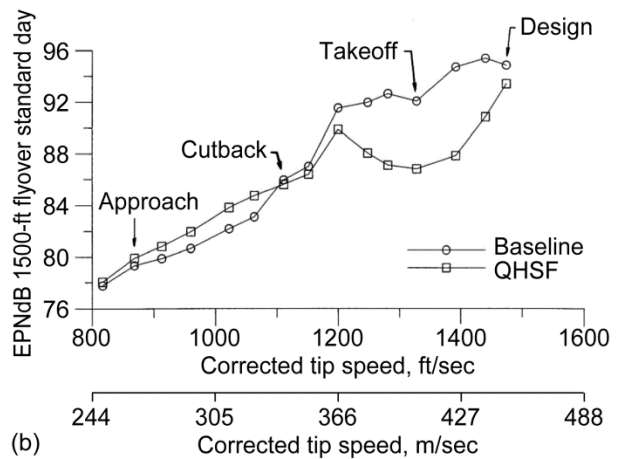
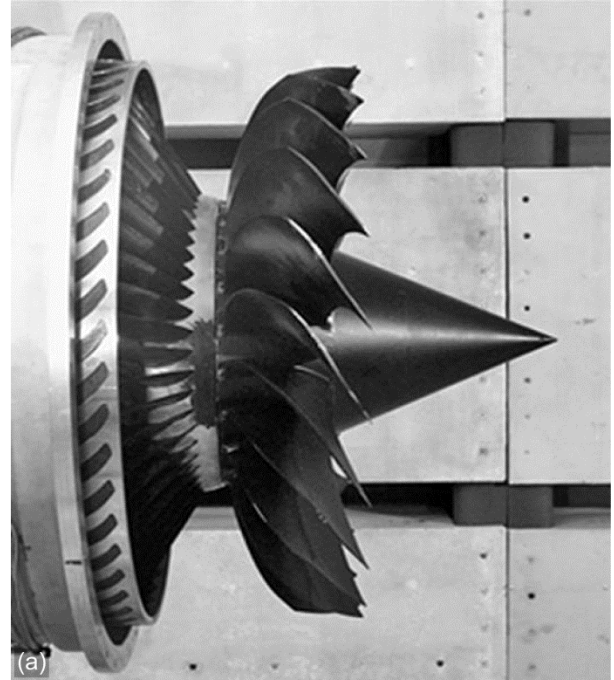

Figure 36.—Honeywell Quiet High Speed Fan (QHSF). (a) Forward-swept fan. (b) Delay of MPT noise onset.

would be reduced due to the lower aerodynamic loading per blade. A fan that had 106 blades and 7 long chord stators, with a tip speed of about 1100 ft/s (335 m/s) was tested in 1997 (Fig. 37) using the Allison Low Noise Fan for baseline comparisons. Results showed reductions in both the tones and fan broadband noise. The NASA ALNF was about 4 EPNdB quieter than the Allison Low Noise Fan for takeoff conditions, and about 5 EPNdB lower at approach conditions (Ref. 63).

(7) Source Diagnostics Test—A comprehensive fan test campaign was carried out during this time period to provide a better understanding of the fan noise generation process and to provide an extensive validation database that could be used for fan noise prediction methods. A test at Boeing in 1995 using

an 18-in.- (46-cm-) diameter fan to obtain initial diagnostics data was supported by NASA. NASA then worked with GE to obtain similar data using an early fan design for the GE-90 engine called the R4 fan. One of the more challenging goals was to test in a rotor-alone configuration in the wind tunnel, which required externally supporting the nacelle (Fig. 38(a)) when the structural exit guide vanes were removed. Since the drive rig pitched and yawed as the fan rotational speed increased, an active control system was designed so the nacelle remained centered over the fan to maintain a uniform 0.005-in. (0.0127-cm) tip clearance (Fig. 38(b)) during testing.

A comprehensive set of flow and acoustic measurements were obtained using instrumentation shown in Figure 10(e). Results showed that, in general, the inlet-radiated noise was dominated by the rotor, and the aft-radiated noise was dominated by the rotor-stator interaction noise. The rotor-alone noise was up to 4 EPNdB less than the noise with the rotor and stators and provided insight into how important it was to work on both the fan and the stator sources before further significant noise reduction could be achieved. Flow surveys, turbulence, acoustic duct mode, and rotating microphone measurements, and inlet/aft separation and rotor-alone data all used to provide input to fan noise prediction codes. A fan broadband noise challenge problem was posed to several code developers with blind test cases using input on flow parameters from the data and from CFD predictions. The BFaNS code developed by P&W and United Technologies Research Center under a NASA contract predicted the overall noise levels within a couple of decibels. A special session at the 2002 AIAA Aeroacoustics Conference was organized and papers were presented about all aspects of the test (Refs. 64 to 68).

Active noise control of the fan noise was another major research effort during the AST program. UHB engines would have less acoustic treatment due to shorter nacelles and would be more susceptible to inflow distortions in flight due to shorter inlets. Active noise control had never been tried for fans, but was increasingly popular for headsets and ventilating system duct noise. For plane waves in a duct, active noise control is achieved by using a sound source to introduce another plane wave that is 180° out of phase with the target plane wave. Rotating microphone measurements showed that fan noise sources were complex, varied with speed, and became even more complex at higher frequencies. The sound sources used for active control needed to be equally complex to reduce the amplitudes of target duct acoustic modes without exciting other duct modes that could increase the noise.

The ANCF (Fig. 16(a)) was built to study the fundamentals of fan noise generation, its propagation in the fan duct, and its radiation to the far field. The ANCF was also an ideal test bed to assess the feasibility of active control of fan. Acoustic frequencies were set to match expected UHB engine fan frequencies. Many concepts were investigated ranging from



Figure 37.—Alternative Low Noise Fan (ALNF).

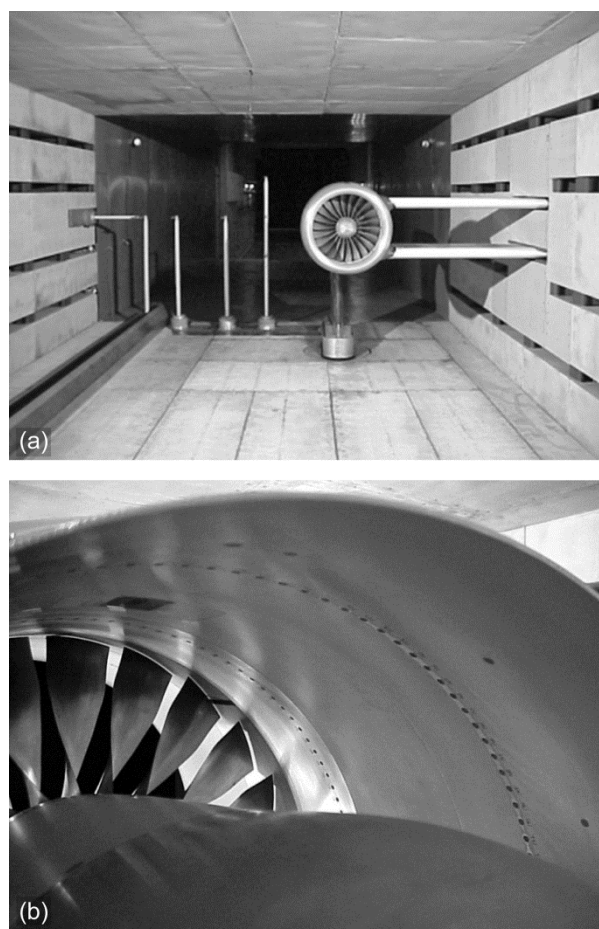

Figure 38.—Source diagnostics test (SDT). (a) External nacelle support struts. (b) Fan with no stators; view looking toward inlet from aft bypass duct.

duct- and hub-mounted actuators (sound sources) to cancel a single duct mode, to a system including an array of actuators embedded inside the stator vanes to cancel multiple acoustic duct modes and tones simultaneously (Fig. 16(b)). Actuators varied from speakers to piezoelectric devices that could be tuned for maximum sound amplitude, but were limited in frequency range. It was shown that global reduction of fan noise around the engine is possible for several tones containing multiple modes. The control systems were adequate to adjust to the changes in fan speeds. However, the complexity of the system, number of actuators, and expected cost made it difficult to justify in an engine application.

A joint solicitation between Glenn and Langley was issued to identify ideas for addressing some of these challenges and ways to reduce fan broadband noise. One idea pursued by Northrop-Grumman and Hersh Acoustical Engineering was to integrate the active control system with the acoustic treatment to create a hybrid active-passive system. The active system directed the sound more efficiently into the liners for better absorption. The concept was tested in the 9×15 LSWT as an add-on to the P&W ADP fan tests and showed promising results. Another idea was to control only the modes that significantly contributed to the far-field perceived noise levels. In either case, the system was still too complex to be considered for an engine application. Another problem was that the contributions of tones to the overall fan noise levels were small for low-pressure ratio fans. Therefore methods to address broadband noise were also needed. It is anticipated active noise control concepts will be revisited sometime in the future as other technologies mature, such as higher amplitude actuators and faster processors to analyze the synthesis acoustic signals in real time to control fan broadband noise. The pioneering work done during this time showed fundamentally that active control of complex fan noise sources is possible.

In addition to the model tests, there were engine validation contracts with Honeywell and P&W to show that some of the noise reduction technologies would work at a higher TRLs. Static engine tests were done at the company test sites. P&W tested a scarf inlet, active/passive inlet liners, cut-on stators, and an acoustically treated turbine exhaust (Fig. 39(a)). The scarf inlet (Fig. 39(b)) was shown to direct the inlet radiated noise away from the community (lower) side of the engine by 2 to 4 EPNdB relative to a conventional inlet. By treating the turbine exit, it was discovered that the aft-radiated noise was more from the turbine than from the fan. The idea behind using a cut-on stator was to reduce the fan broadband noise due to the lower number of stator vanes. The blade passing frequency tone noise would increase, but it could be reduced with either active noise control or a scarf inlet. The overall fan noise would be lower than a conventional cut-off fan design. Any effectiveness

of the cut-on stator during the test may have been obscured due to the unexpected turbine noise contribution. The active/passive inlet had mechanical problems and was never successfully tested.



Figure 39.—PW4098 engine test. (a) Pratt & Whitney (P&W) C11 test stand. (b) Boeing scarf inlet.

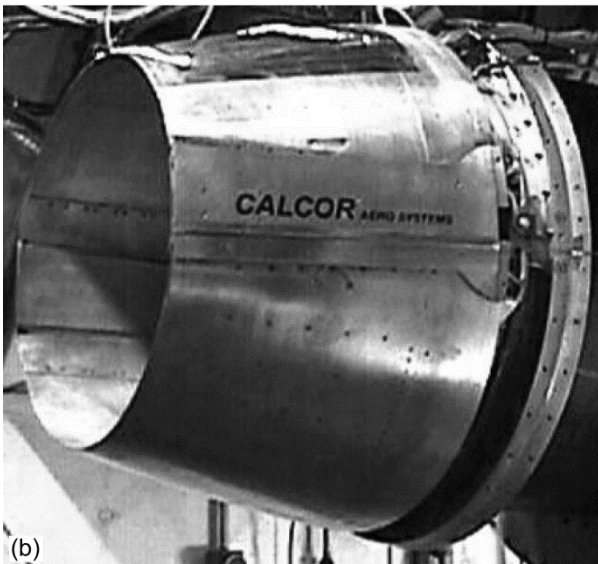
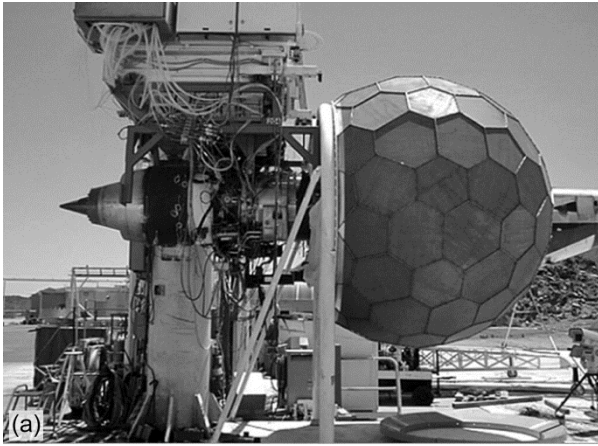

Figure 40.—Honeywell TFE731–60 test. (a) Honeywell San Tan test stand. (b) CalcCor variable-area nozzle.

Honeywell conducted static tests on their TFE731 engine in 1999 at their San Tan facility in Arizona (Fig. 40(a)), followed by flight tests in 2001 on a Falcon 20 test aircraft to investigate chevron nozzles (Fig. 41(a)), and a variable area nozzle (Fig. 40(b)) for jet noise reduction. Flight test results showed the chevron nozzles provided about a 3-EPNdB jet noise reduction and were consistent with projections from model scale and static engine tests (Ref. 69). The Glenn Learjet was also flown with a chevron nozzle during these tests. Honeywell clearly demonstrated the jet noise reduction benefits for both aircraft by using a video with an audio track that switched between flyovers with the baseline nozzle and flyovers with the chevron nozzles. The variable area nozzle showed a 1- to 2-EPNdB jet noise reduction, but the fan noise increased due to the change in loading from varying the back pressure (Ref. 70). A scarf inlet was also tested and showed about a 3-EPNdB noise reduction (Fig. 41(b)) (Ref. 71).

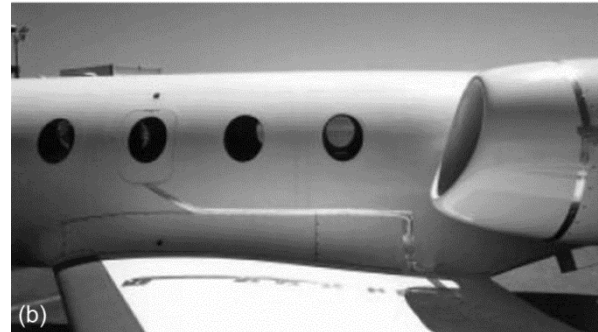

Figure 41.—Honeywell Falcon 20 test aircraft. (a) Chevron nozzles. (b) Scarf inlet.

The AST program officially ended in 1999, but a few of the tests extended into 2001. The new set of NASA “pillar” goals, announced in 1997, intended to push the technology development toward solving the aircraft noise problem. According to the U.S. Environmental Protection Agency (EPA) (Ref. 72), 55 day night level (LDN) is the outdoor noise exposure level “requisite to protect the public health and welfare with an adequate margin of safety.” The phrase “health and welfare” is defined as “complete physical, mental and social well-being and not merely the absence of disease and infirmity.” NASA conducted a study to determine what this would mean for a single event noise metric like EPNL. Since the aircraft fleet mix, number of operations, and size of the airports vary, the study looked at 17 major U.S. airports to determine an average value that could be used for a goal (Fig. 42). NASA selected 20 EPNdB at each certification point (60 dB cumulative) as a good overall goal to contain the objectionable noise within an average airport boundary. The new noise goals were set to develop technologies for reducing the perceived noise level by 2 times (10 EPNdB) in 10 years, and 4 times (20 EPNdB) in 25 years relative to 1997 aircraft. The AST program would contribute 5 dB toward the 10 dB goal, and a new program called Quiet Aircraft Technology (QAT) would develop the remaining technologies needed to reach the 10 dB goal in 10 years. Follow-on research programs would be needed to work on the longer term goal of 20 EPNdB aircraft noise reduction.

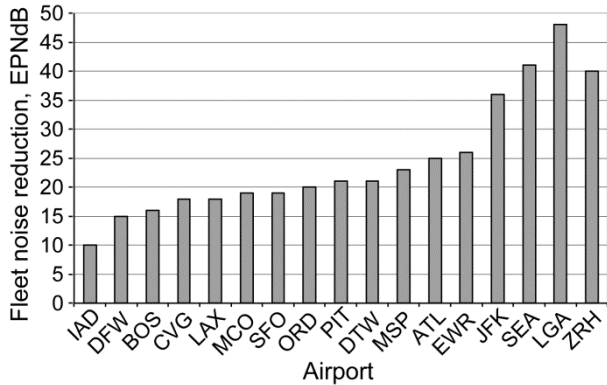

Figure 42.—NASA study for setting noise reduction goals.

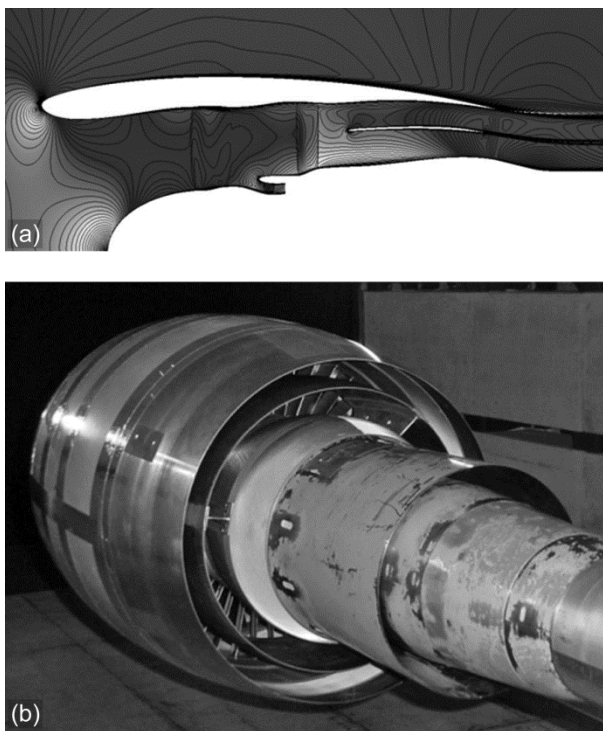

Figure 43.—Aft acoustic splitter for fan noise reduction.
 (a) Mach number contours from CFD predictions.
 (b) Test installation in wind tunnel.

Aeroacoustics Research Consortium (AARC)

Funding for aeronautics research was significantly reduced after the AST and HSR programs. Historically, the average life of a NASA project has been about 5 years and it was a challenge to execute long-term research. The AARC was started in 2001 to establish an organizational structure to promote world-class aeroacoustics research while providing a stimulating environment that can attract high-quality researchers in this area and complement the NASA Glenn acoustic research workforce (Ref. 73). The consortium still exists today

and is managed by the OAI, with financial support from NASA, Boeing, United Technologies, Rolls-Royce, and Honeywell. A peer review panel evaluates proposals and funds multiyear research activities that are considered fundamental to understanding propulsion system noise. Researchers visit supporting organizations to share knowledge and to promote collaboration. Seventeen researchers have been supported over the past 10 years. OAI produces a “Year End Review” for participating organizations and many reports documenting the research have been published.

Quiet Aircraft Technology (QAT) Program

The QAT program began in 2001 by conducting studies to assess the system-level impact of the noise reduction technologies developed in the AST program. Changing cycle parameters, such as reducing the FPR and jet exhaust velocity, provided about a 75 percent reduction in engine noise, leaving about 25 percent to noise reduction technologies such as chevron nozzles or advanced acoustic liners that could be applied to a fixed engine cycle. Incorporating these changes meant increasing engine diameters, which could adversely impact fuel burn due to higher drag, weight, and aircraft installation challenges. Higher bypass ratio engines would eventually make their way into service, so NASA focused the noise reduction research on the most important sources for UHB ratio engines. Aft-radiated fan noise was most important.

A second entry of the source diagnostics test was used to obtain more flow-field measurements such as time-dependent PIV and unsteady surface pressures on the stators. Several fan duct nozzles were tested and showed about 2 dB reduction in fan noise and a thrust benefit by increasing the exit area (Ref. 74). CFD and noise prediction codes were used to guide the design of an aft-treated splitter. The splitter increased the treatment area and was successful in previous programs such as QEP (Fig. 5(b)), but the aerodynamic losses were too high for practical applications. With CFD considered a mature technology for aerodynamic design, the losses from a splitter could be minimized with higher accuracy (Fig. 43(a)). Figure 43(b) shows the splitter installation using the P&W ADP fan and nacelle hardware. Results from this test were disappointing, showing only a 1.5-dB reduction in sound pressure level from 12.5 to 20 kHz and about 1 percent loss in thrust.

Acoustically treated soft (sound absorbing) stator vanes (Fig. 44) were investigated on the ANCF rig and then tested in the 9×15 LSWT. Small Helmholtz resonators were embedded inside the stators and tuned to reduce dominant fan noise frequencies. The resonators would also reduce the unsteady aerodynamic response of the stators to passing fan wakes. Results showed about a 1.5-EPNdB reduction with no measureable aerodynamic losses.

Another strategy was to mix or reduce fan wake strengths before they impinged on the stators. Fan-trailing edge blowing was suggested by MIT and successfully tested in the ANCF rig

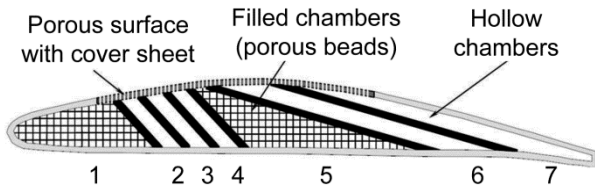

Figure 44.—Sound-absorbing fan stators for fan noise reduction.

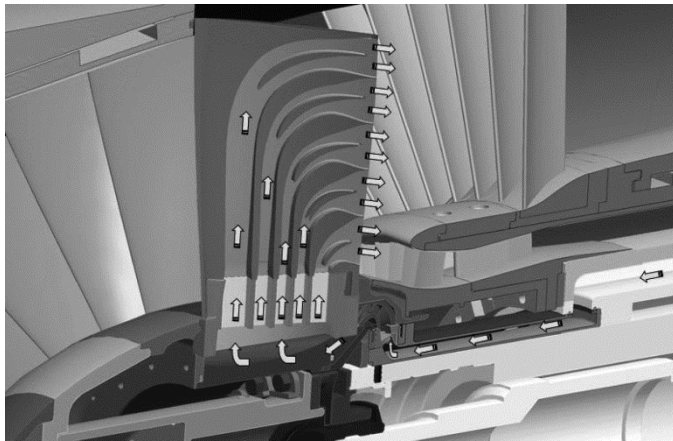

Figure 45.—Fan trailing edge blowing for fan noise reduction.

(Ref. 75). Then a complex test was carried out in the 9×15 LSWT in 2006 where air was supplied through the drive rig and into multiple channels within each fan blade and ejected through the trailing edge to fill and mix the wakes (Fig. 45). The internal flow passages shown in Figure 45 were designed using CFD and flow measurements were made behind the fan at various blowing rates. Acoustic results showed about 2 dB reduction in the overall PWL using 2 percent of the bypass duct mass flow. Part-span filling was tried to reduce the air requirements, but the noise benefits diminished (Ref. 76). Passive mixing reduction methods were also investigated by GE, NASA, and Virginia Tech and used chevrons on the trailing edges of the fan blades to mix the wakes.

In 2004, Honeywell tested a second QHSF, called the QHSF II, aimed at improving the structural and acoustic performance of the first QHSF fan tested in 1998 (Fig. 46(a)). Modifications were made to the fan and the stators. The results were used to design a fan for the HTF7000 engine that would be used for further noise diagnostic tests. Honeywell was awarded the Engine Validation of Noise and Emissions Reduction Technology contract. A comprehensive series of tests were performed including engine fan wake measurements; caged and in-duct phased microphone arrays; cross-correlation of unsteady flow measurements in the combustor and turbine exit; far-field separation of inlet/aft-radiated noise; in situ acoustic liner impedance measurements; rotating microphone measurements;

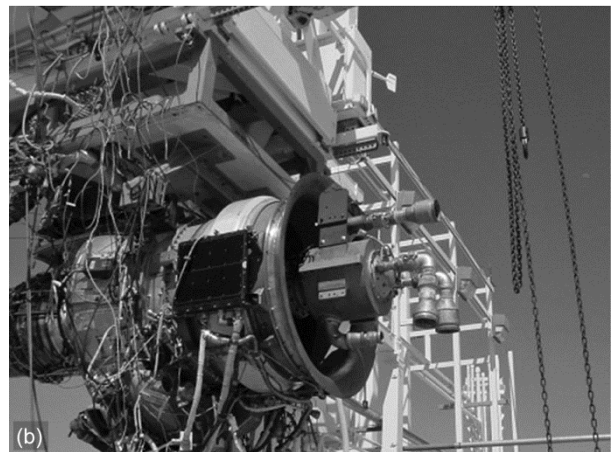
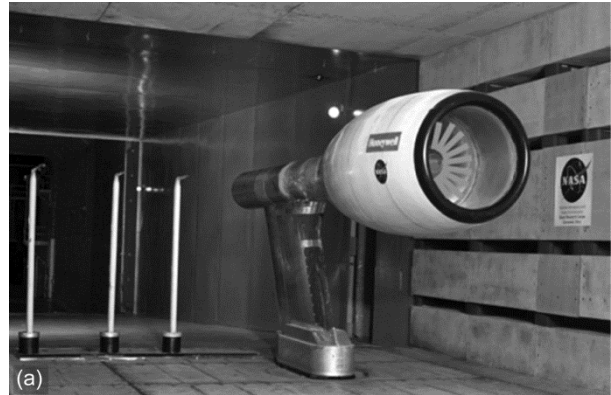

Figure 46.—Honeywell fan and engine tests. (a) QHSF in the 9×15 LSWT. (b) Water brake for testing without a fan.

and engine testing without a fan by using a water brake to provide a load (Fig. 46(b)) (Ref. 77). Adaptive Herschel-Quincke tubes mounted in the fan duct were tested and showed a 2-EPNdB cumulative noise reduction. A special session was organized at the 2008 AIAA Aeroacoustics Conference where papers were presented about all aspects of the test.

Jet noise reduction concepts were focused on offset nozzles to change the noise directivity; chevrons made from shape memory alloys to optimize the penetration angle between takeoff and cruise; and fluidic injection to control the breakup of the streamwise vorticity from mixing devices such as chevrons. Advanced mixers were also tested through a cooperative program with Rolls-Royce. Strong emphasis was placed on flow measurements to improve the understanding of the noise generation process.

The SHJAR rig was built for fundamental tests and screening nozzle concepts. Figure 47 shows some of the test setups used to obtain very detailed databases that have been used to compare and improve jet noise prediction tools (Ref. 26). Similar tests were done in larger scale using the NATR rig.

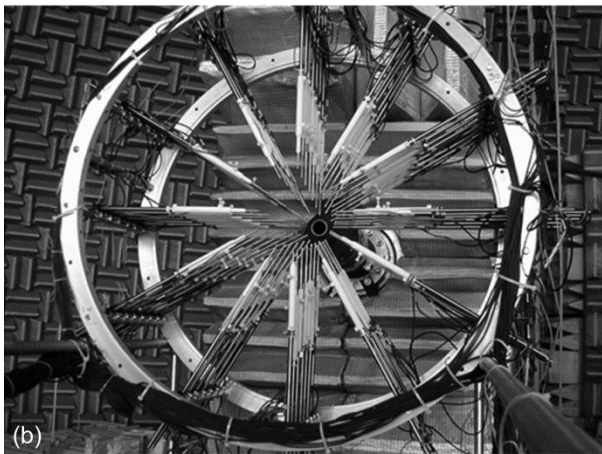
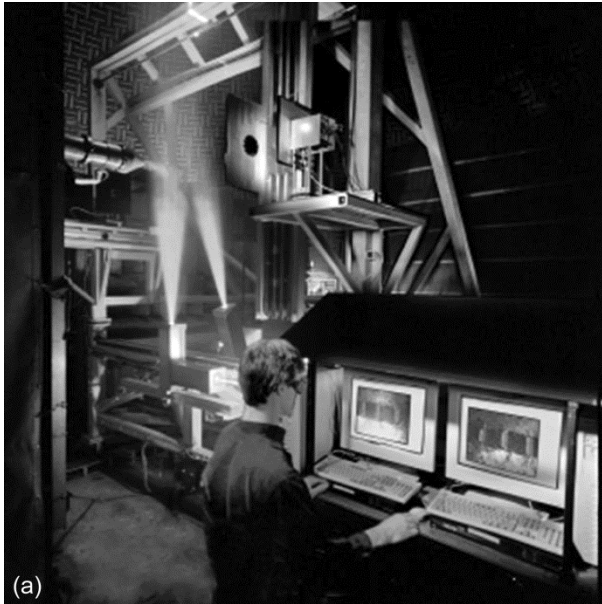

Figure 47.—SHJAR tests. (a) PIV. (b) Microphone array for instability wave diagnostic measurements.

Measurements included three-component PIV (Fig. 47(a)) (Ref. 78), two-point space-time velocity correlations (Ref. 79), and three-dimensional phased microphone arrays (Ref. 80). Arrays of microphones were used to investigate instability waves in the shear layer of the jet and the propagation of sound to the far field (Fig. 47(b)). Investigations also excited the jet with plasma actuators to promote mixing and jet noise reduction. Fundamental experiments were started at The Ohio State University and scaled up to larger nozzle diameters for tests at NASA. Large Eddy Simulations (LESs) were used to model plasma actuators to excite the jet (Ref. 81). Results from the simulations looked promising for scaling to larger jets, but experiments have yet to be successful. A recent review paper (Ref. 82) summarizes the long history of fluidic injection methods for jet noise reduction.

Fundamental Aeronautics Program (FAP)

In 2006, NASA completely reorganized aeronautics to focus on fundamental research in an attempt to return to the NACA roots known for rigorous investigations and comprehensive documentation of results. More emphasis was placed on prediction methods and validation experiments and less on specific aircraft applications. Noise research was split among the Subsonic Fixed Wing (SFW), Supersonics (SUP) and Subsonic Rotary Wing (SRW) projects under the Fundamental Aeronautics Program (FAP). The TWG that was utilized during the AST and QAT programs continued as a way to communicate progress across projects and to keep industry aware of NASA's research in acoustics. The aeronautics budget was reduced compared to the AST and QAT programs, so NASA placed more emphasis on partnerships and cooperative tests with external organizations. Model test hardware that used to be fully funded by NASA was now jointly funded with industry. NASA Research Announcements (NRAs) were used to promote competition by universities and industry for related work. Areas of research focused jointly on noise, emissions, and aircraft performance rather than in separate programs or projects. For subsonic aircraft, NASA focused on utilizing UHB engines (just as it did at the beginning of the AST program). Goals were set based on technologies that would be ready for future generations of aircraft.

Table I shows the noise, emissions, and fuel burn reduction goals for the SFW project. The N+1 goals aimed to reduce the noise for B737- and A320-size aircraft, although the technologies would benefit other aircraft classes. Industry projected that it could meet a 20-EPNdB cumulative noise level under Chapter 4 at a TRL 9 (in service) by utilizing higher bypass ratio engines, or approximately 2/3 of the noise goal set by the AST program in 1992. NASA studies (Ref. 83) showed that if even lower FPRs with noise reduction technologies could be justified (to satisfy other design criteria like emissions and fuel burn), it would be possible to achieve a 25- to 29-EPNdB cumulative below Chapter 4, which almost satisfies the AST and SFW N+1 goals.

NASA believed that the N+1 goals could be achieved with a conventional "tube and wing" aircraft utilizing advanced technologies. However, further noise reduction would be difficult to achieve without some configuration change to help shield the community from the engine noise. Engine noise shielding was observed during flyover tests of a DC-9 in the 1970s. The wings serve as a barrier to reduce the noise radiated from the engine inlet. Studies from noise prediction codes and experiments during the planning for FAP showed that up to a 10-EPNdB cumulative noise reduction could be achieved for radically different commercial aircraft designs such as a blended or hybrid wing body (Ref. 84). As a result, the N+2 noise goals were set to be a 42-EPNdB cumulative below Chapter 4, with the expectation that the aircraft configuration would change from a conventional tube and wing to a configuration such as a hybrid wing body.

TABLE I.—RESEARCH GOALS FOR SUBSONIC AIRCRAFT

Corners of the Trade Space	N+1 (2015) ^a technology benefits relative to a single aisle reference configuration	N+2 (2020) ^a technology benefits relative to a large twin aisle reference configuration	N+3 (2025) ^a technology benefits
Noise (cum below Stage 4)	-32 dB	-42 dB	-71 dB
LTO NOx emissions (below CAEP 6)	-60 percent	-75 percent	Better than -75 percent
Performance aircraft fuel burn	-33 percent ^b	-50 percent ^b	Better than -70 percent
Performance field length	-33 percent	-50 percent	Exploit metroplex ^c concepts

^aTechnology Readiness Level for key technologies = 4 to 6.

^bAdditional gains may be possible through operations improvements.

^cConcepts that enable optimal use of runways at multiple airports with the metropolitan areas.

TABLE II.—RESEARCH GOALS FOR SUPERSONIC AIRCRAFT

	N+1 supersonic business class aircraft (2015)	N+2 small supersonic airliner (2020)	N+3 efficient multi-Mach aircraft (beyond 2030)
Environmental goals			
Sonic boom	65 to 70 PLdB	65 to 70 PLdB	65 to 70 PLdB low-boom flight
Airport noise (cum below Stage 4)	Meet with margin	10 EPNdB	75 to 80 PLdB overwater flight
Cruise emissions (cruise NO _x g/kg of fuel)	Equivalent to current subsonic	<10	10 to 20 EPNdB <5 and particulate and water vapor mitigation
Performance goals			
Cruise speed	Mach 1.6 to 1.8	Mach 1.6 to 1.8	Mach 1.3 to 2.0
Range (n mi)	4000	4000	4000 to 5500
Payload (passengers)	6 to 20	35 to 70	100 to 200
Fuel efficiency (pass-miles per lb of fuel)	1.0	3.0	3.5 to 4.5

The N+2 goals were intended for larger aircraft replacement such as the B777. The N+3 goal for noise was established to meet NASA’s long-term goal of containing the objectionable noise within an average airport boundary. Other studies, including the MIT/Cambridge Silent Aircraft Initiative investigated an aircraft design with noise reduction as the primary goal. Based on these studies, NASA identified the ultimate goal for noise reduction to be about a 71-EPNdB cumulative below Chapter 4 levels, which approximately corresponded to the EPA goal of 55 LDN noise contours at an average airport boundary. This was about 10 dB more aggressive than the 2025 noise reduction that was established by NASA in 1997.

Supersonic aircraft research has focused on airport noise and sonic boom reduction to enable flight over land. The SUP project set similar generational goals starting with smaller aircraft and increasing the size over time. Table II shows the project’s long-term goals. The sonic boom noise goals are specified as perceived noise levels in decibels (PLdB). The

engines planned for commercial supersonic aircraft will use lower BPR turbofans. The engines will need to be compact to meet the performance and sonic boom goals, but will also need to have reduced exhaust velocities during takeoff and landing to meet the airport noise goals. Chevron nozzles used for subsonic aircraft would not provide enough noise reduction so emphasis has been placed on developing variable cycle engines. Military engines are considering a third flow stream that could be closed for cruise, would effectively change the BPR. A third flow stream could also provide more control over the Mach number distribution in the jet with the possibility of implementing inverted velocity profile noise reduction concepts first explored by Glenn in the 1970s (Ref. 19).

NASA awarded contracts to Lockheed and Boeing to study the benefits of a variable cycle engine. GE and Rolls-Royce developed engine concepts aimed at meeting the N+2 goal of a 10-EPNdB cumulative noise reduction under Chapter 4 regulations. Model scale tests were carried out in NATR to investigate mixer-ejector concepts with a third flow stream

and inverted velocity profiles. Predictions from Rolls-Royce, using a mixer-ejector concept, estimated about an 8-EPNdB cumulative noise reduction under Chapter 4 is possible. Test results showed that this could be achieved if extraneous tones could be removed by improving the third stream nozzle hardware design (Refs. 85 and 86). Figure 48(a) shows a reference nozzle with three flow streams and Figure 48(b) shows a three stream mixer-ejector nozzle from Rolls-Royce.

Subsonic research remains focused on fan noise reduction, but core noise is expected to be a concern for future engines as the fan and jet noise are further reduced. Engine data from Honeywell (Ref. 77) has been used to develop correlation methods for separating noise sources. A time delay method (Ref. 87) was developed to separate direct and indirect combustion noise. The intention is to take advantage of the timescale difference between an entropy disturbance traveling with the mean flow from the combustor interacting with the turbine, and the direct sound radiating from the combustor to the far field. Alternative pressure gain combustion concepts have been investigated such as pulse detonation engines (PDEs). Just as the V-1 “buzz bomb” testing disturbed the community around Glenn in 1945, tests of a single PDE tube in the AAPL generated complaints about noise in 2002. The acoustic investigations showed that while the direct noise from the device was high, a turbine placed downstream with the appropriate blade numbers and stages could block enough sound to make the alternative combustor competitive with commercial engine noise levels. For fan noise, the two previous source diagnostics tests in the 9×15 LSWT helped quantify when the rotor alone noise would need to be addressed. A method for reducing rotor noise without relying on further reduction in tip speed or FPR was to add acoustic treatment directly over the tip of the fan. Initial concept tests in the ANCF looked promising and follow-on tests were done in the 9×15 LSWT and with a FJ44 engine (Fig. 49) from Williams International (Ref. 88). Even though the concept looked promising in engine tests, the wind tunnel results showed substantial aerodynamic loss with small reduction in noise due to stator-dominated sources in the test (Ref. 89). Over-the-rotor acoustic treatment is still being investigated along with refinements to the soft stator concept. Fundamental measurement methods were developed to identify fan broadband noise sources within the fan duct (Ref. 90) and would be key in identifying additional fan noise reduction concepts.

Integrated Systems Research Program (ISRP)

In 2010, the Integrated Systems Research Program (ISRP) was established, and the Environmentally Responsible Aviation (ERA) project was started under ISRP to fund system-level validation experiments and concepts that could help meet NASA’s N+2 goals (Table 1). Several concepts that showed

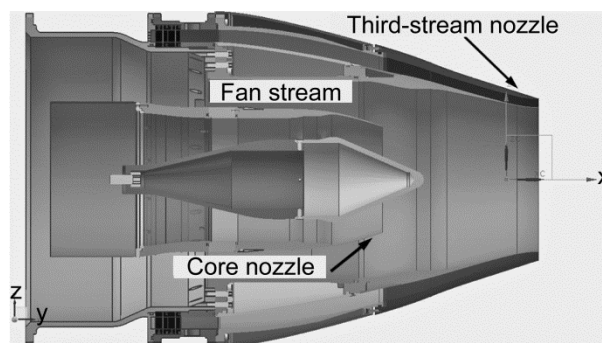

(a)

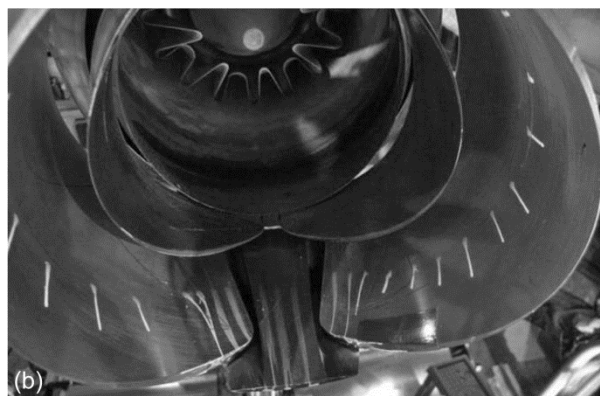

(b)

Figure 48.—Three-stream nozzles for jet noise reduction. (a) Reference nozzle (without mixer). (b) Rolls-Royce mixer-ejector nozzle.

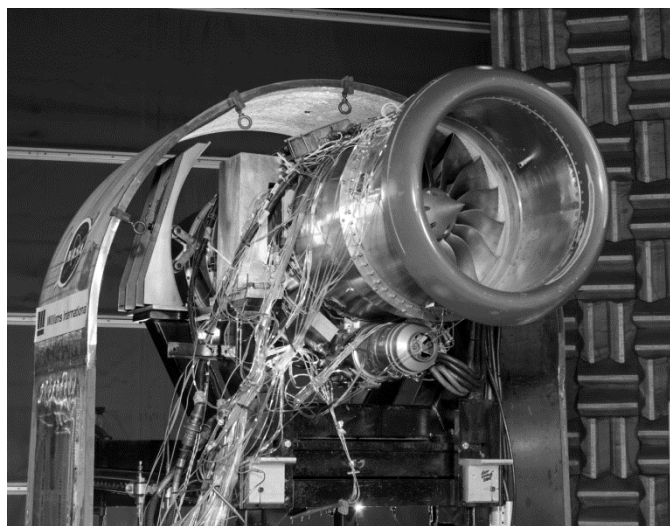

Figure 49.—Williams International FJ44 engine test in the AAPL.

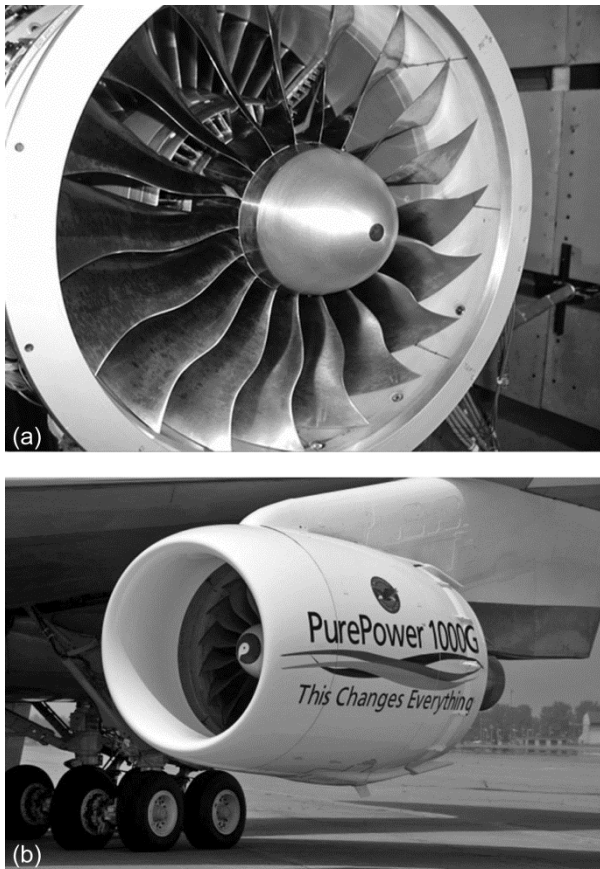

Figure 50.—P&W geared turbofan. (a) Scale model in the 9×15 LSWT test. (b) Full-scale flight test on a P&W 747 test aircraft.

promise for fuel burn and noise reduction were moved from the SFW project into ERA, including P&W’s Geared Turbofan (GTF) and GE’s open rotor. Open rotor was the name given to the follow-on development of GE’s UDF concept. After about 10 years of working exclusively on propellers during ATP followed by about 15 years of working exclusively on turbofans during AST and QAT, Glenn was refining both propulsion systems with hope that these technologies would be used in engines for new aircraft.

The GTF was tested in the 9×15 LSWT in 2007 (Fig. 50(a)) and built on the successful ADP fan tests done in the 1990s. The GTF work led to a flight test funded by P&W (Fig. 50(b)). Several new GTF engines are expected to be introduced by P&W over the next few years. The open rotor was tested from 2009 through 2012 through a jointly funded program between GE and NASA (Fig. 51(a)). Model-scale data were acquired in the 9×15 LSWT and high-speed cruise simulation data were taken in the 8×6 SWT, just as was done during the ATP program in the 1980s. Newer blade designs have shown significantly reduced noise levels compared to the UDF. Valuable flow diagnostic data such as microphone

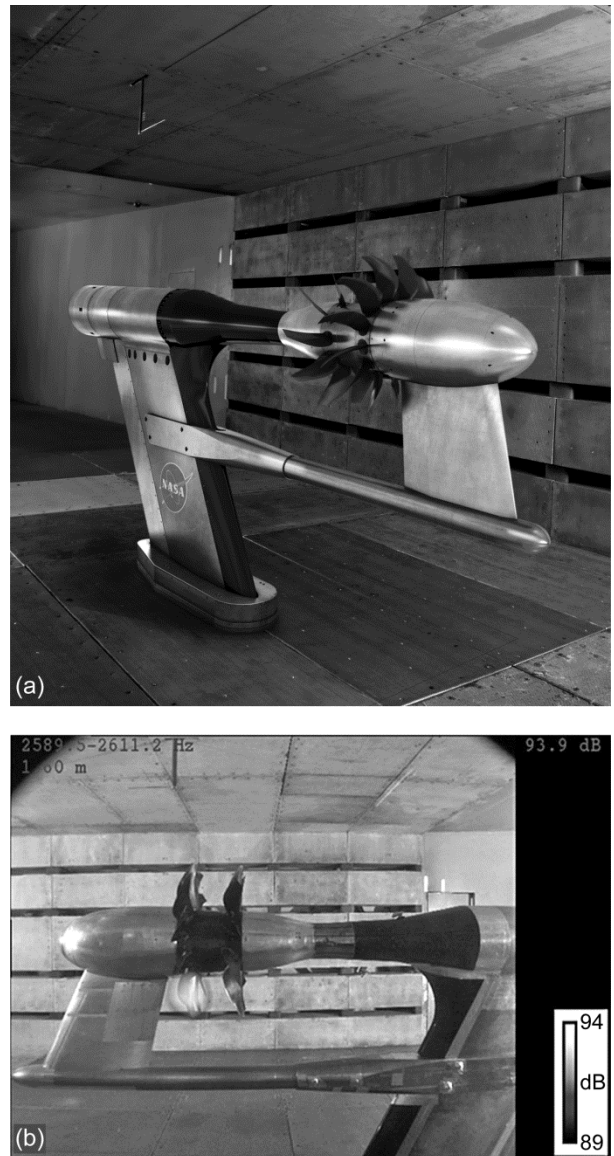

Figure 51.—GE open rotor test in the 9×15 LSWT. (a) Acoustic traverse microphone measurements. (b) Phased microphone array test showing pylon interaction with first rotor (white region on front blades).

phased array and PIV helped to identify dominant noise sources (Fig. 51(b)). NASA conducted a study in 2011 to compare noise and fuel burn predictions for the GTF and open rotor systems based on model data scaled to a B-737-size aircraft using ANOPP (Fig. 52). Results show that at TRLs 4 to 5, the open rotor is expected to be about a 13-EPNdB cumulative under Chapter 4 regulation and the GTF is expected to be about a 25-EPNdB cumulative below Chapter 4. While the noise levels are about 12 EPNdB cumulative higher for the open rotor, the fuel burn was predicted to be about 9 percent less. Industry and market demands will determine which engine will be selected for future aircraft applications.

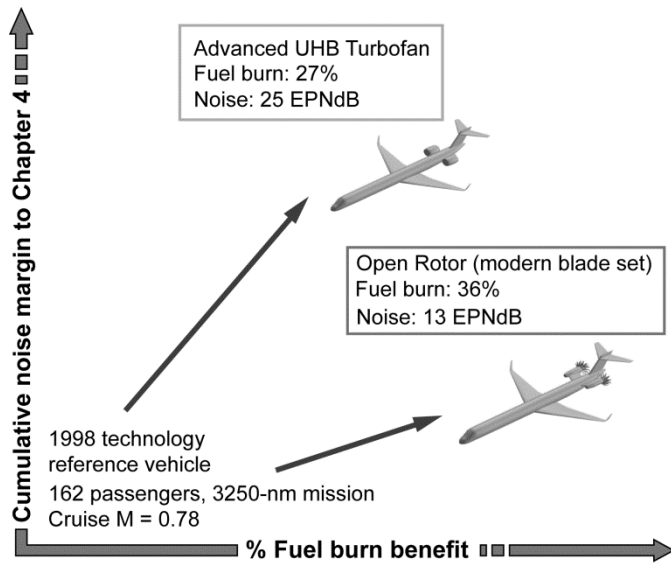

Figure 52.—NASA study for UHB turboprops and open rotor propellers: fuel burn versus noise.

Collaboration and Outreach

Cooperative working relationships with other NASA centers have been critical for the success of engine noise research and the ability to influence technologies for new aircraft. Work with the Department of Defense (DOD) has also been important since the DOD relies on NASA for environmental research in noise and emissions. NASA has participated with the Navy and Air Force on many committees over the years to help assess jet noise problems and possible solutions. NASA’s working relationship with the FAA has led to jointly funded research for commercial engines that typically have been focused more on near-term applications. The most recent example is the FAA’s Continuous Low Emissions, Energy and Noise (CLEEN) program that will help raise the TRL for aircraft to meet the N+1 goals. NASA has provided technical expertise for the AIAA Aeroacoustics Technical Committee the Society for Automotive Engineers (SAE) A21 Aircraft Noise Measure and Noise Aviation Emission Modeling committee; ICAO Independent Expert Review Panels; and source evaluation boards for government procurements. Glenn employees routinely speak at schools and community meetings to raise the awareness on how Glenn’s technologies are being used and to inspire the next generation of acousticians.

The Future

While considerable progress has been made on aircraft noise reduction, additional research is needed to contain objectionable noise levels to the boundaries of an average size airport. The N+3 goals for subsonic aircraft were defined to push technologies even further. It is anticipated that increasing engine BPR will reach a limit where there will be no further

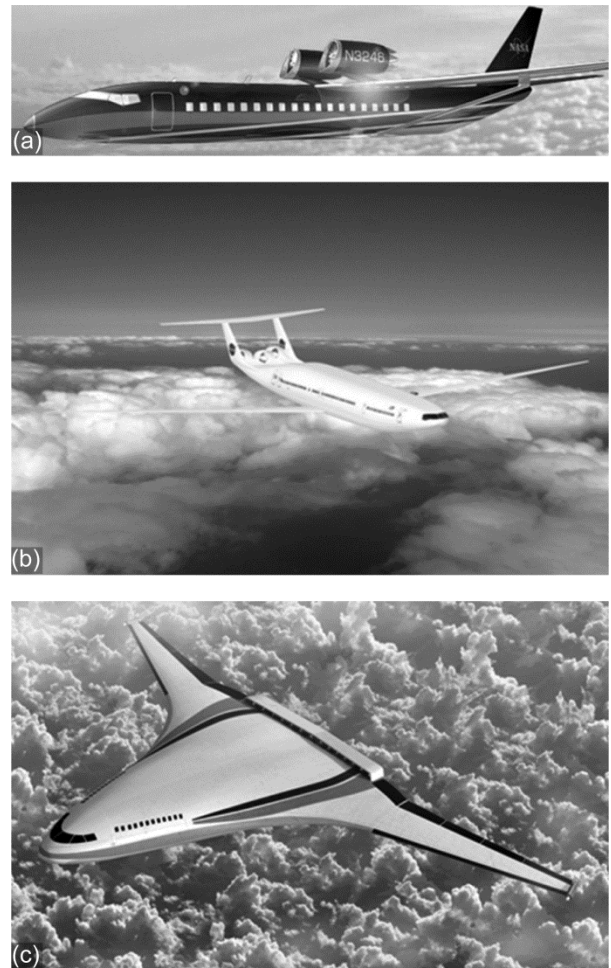

Figure 53.—Advanced aircraft concepts. (a) Engines over wings. (b) MIT Double Bubble with aft engines. (c) NASA turboelectric.

noise reduction benefit. Nacelle lengths will need to be shortened to reduce engine weight, which will reduce the available acoustic treatment area. The primary benefit of increasing BPR has been jet noise reduction. When jet noise levels are significantly below the fan levels and other noise sources, the FPR will have more of an effect. Once a practical limit for lowering the FPR has been reached and the acoustic treatment area cannot be increased, additional engine noise reduction will be difficult to achieve.

One alternative strategy considered in the past shielded the engine noise using the aircraft structure. In 2010, NASA initiated a challenge to the aerospace community to study ways to further reduce the noise, along with fuel burn and emissions. The concepts have been documented (Refs. 91 to 95) and show a general trend of placing engines either above the wing (Fig. 53(a)) or above the fuselage (Fig. 53(b)) to shield the engine noise. The turboelectric aircraft concept, shown in Figure 53(c), uses electrically powered fans with superconducting motors to distribute propulsors across the

trailing edge of a flying wing. The boundary layer from the wing is ingested to provide additional fuel burn reduction benefits. It will take many years before the technologies will be mature enough to introduce these advanced aircraft, but the noise reduction benefits are expected to come close to the ultimate goal of solving the aircraft noise problems that the NACA and NASA have been working on for almost 70 years.

Concluding Remarks

Since the 1970s, the common thread of all aircraft engine noise reduction research programs has been to find ways to move larger amounts of air more slowly through the engine using methods that enhance or do not adversely impact performance. There are similarities between noise reduction methods identified in the 1950s and the concepts being explored today. For example, the original high-aspect-ratio nozzles investigated in the late 1950s are similar to today's distributed propulsion concept. The quest for a low-pressure ratio fan was explored in the short takeoff and landing (STOL) research of the 1970s and Pratt & Whitney's (P&W's) Geared Turbofan will be the first engine to enter service with these characteristics. The difference has been the enabling of technologies like high-fidelity computational fluid dynamics (CFD), lighter

weight structures, improved measurement methods, and better knowledge of the noise generation physics that make today's designs practical and effective. A number of noise reduction concepts that initially appeared not to work were due to inadequate test procedures (extraneous noise sources and masking of sources), and were later found to provide significant noise reduction benefits.

Tremendous progress has been made since the aircraft noise problem peaked in the 1960s and regulations were introduced. The average noise level at each certification point has been reduced by about 20 effective perceived noise level in decibels (EPNdB) over 50 years (60 EPNdB cumulative). Projections for turbofan-powered aircraft show noise levels are expected to be at least a 20-EPNdB cumulative under Chapter 4 for new aircraft with higher BPR engines. Because the impact of aircraft noise also depends on how often noise occurs, the amount of noise reduction needed for each aircraft is greater if the number of flights increase. To achieve the ultimate goal of containing objectionable aircraft noise within the boundaries of an average airport, more work needs to be done. Studies show another 15 to 17 EPNdB at each certification point may be required depending on the size of the airport, aircraft fleet mix, and actual growth in air travel. Glenn has made significant contributions toward achieving this goal.

Appendix—Acronyms

AAPL	Aero-Acoustic Propulsion Laboratory	NACA	National Advisory Committee for Aeronautics
AARC	Aeroacoustic Research Consortium	NASA	National Aeronautics and Space Administration
ACEE	Aircraft Energy Efficiency	NATR	Nozzle Acoustics Test Rig
ADP	Advanced Ducted Propulsor	NRA	NASA Research Announcement
ALNF	Alternative Low Noise Fan	OAI	Ohio Aerospace Institute
AIAA	American Institute of Aeronautics and Astronautics	OTW	over the wing
ANCF	Advanced Noise Control Fan	P&W	Pratt & Whitney
ANOPP	Aircraft Noise Prediction Program	PDE	pulse detonation engine
AST	Advanced Subsonic Technology	PIV	particle image velocimetry
AWT	Altitude Wind Tunnel	PLdB	perceived noise levels in decibels
ATP	Advanced Turboprop	PTA	Propfan Test Assessment
BBN	Bolt, Beranek, and Newman, Inc.	PWL	sound power level
BPR	bypass ratio	QAT	Quiet Aircraft Technology
CAEP	Committee on Aviation Environmental Protection	QCGAT	Quiet, Clean, General Aviation Turbofan
CAA	Computational Aeroacoustics	QCSEE	Quiet, Clean, Short-Haul, Experimental Engine
CFD	computational fluid dynamics	QEP	Quiet Engine Program
CLEEN	Continuous Low Emissions, Energy and Noise	QHSF	Quiet High Speed Fan
DOD	Department of Defense	QSRA	Quiet Short-Haul Research Aircraft
EEE	Energy Efficient Engine	RECAT	Reducing Energy Consumption of Commercial Air Transportation
EPA	Environmental Protection Agency	RSI	Rotor-Stator Interaction (prediction code)
EPNdB	effective perceived noise level in decibels	SAE	Society of Automotive Engineers
EPNL	effective perceived noise level	SDT	source diagnostics test
ERA	Environmentally Responsible Aviation	SFW	Subsonic Fixed Wing project
FAA	Federal Aviation Administration	SHJAR	Small Hot Jet Acoustic Rig
FAR	Federal Aviation Regulation	SPL	sound pressure level
FAP	Fundamental Aeronautics Program	SRW	Subsonic Rotary Wing project
FPR	fan pressure ratio	SST	Supersonic Transport
GE	General Electric	St	Strouhal number
GTF	Geared Turbofan	STOL	short takeoff and landing
HSR	High-Speed Research	SUP	Supersonics project
HW	hot wire	TRL	Technology Readiness Level
ICAO	International Civil Aviation Organization	TWG	Technical Working Group
ICD	inflow control device	UHB	ultrahigh bypass
ISRP	Integrated Systems Research Program	UDF	unducted fan
JeNo	jet noise (prediction code)	UPS	Universal Propulsion Simulator
LDV	laser Doppler velocimetry	UTW	under the wing
LES	Large Eddy Simulation	8×6 SWT	8- by 6-Foot Supersonic Wind Tunnel
MPT	multiple pure tone	9×15 LSWT	9- by 15-Foot Low-Speed Wind Tunnel
		10×10 SWT	10- by 10-Foot Supersonic Wind Tunnel

References

1. International Civil Aviation Organization: ICAO/CAEP Current Activities on Noise Certification. Noise Certification Workshop, Montreal, 2004. http://legacy.icao.int/icao/en/atb/atbworkshops/2004/noise/certificationworkshop_04/Presentations/BIP_5tc.pdf. Accessed July 3, 2012.
2. Dawson, Virginia P.: Engines and Innovation. NASA SP-4306, 1991. <http://ntrs.nasa.gov/>
3. Beranek, Leo: Bolt Beranek & Newman, the United Nations, Big Noise, and the Internet. Riding the Waves, ch. 5, The MIT Press, Cambridge, MA, 2008, p. 103.
4. Davis, Don D.: Acoustical Filters and Mufflers. Handbook of Noise Control, Cyril M. Harris, ed., McGraw-Hill, New York, NY, 1957, pp. 21–40.
5. Burluson, Carl: Aviation and the Environment—Managing the Challenge of Growth. NASA Fundamental Aeronautics Meeting. Federal Aviation Administration Office of Environment and Energy, Washington, DC, 2007.
6. Ciepluch, Carl C., et al.: Acoustics, Thrust, and Drag Characteristics of Several Full-Scale Noise Suppressors for Turbojet Engines. NACA TN-4261, 1958. <http://ntrs.nasa.gov/>
7. Howes, Walton L., et al.: Near Noise Field of a Jet-Engine Exhaust. NACA TR-1338, 1957. <http://ntrs.nasa.gov/>
8. Coles, Willard D.: Jet-Engine Exhaust Noise From Slot Nozzles. NACA TN D-60, 1959. <http://ntrs.nasa.gov/>
9. Feiler, Charles E.; and Groeneweg, John F.: Summary of Forward Velocity Effects on Fan Noise. NASA TM-73722, 1977. <http://ntrs.nasa.gov/>
10. Ciepluch, C.C.: A Review of the QCSEE Program. NASA TM X-71818, 1975. <http://ntrs.nasa.gov/>
11. Dorsch, R.G.; Krejsa, E.A.; and Olsen, W.A.: Blown Flap Noise Research. NASA TM X-67850, 1971. <http://ntrs.nasa.gov/>
12. Dittmar, James H.; Woodward, Richard P.; and MacKinnon, Michael J.: Fan Noise Reduction Achieved by Removing Tip Flow Irregularities Behind the Rotor—Forward Arc Test Configuration. NASA TM-83616, 1984. <http://ntrs.nasa.gov/>
13. Sutliff, D.L.: Rotating Rake Turbofan Duct Mode Measurement System. NASA/TM—2005-213828, 2005. <http://ntrs.nasa.gov/>
14. Loew, R.A., et al.: The Advanced Noise Control Fan. NASA/TM—2006-214368 (AIAA-2006-3150), 2006. <http://ntrs.nasa.gov/>
15. Stone, J.R.: Interim Prediction Method for Jet Noise. NASA TM X-71618, 1974. <http://ntrs.nasa.gov/>
16. Huff, R.G.; Clark, B.J.; and Dorsch, R.G.: Interim Prediction Method for Low Frequency Core Engine Noise. NASA TM X-71627, 1974. <http://ntrs.nasa.gov/>
17. Heidmann, M.F.: Interim Prediction Method for Fan and Compressor Source Noise. NASA TM X-71763, 1975. <http://ntrs.nasa.gov/>
18. Krejsa, E.A.; and Valerino, M.F.: Interim Prediction Method for Turbine Noise. NASA TM X-73566, 1976. <http://ntrs.nasa.gov/>
19. Stone, J.R.: An Empirical Model for Inverted-Velocity-Profile Jet Noise Prediction. NASA TM-73838, 1977. <http://ntrs.nasa.gov/>
20. Stone, James R., et al.: Jet Noise Modeling for Suppressed and Unsuppressed Aircraft in Simulated Flight. NASA/TM—2009-215524, 2009. <http://ntrs.nasa.gov/>
21. Kontos, K.B.; Janardan, B.A.; and Gliebe, P.R.: Improved NASA-ANOPP Noise Prediction Computer Code for Advanced Subsonic Propulsion Systems. NASA CR-195480, 1996. <http://ntrs.nasa.gov/>
22. Saule, A.V.: Modal Structure Inferred From Static Far-Field Noise Directivity. NASA TM X-71909, 1976. <http://ntrs.nasa.gov/>
23. Rice, E.J.: Multimodal Far-Field Acoustic Radiation Pattern: An Approximate Equation. NASA TM-73721, 1977. <http://ntrs.nasa.gov/>
24. Groeneweg, John F., et al.: Turbomachinery Noise. Acoustics of Flight Vehicles: Theory and Practice, Harvey H. Hubbard, ed., Vol. 1, NASA, Langley, VA, 1991.
25. Rice, E.J.: Acoustic Liner Optimum Impedance for Spinning Modes With Mode Cut-Off Ratio as the Design Criterion. NASA TM X-73411, 1976. <http://ntrs.nasa.gov/>
26. Goldstein, M.E.: Aeroacoustics. NASA SP-346, 1974. <http://ntrs.nasa.gov/>
27. Khavaran, Abbas; Bridges, James; and Georgladis: Prediction of Turbulence-Generated Noise in Unheated Jets; Part 1: JeNo Technical Manual (Version 1.0). NASA/TM—2005-213827, 2005. <http://ntrs.nasa.gov/>
28. Bridges, James E.; Khavaran, Abbas; and Hunter, Craig A.: Jet Noise Prediction. Assessment of NASA's Aircraft Noise Prediction Capability, ch. 8., Milo D. Dahl, ed., NASA/TP—2012-215653, 2012, p. 241.
29. Nallasamy, M.; and Envia, E.: Computation of Rotor Wake Turbulence Noise. J. Sound Vib., vol. 282, nos. 3–5, 2005, pp. 649–678.
30. Envia, Edmane, et al.: Fan Noise Prediction. Assessment of NASA's Aircraft Noise Prediction Capability, ch. 5, Milo D. Dahl, ed., NASA/TP—2012-215653, 2012, p. 115.
31. Dahl, Milo D., ed.: Third Computational Aeroacoustic (CAA) Workshop on Benchmark Problems. NASA/CP—2000-209790, 2000. <http://ntrs.nasa.gov/>
32. Dahl, Milo D., ed.: Fourth Computational Aeroacoustics (CAA) Workshop on Benchmark Problems. NASA/CP—2004-212954, 2004. <http://ntrs.nasa.gov/>
33. Lighthill, M.J.: On Sound Generated Aerodynamically. I. General Theory. Proc. R. Soc. Lond. A, vol. 211, 1952, pp. 564–587.
34. Lighthill, M.J.: On Sound Generated Aerodynamically. II. Turbulence as a Source of Sound. Proc. R. Soc. Lond. A, vol. 222, 1954, pp. 1–32.
35. Stitt, Leonard E.: Exhaust Nozzles for Propulsion Systems With Emphasis on Supersonic Cruise Aircraft. NASA RP-1235, 1990. <http://ntrs.nasa.gov/>

36. Kramer, J.J.; and Montegani, F.J.: The NASA Quiet Engine Program. NASA TM X-67988, 1972. <http://ntrs.nasa.gov/>
37. Shovlin, M.D.; and Cochrane, J.A.: An Overview of the Quiet Short-Haul Research Aircraft Program. NASA TM-78545, 1978, <http://ntrs.nasa.gov/>
38. Vance, Tom: NASA QSRA—Quiet Short Haul Research Aircraft NAS Moffett Field 1987 Airshow. Youtube, 1987. <http://www.youtube.com/watch?v=4QiW-ROJtg>. Accessed Feb. 23, 2012.
39. Sams, Eldon W.; and Bresnahan, Donald L.: REFAN Program, Phase I—Summary Report. NASA TM X-71456, 1973. <http://ntrs.nasa.gov/>
40. Abdalla, K.L.; and Yuska, J.A.: NASA REFAN Program Status. TM X-71705, 1975. <http://ntrs.nasa.gov/>
41. Koenig, R.W.; and Sievers, G.K.: Preliminary QCGAT Program Test Results. NASA TM-79013, 1979. <http://ntrs.nasa.gov/>
42. German, Jon; Fogel, Philip; and Wilson, Craig: Design and Evaluation of an Integrated Quiet Clean General Aviation Turbofan (QCGAT) Engine and Aircraft Propulsion System. NASA CR-165185, 1980. <http://ntrs.nasa.gov/>
43. Hildenbrand, R.W.; and Norgren, W.M.: AiResearch QCGAT Program; Quiet Clean General Aviation Turbofan Engines; Final Report. NASA CR-159758, 1980. <http://ntrs.nasa.gov/>
44. Bowles, Mark D.: The “Apollo” of Aeronautics: NASA's Aircraft Energy Efficiency Program 1973-1987. NASA SP-2009-574, 2010. <http://ntrs.nasa.gov/>
45. Hager, Roy D.; and Vrabel, Deborah: Advanced Turbo-prop Project. NASA SP-495, 1988. <http://ntrs.nasa.gov/>
46. Kumasaka, Henry A.; Martinez, Michael M.; and Weir, Donald S.: Definition of 1992 Technology Aircraft Noise Levels and the Methodology for Assessing Airplane Noise Impact of Component Noise Reduction Concepts. NASA CR-198298, 1996. <http://ntrs.nasa.gov/>
47. Gliebe, Philip R.; and Janardan, Bangalore A.: Ultra-High Bypass Engine Aeroacoustic Study. NASA/CR-2003-212525, 2003. <http://ntrs.nasa.gov/>
48. Dalton, W.N., III: Ultra High Bypass Ratio Low Noise Engine Study; Final Report. NASA/CR-2003-212523, 2003. <http://ntrs.nasa.gov/>
49. Holcombe, V.: Aero-Propulsion Technology (APT) Task V Low Noise ADP Engine Definition Study; Final Report. NASA/CR-2003-212521, 2003. <http://ntrs.nasa.gov/>
50. Zaman, K.B.M.Q.; Bridges, J.E.; and Huff, D.L.: Evolution From ‘Tabs’ to ‘Chevron Technology’—A Review. *Aeroacoustics*, vol. 10, nos. 5 and 6, 2011, pp. 685-710.
51. Dittmar, James H.; Elliott, David M.; and Bock, Lawrence A.: Some Acoustic Results From the Pratt and Whitney Advanced Ducted Propulsor—Fan 1. NASA/TM-1999-209049, 1999. <http://ntrs.nasa.gov/>
52. Jeracki, Robert J.: Comprehensive Report of Fan Performance From Duct Rake Instrumentation on 1.294 Pressure Ratio, 806 ft/sec Tip Speed Turbofan Simulator Models. NASA/TM-2006-213863, 2006. <http://ntrs.nasa.gov/>
53. Fite, E. Brian: Fan Performance From Duct Rake Instrumentation on a 1.294 Pressure Ratio, 725 ft/sec Tip Speed Turbofan Simulator Using Vaned Passage Casing Treatment. NASA/TM-2006-214241, 2006. <http://ntrs.nasa.gov/>
54. Envia, Edmane; and Nallasamy, M.: Design Selection and Analysis of a Swept and Leaned Stator Concept. NASA/TM-1998-208662, 1998. <http://ntrs.nasa.gov/>
55. Woodward, Richard P., et al.: Benefits of Swept and Leaned Stators for Fan Noise Reduction. NASA/TM-1998-208661, 1998. <http://ntrs.nasa.gov/>
56. Huff, Dennis L.; and Gliebe, Philip: Recent Progress in Engine Noise Reduction Technologies. 41st AIAA Aerospace Sciences Meeting, Reno, NV, 2003.
57. Hayden, R.E., et al.: Analysis and Design of a High Tip Speed, Low Noise Aircraft Fan Incorporating Swept Leading Edge Rotor and Stator Blades; Progress Report. NASA CR-135092, 1977. <http://ntrs.nasa.gov/>
58. Lieber, Lysbeth; Repp, Russ; and Weir, Donald S.: Quiet High-Speed Fan; Final Report. NASA CR-198518, 1996. <http://ntrs.nasa.gov/>
59. Miller, Christopher J., et al.: Design and Test of Fan/Nacelle Models Quiet High-Speed Fan Design; Final Report. NASA/CR-2003-212369, 2003. <http://ntrs.nasa.gov/>
60. Dittmar, James H.; Elliott, David M.; and Fite, E. Brian: The Noise of a Forward Swept Fan. NASA/ TM-2003-212208, 2003. <http://ntrs.nasa.gov/>
61. Weir, Donald: Design and Test of Fan/Nacelle Models Quiet High-Speed Fan; Final Report. NASA/CR-2003-212370, 2003. <http://ntrs.nasa.gov/>
62. Weir, Donald; and Podboy, Gary G.: Flow Measurements and Multiple Pure Tone Noise From a Forward Swept Fan. AIAA-2005-1200, 2005.
63. Dittmar, James H., et al.: The Alternative Low Noise Fan. NASA/TM-2000-209916, 2000. <http://ntrs.nasa.gov/>
64. Woodward, Richard P., et al.: Fan Noise Source Diagnostic Test—Far Field Acoustic Results. NASA/TM-2002-211591 (AIAA-2002-2427), 2002. <http://ntrs.nasa.gov/>
65. Hughes, Christopher E., et al.: Fan Noise Source Diagnostic Test: Rotor Alone Aerodynamic Performance Results. NASA/TM-2005-211681 (AIAA-2002-2426), 2005. <http://ntrs.nasa.gov/>
66. Podboy, Gary G., et al.: Fan Noise Source Diagnostic Test: LDV Measured Flow Field Results. NASA/TM-2003-212330, 2003. <http://ntrs.nasa.gov/>
67. Heidelberg, Laurence J.: Fan Noise Source Diagnostics Test: Tone Modal Structure Results. NASA/ TM-2002-211594, 2002. <http://ntrs.nasa.gov/>
68. Envia, Edmane: Fan Noise Source Diagnostics Test—Vane Unsteady Pressure Results. NASA/TM-2002-211808 (AIAA-2002-2430), 2002. <http://ntrs.nasa.gov/>

69. Weir, Donald S.: Engine Validation of Noise Reduction Concepts—Separate Flow Nozzles. AIAA–2004–188, 2004.
70. Weir, Donald S.; and Mendoza, Jeff M.: Static and Flight Aeroacoustic Evaluations of a Variable Exhaust Nozzle. AIAA–2005–3049, 2005.
71. Weir, Don; Bouldin, Bruce; and Mendoza, Jeff: Static and Flight Aeroacoustic Evaluations of a Scarf Inlet. AIAA–2006–2462, 2006.
72. U.S. Environmental Protection Agency, Office of Noise Abatement and Control: Information on Levels of Environmental Noise Requisite To Protect Public Health and Welfare With an Adequate Margin of Safety. EPA 550/9–74–004, 1974. <http://www.nonoise.org/library/levels74/levels74.htm> Accessed Feb. 2, 2013.
73. Ohio Aerospace: Institute AeroAcoustic Research Consortium. 2008. <http://www.oai.org/aeroacoustics/challenge.html/> Accessed Feb. 2, 2013.
74. Woodward, Richard P.; and Hughes, Christopher E.: Noise Benefits of Increased Fan Bypass Nozzle Area. AIAA–2005–1201, 2005.
75. Sutliff, Daniel L.: Broadband Noise Reduction of a Low-Speed Fan Using Trailing Edge Blowing. NASA/TM—2005-213814 (AIAA–2005–3028), 2005. <http://ntrs.nasa.gov/>
76. Woodward, Richard P.; Fite, E. Brian; and Podboy, Gary G.: Noise Benefits of Rotor Trailing Edge Blowing for a Model Turbofan. NASA/TM—2007-214666, 2007. <http://ntrs.nasa.gov/>
77. Weir, D., ed.: Engine Validation of Noise and Emission Reduction Technology Phase I. NASA/CR—2008-215225, 2008. <http://ntrs.nasa.gov/>
78. Bridges, James; and Wernet, Mark: Measurements of Aeroacoustic Sound Source in Hot Jets. NASA/TM—2004-212508 (AIAA–2003–3130), 2004. <http://ntrs.nasa.gov/>
79. Bridges, James; and Brown, Clifford A.: Parametric Testing of the Chevrons on Single Flow Hot Jets. NASA/TM—2004-213107 (AIAA–2004–2824), 2004. <http://ntrs.nasa.gov/>
80. Lee, Sang Soo; and Bridges, James: Phased-Array Measurements of Single Flow Hot Jets. NASA/TM—2005-213826, 2005. <http://ntrs.nasa.gov/>
81. Brown, Clifford A.: Scalability of Localized Arc Filament Plasma Actuators. NASA/TM—2008-215278 (AIAA–2008–3043), 2008. <http://ntrs.nasa.gov/>
82. Henderson, Brenda: Fifty Years of Fluidic Injection for Jet Noise Reduction. *International Journal of Aeroacoustics*, vol. 9, nos. 1 and 2, 2010, pp. 91–122.
83. Guynn, Mark D., et al.: Refined Exploration of Turbofan Design Options for an Advanced Single-Aisle Transport. NASA/TM—2011-216883, 2011. <http://ntrs.nasa.gov/>
84. Thomas, Russell H.; Burley, Casey L.; and Olson, Erik D.: Hybrid Wing Body Aircraft System Noise Assessment With Propulsion Airframe Aeroacoustic Experiments. AIAA–2010–3913, 2010.
85. Sokhey, Jack S.: N+2 Low Noise Exhaust Nozzle Validation—RRLW Mixer-Ejector Concept. Proceedings From the Fundamental Aeronautics Program Technical Conference, Cleveland, OH, 2012.
86. Henderson, Brenda S.: Aeroacoustics of Three-Stream Jets. AIAA–2012–2159, 2012.
87. Miles, Jeffrey Hilton: Spectral Separation of the Turbofan Engine Coherent Combustion Noise Component. NASA/TM—2008-215157, 2008. <http://ntrs.nasa.gov/>
88. Sutliff, D. L., et al.: Attenuation of FJ44 Turbofan Engine Noise With a Foam-Metal Liner Installed Over-the-Rotor. NASA/TM—2009-215666 (AIAA–2009–3141), 2009. <http://ntrs.nasa.gov/>
89. Elliott, David M.; Woodward, Richard P.; and Podboy, Gary G.: Acoustic Performance of Novel Fan Noise Reduction Technologies for a High Bypass Model Turbofan at Simulated Flight Conditions. NASA/TM—2010-215841 (AIAA–2009–3140), 2010. <http://ntrs.nasa.gov/>
90. Dougherty, Robert P.; Walker, Bruce E.; and Sutliff, Daniel L.: Locating and Quantifying Broadband Fan Sources Using In-Duct Microphones. NASA/TM—2010-216931 (AIAA–2010–3736), 2010. <http://ntrs.nasa.gov/>
91. Bradley, Marty K.; and Droney, Christopher K.: Subsonic Ultra Green Aircraft Research: Phase I Final Report. NASA/CR—2011-216847, 2011. <http://ntrs.nasa.gov/>
92. Greitzer, E.M., et al.: N+3 Aircraft Concept Designs and Trade Studies, Final Report. NASA/CR—2010-216794, vols. 1 and 2, 2010. <http://ntrs.nasa.gov/>
93. Bruner, Sam, et al.: NASA N+3 Subsonic Fixed Wing Silent Efficient Low-Emissions Commercial Transport (SELECT) Vehicle Study. NASA/CR—2010-216798, 2010. <http://ntrs.nasa.gov/>
94. D’Angelo, Martin M., et al.: N+3 Small Commercial Efficient and Quiet Transportation for Year 2030–2035. NASA/CR—2010-216691, 2010. <http://ntrs.nasa.gov/>
95. Felder, James L., et al.: Turboelectric Distributed Propulsion in a Hybrid Wing Body Aircraft. ISABE–2011–1340, 2011.

REPORT DOCUMENTATION PAGE			Form Approved OMB No. 0704-0188		
<p>The public reporting burden for this collection of information is estimated to average 1 hour per response, including the time for reviewing instructions, searching existing data sources, gathering and maintaining the data needed, and completing and reviewing the collection of information. Send comments regarding this burden estimate or any other aspect of this collection of information, including suggestions for reducing this burden, to Department of Defense, Washington Headquarters Services, Directorate for Information Operations and Reports (0704-0188), 1215 Jefferson Davis Highway, Suite 1204, Arlington, VA 22202-4302. Respondents should be aware that notwithstanding any other provision of law, no person shall be subject to any penalty for failing to comply with a collection of information if it does not display a currently valid OMB control number.</p> <p>PLEASE DO NOT RETURN YOUR FORM TO THE ABOVE ADDRESS.</p>					
1. REPORT DATE (DD-MM-YYYY) 01-12-2013		2. REPORT TYPE Technical Paper		3. DATES COVERED (From - To)	
4. TITLE AND SUBTITLE NASA Glenn's Contributions to Aircraft Engine Noise Research			5a. CONTRACT NUMBER		
			5b. GRANT NUMBER		
			5c. PROGRAM ELEMENT NUMBER		
6. AUTHOR(S) Huff, Dennis, L.			5d. PROJECT NUMBER		
			5e. TASK NUMBER		
			5f. WORK UNIT NUMBER WBS 432938.11.01.03.02.03.08		
7. PERFORMING ORGANIZATION NAME(S) AND ADDRESS(ES) National Aeronautics and Space Administration John H. Glenn Research Center at Lewis Field Cleveland, Ohio 44135-3191			8. PERFORMING ORGANIZATION REPORT NUMBER E-18290-1		
9. SPONSORING/MONITORING AGENCY NAME(S) AND ADDRESS(ES) National Aeronautics and Space Administration Washington, DC 20546-0001			10. SPONSORING/MONITOR'S ACRONYM(S) NASA		
			11. SPONSORING/MONITORING REPORT NUMBER NASA/TP-2013-217818		
12. DISTRIBUTION/AVAILABILITY STATEMENT Unclassified-Unlimited Subject Categories: 01 and 07 Available electronically at http://www.sti.nasa.gov This publication is available from the NASA Center for AeroSpace Information, 443-757-5802					
13. SUPPLEMENTARY NOTES					
14. ABSTRACT This report reviews all engine noise research conducted at the NASA Glenn Research Center over the past 70 years. This report includes a historical perspective of the Center and the facilities used to conduct the research. Major noise research programs are highlighted to show their impact on industry and on the development of aircraft noise reduction technology. Noise reduction trends are discussed, and future aircraft concepts are presented. Since the 1960s, research results show that the average perceived noise level has been reduced by about 20 decibels (dB). Studies also show that, depending on the size of the airport, the aircraft fleet mix, and the actual growth in air travel, another 15 to 17 dB reduction will be required to achieve NASA's long-term goal of providing technologies to limit objectionable noise to the boundaries of an average airport.					
15. SUBJECT TERMS Turbofan; Turbojet; Aircraft engine noise; Acoustics; Aeroacoustics; Fans; Jets; Turbomachinery; Noise reduction					
16. SECURITY CLASSIFICATION OF:			17. LIMITATION OF ABSTRACT	18. NUMBER OF PAGES	19a. NAME OF RESPONSIBLE PERSON
a. REPORT	b. ABSTRACT	c. THIS PAGE			STI Help Desk (email:help@sti.nasa.gov)
U	U	U	UU	50	19b. TELEPHONE NUMBER (include area code) 443-757-5802

