



Communications Technology Assessment for the Unmanned Aircraft System (UAS) Control and Non-Payload Communications (CNPC) Link

Steven C. Bretmersky
MTI Systems, Inc., Cleveland, Ohio

William D. Bishop
Verizon Federal Network Systems, LLC., Arlington, Virginia

Justin E. Dailey
MTI Systems, Inc., Cleveland, Ohio

Christine T. Chevalier
Vantage Partners, LLC, Brook Park, Ohio

NASA STI Program . . . in Profile

Since its founding, NASA has been dedicated to the advancement of aeronautics and space science. The NASA Scientific and Technical Information (STI) program plays a key part in helping NASA maintain this important role.

The NASA STI Program operates under the auspices of the Agency Chief Information Officer. It collects, organizes, provides for archiving, and disseminates NASA's STI. The NASA STI program provides access to the NASA Aeronautics and Space Database and its public interface, the NASA Technical Reports Server, thus providing one of the largest collections of aeronautical and space science STI in the world. Results are published in both non-NASA channels and by NASA in the NASA STI Report Series, which includes the following report types:

- **TECHNICAL PUBLICATION.** Reports of completed research or a major significant phase of research that present the results of NASA programs and include extensive data or theoretical analysis. Includes compilations of significant scientific and technical data and information deemed to be of continuing reference value. NASA counterpart of peer-reviewed formal professional papers but has less stringent limitations on manuscript length and extent of graphic presentations.
- **TECHNICAL MEMORANDUM.** Scientific and technical findings that are preliminary or of specialized interest, e.g., quick release reports, working papers, and bibliographies that contain minimal annotation. Does not contain extensive analysis.
- **CONTRACTOR REPORT.** Scientific and technical findings by NASA-sponsored contractors and grantees.

- **CONFERENCE PUBLICATION.** Collected papers from scientific and technical conferences, symposia, seminars, or other meetings sponsored or cosponsored by NASA.
- **SPECIAL PUBLICATION.** Scientific, technical, or historical information from NASA programs, projects, and missions, often concerned with subjects having substantial public interest.
- **TECHNICAL TRANSLATION.** English-language translations of foreign scientific and technical material pertinent to NASA's mission.

Specialized services also include creating custom thesauri, building customized databases, organizing and publishing research results.

For more information about the NASA STI program, see the following:

- Access the NASA STI program home page at <http://www.sti.nasa.gov>
- E-mail your question to help@sti.nasa.gov
- Fax your question to the NASA STI Information Desk at 443-757-5803
- Phone the NASA STI Information Desk at 443-757-5802
- Write to:
STI Information Desk
NASA Center for AeroSpace Information
7115 Standard Drive
Hanover, MD 21076-1320



Communications Technology Assessment for the Unmanned Aircraft System (UAS) Control and Non-Payload Communications (CNPC) Link

Steven C. Bretmersky
MTI Systems, Inc., Cleveland, Ohio

William D. Bishop
Verizon Federal Network Systems, LLC., Arlington, Virginia

Justin E. Dailey
MTI Systems, Inc., Cleveland, Ohio

Christine T. Chevalier
Vantage Partners, LLC, Brook Park, Ohio

Prepared under Contract NNC12BA01B

National Aeronautics and
Space Administration

Glenn Research Center
Cleveland, Ohio 44135

Trade names and trademarks are used in this report for identification only. Their usage does not constitute an official endorsement, either expressed or implied, by the National Aeronautics and Space Administration.

Level of Review: This material has been technically reviewed by expert reviewer(s).

Available from

NASA Center for Aerospace Information
7115 Standard Drive
Hanover, MD 21076-1320

National Technical Information Service
5301 Shawnee Road
Alexandria, VA 22312

Available electronically at <http://www.sti.nasa.gov>

Table of Contents

1 Introduction	1
2 Candidate Technology Identification	3
3 Initial Technology Review and Downselection	4
3.1 Cellular Family.....	4
3.1.1 CDMA (IS-95A)	4
3.1.2 CDMAone (IS-95B)	5
3.1.3 Mobitex.....	5
3.1.4 Flash-OFDM.....	5
3.2 IEEE 802 Derivatives Family	5
3.2.1 IEEE 802.15.....	5
3.2.2 HIPERPAN	5
3.2.3 HIPERLAN	5
3.2.4 HIPERMAN.....	5
3.3 Public Safety Family	6
3.3.1 EDACS.....	6
3.3.2 IDEN.....	6
3.3.3 Project MESA.....	6
3.3.4 TETRA Release 1.....	6
3.3.5 TETRA Release 2 (TAPS)	6
3.4 Custom Family.....	6
3.4.1 ACARS.....	6
3.4.2 ADL.....	7
3.4.3 B-VHF.....	7
3.4.4 E-TDMA	7
3.4.5 Gatelink.....	7
3.4.6 HFDL.....	7
3.4.7 AMACS.....	7
3.4.8 Mode S.....	7
3.4.9 UAT.....	8
3.4.10 VDL Mode 2.....	8
3.4.11 VDL Mode 3, xDL3, LDL, Mode 3 with SAIC.....	8
3.4.12 VDL Mode E.....	8
3.5 Military Family	8

3.6 Satellite Family	8
3.7 Other Family.....	9
3.7.1 Airfone	9
3.7.2 AirCell.....	9
3.7.3 SkyWay.....	9
4 Technology Evaluation Criteria	10
4.1 Air/Ground Communications Criteria	10
4.2 Data Transmission Criteria	11
4.3 Mobility Criteria	12
4.4 Security Criteria.....	13
4.5 Traffic QoS Criteria.....	14
4.6 Standardization and Certification Criteria	15
4.7 Waveform Criteria	16
5 Technology Evaluations	18
5.1 Cellular Family.....	18
5.1.1 TDMA (IS-136).....	18
5.1.2 GSM.....	21
5.1.3 GPRS.....	23
5.1.4 EDGE.....	25
5.1.5 UMTS (W-CDMA/TD-CDMA/TD-SCDMA).....	27
5.1.6 CDMA2000 (1x-3xRTT, 1x EVDV).....	30
5.1.7 EVDO	33
5.1.8 LTE.....	34
5.1.9 DECT	40
5.2 IEEE 802 Family	43
5.2.1 802.11	43
5.2.2 802.16	46
5.2.3 802.20	50
5.3 Public Safety Family	53
5.3.1 P-25	53
5.3.2 P-34	56
5.3.3 IDRA.....	58
5.3.4 TETRAPOL.....	61
5.3.5 TETRA Release 2 (TEDS)	64
5.4 Custom Solutions Family.....	67

5.4.1 VDL Mode 4.....	67
5.4.2 L-DACS 1.....	71
5.4.3 L-DACS 2.....	74
5.4.4 STANAG 4660.....	77
5.5 Evaluation Summary.....	80
6 Technology Comparisons and Downselection.....	82
7 Potential CNPC Systems.....	88
7.1 LTE-based CNPC.....	88
7.1.1 Frame Configuration.....	89
7.1.2 Architecture Overview.....	91
7.1.3 Network entry / initialization.....	92
7.2 802.16-based CNPC.....	96
7.2.1 Network entry / initialization.....	98
7.2.2 Data transfer.....	99
7.2.3 Handoff.....	102
7.3 P-34-based CNPC.....	103
7.3.1 Network entry / initialization.....	105
7.3.2 Data transfer.....	106
7.3.3 Handoff.....	107
7.4 TEDS-based CNPC.....	108
7.4.1 Network entry / initialization.....	110
7.4.2 Data transfer.....	111
7.4.3 Handoff.....	111
7.5 Summary.....	112
Appendix A. Abbreviations.....	113
Appendix B. References.....	119

Communications Technology Assessment for the Unmanned Aircraft System (UAS) Control and Non-Payload Communications (CNPC) Link

Steven C. Bretmersky
MTI Systems, Inc.
Cleveland, Ohio 44135

William D. Bishop
Verizon Federal Network Systems, LLC
Arlington, Virginia 22209

Justin E. Dailey
MTI Systems, Inc.
Cleveland, Ohio 44135

Christine T. Chevalier
Vantage Partners, LLC
Brook Park, Ohio 44142

1 Introduction

The National Aeronautics and Space Administration (NASA) Glenn Research Center (GRC) is performing communications systems research for the Unmanned Aircraft System (UAS) in the National Airspace System (NAS) Project. One of the goals of the communications element is to select and test a communications technology for the UAS Control and Non-Payload Communications (CNPC) link. The GRC UAS Modeling and Simulation (M/S) Sub Team will evaluate the performance of several potential technologies for the CNPC link through detailed software simulations. In parallel, an industry partner will implement a technology in hardware to be used for flight testing.

The task necessitated a technical assessment of existing Radio Frequency (RF) communications technologies to identify the best candidate systems for use as the UAS CNPC link. The assessment provides a basis for selecting the technologies for the M/S effort and the hardware radio design. The process developed for the technical assessments for the Future Communications Study¹ (FCS) was used as an initial starting point for this assessment. The FCS is a joint Federal Aviation Administration (FAA) and Eurocontrol study on technologies for use as a future aeronautical communications link. The FCS technology assessment process methodology can be applied to the UAS CNPC link; however the findings of the FCS are not directly applicable because of different requirements between a CNPC link and a general aeronautical data link.

Additional technologies were added to the potential technologies list from the State of the Art Unmanned Aircraft System Communication Assessment developed by NASA GRC². This document investigates the state of the art of communications as related to UAS. A portion of the document examines potential communications systems for a UAS communication architecture. Like the FCS, the state of the art assessment surveyed existing communications technologies. It did not, however, perform a detailed assessment of the technology necessary to recommend a technology for the UAS CNPC link.

The technical assessment process, as shown in Figure 1, consists of the following steps. First, candidate RF communications technologies are identified. An initial review of each of these technologies is then performed to determine if the technology appears to be a good candidate and requires further review. Any technology that can be shown to be inadequate at that point is removed from consideration to allow for more detailed analysis of the remaining technologies. Criteria for the detailed assessments are defined and a scoring methodology is devised. This is followed by the detailed review and scoring of each technology. The least favorable technologies are removed during the process until only the few best candidates remain.

¹ Technology Assessment for the Future Aeronautical Communications Study, NASA/CR 2005-213587

² State of the Art Unmanned Aircraft System Communication Assessment, PACE III-A2901-D15 rev2

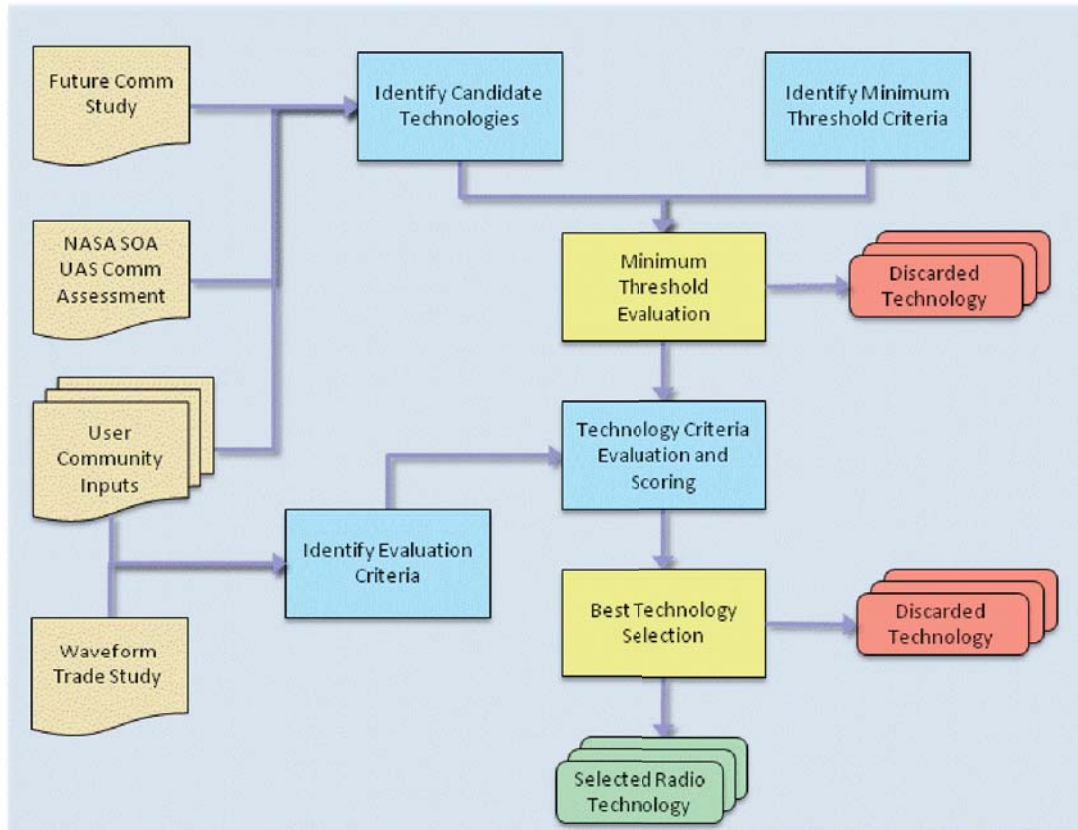

Figure 1. Technical assessment process

Based on discussions with external partners, the best identified technologies are reviewed and one is selected as the best candidate for use as an initial CNPC system. This candidate will be used as the basis for the CNPC technology implemented in the prototype radio. The technology will be modified as necessary for the needs of the UAS CNPC communications link. Along with the prototype development, the technology will be utilized in simulations to help develop the system.

The remaining identified technologies will be developed into simulation models for further investigation as alternative solutions for the CNPC communications technology and compared with the selected technology.

2 Candidate Technology Identification

This evaluation has many similarities to the work performed for the FCS. As such, the initial list of technologies identified by the FCS is carried forward into this study. These technologies were separated into several families, which for the most part have been retained here. Notably, the FCS had custom narrowband separated from wideband technologies. In this analysis these are all assembled into a single custom category.

The list of technologies is also augmented with additional technologies identified through other sources. One additional source for these technologies is the UAS Project Communications Gap Analysis. The completed list of technologies is contained in Table 1.

Table 1. Potential Technology List

Family	Potential Technologies
Cellular	TDMA (IS-136), CDMA (IS-95A), CDMAone (IS-95B), UMTS (W-CDMA, TD-CDMA, TD-SCDMA), CDMA2000, CDMA2000 1xEV, CDMA2000 3x, GSM/GPRS/EDGE, EV-DO Rev. A, EV-DV, DECT, LTE, Mobitex, Flash-OFDM
IEEE 802 Derivatives	IEEE 802.11, 802.15, 802.16, 802.20, ETSI HIPERLAN, HIPERMAN
Public Safety	P-25 Phase 1, P-25 Phase 2, TETRA Release 1, TETRAPOL, iDRA (RTR-STD-32A), IDEN, EDACS, P-34 (TIA-902), TETRA Release 2 (TAPS), TETRA Release 2 (TEDS), Project MESA
Custom	HF Data Link, ACARS, VDL Mode 2, VDL Mode 3, VDL Mode 4, VDL Mode E, VDL Mode 3 with SAIC, E-TDMA, ADL, B-VHF, UAT, Mode S, Gatelink, L-DACS 1, L-DACS 2, AMACS, LDL (xDL3), xDL4, STANAG 4660
Military	TADIL-J/Link 16, SINCGARS, EPLRS, HAVEQUICK, JTRS, ATDL-1, JREAP, JTIDS, Link 22, MUOS, MADL, TADIL-A/Link 11, TADIL-B/Link 11B, TADIL-C/Link 4
Satellite	Connexion by Boeing, IGSAGS, SDLS, Thuraya, Inmarsat, Boeing, Sensis, Iridium, Globalstar, Direct Broadcast Satellite System, HughesNet, ICO, Intelsat, LightSquared, Live TV, Orbcomm, S-DARS Sirius, S-DARS XM, SES, TerreStar
Other	Airfone, AirCell, SkyWay

3 Initial Technology Review and Downselection

An initial technology review was performed to obtain a preliminary understanding of each of the potential technologies. This review focused on assembling background information and the technology basics to identify any that can be quickly discarded. For this review, technical publications were preferred as sources over the technology standards. A more detailed review of the remaining technologies based on the standards will be performed in a later stage.

A set of minimum thresholds was identified for the initial technology review to eliminate unsuitable technologies. These criteria were carefully chosen to allow this elimination without a time consuming in-depth analysis of the technology. The minimum criteria selected are:

- *The technology must be non-proprietary with open standards and exportable* – The NASA UAS communications task intends to align with the RTCA special committee for UAS (SC-203) which will produce a Minimum Aviation System Performance Standard (MASPS) for the UAS CNPC link. The technology selected must allow for this public standardization and ideally not have licensing restrictions. The technology must also not be export-controlled to allow for international harmonization on the standard.
- *The technology must be sufficiently mature* – The basis for the CNPC link must have enough maturity to be implemented. To meet this minimum threshold requirement, the technology must be defined by a completed standard.
- *The technology must be capable of supporting the necessary channel access rate for control of the UAS* – A high rate of messaging will be required to manually operate the UA. SC-203 has identified a message repetition rate of 20 Hz as necessary. As such the CNPC must be capable of supporting the required rate without relying on buffering and batch delivery of messages. Some systems, such as Time Division Multiple Access (TDMA) systems with longer frame times, may not be able to meet this rate and will be excluded from further analysis. However, considering that the technology may be modified over its standard form to increase the possible access rate, a conservative value of 10 Hz is used as the minimum threshold.
- *The technology must be sufficiently dissimilar to other evaluated technologies* – Some technologies are based on others or are extensions of other technologies. When appropriate, technologies that are shown to be similar to other evaluated technologies are removed from consideration. When a technology has subsequent revisions that have not significantly modified the original technology, the newer revisions are evaluated.

Technologies that did not meet the minimum criteria and removed from consideration are discussed in the following subsections.

3.1 Cellular Family

3.1.1 CDMA (IS-95A)

IS-95A was the second iteration of commercial cellular Code Division Multiple Access (CDMA) (IS-95 was the first) and considered to be 2G with two fixed device vocoder rate sets. It was superseded by more

advanced versions of the technology which is why it was eliminated from future consideration as a UAS CNPC link.

3.1.2 CDMAone (IS-95B)

CDMA IS-95B is the Phase II derivative of CDMA IS-95A with other standards included. Domestic wireless carriers went directly from IS-95A to CDMA 2000 1X which is why it was eliminated from future consideration as a UAS CNPC link. CDMA 2000 1X and wideband versions of CDMA, however, did pass the initial review and are evaluated in the next section.

3.1.3 Mobitex

Although some sources cite that Mobitex is an open standard technology, only the upper layer interface standard is open and freely available. The radio specifications for Mobitex are licensed³ therefore this technology cannot be classified as open and will not be considered.

3.1.4 Flash-OFDM

The Fast Low-latency Access with Seamless Handoff – Orthogonal Frequency Division Multiplexing (Flash-OFDM) is a proprietary technology developed by Flarion. It was designed as an alternative to the GSM and 3G networks. Because Flash-OFDM is a licensed proprietary technology it will not be considered for the CNPC link.

3.2 IEEE 802 Derivatives Family

3.2.1 IEEE 802.15

IEEE 802.15 is a technology that is classified as a Personal Area Network (PAN) that is generally defined by low power and short range devices. The maximum range of an 802.15 device is typically around 10 meters, which is far short of the range required for UAS. IEEE 802.15 is not considered for the UAS CNPC link.

3.2.2 HIPERPAN

High Performance Radio Personal Area Network (HIPERPAN) is a PAN technology standardized by the European Telecommunications Standards Institute (ETSI) that is closely related to IEEE 802.15. The design of HIPERPAN also blends some features of 802.11 and HIPERLAN. Given the distance limitation of PAN technologies and the similarity of HIPERPAN to 802.11 and HIPERLAN, this technology is not considered.

3.2.3 HIPERLAN

High Performance Radio Local Area Network (HIPERLAN) is an ETSI standard that is an alternative to IEEE 802.11 that provides Local Area Network (LAN) functionality. HIPERLAN/2 uses an equivalent physical layer as 802.11a. However, unlike the Carrier Sense Multiple Access with Collision Avoidance (CSMA/CA) protocol used in 802.11, HIPERLAN/2 uses a TDMA protocol. HIPERLAN/2 is still deemed similar to IEEE 802.11 and will not be considered separately.

3.2.4 HIPERMAN

High Performance Radio Metropolitan Area Network (HIPERMAN) is an ETSI standard that is an alternative to IEEE 802.16. HIPERMAN uses the same basic Medium Access Control (MAC) protocol as

³ http://www.mobitex.com/company/download_MIS.asp

802.16. HIPERMAN is interoperable with a subset of the 802.16a standard⁴. Since this technology is so close to 802.16, it will not be considered separately.

3.3 Public Safety Family

3.3.1 EDACS

Enhanced Digital Access Communication System (EDACS) is a proprietary, closed standard technology by General Electric. Because the technologies protocols and interfaces are proprietary, EDACS will not be considered further.

3.3.2 IDEN

Integrated Digital Enhanced Network (IDEN) is a proprietary, closed-standard technology developed by Motorola. IDEN uses a TDMA protocol to provide push-to-talk capabilities for up to 6 simultaneous voice users per 25 kHz channel. It is the technology used by the Digital Integrated Mobile Radio System (DIMRS). IDEN is similar to IDRA in that it is a 6-slot TDMA system using 16QAM in 25 kHz channels. Because IDEN is proprietary and similar to the open-standard IDRA technology, IDEN will not be considered further.

3.3.3 Project MESA

Project MESA is an international partnership designed to create a global specification for public safety. It leverages existing technology and focuses on interoperability and internetworking to create ad hoc mobile broadband networks. Project MESA ended in 2010⁵. The project did not publish a specific communications technology standard and will not be considered further.

3.3.4 TETRA Release 1

Terrestrial Trunked Radio (TETRA) Release 1 is a voice and data communications system standard developed by ETSI. It was expanded upon by TETRA Release 2 (TEDS), which added the ability to use various channel bandwidths and data rates. TEDS is backwards compatible with Release 1⁶. As such, TETRA Release 1 will not be considered separately but instead as a subset of TEDS.

3.3.5 TETRA Release 2 (TAPS)

TETRA Advanced Packet Service (TAPS) air interface protocol is based on the Global System for Mobile communications (GSM) standards⁷. As such, TAPS is not considered separately.

3.4 Custom Family

3.4.1 ACARS

The Aircraft Communications Addressing and Reporting System (ACARS) is a character-oriented technology developed in the late 1970's by ARINC. Its CSMA-based MAC protocol and stop-and-wait transmission characteristics preclude a reliable 20 Hz access rate. ACARS will not be considered for the CNPC link.

⁴ <http://www.etsi.org/WebSite/technologies/HiperMAN-WiMAXTesting.aspx>

⁵ <http://www.projectmesa.org/home.htm>

⁶ <http://www.tetramou.com/about/page/12029>

⁷ Terrestrial Trunked Radio (TETRA); Guide to TETRA Advanced Packet Service (TAPS), ETSI TR 101 976, 2001, p. 10

3.4.2 ADL

The Advanced Airport Data Link (ADL) is a multi-carrier CDMA system proposed by the German Aerospace Center (DLR) for airport surface communications. This system appears to be in the early stages of development with a concentration on the physical layer waveform. The technology does not appear to be complete enough to consider for the CNPC link.

3.4.3 B-VHF

Broadband VHF (B-VHF) is a technology proposed to overlay a multi-carrier CDMA system in the aeronautical VHF communications band. Development on B-VHF stopped as FAA and Eurocontrol agreed to look into future communications systems in the L-band instead of VHF. Key features of B-VHF were carried forward into the L-band concepts AMACS and LDACS 1 and 2. B-VHF is not considered for the CNPC link.

3.4.4 E-TDMA

Enhanced TDMA (E-TDMA) uses a statistical self-synchronization approach to TDMA. The E-TDMA frame can be between 2 and 10 seconds long with each frame divided into several QoS regions. This division of the frame, combined with the multi-second frame duration, will preclude E-TDMA from achieving a 20 Hz access rate. E-TDMA is not considered for the CNPC link.

3.4.5 Gatelink

Gatelink is not a specific technology, but rather a general term for communications service to aircraft docked at the gate. Gatelink is commonly implemented with 802.11 technology but in some cases uses other technologies such as cellular⁸. Since Gatelink does not offer a unique technology it is not considered for the CNPC link.

3.4.6 HF DL

The High-Frequency (HF) Data Link (HF DL) is an ACARS-based aeronautical data link that uses HF propagation characteristics to provide worldwide communications to aircraft. HF DL is a TDMA based system with 13 slots in a 32 second frame. The access rate is less than 1 Hz, far less than would be required for UAS. HF DL is not considered further for the CNPC link.

3.4.7 AMACS

The All-purpose Multi-channel Aviation Communication System (AMACS) is a proposed aeronautical data link technology that is somewhat based on E-TDMA and VHF Digital Link (VDL) Mode 4. It is a TDMA system that uses a 2s MAC frame. The MAC frame is divided into 2 uplink and 2 downlink sections. Because of the separate uplink and downlink sections, the system is half duplex with relatively large durations of transmit-only or receive-only operations. This prevents uniform access rates of 20 Hz.

The AMACS work was later used as the basis for LDACS 2. For these reasons AMACS is not considered for the CNPC link.

3.4.8 Mode S

Mode S technology is an evolution of the Secondary Surveillance Radar (SSR) system that includes aircraft addressing capabilities. The directional SSR antenna is attached to primary radar and shares the same rotational rate, which is one revolution every 4.8s for terminal radars and up to 12s per rotation

⁸ Wireless Gatelink: Coming of Age, Avionics Magazine, July 1 2005

for en route radars. Given the relatively short amount of time that an aircraft is within the narrow beam width of the SSR, Mode S cannot support the required access rates and is not considered.

3.4.9 UAT

The Universal Access Transceiver (UAT) is an aeronautical data link. UAT is one of the two technologies selected for Automatic Dependent Surveillance-Broadcast (ADS-B) in the United States, the other being Mode S. Its design primarily follows functionality required for ADS-B, such as a 1 Hz access. At the MAC layer, UAT uses a 1s frame with a form of slotted aloha access mechanism, where slot selection is based in part on the aircraft's location. UAT was not designed for the access rates required for the UAS CNPC link, and the slotted aloha mechanism (without retransmission procedures) cannot reliably transfer critical control and telemetry messages. UAT is not considered for the CNPC link.

3.4.10 VDL Mode 2

VDL Mode 2 is an aeronautical data link designed to support controller-pilot communications as well as an upgrade to the older ACARS systems. Like ACARS, VDL Mode 2 uses a CSMA technology in its MAC protocol. As implemented, the CSMA technology cannot reliably support a 20 Hz access rate.

3.4.11 VDL Mode 3, xDL3, LDL, Mode 3 with SAIC

VDL Mode 3 is a TDMA-based voice and data system that operates in either standard 4-slot or extended range 3-slot configurations. xDL3 and LDL are proposed re-banded variants of VDL Mode 3 that do not appear to have any protocol modification, while VDL Mode 3 with SAIC is a modification that adds improved signal detection but does not change the basic protocols themselves. Since all of the variants have the same protocol implementation, they are not considered separately.

In the best data-oriented configuration, VDL Mode 3 supports 1 voice and 3 data slots in a 120 ms frame, which would indicate support for roughly a 25 Hz access rate. However, the VDL 3 protocol uses an acknowledgement protocol and slot request protocol that limit the actual slot access rate to approximately once every MAC cycle (2 frames or 240 ms), which reduces the access rate to approximately 4 Hz. To support a 20 Hz rate would require significant modification to the VDL Mode 3 protocol, so it will not be considered for the CNPC link.

3.4.12 VDL Mode E

VDL Mode E is a modification of VDL Mode 3 to make it work in 8.33 kHz channels. This is accomplished by increasing the data rate while decreasing the number of slots per 120 ms frame to 2. This version of VDL Mode 3 suffers the same issues as the original VDL Mode 3 protocol and will not be considered.

3.5 Military Family

All military technologies were removed from consideration for the UAS CNPC link due to concerns over security. For civil use, the UAS CNPC link protocols must be publishable in an open standard that is available to any and all interested commercial parties. The CNPC link may well become an international standard and thus must not contain ITAR-restricted material.

3.6 Satellite Family

At this time, satellite communications systems are not considered. The satellite component of the UAS system is out of scope for the prototype radio development. However, the satellite technologies will be investigated in a future version of this document so as to identify systems to be evaluated through simulation.

3.7 Other Family

3.7.1 Airfone

Airfone (formerly known as GTE Airfone and Verizon Airfone), now called LIVETV Airfone, uses satellite communications in the Ka-band to provide video feeds and XM Radio Services to aircraft passengers. It is augmented by a ground station network that is said to support altitudes up to 30,000 feet. However, coverage is limited at higher altitudes and reliable coverage is said to be provided only up to 18,000 feet. Technologies relying on a combination of Line of Sight (LOS) and Beyond Line of Sight (BLOS) communications are not being considered for UAS CNPC at this time.

3.7.2 AirCell

AirCell is a proprietary technology that provides passenger voice and data services to the aircraft. The system is based on the cellular Evolution – Data Optimized (EV-DO) and Ka-band satellite technology⁹. Based on its proprietary nature and similarity to EV-DO, it is not considered further.

3.7.3 SkyWay

SkyWay was identified by the FCS as a potential technology. However, no information about this system has been found. This system will not be considered.

⁹ <http://www.aircell.com/press-room/aircell-announces-technology-roadmap>

4 Technology Evaluation Criteria

One of the challenges in performing this technology assessment is a dearth of defined requirements for the CNPC radio system. To define the criteria against which to evaluate the various technologies, documents from SC-203 were reviewed to identify potential capabilities that would be required in the CNPC radio. This list was augmented with applicable criteria from the FCS and desirable features for a modern RF communication that is power and bandwidth constrained. The final evaluations of the technology will apply weights to these criteria, allowing for Subject Matter Expert (SME) inputs on the relative importance of the various criteria.

It is anticipated that any technology will require modifications to better fit the needs of the CNPC radio. As such, many of the criteria are defined in terms of the technology having a feature, being modifiable to implement a feature, or being impossible or extremely difficult to add a feature. In cases where criteria rate capabilities based on numerical values such as range limits or data rates, modifiable is defined as up to a four-fold increase over the current limitations.

Criteria related to the waveform of the technologies considered inputs from Rockwell Collins based on their trade study.

4.1 Air/Ground Communications Criteria

Many technologies are range limited due to factors such as power and the size of guard times. These criteria evaluate the capabilities of the technology to support the distances needed for air/ground communications. The airport surface and terminal distances are based on maximum assumed ranges. Several distances have been postulated for coverage range in various UAS documents, therefore the maximum of these distances¹⁰ is used. The criteria do not evaluate preflight/postflight as those phases potentially may be served by other communications.

- Ability to support air/ground communications in the taxi and surface phases
 - Green – Technology supports a range of at least 1 NM
 - Yellow – Technology supports a range of at least .25 NM and can be modified to support a range of 1 NM
 - Red – Technology supports a range of less than .25 NM or cannot be modified to support a range of 1 NM

- Ability to support air/ground communications in the takeoff, landing, and terminal phases
 - Green – Technology supports a range of at least 10 NM
 - Yellow – Technology supports a range of at least 2.5 NM and can be modified to support a range of 10 NM
 - Red – Technology supports a range of less than 2.5 NM or cannot be modified to support a range of 10 NM

¹⁰ SC203-CC019 “Terrestrial L-Band and C-Band Architectures for UAS Control and Non-Payload Communications”
Rev. C December 2010

- Ability to support air/ground communications in the en route phase
 - Green – Technology supports a range of at least 83 NM
 - Yellow – Technology supports a range of at least 21 NM and can be modified to support a range of 83 NM
 - Red – Technology supports a range of less than 21 NM or cannot be modified to support a range of 83 NM

4.2 Data Transmission Criteria

One of the basic criteria for CNPC data communications is that the data link support addressed communications. All identified communications on the CNPC link to the aircraft are based on a unique address capability to allow the pilot to communicate with a specific UA. No requirement could be identified for broadcast or multicast communications. Because the addressing feature is a basic component of a technology, a yellow rating is not included to allow modification since it is deemed to be a major change.

- Ability to support addressed capability
 - Green – Technology has unique addressing capabilities
 - Red – Technology does not support addressing

The CNPC link must support the access rates needed by the command/telemetry, Air Traffic Service (ATS) relay, and surveillance products (target data, weather, and video). Of these, the command/telemetry requires the highest access rate of 20 Hz during the arrival phase.

- Ability to support necessary access rates for command/telemetry, voice, and surveillance
 - Green – Technology supports an access rate of at least 20 Hz
 - Yellow – Technology supports an access rate of at least 5 Hz and can be modified to support a rate of 20 Hz
 - Red – Technology supports an access rate of less than 5 Hz or cannot be modified to support a rate of 20 Hz

The CNPC must be capable of supporting the data rates needed by the command/telemetry, ATS relay, and surveillance products. SC-203 has defined required data rates for these services¹¹. The worst case numbers were used to determine that command and telemetry (control and nav aids) requires 14 kbps, ATS relay (voice and data) requires 18 kbps, and surveillance (target data, weather, and video) requires a total of 307 kbps.

The ATS relay numbers identified by SC-203 were only about 5 kbps. However, SC-203 did not consider the delay requirements for the ATS data identified in the Communications Operating Concepts and Requirements (COCR) document¹². When considering the delays required for phase 2, and assuming an even split in delay allocation between the future radio system and UA command link, the worst-case data rate required would be 13 kbps. Note that an even allocation between the two links is considered optimistic. The actual delay allowed for the CNPC link for data relay is a topic for further study.

¹¹ SC203-CC007 “Throughput Requirements for Control and Non-Payload Communications of a Single Unmanned Aircraft” Rev. G May 2009

¹² “Communications Operating Concepts and Requirements for the Future Radio System” ver. 2,

The identified data rates lead to the following criteria:

- Ability to support the necessary data rate for command and control
 - Green – Technology supports a rate of at least 14 kbps
 - Yellow – Technology supports a rate of at least 3.5 kbps and can be modified to support a rate of 14 kbps
 - Red – Technology supports a rate of less than 3.5 kbps or cannot be modified to support a rate of 14 kbps

- Ability to support the necessary data rate for command and control and ATS relay
 - Green – Technology supports a rate of at least 32 kbps
 - Yellow – Technology supports a rate of at least 8 kbps and can be modified to support a rate of 32 kbps
 - Red – Technology supports a rate of less than 8 kbps or cannot be modified to support a rate of 32 kbps

- Ability to support the necessary data rate for command and control, ATS relay, and surveillance
 - Green – Technology supports a rate of at least 339 kbps
 - Yellow – Technology supports a rate of at least 85 kbps and can be modified to support a rate of 339 kbps
 - Red – Technology supports a rate of less than 85 kbps or cannot be modified to support a rate of 339 kbps

4.3 Mobility Criteria

In order to utilize a multi-ground station network, support for handoffs between ground stations is critical. Soft handoffs will help ensure sufficient availability is maintained for the CNPC link.

- Ability to support handoff from ground station to ground station
 - Green – Technology supports soft handoffs
 - Yellow – Technology can be modified to support soft handoffs
 - Red – Technology cannot be modified to support anything more robust than hard handoffs

Dynamic power control (DPC) allows transmit power to be adjusted so that a UA near the ground station can use less power than a UA at the far edge of coverage. Although this is not a vital feature of a possible CNPC link, it could help reduce unneeded transmitter noise levels and help ensure link availability.

- Ability to support dynamic power control
 - Green – Technology supports dynamic power control
 - Yellow – Technology can be modified to support dynamic power control
 - Red – Technology cannot be modified to support dynamic power control

Many technologies incorporate adaptive modulation rates (AMR). In situations where link quality improves, higher rate modulations can be used to increase spectral efficiency. Alternatively, if link quality degrades, a lower rate modulation can be selected to help reduce error rates on the link. This poses itself to be a useful feature for a CNPC link since available bandwidth is limited.

- Ability to support adaptive modulation rates
 - Green – Technology supports adaptive modulation rates
 - Yellow – Technology can be modified to support adaptive modulation rates
 - Red – Technology cannot be modified to support adaptive modulation rates

Active QoS retuning is the ability for a technology to monitor the current channel and monitor adjacent channels and cells. If a better quality link is available, a handoff will occur to ensure the best available link is used. This will help increase link quality and availability.

- Ability to support active QoS retuning due to interference
 - Green – Technology supports active QoS retuning
 - Yellow – Technology can be modified to support active QoS retuning
 - Red – Technology cannot be modified to support active QoS retuning

4.4 Security Criteria

Confidentiality is the protection of data from unauthorized or unintended disclosure. National Institute of Standards and Technology (NIST) approved standards were desired since they are non-proprietary and are considered cryptographically secure algorithms.

- Ability of the technology to support confidentiality
 - Green – Supports NIST Federal Information Processing Standard (FIPS) approved cryptographic algorithm for the protection of data described in FIPS 197
 - Yellow – Supports commercially available and accepted cryptographic algorithms for the protection of data
 - Red – Does not support any NIST or commercially accepted cryptographic algorithms for the protection of data

Integrity is the protection of data from improper modification or destruction. Again, NIST approved standards were desired since they are non-proprietary and are considered cryptographically secure algorithms.

- Ability of the technology to support integrity
 - Green – Supports NIST FIPS approved message authentication code utilizing cryptographic hash functions described in FIPS 198-1 for message authentication and integrity
 - Yellow – Supports commercially available and accepted cryptographic hash functions for message authentication and integrity
 - Red – Does not support any NIST or commercially accepted cryptographic hash functions for message authentication and integrity

Availability is the protection from loss of system functionality and operational effectiveness due to unintentional or intentional interference. In order to meet the criteria for availability, the technology must support at least three RF or protocol techniques to counter interference. Examples of this are dynamic power control, narrowband channels, dynamic frequency selection, and frequency hopping.

- Ability of the technology to support availability
 - Green – Supports three or more techniques to maintain system availability
 - Yellow – Supports one or more techniques to maintain system availability
 - Red – Does not support any techniques to maintain system availability

4.5 Traffic QoS Criteria

Cross-carrier distribution is desirable for the UA to switch to a less utilized channel or ground station when possible. This can lead to better spectrum efficiency within the band. Distribution decisions can be made by the ground infrastructure, the mobile radio, or a combination of both.

- Ability to support traffic cross-carrier distribution
 - Green – Technology supports cross-carrier distribution
 - Yellow – Technology can be modified to support cross-carrier distribution
 - Red – Technology cannot support cross-carrier distribution

The ability to prioritize traffic streams and packets on the link can offer better QoS, especially in critical situations where certain messages are of the utmost importance. Priorities affect the ordering of packets before transmission or determine resource allocations.

- Ability to support traffic priority
 - Green – Technology supports traffic priority
 - Yellow – Technology can be modified to support traffic priority
 - Red – Technology cannot support traffic priority

The CNPC link will be carrying a variety of data such as command and control, ATS relay (containing voice and data), and surveillance. Traffic classes help to identify what kinds of quality assurances, such as average delay, acceptable loss, and throughput, should be applied to different data.

- Ability to support traffic classes
 - Green – Technology supports various traffic classes
 - Yellow – Technology can be modified to support traffic classes
 - Red – Technology cannot support traffic classes

Reliability mechanisms within the data link layers are desired so that retransmission of lost data can occur sooner than if it were to take place at higher layers. A variety of Automatic Repeat Request (ARQ) mechanisms exist, such as stop-and-wait, go-back-N, and selective repeat.

- Ability to support data reliability/ARQ on traffic basis
 - Green – Technology supports reliability mechanisms
 - Yellow – Technology can be modified to support reliability mechanisms
 - Red – Technology cannot support reliability mechanisms

Due to the limited bandwidth and projected UAS growth, spectral efficiency is a concern. Dynamic bandwidth allocation allows a UA to only use what bandwidth is required at that time. Examples of dynamic bandwidth allocation include using more time slots, moving to a larger bandwidth channel, or combining multiple channels. This also allows reduced bandwidth usage such that it can be used by other UAs when possible.

- Ability to support dynamic bandwidth allocation
 - Green – Technology supports dynamic bandwidth allocation
 - Yellow – Technology can be modified to support dynamic bandwidth allocation
 - Red – Technology cannot support dynamic bandwidth allocation

An added feature that could help maintenance and future system deployment is the ability for the UA to collect RF link statistics such as the Bit Error Rate (BER) and signal strength. These statistics can be either sent down to the ground during flight or offloaded from the UA after landing.

- Ability to support RF statistics reporting
 - Green – Technology contains reporting on RF statistics
 - Yellow – Technology can be modified to report RF statistics
 - Red – Technology cannot support RF statistics reporting

4.6 Standardization and Certification Criteria

To measure the maturity of a technology for aeronautical usage, the Technology Readiness Level (TRL) scale was used. The green/yellow/red ratings used for readiness are from the FCS.

- Technology Readiness Level (TRL)
 - Green – The technology has defined standards, is mature, and available (TRL 6 or above)
 - Yellow – The technology is defined and tested experimentally (TRL 4 or 5)
 - Red – The technology is incomplete and/or untested (TRL 3 or below)

Although the focus at this time is not for aeronautical certification, it still must be considered since the hope is to select a CNPC system that is on a path to certification. Also, it is assumed that the downselected technology will need modifications to meet the CNPC requirements. The green/yellow/red ratings used for certification risk are from the FCS.

- Certification risk
 - Green – Technology is designed for aeronautical use
 - Yellow – Technology is designed for public safety
 - Red – Technology is not designed for aeronautical or public safety

A set of criteria were defined with the industry partner to reflect the complexity of the technology in three key areas: robustness, determinism, and link layer compatibility.

The robustness criterion evaluated if the waveform physical characteristics would be capable of meeting the 99.8% availability requirement. Both Frequency Division Multiple Access (FDMA) and TDMA approaches should be capable of meeting the availability requirement given adequate link margin. Based on the Rockwell Collins Trade Study¹³, it was determined that a CDMA approach would not be capable of meeting the required availability requirement due to a low Signal-to-Interference ratio (SIR). Orthogonal Frequency Division Multiplexing (OFDM) systems also would not meet the requirement due to the need for transmitter linearity and the need for multiple power amplifiers for sectored antennas.

¹³ NASA Unmanned Aircraft Control and Non-Payload Communication System Waveform Trade Studies, Rockwell Collins, March 2012

- Robustness
 - Green – Technology utilizes either FDMA or TDMA without OFDM
 - Red – Technology utilized CDMA or OFDM

The determinism criterion evaluated if the waveform architecture is deterministic or was ad hoc. The technology receives the lowest score if the waveform architecture is an ad hoc architecture, or non-deterministic, due to the complexity of achieving FAA certification. CSMA-based technologies would be in this category. In addition, the waveform may have a reduced ranking if the performance of the waveform was not deterministic. In the case of CDMA, although the waveform may have been deterministic, the performance is a function of the number of UAs operating, and the 99.8% availability cannot be guaranteed. Change would be required to address this issue.

- Determinism
 - Green – The waveform is deterministic and does not utilize CDMA
 - Yellow – The waveform utilizes CDMA
 - Red – The waveform is ad hoc or utilizes CSMA

The link layer compatibility criterion evaluated if the waveform architecture was compatible with the waveform design described in the Rockwell Collins Trade Study. The best rating is applied to technologies that support either TDMA or FDMA since these are most compatible with Trade Study waveform. OFDM technologies require more modification and receive a lower rating. CDMA waveforms receive the lowest rating due to the significant redesign required replacing the CDMA structure.

- Link layer compatibility
 - Green – Technology utilizes TDMA or FDMA multiplexing without OFDM
 - Yellow – Technology utilizes TDMA or FDMA with OFDM
 - Red – Technology utilizes CDMA

4.7 Waveform Criteria

Rockwell Collins has performed a trade study to evaluate the potential waveform characteristics that are most beneficial to a UAS CNPC link when considering the Size, Weight, and Power (SWAP) constraints that will exist for the smaller UA. This trade study led to recommendations for waveform duplexing, multiplexing, and modulation.

For the duplexing option, Rockwell Collins performed a trade analysis between Time Division Duplex (TDD) and Frequency Division Duplex (FDD). Ultimately the study concluded only the TDD option is viable for the CNPC link. The duplexing criteria is defined to reflect this recommended option. In addition, it is assumed that half-duplex FDD technologies would be more adaptable to a TDD configuration than full-duplex FDD.

- Duplexing
 - Green – Technology uses TDD
 - Yellow – Technology uses half-duplex FDD
 - Red – Technology uses full-duplex FDD

The trade study evaluated multiplexing options separately for the forward and reverse link. The evaluated options were TDMA, FDMA, and CDMA.

For the forward link, the trade study found TDMA to be the best method, followed by FDMA, and CDMA being the least recommended. For the reverse link, the study preferred FDMA, followed by TDMA, and CDMA the least recommended.

- Forward Link Multiplexing
 - Green – Technology uses TDMA forward link multiplexing
 - Yellow – Technology uses FDMA forward link multiplexing
 - Red – Technology uses CDMA forward link multiplexing

- Reverse Link Multiplexing
 - Green – Technology uses FDMA reverse link multiplexing
 - Yellow – Technology uses TDMA reverse link multiplexing
 - Red – Technology uses CDMA reverse link multiplexing

The trade study found that for both the forward and reverse links, a constant envelope single carrier modulation is recommended. Other single carrier modulations were rated second best, as the transmitter linearity becomes more important. Multi-carrier modulations are least recommended due to the increased receiver complexity and increased transmitter linearity required.

- Forward Link Modulation
 - Green – Technology uses a constant envelope single carrier modulation
 - Yellow – Technology uses a single carrier modulation
 - Red – Technology uses a multi-carrier modulation

- Reverse Link Modulation
 - Green – Technology uses a constant envelope single carrier modulation
 - Yellow – Technology uses a single carrier modulation
 - Red – Technology uses a multi-carrier modulation

5 Technology Evaluations

After prescreening, twenty-four technologies were left for further evaluation. The technologies that progressed past the prescreening process into the detailed analysis are shown in Table 2. Note that L-DACS 2 and STANAG 4660 are included in this list for special consideration although they did not meet the all the requirements of the prescreening.

The evaluation criteria are applied to each technology to provide a detailed assessment. The remainder of this section provides a brief introduction to each technology and the rationale for the received ratings.

Table 2. Candidate Technologies

Family	Primary Technology	Related Technologies
Cellular	TDMA (IS-136)	
	GSM	TETRA Release 2 (TAPS)
	GPRS	TETRA Release 2 (TAPS)
	EDGE	
	W-CDMA (UMTS)	
	TD-CDMA (UMTS)	
	TD-SCDMA (UMTS)	
	CDMA2000 (1x, 1xEV, 3x)	
	EV-DO	AirCell
	EV-DV	
	LTE	
	DECT	
IEEE 802	802.11	HIPERLAN/2
	802.16	HIPERMAN
	802.20	
Public Safety	P-25	
	P-34	
	IDRA (RTR STD-32A)	IDEN
	TETRAPOL	
	TETRA Release 2 (TEDS)	TETRA Release 1
Custom Solutions	VDL Mode 4	
	L-DACS 1	
	L-DACS 2	AMACS
	STANAG 4660	

5.1 Cellular Family

5.1.1 TDMA (IS-136)

TDMA IS-136 is a technology primarily designed for voice services. It is a channel access technology where multiple users can share the same radio frequency. In TDMA IS-136, time is divided into 40 ms frames that are each subdivided into six slots. Separate channels are allocated for the forward and reverse link. The assigned slots are shifted in time as shown in Figure 2 so that a device can receive, retune, and transmit seamlessly. TDMA IS-136 may operate in half-rate mode, with six users utilizing a

single slot per frame, or full rate mode, where three users utilize two slots each. Full-rate is preferred for voice clarity.

A major limitation in TDMA is that precise timing between the aircraft and ground station would be required. In a two-way TDMA system the delay between the aircraft and ground station caused by excessive distance can cause data to arrive outside of the appropriate time slot and interfere with the next one.

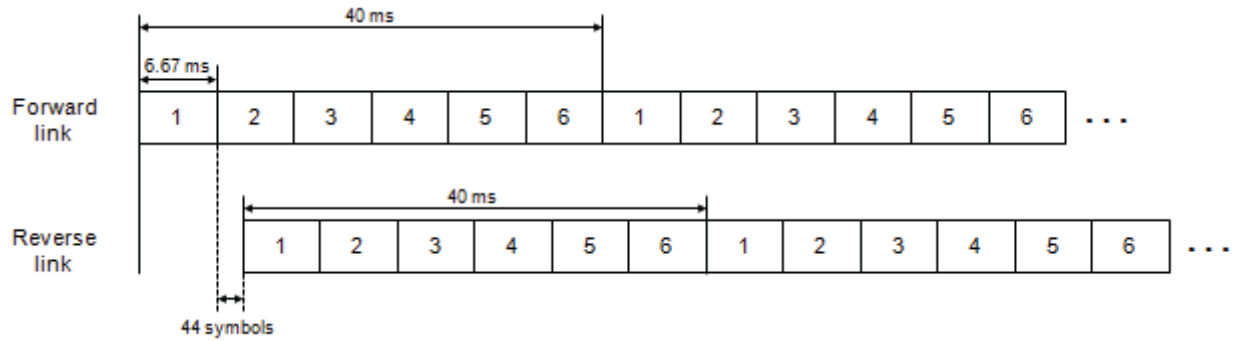

Figure 2. TDMA IS-136 frame structure

5.1.1.1 Air/Ground Communications Criteria

The UA has to be less than 41 NM away from the ground station for data to arrive in the appropriate time slot or a maximum of 252 μs. Modifications to the bandwidth and frame size would be necessary, being cognizant of other criteria that may suffer as a result.

Air/Ground Communications	Taxi / Surface	
	Takeoff / Landing / Terminal	
	En Route	

5.1.1.2 Data Transmission Criteria

The device on a TDMA network can be addressed supporting paging services and non- Global Positioning System (GPS) based location. Using half-rate, the use of 1 slot every 40 ms results in a maximum access rate of 25 Hz. Full-rate would double this to 50 Hz. This yields a green rating for the repetition rate criterion. Full-rate enables a data rate of 13 kbps, sufficient for the command and control traffic. Command and Control (C&C) with ATS relay could not be completely supported. Modifications would have to be made to the structure up to and including larger bandwidth channels and/or data compression techniques which would be extremely difficult to achieve. Using a TDMA traffic channel multi-frame would reduce the repetition rate to an unacceptable level.

Data Transmission	Addressed capability	
	Repetition rate	
	Command/Control	
	C&C and ATS	
	C&C, ATS, and Surveillance	

5.1.1.3 Mobility Criteria

Soft handoffs are not supported in TDMA, as the connection on the source ground station would have to be broken to allow the mobile device to retune to the target ground station. Given proper network

design considerations and acceptable RF conditions, the hard handoffs are very reliable. To implement soft handoffs would require restructuring the TDMA frame with candidate site data in addition to adding an additional receiver in the aircraft radio. Dynamic power control is available on traffic channels; however, TDMA being predominantly a voice technology, degradation in quality KPIs would result in a handoff attempt as RF conditions dictate. Modulation would remain static.

Mobility	Handoff	Yellow
	Dynamic Power Control	Green
	Adaptive Modulation Rates	Yellow
	Active QoS Retuning	Yellow

5.1.1.4 Security Criteria

TDMA IS-136 uses the Cellular Message Encryption Algorithm (CMEA) which has been broken and Cellular Authentication and Voice Encryption (CAVE) authentication which may be vulnerable according to some publications but is still commercially acceptable. TDMA uses dynamic power control, which improves availability.

Security	Confidentiality	Red
	Integrity	Yellow
	Availability	Yellow

5.1.1.5 Traffic QoS Criteria

TDMA is very limited in its ability to negotiate QoS in a networked environment. There are no provisions within the technology to distribute traffic; however, there are methods to shed traffic to adjacent sectors to allow capacity for incoming devices, reducing lost link scenarios. This would be done solely as a temporary measure until the proper resources can be added. Priority is given to emergency 911 traffic as a rule, implying that capabilities could be made for other levels as well. To provide ARQ service, the Fixed Network Equipment (FNE) providers or the network users could provide an end-to-end solution outside of the network environment. The standard itself does not support the traditional concept of dynamic bandwidth allocation; however, there is a dynamic TDMA version used in other technologies that can reserve a variable number of time slots in each frame to variable bit-rate data streams based on demand that could potentially be integrated. RF statistics reporting in varying degrees is a staple in all commercial wireless technologies.

Traffic QoS	Cross-Carrier Distribution	Yellow
	Priority	Green
	Classes	Yellow
	Reliability/ARQ	Yellow
	Dynamic Bandwidth Allocation	Yellow
	RF Statistics Reporting	Green

5.1.1.6 Standardization and Certification Criteria

The TDMA IS-136 standard has been in use for over 20 years in the United States (US) and has proven itself to be a reliable RF technology but has not been certified for aeronautical command and control use in this form, therefore technology readiness level is rated as green and certification is rated as red. TDMA should be capable of meeting the availability requirement given adequate link margin, therefore it is rated as green. Determinism is also rated as green as is link layer compatibility for the same reasons.

Standardization and Certification	Technology Readiness Level	Green
	Certification Risk	Red
	Robustness	Green
	Determinism	Green
	Link Layer Compatibility	Green

5.1.1.7 Waveform Criteria

IS-136 TDMA is a half-duplex FDD technology. It uses TDMA uplink and downlink multiplexing. The trade study by Rockwell prefers FDMA on the downlink due to timing delays causing potential synchronization issues. The uplink and downlink modulation is single carrier/constant envelope Gaussian Frequency Shift Keying (GFSK).

Waveform	Duplexing	Yellow
	Forward Link Multiplexing	Green
	Reverse Link Multiplexing	Yellow
	Forward Link Modulation	Green
	Reverse Link Modulation	Green

5.1.2 *GSM*

Global System for Mobile Communication (GSM) is a TDMA-based system with frequency hopping and includes other key features. It was the next logical step in the evolution for IS-136 network operators in the US. GSM has the same limitation as TDMA IS-136 in that the time delay between the aircraft and ground station caused by excessive distance can cause data to arrive outside of the appropriate time slot and interfere with the next one.

5.1.2.1 Air/Ground Communications Criteria

In air/ground communications, GSM would obviously not have any problems with surface applications or take-off and landing. However, as with any technology using TDD in both directions, timing is critical and delay becomes an issue at greater distances. In GSM timing advance can be controlled in 64 steps of 550m. The maximum one-way distance between a GCS and an aircraft is in theory is $550m * 64 = 19 \text{ NM}$. The GSM standard offers an additional timeslot configuration to increase the maximum distance to 64.79 NM. A non-standard configuration would have to be used to achieve a greater distance.

Air/Ground Communications	Taxi / Surface	Green
	Takeoff / Landing / Terminal	Green
	En Route	Yellow

5.1.2.2 Data Transmission Criteria

GSM, being predominantly a voice-only technology has obvious shortcomings in data transmission. As with all wireless technologies, the mobile device can be located by its hardware or use of system identification (ID) and Mobile Identification Number (MID). The 8 time slot, 200 kHz channel structure used has a frame that is 4.615 ms long having a repetition rate of 216.7 Hz. At 9.6 kbps per time slot, 76 kbps peak can be achieved without error correction.

Data Transmission	Addressed capability	Green
	Repetition rate	Green
	Command/Control	Yellow
	C&C and ATS	Yellow
	C&C, ATS, and Surveillance	Yellow

5.1.2.3 Mobility Criteria

Handoffs occur to different frequencies in the hopping list or to other sectors or sites in the network. They are considered hard handoffs due to these frequency changes which require retuning of the device. Dynamic power control is done in 2dB increments. AMR was added to GSM later in the deployment in 8 codec values. RF Quality (RFQual) dictates the necessity to hop to another timeslot in a different channel.

Mobility	Handoff	Yellow
	Dynamic Power Control	Green
	Adaptive Modulation Rates	Green
	Active QoS Retuning	Green

5.1.2.4 Security Criteria

A5/3 and A5/4 (f8) are commercially accepted cryptographic algorithms, however not acceptable as the sole form of confidentiality protection. Cipher Block Chaining Message Authentication Code (CBC-MAC) (f9) is a commercially accepted hashing method; however, additional security would need to be added. GSM also has dynamic power control, dynamic channel allocation, and frequency hopping adding resiliency against jamming.

Security	Confidentiality	Yellow
	Integrity	Yellow
	Availability	Green

5.1.2.5 Traffic QoS Criteria

GSM is not a multiple access, but a single-channel time slot based technology, so there would not be a function for cross-carrier distribution. However, one can establish hopping lists to avoid using specific frequencies unless the site is fully loaded. This is commonly used to avoid interference or collisions. The channels are fixed at 200 kHz and would have to be somehow combined to add bandwidth. RF statistics are plentiful and layer 3 messaging can be extracted from field test data.

Traffic QoS	Cross-Carrier Distribution	Yellow
	Priority	Green
	Classes	Yellow
	Reliability/ARQ	Yellow
	Dynamic Bandwidth Allocation	Yellow
	RF Statistics Reporting	Green

5.1.2.6 Standardization and Certification Criteria

GSM has been used worldwide for nearly 20 years in the US and abroad, however is has not been certified for aeronautical command and control use, therefore technology readiness level is rated as green and certification is rated as red. GSM should be capable of meeting the availability requirement

given adequate link margin, therefore it is rated as green. Determinism is also rated as green as is link layer compatibility for the same reasons.

Standardization and Certification	Technology Readiness Level	Green
	Certification Risk	Red
	Robustness	Green
	Determinism	Green
	Link Layer Compatibility	Green

5.1.2.7 Waveform Criteria

GSM uses FDD with transmit and receive frequencies separated by 45 MHz. Forward and reverse link multiplexing are divided both by time and frequency and modulated using Gaussian Minimum Shift Keying (GMSK) in a single carrier, constant envelope scheme.

Waveform	Duplexing	Red
	Forward Link Multiplexing	Yellow
	Reverse Link Multiplexing	Yellow
	Forward Link Modulation	Green
	Reverse Link Modulation	Green

5.1.3 GPRS

General Packet Radio Service (GPRS) is GSM’s response to CDMA 1xRTT and can be considered and overlay. GPRS uses dedicated GSM channels reserved for data-only use and are also shared among other users. GPRS channels can be assigned to frequency hop or remain static, which somewhat improves throughput.

5.1.3.1 Air/Ground Communications Criteria

In air/ground communications, GSM/GPRS would obviously not have any problems with surface applications or takeoff and landing. However, as with any technology using TDD in both directions, timing is critical and delay becomes an issue at greater distances. In GSM timing advance can be controlled in 64 steps of 550m. The maximum one-way distance between a Ground Control Station (GCS) and an aircraft is in theory is $550m * 64 = 19 \text{ NM}$. The GSM standard offers an additional timeslot configuration to increase the maximum distance to 120 km (64.79 NM). A non-standard configuration would have to be used to achieve a greater distance.

Air/Ground Communications	Taxi / Surface	Green
	Takeoff / Landing / Terminal	Green
	En Route	Yellow

5.1.3.2 Data Transmission Criteria

GPRS peak forward link data rate is 171 kbps, with throughput somewhere near the lower end on the reverse link depending on the number of users and RF conditions. Four forward link and one reverse link TDMA time slots for each radio channel are allocated to this service. This would have to be reversed to allow more time slots for telemetry and modified to support the added burden of surveillance data.

Data Transmission	Addressed capability	Green
	Repetition rate	Green
	Command/Control	Green
	C&C and ATS	Green
	C&C, ATS, and Surveillance	Yellow

5.1.3.3 Mobility Criteria

Handoffs occur to different frequencies in the hopping list or to other sectors or sites in the network. They are considered hard handoffs due to these frequency changes which require retuning of the device. DPC is done in 2dB increments. AMR was added to GSM later in the deployment in 8 codec values. RFQual dictates the necessity to hop to another timeslot in a different channel.

Mobility	Handoff	Yellow
	Dynamic Power Control	Green
	Adaptive Modulation Rates	Green
	Active QoS Retuning	Green

5.1.3.4 Security Criteria

The GPRS Encryption Algorithms (GEA) GEA3 & GEA4 are commercially accepted cryptographic algorithms, however not acceptable as the sole form of confidentiality protection. CBC-MAC (f9) is a commercially accepted hashing method, however additional security would need to be added. GPRS has DPC, dynamic channel allocation, and frequency hopping adding resiliency against jamming.

Security	Confidentiality	Yellow
	Integrity	Yellow
	Availability	Green

5.1.3.5 Traffic QoS Criteria

Like GSM, GPRS is not a multiple access, but a single-channel time slot based technology, so there would not be a function for cross-carrier distribution. However, one can establish hopping lists to avoid using specific frequencies unless the site is fully loaded. This is commonly used to avoid interference or collisions. Priority can be given to specific devices and/or inbound/outbound paging. The channels are fixed at 200 kHz and would have to be somehow combined to add bandwidth. RF statistics are plentiful and layer 3 messaging can be extracted from field test data.

Traffic QoS	Cross-Carrier Distribution	Yellow
	Priority	Green
	Classes	Yellow
	Reliability/ARQ	Yellow
	Dynamic Bandwidth Allocation	Yellow
	RF Statistics Reporting	Green

5.1.3.6 Standardization and Certification Criteria

GPRS has been implemented for 10-12 years in the US and abroad; however, it has not been certified for aeronautical command and control use, therefore technology readiness level is rated as green and certification is rated as red. GPRS should be capable of meeting the availability requirement given

adequate link margin, therefore it is rated as green. Determinism is also rated as green as is link layer compatibility for the same reasons.

Standardization and Certification	Technology Readiness Level	Green
	Certification Risk	Red
	Robustness	Green
	Determinism	Green
	Link Layer Compatibility	Green

5.1.3.7 Waveform Criteria

Like GSM, GPRS uses FDD with 45 MHz separation between the transmit and receive frequencies. For this reason, it is not recommended for use on either path. Forward and reverse link multiplexing are divided both by time and frequency and modulated using GMSK in a single carrier, constant envelope, binary scheme.

Waveform	Duplexing	Red
	Forward Link Multiplexing	Yellow
	Reverse Link Multiplexing	Yellow
	Forward Link Modulation	Green
	Reverse Link Modulation	Green

5.1.4 EDGE

Enhanced Data Rates for GSM Evolution (EDGE) is considered pre-3G and was designed to provide higher throughput for the growing data requirements and is another modification of the GSM air interface. The efficiency of EDGE in terms of kbps per time slot is 3-4 times greater than GPRS. It is also considered a data overlay to GSM/GPRS networks.

5.1.4.1 Air/Ground Communications Criteria

In air/ground communications, EDGE would obviously not have any problems with surface applications or takeoff and landing. However, as with any technology using TDD in both directions, timing is critical and delay becomes an issue at greater distances. In GSM timing advance can be controlled in 64 steps of 550m. The maximum one-way distance between a GCS and an aircraft is in theory is $550m * 64 = 19 \text{ NM}$. The GSM standard offers an additional timeslot configuration to increase the maximum distance to 64.79 NM. A non-standard configuration would have to include another time slot to achieve a greater distance.

Air/Ground Communications	Taxi / Surface	Green
	Takeoff / Landing / Terminal	Green
	En Route	Yellow

5.1.4.2 Data Transmission Criteria

EDGE is an IP-based packet data technology. They are up to 9 GMSK/8-ary Phase Shift Keying (PSK) coding schemes delivering 59.2 kbps per time slot using 8-PSK and a maximum of 17.6 kbps using GMSK modulation. EDGE modulation can be time inserted on a time slot basis. The theoretical maximum rate is 474 kbps using all 8 timeslots in a single channel. 8-PSK requires higher signal to noise ratios to fully realize peak speeds.

Data Transmission	Addressed capability	Green
	Repetition rate	Green
	Command/Control	Green
	C&C and ATS	Green
	C&C, ATS, and Surveillance	Green

5.1.4.3 Mobility Criteria

Handoffs will occur to different channel frequencies, which are highly reliable, but still considered hard handoffs. EDGE contains all important mobility features such as dynamic channel allocation, adaptive modulation rates, and QoS retuning based on RF conditions to improve throughput and reduce lost link occurrences.

Mobility	Handoff	Yellow
	Dynamic Power Control	Green
	Adaptive Modulation Rates	Green
	Active QoS Retuning	Green

5.1.4.4 Security Criteria

A5/3 and A5/4 (f8) are commercially accepted cryptographic algorithms, however not acceptable as the sole form of confidentiality protection. CBC-MAC (f9) is a commercially accepted hashing method; however, additional security would need to be added. EDGE also has dynamic power control, dynamic channel allocation, and frequency hopping adding resiliency against jamming

Security	Confidentiality	Yellow
	Integrity	Yellow
	Availability	Green

5.1.4.5 Traffic QoS Criteria

EDGE is GSM-based and is also frequency divided and a single-channel time slot based technology, so there would not be a function for cross-carrier distribution. However, one can establish hopping lists to avoid using specific frequencies unless the site is fully loaded. This is commonly used to avoid interference or collisions. However, as with GPRS, EDGE can be assigned to static channels, which is recommended, but adds complexity to frequency planning a GSM network. Priority can be given to specific devices and/or inbound/outbound paging. The channel bandwidth, like GSM and GPRS, is fixed at 200 kHz and would have to be somehow combined to add bandwidth. RF statistics are plentiful and layer 3 messaging can be extracted from field test data.

Traffic QoS	Cross-Carrier Distribution	Yellow
	Priority	Green
	Classes	Green
	Reliability/ARQ	Yellow
	Dynamic Bandwidth Allocation	Yellow
	RF Statistics Reporting	Green

5.1.4.6 Standardization and Certification Criteria

EDGE has been implemented for 7-10 years in the US; however, the technology has never been certified for aeronautical use, therefore technology readiness level is rated as green and certification is rated as red. EDGE should be capable of meeting the availability requirement given adequate link margin, therefore it is rated as green. Determinism is also rated as green as is link layer compatibility for the same reasons.

Standardization and Certification	Technology Readiness Level	Green
	Certification Risk	Red
	Robustness	Green
	Determinism	Green
	Link Layer Compatibility	Green

5.1.4.7 Waveform Criteria

Being a GSM-Based technology, EDGE is also FDD and channels are divided into time slots. Several modulation schemes can be used based on network configuration and RF conditions. However, when using 8PSK, amplifier linearity becomes a concern. For this reason, it is not recommended for use on either path.

Waveform	Duplexing	Red
	Forward Link Multiplexing	Yellow
	Reverse Link Multiplexing	Yellow
	Forward Link Modulation	Yellow
	Reverse Link Modulation	Yellow

5.1.5 *UMTS (W-CDMA/TD-CDMA/TD-SCDMA)*

The Universal Mobile Telecommunications System (UMTS) is a 3rd generation cellular technology based on GSM and uses CDMA. It defines three different air interfaces while maintaining the upper layers of the protocol. Some features of the different air interfaces are shown in Table 3. All three interfaces define a 10 ms frame constructed of 15 slots, each being 0.667 ms in duration. Wideband CDMA (W-CDMA) also defines a 2 ms subframe which is a grouping of 3 slots. For simplicity, the term UMTS will be used to refer the all three interfaces and the specific air interfaces will be referenced individually where appropriate.

Table 3. UMTS Air Interfaces

Interface	Duplexing	Channel Bandwidths	Notes
W-CDMA	FDD	2 × 5 MHz	
TD-CDMA	TDD	5 MHz	High Chip Rate
TD-SCDMA	TDD	1.6 MHz	Low Chip Rate

5.1.5.1 Air/Ground Communications Criteria

All three interfaces are able to support the phases of flight up and including terminal and are rated as green. The FCS found that Time Division CDMA (TD-CDMA) and Time Division Synchronous CDMA (TD-SCDMA) have ranges of 16 NM and 21.5 NM, respectively. It stated for W-CDMA that there was no

explicit limitation to the maximum range. W-CDMA is rated as green. TD-CDMA is rated as red since it does not meet the 21 NM minimum. TD-SCDMA is rated as yellow.

		W-CDMA	TD-CDMA	TD-SCDMA
Air/Ground Communications	Taxi / Surface	Green	Green	Green
	Takeoff / Landing / Terminal	Green	Green	Green
	En Route	Green	Red	Yellow

5.1.5.2 Data Transmission Criteria

UMTS supports a variety of addressing schemes, and is therefore rated as green. A repetition rate of 100 Hz is achievable when just one access is made per frame. More than one slot can be used per frame, giving a much higher possible repetition rate and is rated as green. The data rates supported by the three air interfaces do vary but are all able to easily support a 1 Mbps data rate. Newer releases of the UMTS standard define a High Speed Data Packet Access (HSDPA) channel that can support over 80 Mbps in the forward link and 20 Mbps in the reverse link. UMTS can easily accommodate the data rates required to include C&C, ATS, and surveillance. Thus, it is rated as green for the three data throughput criteria.

Data Transmission	Addressing	Green
	Repetition Rate	Green
	Command/Control	Green
	C&C and ATS	Green
	C&C, ATS, and Surveillance	Green

5.1.5.3 Mobility Criteria

UMTS defines handoff procedures. However, W-CDMA with its FDD is able to support soft handoffs. TD-CDMA and TD-SCDMA use hard handoffs since frequency changes may occur. The standard also supports hard handoffs between FDD and TDD, given the station and mobile device supports both. W-CDMA is rated as green since it supports soft handoffs. Both TD-CDMA and TD-SCDMA are rated as yellow since hard handoffs may occur.

All three interfaces support open and closed loop power control in both directions. Adjustments of 1, 2, or 3 dB can be made. All three air interfaces are rated as green for dynamic power control.

With the release of the newer revisions supporting HSDPA, UMTS supports Quadrature Phase Shift Keying (QPSK), 16- Quadrature Amplitude Modulation (QAM), and 64-QAM. Different slot configurations are defined to determine what modulation scheme to use. All three air interfaces are rated as green for adaptive modulation rates.

Mobile devices monitor adjacent cells and frequency channels. If another channel is deemed better than the current one, handoffs will occur to switch the mobile device to that channel. All three are rated as green for QoS retuning.

		W-CDMA	TD-CDMA	TD-SCDMA
Mobility	Handoff	Green	Yellow	Yellow
	Dynamic Power Control	Green	Green	Green
	Adaptive Modulation Rates	Green	Green	Green
	Active QoS Retuning	Green	Green	Green

5.1.5.4 Security Criteria

The encryption algorithm f8 is used for the protection of user and signaling data sent over the radio access link. Confidentiality is rated as yellow since it uses a commercially accepted cryptographic algorithm. The Message Authentication Code (MAC) function f9 is used to authenticate the data integrity and data origin of signaling data. Integrity is rated as yellow since it uses a commercially acceptable hash algorithm. UMTS uses dynamic power control to support availability and is rated as yellow.

Security	Confidentiality	Yellow
	Integrity	Yellow
	Availability	Yellow

5.1.5.5 Traffic QoS Criteria

UMTS devices will monitor the channel and reselect as needed if a less utilized channel is available, providing a green rating for traffic distribution. The UMTS QoS is an extensive specification that allows a variety of traffic controls. It supports 15 levels of priority within each traffic class. The QoS supported by UMTS defines four traffic classes: conversational, streaming, interactive, and background. Not only does the QoS for UMTS cover data transmitted over the air, but also within the ground infrastructure, allowing for more effective end-to-end control. UMTS is able to support acknowledged and unacknowledged data transfers at the MAC layer. It can use a variety of ARQ mechanisms.

All three air interfaces provide means of supporting dynamic bandwidth allocation. Random access channels can be used when needed. Varying amount of time slots can also be requested to allow for scheduled transmissions of frames. UMTS mobile devices can be polled for link statistics. These are used to help make handoff decisions and for closed loop power control. All traffic QoS criteria are rated as green for UMTS.

Traffic QoS	Cross-Carrier Distribution	Green
	Priority	Green
	Classes	Green
	Reliability/ARQ	Green
	Dynamic Bandwidth Allocation	Green
	RF Statistics Reporting	Green

5.1.5.6 Standardization and Certification Criteria

UMTS is used by wireless service providers in multiple countries to provide 3G cellular access. UMTS devices are manufactured and are widely in use, giving it a TRL level of 6. Technology readiness receives a rating of green. The standard was designed as a cellular voice and high speed data technology. For this reason, certification risk is rated as red.

Robustness and link layer compatibility are rated as red due to being a CDMA based technology. Determinism is rated as yellow since it may be difficult to always meet link margin requirements when using CDMA.

Standardization and Certification	Technology Readiness Level	Green
	Certification Risk	Red
	Robustness	Red
	Determinism	Yellow
	Link Layer Compatibility	Red

5.1.5.7 Waveform Criteria

W-CDMA uses FDD for duplexing and is rated as red. TD-CDMA and TD-SCDMA use TDD and are rated as green. All three interfaces use CDMA as the means of multiplexing and are all rated as red since this is least desirable. In both directions, the modulations used are QPSK and QAM and are rated as yellow.

		W-CDMA	TD-CDMA	TD-SCDMA
Waveform	Duplexing	Red	Green	Green
	Forward Link Multiplexing	Red	Red	Red
	Reverse Link Multiplexing	Red	Red	Red
	Forward Link Modulation	Yellow	Yellow	Yellow
	Reverse Link Modulation	Yellow	Yellow	Yellow

5.1.6 CDMA2000 (1x-3xRTT, 1x EVDV)

CDMA 2000 uses 1.25 MHz carriers for multiple users of voice and data using Walsh codes to disseminate specific conversations and data sessions. In 3xRTT, three carriers are combined for a bandwidth of 3.75 MHz which was actually superseded by the CDMA2000 1x evolution strategy. CDMA2000 3xRTT was never implemented in its intended form. CDMA2000 is currently the most spectrally efficient technology supporting both voice and data.

EVDV was not adopted due to the impending release of EVDO being a data-only technology that would be used together with the legacy CDMA2000 networks for voice. Accordingly, Qualcomm ceased any further development. The EVDO overlay path made more sense for budgetary reasons as well. Differences are noted in the sections that follow.

5.1.6.1 Air/Ground Communications Criteria

CDMA2000 will not support a distance of 83 NM unless a Pseudorandom Noise (PN) code increment of 12 is used providing only 42 PN codes, which is unrealistic with air-based and larger terrestrial networks. There are range extension features available from specific vendors which would need to be modeled and tested.

Air/Ground Communications	Taxi / Surface	Green
	Takeoff / Landing / Terminal	Green
	En Route	Yellow

5.1.6.2 Data Transmission Criteria

CDMA2000 meets most packet data criteria without modification. The access channel uses a data rate of 4.8 kbps in a 20 ms frame which equates to a 50 Hz repetition rate. Data rates are up to 150 kbps reverse link and 307 kbps forward link supporting all but streaming surveillance data from the aircraft on 1xRTT. 3xRTT would be required to support video on the reverse link. On EVDV up to 600kbps on the forward link on EVDV.

		1-3x RTT	1x EVDV
Data Transmission	Addressed capability	Green	Green
	Repetition rate	Green	Green
	Command/Control	Green	Green
	C&C and ATS	Green	Green
	C&C, ATS, and Surveillance	Yellow	Green

5.1.6.3 Mobility Criteria

CDMA2000 meets most of the mobility criteria as expected. Required carrier or network changes would impose the retuning of both radios and be considered a hard handoff, however inter-carrier handoffs would be soft. Dynamic power control is superior as would be required in an interference limited technology. Data rates are variable as dynamics of the RF environment dictate. QoS retuning is effectively accomplished by cross carrier as well as sector port changes to the same carrier oriented in a different direction with an improved Chip Energy/Spectral Interference (E_c/I_o).

Mobility	Handoff	Yellow
	Dynamic Power Control	Green
	Adaptive Modulation Rates	Green
	Active QoS Retuning	Green

5.1.6.4 Security Criteria

CDMA2000 has inherent Advanced Encryption Standard (AES) encryption and the Secure Hash Algorithm (SHA) SHA-1 functionality in addition to dynamic channel allocation which improves availability.

Security	Confidentiality	Yellow
	Integrity	Yellow
	Availability	Yellow

5.1.6.5 Traffic QoS Criteria

CDMA2000 meets all Traffic QoS criteria as expected. Most criteria are mandatory for interference control in a multicarrier environment. Cross-carrier distribution is designed to balance traffic load distribution keeping linear Power Amplifier (PA) output power consistent within sectors. Bandwidth is allocated based on RF conditions, user requirements, and availability. Layer 3 messaging can provide volumes of statistical performance data.

Traffic QoS	Cross-Carrier Distribution	
	Priority	
	Classes	
	Reliability/ARQ	
	Dynamic Bandwidth Allocation	
	RF Statistics Reporting	

5.1.6.6 Standardization and Certification Criteria

CDMA2000 has been in commercial use for nearly 20 years in the US, however it has not been certified for aeronautical command and control use. 1xRTT was released about 2 years later and EVDV never commercially materialized due to EVDO being released sooner. EVDV was expected 2 years after EVDO. The technology readiness levels reflect this timing. Based on the Rockwell Collins Trade Study, it was determined that a CDMA approach would not be capable of meeting the required availability requirement based on a low SIR which resulted in a red evaluation for Robustness. CDMA, although the waveform may have been deterministic, the performance is a function of the number of UAs operating, and the 99.8% availability cannot be guaranteed. Change would be required to address this issue and the CDMA architectures were rated as yellow. For link layer compatibility, CDMA was evaluated as red due to the significant redesign required replacing the CDMA technology structure.

		1-3x RTT	1x EVDV
Standardization and Certification	Technology Readiness Level		
	Certification Risk		
	Robustness		
	Determinism		
	Link Layer Compatibility		

5.1.6.7 Waveform Criteria

The major differences between CDMA2000 1xRTT and 1xEVDV lie in the physical layer. CDMA is a spread spectrum technology and by nature requires a ground station amplifier with stable linearity especially on the forward link. However, forward and reverse link timing is not a concern. The modulation is QPSK in both directions. It is recommended neither for forward or reverse link use.

For EVDV, the duplexing and reverse link multiplexing are similar to CDMA2000, being FDD and CDMA respectively. However, TDMA was proposed for the forward link for higher throughput and to reduce complexity. The modulation schemes are QPSK, 8PSK or 16-QAM on the forward link and 64-QAM on the reverse link. These non-constant envelope modulation schemes are also comparable to CDMA2000 which are not recommended. On EVDV, forward link multiplexing can be pure TDMA for high speed applications. Again, EVDV was never fully developed and was subsequently superseded by EVDO, leaving CDMA to continue to carry voice traffic in an overlaid network environment.

		1-3x RTT	1x EVDV
Waveform	Duplexing		
	Forward Link Multiplexing		
	Reverse Link Multiplexing		
	Forward Link Modulation		
	Reverse Link Modulation		

5.1.7 EVDO

Evolution-Data Optimized or Evolution-Data Only (EVDO) was designed as a data overlay on CDMA2000 and is a part of that family of standards, but considered 3G specified as IS-856. The EVDO channel also has a bandwidth of 1.25 MHz. There are two versions or revisions commonly in operation, 0 and A. Rev0 provides a peak data rate of 2.4 Mbps and RevA provides 3.1 Mbps peak. There is a standard for EVDO Rev C which provides peak data rates to 288 Mbps forward and 75 Mbps reverse in a 20 MHz bandwidth, however domestic operators chose to go directly to Long Term Evolution (LTE). EVDO can provide an always-on connection, but operators can set a time-out threshold to save on network resources. The technology is CDMA-based on the forward link and TDMA-based on the reverse link.

5.1.7.1 Air/Ground Communications Criteria

EVDO is CDMA based on the forward link which will not support a distance of 83 NM unless a PN increment of 12 is used which will only provide 42 PN codes and is unrealistic with air-based networks. There are range extension features available from specific vendors which would need to be modeled and tested.

Air/Ground Communications	Taxi / Surface	Green
	Takeoff / Landing / Terminal	Green
	En Route	Yellow

5.1.7.2 Data Transmission Criteria

EVDO meets all of the required data transmission criteria. The forward link CDMA channel has a 37 Hz repetition rate. EVDO RevA has forward link throughput rates from 600 kbps to 1400 kbps with bursts to 3.1 Mbps. The Reverse Link rates are 500 kbps to 800 kbps with bursts up to 1.8 Mbps.

Data Transmission	Addressed capability	Green
	Repetition rate	Green
	Command/Control	Green
	C&C and ATS	Green
	C&C, ATS, and Surveillance	Green

5.1.7.3 Mobility Criteria

EVDO meets most of the mobility criteria as expected; however, required carrier or network changes would impose the retuning of both radios and be considered a hard handoff. Dynamic power control is superior as would be required in an interference limited technology. Data rates are variable as RF conditions dictate. QoS retuning is effectively accomplished by carrier changes as well as sector changes to the same carrier oriented in a different direction with an improved E_c/I_o .

Mobility	Handoff	Yellow
	Dynamic Power Control	Green
	Adaptive Modulation Rates	Green
	Active QoS Retuning	Yellow

5.1.7.4 Security Criteria

EVDO has inherent AES and CAVE encryption and SHA-1 hash functionality in addition to dynamic channel allocation which improves availability. EVDO Rev C is Orthogonal Frequency Division Multiple

Access (OFDMA) which uses sophisticated control and signaling schemes including adaptive reverse link interference control enhancing availability.

Security	Confidentiality	Green
	Integrity	Yellow
	Availability	Green

5.1.7.5 Traffic QoS Criteria

EVDO meets all traffic QoS criteria as expected. Most criteria are mandatory for interference control in a multicarrier environment. Cross-carrier distribution is meant to balance load to keep linear PA output power consistent. Bandwidth is allocated based on RF conditions, user requirements, and availability. Layer 3 messaging can provide volumes of statistical performance data.

Traffic QoS	Cross-Carrier Distribution	Green
	Priority	Green
	Classes	Green
	Reliability/ARQ	Green
	Dynamic Bandwidth Allocation	Green
	RF Statistics Reporting	Green

5.1.7.6 Standardization and Certification Criteria

EVDO has been deployed in the US for the last 5-7 years, however it has not been certified for aeronautical command and control use.

Standardization and Certification	Technology Readiness Level	Green
	Certification Risk	Red
	Robustness	Red
	Determinism	Yellow
	Link Layer Compatibility	Red

5.1.7.7 Waveform Criteria

EVDO uses CDMA on the forward link and by nature requires a ground station amplifier with stable linearity. However, forward and reverse link timing is not a concern. The modulation is QPSK in both directions. 8-PSK and 16QAM can also be used on the reverse link. Therefore, it is not recommended for use in either direction.

Waveform	Duplexing	Red
	Forward Link Multiplexing	Green
	Reverse Link Multiplexing	Red
	Forward Link Modulation	Yellow
	Reverse Link Modulation	Yellow

5.1.8 *LTE*

LTE is a 4G data technology and can carry Voice over Internet Protocol (VoIP). Technically, it is 3.9G since it does not meet every criterion in ITU’s definition. It is based on GSM-EDGE and UMTS standards. It is also based on OFDM, multiple antennas and all IP flat architecture. LTE is implemented using Evolved

Packet System (EPS) architecture. EPS represents a migration from the traditional hierarchical system architecture to a flattened architecture that minimizes the number of hops and distributes the processing load across the network. There is an FDD version, which is commonly used and a TDD version which China is currently deploying. It is ran under a complete IP-based network architecture (IMS) which simplifies designed providing for improved latency over 3-G. The main LTE parameters are shown in Figure 3 below.

Parameter	Value
Modulation	Selectable form QPSK, 16-QAM, 64-QAM
Forward Link Access Scheme	OFDMA
Reverse Link Access Scheme	DFTS-OFDM (i.e. SC-FDMA)
Bandwidth	Selectable from 1.4/3.0/5.0/10/15/20 MHz
Minimum TTI	1ms
Sub-Carrier spacing	15 kHz
Cyclic Prefix Length	Short: 4.7 us/Long: 16.7 us
Spatial Multiplexing	Forward Link: maximum of 4 layers/Uplink Radio. Reverse Link: 1 Layer/Uplink Radio MU-MIMO for Forward and Reverse Link

Figure 3. LTE parameters

Release 8 is the base for LTE. Release 9 has minor additions. Release 10 is the base for LTE-Advanced. Release 10 will have enhancements for LTE-Advanced. Basic Release 8 capabilities are shown in Figure 4.

Category		1	2	3	4	5
Peak rate Mbps	DL	10	50	100	150	300
	UL	5	25	50	50	75
Capability for physical functionalities						
RF bandwidth		20MHz				
Modulation	DL	QPSK, 16QAM, 64QAM				
	UL	QPSK, 16QAM				QPSK, 16QAM, 64QAM
Multi-antenna						
2 Rx diversity		Assumed in performance requirements.				
2x2 MIMO		Not supported	Mandatory			
4x4 MIMO		Not supported				Mandatory

Figure 4. LTE Release 8 capabilities

5.1.8.1 Air/Ground Communications Criteria

There are no issues with LTE meeting or exceeding all air/ground communications criteria. It should perform very well during all phases of flight in both FDD and TDD formats.

Air/Ground Communications	Taxi / Surface	
	Takeoff / Landing / Terminal	
	En Route	

5.1.8.2 Data Transmission Criteria

The LTE specification states peak forward link rates to 100 Mbps and 50 Mbps on the reverse link. It supports network bandwidth sizes from 1.4 MHz to 20 MHz (1.4, 3, 5, 10, 15 and 20 MHz sizes) and supports both FDD and TDD. Theoretical peak rates assume a 20 MHz bandwidth and 4x4 Multiple Input-Multiple Output (MIMO) technologies. LTE can support 200 simultaneous users/sector/cell in a 5 MHz bandwidth configuration. One FDD LTE frame (type 1) is 10 ms and structured from 10-1 ms subframes. One TDD LTE frame (type 2) is also 10 ms, but is divided into two half frames (5 ms each) and these are divided into five subframes (1 ms each). See Figure 5 below. LTE-Advanced, is said to provide peak data rates of 1 Gbps and 500 Mbps on the forward and reverse links respectively. This is achieved using wider bandwidths than standard LTE. LTE can easily satisfy all data transmission criteria.

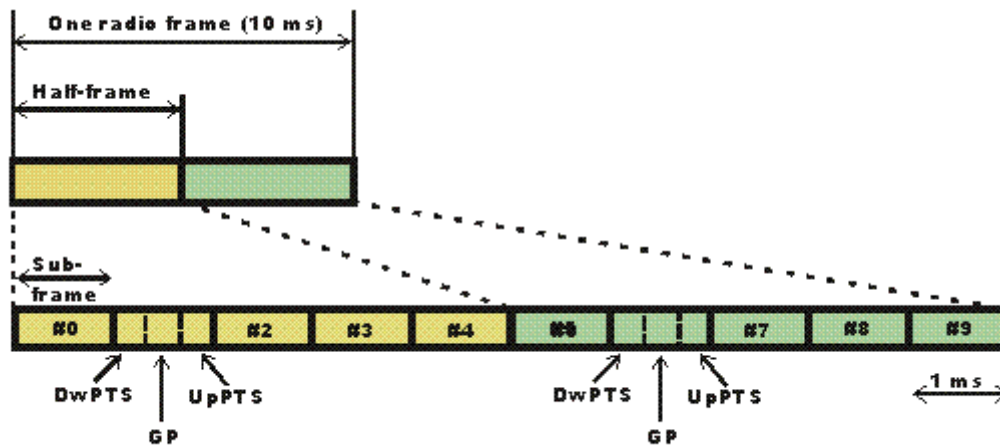

Figure 5. LTE TDD frame structure

Data Transmission	Addressed capability	
	Repetition rate	
	Command/Control	
	C&C and ATS	
	C&C, ATS, and Surveillance	

5.1.8.3 Mobility Criteria

LTE offers handover support for GSM, CDMA, and UMTS. These would be hard handoffs, whereas intra site/sector LTE handoffs would be soft. The hard handoffs are network controlled where the forward link would notify the aircraft as to the target ground station to hand into. To control packet loss, a data

forwarding process transfers undelivered data to the target ground station for delivery to the aircraft at the new location. LTE will optimize speed and bandwidth based on resources, requirements and RF conditions. The use and quality of the band is monitored so users can be placed in optimum areas of the spectrum.

Dynamic power control commands can be sent in every sub-frame, 1000 times/second. They take effect 4 sub-frames after the command is received. The adaptive modulation selection algorithm is based on mapping tables that return a modulation format after having received a Signal to Interference plus Noise Ratio (SINR) value. The supported schemes are QPSK, 16-QAM and 64-QAM. The adaptive modulation can happen at a slow rate or fast rate. The fast rate can show a gain due to the high instantaneous Signal to Noise Ratio (SNR) conditions.

Mobility	Handoff	
	Dynamic Power Control	
	Adaptive Modulation Rates	
	Active QoS Retuning	

5.1.8.4 Security Criteria

LTE supports AES and EEA2 (EPS Encryption Algorithm) for high confidentiality. It also uses the EPS Integrity Algorithm 2 (EIA2), a CBC-MAC. This technology also uses sophisticated interference mitigation techniques to boost throughput and availability. IPSec with Public Key Infrastructure (PKI) is used as a standardized security solution on the ground station level. PKI is applied to authenticate network elements and authorize network access, whereas IPSec provides integrity and confidentiality on the backhaul.

Security	Confidentiality	
	Integrity	
	Availability	

5.1.8.5 Traffic QoS Criteria

Traffic and bandwidth on an LTE carrier is distributed based on requirements, RF conditions, and resource availability. In LTE, both transmission functionalities ARQ and Hybrid ARQ (HARQ) are provided. ARQ provides error correction by retransmissions in acknowledged mode at the Radio Link Control (RLC) sub-layer of layer 2. HARQ is located in the MAC sub-layer of layer 2 and ensures delivery to layer 1. Refer to Figure 6 and Figure 7.

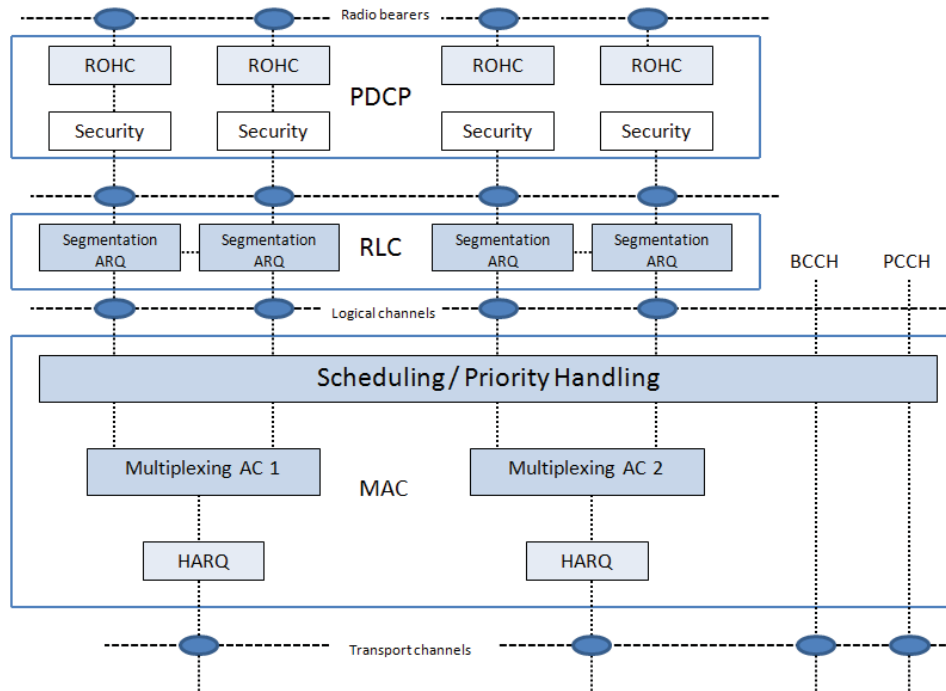

Figure 6. LTE forward link structure

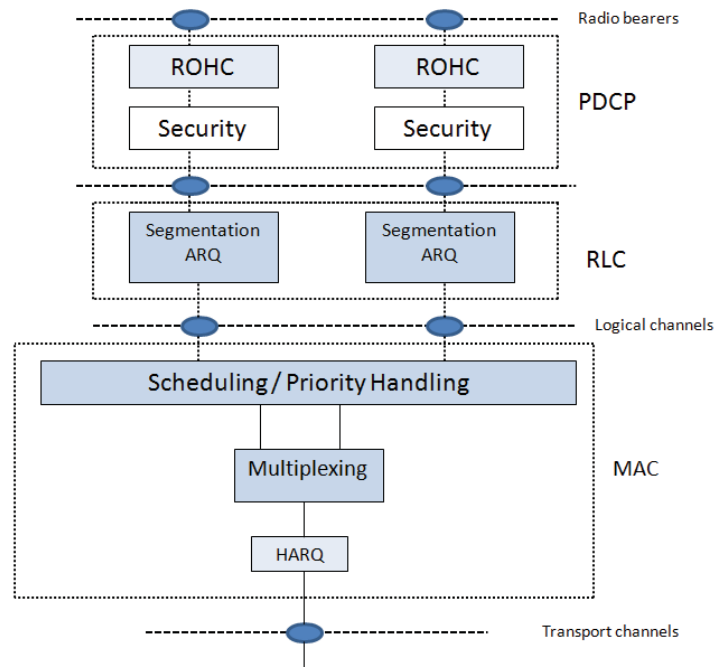

Figure 7. LTE reverse link structure

Quality Class Identifiers (QCI) represents a reference that is mapped to a parameter matrix that control data packet forwarding treatment such as priority, delay, and loss rate. Admission Control (AC) is used to allow or deny set-up requests based on available resources, QoS requirements, priority levels, and the QoS of sessions in progress. LTE also supports Self-Organizing Network (SON) operation which will take inputs from the network and optimize performance. Standards are being developed.

RF statistics are prevalent which identify quality/throughput and resource issues to the operator. Statistics are important for optimizing the network as well as identifying poor performing end user equipment. Measurements are needed in the core, the RF and the air interface as shown in Figure 8.

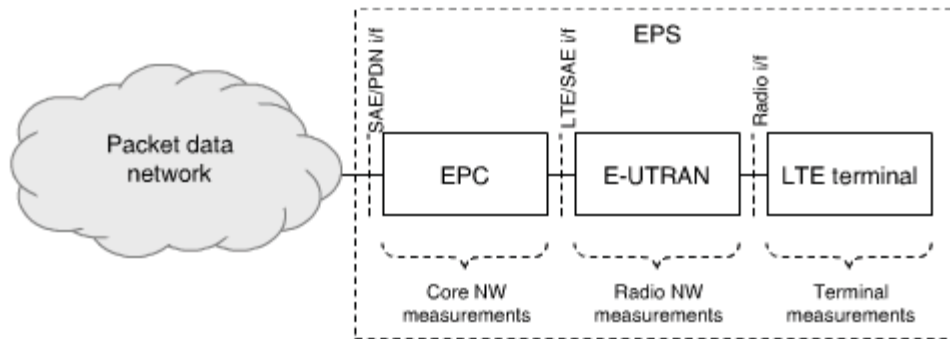

Figure 8. LTE network measurements

Traffic QoS	Cross-Carrier Distribution	Green
	Priority	Green
	Classes	Green
	Reliability/ARQ	Green
	Dynamic Bandwidth Allocation	Green
	RF Statistics Reporting	Green

5.1.8.6 Standardization and Certification Criteria

LTE was proposed in 2004 and first launched in 2009. Although LTE is a proven technology, it has not been certified for aeronautical command and control use, therefore the technology readiness level is rated green and certification risk is rated red. Rockwell has rated OFDM systems as red (which include LTE) due to the need for transmitter linearity and the need for multiple power amplifiers for sectored antennas. The single carrier LTE architecture did not have any identified issues with its deterministic performance characteristics; therefore it received a green rating for this criterion. The link layer compatibility was rated yellow due to the waveform being OFDM.

Standardization and Certification	Technology Readiness Level	Green
	Certification Risk	Red
	Robustness	Red
	Determinism	Green
	Link Layer Compatibility	Yellow

5.1.8.7 Waveform Criteria

LTE is based on OFDM in the Forward Link and Single Carrier FDMA (SC-FDMA) on the reverse link. This scheme provides the scalable bandwidth mentioned earlier. LTE also supports both FDD and TDD duplexing. TDD will enable dynamic changes to meet loading requirements. QPSK, 16-QAM, and 64-QAM are used in both the forward and reverse link.

Waveform	Duplexing	
	Forward Link Multiplexing	
	Reverse Link Multiplexing	
	Forward Link Modulation	
	Reverse Link Modulation	

5.1.9 DECT

Digital Enhanced Cordless Telecommunications (DECT) is an ETSI standard developed as a short-range voice and data link. Originally designed for cordless phones, its use has expanded into homes, offices, and industrial settings to provide wireless LANs and ad-hoc networks. Its TDMA structure consists of a 10 ms frame broken into 24 full-slots. The first 12 full-slots are used for the forward link and the last 12 full-slots for the reverse link. This structure is shown in Figure 9. Double-slots can be defined by using 2 adjacent full-slots. Half-slots can also be defined by splitting a full-slot. In order to support simple duplexing, 2 full-slots spaced 5 ms apart are used. The MAC layer is also able to establish asymmetric connections by varying the number and type of slots used.

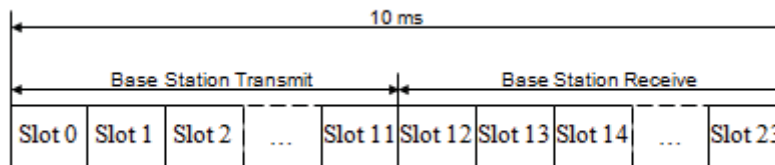

Figure 9. DECT TDMA structure

DECT defines varying sizes of “physical packets”. A physical packet is the number of symbols within the slot that will be used. For example, the basic physical packet uses 420 symbols in a full-slot (which is 480 symbols) and leaves 60 symbols unused. The left over symbols are used as the guard time. Other physical packets can provide larger guard times.

5.1.9.1 Air/Ground Communications Criteria

Since DECT was designed as a short-range link, it provides a cell range of 300 m. The functional environment for which DECT was initially designed makes it very unsuitable for the distances needed for air/ground communications to support the CNPC link. However, due to power limitations and the varying guard times, the range has potential to be significantly increased. All phases of flight have been rated as red since significant modifications would have to be made to extend the supported range.

Air/Ground Communications	Taxi / Surface	
	Takeoff / Landing / Terminal	
	En Route	

5.1.9.2 Data Transmission Criteria

DECT supports the use a 36 bit globally unique address. It can support a minimum repetition rate of 50 Hz with its 10 ms frame. If the MAC layer sets up a larger connection, more slots can be accessed, thus increasing the repetition rate. The data rates for C&C, ATS, and surveillance can be supported by DECT. The net data rate for a single slot can range from 8 kbps up to 5 Mbps. Multiple slots can be combined to further increase the data rate. DECT is rated as green for supporting all data transmission criteria.

Data Transmission	Addressing	Green
	Repetition Rate	Green
	Command/Control	Green
	C&C and ATS	Green
	C&C, ATS, and Surveillance	Green

5.1.9.3 Mobility Criteria

Soft handoffs are supported by DECT. The mobile devices monitor the current cell's channels along with other neighboring cells. When a different channel or cell can provide a better link, it will perform a soft handoff. DECT is evaluated as green for handoffs. Dynamic power control is available for the mobile device only. It can use an open loop method in which the mobile device monitors the link and adjusts its power accordingly. The base station is also able to broadcast out parameters, such as fading margins, to help the mobile devices make more appropriate power control decisions. Dynamic power control is rated as green.

Multiple modulation types are supported by DECT. Only the modulation of user traffic within the frame can be modified. The header information always uses the same modulation. The mobile device issues a request to change the modulation, which the base station confirms. This allows a variety of data rates to be achieved. DECT is rated as green for supporting adaptive modulation rates. DECT makes extensive use of monitoring adjacent channels and cells to ensure the best quality channel is selected, and is rated as green for active QoS retuning.

Mobility	Handoff	Green
	Dynamic Power Control	Green
	Adaptive Modulation Rates	Green
	Active QoS Retuning	Green

5.1.9.4 Security Criteria

Both the confidentiality and integrity algorithms are proprietary DECT algorithms that require non-disclosure agreements for implementation. These algorithms are considered weak and have been reverse-engineered. Both confidentiality and integrity are rated as red. DECT employs frequency-hopping techniques, dynamic power control for the mobile radio, and dynamic frequency selection. Availability is rated as green since it contains sufficient mechanisms to combat interference.

Security	Confidentiality	Red
	Integrity	Red
	Availability	Green

5.1.9.5 Traffic QoS Criteria

The DECT standard specifies how loaded a base station is allowed to become. If a channel becomes over utilized, the mobile device must use another channel. There is also a limit to the combined utilization of all channels for a single base station. This is due to transmit power regulations in the frequency band. It is rated as green since the mechanisms are in place to distribute traffic among channels and base stations.

DECT does not currently define a means of prioritizing one data stream over another. To add traffic priority levels to DECT, priorities would have to be defined along with a means for the upper layers to convey a requested priority. A scheduler would also need to be implemented to order traffic by priority. For this reason DECT is rated as yellow for traffic priority. Although DECT defines three classes of service, these are not sufficient to fulfill this requirement. DECT’s classes consist of unacknowledged, single-frame acknowledged, and multi-frame acknowledged data transfers. More appropriate traffic classes could be defined and implemented. Therefore, support for traffic classes is rated as yellow. DECT supports unacknowledged and acknowledged data. It also supports ARQ at both the MAC and Data Link Control layers. It is rated as green for traffic reliability.

Multiple methods are able to provide dynamic bandwidth to devices. These include slot size, physical packet size, and the number of slots in each direction. DECT is rated as green for dynamic bandwidth allocation. The standard does not currently support RF statistics reporting. However, it is worth noting that QoS message types have been set aside for manufacturer-specific uses. The standard states that this could be used for reporting the Received Signal Strength Indicator (RSSI) of the mobile device, and for this reason it is rated as yellow.

Traffic QoS	Cross-Carrier Distribution	Green
	Priority	Yellow
	Classes	Yellow
	Reliability/ARQ	Green
	Dynamic Bandwidth Allocation	Green
	RF Statistics Reporting	Yellow

5.1.9.6 Standardization and Certification Criteria

Development of the DECT standard began in the late 1980s and has undergone several revisions since then. DECT-based devices have been widely used in countries all around the globe, proving that it is capable of supporting voice and data services. However, DECT has not been tested in any aeronautical environments. This gives DECT a TRL level of 6, and thus is rated as green for technology readiness. DECT was designed as a short-range wireless voice and data technology. For this reason it is rated as red for certification risk.

Robustness issues could not be identified for DECT and is rated as green. The TDMA structure provides deterministic characteristics and is receive a green rating. Link layer compatibility is rated as green since converting from TDMA to FDMA, which would only be needed for the reverse link, is within reason.

Standardization and Certification	Technology Readiness Level	Green
	Certification Risk	Red
	Robustness	Green
	Determinism	Green
	Link Layer Compatibility	Green

5.1.9.7 Waveform Criteria

DECT uses TDD for duplexing and is rated as green. For multiplexing, it uses TDMA within FDMA. Each base station provides multiple channels and allows multiple devices per channel. Even if one device uses the entire channel (as if it were using FDMA), the TDMA structure still exists. It is rated as green for forward link multiplexing and yellow for reverse link multiplexing. DECT uses a variety of modulations such as GFSK, Differential QPSK (DQPSK), and QAM in both directions. It is rated as green for both forward and reverse modulation since it can use GFSK.

Waveform	Duplexing	
	Forward Link Multiplexing	
	Reverse Link Multiplexing	
	Forward Link Modulation	
	Reverse Link Modulation	

5.2 IEEE 802 Family

5.2.1 802.11

The IEEE 802.11 technology utilizes a Carrier Sense Multiple Access with Collision Avoidance (CSMA/CA) technique to provide wireless LAN access. Multiple revisions to the standard have been made. The revisions define the physical layers that the rest of the 802.11 protocol can operate over. In CSMA, each station will listen to the channel to ensure it is clear. Once it is deemed clear, it will then transmit. Collision avoidance is used to decrease the likelihood that multiple stations will transmit as soon as the channel is clear. Each station randomly chooses a small time interval to wait after the channel is clear before it is allowed to send.

To help ensure that large frames arrive without collisions due to the hidden node problem, the station will first send a short Request to Send (RTS) frame. If the RTS is received, the Access Point (AP) will respond with a Clear to Send (CTS) frame indicating to all other stations to halt transmissions during this time. The CTS includes a Network Allocation Vector (NAV) which is the length of the allocation. Figure 10 shows how these messages are used sequentially.

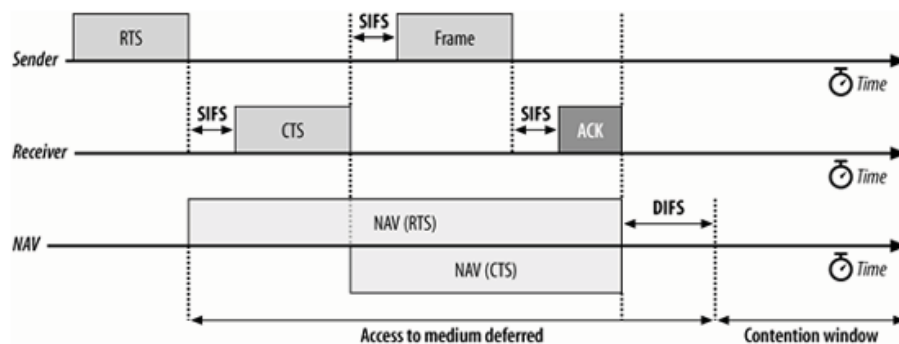

Figure 10. RTS/CTS Example

5.2.1.1 Air/Ground Communications Criteria

Originally designed to provide wireless access within a couple hundred meters, its popularity increased the need for extended ranges. IEEE Std 802.11y-2008 is an extension to the standard that allows 802.11a to operate in a licensed band from 3650–3700 MHz. Increased transmit power along with slight protocol

modifications allows for extended range up to 5000 meters (2.7 NM). Extensive research and implementation has been conducted concerning long range 802.11 links. The taxi/surface phase is rated as green. The terminal phase is rated as yellow since it meets the 2.5 NM condition and should be modifiable to support more. En route is rated as red.

Air/Ground Communications	Taxi / Surface	Green
	Takeoff / Landing / Terminal	Yellow
	En Route	Red

5.2.1.2 Data Transmission Criteria

802.11 uses IEEE 802.3 MAC addresses, also known as Ethernet addresses, which are 48 bits. It is rated as green for addressing capabilities. Since 802.11 uses CSMA, there is no predefined access order. The standard defines optional QoS services that can be supported to provide scheduled transmission opportunities (TXOP) for a station. These can be reserved for both directions and allow a maximum timeframe to be specified for the TXOP. This helps ensure time-critical traffic (such as voice and video) is less affected by collisions. The repetition rate is not easy calculated even when TXOPs are used. If a collision does occur, it uses random backoff values along with a configurable contention window size. However, it is still well within reason for 802.11 to meet the repetition rate of 20 Hz, and is rated as green.

With the multiple revisions of 802.11, a wide range of data rates are supported. These range from 1 Mbps up to 600 Mbps. Even at the lowest supported data rate, the data throughput provides for C&C, ATS, and surveillance and is rated as green for these three criteria.

Data Transmission	Addressing	Green
	Repetition Rate	Green
	Command/Control	Green
	C&C and ATS	Green
	C&C, ATS, and Surveillance	Green

5.2.1.3 Mobility Criteria

The 802.11 standard does not define a make-before-break mechanism for handoffs. For transitions between one Extended Service Set (ESS) to another, interruption is likely to occur. Extensive research is available for implementation of soft handoffs in 802.11 environments. Because of the existing research, and no technical issue appears to preclude it, 802.11 is rated as yellow for handoffs.

Transmit Power Control (TPC) procedures are defined to help reduce interference and meet government regulations. Devices are configured with regulatory minimum and maximum transmit power levels. Stations convey these levels when associating with an AP. The AP uses these levels to help determine transmit power levels of any Basic Service Set (BSS) it controls. It has been rated as green for power control.

802.11 stations normally use Binary Phase Shift Keying (BPSK) or QPSK modulation. Stations operating in the 5 GHz band can use 16-QAM or 64-QAM to supporting much higher data rates. Depending on the data rate chosen between the station and the AP, the appropriate modulation scheme will be used. If signal quality changes, the modulation will change in order to best utilize the channel. For this reason, it is rated as green for adaptive modulation rates.

In certain regulatory regions, it is required for stations operating in the 5 GHz range to monitor co-channel interference from radar systems. 802.11 defines a Dynamic Frequency Selection (DFS) mechanism to comply with these regulations. If an AP detects a radar system operating in its frequency, it will announce that it is switching to a different channel, and that the stations should also switch. It is rated as green for QoS retuning.

Mobility	Handoff	Yellow
	Dynamic Power Control	Green
	Adaptive Modulation Rates	Green
	Active QoS Retuning	Green

5.2.1.4 Security Criteria

The standard supports AES for confidentiality of data and is rated as green. The standard supports NIST-800.38c recommended technology Counter with CBC-MAC (CCM) for data integrity protection, employing AES-based CBC-MAC. CBC-MAC is more efficiently implemented in hardware which is why Hash-based Message Authentication Code (HMAC) was not used. It is rated as yellow for integrity. 802.11 supports dynamic power control, dynamic channel allocation, and OFDM. It receives a rating of green for availability.

Security	Confidentiality	Green
	Integrity	Yellow
	Availability	Green

5.2.1.5 Traffic QoS Criteria

802.11 does not implement cross-carrier distribution for traffic. However, it already provides some mechanisms for moving stations to other channels, such as DFS. It is rated as yellow since these preexisting capabilities are similar to those needed to distribute traffic among other channels or stations. The QoS services support 8 levels of user priority (UP). The UP is specified by the upper layers for each data unit. The MAC layer uses the UP for prioritizing data units relative to each other. It has earned a rating of green for traffic priority. Its traffic categories consist of background, best effort, video, and voice. The channel access values can be configured for each category to ensure adequate QoS for different environments. It rated as green for traffic classes.

In a station supporting QoS services, it can request that the data unit be either acknowledged or unacknowledged. For acknowledged data units, it can use either single acknowledgments or block acknowledgements at the MAC layer. 802.11 has been rated green for supporting traffic reliability.

Inherent to CSMA, each device is able to access the channel as needed, provided the channel is available and no collisions occur. It is rated as green for dynamic bandwidth allocation since each device can use as much or as little bandwidth as needed. The 802.11 AP is able to send Measurement Requests to stations indicating what type of RF statistics it should collect and for how long. At the end of that time, the station will respond with a Measurement Report to the AP. Given this feature, it is rates as green for RF statistics reporting.

Traffic QoS	Cross-Carrier Distribution	Yellow
	Priority	Green
	Classes	Green
	Reliability/ARQ	Green
	Dynamic Bandwidth Allocation	Green
	RF Statistics Reporting	Green

5.2.1.6 Standardization and Certification Criteria

Most current short-range wireless LANs deployed use 802.11. It is used in multiple countries and can operate in numerous frequency ranges. The wide deployment has shown that the 802.11 standard is a mature technology, but it has not been tested for aeronautical use. It has been rated as green since it has a TRL level of 6. It was designed as a short-range wireless technology. Certification risk is evaluated as red.

Among the different versions of 802.11, OFDM and direct-sequence spread spectrum (DSSS) are used, thus robustness is rated as red. Determinism is rated as red, which is due to random channel access techniques inherent to CSMA. Link layer compatibility is rated as yellow since the CSMA would need significant restructuring to work in the proposed waveform.

Standardization and Certification	Technology Readiness Level	Green
	Certification Risk	Red
	Robustness	Red
	Determinism	Red
	Link Layer Compatibility	Yellow

5.2.1.7 Waveform Criteria

CSMA has the same effect as TDD/TDMA since the transmissions are separated by time. Given its TDD nature, it is rated as green for duplexing. It is rated as green for forward link multiplexing and yellow for reverse link multiplexing due to the TDMA based structure. 802.11 supports OFDM and QAM modulations in both directions and is rated as yellow.

Waveform	Duplexing	Green
	Forward Link Multiplexing	Green
	Reverse Link Multiplexing	Yellow
	Forward Link Modulation	Yellow
	Reverse Link Modulation	Yellow

5.2.2 802.16

IEEE 802.16 is a broad TDMA point-to-multipoint system standard with that specifies several physical layer options, including single-carrier, OFDM, and OFDMA options. Some of the enhancements to the original standard include vehicle speed mobility (802.16e), multihop relay (802.16j), and advanced high-rate interfaces (802.16m). For the purposes of this assessment the 802.16-2009 standard (which includes 802.16e) is used as the basis of evaluation.

802.16 can be used in an FDD or TDD configuration. Under the TDD configuration, each frame is divided into downlink (DL) and uplink (UL) subframes as shown in Figure 11. As with other wireless technologies, downlink refers to communications originating from the Base Station (BS) while uplink refers to

communications originating from the subscriber. To stay consistent with the rest of the document, the DL frames refer to the forward link while the UL frames refer to the reverse link. The forward link subframe begins with the downlink map (DL-MAP) and uplink map (UL-MAP) sections that respectively define the usage of the slots in the forward and reverse link subframes. This is followed by TDM sections which contain data to the subscribers. Each TDM section may use a different modulation and coding scheme which is adapted based on feedback from the subscribers. The subframe ends with a Transmit/receive Transition Gap (TTG) guard time.

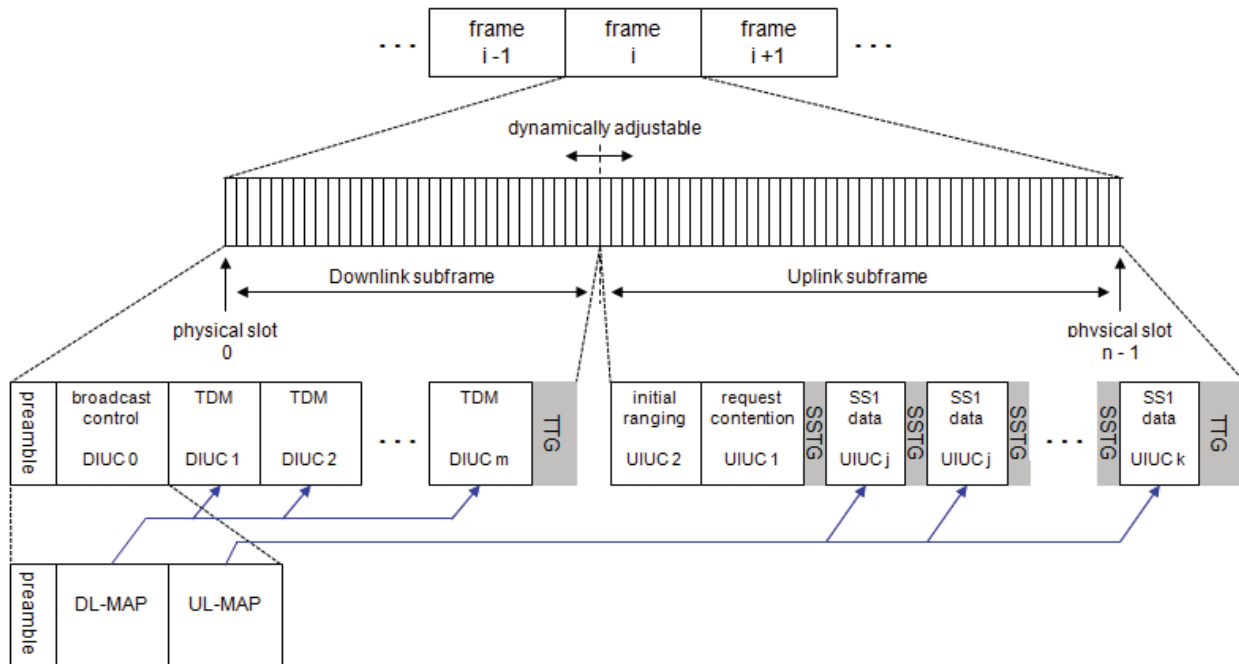

Figure 11. 802.16 TDD frame structure

The reverse link subframe begins with an initial ranging section that is available for random-access usage by new subscribers entering the network. This is followed by another random access section that is used for requesting reservations. The following sections are used by the subscribers (as assigned by the UL-MAP) that are each separated by a Subscriber Station Transition Gap (SSTG). As with the forward link sections, each reverse link block may utilize a different modulation and coding scheme. After the last subscriber block, another TTG guard time separates these transmissions from the next forward link transmission.

5.2.2.1 Air/Ground Communications Criteria

802.16 was designed to be a metropolitan area network capable of communication range of up to 30 miles, although many sources indicate that the actual usable range is limited to about 10 miles when considering clutter. With the appropriate link budget, extending the range is possible, although it may require adjustment to the guard times. IEEE 802.16 uses ranging procedures to control the transmission time by the mobile stations. The amount of adjustment in the ranging messages is one potential limitation to the ultimate range that can be achieved. However, the adjustment parameter is based upon several variables including the specific physical layer selected, bandwidth, and symbol rate therefore these must be known before the limit can be calculated. Based on the stated ranges for

802.16, it is rated as green for the surface and terminal areas but yellow for en route as it will likely need some modifications to meet the desired range.

Air/Ground Communications	Taxi / Surface	Green
	Takeoff / Landing / Terminal	Green
	En Route	Yellow

5.2.2.2 Data Transmission Criteria

IEEE 802.16 uses 48-bit addresses and supports unicast addressing, yielding a green rating for the addressing criteria. Although not required by the UAS CNPC link at this time, it also supports broadcast and multicast addressing. The choice of physical layer impacts the number of frames per second, with the single carrier option supporting 500-2000 frames per second. Use of one of the real-time polling services or the unsolicited grant service will easily allow an access rate of 20 Hz. Therefore the repetition rate criteria is rated green.

IEEE 802.16 supports several methods for supporting real-time services. The unsolicited grant service provides fixed bandwidth allocations at periodic intervals with low overhead and delay. For traffic that is variable in size, the real-time polling services are more efficient at providing the right amount of bandwidth at the appropriate intervals. Using these services, voice, weather, and video can be supported. IEEE 802.16 is in general a high data rate system (at least 10 Mbps at the physical layer). These data rates are more than adequate to support the combination of command and control, ATS relay, and surveillance products; therefore, the criteria for all the data rates are rated as green.

Data Transmission	Addressing	Green
	Repetition Rate	Green
	Command/Control	Green
	C&C and ATS	Green
	C&C, ATS, and Surveillance	Green

5.2.2.3 Mobility Criteria

IEEE 802.16 utilizes frequency reuse for the base station layout. Handoffs in 802.16 require a frequency change which rates the handoff criteria as yellow, although it should be noted that 802.16 allows for a radio to quickly switch frequencies for scanning purposes without interruption of traffic. IEEE 802.16 does support dynamic power control as part of its ranging procedures and multiple modulation profiles, yielding a rating of green for dynamic power control and adaptive modulation rates. The mobile station scans its neighbor frequencies for handoff purposes. This capability allows a green rating for active QoS retuning.

Mobility	Handoff	Yellow
	Dynamic Power Control	Green
	Adaptive Modulation Rates	Green
	Active QoS Retuning	Green

5.2.2.4 Security Criteria

IEEE 802.16 support a FIPS-accepted AES 128-bit encryption algorithm therefore confidentiality is rated as green. For integrity, it supports HMAC-SHA1 and AES-CMAC for management frames only. These are commercially accepted but not FIPS accepted therefore integrity rates as yellow. IEEE 802.16 supports

several features for availability, including RF power control, dynamic frequency selection, and OFDM therefore availability criteria rates as green.

Security	Confidentiality	Green
	Integrity	Yellow
	Availability	Green

5.2.2.5 Traffic QoS Criteria

IEEE 802.16 contains support for multiple channels. The BS is capable of handing subscribers off to different channels; therefore, the cross carrier distribution criteria is rated as green. It also has 8 priority levels and traffic classes, such as unsolicited grant, real time variable rate, and best effort, which would be effective for the various UAS traffic types. It also supports ARQ on a per-connection (traffic instance) basis and HARQ if the OFDMA waveform is used. The priority, traffic classes, and reliability criteria are rated as green.

802.16 is a TDMA based system where subscribers can request bandwidth as needed, up to an amount specified by service agreements. This rates 802.16 as green for the dynamic bandwidth allocation criteria. It also includes features for the base station to request feedback on Carrier to Interference and Noise Ratio (CINR), reverse path transmission power, and a Channel Quality Indicator (CQI) for Adaptive Modulation and Coding (AMC) bands which rates the RF statistics reporting as green.

Traffic QoS	Cross-Carrier Distribution	Green
	Priority	Green
	Classes	Green
	Reliability/ARQ	Green
	Dynamic Bandwidth Allocation	Green
	RF Statistics Reporting	Green

5.2.2.6 Standardization and Certification Criteria

802.16 has fully developed standards and is commercially available; therefore, the TRL criteria is rated as green. It is not an aeronautical or public safety communications link. It is rated as red for the certification risk criteria, although it should be noted that 802.16 is the basis of an ongoing project called the Aeronautical Mobile Airport Communications System (AeroMACS). AeroMACS is in the process of defining standards through RTCA with an ultimate goal of certification for aeronautical use.

The single carrier 802.16 option did not have any identified issues with robustness or determinism therefore it received a green rating for those criteria. Since 802.16 is fundamentally a TDMA system, the link layer compatibility is rated as green for the single carrier option.

Standardization and Certification	TRL	Green
	Certification Risk	Red
	Robustness	Green
	Determinism	Green
	Link Layer Compatibility	Green

5.2.2.7 Waveform Criteria

802.16 is capable of either TDD or FDD duplexing resulting in a green rating for the duplexing option. If the single carrier physical layer configuration is selected, it uses TDMA for the forward link resulting in a green rating for the forward link multiplexing option. The same single carrier configuration uses TDMA for reverse link multiplexing which results in a yellow rating. Both the forward and reverse link modulations are single carrier for this configuration, but are not constant envelope therefore these criteria rate as yellow.

Waveform	Duplexing	
	Forward Link Multiplexing	
	Reverse Link Multiplexing	
	Forward Link Modulation	
	Reverse Link Modulation	

5.2.3 802.20

For the purposes of this assessment the 802.20-2008 standard is used as the basis of evaluation. 802.20 supports two modes of operation. The wideband mode is capable of FDD or TDD operation with various bandwidths. The 625k-MC mode uses a 625 kHz multicarrier physical layer and is based on the High Capacity – Spatial Division Multiple Access (HC-SDMA) technology specified in the ATIS-0700004.2005 standard. Much of the operation of this mode is not specifically defined in the 802.20 standard and instead, refers back to the Alliance for Telecommunications Industry Solutions (ATIS) standard.

When using the TDD configuration, each superframe is divided into three alternating Forward Link (FL) and Reverse Link (RL) sections. 802.20 offers two standard configurations of the TDD structure. In the 4:4 configuration shown in Figure 12, the structure uses 4 frames per FL section and 4 frames per RL section for a total of 12 FL frames and 12 RL frames per superframe. The 6:3 configuration uses 6 frames per FL section and 3 frames per RL section for a total of 18 FL frames and 9 RL frames per superframe.

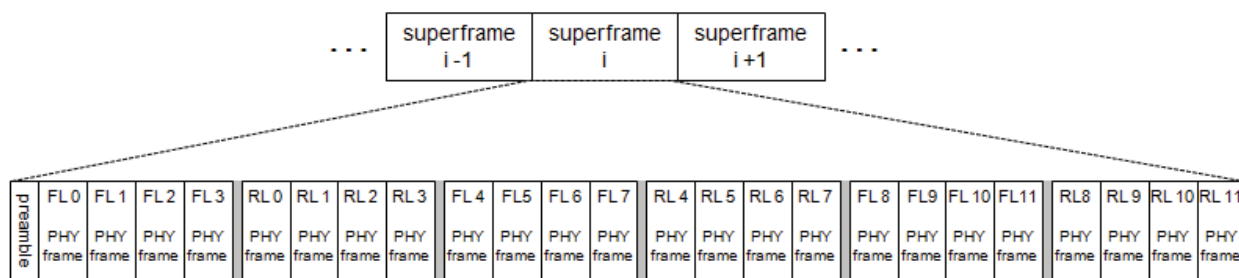

Figure 12. 802.20 TDD frame structure (TDD44)

5.2.3.1 Air/Ground Communications Criteria

802.20 has a claimed range of up to about 9 miles, depending on the terrain and clutter. Although this is assuming the mobile is at or near ground level, and likely the range may be higher for a UA with greater altitude, the en route criteria is rated as red as significant modifications likely would be necessary to get the ranges required. However, the range does rate the surface and terminal criteria as green.

Air/Ground Communications	Taxi / Surface	
	Takeoff / Landing / Terminal	
	En Route	

5.2.3.2 Data Transmission Criteria

802.20 supports unicast addressing which yields a green rating for the addressing criteria. It additionally offers broadcast and multicast services. When using the TDD44 configuration, 802.20 may utilize one of several predefined superframe durations ranging between 23 and 27 ms. Utilizing just one frame per superframe provides for access rates of between 37 and 43 Hz, ensuring a green rating for the repetition rate criteria.

802.20 can support downlink rates of 6.4 – 190.4 kbps depending on the modulation and coding used. This is sufficient for the command and control and ATS relay data rates. Voice can be provided utilizing one of the higher priority traffic classes. However, the data rate is short of meeting the requirements for command and control, ATS relay, and surveillance products combined. Additionally, the highest rate possible would not likely be available at distant ranges. Modification of the technology would be necessary to support a higher data rate. As a result, 802.20 receives a green rating for basic command and control and the command and control with ATS relay criteria, but a yellow rating for the criteria with combined command and control, ATS relay, and surveillance.

Data Transmission	Addressing	Green
	Repetition Rate	Green
	Command/Control	Green
	C&C and ATS	Green
	C&C, ATS, and Surveillance	Yellow

5.2.3.3 Mobility Criteria

802.20 contains many desirable features for mobility. It supports softer handoffs for a green rating on the handoff criteria. 802.20 also supports dynamic power control and adaptive modulations on both the forward and reverse links. The reverse link includes both open and closed loop methods for power adjustment. 802.20 supports up to 16 modulation classes that can be dynamically selected and used. This rates the power control and adaptive modulation rates criteria as green. 802.20 does not support active retuning based on signal interference but should be capable of having this incorporated.

Mobility	Handoff	Green
	Dynamic Power Control	Green
	Adaptive Modulation Rates	Green
	Active QoS Retuning	Yellow

5.2.3.4 Security Criteria

802.20 supports AES 128 bit encryption and HMAC for integrity protection of data and management frames, therefore confidentiality and integrity are rated as green. The standard supports dynamic power control, dynamic channel allocation, and OFDM therefore the availability criteria is rated as green.

Security	Confidentiality	Green
	Integrity	Green
	Availability	Green

5.2.3.5 Traffic QoS Criteria

The 802.20 standard does not explicitly specify a mechanism for performing cross-carrier distribution; therefore, this criteria is rated as yellow. It does include priority at multiple layers, including 256 levels

for streams and 16 levels for IP flows. 802.20 also includes 3 levels of QoS classes, which are referred to as priority. Priority 1 has expedited delivery, low loss, low latency, and low jitter. Priority 2 is assured forwarding with twelve sublevels that provide flexibility in its usage. Priority 3 is best effort. These options are sufficient for the foreseen needs of a UAS CNPC link therefore 802.20 receives a green rating for the priority and traffic classes criteria.

802.20 supports both Acknowledged Mode (AM) and Unacknowledged Mode (UM) traffic and has options for HARQ as well as ARQ in the 625k-MC profile. This yields a green rating for the reliability criteria. In 802.20 the usage of the TDMA slots is allocated by the scheduler as needed, which results in a green rating for the dynamic bandwidth allocation criteria. It has built-in support for reporting of RF statistics such as CQI. As a result it receives a green rating for the statistics criteria.

Traffic QoS	Cross-Carrier Distribution	Yellow
	Priority	Green
	Classes	Green
	Reliability/ARQ	Green
	Dynamic Bandwidth Allocation	Green
	RF Statistics Reporting	Green

5.2.3.6 Standardization and Certification Criteria

Standards are complete for IEEE 802.20, although it is noted that there is no current activity. The 625k-MC profile is commercially sold as the iBurst technology¹⁴. It is sufficiently mature to receive a green rating for the TRL. IEEE 802.20 was not designed for aeronautical or public safety use; therefore, the certification risk criteria is rated as red.

For 802.20, the robustness is rated as red because of its use of OFDMA in the forward link and CDMA for a portion of the reverse link. The CDMA robustness is low due to the increased interference from multiple simultaneous transmissions on the same channel. OFDM is less robust than other modulations because of the stability required in the PA. Determinism is rated green as no effects to impact it were discovered. The link layer compatibility is rated as yellow due to similar complexity as 802.16.

Standardization and Certification	TRL	Green
	Certification Risk	Red
	Robustness	Red
	Determinism	Green
	Link Layer Compatibility	Yellow

5.2.3.7 Waveform Criteria

Both the Wideband and 625k-MC modes of operation support TDD duplexing for a green rating for the duplexing criteria. 802.20 utilizes OFDMA for both the forward and reverse link, although the reverse link also includes a unique CDMA segment for signaling. The OFDMA forward link receives a yellow rating for forward link multiplexing; the reverse link multiplexing receives a red rating due to the use of the CDMA segment. The OFDMA used for both the forward and reverse links uses a multi-carrier waveform which results in a red rating for both uplink and downlink modulation.

¹⁴ <http://global.kyocera.com/prdct/telecom/office/iburst/news/080709.html>

Waveform	Duplexing	Green
	Forward Link Multiplexing	Yellow
	Reverse Link Multiplexing	Red
	Forward Link Modulation	Red
	Reverse Link Modulation	Red

5.3 Public Safety Family

5.3.1 P-25

Association of Public-Safety Communications Officials (APCO) Project 25 (P-25) is a system designed for use in public safety communications. Phase I of P-25 is FDMA, while Phase II is TDMA. P-25 systems can be either trunked or conventional. A conventional system is characterized by relatively simple geographically fixed infrastructure that serves to repeat radio calls from one frequency to another. All aspects of system operation are under manual control of the system users. Conventional systems can operate direct (radio-to-radio) or via a repeater. A trunked system is characterized by a controller in the infrastructure which assigns calls to a specific channel automatically, relieving users of the need to control operation. Trunked systems can accommodate more radio users on fewer channels. The P-25 standard covers digital speech and/or data services including optional connections to fixed telephony and data networks. Voice calls can be broadcast, unaddressed, group, or individual. Data can be circuit switched (unreliable or reliable) or packet switched (unconfirmed or confirmed).

5.3.1.1 Air/Ground Communications Criteria

The standard lists the range as TBD (to be determined), though it does specify the range of a RF subsystem to be 40 miles, and multiple RF subsystems can be grouped together to form a system. Therefore all phases were rated green, except en route which was rated yellow.

Air/Ground Communications	Taxi / Surface	Green
	Takeoff / Landing / Terminal	Green
	En Route	Yellow

5.3.1.2 Data Transmission Criteria

P-25 was designed to support both broadcast and addressed applications therefore it meets the green conditions of the addressing criteria.

Data transmission over the RF link has a minimum gross bit rate of 9.6 kbps. The net bit rate that is available after deduction of overhead for error correction and re-transmission is 5.8 kbps. It is capable of meeting the 20 Hz access rate and is rated green for the repetition rate criterion.

There are 198 bytes provided for voice information in each 224 byte superframe, which takes 360 ms to transmit. This yields a voice rate of 4.4 kbps. However, there are only 4 bytes provided for low speed data (user applications not defined in the Common Air Interface) in each 360 ms superframe, for a total capacity of 88.89 bps. Optionally, P-25 can also support separate packet data messages, with a maximum bit rate of 6.008 kbps. Delivery reliability is best effort. This does not meet the requirements for Command/Control, but could be modified to do so; therefore, it is rated yellow. When combined with ATS or Surveillance the data rates are less than 1/4 of the required data rates. It would take significant modification to meet the requirement. Therefore C&C, ATS, and surveillance were rated red.

Data Transmission	Addressing	Green
	Repetition Rate	Green
	Command/Control	Yellow
	C&C and ATS	Red
	C&C, ATS, and Surveillance	Red

5.3.1.3 Mobility Criteria

Multiple repeaters are used to service a large network area. They are each given a separate Network Access Code (NAC) so they can occupy the same channel. The user may select the NAC based on its proximity to a receiver. Because this is not done automatically, handoff was rated yellow.

Dynamic power control can be set and requires no user intervention. This results in a green rating for the dynamic power control criterion. P-25 only utilizes Continuous 4-level Frequency Modulation (C4FM) and Compatible Quadrature Phase Shift Keying (CQPSK) modulations; however, this could be modified, so the adaptive modulation rates criterion is rated yellow. P-25 does not contain any features for active QoS retuning; however, it could be modified to do so, and was therefore given a yellow rating.

Mobility	Handoff	Yellow
	Dynamic Power Control	Green
	Adaptive Modulation Rates	Yellow
	Active QoS Retuning	Yellow

5.3.1.4 Security Criteria

P-25 supports AES and Data Encryption Standard (DES), including 3DES and DES Output Feedback (OFB) encryption. In addition, using aftermarket software, operators can install the following FIPS 140-2 Approved Operational Modes: DES Encryption Codebook (ECB), DES OFB, DES Cipher Block Chaining (CBC), DES 1-bit Cipher Feedback (CFB), AES-256 ECB, AES-256 OFB, and AES-256 CBC. Therefore, P-25 receives a green rating for confidentiality. Message Authentication Codes are not used in P-25. In addition, cryptographic keying of radios is done manually or performed remotely via Over the Air Rekeying. Therefore, P-25 is rated yellow for integrity. P-25 supports dynamical channel assignment over the full band. However, channels are narrow band and it would be easy for multiple adjacent channels to be jammed. Therefore, P-25 is rated yellow for availability.

Security	Confidentiality	Green
	Integrity	Yellow
	Availability	Yellow

5.3.1.5 Traffic QoS Criteria

In a conventional P-25 system users control their own access. However, in a trunked P-25 system a resource controller coordinates the user's access on a per call basis; therefore cross-carrier distribution criterion is rated green. Many service requests contain a priority attribute. RF Subsystems process higher priority requests first. However, since channel access is obtained by carrier sense collision avoidance system, this does not meet the requirements for green. Because it can be modified, priority receives a yellow rating. P-25 does not contain traffic classes, however it could be modified to support this feature.

Each packet contains a check sum. If corrupted, an ARQ is sent; therefore, P-25 is given a green rating for reliability/ARQ. P-25 utilizes dynamic assignment of TDMA slots on a per-call basis, however, once a channel is assigned, the user cannot dynamically change the channel. Dynamic bandwidth allocation is therefore given a yellow rating.

If the user sends a Get Information Request, the Mobile Routing Control (MRC) will respond with the channel quality and signal strength. In addition, the RF Subsystem periodically sends messages with the status of adjacent sites. Therefore, RF statistics reporting criterion is rated green.

Traffic Qos	Cross-Carrier Distribution	Green
	Priority	Yellow
	Classes	Yellow
	Reliability/ARQ	Green
	Dynamic Bandwidth Allocation	Yellow
	RF Statistics Reporting	Green

5.3.1.6 Standardization and Certification Criteria

P-25 is in use, and is therefore given a green for Technology Readiness Level. It is a public safety technology and is therefore given a yellow rating for its certification risk. P-25 is a reliable technology and is rated green for robustness. Phase I of P-25 is FDMA, while Phase II is TDMA. Neither FDMA or TDMA systems have interference issues, therefore P-25 is rated green for determinism. P-25 is not a complex technology and should be easy to integrate with the upper layers, therefore P-25 is rated green for link layer compatibility.

Standardization and Certification	Technology Readiness Level	Green
	Certification Risk	Yellow
	Robustness	Green
	Determinism	Green
	Link Layer Compatibility	Green

5.3.1.7 Waveform Criteria

Mobile units are half duplex on separate frequency channels (FDD); therefore the duplexing criterion is rated yellow. Phase I of P-25 is FDMA, while Phase II is TDMA. TDMA is preferred for the forward link, while FDMA is preferred for the reverse link. Therefore, with P-25 either the forward or reverse link would have to be modified depending on which phase was selected. Assuming Phase I was selected, forward link multiplexing is rated yellow. The reverse link multiplexing is also rated yellow since the mobile units generally wait until the inbound channel is idle before transmitting. The C4FM modulation option of P-25 is constant envelope; therefore, both the forward and reverse link modulation criteria are rated green.

Waveform	Duplexing	Yellow
	Forward Link Multiplexing	Yellow
	Reverse Link Multiplexing	Yellow
	Forward Link Modulation	Green
	Reverse Link Modulation	Green

5.3.2 P-34

After development of P-25, APCO recognized the need for advanced high rate data services and created Project 34 (P-34) in that pursuit. The P-34 standard enables interoperability in a wideband radio system using high-speed packet data over wideband data channels in the 700 MHz public safety band. The goal is to reuse as much Internet Protocol (IP) technology as possible to facilitate the convergence of wireline and wireless data networks. P-34 offers two types of physical layers: Scalable Adaptive Modulation (SAM) and Isotropic Orthogonal Transform Algorithm (IOTA). SAM is TDMA and delivers a flexible bit rate. IOTA consists of a number of frequency-division multiplexed subchannels, enabling the bandwidth to be easily changed. Channel bandwidth can be 50, 100, or 150 kHz.

5.3.2.1 Air/Ground Communications Criteria

A propagation margin of 500 μ s allows P-34 to be used up to distances of 81 NM. Note that this is just under the requirement of 83 NM. However it is felt that it could be very easily modified to meet the criteria for en route. Therefore, all stages of flight are rated green.

Air/Ground Communications	Taxi / Surface	Green
	Takeoff / Landing / Terminal	Green
	En Route	Green

5.3.2.2 Data Transmission Criteria

P-34 was designed to support both IPv4 and IPv6; therefore, it meets the green conditions of the addressing criteria. P-34 can achieve up to 864 kbps using IOTA modulation and 150 kHz channels. It can meet the 20 Hz access rate and the repetition rate criterion is rated green. Additionally, it meets even the highest data rate requirements, so all data rate criteria are all rated green.

Data Transmission	Addressing	Green
	Repetition Rate	Green
	Command/Control	Green
	C&C and ATS	Green
	C&C, ATS, and Surveillance	Green

5.3.2.3 Mobility Criteria

Handovers are negotiated during automatic unit registration procedures; therefore, handoff was rated green. A mobile unit's transmit power is dynamically changed to maintain QoS, reduce adjacent and co-channel interference, and conserve energy; therefore, dynamic power control and active QoS retuning were rated green. SAM has QPSK, 16 QAM, and 64 QAM. IOTA has 2-, 4-, and 8-ary Amplitude Shift Keying (ASK), which are selected on a slot by slot basis. The adaptive modulation rates criterion is rated green.

Mobility	Handoff	Green
	Dynamic Power Control	Green
	Adaptive Modulation Rates	Green
	Active QoS Retuning	Green

5.3.2.4 Security Criteria

P-34 supports block encryption protocol (BEP) and has a scrambling over the air interface. Confidentiality is therefore rated yellow. P-34 mobile subscriber authentication is performed. Integrity is rated yellow. P-34 is wideband, utilizes FDD with OFDM modulation, has variable channelization using different modulations, and performs dynamic power control. Therefore, it is rated green for availability.

Security	Confidentiality	Yellow
	Integrity	Yellow
	Availability	Green

5.3.2.5 Traffic QoS Criteria

P-34 has automatic frequency control, and was therefore rated green for the cross-carrier distribution criterion. Traffic from the mobile units to the network use slotted aloha random access. Outbound traffic is controlled by priority queuing, where the 4-bit priority field is specified by the mobile unit. Priority is rated green. For the classes criterion, P-34 utilizes IP classes and is therefore rated green.

Data can be acknowledged or unacknowledged. Therefore, reliability is rated green. P-34 assigns 50, 100, or 150 kHz channels on a per-call basis; however, once a channel is assigned, the user cannot dynamically change the channel. For this reason dynamic bandwidth allocation receives a yellow rating. P-34 measures the recovered signal strength, and is therefore given a green rating.

Traffic QoS	Cross-Carrier Distribution	Green
	Priority	Green
	Classes	Green
	Reliability/ARQ	Green
	Dynamic Bandwidth Allocation	Yellow
	RF Statistics Reporting	Green

5.3.2.6 Standardization and Certification Criteria

P-34 is in use and is therefore given a green rating for TRL. It was developed for use as a public safety technology and is given a yellow rating for its certification risk.

P-34 is an OFDM technology, which have issues with PA stability affecting performance. Therefore P-34 was rated red for robustness. P-34 is a TDMA system and was therefore rated green for determinism. There are no issues foreseen for integrating P-34 with the proposed link layer, therefore P-34 was rated green for link layer compatibility.

Standardization and Certification	Technology Readiness Level	Green
	Certification Risk	Yellow
	Robustness	Red
	Determinism	Green
	Link Layer Compatibility	Green

5.3.2.7 Waveform Criteria

P-34 uses a half-duplex FDD format, therefore the duplexing criterion is rated yellow. TDMA is preferred for the forward link, while FDMA is preferred for the reverse link. Forward link multiplexing is rated green. The reverse link would have to be modified. As such the reverse link multiplexing is rated yellow. P-34 utilizes OFDM, therefore both forward and reverse link modulation criteria are rated red.

Waveform	Duplexing	Yellow
	Forward Link Multiplexing	Green
	Reverse Link Multiplexing	Yellow
	Forward Link Modulation	Red
	Reverse Link Modulation	Red

5.3.3 IDRA

The Integrated Dispatch Radio System (IDRA) is based on the Association of Radio Industries and Businesses (ARIB) RCR STD-32A standard. The original standard was written in Japanese, this study utilizes a version that had been translated to English.

IDRA utilizes a 6-slot TDMA system with independent forward and reverse link channels. In IDRA terminology, the forward link is referred to as the outbound channel while the reverse link is the inbound channel. As shown in Figure 13, each slot is 15 ms in length, and each frame is 6 slots long. The forward and reverse link slots are shifted so that a single mobile radio may be used for both transmission and reception. As an example, a mobile radio that is assigned slot channel 1 will first tune to the forward link channel and receive from a repeater in slot 1. After the reception is completed, the mobile retunes to the reverse link frequency and then transmits in the reverse link channel 1. Using this structure, IDRA can support 6 simultaneous users (at 1 slot per user) on a single pair of radio channels.

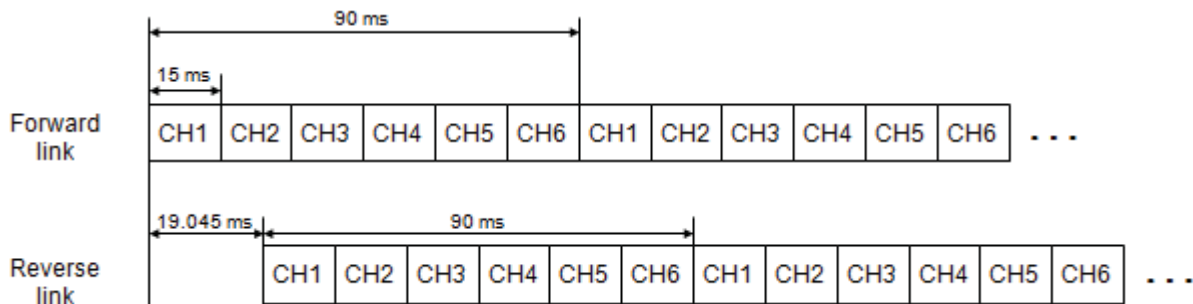

Figure 13. IDRA channel framing

5.3.3.1 Air/Ground Communications Criteria

Range information is lacking for the IDRA system; however, it is anticipated to be comparable to the other public radio systems with a range possibly up to 40 km. There does not appear to be any technical reason the range could not be increased, and indeed may be higher if used for ground-air

communications; therefore, IDRA is rated as yellow for en route and green for surface and terminal phases.

Air/Ground Communications	Taxi / Surface	Green
	Takeoff / Landing / Terminal	Green
	En Route	Yellow

5.3.3.2 Data Transmission Criteria

IDRA supports addressed messaging along with multicast in the form of “party calls” for a green rating for addressing. At best, an IDRA device can use two independent slots out of the six available in a 90 ms frame, for a maximum access rate of 22 Hz in each direction. However, these slots must be used for common access control channels and radio control channels as well as the user data channels; therefore, it is unlikely to reliably achieve 20 Hz access for data without modification. The repetition rate criteria is rated as yellow for IDRA.

IDRA supports a per-slot rate of 10 kbps yielding a maximum data rate of 20 kbps if 2 slots per frame are utilized. Since IDRA is an FDD system, the 20 kbps rate is simultaneously available to both the forward and reverse link. This results in a green rating for the basic command and control. IDRA is designed primarily as a voice system with a vocoder rate of 7.467 kbps, however the total data rate is not enough to support the addition of ATS relay or surveillance. Additional bandwidth would need to be allocated to support these services.

Data Transmission	Addressing	Green
	Repetition Rate	Yellow
	Command/Control	Green
	C&C and ATS	Yellow
	C&C, ATS, and Surveillance	Red

5.3.3.3 Mobility Criteria

The IDRA standard is built around a single repeater architecture, where all of the mobile radios are preconfigured to the repeater. The system is not designed for a mobile to handoff from one repeater to another, and it is unclear at this point how much technical difficulty would be involved in adding such a capability. For this reason, IDRA is rated as red for the handoff criteria. IDRA does, however, support dynamic power control for the mobile unit in both an autonomous mode and an explicit ground controlled mode, yielding a green rating for the dynamic power control criteria.

IDRA uses a fixed modulation and does not support adaptive modulations, but this should be possible to add to the technology with the appropriate control messages for at least the data channels. Channels assignments are made by the repeater based on current resources only; it does not support retuning based on signal quality. This feature also should be implementable if needed through use of new control messages.

Mobility	Handoff	Red
	Dynamic Power Control	Green
	Adaptive Modulation Rates	Yellow
	Active QoS Retuning	Yellow

5.3.3.4 Security Criteria

IDRA does not support cryptographic algorithms or hashing functions therefore it receives a red rating for confidentiality and integrity. The dynamic frequency allocation method used on call initialization can be considered an availability technique earning IDRA a yellow rating for the availability criteria.

Security	Confidentiality	Red
	Integrity	Red
	Availability	Yellow

5.3.3.5 Traffic QoS Criteria

The IDRA repeater assigns a mobile unit to an available radio channel as needed, intrinsically supporting the cross-carrier distribution criteria rating of green. It has an optional feature for prioritized access intended for emergency use but it is not deemed sufficient for the priority mechanisms desired for UAS. Since modification to support priority seems feasible, IDRA also does not support more than a basic voice/data structure requiring improvements to support the QoS classes for UAS traffic. It does not support acknowledgement on per class basis. The priority, traffic classes, and reliability criteria are all evaluated as yellow.

IDRA uses TDMA that is demand-assigned on a per-call basis, but it does not support more than one assignment at a time restricting the amount of bandwidth that can be utilized. IDRA does not contain any support for RF statistics reporting but the feature could be added using new control messages. Both these criteria are rated as yellow.

Traffic QoS	Cross-Carrier Distribution	Green
	Priority	Yellow
	Classes	Yellow
	Reliability/ARQ	Yellow
	Dynamic Bandwidth Allocation	Yellow
	RF Statistics Reporting	Yellow

5.3.3.6 Standardization and Certification Criteria

IDRA has a defined standard and, although it does not appear to be a popular technology, equipment is available. IDRA is rated as green for the TRL criteria. IDRA is designed as a public safety radio system and evaluated as yellow for certification risk.

The robustness, determinism, and link layer compatibility are rated green.

Standardization and Certification	TRL	Green
	Certification Risk	Yellow
	Robustness	Green
	Determinism	Green
	Link Layer Compatibility	Green

5.3.3.7 Waveform Criteria

IDRA only supports a half-duplex FDD option resulting in a yellow rating for the duplexing criteria. Multiplexing is TDMA for both the forward and reverse link channels which results in a green rating for the forward link multiplexing criteria but a yellow rating for the reverse link multiplexing criteria. The

16QAM modulation used in both the forward and reverse link is single carrier but not constant envelope yielding a yellow rating for both modulation criteria.

Waveform	Duplexing	Yellow
	Uplink Multiplexing	Green
	Downlink Multiplexing	Yellow
	Uplink Modulation	Yellow
	Downlink Modulation	Yellow

5.3.4 TETRAPOL

Terrestrial Trunked Radio Police (TETRAPOL) is a narrowband FDMA system that was originally based on early revisions of TETRA. However, it is significantly different from TETRA and is evaluated separately. It uses 12.5 kHz channels to support both voice and data. It provides circuit or packet switched voice and data.

The frame structure consists of 20 ms slots providing 160 bits of information per slot. 200 slots are organized into a 4-second superframe. There are two types of radio channels: control and traffic. When small amounts of data need to be sent, the control channel can be used as a shared channel. Random access requests are made before slots are allocated. For each superframe on the control channel, not all slots are available for user data. Some are set aside for paging, broadcasts, and random access requests/responses. Devices can request to be moved to a dedicated traffic channel when appropriate. The standard leaves this open for interpretation as to when a device should be moved to a dedicated traffic channel. The traffic channels can use the entire superframe for bidirectional voice and data. Signaling may occur by stealing frames on this channel.

5.3.4.1 Air/Ground Communications Criteria

TETRAPOL base stations can provide a range of approximately 15 NM in rural areas. It is able to provide both voice and data over its entire coverage area. It is rated as green up to and including the terminal phase. It is rated as red for en route since it does not meet the 21 NM range needed for a rating of yellow.

Air/Ground Communications	Taxi / Surface	Green
	Takeoff / Landing / Terminal	Green
	En Route	Red

5.3.4.2 Data Transmission Criteria

TETRAPOL devices use a 36 bit address and can support point-to-point and point-to-multipoint communications. It is rated as green for addressing capabilities. When on a traffic channel, all 200 slots are usable for data transfers. This offers a repetition rate of 50 Hz since each slot is 20 ms. The control channel does not provide this high of repetition rate, since opportunities to make a random access request are available every 500 ms. If a request is made at every opportunity, this provides a repetition rate of only 2 Hz. Since the traffic channels can provide an adequate repetition rate, it is rated as green.

The narrowband channel limits TETRAPOL to a gross data rate of 8 kbps and is not able to even support the 14 kbps needed for command and control alone. This could be increased to meet the data throughput requirements if bandwidth channels were increased or combined. For this reason it is rated as yellow for providing C&C and ATS. It is unable to meet the requirement for including surveillance also and is rated as red.

Data Transmission	Addressing	Green
	Repetition Rate	Green
	Command/Control	Yellow
	C&C and ATS	Yellow
	C&C, ATS, and Surveillance	Red

5.3.4.3 Mobility Criteria

TETRAPOL does not support soft handoffs. Devices are required to fully reauthenticate when switching to a new cell. This causes disruptions in service while setting up a new connection. Soft handoff procedures could be added to meet this requirement and is rated as yellow. Only the mobile devices support dynamic power control. Changes are made based on local link conditions. It is rated as green for dynamic power control.

TETRAPOL currently supports only one modulation, GMSK. More modulations could be added. Also, the mobile device and base station would need to agree on a modulation to use. For a dedicated traffic channel, this should be fairly straightforward since only the two radios are concerned. Since multiple devices listen on the control channel, one modulation must always be used on that channel. It is rated as yellow since modifications are within reason to support adaptive modulation.

If interference on a traffic channel becomes a problem, the mobile station must fall back to the control channel to reestablish a new traffic channel. The time to set up a new traffic channel could cause a loss of connection and is rated as yellow for QoS retuning.

Mobility	Handoff	Yellow
	Dynamic Power Control	Green
	Adaptive Modulation Rates	Yellow
	Active QoS Retuning	Yellow

5.3.4.4 Security Criteria

TETRAPOL supports end-to-end encryption using Static Cipher Key (SCK), Derived Cipher Key (DCK), and Common Cipher Key (CCK). It is rated as yellow for confidentiality. Integrity is achieved by the use of authentication of the mobile subscriber using a 128 bit authentication key and the subscriber ID. It is rated as yellow. TETRAPOL uses FDMA narrow band (12.5 KHz) channels with GMSK modulation. It is rated as yellow for availability.

Security	Confidentiality	Yellow
	Integrity	Yellow
	Availability	Yellow

5.3.4.5 Traffic QoS Criteria

Traffic distribution is inherent in TETRAPOL. When a connection needs more data than can be sent on the control channel, it is moved to its own dedicated traffic channel. It is rated as green for traffic distribution. The standard supports a few priority mechanisms. It is able to provide priority among mobile devices based on preset levels. Data streams are able to indicate priorities for slot allocation, retention, and preemption of the traffic channel. It is rated as green for traffic priority.

TETRAPOL does not currently define traffic classes. This should be modifiable to allow the upper layers to specify a type of class and for the MAC layer to treat the classes as appropriate. It is rated as yellow for traffic classes. TETRAPOL uses the ISO High-Level Data Link Control (HDLC) standard for its link layer control. It supports both acknowledged and unacknowledged data. It is rated as green for traffic reliability.

The data throughput rate on the control channel is relatively limited and with a low repetition rate (2 Hz). When a mobile device moves to a traffic channel, a static amount of bandwidth is used for the connection. This is feasible for a voice system since it has a very predictable data rate. Even if the connection does not require the entire bandwidth, it is still set aside for that connection. It also cannot request more if needed. Modifications could be made so that a mobile device can request different sized channels or combine channels to support a variety of data. It is rated as yellow since the bandwidth allocation only consists of a whole 12 kHz channel.

TETRAPOL does not define any means of reporting RF statistics. Any decisions for power control or cell reselections are based on local link statistics only. Since the statistics are being generated but not sent, new control messages could be defined to request and send link statistics. For this reason it is rated as yellow.

Traffic QoS	Cross-Carrier Distribution	Green
	Priority	Green
	Classes	Yellow
	Reliability/ARQ	Green
	Dynamic Bandwidth Allocation	Yellow
	RF Statistics Reporting	Yellow

5.3.4.6 Standardization and Certification Criteria

Multiple TETRAPOL networks are currently in use for public safety in numerous countries. It has not been tested for aeronautical communication and is rated as green since it has a TRL level of 6. TETRAPOL was designed as a robust and secure data link for public safety, thus it is rated as yellow for certification risk. The TDD/FDMA has deterministic features and is rated as green. Link layer compatibility is rated as yellow because of SWAP concerns when used on the forward link.

Standardization and Certification	Technology Readiness Level	Green
	Certification Risk	Yellow
	Robustness	Yellow
	Determinism	Green
	Link Layer Compatibility	Yellow

5.3.4.7 Waveform Criteria

TETRAPOL uses TDD for duplexing and is rated as green. FDMA is used for traffic channels and is rated as yellow for forward link multiplexing and green for reverse link multiplexing. GMSK is used in both directions and is rated as green.

Waveform	Duplexing	
	Forward Link Multiplexing	
	Reverse Link Multiplexing	
	Forward Link Modulation	
	Reverse Link Modulation	

5.3.5 TETRA Release 2 (TEDS)

TETRA is a 4-slot full-duplex TDMA/FDD system defined by ETSI as a secure public safety link for voice and data. TETRA Enhanced Data Service (TEDS) is a newer revision of TETRA, and it is normally referred to as just TETRA since it is an update rather than a separate standard. TEDS adds more modulation rates and multiple channel sizes to the TETRA standard. It is backwards compatible with TETRA Release 1. TEDS was developed to allow the existing TETRA Release 1 equipment already deployed to still be utilized by service providers.

TEDS base stations handle multiple frequency channels and each channel can handle up to four users using TDMA. The timing structure consists of a 61.2 second hyperframe. A hyperframe is made up of sixty 1.02 second multiframes. The multiframes contain eighteen 56.67 ms frames. A frame is broken down into four timeslots (providing access for up to four users) lasting 14.17 ms each. Reverse link slots can be divided in half to form a 7.08 ms subslot. This slot structure is shown in Figure 14. This TDMA structure is for both the forward and reverse link.

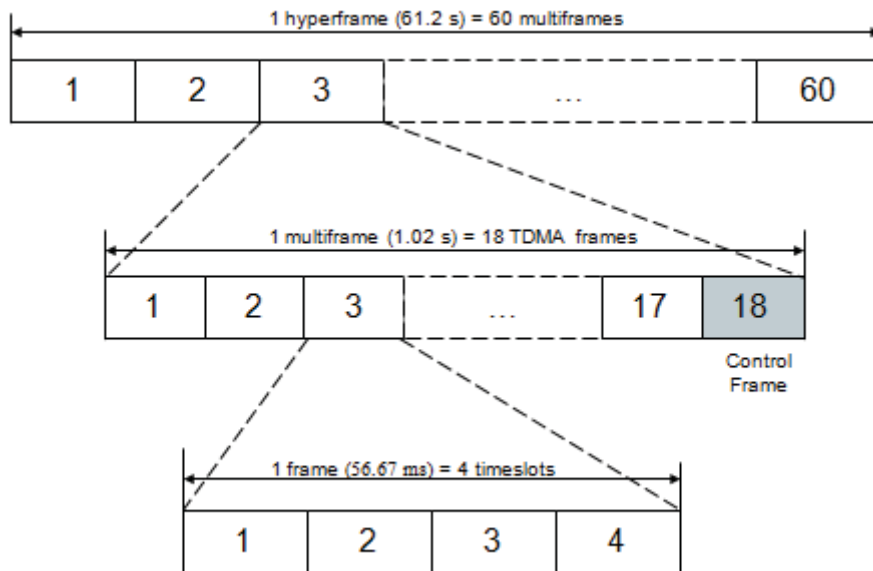

Figure 14. TEDS TDMA structure

5.3.5.1 Air/Ground Communications Criteria

TEDS has an average range of 5 km. Its popularity for public safety has prompted for an air-ground-air extension to increase the range to 85 km (46 NM). The extension was not meant for aeronautical certification but for public safety personnel on the ground and in the air to have voice and data connectivity. The phases of flight up to and including terminal receive a rating of green. En route is rated as yellow since further modifications should be able to extend the range to meet en route requirements.

Air/Ground Communications	Taxi / Surface	Green
	Takeoff / Landing / Terminal	Green
	En Route	Yellow

5.3.5.2 Data Transmission Criteria

TEDS uses 48 bit subscriber identity and is rated as green for addressing. TEDS uses a 4-slot TDMA structure. Since each slot is approximately 14 ms, the potential repetition rate is 70 Hz. The reverse link slots can be divided in half, doubling the repetition rate to 140 Hz in the reverse direction. It is rated as green for repetition rate. A data rate of greater than 500 kbps is achievable and it is rated as green for supporting C&C, ATS, and surveillance.

Data Transmission	Addressing	Green
	Repetition Rate	Green
	Command/Control	Green
	C&C and ATS	Green
	C&C, ATS, and Surveillance	Green

5.3.5.3 Mobility Criteria

TEDS does not support soft handoffs. It does support infrastructure assisted handoffs. The two base stations are able communicate to allocate a traffic channel in the new cell and direct the mobile station to it, instead of having the mobile station request it after it is in the new cell. The infrastructure assisted handoffs seem modifiable to support soft handoffs and is rated as yellow.

Dynamic power control is defined for the mobile station only. It supports an open and closed loop method. In open loop power control, the mobile station will adjust its own power based on such factors as received signal quality. When using closed loop, the base station transmits power control messages to direct the mobile station to make the appropriate adjustments. TEDS is rated as green for dynamic power control.

Modulation rates are chosen on a slot-by-slot basis. A "D8PSK channel" can send either $\pi/4$ -DQPSK bursts or $\pi/8$ -D8PSK bursts. The receiver determines the burst type by the training sequence that is sent at the beginning of a slot. A "QAM channel" can use 4, 16, or 64 modulation levels with varying coding rates. The modulation for QAM channels is determined by negotiating modulation rates. TEDS receives a rating of green for adaptive modulation rates.

TEDS mobile devices monitor the current channels on the serving cell. It can switch over to another channel if interference becomes an issue on the original channel. It is rated as green for QoS retuning.

Mobility	Handoff	Yellow
	Dynamic Power Control	Green
	Adaptive Modulation Rates	Green
	Active QoS Retuning	Green

5.3.5.4 Security Criteria

TEDS supports end-to-end encryption, as well as encryption over the air interface. For the air interface SCK, DCK, and CCK are used. It is rated as yellow for confidentiality. Integrity is achieved by the use of

authentication of the mobile subscriber using a 128 bit authentication key and the subscriber ID. It receives a rating of yellow for integrity. Availability is rated as green since it has sufficient features such as adaptive modulation, dynamic channel allocation, dynamic power control, and is a wideband system.

Security	Confidentiality	Yellow
	Integrity	Yellow
	Availability	Green

5.3.5.5 Traffic QoS Criteria

Each traffic channel provides access for up to four users. A mobile station will only be moved to a traffic channel that is able to handle the new connection. Thus, traffic distribution is inherent to TEDS and is rated as green. Eight levels of data priority are defined that determine slot allocation for traffic. It also provides an internal queue priority among traffic streams. TEDS is rated as green for traffic priority. TEDS defines three types of traffic classes. These consist of real-time, telemetry, and background. It can also apply a data importance level and delay class for packet data. It receives a rating of green for traffic priority.

The Logical Link Controller (LLC) provides for acknowledged and unacknowledged data. The receiving LLC will inform the sender as to which segments are missing or received incorrectly so that they can be retransmitted. TEDS is rated as green for traffic reliability.

TEDS allows for multiple bandwidth sizes: 25, 50, 100, and 150 kHz. Each channel can then be used by 1 – 4 users depending on data rate requirements. Given the flexibility to select channel size and amount of slots, it is receives a green rating for dynamic bandwidth allocation. TEDS devices monitor RF link statistics for determining power control and handoff decisions. It does not currently send these statistics, but could be modified to send them and is rated as yellow.

Traffic QoS	Cross-Carrier Distribution	Green
	Priority	Green
	Classes	Green
	Reliability/ARQ	Green
	Dynamic Bandwidth Allocation	Green
	RF Statistics Reporting	Yellow

5.3.5.6 Standardization and Certification Criteria

TEDS equipment is being manufactured and deployed for public safety networks. It is rated as green since it has a TRL level of 6. TEDS was designed as a secure and robust data link for public safety. Although extensions are defined to provide longer range use for aeronautical communications, it was neither designed nor tested to meet aeronautical standards. It is rated as yellow for certification risk.

No robustness issues could be determined for TEDS and is rated as green. Determinism and link layer compatibility are also rated as green.

Standardization and Certification	Technology Readiness Level	Green
	Certification Risk	Yellow
	Robustness	Green
	Determinism	Green
	Link Layer Compatibility	Green

5.3.5.7 Waveform Criteria

TEDS uses FDD for duplexing and is rated as green. Since it uses TDMA it is rated as green for forward link multiplexing and yellow for reverse link multiplexing. When using QAM, it will use multiple subcarriers, but since it can use single carrier DQPSK in both directions it is rated as yellow.

Waveform	Duplexing	Red
	Forward Link Multiplexing	Green
	Reverse Link Multiplexing	Yellow
	Forward Link Modulation	Yellow
	Reverse Link Modulation	Yellow

5.4 Custom Solutions Family

5.4.1 VDL Mode 4

VDL Mode 4 is a Self-organizing TDMA (STDMA) system designed for aeronautical communications. The TDMA structure uses a 60-second superframe that consists of 4500 slots with each slot 13.33 ms in length. Each radio in the system is synchronized to the Coordinated Universal Time (UTC) second primarily through GPS or Global Navigation Satellite System (GNSS). The system is self-organizing and reservation-based in that each user broadcasts its intent to use slots so that other stations may determine which slots will be utilized and which are free. Stations use this information to select and reserve slots using one of several reservation mechanisms. An example slot structure is shown in Figure 15.

VDL Mode 4 contains multiple reservation mechanisms. When no slots are reserved for use, a random access protocol is used. A periodic broadcast reservation allows a reservation to be placed for the same slot in future superframes. A unicast reservation allows for a slot to be reserved in the near future. An information transfer reservation reserves a set of slots for data along with a later slot for the acknowledgement. These and other reservation mechanisms give VDL Mode 4 flexibility in link access.

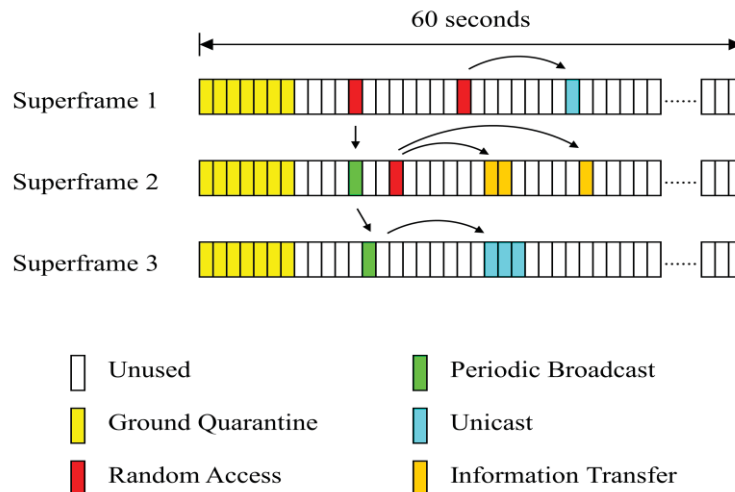

Figure 15. VDL Mode 4 slot example

At the data link layer VDL Mode 4 has two transfer procedures. For small messages (less than 3 slots by default), the message is directly transmitted using one of the reservation protocols or random access.

For larger messages, VDL Mode 4 implements a RTS/CTS mechanism. The RTS includes QoS information regarding the priority of the message and amount of time allowed for the transfer to occur. This allows the system to ensure preference for higher priority messages during busy periods.

5.4.1.1 Air/Ground Communications Criteria

The slot structure of VDL Mode 4 does not include any fixed guard times less than a slot length; therefore, there is not a maximum distance at which a guard time is valid. The standard does not specify any design distance, although it does (by default) set parameters for slot reuse distance of 150 NM. The similar technologies of VDL Modes 2 and 3 were designed for in excess of 100 NM ranges. Given that VDL Mode 4 was designed for aeronautical communications and that 83 NM ranges do not seem infeasible for this technology, the air/ground communications criteria are rated as green for all phases.

Air/Ground Communications	Taxi / Surface	
	Takeoff / Landing / Terminal	
	En Route	

5.4.1.2 Data Transmission Criteria

VDL Mode 4 was designed to support both broadcast and addressed applications therefore it meets the green conditions of the addressing criteria.

The 13.33ms slot duration of VDL Mode 4 would require access to 1 out of every 3.75 slots in order to meet the 20 HZ access rate. The RTS/CTS method of data transfer would require too much overhead to use, as the RTS, CTS, data, and acknowledgement would require a total of 4 slots. Using the short transfer procedure still requires 2 slots, one for the data and another for the acknowledgement which is achievable. However, none of the VDL Mode 4 reservation protocols are well suited for this high access rate. VDL Mode 4 could be modified, however, by a combination of defining a new slot reservation protocol and reducing slot durations. It is rated as yellow for the repetition rate criteria.

For data relay, VDL Mode 4 likely can support the traffic load as it was designed to be a general aeronautical data link. However, VDL Mode 4's lower data rate than Mode 2 and the RTS/CTS request and reservation mechanism will likely introduce extra delays in the pilot to controller path that cannot be dismissed. For this reason, it is anticipated that modifications will be necessary to achieve the intent of the data relay service and is rated as yellow.

VDL Mode 4 does not have a reservation mechanism designed for streaming traffic although a series of unicast reservations might allow this to work. The DLS layer does not have a voice service therefore voice traffic would be treated the same as regular data, and the frames should be small enough to use the direct transfer procedures. However, the data rate is insufficient to support anything but the basic command and control service. The data rate criterion for command and control is rated green while for C&C and ATS it is rated as yellow. VDL Mode 4 cannot support C&C, ATS, and video therefore it receives a red rating.

Data Transmission	Addressing	
	Repetition Rate	
	Command/Control	
	C&C and ATS	
	C&C, ATS, and Surveillance	

5.4.1.3 Mobility Criteria

The handoff mechanism in VDL Mode 4 is soft as long as the handoff is to another site on the same frequency. The aircraft is responsible for monitoring the signal quality of the current ground station as well as other ground stations and initiating a handoff when appropriate. VDL Mode 4 receives a green rating for the handoff criteria.

VDL Mode 4 does not implement dynamic power control but the feature can be added. It must be noted that the performance of the “robin hood” aspect of VDL Mode 4 where it reuses slots reserved by far away aircraft may be impacted by the addition of power control. Slot reusability is determined based on distance between the station that originally reserved the slots and the station attempting to reuse those slots. This criteria is rated as yellow since it seems feasible to modify VDL Mode 4 for this, with the caveat that it would need to be studied to ensure it does not have a negative performance impact.

VDL Mode 4 does not have adaptive modulation rates. Its self-organizing features require that each station receive the announced reservations of every other station. In order to accomplish this with AMR, either each receiver needs to be capable of simultaneously decoding multiple modulations and codings or some mechanism must be introduced to inform the modulation used for each transmission. Neither of these approaches seems viable without inversely affecting the complexity of the radios or fundamentally changing the design of VDL Mode 4. As such, VDL Mode 4 is rated red for AMR.

VDL Mode 4 supports some features to allow use of multiple frequencies and manage handoffs between frequencies. The mobile unit has frequency search and recovery features that can be used after a link failure. Proactively, it includes an autotune handoff feature that allows a ground station to command an aircraft to a different frequency. Although this can accomplish some of the load balancing and signal quality features desired, it would still require modification to support the intended goal of active QoS retuning, therefore this criteria is rated yellow.

Mobility	Handoff	
	Dynamic Power Control	
	Adaptive Modulation Rates	
	Active QoS Retuning	

5.4.1.4 Security Criteria

VDL Mode 4 does not support any cryptographic algorithms or hash functions at the radio. It instead would rely on higher layers to provide these functions; therefore, VDL Mode 4 rates as red for the confidentiality and integrity criteria. It does not include any techniques to combat interference and so also receives a red rating for the availability criteria.

Security	Confidentiality	
	Integrity	
	Availability	

5.4.1.5 Traffic QoS Criteria

VDL Mode 4 uses a combination of global and local channels to maintain traffic levels. The local channels are used to offload traffic as congestion occurs. This results in a green rating for the cross-carrier distribution. VDL Mode 4 also implements 15 levels of priority on the long transmission procedures, resulting in a rating of green.

VDL Mode 4 does implement different traffic classes, but it is mostly designed around different broadcast services such as ADS-B and Traffic Information Service – Broadcast (TIS-B). VDL Mode 4 will need some modifications to support the streaming traffic services with appropriate reservation protocols. It will also need modifications to support varying reliability/ARQ mechanisms for the different traffic classes, resulting in ratings of yellow for both the traffic classes and reliability criteria.

The STDMA nature of VDL Mode 4 with slot reservation inherently supports dynamic bandwidth allocation in that slots are reserved as needed resulting in a green rating.

VDL Mode 4 does not include any RF statistic reporting, but a feature could be added on easily as an application and using the VDL Mode 4 standard data transfer procedures. This criteria is rated as yellow.

Traffic QoS	Cross-Carrier Distribution	Green
	Priority	Green
	Classes	Yellow
	Reliability/ARQ	Yellow
	Dynamic Bandwidth Allocation	Green
	RF Statistics Reporting	Yellow

5.4.1.6 Standardization and Certification Criteria

The VDL Mode 4 standards were published by the International Civil Aviation Organization (ICAO) in 2004 as Doc 9816. VDL Mode 4 equipment has been produced, tested, and used putting the technology at a TRL level of 9 and rating the TRL criteria as green. VDL Mode 4 was also designed as an aeronautical communications system for a green rating for the certification risk criteria.

VDL Mode 4 receives a green rating for robustness and link layer compatibility but a red rating for determinism. The self-organizing nature of VDL Mode 4 that requires receiving all messages to develop an accurate slot usage map is susceptible to packet any packet loss. Collisions that can occur due to an imperfect slot usage map result in loss of additional information on slot usage and potentially future conflicts. VDL Mode 4 also uses CSMA when it must transmit and no reservations exist.

Standardization and Certification	TRL	Green
	Certification Risk	Green
	Robustness	Green
	Determinism	Red
	Link Layer Compatibility	Green

5.4.1.7 Waveform Criteria

The TDMA access scheme used in VDL Mode 4 can be considered TDD duplexing between the forward and reverse links since both utilize the same channel at different times. This results in green rating for duplexing and forward link multiplexing options, but a yellow for the reverse link multiplexing. The GFSK modulation is a single carrier constant envelope. The modulation criteria are both rated as green.

Waveform	Duplexing	Green
	Uplink Multiplexing	Green
	Downlink Multiplexing	Yellow
	Uplink Modulation	Green
	Downlink Modulation	Green

5.4.2 L-DACS 1

The L-Band Digital Aeronautical Communications System Type 1 (L-DACS 1) is one of two proposed communications links for aeronautical use in the L band. L-DACS 1 is based mainly upon the Broadband Aeronautical Multicarrier Communications (B-AMC) system with additional considerations for items from other technologies such as IEEE 802.16, UAT, VDL Mode 3, and P-34. The assessment of this technology is based upon the proposed system specification¹⁵.

L-DACS 1 is designed as a FDD system. Time is divided into 240 ms superframes as shown in Figure 16. The beginning of each superframe begins with a broadcast (BC) segment in the forward link and a random access (RA) segment in the reverse link. The RA is used only for performing cell entry. After the BC/RA segment, each superframe contains four multi-frames. In the forward link, a multiframe is divided into 9 frames. The first 4 of these frames are used exclusively for data. The fifth frame is used for common control (CC); additional frames may be used for CC depending on the amount of CC to send. The remaining frames are used for data.

In the reverse link, a multiframe is divided into tiles instead of frames. Each tile is 0.72 ms in length and utilizes half of the carriers in the OFDMA waveform, allowing for two simultaneous tiles in each timeslot. The collection of tiles is divided into a dedicated control (DC) segment and a data segment. The DC segment provides dedicated access to the users for control messages such as resource requests. The length of the DC segment is variable and based on the number of users in the system. The remaining portion of the multiframe is used for data.

¹⁵ "L-DACS1 System Definition Proposal: Deliverable D2", Eurocontrol, February 2009

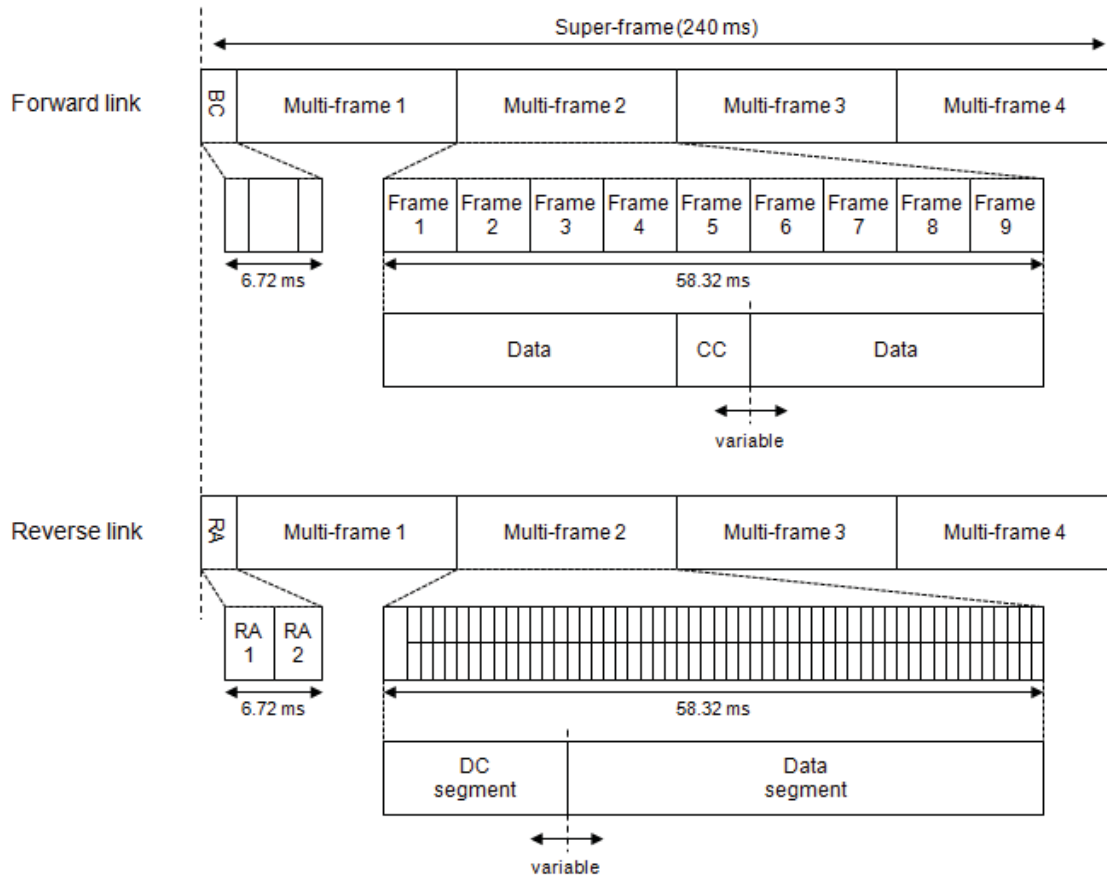

Figure 16. L-DACS 1 frame structure

5.4.2.1 Air/Ground Communications Criteria

L-DACS 1 was designed as an aeronautical air/ground system with a maximum cell range of 200 NM, which is more than required for the UAS CNPC. It rates as green for all domains.

Air/Ground Communications	Taxi / Surface	
	Takeoff / Landing / Terminal	
	En Route	

5.4.2.2 Data Transmission Criteria

L-DACS 1 supports unicast and broadcast communications; therefore, the addressing criteria is rated green. It uses up to 133 uplink data transmit opportunities and 1316 downlink opportunities per second, but requests are limited to a rate of 16.67 Hz (one request per 60 ms). A single request may reserve multiple resources but it cannot guarantee the spacing, and no method is available to signify an arbitrary repetition rate. Therefore, the repetition rate criteria is rated as yellow. L-DACS 1 supports voice through the AMBE-ATC-10B vocoder at a rate of 4.8 kbps, with samples transmitted every 60 ms. L-DACS 1 has data rates of 220.3 – 1038.4 kbps, depending on the modulation and coding used. These data rates are sufficient to support the combined command and control, ATS relay, and surveillance product, thus yielding a green rating for these criteria.

Data Transmission	Addressing	Green
	Repetition Rate	Yellow
	Command/Control	Green
	C&C and ATS	Green
	C&C, ATS, and Surveillance	Green

5.4.2.3 Mobility Criteria

L-DACS 1 has features to enable a mobile to scan adjacent cells and report the power to the ground. All handoffs are ground controlled and may be done in a coordinated or uncoordinated mode between ground stations. The coordinated method meets the green rating for the handoff criteria. L-DACS 1 also has both open and closed loop power control features for the downlink, and adaptive modulation and coding for the uplink and downlink data channels. Since the handoffs are ground controlled, there is no mechanism in L-DACS 1 for the mobiles to retune if it encounters interference. The feature could be enabled by adding uplink messages with adjacent ground station and channel information, as well as an aircraft initiated handoff; therefore, this criteria is yellow.

Mobility	Handoff	Green
	Dynamic Power Control	Green
	Adaptive Modulation Rates	Green
	Active QoS Retuning	Yellow

5.4.2.4 Security Criteria

The L-DACS 1 specification does not specify encryption or integrity algorithms; therefore, it rates as red for confidentiality and integrity. It supports dynamic power control, dynamic channel allocation, and OFDM as methods to combat interference yielding a green rating for the availability criteria.

Security	Confidentiality	Red
	Integrity	Red
	Availability	Green

5.4.2.5 Traffic QoS Criteria

The ground based handoff mechanisms used by L-DACS 1 are sufficient to support cross-carrier distribution. This criteria is rated as green. L-DACS 1 supports 8 levels of priority. It does not explicitly support traffic classes, with the exception of one specific priority level which is intended for voice traffic. Modifications would likely be needed to support the various data requirements for weather and video traffic. L-DACS 1 rates green for priority and yellow for traffic classes. L-DACS 1 supports both an acknowledged and unacknowledged transfer modes that are selectable per transfer. The reliability criteria is evaluated as green.

L-DACS 1 is, by design, a demand-assigned data link. The OFDMA mechanism provides bandwidth resources to users on a request basis, which meets the requirements for a green rating for dynamic bandwidth allocation. It does not contain RF statistics reporting, with the exception of power reporting, which is used for power control and handoffs. The RF statistics criteria is rated as yellow.

Traffic QoS	Cross-Carrier Distribution	Green
	Priority	Green
	Classes	Yellow
	Reliability/ARQ	Green
	Dynamic Bandwidth Allocation	Green
	RF Statistics Reporting	Yellow

5.4.2.6 Standardization and Certification Criteria

L-DACS is still in the development and testing phases. Some subsystems of L-DACS 1 have been built and tested, but a fully function radio has not yet been demonstrated in an airborne environment. For this reason, L-DACS 1 is rated as yellow for the TRL criteria. L-DACS 1 is designed for aeronautical use for ATS and therefore rates green for the certification risk criteria.

L-DACS 1 is rated red for robustness and link layer compatibility due to its use of OFDM. Determinism is rated green.

Standardization and Certification	TRL	Yellow
	Certification Risk	Green
	Robustness	Red
	Determinism	Green
	Link Layer Compatibility	Red

5.4.2.7 Waveform Criteria

L-DACS 1 only supports FDD duplexing. It uses a TDMA mechanism for the forward link multiplexing and OFDMA for reverse link multiplexing. The forward and reverse link modulations are OFDM. With the exception of the multiplexing criteria which is rated green, all the waveform criteria are evaluated as red for being the least desirable options based on the criteria.

Waveform	Duplexing	Red
	Forward Link Multiplexing	Green
	Reverse Link Multiplexing	Green
	Forward Link Modulation	Red
	Reverse Link Modulation	Red

5.4.3 *L-DACS 2*

L-DACS 2 is the second of two proposed communications links for aeronautical use in the L band. This system is based heavily on the proposed AMACS technology along with the physical layer from GSM and UAT adapted to the L-band. The assessment of this technology is based mainly upon the proposed system specification¹⁶. In places where the L-DACS 2 specification was found to be incomplete or unclear, the AMACS description document¹⁷ is referenced.

L-DACS 2 uses the modified version of the basic AMACS frame structure. Each frame is divided into 5 sections: two forward link sections (UP1 and UP2), two reserve link Class of Service (CoS) sections (CoS1 and CoS2), and a log on section (LoG2). The specification declares that the beginning of each frame is

¹⁶ L-DACS2 System Definition Proposal: Deliverable D2, Eurocontrol, 2009

¹⁷ Future Communications Infrastructure – Technology Investigations Description of AMACS, Eurocontrol, 2007

aligned with a UTC second. A framing message transmitted in the beginning of UP1 can be used to adjust the length of each of these sections within a frame.

The UP1 and UP2 sections are used by the ground to transmit data, acknowledgements, or reservation grants to aircraft. In the CoS1 section, each aircraft has dedicated timeslots allocated to request slots for data or send acknowledgements. Slots are granted for data in the CoS2 section. Unused slots in the CoS2 section are available for use via random access.

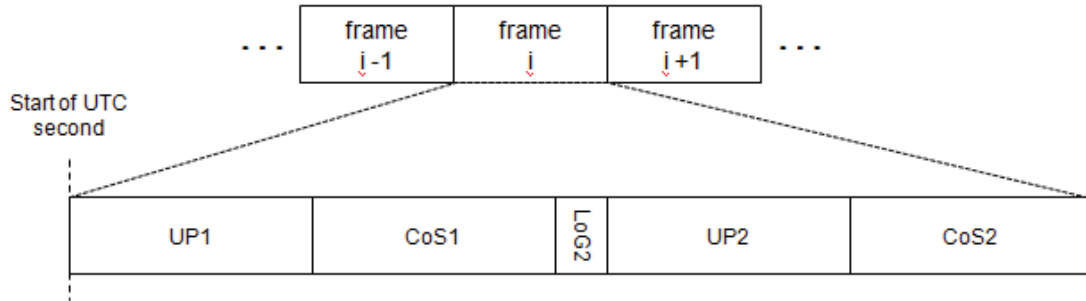

Figure 17. L-DACS 2 Frame Structure

5.4.3.1 Air/Ground Communications Criteria

L-DACS 2 is designed for aeronautical use and thus long range communications. The specification states that guard times are based on a range of 200 NM between the aircraft and ground station. This rates L-DACS 2 as green for all the air/ground criteria.

Air/Ground Communications	Taxi / Surface	Green
	Takeoff / Landing / Terminal	Green
	En Route	Green

5.4.3.2 Data Transmission Criteria

L-DACS 2 supports addressed air/ground messaging with a local address assigned to the aircraft upon log on. The local address is used for all message exchanges from that point. The addressing criterion is rated as green.

The repetition rate of L-DACS 2 is limited. The 1 second frame length combined with the division between the forward and reverse link sections creates a situation where access to the channel is restricted, thus data messages would need to be queued until an appropriate section. The length of the frame would need to be greatly reduced, by more than an order of magnitude, to enable consistently spaced 20 Hz access rates. For this reason L-DACS 2 receives a red rating for repetition rate.

The raw data rate of L-DACS 2 is 270.833 kbps. This easily supports the command and control and ATS relay traffic, but is not sufficient for the inclusion of surveillance traffic.

Data Transmission	Addressing	Green
	Repetition Rate	Red
	Command/Control	Green
	C&C and ATS	Green
	C&C, ATS, and Surveillance	Yellow

5.4.3.3 Mobility Criteria

L-DACS 2 is designed with soft handoff mechanisms and receives a green rating for the handoff criteria. It supports closed loop dynamic power control on the aircraft side, but uses a fixed modulation and coding. The aircraft does passive scanning of nearby ground stations on other frequencies and performs a handoff as appropriate, qualifying for a green rating for the active QoS retuning.

Mobility	Handoff	Green
	Dynamic Power Control	Green
	Adaptive Modulation Rates	Yellow
	Active QoS Retuning	Green

5.4.3.4 Security Criteria

Like L-DACS 1, L-DACS 2 does not mention any encryption or hashing algorithms in the specification and receives a red rating for confidentiality and integrity. It supports dynamic power control and frequency allocation for a rating of yellow for availability.

Security	Confidentiality	Red
	Integrity	Red
	Availability	Yellow

5.4.3.5 Traffic QoS Criteria

The L-DACS 2 specification does not specifically mention cross-carrier distribution. However, it does include methods for a ground station to request an aircraft to handoff. If the request includes a retune, this mechanism could be used to implement this feature. Since some modification likely would be needed on the ground side, the criteria is rated as yellow.

The specification for L-DACS 2 indicates the use of priority in the range of 0-3; however, in the messages the priority field is specified in the range of 0-14. Although the specification has some conflict on priority, it is included and receives a green rating.

L-DACS 2 does not support traffic classes or selectable reliability and receives a yellow rating for these two criteria. The original AMACS specification did include guaranteed and best effort traffic classes, but these seem to have been removed in L-DACS 2 as the use of the CoS1 and CoS2 reverse link sections have been changed, although parts of the documentation still have references to the these two traffic classes.

The TDMA nature of L-DACS 2 inherently supports dynamic bandwidth allocation yielding a green rating for this criteria. No mention of any RF statistics reporting could be found in the specification.

Traffic QoS	Cross-Carrier Distribution	Yellow
	Priority	Green
	Classes	Yellow
	Reliability/ARQ	Yellow
	Dynamic Bandwidth Allocation	Green
	RF Statistics Reporting	Yellow

5.4.3.6 Standardization and Certification Criteria

L-DACS 2 is not a commercially available system. Like L-DACS 1, this technology is still in the development phase. It is rated as yellow for the TRL. It is designed as an aeronautical link yielding a green rating for certification risk.

No issues were identified for L-DACS 2 in the area of robustness, determinism, or link layer compatibility therefore these criteria are rated green.

Standardization and Certification	Technology Readiness Level	Yellow
	Certification Risk	Green
	Robustness	Green
	Determinism	Green
	Link Layer Compatibility	Green

5.4.3.7 Waveform Criteria

L-DACS 2 is a TDD system with TDMA multiplexing for the forward and reverse link. This yields a green rating for the duplexing and forward link multiplexing criteria, but a yellow rating for the reverse link multiplexing. It uses GMSK for both the forward and reverse link modulation yielding a green rating for these criteria.

Waveform	Duplexing	Green
	Forward Link Multiplexing	Green
	Reverse Link Multiplexing	Yellow
	Forward Link Modulation	Green
	Reverse Link Modulation	Green

5.4.4 *STANAG 4660*

Standardization Agreement (STANAG) 4660 is a North Atlantic Treaty Organization (NATO) specification for an Interoperable Command and Control Data Link (IC2DL) for UAS. The standard has not yet been ratified. For the purposes of this assessment, a draft of the standard version 0.6 from October 2006 was used.

The TDMA structure is constructed of 10 ms slots, with 20 slots forming a 200 ms frame. Five frames form a 1 second epoch. The standard defines three types of nodes: slave, master, and relay. Only one master node can be present in a network. It is responsible for transmitting timing information to other nodes. A relay node (normally another UA) will relay messages between the master node and the slave nodes. The slave node is any other node in the network. This layout is depicted in Figure 18.

The network is able to support up to 16 circuits. Slots are assigned based on a circuit allocation table. Circuits are then mapped to the timeslot allocation table which defines when circuits are used. This is also shown in Figure 18.

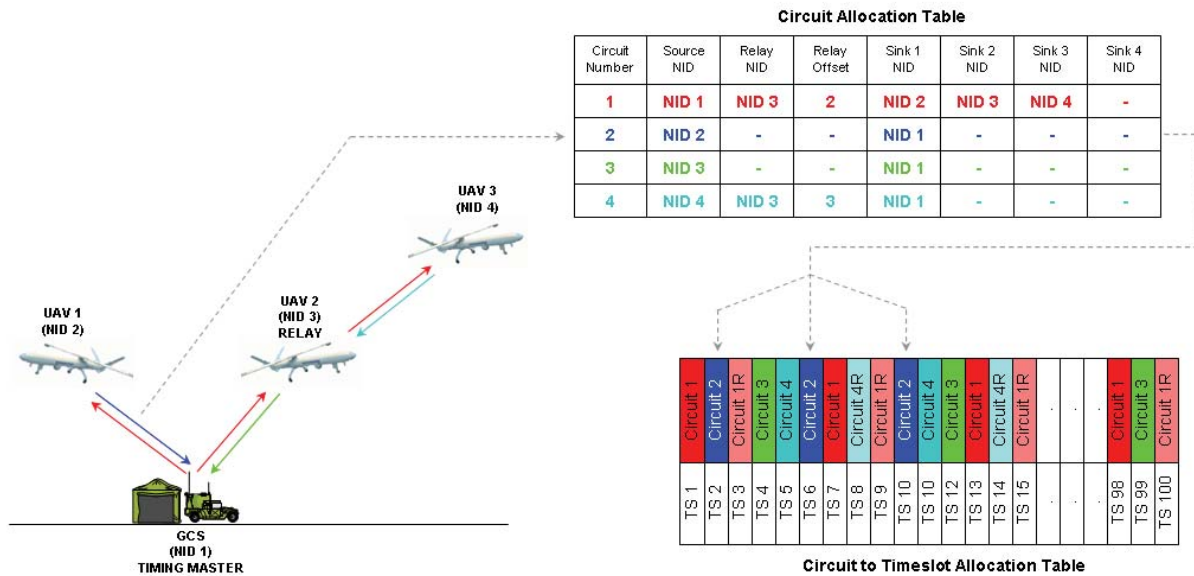

Figure 18. STANAG 4660 circuit implementation

5.4.4.1 Air/Ground Communications Criteria

The STANAG 4660 specification states it will meet a performance requirement of 100 NM range of operation. Assuming that further development of this standard adheres to this requirement, it is rated as green for all phases of flight.

Air/Ground Communications	Taxi / Surface	
	Takeoff / Landing / Terminal	
	En Route	

5.4.4.2 Data Transmission Criteria

STANAG 4660 uses IP address along with User Datagram Protocol (UDP) ports as a means of addressing. However, the full IP/UDP header is not sent over the air interface. Each unique IP/UDP port pair is translated into a single address that is then sent over the air interface. This allows reduced overhead and maintains the IP/UDP streams. It is rated as green for addressing.

Performance requirements state that it will support a 20 – 25 Hz repetition rate. However, this is postulated for launch and recovery only. It is rated as green for repetition rate.

Channels are 25 kHz and provide a rate of 1.976 kbps. Multiple channels are combined to increase the data rate or to provide redundancy. Data rates range from 3.9 kbps (2 channels) up to 1.5 Mbps (800 channels). Performance requirements also state it will have a 250 ms end-to-end delay for voice. It is rated as green for providing C&C, ATS, and surveillance.

Data Transmission	Addressing	Green
	Repetition Rate	Green
	Command/Control	Green
	C&C and ATS	Green
	C&C, ATS, and Surveillance	Green

5.4.4.3 Mobility Criteria

The standard does not specifically define handoff procedures. Since it is a CDMA based technology it should be modifiable to support soft handoffs and is evaluated as yellow. Messages are defined to indicate support for setting the transmit power as high or low. However, the current draft does not specify enough information to meet the intent of this criteria, and is rated as yellow.

STANAG 4660 uses QPSK for its modulation. Due to the lack of specifications, it is unclear if it is possible to use other modulations without adversely affecting the physical layer performance. It is rated as red for adaptive modulation rates. The spread spectrum is used in 20 MHz allotments, and no additional spectrum is seen from the current draft specification. The PN codes seem to be constantly shifting but there is no input from interference used in this process. It is rated as yellow for active QoS retuning.

Mobility	Handoff	Yellow
	Dynamic Power Control	Yellow
	Adaptive Modulation Rates	Red
	Active QoS Retuning	Yellow

5.4.4.4 Security Criteria

Both confidentiality and integrity are external to the STANAG 4660 specification and are left to the upper layers to handle, providing a rating of red for confidentiality and integrity. Availability is rated as yellow since it is a Low-Probability-of-Intercept/Low-Probability-of-Detection (LPI/LPD) data link and uses spread spectrum.

Security	Confidentiality	Red
	Integrity	Red
	Availability	Yellow

5.4.4.5 Traffic QoS Criteria

Cross-carrier distribution is dependent on the setup and division of the 200 MHz into channels. If all 200 MHz are allocated as one block, no other carriers are able to use it. It may be possible if it is using more of CDMA like allocation, and is rated as yellow. No traffic priority is specified in the draft standard and is rated as yellow. Three traffic classes are defined (control/status, digital voice, and application data), but does not seem to treat traffic differently based on class. It is rated as yellow for traffic classes. Messages are UDP based and any retransmissions rely on the application layer to handle this, providing a rating of yellow for reliability. The number of 25 kHz channels is selectable providing varying data rates. However, it is unknown if this is dynamic during flight or is preset and is rated as yellow for dynamic bandwidth allocation. Basic RF statistics are reported locally but are not transmitted over the link, thus it is evaluated as yellow for RF statistics reporting.

Traffic QoS	Cross-Carrier Distribution	Yellow
	Priority	Yellow
	Classes	Yellow
	Reliability/ARQ	Yellow
	Dynamic Bandwidth Allocation	Yellow
	RF Statistics Reporting	Yellow

5.4.4.6 Standardization and Certification Criteria

STANAG 4660 is an incomplete draft at this point. It is rated as red for technology readiness. It is being designed as an aeronautical standard for UAS and is rated as green for certification risk.

Since it is based on CDMA, robustness and link layer compatibility is rated as red. Determinism is rated as yellow since CDMA can lead to interference issues.

Standardization and Certification	Technology Readiness Level	Red
	Certification Risk	Green
	Robustness	Red
	Determinism	Yellow
	Link Layer Compatibility	Red

5.4.4.7 Waveform Criteria

Duplexing is rated as green since it uses TDD. Multiplexing in both directions is rated as red since TDMA/CDMA are used. Both directions of modulation are also rated as red since it uses multichannel carrier QPSK.

Waveform	Duplexing	Green
	Forward Link Multiplexing	Red
	Reverse Link Multiplexing	Red
	Forward Link Modulation	Red
	Reverse Link Modulation	Red

5.5 Evaluation Summary

The rating for all technologies and criteria is shown in Figure 19.

Category	Criteria	TDMA IS-136	GSM	GPRS	EDGE	WCDMA	TD-CDMA	TD-SCDMA	CDMA 2000 1x RTT-3XRTT	EV-DO	CDMA 2000 1x EVDV (3GPP2)	LTE	DECT	802.11	802.16	802.20	P-25	P-34	IDRA	TETRAPOL	TEDS	VDL4	L-DACS 1	L-DACS 2	STANAG 4660		
Air/ground comm	Taxi / Surface / Preflight / Postflight																										
	Takeoff / Landing / Terminal																										
	En Route																										
Data Transmission	Addressed capability																										
	Repetition rate																										
	Command/Control (C&C) C&C + ATC																										
Mobility	C&C + ATC + Surveillance																										
	Handoff																										
	Dynamic power control																										
Security	Adaptive modulation rates																										
	Active QoS returning																										
	Confidentiality																										
Traffic QoS	Integrity																										
	Availability																										
	Traffic cross-carrier distribution																										
Certification / complexity	Traffic priority																										
	Traffic classes																										
	Traffic reliability/ARQ																										
Waveform	Dynamic bandwidth allocation																										
	RF statistics reporting																										
	TRL																										
Waveform	Certification risk																										
	Robustness																										
	Determinism																										
Waveform	Link layer compatibility																										
	Duplexing																										
	Forward Link multiplexing																										
Waveform	Reverse Link multiplexing																										
	Forward Link modulation																										
	Reverse Link modulation																										

Figure 19. Technology criteria ratings

6 Technology Comparisons and Downselection

With all of the technologies rated against the criteria, the technologies can be scored and compared against each other. The technology scoring begins with the assignment of a numerical value to the color rating scale. For the analysis, the scale chosen utilizes a value of 0 for red, 1 for yellow, and 2 for green. Each criterion is assigned a weight as a method of prioritizing its importance. Several weighting scenarios were developed as a means of sensitivity analysis.

For a technology, the numerical value of its rating for a criterion is multiplied by the criterion's weighting. The sum of all the criteria ratings multiplied by the respective weights results in a technology's score for that scenario. To allow comparison with other weighting scenarios, the technology score is normalized such that a technology with green values for all criteria receives a score of 100.

An example of the scoring is shown in Figure 20. Five criteria are defined with respective weights of 1, 0, 2, and 2. The technology ratings for the criteria is green, yellow, red, and green with the resultant values of 2 for criteria 1, 1 for criteria 2, 0 for criteria 3, and 2 for criteria 4. To arrive at the technology score, each of the weights is multiplied by the respective rating value and summed together for a raw score of 6. A perfect score is calculated by multiplying the weights by the green rating value of 2 and summed together for a value of 10 in this example. The normalized score for this example is the technology's raw score divided by the perfect score, or 60%. Note that with this weighting method, any criteria with a weight of 0 effectively has no effect on the normalized score.

Criteria	Weight	Technology Rating	Technology Score	Perfect Score
Criteria 1	1	2	$2 \times 1 = 2$	$2 \times 1 = 2$
Criteria 2	0	1	$1 \times 0 = 0$	$2 \times 0 = 0$
Criteria 3	2	0	$0 \times 2 = 0$	$2 \times 2 = 4$
Criteria 4	2	2	$2 \times 2 = 4$	$2 \times 2 = 4$
Score			$2+0+0+4 = 6$	$2+0+4+4 = 10$
Normalized Score			$6/10 = 60\%$	$10/10 = 100\%$

Figure 20. Example weighting scenario

Several simple weighting cases were created to examine each technology against the criteria categories of data transmission capabilities, mobility, QoS, certification, and the waveform properties. For these scenarios, each criterion in the relevant category is given a weight of 1, while all other criteria have a weight of 0. The results from these scenarios are shown in Figure 21.

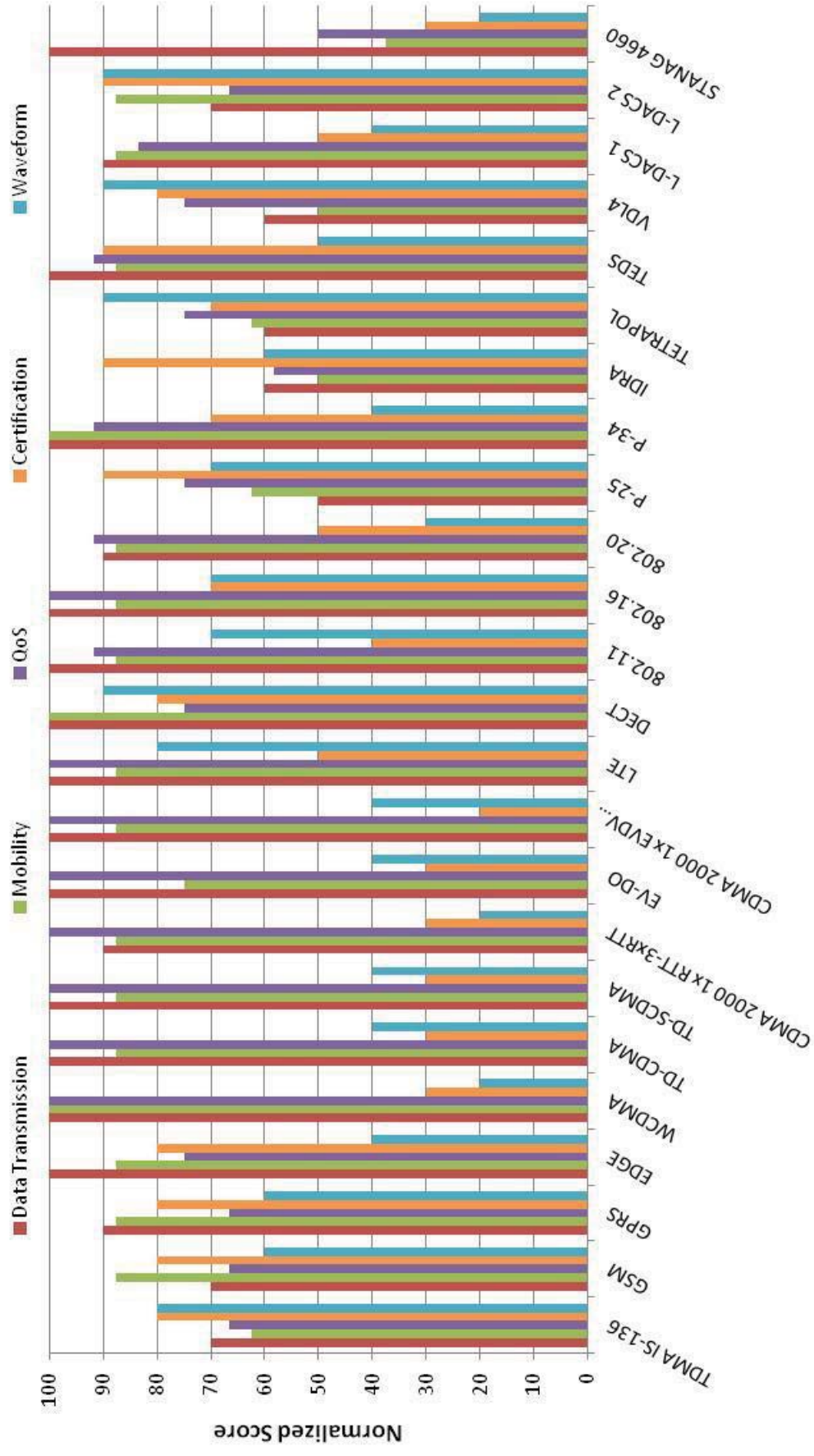

Figure 21. Scenario results for the basic categories

The graph indicates that no technology scores perfectly in all of the major categories. There will be some tradeoff in capabilities in the selected technology. For example, the UMTS and CDMA2000 technologies performed very well from the data transmission, mobility, and QoS standpoints, but did not fare well in the certification and waveform categories. On the other hand, TDMA IS-136, TETRAPOL, VDL Mode 4, and L-DACS 2 did well from the waveform perspective but not as well in the other categories.

Two more basic weighting cases were created and shown in Figure 22. The first case weights all criteria the same as an overall evaluation of the technology. The second case weights each category the same, with each criteria in the category equally weighted. In this way, the sum of the criteria weights in each category equals 1. The two cases result in similar scores for the technologies. From this case, some technologies start to exhibit signs of rating above the others, such as LTE and 802.16, and to a lesser extent, P-34 and TEDS.

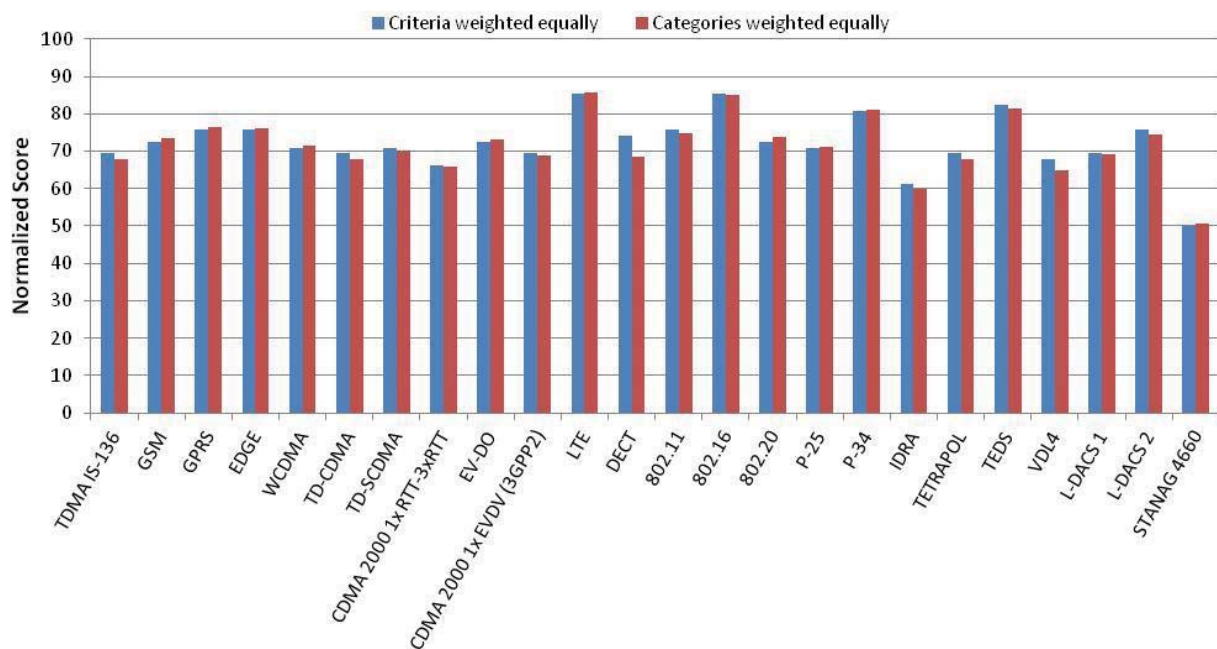

Figure 22. Scenario results for all criteria with equal weighting

In addition to the above simple cases, four different weighting scenarios were developed with inputs from subject matter experts. These scenarios were developed from different perspectives.

SME 1 Weighting Scenario

The first weighting scenario focuses on a few key criteria and allows others to not be considered. This scenario utilizes a weighting scale of 0 to 3. It weighs heavily on en route distances, the repetition rate and command/control with ATS relay data as these are deemed necessary and the most stringent capabilities required in both the L and C band links. Equally weighted are handoff, availability, robustness, determinism, and the duplexing option since it is felt that mapping the higher layers to the proposed TDD system will be easiest when starting with a TDD system.

SME 2 Weighting Scenario

This scenario is utilizes a weighting scale of 0 to 5, although the lowest assigned value utilized is 2. This scenario considers all criteria important. The most important criteria are the surface, handoff

capabilities, availability, and certification risk. The next most important are adaptive features such as power, modulation rates, and bandwidth, along with security, complexity, and the waveform compatibility. The lowest rated criteria involve the data traffic capabilities and QoS under the assumption that modifications could be made to get the required performance.

SME 3 Weighting Scenario

Weighting scenario 3 utilizes a scale of 0 to 5, but as with scenario 2 considers all criteria important such that none receive a score of 0. The most important criteria are surface and terminal communications, meeting the repetition rate of the data, TRL, and link robustness and determinism. Mid-scores are applied to the data traffic and QoS capabilities, security, and waveform compatibility.

SME 4 Weighting Scenario

Weighting scenario 3 utilizes a scale of 0 to 5 and, as with the prior scales, considers all criteria important. This scale considers mobility and QoS features to be very important and focuses on the most stringent cases for data rate requirements and distances. Technology TRL is also considered high, although the certification and complexity criteria and weighted less. In terms of waveform compatibility, the duplexing option is identified as most important, followed by the multiplexing at a lesser weight and the modulation with the least weight.

The weights used for each of the scenarios are shown in Figure 23.

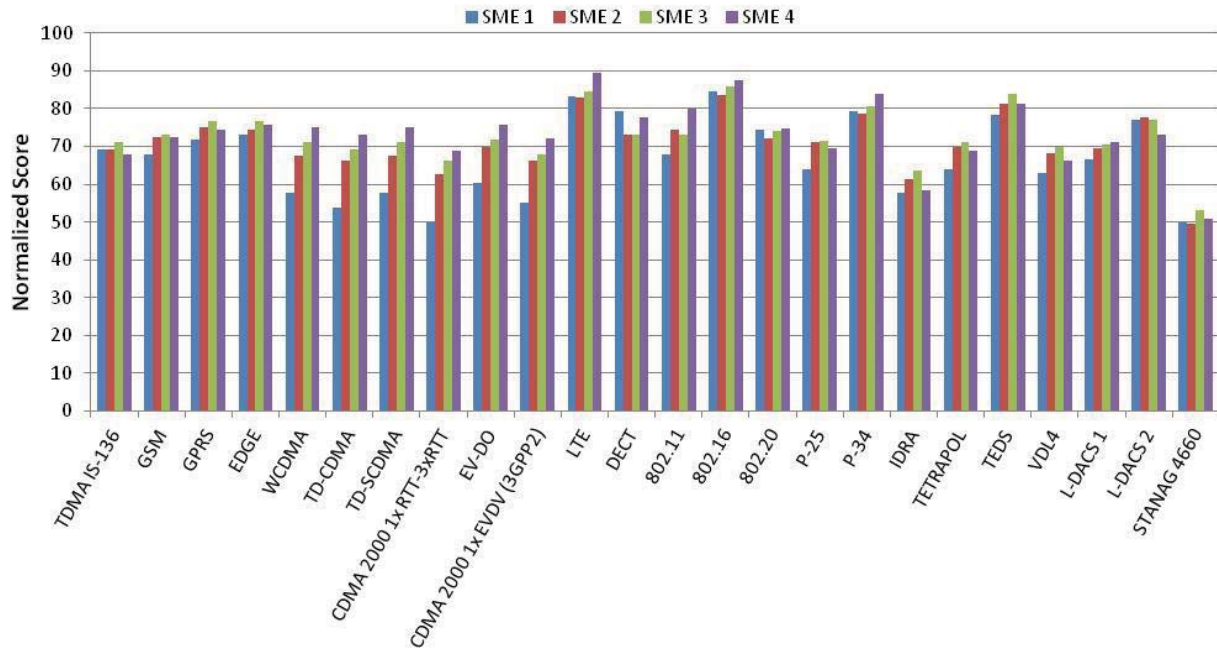

Figure 24. SME scenario results

From the weighted scenarios, LTE and 802.16 received similar overall ratings and were better than all the other technologies in each scenario. These were also the only technologies to score better than 80% in all scenarios. Referencing the basic categories scores in Figure 21, 802.16 and LTE both received perfect scores for the data transmission and QoS criteria and high scores for mobility. The drawbacks of these technologies lie mainly in the waveform and certification criteria. Overall these technologies rank the highest and are the forerunners for selection as CNPC.

P-34 and TEDS rank the next highest in these scenarios with scores around 80%. Both technologies received a perfect score for the data transmission criteria. P-34 additionally had a perfect score for the mobility criteria. TEDS on the other hand rated very well for the certification criteria, scoring as well as any other technology and better than most in this category. The weakness of these technologies is in the waveform criteria, with P-34 and TEDS rating 40% and 50% respectively. Overall, these technologies rank second-highest for consideration as CNPC.

7 Potential CNPC Systems

The previous sections of the document have focused on identifying potential technologies and the methods used to narrow the candidates to the few that best represented solutions for the CNPC link. This section examines, at a high level, the potential CNPC systems based on the best identified technologies from Section 6. This exercise serves several purposes:

1. To verify that modification to the proposed physical waveform appears viable.
2. To identify portions of technology that are required for CNPC and those that are not needed.
3. To identify early-on any foreseen modifications required.
4. Based on the above, identifying the best, recommended technology from the short list.

The section references the proposed physical layer waveform shown in Figure 25. The proposed system is TDD with TDMA uplink and FDMA downlink.

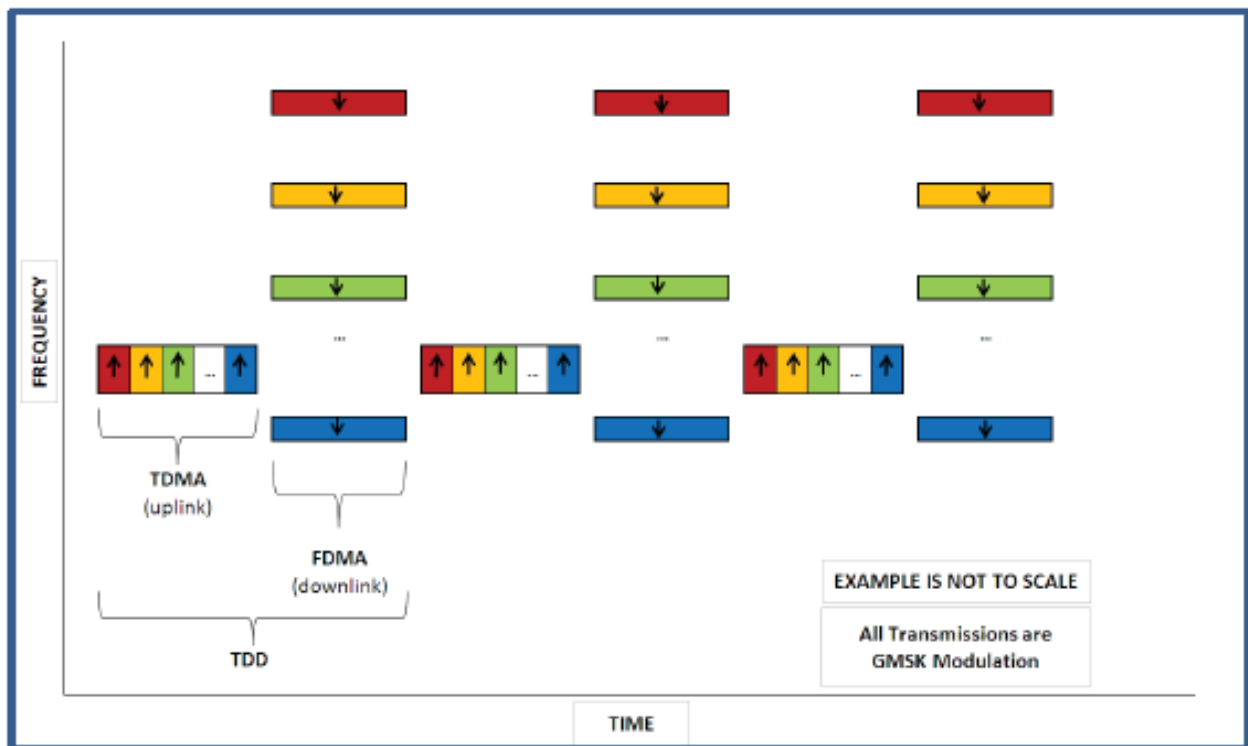

Figure 25. Proposed CNPC format¹⁸

7.1 LTE-based CNPC

LTE Release 8, which is the base LTE standard, will be evaluated as a leading technology candidate to merge with the layer 1 and 2 areas Rockwell is developing for the NASA UAS CNPC Radio Prototype Development Project. As mentioned earlier in this document, the LTE standard supports both FDD and TDD modes within a single radio access technology. Efficient multicast/broadcast functionality is included in the standard, which makes it possible to use a single frequency network (SFN) concept as an option that is available in OFDM. Single-carrier FDD would be used in the reverse link which would

¹⁸ NASA Unmanned Aircraft Control and Non-Payload Communication System Waveform Trade Studies, Rockwell Collins, March 2012

achieve the low Peak-to-Average Power Ratio (PAPR) and user orthogonality in the frequency domain. Figure 26 shows the time-frequency structures for FDD and TDD. The TDD Forward Link would be the ground station transmit, whereas the FDD Reverse Link represents the UA transmit. In the CNPC link, the overall TDD frame will also need to accommodate FDD transmissions and will need to have a static configuration to avoid interference between other UA and ground stations. However, it can be changed on a very slow basis to suit traffic demand, but would add complexity and must be done very carefully.

7.1.1 Frame Configuration

As in any complete FDD or TDD LTE configuration, a combined TDD and FDD LTE, the ground station and the UA would need to switch from transmit to receive and vice versa. In the TDD LTE standard, the switch occurs in a special subframe, which is split into three parts: Forward Link (Downlink Pilot Time Slot), a guard period and Reverse Link (Uplink pilot Time Slot). Subframes immediately following a special subframe in a 10 ms frame are always reserved for the uplink transmission.

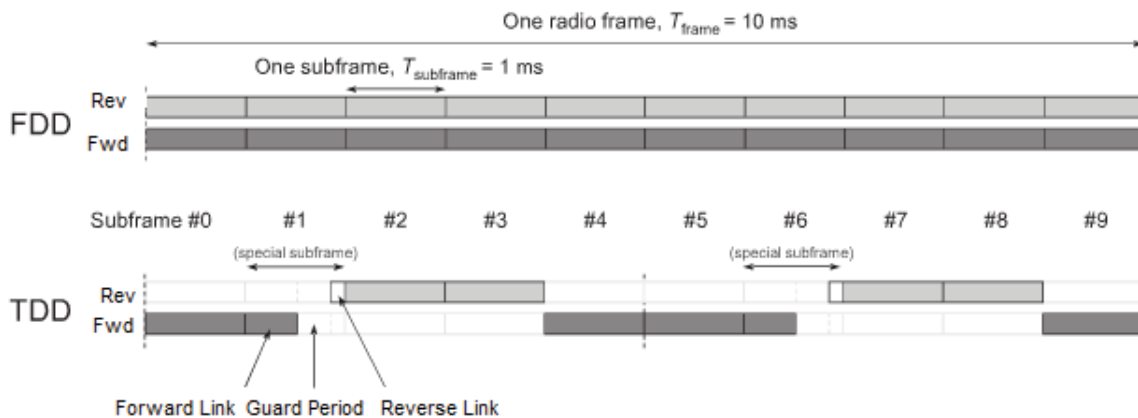

Figure 26. LTE FDD and TDD frame configuration

In a CNPC configuration, a guard band will also be required to allow for the transition. The duration of the guard will depend on the propagation delays (timing advance) and the hardware switching time, which is relatively fast, on the order of 20 μ s. Figure 27 depicts what a CNPC LTE Hybrid TDD-FDD 10 ms frame might look like with a transmit/receive switch periodicity of 5ms. Figure 28 depicts a periodicity of 10 ms. The special sub-frames on the GCS transmit (LTE-TDD) would be in the green areas and would also contain guard time, except for the seventh subframe in the 10 ms switch periodicity, which would only be a downlink pilot time slot. The Reverse Link timing of each UA can be controlled by the GCS by using the timing-advance mechanism. The location of the synchronization signal for FDD is located at the middle of subframe 0 and subframe 5, regardless of the periodicity. In a 10 ms switch periodicity frame, the second subframe is always a special subframe. In a 5 ms switch periodicity frame, the second and seventh subframes are special subframes.

The synchronization signal for FDD in the reverse link would have to be contained in the traditional downlink path to comply with the LTE spec, otherwise non-conventional configurations would have to be applied. Note that there are six possible forward/reverse link configurations possible of which two are used as examples in Figure 27 and Figure 28. LTE-TDD maximum absolute deviation in frame start timing spec for co channel GCSs greater than 3 km is less than or equal to 10 μ s.

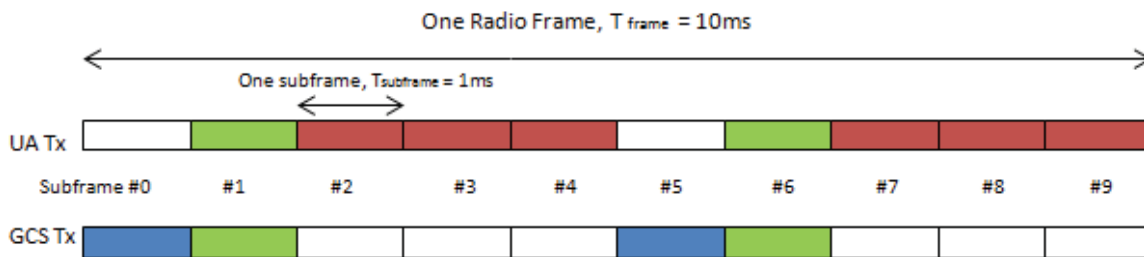

Figure 27. NPC frame at 5 ms Tx/Rx switch periodicity

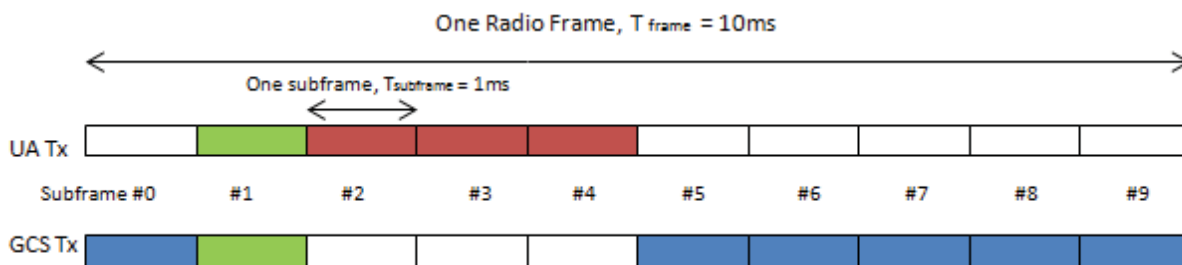

Figure 28. NPC frame at 10 ms Tx/Rx switch periodicity

To comply with Rockwell’s recommended waveform, the LTE frame is essentially stretched to 50 ms, maintaining guard/transitions times at 1 ms, or the amount of time required to compensate for propagation delays at the end of coverage. This is also accomplished using the frame configurations defined in the standard. Figure 29 and Figure 30 depict these changes.

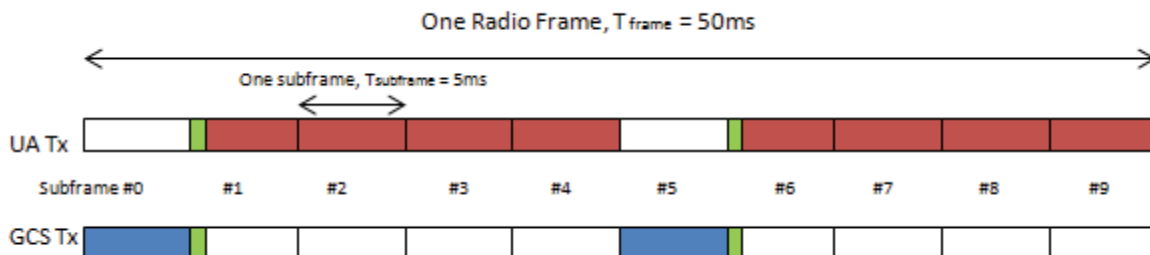

Figure 29. NPC frame at 5 ms periodicity Tx/Rx switch periodicity using Rockwell’s waveform

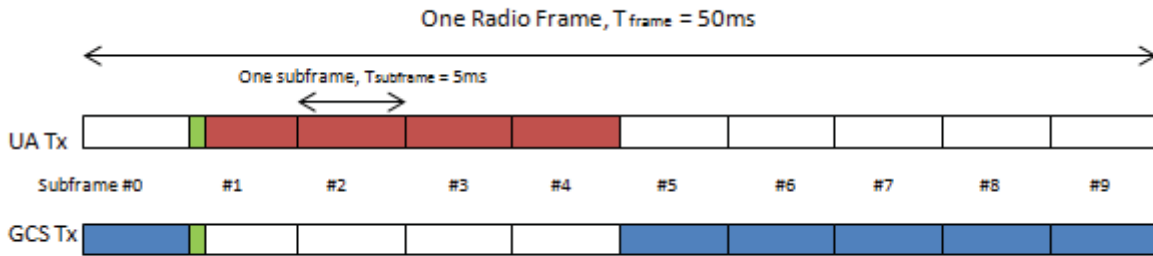

Figure 30. CNPC frame at 10 ms periodicity Tx/Rx switch periodicity using Rockwell’s waveform

7.1.2 Architecture Overview

In LTE architecture, Radio Access Network (RAN) decisions are all handled by the ground station. The ground station would handle functionalities such as radio access control, scheduling, measurements at the radio interface, admission control, mobility control, and inter-ground station. The “core” would oversee other functionalities such as security and mobility while the User Equipment (UE) is in the idle state, and IP address allocation and packet filtering. Figure 31 shows the protocol stack at the ground station, including the RLC, Packet Data Convergence Protocol (PDCP) and the Radio Resource Control (RRC). The MAC, RLC and PDCP are layer 2 protocols, while the RRC is a sublayer of layer 3. Figure 32 shows the interaction of the Aircraft and the GCS.

With respect to the Radio Protocol Architecture, the MAC performs the mapping between logical and transport channels, relaying scheduling information, error correction (HARQ), and priority handling. The RLC performs error correction (ARQ), concatenation, segmentation and reassembly. The PDCP mainly oversees ciphering and integrity protection.

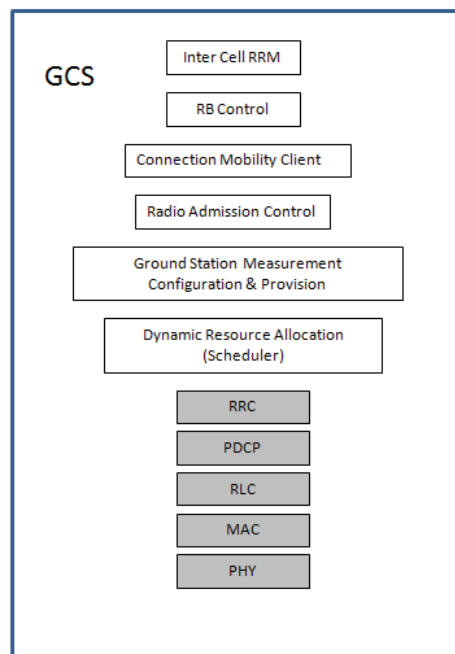

Figure 31. LTE GCS control plane

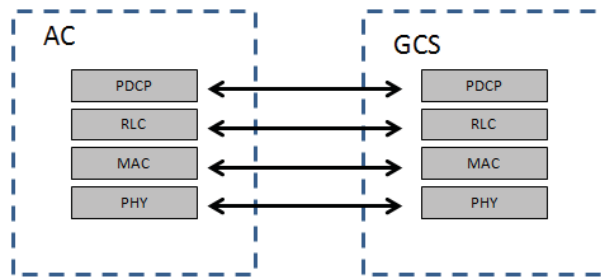

Figure 32. LTE user plane

7.1.3 Network entry / initialization

A device on an LTE network is either Idle or Connected. The LTE standard defines simplified states and state transitions. This section defines the states and the transitions. The flow will describe the Idle, acquisition of system information and resources, connected, and disconnected states.

IDLE Process

There are four processes in the idle mode.

- Public Land Mobile Network (PLMN) selection
- GCS selection and reselection
- Location registration
- Support for manual Closed Subscriber Group (CSG) ID selection

The PLMN selection would be done by the AC radio by acquiring information relative to identified PLMNs and supporting measurements. The section process can be done automatically or manually. The AC radio is synchronized to a broadcast channel by request or autonomously. During the search and measurement optimization can be done through using stored information, such as stored frequencies and/or GCS identifiers. Once completed, the AC radio proceeds to the GCS selection process.

The objective of the GCS selection process is to identify a GCS of which the AC radio can camp on to receive either limited or normal services. This information may be passed along during the PLMN process. GCS selection begins with performing measurements to support a decision, the details of which are described in detail in the standard. There are two signals transmitted in the downlink to facilitate the GCS search, the primary synchronization signal and the secondary synchronization signal. The AC will monitor radio frames to determine radio quality and synchronization.

Location registration is accomplished by the transfer of registration area information from the GCS for processing in the Non-Access Stratum. The procedures are performed for initial location registration, registration updates, maintenance of forbidden registration areas and deregistration when the AC radio is shut down.

Support for Manual CSG ID Selection is provided by the Access Stratum (AS) which searches for GCSs with a CGS ID, reading home GCS names, and selecting a CGS ID.

While Idle, a UA needs to acquire system information prior to getting connected. System information acquisition also needs to take place in the connected state. System information is divided into blocks.

The standard identifies a Master Information Block (MIB) and several types of System Information Blocks (SIBs). The MIB defines the most essential physical layer information of a cell required to receive further system information. The SIBs contains information relevant when evaluating if an AC is allowed to access a GCS and defines the scheduling of other SIBs. Other SIBs contains common and shared channel information, cell re-selection information, functions to relay other specific information such availability of other frequencies, neighboring technologies, and Multimedia Broadcast and Multicast Services.

Connection Establishment and Control – Random Access Procedure

Connection establishment begins with a procedure for random access through which the user is scheduled a transmission to initiate connection setup. There are other instances where the random access procedure may be required. These include RRC connection re-establishing, handover, upon data arrival in the uplink or downlink while the UE is not synchronized or allocated resources, and for positioning while in the CONNECTED state. There are two types of random access procedure: contention based, and non-contention based. The non-contention based procedure is utilized when it is the GCS network that is trying to establish the connection to the AC. The contention based procedure is utilized for AC initiated activity.

In the contention based procedure (Figure 33), AC radio first generates and sends a Random Access Preamble on the Random Access Channel (RACH) in the reverse link. The GCS responds with a Random Access Response on the Forward Link Shared Channel (SCH). This response relays at least the preamble identifier, Timing Alignment information, initial reverse link grant and the assignment of a Cell Radio Network Temporary Identifier (C-RNTI). The AC radio then, when scheduled, transmits its scheduled transmission on the Reverse Link SCH. This scheduled response varies depending on whether the UE is attempting initial access, connection re-establishment, after handover (in the target cell) or other reasons. Finally, indication of contention resolution is made on the Physical Downlink Control Channel (PDCCH) by the GCS. This indication is not synchronized with the AC radio's scheduled transmission and is addressed to either the C-RNTI or a Temporary C-RNTI (TC-RNTI) depending on whether the AC is attempting initial access or is connected.

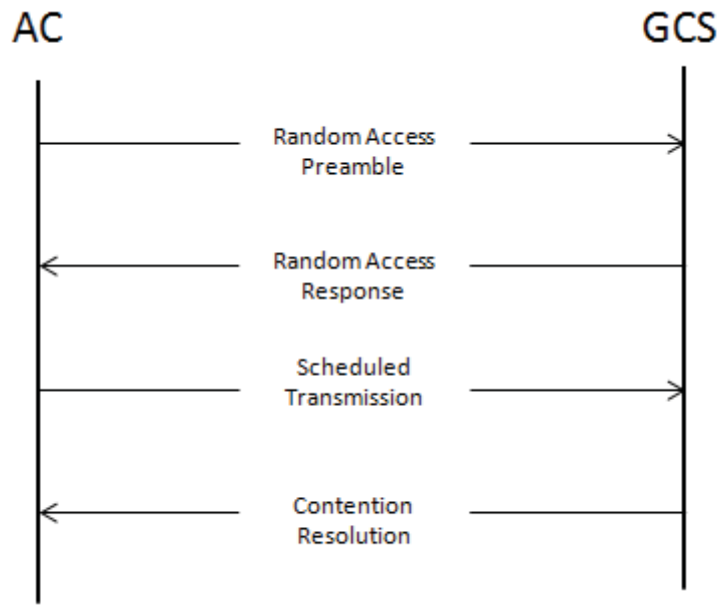

Figure 33. Contention based Random Access Procedure

In the non-contention based random access procedure (Figure 34), an assignment of a RA preamble by the GCS sent to the AC radio is made on the PDCCH or in a handoff command. The AC then sends the RA preamble on the RACH in the uplink. The GCS then sends a RA response on the DL-SCH.

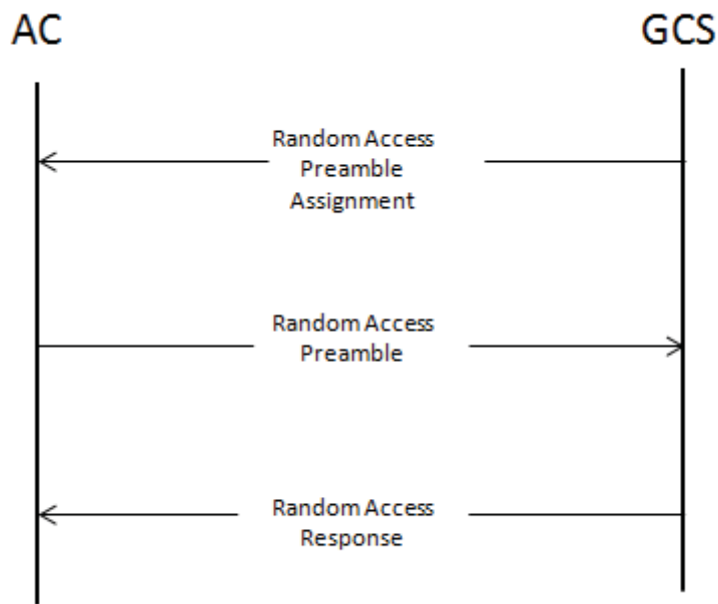

Figure 34. Non-Contention based Random Access Procedure

In a successful RRC connection establishment exchange, an AC radio initiates the connection establishment through sending an RRCConnectionRequest. This request is scheduled through a contention based random access procedure, as described above. However, prior to attempting to establish an RRC connection, the AC verifies whether or not the cell it is camped on is barred or not. This

verification is made through processing the GCS's SIBs. Note that an AC radio is not required to ensure that it maintains updated system information applicable only for AC in an RRC_IDLE state. However, the AC needs to perform system information acquisition upon cell re-selection. The AC shall also, while awaiting the GCS's response, continue GCS re-selection related measurements and evaluation and, if conditions for re-selections are fulfilled, perform cell re-selection. The network responds to an RRCConnectionRequest with an RRCConnectionSetup. An AC radio receiving the RRCConnectionSetup applies the relayed configurations, enters the RRC_CONNECTED state, and stops the cell re-selection procedure. The UE then responds with an RRCConnectionSetup complete message carrying PLMN and Mobile Management Entity (MME) related information, in addition to non access stratum information received from upper layers.

Connection Reconfiguration

LTE also allows for connection reconfiguration in instances where it is required to establish, modify or release resource blocks, undergo handoffs or to conduct setup or release measurements.

Connection Re-establishment

Connection re-establishment is motivated by various failures, including failures in the radio link, handover, mobility, integrity check or RRC connection reconfiguration. The AC radio resets MAC configurations, applies default configuration based on latest system configuration and performs the GCS selection process described above.

Connection Release

A network releasing the connection of an AC radio in connected state sends a release message to the AC. In response, the AC performs actions relevant to leaving the connected state and applies idle mode mobility control information indicated in the release message. The AC resets the MAC, releases all radio resources and indicates the release and cause to the upper layers and performs cell reselection.

Mobility Management

For LTE, the standard distinguishes between three types of mobility scenarios. The first, intra-frequency, is the fundamental handover scenario and is strictly driven by “best radio condition” driver—no other driver can result in an intra-frequency handover as it will definitely result in a degrading performance. Inter-frequency, on the other hand, becomes possible when an operator has simultaneous access to multiple carriers or bands for LTE. This accessibility can be either fixed or temporary. The resulting flexibility allows for different decisions in resource control and architecture, that is, dedicate certain bands for certain services, or establish a network hierarchy. Similarly, the various drivers and limitations can be applied if the operator (or user) has access to multiple technologies.

Connected State

When an aircraft radio is at the RRC_CONNECTED state the network handles the AC's handover decisions, including evaluation of GCS measurements and AC measurements limitations, communication with target cell or network, informing the AC of new radio resources and releasing unused resources. As in cell reselection, the AC makes measurements of attributes of the serving cells and neighboring cells and networks. The GCS need not indicate to the AC radio neighboring GCSs. It needs, however, to indicate the carrier frequencies of the neighboring of inter-frequency neighboring GCSs. The GCS can provide a Neighbor list or black lists of neighboring GCSs. Whether or not an AC radio requires a measurement gap depends on the carrier frequency of neighboring cells. To elaborate, if both the serving and target cells have the same carrier frequency, the AC radio does not require a measurement

gap. This is regardless of whether or not the bandwidths of the two cells completely overlap. If the carrier frequencies of the two cells are different, then the AC radio requires a measurement gap.

In a handoff scenario, once the Source GCS receives the AC's measurement reports and decides that a handover would be appropriate, it communicates a Handover Request to the target GCS. Upon receiving the request, the target GCS performs admission control to judge whether it can handle the AC's requirements. If sufficient resources are available, the target GCS acknowledges the handover requests, including information such as random access preamble, downlink allocation, etc., which are transparently relayed by the source GCS. The Source GCS also issues an RRC connection reconfiguration message. Upon receiving the reconfiguration message, the UE begins detachment from the source GCS and begins synchronization with the target GCS. At this instance, the source GCS begins forwarding the AC's data and transfer the AC's context to the target GCS.

7.2 802.16-based CNPC

Using the 802.16-2009 single carrier (SC) waveform as the baseline, this section describes a potential realization of the CNPC link matched to the proposed physical waveform. The 802.16 Base Station (BS) will have the role of the UA ground station, while the UA itself will be the 802.16 Mobile Station (MS). The system described herein utilizes as much of the SC TDD specified in the standards as possible. Deviations from the standard foreseen for the CNPC link are noted.

It is assumed that techniques specific to the OFDM or OFDMA options will not be used. In general, it is assumed the following features are not applicable, undesired, or not required for CNPC (referenced to the sections in the standard as appropriate).

- Asynchronous Transfer Mode (ATM) convergence sublayer (5.1)
- Generic packet convergence sublayer (5.3)
- FDD duplexing option (6.3.7.1)
- Shared frequency band usage (6.3.15)
- Hybrid ARQ (HARQ) – OFDMA only (6.3.16)
- DL CINR reporting – OFDMA only (6.3.17)
- Sleep mode (6.3.20)
- Multicast / broadcast services (6.3.22)
- MS idle mode (6.3.23)
- Persistent scheduling – OFDMA only (6.3.26)
- Emergency notification service (6.3.27)
- OFDM option (8.3)
- OFDMA option (8.4)
- Unlicensed frequency option (8.5)

Some of the features that may be necessary or beneficial for the CNPC link are:

- Packet convergence sublayer (5.2)
- Payload header suppression (5.2.3)
- Concatenation (6.3.3.2)
- Fragmentation (6.3.3.3)
- Packing (6.3.3.4)
- Automatic Repeat Request (ARQ) (6.3.4)

A proposed 802.16 CNPC frame structure is shown in Figure 35. The forward link subframe is retained from the standard. It is divided into smaller physical slots (PS) and separated from the reverse link subframe by a TTG. The forward link burst begins with transmission of the DL-MAP and UL-MAP, followed by the individual forward link transmissions to the UA, and ending with the TTG.

The DL-MAP identifies the burst profile used for the transmissions in the forward link and references the PS of the start of the burst. Given that the trade study proposes a fixed modulation (GMSK), the burst may still use a variable coding thus requiring the DL-MAP for proper decoding. If variable coding mechanisms are not desired for the CNPC link, the DL-MAP may become unnecessary.

The UL-MAP identifies the usage of the reverse link. Whereas in the 802.16 standard, the UL-MAP identifies PS for transmission by the various subscribers, in this CNPC version the UL-MAP would identify individual frequencies for transmission by the various UA. Although each frequency in the subframe can still be viewed as split into a number PS, in effect there is no need for this since a UA has complete use of its frequency for the entire duration of the subframe. Since the reverse link is no longer TDMA, there is no need for the guard times between reverse link transmissions.

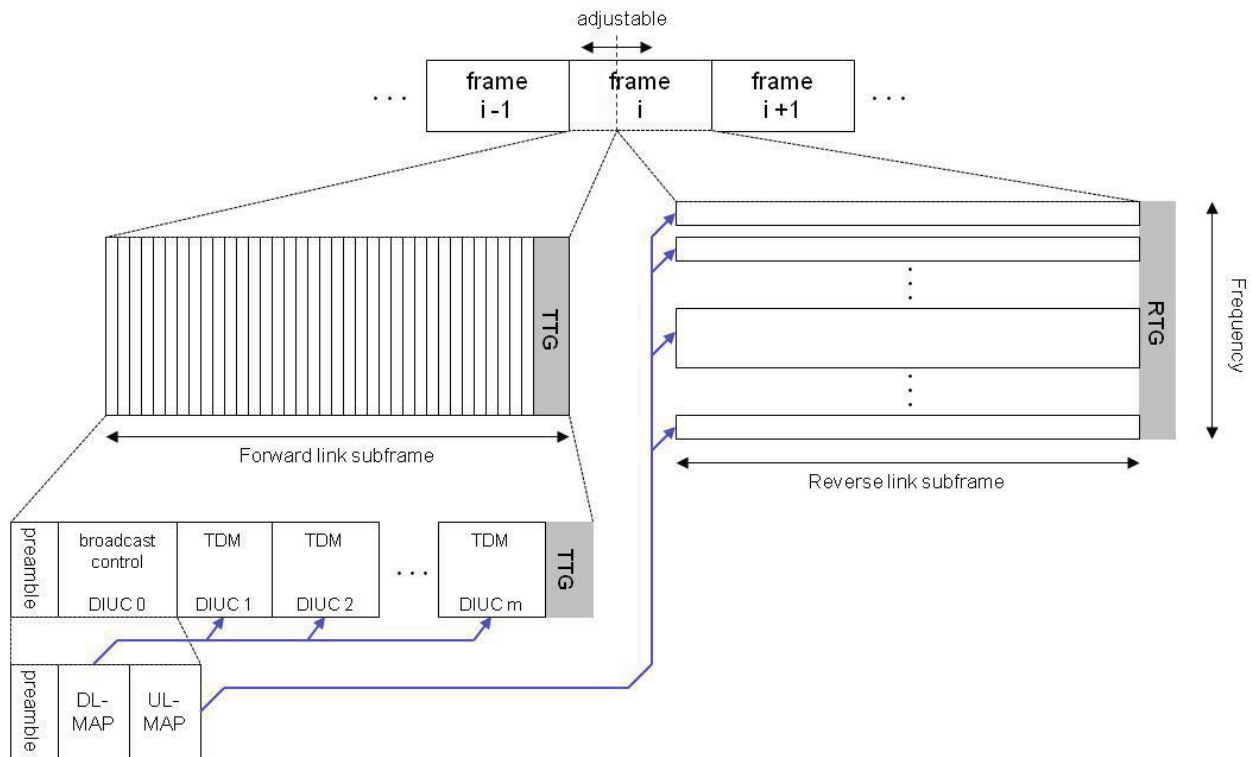

Figure 35. Proposed 802.16 CNPC frame structure

Periodically, a base station will also transmit a Downlink Channel Descriptor (DCD) for the forward link and an Uplink Channel Descriptor (UCD) for the reverse link. The DCD can identify settings such as frame duration, center frequency, the forward link burst profiles, and an indication of the current available resources. The UCD defines the properties for the reverse link. Along with the burst profiles, the UCD also defines portions of time in the reverse link that are set aside for network entry ranging procedures and contention-based requests. For CNPC use, the UCD could be modified to identify the reverse link frequencies and bandwidths. Ranging and contention-based bandwidth requests may be allocated to specific frequencies instead of times. Alternatively, assuming that the ranging and bandwidth request

messages are small, a single channel may be subdivided into TDMA portions for this purpose. The best mechanism to use is outside the scope of this analysis.

7.2.1 Network entry / initialization

The 802.16 standard defines a 10-step process for network entry and initialization. This section briefly describes these steps along with any foreseen modifications necessary for CNPC operation. It is anticipated that these steps will be further reviewed to determine those necessary for CNPC. Potentially, some steps may be omitted if deemed unnecessary to expedite the connection process.

Scanning

The scanning procedure is the first part of the network initialization process. In this phase the UA radio searches for a suitable forward link channel. The method by which the UA determines the scan frequencies, whether it is by non-volatile database of GS and frequencies, set by the UA support element during preflight, or other means, is outside the scope of this document.

Obtain transmit parameters

After scanning for a forward link channel, the UA waits for synchronization by receiving the DL-MAP and UL-MAP, DCD, and UCD messages. Receipt of these messages is necessary for the MS to achieve synchronization with base station. Information carried in these messages is used by the MS to determine if the channel is suitable for use or if scanning should continue. The information also conveys channel parameters such as the channels used in the reverse link, the time at which the reverse link begins, and any transmit parameters required.

Ranging

The initial ranging phase is used by 802.16 to adjust the timing of transmissions by the mobile/subscriber stations such that transmitted messages are received at the base station at the appropriate times. The proper alignment reduces the amount of guard time required between transmissions from different subscribers. By using FDMA instead of TDMA in the downlink, this timing feature may not be required for the CNPC system.

The initial ranging is also used to set the transmit power of the MS. The process begins with the MS sending a range request (RNG-REQ) message at a predetermined power level. If a response is not received from the BS, the MS adjusts its transmit power and retransmits the RNG-REQ. Upon receipt of the initial RNG-REQ, the BS responds with a range response (RNG-RSP) that indicates any adjustments required to power or timing (if needed) as well as indication if further ranging is required or ranging is complete. The RNG-RSP additionally establishes the basic and primary management connection identifiers to be used by the MS. The basic connection is used to exchange short, time-sensitive MAC management messages. The primary management connection is used for longer and less time critical MAC management messages.

In the 802.16 standard, initial ranging is performed in the contention-based ranging section of the reverse link until the basic Connection Identifier (CID) is established. For the CNPC link, the contention-based ranging section may be relegated to a specific frequency or set of frequencies in the reverse link.

Negotiate basic capabilities

Upon completion of ranging, the MS and BS negotiate the basic capabilities to be used for the link. The UA initiates this by sending the subscriber basic capabilities request (SBC-REQ) to the base station with

the set of capabilities supported by the MS defined. The BS responds with a SBC-RSP indicating the common set of features supported by both the UA and the BS.

Depending on the design of the CNPC system and whether features can be optional, the basic capabilities negotiation may not be required.

Authorization and key exchange

The authorization and key exchange is an optional phase of link establishment, utilized only if Privacy Key Management (PKM) is enabled.

Registration

The registration process is used to establish the secondary management connection used for the next phase of network entry. The secondary management connection is used for delay-tolerant, standards-based messages such as DHCP. Registration is a required process for managed subscribers.

Establish IP connectivity

In the 802.16 standard, establishing IP connectivity consists of obtaining an IP address either through mobile IP or Dynamic Host Configuration Protocol (DHCP) mechanisms. Information is transferred using the secondary management connection. At this point in the study, the network connectivity issues have not been analyzed and therefore this section is not expounded upon, other than to note its existence and purpose.

Establish time of day

802.16 standard requires time of day for time-stamped event logging required by the management system. This phase utilizes the time of day protocol specified in the Internet Engineering Task Force (IETF) Request For Comment (RFC) 868 to set the subscriber time. The necessity of this feature and phase for CNPC has yet to be determined.

Transfer operational parameters

In this phase the Subscriber Station (SS) downloads the SS Configuration File using the TFTP protocol on the secondary management connection. The configuration file may include information such as hardware ID, vendor ID, software version, and filename for performing software upgrade. The SS is not required to need a SS Configuration File.

Set up connections

The last phase of network entry is establishment of connections for data transfer. In this phase any provisioned flows are established. See more on flows in the next section.

7.2.2 Data transfer

In 802.16 data transfer is defined in terms of service flows and connections. The 802.16 standard identifies a service flow as a unidirectional flow of packets that is characterized by a set QoS parameters such as latency, jitter, and throughput assurances. A connection is the mechanism used by 802.16 between the BS and MS for transmission.

802.16 specifies that a classifier is used to determine a service flow to which an upper layer packet belongs. For the packet convergence sublayer, the classifier may use the headers from the packet and

transport layers to determine the service flow. The classifier contains rules to allow this mapping, which may be based on fields such as source or destination address, port numbers, etc.

802.16 maps the service flows to transport connections at the MAC layer. There is a one-to-one mapping of service flows to connections. An example mapping is shown in Figure 36. As seen in the example, multiple traffic streams may be classified into the same unidirectional service flow. Furthermore, there is not necessarily a correlation between the traffic in the flows in the forward and reverse direction. The traffic is grouped into service flows in logical ways that allow the appropriate QoS to be applied to the flow and meet the needs of all the traffic in that flow.

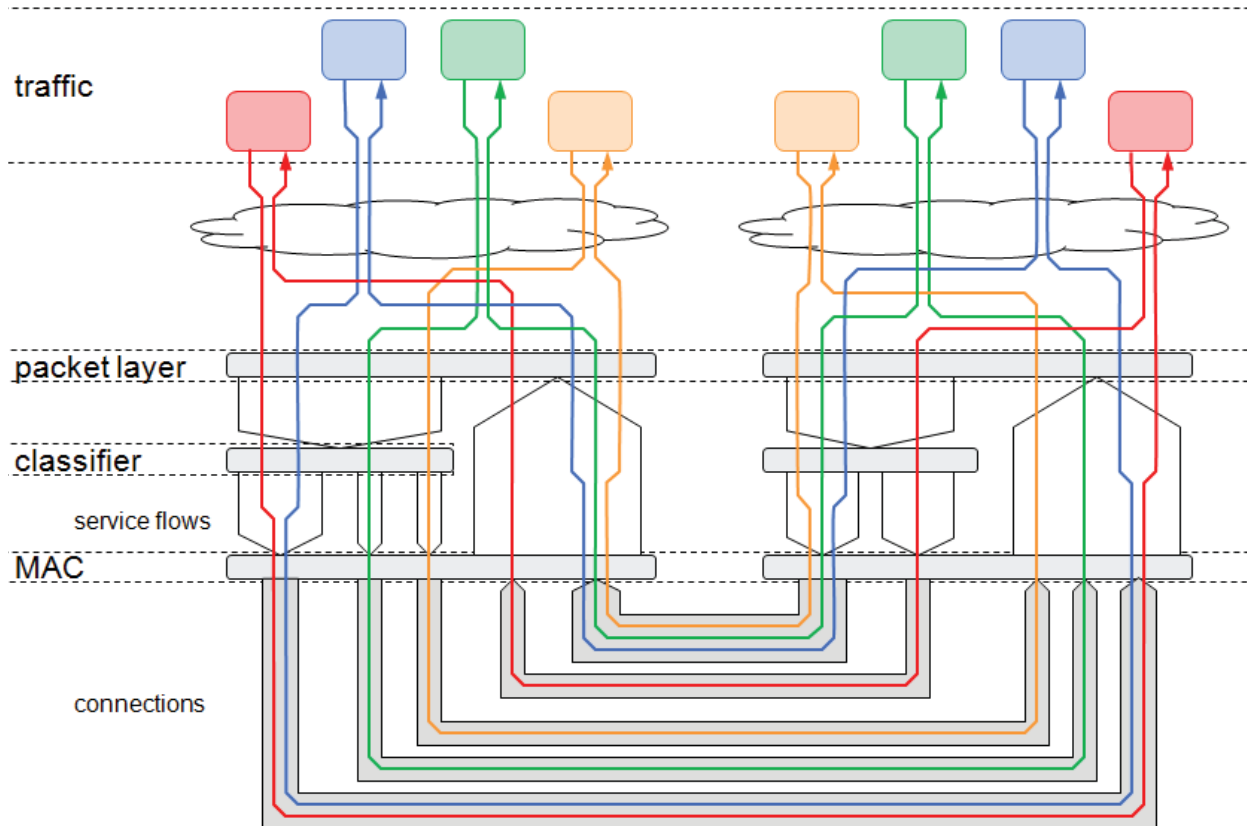

Figure 36. Example 802.16 service flows and connections

Service flows have a lifecycle in 802.16. Service flows are first *Provisioned* when the information on the flow such as basic QoS requirements is known by the ground network. At this point, the service flow has a Service Flow Identifier (SFID) and classifier rules are known. A provisioned flow becomes *Admitted* when resources are reserved for it by the BS and a CID is allocated for it, but it is not active (i.e. no traffic is flowing). The admitted flow becomes *Active* when traffic is flowing between the devices.

Authorization for service flows may be either static or dynamic.

To become activated, either the BS or MS may choose to activate a flow by sending a dynamic service change request (DSC-REQ) which includes the service flow ID and QoS parameters. The BS will allocate a connection for the flow and notify the MS of the CID. Service flows may be started/stopped multiple times by use of the DSC-REQ message.

Bandwidth Services

Once a connection becomes active, it may begin requesting and using slots to transmit data according to the QoS policy for the service flow. Each flow utilizes a single type of scheduling service to obtain slots for transmission. These scheduling service mechanisms mainly apply to the reverse link, as the BS is capable of assigning the forward link slots as necessary based on the QoS of the traffic. These services are detailed below.

The Unsolicited Grant Service (UGS) is designed for real-time fixed-rate traffic. The QoS parameters specify the size, grant interval, tolerated jitter, and maximum latency. The BS allocates bandwidth automatically to the connection while a UGS flow is active. UGS likely would be suitable for manual-mode control/status messages (assuming a relatively constant size and rate) and video.

The Real-Time Variable-Rate (RT-VR) service supports, as the name implies, real time traffic that is not fixed in rate or size. The QoS parameters specify the maximum latency, minimum and maximum traffic rates, traffic priority, and a polling interval. The BS uses polling to allocate a small amount of bandwidth to the connection for the purpose of specifying the amount of bandwidth required for the data. Surveillance target data may be one type of traffic that could use the RT-VR service.

802.16 also includes an Extended Real-Time Variable Rate (ERT-VR) service which is a combination of the UGS and RT-VR services. It contains an unsolicited grant interval like UGS, but the grant sizes are variable between the maximum and 0. The MS can dynamically adjust the size of the requested bandwidth with a bandwidth request message transmitted during one of its grants or during a contention opportunity. The ERT-VR service would be suitable for the voice relay service, where the rate changes between the vocoder rate and 0 depending on if the radio is receiving or transmitting.

The Non-Real-Time Variable-Rate (NRT-VR) service is similar to the RT-VR service but designed for traffic that is less sensitive to delays. Its QoS parameters include minimum and maximum traffic rates and traffic priority. Bandwidth is normally allocated by the polling mechanism used in the RT-VR service.

The final service type is the Best Effort (BE) service. In this service, bandwidth must be explicitly requested every time it is needed. These requests may either use the contention opportunities or be combined with other requests or data transmissions. The QoS parameters for BE service are the maximum traffic rate and priority. BE service may be adequate for the less time critical ATS data relay traffic.

It is important to note that all bandwidth requests to the BS reference the specific connection such that the BS can determine the QoS parameters required for the request. However, all bandwidth grants are allocated to the Basic CID of the MS. It is up to the MS to determine which data or request traffic is to be transmitted in that allocation.

For the CNPC system, the use of these services potentially may be simplified. Given that, at a minimum, telemetry and status messages will be flowing regularly during the entire flight, the need for polling each individual service may be reduced. Whereas with standard 802.16 usage is optimized by granting bandwidth only for a duration long enough to satisfy the transmission demand, for the CNPC system a bandwidth grant allocates a channel for the entire reverse link subframe regardless of the actual amount required. To optimize usage, the UA should utilize its grant as fully as possible, using any extra time to transmit bandwidth requests for other connections. If done properly, this will eliminate the need to allocate a channel just for the polling of RT-VR or NRT-VR services.

Automatic Repeat Request (ARQ)

ARQ is a method of ensuring message delivery via an acknowledgement and retransmission procedure. ARQ can be enabled or disabled on a per-connection basis and is negotiated during the connection setup. Although the standard states that ARQ shall not be used on the SC waveform, neither a technical limitation nor reasoning is found for this restriction.

In ARQ operation, a transmission is logically partitioned into blocks of a given size. Sets of these blocks are transmitted using a sliding window up to the window size. The receiver can use a combination of cumulative, selective, and negative acknowledgements to acknowledge blocks using the ARQ feedback message. The transmitter uses this information to adjust the window and schedule blocks for retransmission as necessary.

7.2.3 Handoff

The handoff process in 802.16 is initiated by the mobile. The process consists of 5 major phases. These are cell selection, handoff decision and initiation, synchronization to the new BS, ranging, and finally termination of the current link. These steps are discussed below.

Cell Selection

In 802.16, the BS makes MS aware of other nearby by BS by using mobile neighbor advertisement message (MOB_NBR-ADV). This message contains information on the channels used by neighboring BS. This information is essentially the same as that contained in the DCD and UCD messages.

The MS utilizes the information in the MOB_NBR-ADV messages to identify and scan the neighboring BS. The MS coordinates with the BS to create scanning periods. In these periods, the BS will not transmit to the MS or allocate bandwidth to the UA for normal data transmission. Instead, the MS tunes to a channel identified in the MOB_NBR-ADV for the purpose of scanning a neighbor BS for a set number of frames. During the scan, the MS synchronizes with the BS and measures the channel quality. After the scanning, the MS reports the results such as CINR or RSSI to its BS.

The MS may also optionally associate with the neighbor BS along with scanning. In the most basic form, the association includes performing initial ranging with the neighbor during the scanning interval. More advanced forms of association can reduce the time (and number of frames) required by providing coordination between the original and neighbor BS.

Note that the scanning interval requires that the CNPC link is capable of an access rate greater than that required by the data, as some frames used for scanning or association cannot be used for data transmission. The feasibility of requiring multiple adjacent frames to perform neighbor scanning and association without substantially increasing the frame rate has yet to be determined.

Handoff Decision and Initiation

The MS and/or BS uses information acquired during the scanning process to determine when a handoff should occur. The algorithm for this determination is outside the scope of the standard.

Once the decision has been made, the handoff is initiated by the entity that made the HO decision. For an MS-based decision, the handoff is initiated with the MS handoff request message (MOB_MSHO-REQ). This request may include one or more possible target BS. The BS can send handoff indications to the identified BS. The BS can use the response from these indications to determine the BS selected for the handoff. The BS acknowledges the handoff with the MOB_BSHO-RSP response message to the MS

recommending a target BS. The MS has the final decision on the target BS and notifies the BS through the MOB_HO-IND message.

If the BS decided to perform the handoff, it notifies the aircraft with the MOB_BSHO-REQ handoff request message. This request may include information on a target BS. The MS may respond with the MOB_IND message accepting the recommended BS, issue its own handoff request via sending a MOB_MSHO-REQ message, or cancel the handoff.

As can be seen, the 802.16 standard supports many options for the handoff decision that were briefly described here. The full set of handoff decision and initiation options may, after further research, be reduced to a more manageable subset necessary for the CNPC link.

Synchronization to the Target BS

For a handoff, the synchronization step is similar to that of network entry. The MS receives information about the target BS channel by receiving the DCD and UCD messages. This step is shortened if the MS previously received the information for this BS via the MOB_NBR-ADV neighbor advertisement.

Ranging

If the handoff notification was performed between the original and target BS, the target BS may provide non-contention ranging opportunities for the MS. For the CNPC link, the target BS would allocate a channel for the UA performing the handoff for this purpose, known as fast ranging. Ranging procedures are performed as in network entry.

The target BS may obtain operational parameters for the MS over the backbone from the previous BS, shortening the procedures required for network entry. The steps that may be removed include

- Negotiation of basic capabilities
- PKM authentication
- Registration

Termination of Previous Link

At this point the MS can begin using the new BS. The link to the old BS is terminated by sending a MOB_HO-IND message indicating the release of the link. The original BS starts a timer upon receipt of this message, and upon expiration releases all resources for the MS. Before the timer expires, the MS still has the opportunity to cancel the handoff.

Handoff Cancellation

The MS can cancel a handoff at any time prior to the termination of the previous link. Once performed, the MS and original BS resume normal operation.

7.3 P-34-based CNPC

It is assumed the following features are undesirable or not required for CNPC.

- Interleaving to spread sequentially coded symbols in time and frequency
- FDD duplexing option
- Adaptive modulation
- Multicast / broadcast services

- Emergency service
- OFDM option
- Energy Conservation (Sleep mode)

A proposed P-34-based CNPC link is shown in Figure 37. The forward link subframe transmits continuously. The first slot of every forward link subframe contains the Broadcast Control Channel (BCCH) synchronization information. Every slot thereafter contains a Slot Information Channel (SICH) and a Packet Data Channel (PDCH).

The SICH conveys slot identification information and contains all MAC protocol elements common to the configuration mode. It contains the information necessary to decode the remainder of the slot, including coding scheme, logical channel multiplexing, and block formatting information. In addition, the forward link slot header contains information on usage of the corresponding reverse link slot stream. The SICH maps directly to the MAC slot header block.

The PDCH conveys the user's data in IP packets. MAC data messages map directly into the PDCH on all forward and reverse slots. The data is transmitted utilizing reserved access slots. The MAC layer obtains sufficient bandwidth on the PDCH using random access procedures.

There is guard time between the forward link and reverse link subframes.

The one-to-many link between the Mobile Radios (MR) and the Fixed Network Equipment (FNE) requires a method to efficiently schedule inbound channel access to simultaneously contending MRs. P-34 utilizes a slotted Aloha RACH to request PDCH resources. In addition, the RACH carries control plane information. The normal P-34 random access procedures are for the MR to request timeslots. Instead of granting slots, the CNPC FNE would grant usage of a frequency channel in reverse link subframes.

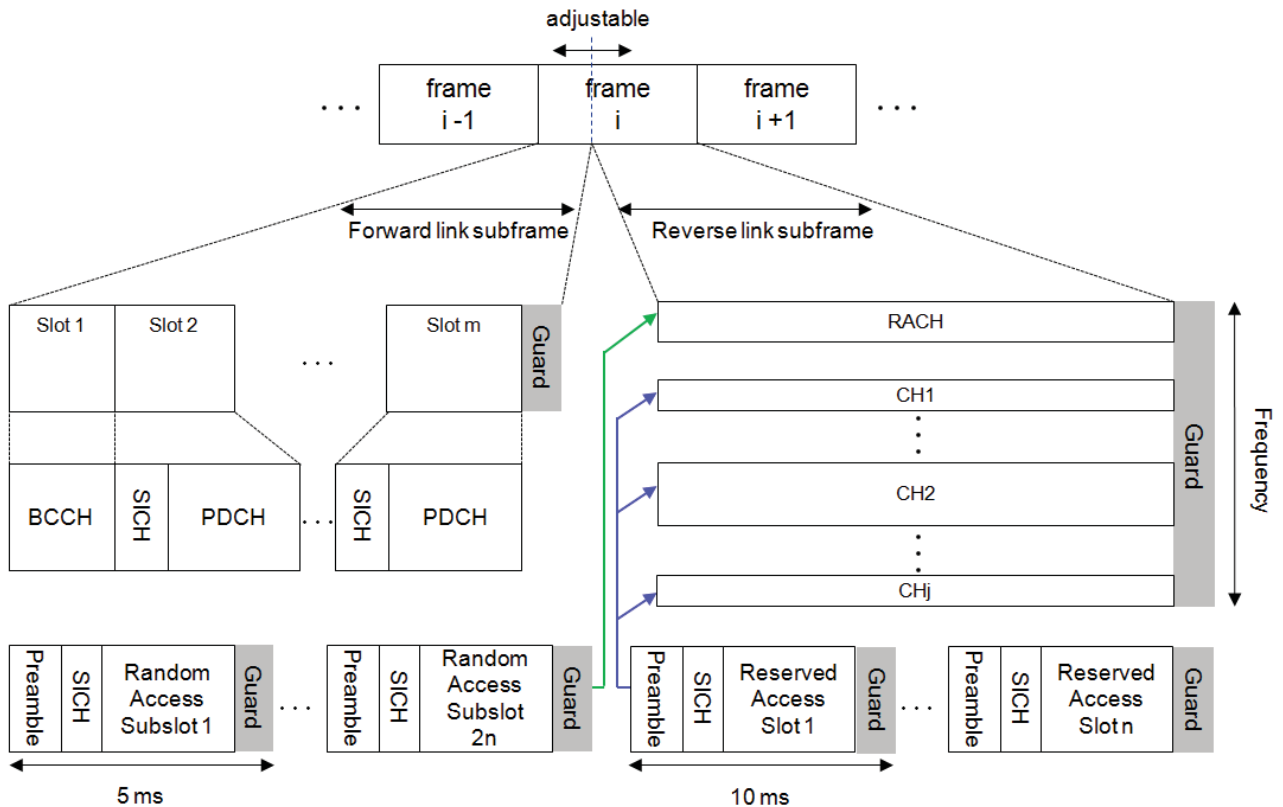

Figure 37. Proposed P-34 CNPC frame structure

7.3.1 Network entry / initialization

IP packets are transported across the Wideband Air Interface (WAI) using the Sub-Network Dependent Convergence Protocol (SNDPC), which uses tunneling to create, maintain, and multiplex simultaneous network layer connections and provide robust network management. The MR and FNE negotiate packet data protocol (PDP) between network layer clients, allowing dynamic association between the MR IP address and the WAI address and initialize any supplementary services utilized between higher layer clients. The SNDPC network layer service identifier (NSAPI) is used to distinguish multiple higher layer services and connections. IP addresses can be static or dynamic. Asymmetrical addressing is used. The MAC layer uses a 12-bit subscriber access code (SAC) since the FNE is always the implied source for outbound frames and the destination for inbound frames. The FNE dynamically assigns the SAC to the MRC, as is detailed below.

Scanning

The MR scans and evaluates channels of acceptable link quality and determines which site offers the best service quality. The FNE may allow access to the requested site, or may deny access, in which case the MR shall search for an alternative site.

Channel Access

P-34 utilizes a slotted-aloha RACH to request PDCH resources. The MR uses random access procedures (RAP) when first gaining access to a site/channel to obtain a working MAC address (SAC) or when a packet must be transmitted and no slot reservation exists yet.

Authentication and Configuration

The Mobility Management (MM) layer permits the FNE to authenticate the MR before allowing registration and subsequent network services. If the MR has not been manually provisioned with the following registration identities, it shall request them from the FNE: 48 bit Electronic Serial Number (ESN), 12 bit Home System Wide Area Communications Network ID (WACN ID), 20 bit Home System ID (SYS ID), 24 bit working MR Control Subscriber Unit Address (WUID), and an 8 bit Manufacturer's ID. In addition, the FNE must already be configured with the following valid network identities: WACN ID, SYS ID, 8 bit radio frequency subsystem ID (RFSS ID), 8 bit radio site (Site ID), 8 bit location registration area (LRA), and an 8 bit location area (LA).

Registration and Transmit Parameters

The MM layer requests the MAC to open a connection to the FNE. The FNE allocates a valid SAC, forms a MAC Address response primitive. Normally this is transmitted to the MR on the Slot Signaling Channel (SSCH) using the anonymous SAC. However the SSCH, whose primary use is for conveying peer-to-peer signaling, will likely not be used in the CNPC. This information will need to be sent on the SICH instead. The FNE also provides the MR with timing adjustments based on the propagation conditions.

Packet Data Protocol Context Activation

PDP context activation can be initiated by the MR or FNE. The MR initiates PDP context activation when a SN_Activate_Request primitive is received from the service user via the network layer. The MR transmits a W_ACV_CNT_REQ primitive to the FNE via the Logical Link Control (LLC) Plane. If the parameters are acceptable the FNE responds with a W_ACV_CNT_ACC primitive. If the parameters are unacceptable the FNE responds with the W_ACV_CN_REJ primitive. If the MR hasn't received a response before the T.300 timer expires it may retry once. The MR informs the user of the service parameters with the SN_Active_Con primitive.

If the FNE receives a packet for an inactive context the FNE transmits the W_ACV_CNT_CMD primitive to the MR. If the parameters are acceptable to the MR it continues the context activation procedures. If the parameters are unacceptable the MR transmits the W_DCV_CNT_CMD primitive back to the FNE.

The MR shall try to establish LLC connection during or after initial context activation or when it's paged by the FNE.

The SNDCP to LLC layer interface is defined through the following primitives: LLC_Data, LLC_Signal, LLC_ARP, LLC_Cancel, and LLC_Connect.

7.3.2 Data transfer

IPv6 bearer service classes differentiate wideband service quality characteristics via the following parameters: source address and subnet mask, next header, destination port range, source port range, IPSec Security Parameter Index, traffic class and mask, and flow label.

Service users request transmission services from the SNDCP and may negotiate for a QoS using the following primitives: SN_Activate, SN_Deactivate, SN_Data, and SN_Cancel.

When the MR receives a packet it first verifies that the IP header is valid and that the Maximum Transmission Unit (MTU) size is acceptable. When the MR SNDCP receives a SN_Data_Req primitive it verifies that an active PDP context exists for the source address. The MR then applies any supplementary SNDCP service processing such as IP header or user data compression or mobile IP

service processing. Then the MR prioritizes the packet in its transmit queue. The SNDCP then requests the LLC link deliver the message using an LLC_Data_Req for confirmed data.

When the FND SNDCP receives an LLC_Data_Ind the SN header is checked and the packet is decompressed and then the FNE applies IP routing techniques to attempt delivery to the destination IP host.

7.3.3 Handoff

The system operator may configure a network into one or more registration areas (RA). A RA is a collection of sites within the same Location Registration Area (LRA) and may have one WACN/SYS ID. Within an RA there can be multiple LRA, each having a unique RFSS ID. Within the LRA there can be multiple Location Areas (LA). A LA can consist of one or more sites, which each have a unique Site ID.

Handovers can be MR controlled or FNE controlled. This is negotiated during unit registration.

The SNDCP may request paging services from the MM layer so it has knowledge of the operational status of the mobile link and can support efficient RF delivery of packets. The MM layer of either the MR or the FNE can select a different radio channel due to cell service quality reasons.

The MR attempts to retain the LLC connection after site handovers. Or the MR can request the reconnection of the link on the new cell. The FNE responds by indicating if the reconnect request has been accepted or rejected. The MR may try to reconnect the link during or after location registration procedures.

A full unit registration is performed whenever a new RA is entered. The FNE checks the validity of the full 56-bit MR long address Subscriber Unit ID (SUID) and then allocates a 24-bit WUID for the MR to use for MM procedures within the RA or LRA.

An abbreviated location registration is performed whenever a new LRA is entered.

Whenever a new LA is entered a location registration is performed. This facilitates the FNE tracking of the current location of the MR. The MR may have to first perform channel acquisition procedures and obtain a new SAC. A location registration is not required when the MR roams to a new site within the same LA.

The FNE periodically broadcasts adjacent cell/channel information to the MRs for the support of network location registration.

The SNDCP to MM layer interface is defined through the following primitives: MM_Page, MM_Link, MM_Register, MM_Deregister.

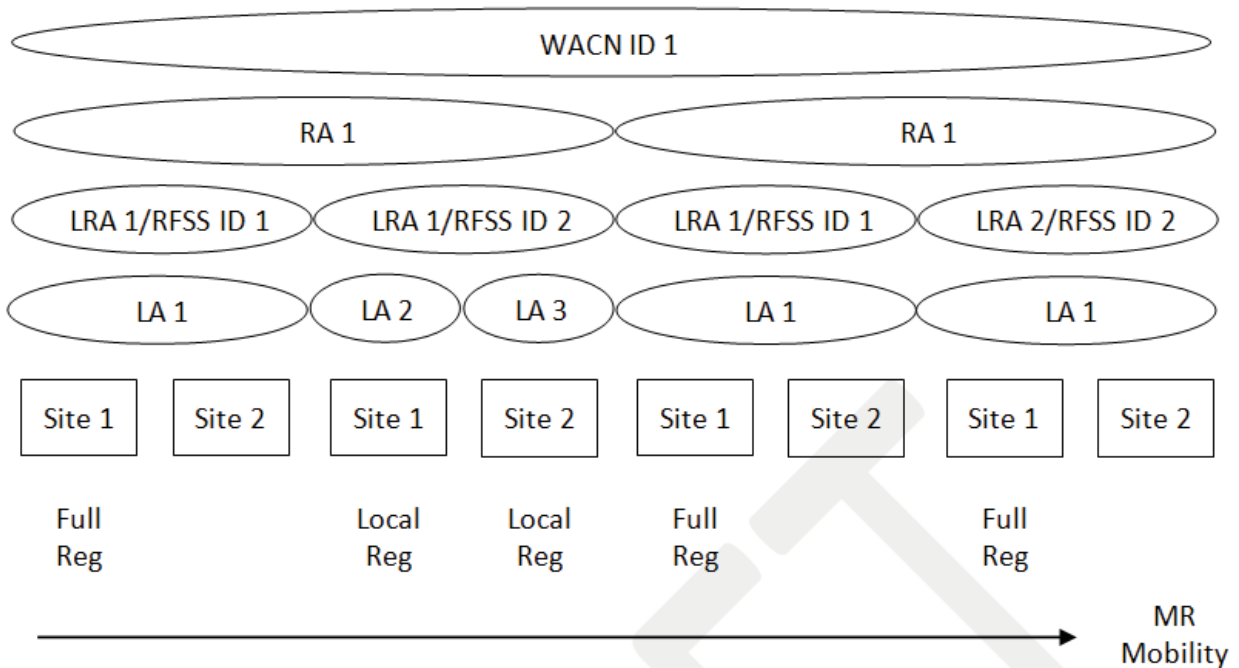

Figure 38. P-34 Mobility Management Area Diagram

7.4 TEDS-based CNPC

TEDS incorporates many features since it is designed as a robust public safety link. The following features are either not applicable or undesirable for a TEDS-based CNPC link:

- Direct Mode Operation (DMO)
- Call related features
- Circuit mode transfers (i.e. Traffic Channels)
- Carrier sharing
- Secondary Control Channels
- QAM modulation and related procedures
- Napping

A proposed TEDS-based CNPC link is shown in Figure 39. The forward link subframe can use a transmission mode called Downlink-Continuous Transmission. When the TEDS BS is using all four slots adjacent to each other, no guard times are needed between each slot. This is the type of transmission that would be needed in the CNPC forward link since no guard times would be needed between slots. Modifications would have to be made to support more than four timeslots per frame. This would mostly impact random access procedures since slots are referenced by number. However, since random access will be performed differently, it should not be much of an issue.

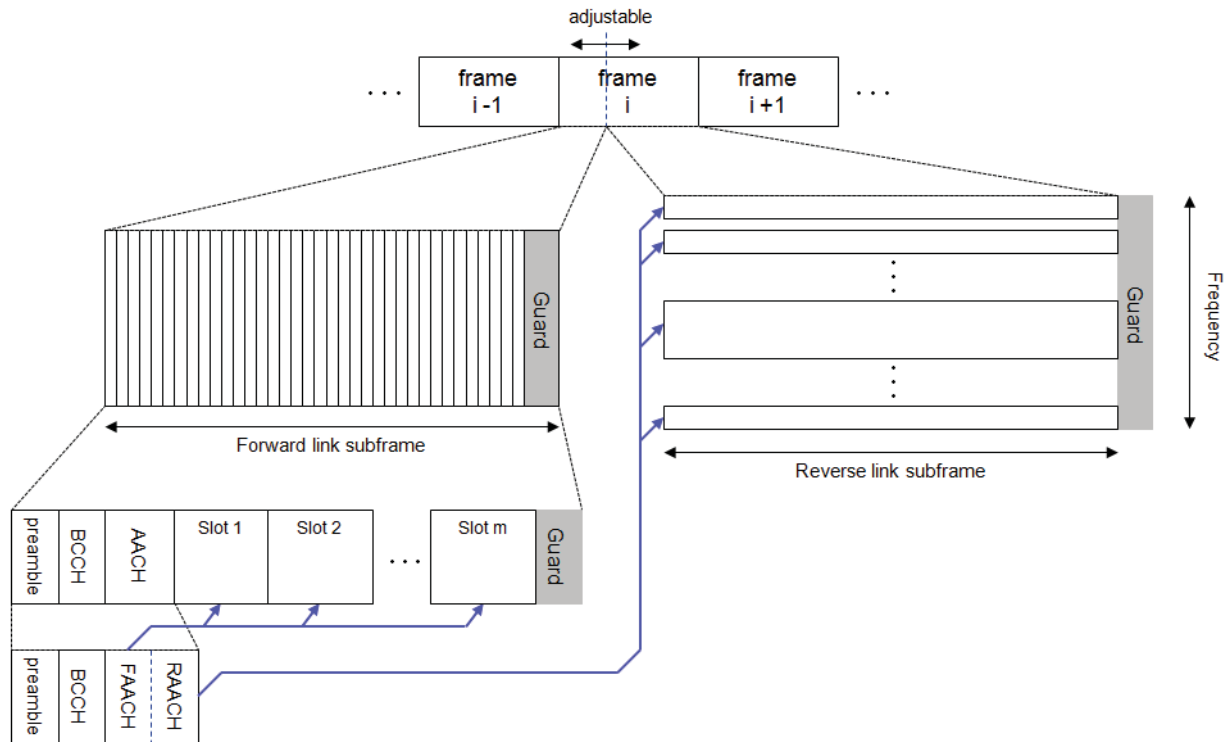

Figure 39. Proposed TEDS CNPC frame structure

Each TEDS cell has a single RF carrier that uses the first slot of the TDMA frame that acts as the Main Control Channel (MCCH). The control channel is where such things as broadcasts and random access procedures take place. The information broadcast on the MCCH will also need sent out for a CNPC link. This is proposed to be the first slot in the forward link as a control slot. This way the UA could gather the appropriate channel information when initially moving into a cell.

In order for a TEDS MS to get onto a cell it must parse data from the Broadcast Control Channel (BCCH) which carries the SYNC PDU, SYSINFO PDU, and D-NWRK-BROADCAST PDU. These are currently sent out approximately every 1 second. For a TEDS-based CNPC link, it is assumed these would not need sent out every frame since this information does not change often, so the BCCH may not always be present in every frame. However, when an MS scans a cell, it must get the SYNC PDU and SYSINFO PDU to analyze the link. A long interval may lead to a UA taking longer to scan a cell, and a lower interval may lead to unneeded overhead. This is possibly a topic of future investigation.

In TEDS, the Access Assignment Channel (AACH) is present in every forward timeslot to indicate what the forward and reverse timeslots are designated for. The AACH in the CNPC link would have to aggregate this information to send in the control slot. The Forward AACH (FAACH) would map timeslots to a particular UA. This may be unneeded if the UA is specified to receive all forward link slots and find the timeslot designated for itself; however, this may lead to inefficient power usage. This is an area of future investigation.

The Reverse AACH (RAACH) would map frequencies to a particular UA. Each UA would then know what frequency it is allowed use in the reverse link. The RAACH could possibly contain a mapping for all frequencies on every frame, or it may send only updated information since the previous frame.

The RAACH would also indicate what frequencies are set aside for random access procedures. The normal TEDS random access procedures are for the MS to request timeslots (described below). Instead of granting slots, the CNPC BS would grant usage of a frequency in reverse link subframes.

7.4.1 Network entry / initialization

To initiate the network entry process, the MS will scan potential cells from a list. This list can either be stored on the device or provided by the upper layers. The Mobile Link Entity (MLE) layer will go through a process that sequentially measures link statistics for each candidate in the list.

Scanning

First, the physical layer will retune to a frequency channel requested by the MAC layer. It will then acquire synchronization on the channel by listening for the synchronization training sequence contained in the Broadcast Synchronization Channel (BSCH). The MS will then be able to decode the SYNC PDU that is also carried within the BSCH. The SYNC PDU normally contains information such as the slot, frame, and multiframe number for the downlink slot giving the MS full synchronization with the BS. It may need to contain different information for a CNPC link, but the intent would be similar.

Once the location within the timing structure is known, it can listen to the Broadcast Network Channel (BNCH) to decode the SYSINFO PDU. The SYSINFO PDU normally contains such things as the frequency of the main carrier, number of channels, and cell re-selection parameters. Again, different information may be contained for a CNPC link.

It can begin measurement of the RSSI of the channel on the selected cell. It will calculate the loss parameter C1, which is a function of the RSSI and various permissible transmit levels gathered from the SYSINFO PDU. The C1 loss parameter is reported to the MLE to conduct cell ranking decisions to select the appropriate channel.

Once ranking of all the potential cells is finished, it will select the best one and will retune to that cell. Assumedly, information will be saved from when it was initially scanned to acquire synchronization faster.

Registration

If required, the MS will then register, and possibly authenticate, itself with the BS. Registration can be initiated by the user, the MS's MLE, or the ground infrastructure. It is assumed that for UAS the infrastructure will be responsible for ensuring that the UA is registered. The infrastructure will request the MS register. The MS will reply containing identity information and other needed parameters. The BS will then accept or reject the registration. These messages exchange such things as addresses, ciphering parameters, and authentication. Once registered, it is then able to send and receive data on that cell.

Ranging

An air-ground-air (AGA) extension was defined for TEDS to extend the cell radius to approximately 46 NM by shortening ramp-up and ramp-down times. After registering with an air cell (i.e. a cell using AGA services), the BS may perform ranging procedures to estimate the range of the MS. The BS will send a request to indicate the MS immediately respond so distance can be estimated. This is done to ensure that the MS stays inside the cell radius, preventing overlapping transmissions. At any time the BS can request that the MS perform cell reselection if it detects the path delay exceeds a set limit.

7.4.2 Data transfer

TEDS provides two types of links for transferring data. A basic link is always available as soon as the MS is established with a BS. The basic link is normally used for layer 3 signaling and short data bursts. This link has a predefined QoS, which allows for minimized overhead since QoS does not have to be negotiated for this link. For larger packet data that must be segmented, or if the QoS of the basic link is inadequate, an advanced link can be established that has negotiated QoS parameters for the data stream. The basic link is used to establish the advanced link and is still available while the advanced link is in use. Both the basic and advanced link used the control channel for packet data transfer and can use the same timeslot.

Random Access

Once it has received and decoded access parameters from the RAACH, a slotted aloha random access protocol is used to initiate data transmission from the MS. The BS can dynamically assign each MS one of up to four access codes. An MS can only send a random access request during a slot designated for its access code. The BS can segregate different MSs to allow for reduced collisions and to implement priority among MSs. The BS is allowed to decide who gets what access code and when. In every forward link transmission, a mapping is sent that defines what access codes are allowed to send in the corresponding reverse link slot.

Random access would still be needed but would use the designated frequencies from the RAACH instead of timeslots to make a request. The access codes could still be implemented if desired to gain the same advantages in TEDS such as reduced collisions and priority. The access code mappings would need to be sent in the RAACH and define what frequencies are assigned to which access codes.

Reserved Access

If the BS is expecting a response from the MS, the BS will reserve a timeslot for the response. For the CNPC link it would reserve a frequency. The MS can also request reserved slots. It can set up scheduled access so that it can meet a specified data rate and repetition rate. For applications with bursty data, this provides quicker access to the channel since it does not use the random access process each time. The MS can also request slot granting, so that a predefined number of slots will be set aside. This is used when a single message must be sent. Both of these mechanisms are established using the random access protocol described above.

Again, instead of timeslots being requested for schedule access, the UA can request that a frequency be set aside in the reverse link subframe. The requests for reserved access can be made on a random access frequency, and a conformation can be sent in the forward link of the following frame. This allows for a rapid setup of reserved access.

7.4.3 Handoff

To ensure the best link is used, the MS scans neighboring cells. The current BS may send out a D-NWRK-BROADCAST PDU which contains a list of neighboring cells and their parameters. Scanning can be done in foreground mode (communications must be broken during scanning) or background mode (communications are not interrupted during scanning). It is desirable for a UA to implement background scanning to prevent communications being interrupted.

A handoff can be caused by link failure or a better link becoming available. If ranking of neighboring cells shows that another can provide a better quality link it will initiate procedures to switch to the new cell. TEDS defines five different types of handoffs as follows:

- Unannounced – An unannounced handoff is when a mobile device is unable to notify the current cell prior to a handoff. This is the case in a lost link scenario.
- Undeclared – An undeclared handoff is preformed when no circuit mode transfers are currently active. However, the standard recommends that advanced links are disconnected prior to doing an undeclared handoff.
- Announced Type 3 – For a MS that is unable to monitor adjacent cells while maintaining current communications, it will break all current connection in order to monitor and acquire broadcast and synchronization information.
- Announced Type 2 – A type 2 handoff is conducted when a MS is able to perform background scanning. Once a new cell is selected, it will announce the new cell to the current cell, and will switch to the new MCCH so that traffic channels can be reestablished.
- Announced Type 1 – A type 1 handoff is similar to a type 2 handoff except that once the MS announces the new cell that it is going to handoff to, the current cell will coordinate with the new cell to allocate a traffic channel for the MS. The MS can then immediately switch to the new traffic channel and bypass reestablishing connections.

Since circuit mode transfers are not being considered for the CNPC link, an announced handoff would not be applicable if strictly following the TEDS standard. However, robust handoffs are desired for UAS. An announce type 1 handoff would be preferred to apply for all situations. This would be a starting point to further investigate implementation of soft handoffs for the CNPC link.

For a type 1 handoff, the MS must be able to perform background scanning of cells. Once a new cell is selected, it will inform the current cell that a handoff is desired to a given cell. Forward registration allows the MS to register with the new cell before switching over to it. If the registration is accepted, the current cell will issue a response which indicates a traffic channel has been allocated in the new cell and to switch over immediately. For the proposed CNPC link, the current cell would inform the new cell of how many frequencies must be available for the UA to switch to a new cell. The current cell could possibly inform the UA of timing information and frequencies pre-allocated by the new cell.

7.5 Summary

The four technologies identified in Section 6 were investigated in further detail for application as a potential UAS CNPC link. The exercise demonstrated that, with modifications, each of the four candidates could potentially operate using the waveform. In each case, no foreseeable technical issues were identified that would prohibit operation within the CNPC waveform. However, this was a brief examination and cannot sufficiently conclude that a technology would fulfill the requirements for a CNPC link. Further research is needed to determine the most efficient and technically feasible solution for implementation as a CNPC link.

Of the four technologies, LTE and 802.16 were ranked as the top two. Although 802.16 ranked slightly lower than LTE, it is being selected as the technology for the prototype CNPC radio. It was chosen due to being a more mature technology and the precedence 802.16 has for aeronautics from the ongoing AeroMACS project. A variant of 802.16 will be defined throughout the project which NASA GRC will model and simulate in parallel with the development and testing of the prototype radio. A few other technologies will be selected to be modeled and simulated alongside 802.16 as possible alternatives, and to validate the choice of 802.16 as the most suitable CNPC candidate.

Appendix A. Abbreviations

AACH	Access Assignment Channel
AC	Admission Control
ACARS	Aircraft Communications Addressing and Reporting System
ADL	Advanced Airport Data Link
ADS-B	Automatic Dependent Surveillance - Broadcast
AeroMACS	Aeronautical Mobile Airport Communications System
AES	Advanced Encryption Standard
AGA	Air-ground-air
AM	Acknowledged Mode
AMACS	All-purpose Multi-channel Aviation Communication System
AMC	Adaptive Modulation and Coding
AMR	Adaptive Modulation Rate
AP	Access Point
APCO	Association of Public-Safety Communications Officials
ARIB	Association of Radio Industries and Businesses
ARINC	Aeronautical Radio, Incorporated
ARQ	Automatic Repeat Request
AS	Access Stratum
ASK	Amplitude Shift Keying
ATC	Air Traffic Control
ATIS	Alliance for Telecommunications Industry Solutions
ATM	Asynchronous Transfer Mode
ATS	Air Traffic Services
B-AMC	Broadband Aeronautical Multicarrier Communications
BC	broadcast
BCCH	Broadcast Control Channel
BE	Best Effort
BEP	Block Encryption Protocol
BER	Bit Error Rate
BLOS	Beyond Line of Sight
BNCH	Broadcast Network Channel
BPS	Bits Per Second
BPSK	Binary Phase Shift Keying
BS	Base Station
BSCH	Broadcast Synchronization Channel
BSS	Basic Service Set
B-VHF	Broadband VHF
C4FM	Constant Envelope 4-Level Frequency Modulation
CAVE	Cellular Authentication and Voice Encryption
C&C	Command and Control
CBC	Cipher Block Chaining
CBC-MAC	Cipher Block Chaining Message Authentication Code
CC	Common control

CCK	Common Cipher Key
CCM	Counter with CBC-MAC
CDMA	Code Division Multiple Access
CFB	Cipher Feedback
CGS	Closed Subscriber Group
CID	Connection Identifier
CINR	Carrier to Interference and Noise Ratio
CMEA	Cellular Message Encryption Algorithm (CMEA)
CNPC	Control and Non-Payload Communications
COCR	Communications Operating Concepts and Requirements
COS	Class of Service
CQI	Channel Quality Indicator
CQPSK	Compatible Quadrature Phase Shift Keying
C-RNTI	Cell Radio Network Temporary Identifier
CSMA	Carrier Sense Multiple Access
CSMA/CA	Carrier Sense Multiple Access with Collision Avoidance
CSG	Closed Subscriber Group
CSGID	Closed Subscriber Group ID
CTS	Clear to Send
DC	Dedicated control
DCD	Downlink Channel Descriptor
DCK	Derived Cipher Key
DECT	Digital Enhanced Cordless Telecommunications
DES	Data Encryption Standard
DFS	Dynamic Frequency Selection
DHCP	Dynamic Host Configuration Protocol
DIMRS	Digital Integrated Mobile Radio System
DL	downlink
DL-MAP	Downlink map
DLR	German Aerospace Center (Deutsches Zentrum für Luft- und Raumfahrt)
DMO	Direct Mode Operation
DPC	Dynamic Power Control
DQPSK	Differential QPSK
DSC-REQ	Dynamic service change request
DSSS	Direct-sequence spread spectrum
ECB	Encryption Codebook
EDACS	Enhanced Digital Access Communications System
EDGE	Enhanced Data Rates for GSM Evolution
EEA	EPS Encryption Algorithm
EIA	EPS Integrity Algorithm
EPS	Evolved Packet System
ERT-VR	Real-Time Variable-Rate
ESN	Electronic Serial Number
ESS	Extended Service Set
E-TDMA	Enhanced TDMA
ETSI	European Telecommunications Standards Institute

EV-DO	Evolution – Data Optimized
EV-DV	Evolution – Data and Voice
FAA	Federal Aviation Administration
FAACH	Forward Access Assignment Channel
FCS	Future Communications Study
FDD	Frequency Division Multiplexing
FDMA	Frequency Division Multiple Access
FIPS	Federal Information Processing Standard
FL	Forward link
FLASH-OFDM	Fast Low-latency Access with Seamless Handoff – Orthogonal Frequency Division Multiplexing
FNE	Fixed Network Equipment
GCS	Ground Control Station
GEA	GPRS Encryption Algorithm
GFSK	Gaussian Frequency Shift Keying
GMSK	Gaussian Minimum Shift Keying
GNSS	Global Navigation Satellite System
GPRS	General Packet Radio Service
GPS	Global Positioning System
GRC	Glenn Research Center
GSM	Global System for Mobile communications
HARQ	Hybrid ARQ
HC-SDMA	High Capacity – Spatial Division Multiple Access
HDLC	High-Level Data Link Control
HF	High Frequency
HFDL	HF Data Link
HIPERLAN	High Performance Radio Local Area Network
HIPERMAN	High Performance Radio Metropolitan Area Network
HIPERPAN	High Performance Radio Personal Area Network
HMAC	Hash-based Message Authentication Code
HSDPA	High Speed Data Packet Access
ICAO	International Civil Aviation Organization
IC2DL	Interoperable Command and Control Data Link
ID	Identifier
IDEN	Integrated Digital Enhanced Network
IDRA	Integrated Dispatch Radio System
IEEE	Institute of Electrical and Electronic Engineers
IETF	Internet Engineering Task Force
IMS	IP-based network architecture
IOTA	Isotropic Orthogonal Transform Algorithm
IP	Internet Protocol
IPv4	Internet Protocol version 4
IPv6	Internet Protocol version 6
ITAR	International Traffic in Arms Regulations
LA	Location Area
LAN	Local Area Network

L-DACS	L-Band Digital Aeronautical Communications System
L-DACS 1	L-Band Aeronautical Communications System Type 1
L-DACS 2	L-Band Aeronautical Communications System Type2
LLC	Log on section
LOS	Line of Sight
LPI/LPD	Low-Probability-of-Intercept/Low-Probability-of-Detection
LRA	Local Registration Area
LTE	Long-Term Evolution
MAC	Medium Access Control
MAC	Message Authentication Code
MASPS	Minimum Aviation System Performance Standard
MCCH	Main Control Channel
MIB	Master Information Block
MID	Mobile Identification Number
MIMO	Multiple Input-Multiple Output
MLE	Mobile Link Entity
MM	Mobility Management
MME	Mobile Management Entity
MR	Mobile Radio
MRC	Mobile Routing Control
M/S	Modeling and Simulation
MS	Mobile Station
MTU	Maximum Transmission Unit
NAC	Network Access Code
NAS	National Airspace System
NASA	National Aeronautics and Space Administration
NATO	North Atlantic Treaty Organization
NAV	Network Allocation Vector
NIST	National Institute of Standards and Technology
NRT-VR	Non-Real Time Variable-Rate
NSAPI	Network Layer Service Identifier
OFB	Output Feedback
OFDM	Orthogonal Frequency Division Multiplexing
P-25	Project 25
P-34	Project 34
PA	Power Amplifier
PAN	Personal Area Network
PAPR	Peak-to-Average Power Ratio
PDCCH	Physical Downlink Control Channel
PDCH	Packet Data Channel
PDCP	Packet Data Convergence Protocol
PDP	Packet Data Protocol
PKI	Public Key Infrastructure
PKM	Privacy Key Management
PLMN	Public Land Mobile Network
PN	Pseudorandom Noise

PS	Physical Slots
PSK	Phase Shift Keying
QAM	Quadrature Amplitude Modulation
QCI	Quality Class Identifiers
QoS	Quality of Service
QPSK	Quadrature Phase Shift Keying
RA	Registration Area
RA	Random Access
RAACH	Reverse Access Assignment Channel
RACH	Random Access Channel
RAP	Random Access Procedures
RAN	Radio Access Network
RF	Radio Frequency
RFC	Request For Comment
RFSS	Radio Frequency Subsystem
RL	Reverse link
RLC	Radio Link Control
RNG-REQ	Range request
RNG-RSP	Range response
RRC	Radio Resource Control
RSSI	Received Signal Strength Indicator
RTS	Request to Send
RT-VR	Real-Time Variable-Rate
SAC	Subscriber Access Code
SAIC	Single Antenna Interference Cancellation
SAM	Scalable Adaptive Modulation
SBC-REQ	Subscriber basic capabilities request
SC	Single Carrier
SC-FDMA	Single Carrier FDMA
SCH	Shared Channel
SCK	Static Cipher Key
SFID	Service Flow Identifier
SFN	Single frequency network
SHA	Secure Hash Algorithm
SIBs	System Information Blocks
SICH	Slot Information Channel
SINR	Signal to Interference plus Noise Ratio
SIR	Signal-to-Interference
SME	Subject Matter Expert
SNDCP	Sub-Network Dependent Convergence Protocol
SNR	Signal to Noise Ratio
SON	Self Organizing Network
SS	Subscriber Station
SSCH	Slot Signaling Channel
SSR	Secondary Surveillance Radar
SSTG	Subscriber Station Transition Gap

STANAG	Standardization Agreement
STDMA	Self-organizing TDMA
SUID	Subscriber Unit Identifier
SWAP	Size, Weight and Power
SYS ID	System ID
TAPS	TETRA Advanced Packet Service
TBD	To be determined
TC-RNTI	Temporary C-RNTI
TD-CDMA	Time Division CDMA
TD-SCDMA	Time Division Synchronous CDMA
TDD	Time Division Duplexing
TDMA	Time Division Multiple Access
TEDS	TETRA Enhanced Data Service
TETRA	Terrestrial Trunked Radio
TETRAPOL	Terrestrial Trunked Radio Police
TIS-B	Traffic Information Service - Broadcast
TPC	Transmit Power Control
TRL	Technology Readiness Level
TTG	Transmit/receive Transmission Gap
TXOP	Transmission opportunities
UA	Unmanned Aircraft
UAS	Unmanned Aircraft Systems
UAT	Universal Access Transceiver
UCD	Uplink Channel Descriptor
UDP	User Datagram Protocol
UE	User Equipment
UGS	Unsolicited Grant Service
UL-MAP	Uplink map
UM	Unacknowledged Mode
UMTS	Universal Mobile Telecommunications System
UP	uplink
UP	User priority
UTC	Coordinated Universal Time
VDL	VHF Digital Link
VHF	Very High Frequency
VoIP	Voice over Internet Protocol
W-CDMA	Wideband CDMA
WACN	Wide Area Communications Network
WAI	Wideband Air Interface
WUID	Working Unit Identifier

Appendix B. References

- "Aircell Announces Technology Roadmap." Aircell Announces Technology Roadmap. Aircell, 9 March 2011. Web. 4 January 2012. <<http://www.aircell.com/press-room/aircell-announces-technology-roadmap>>.
- "HiperMAN / WiMAX Testing." *HiperMAN / WiMAX Testing*. ETSI, 2011. Web. 12 January 2012. <<http://www.etsi.org/WebSite/technologies/HiperMAN-WiMAXTesting.aspx>>.
- "KYOCERA to Introduce Updated USB Wireless Broadband Modem for iBurst™." *News*. KYOCERA Corporation, 9 July 2008. Web. 16 January 2012. <<http://global.kyocera.com/prdct/telecom/office/iburst/news/080709.html>>.
- "Project MESA - Mobile Broadband for Public Safety." *Project MESA - Mobile Broadband for Public Safety - Home Page*. Project MESA. Web. 14 December 2012. <<http://www.projectmesa.org/home.htm>>.
- "Specifications Download." Mobitex Technology. Mobitex Technology, 2004. Web. 14 December 2012. <http://www.mobitex.com/company/download_MIS.asp>.
- "TETRA Release 2." *TETRA + Critical Communications Association*. TETRA. Web. 14 December 2012. <<http://www.tetramou.com/about/page/12029>>.
- "Security Provisions in CDMA2000 Networks." Qualcomm, November 2011.
- Sofreavia ATM Department. "The E-TDMA Concept." RTCA SC-172. April 1998.
- Agilent Technologies. "Optimizing Your CDMA Wireless Network Today and Tomorrow Using Drive-Test Solutions Application Note-1345." April 2000.
- ANSI/TIA. *902.BAAB Wideband Air Interface; Scalable Adaptive Modulation (SAM); Physical Layer Specification – Public Safety Wideband Data Standards Project – Digital Radio Technical Standards*. September 2003.
- ANSI/TIA. *902.BAAD Wideband Air Interface; Scalable Adaptive Modulation (SAM); Radio Channel Coding Specification – Public Safety Wideband Data Standards Project – Digital Radio Technical Standards*. December 2008.
- ANSI/TIA/EIA. *102.AAAA Project 25 DES Encryption Protocol*. February 2001.
- ANSI/TIA/EIA. *102.AAAD Project 25 Block Encryption Protocol*. July 2002.
- ANSI/TIA/EIA. *102.AABB Project 25 Trunking Control Channel Formats*. May 2000.
- ANSI/TIA/EIA. *102.BAAA Project 25 FDMA Common Air Interface*. May 1998.
- ANSI/TIA/EIA. *102.BAEA Project 25 Data Overview*. March 2000.

ANSI/TIA/EIA. *102.BAEB Project 25 Packet Data Specification*. March 2000.

ANSI/TIA/EIA. *102.BAEE Project 25 Radio Control Protocol (RCP)*. March 2000.

ANSI/TIA/EIA. *902.BAAC Wideband Air Interface; Media Access Control; Radio Link Adaptation (MAC/RLA) Layer Specification*. February 2007.

ANSI/TIA/EIA. *902.BAAE Wideband Air Interface – Logical Link Control (LLC) Layer Specification*. February 2007.

ANSI/TIA/EIA. *902.BAAF Wideband Air Interface – Mobility Management (MM) Layer Specification; Public Safety Wideband Data Standards Project – Digital Radio Technical Standards*. January 2008.

ANSI/TIA/EIA. *902.BAEB Wideband Air Interface; Packet Data Specification; Public Safety Wideband Data Standards Project – Digital Radio Technical Standards*. January 2008.

ARINC. Rep. No. 635-4. *ARINC Specification 635-4, HF Data Link Protocols Specification*. December 2003.

Association of Radio Industries and Businesses (ARIB). *Integrated Radio Dispatch System; ARIB Standard; RCR-STD32A*. November 1995.

Chayer, Remi. “Tutorial of TDD systems – FCC Office of Engineering and Technology.” TDD Coalition. 3 December 2001.

Dahlman, Erik, Stefan Parkvall, and Johan Sköld. *4G LTE/LTE-Advanced for Mobile Broadband*. Amsterdam: Elsevier/Academic, 2011. Print.

ETSI. *ETSI EN 300 175-1 Digital Enhanced Cordless Telecommunications (DECT); Common Interface (CI); Part 1: Overview*. November 2008.

ETSI. *ETSI EN 300 175-2 Digital Enhanced Cordless Telecommunications (DECT); Common Interface (CI); Part 2: Physical Layer (PHL)*. June 2010.

ETSI. *ETSI EN 300 175-3 Digital Enhanced Cordless Telecommunications (DECT); Common Interface (CI); Part 3: Medium Access Control (MAC) layer*. December 2011.

ETSI. *ETSI EN 300 175-4 Digital Enhanced Cordless Telecommunications (DECT); Common Interface (CI); Part 4: Data Link Control (DLC) layer*. December 2011.

ETSI. *ETSI EN 300 392-1 Terrestrial Trunked Radio (TETRA); Voice plus Data (V+D); Part 1: General network design*. January 2009.

ETSI. *ETSI EN 300 392-2 Terrestrial Trunked Radio (TETRA); Voice plus Data (V+D); Part 2: Air Interface (AI)*. August 2008.

ETSI. *ETSI EN 300 392-7 Terrestrial Trunked Radio (TETRA); Voice plus Data (V+D); Part 7: Security*. June 2006.

- ETSI. *ETSI TR 101 976 Terrestrial Trunked Radio (TETRA); Guide to TETRA Advanced Packet Service (TAPS)*. July 2001.
- ETSI. *ETSI TS 101 493-1 Broadband Radio Access Networks (BRAN); HIPERLAN Type 2; Packet based Convergence Layer; Part 1: Common Part*. April 2000.
- ETSI. *ETSI TS 101 493-2 Broadband Radio Access Networks (BRAN); HIPERLAN Type 2; Packet based Convergence Layer; Part 2: Ethernet Service Specific Convergence Sublayer (SSCS)*. December 2001.
- ETSI. *ETSI TS 101 761-1 Broadband Radio Access Networks (BRAN); HIPERLAN Type 2; Data Link Control (DLC) Layer; Part 1: Basic Data Transport Functions*. December 2001.
- ETSI. *ETSI TS 101 761-2 Broadband Radio Access Networks (BRAN); HIPERLAN Type 2; Data Link Control (DLC) Layer; Part 2: Radio Link Control (RLC) Sublayer*. January 2002.
- ETSI. *ETSI TS 123 107 Digital cellular telecommunications system (Phase 2+); Universal Mobile Telecommunications System (UMTS); LTE; Quality of Service (QoS) concept and architecture (3GPP TS 23.107 version 10.2.0 Release 10)*. January 2012.
- ETSI. *ETSI TS 125 101 Universal Mobile Telecommunications System (UMTS); User Equipment (UE) radio transmission and reception (FDD) (3GPP TS 25.101 version 10.4.0 Release 10)*. January 2012.
- ETSI. *ETSI TS 125 123 Universal Mobile Telecommunications System (UMTS); Requirements for support of radio resource management (TDD) (3GPP TS 25.123 version 10.2.0 Release 10)*. July 2011.
- ETSI. *ETSI TS 125 133 Universal Mobile Telecommunications System (UMTS); Requirements for support of radio resource management (FDD) (3GPP TS 25.133 version 10.3.0 Release 10)*. October 2011.
- ETSI. *ETSI TS 125 201 Universal Mobile Telecommunications System (UMTS); Physical layer - general description (3GPP TS 25.201 version 10.0.0 Release 10)*. April 2011.
- ETSI. *ETSI TS 125 211 Universal Mobile Telecommunications System (UMTS); Physical channels and mapping of transport channels onto physical channels (FDD) (3GPP TS 25.211 version 10.0.0 Release 10)*. May 2011.
- ETSI. *ETSI TS 125 221 Universal Mobile Telecommunications System (UMTS); Physical channels and mapping of transport channels onto physical channels (TDD) (3GPP TS 25.221 version 10.2.0 Release 10)*. January 2012.
- ETSI. *ETSI TS 125 301 Universal Mobile Telecommunications System (UMTS); Radio interface protocol architecture (3GPP TS 25.301 version 10.0.0 Release 10)*. March 2011.
- ETSI. *ETSI TS 125 321 Universal Mobile Telecommunications System (UMTS); Medium Access Control (MAC) protocol specification (3GPP TS 25.321 version 10.5.0 Release 10)*. January 2012.
- ETSI. *ETSI TS 125 331 Universal Mobile Telecommunications System (UMTS); Radio Resource Control (RRC); Protocol specification (3GPP TS 25.331 version 10.5.0 Release 10)*. November 2011.

- ETSI. *ETSI TS 136 104 LTE; Evolved Universal Terrestrial Radio Access (E-UTRA); Base Station (BS) radio transmission and reception (3GPP TS 36.104 version 8.4.0 Release 8)*. January 2009.
- ETSI. *ETSI TS 136 133 LTE; Evolved Universal Terrestrial Radio Access (E-UTRA); Requirements for support of radio resource management (3GPP TS 36.133 version 8.17.0 Release 8)*. April 2012.
- ETSI. *ETSI TS 136 211 LTE; Evolved Universal Terrestrial Radio Access (E-UTRA); Physical channels and modulation (3GPP TS 36.211 version 8.9.0 Release 8)*. January 2010.
- ETSI. *ETSI TS 136 321 LTE; Evolved Universal Terrestrial Radio Access (E-UTRA); Medium Access Control (MAC) protocol specification (3GPP TS 36.321 version 8.12.0 Release 8)*. March 2012.
- ETSI. *ETSI TS 136 322 LTE; Evolved Universal Terrestrial Radio Access (E-UTRA); Radio Link Control (RLC) protocol specification (3GPP TS 36.322 version 8.8.0 Release 8)*. July 2010.
- Eurocontrol. "Future Communications Infrastructure – Technology Investigations Description of AMACS." Eurocontrol, July 2007.
- Eurocontrol. "L-DACS1 System Definition Proposal: Deliverable D2." Eurocontrol, 13 February 2009.
- Eurocontrol. "L-DACS2 System Definition Proposal: Deliverable D2." Eurocontrol, 11 May 2009.
- Eurocontrol/FAA. *Communications Operating Concept and Requirements for the Future Radio System*. March 2006.
- ICAO. *Manual on Detailed Technical Specifications for the VDL Mode 4 Digital Link*. 11 October 2002.
- IEEE. "LAN/MAN Standards Committee of the IEEE Computer Society and IEEE Microwave Theory and Techniques Society." *Local and metropolitan area networks; Part 16: Air Interface for Broadband Wireless Access Systems; Amendment 3: Advanced Air Interface*. IEEE 802.16m IEEE-SA Standards Board. March 2011.
- IEEE. "LAN/MAN Standards Committee of the IEEE Computer Society and IEEE Microwave Theory and Techniques Society." *Local and metropolitan area networks; Part 16: Air Interface for Broadband Wireless Access Systems*. IEEE 802.16 IEEE 802.20, IEEE-SA Standards Board. May 2009.
- IEEE. "LAN/MAN Standards Committee of the IEEE Computer Society." *Local and metropolitan area networks; Part 20: Air Interface for Mobile Broadband Wireless Access Systems Supporting Vehicular Mobility—Physical and Media Access Control Layer Specification*. IEEE 802.20 IEEE-SA Standards Board. August 2008.
- IEEE. "LAN/MAN Standards Committee of the IEEE Computer Society." *Telecommunications and information exchange between systems— Local and metropolitan area networks— Specific requirements; Part 11: Wireless LAN Medium Access Control (MAC) and Physical Layer (PHY) Specifications*. IEEE 802.11 IEEE-SA Standards Board. March 2007.
- IEEE. "LAN/MAN Standards Committee of the IEEE Computer Society." *Telecommunications and information exchange between systems— Local and metropolitan area networks— Specific requirements; Part 11: Wireless LAN Medium Access Control (MAC) and Physical Layer (PHY)*

- Specifications; Amendment 5 Enhancements for Higher Throughput*. IEEE 802.11n IEEE-SA Standards Board. October 2009.
- IEEE. "LAN/MAN Standards Committee of the IEEE Computer Society." *Telecommunications and information exchange between systems— Local and metropolitan area networks— Specific requirements; Part 11: Wireless LAN Medium Access Control (MAC) and Physical Layer (PHY) Specifications; Amendment 3: 3650–3700 MHz Operation in USA*. IEEE 802.11y IEEE-SA Standards Board. September 2008.
- Langer, Johan and Larson, Gwenn. *CDMA2000 – A world view*. November 2001.
- McConnell, Vicki P. "Wireless Gatelink: Coming of Age." *Avionics Magazine*. Avionics Today, 1 July 2005. Web. 14 December 2012. <http://www.aviationtoday.com/av/issue/feature/Wireless-Gatelink-Coming-of-Age_996.html>.
- Myung, Hyung G. "Single Carrier FDMA." IEEE. 18 May 2008.
- NASA. *State of the Art Unmanned Aircraft System Communication Assessment*. Doc. No. PACE III-A2901-D15 rev2. NASA, February 2011.
- NASA. *Technology Assessment for the Future Aeronautical Communications Study*. Doc. No. CR 2005-213587. NASA, May 2005.
- NATO Standardization Agency STANAG 4660. *Interoperable Command and Control Data Link for Unmanned Systems (IC2DL)*. NATO Standardization Agency. October 2006.
- Rockwell Collins. *NASA Unmanned Aircraft (UA) Control and Non-Payload Communication (CNPC) System Waveform Trade Studies*. March 2012.
- RTCA Special Committee (SC) 203. *Terrestrial L-Band and C-Band Architectures for UAS Control and Non-Payload Communications*. RTCA, December 2010.
- RTCA Special Committee (SC) 203. *Throughput Requirements for Control and Non-Payload Communications of a Single Unmanned Aircraft*. RTCA, May 2009.
- Taha, Abd-Elhamid M., Hossam Hassanein, and Najah Abu Ali. *LTE, LTE-advanced and WiMAX: Towards IMT-advanced Networks*. Chichester, West Sussex: Wiley, 2012. Print.
- TETRAPOL Forum. *TETRAPOL Specifications; Part 1: General Network Design; Part 1: Reference Model*. November 1999.
- TETRAPOL Forum. *TETRAPOL Specifications; Part 1: General Network Design; Part 2: Voice and Data Services in Network and Direct Mode*. March 1998.
- TETRAPOL Forum. *TETRAPOL Specifications; Part 1: General Network Design; Part 3: General Mechanisms*. January 1998.
- TETRAPOL Forum. *TETRAPOL Specifications; Part 2: Radio Air Interface*. November 1998.

- TIA. *TSB-902.AAAA Wideband Data System Security Services –Overview Public Safety – Wideband Data Standards Project*. June 2009.
- TIA/EIA. *902.BBAB Wideband Air Interface Isotropic Orthogonal Transform Algorithm (IOTA) Physical Layer Specification; Public Safety Wideband Data Standards Project – Digital Radio Technical Standards*. March 2003.
- TIA/EIA. *902.BBAD Wideband Air Interface Isotropic Orthogonal Transform Algorithm (IOTA) Radio Channel Coding (CHC) Specification – Public Safety Wideband Data Standards Project – Digital Radio Technical Standards*. August 2003.
- TIA/EIA. *TSB102.BAAD APCO Project 25 Common Air Interface Operational Description for Conventional Channels*. October 1994.
- TIA/EIA. *TSB102-A APCO Project 25 System and Standards Definition*. November 1995.
- TIA/EIA. *TSB-902.A Digital Radio Technical Standards – Public Safety Wideband Data Standards Project – Wideband Data System and Standards Definition*. December 2001.
- TIA/EIA. *TSB-902.BAAA Wideband Air Interface (WAI) Overview – Public Safety Wideband Data Standards Project – Digital Radio Technical Standards*. May 2005.

