

MMOD Protection and Degradation Effects for Thermal Control Systems

Eric Christiansen

NASA Johnson Space Center

August 2014



Agenda

- **Micrometeoroid and orbital debris (MMOD) environment overview**
- **Hypervelocity impact effects & MMOD shielding**
- **MMOD risk assessment process**
- **Requirements & protection techniques**
 - ISS
 - Shuttle
 - Orion/Commercial Crew Vehicles
- **MMOD effects on spacecraft systems & improving MMOD protection**
 - Radiators
 - Coatings
 - Thermal protection system (TPS) for atmospheric entry vehicles
 - Coatings
 - Windows
 - Solar arrays
 - Solar array masts
 - EVA Handrails
 - Thermal Blankets

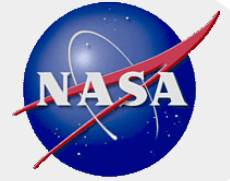

MMOD Environment Models

- **Orbital Debris provided by JSC & is the predominate threat in low Earth orbit**
 - ORDEM 3.0 is latest model (released December 2013)
 - <http://orbitaldebris.jsc.nasa.gov/>
 - Man-made objects in orbit about Earth impacting up to 16 km/s
 - average 9-10 km/s for ISS orbit
 - High-density debris (steel) is major issue
- **Meteoroid model provided by MSFC**
 - MEM-R2 is latest release
 - <http://www.nasa.gov/offices/meo/home/index.html>
 - Natural particles in orbit about sun
 - Mg-silicates, Ni-Fe, others
 - Meteoroid environment (MEM): 11-72 km/s
 - Average 22-23 km/s



MEM Environment for ISS

Speed Distributions by Surface, one month average, ISS

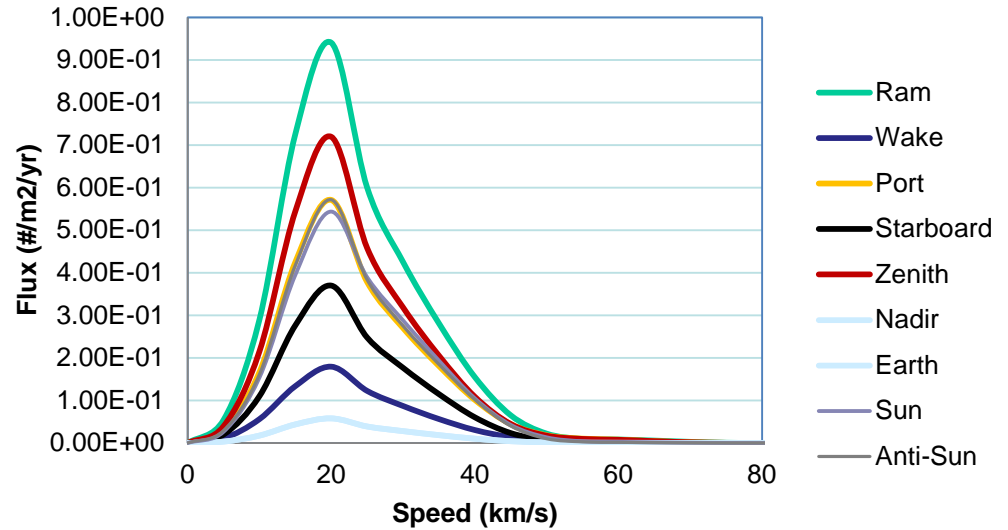
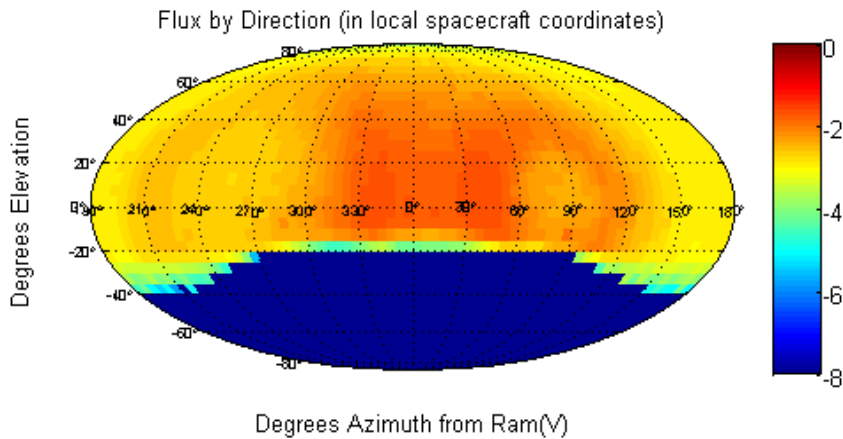

Total Flux on Spacecraft

Average of All States

Cross Sectional Flux 7.258269e+000 /m²/yr

	Ram	Wake	Port	Starboard	Zenith	Nadir	Earth	Sun	Anti-Sun
Average Speed (km/s)	22.8	23.3	23.5	22.7	22.8	23.2	23.2	23.2	23.4
Total Flux (#/m ² /yr)	3.586e+000	7.037e-001	2.211e+000	1.408e+000	2.694e+000	2.250e-001	2.251e-001	2.160e+000	2.181e+000

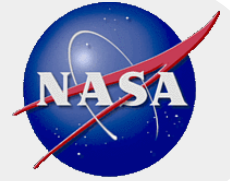

MMOD Environment Dynamics

- **Meteoroids consist of background sporadic flux (static), and streams from meteor showers (variable)**
 - Occasionally, showers can turn into storms
- **Orbital Debris changes as function of orbital altitude, the rate of on-orbit explosions & collisions, launch rate, atmospheric drag/solar activity and other factors**

400km altitude

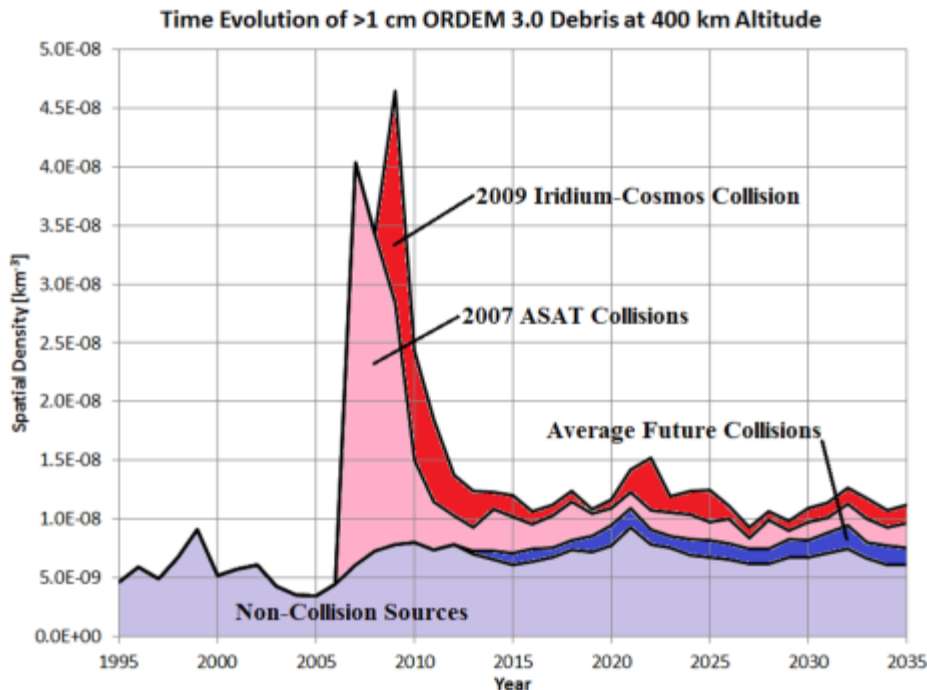

705km altitude

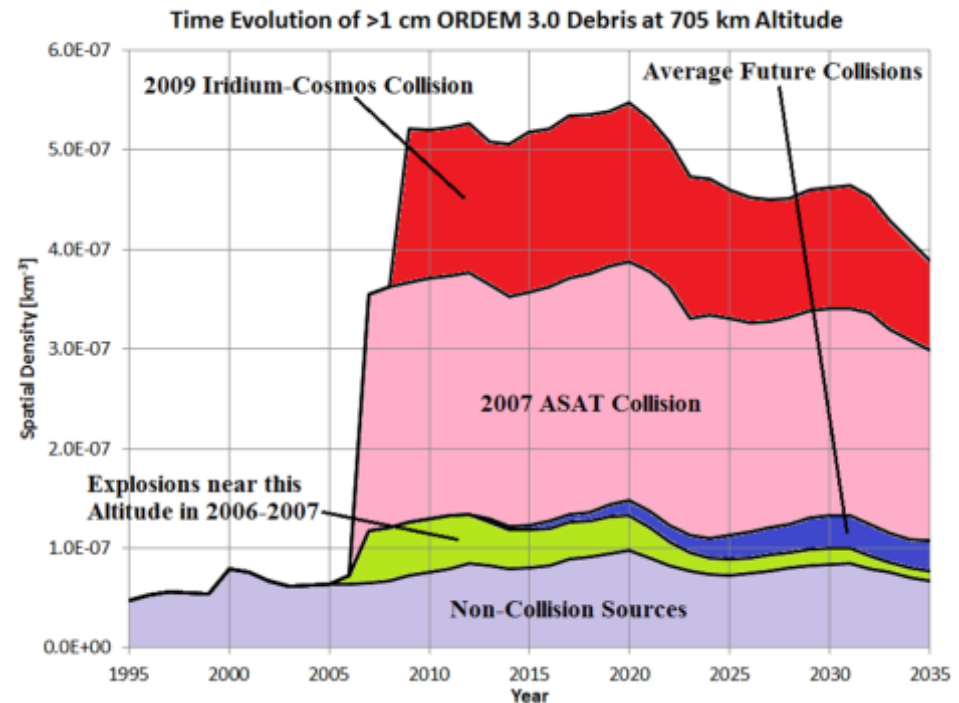

Note, Spatial Density is proportional to impact risk

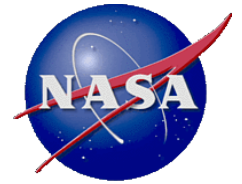

1960

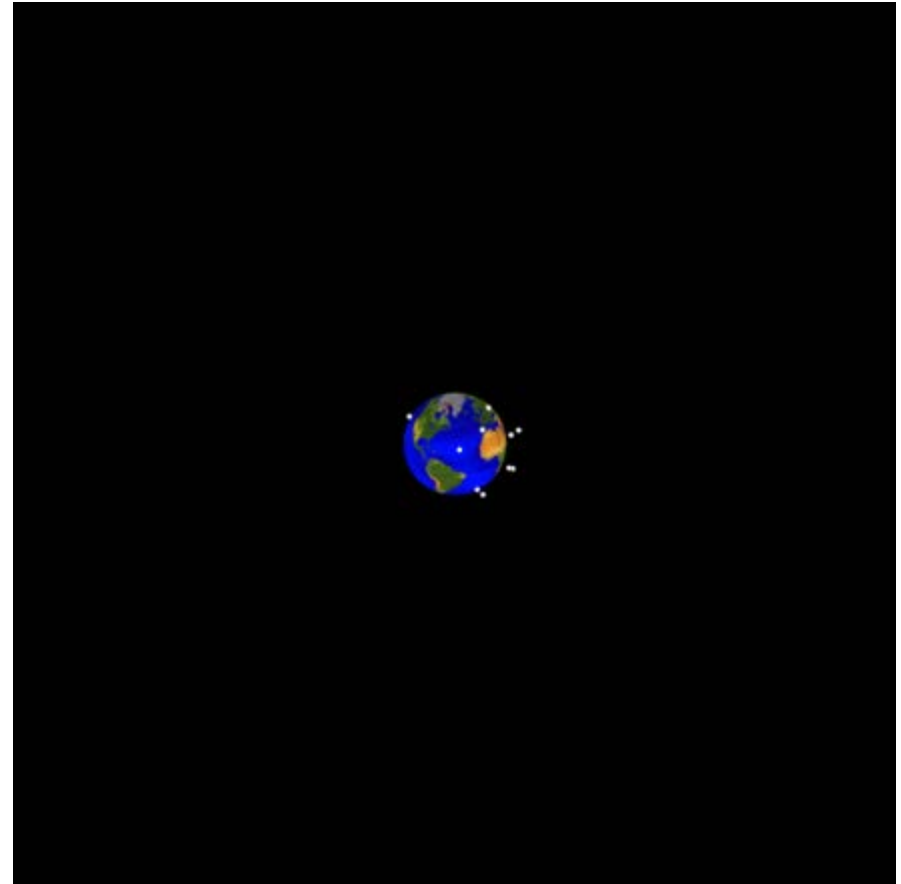
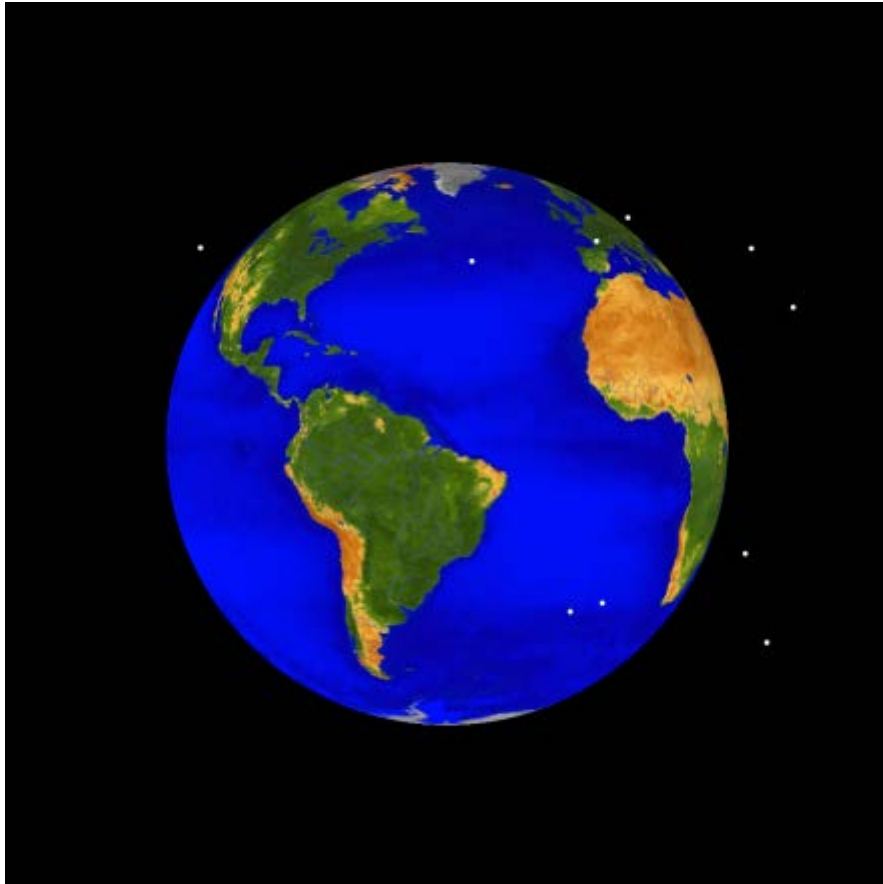

Cataloged objects >10 cm diameter

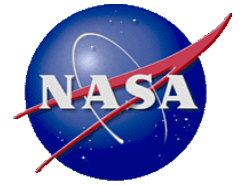

1970

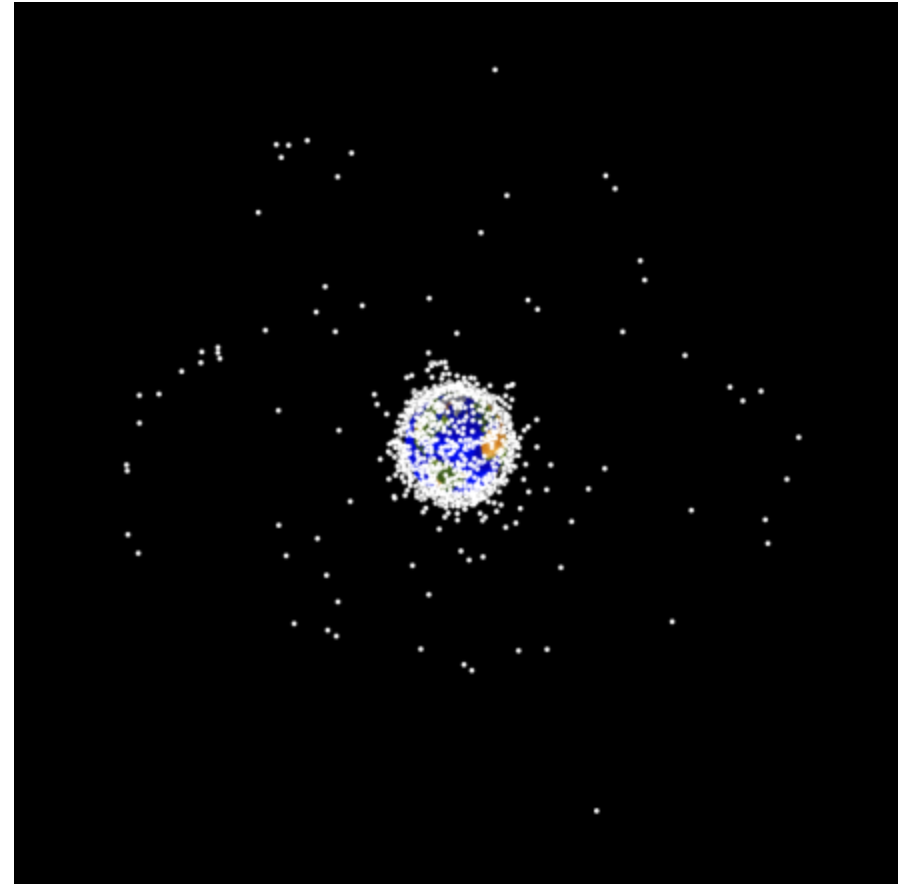
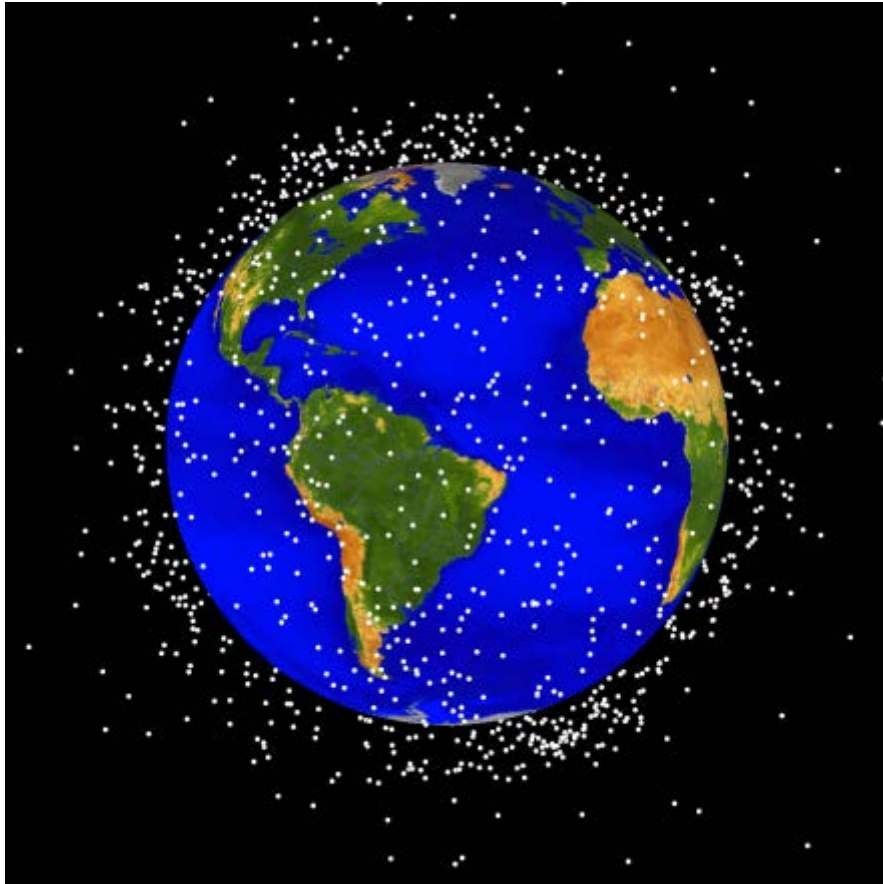

Cataloged objects >10 cm diameter

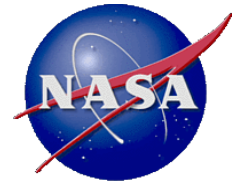

1980

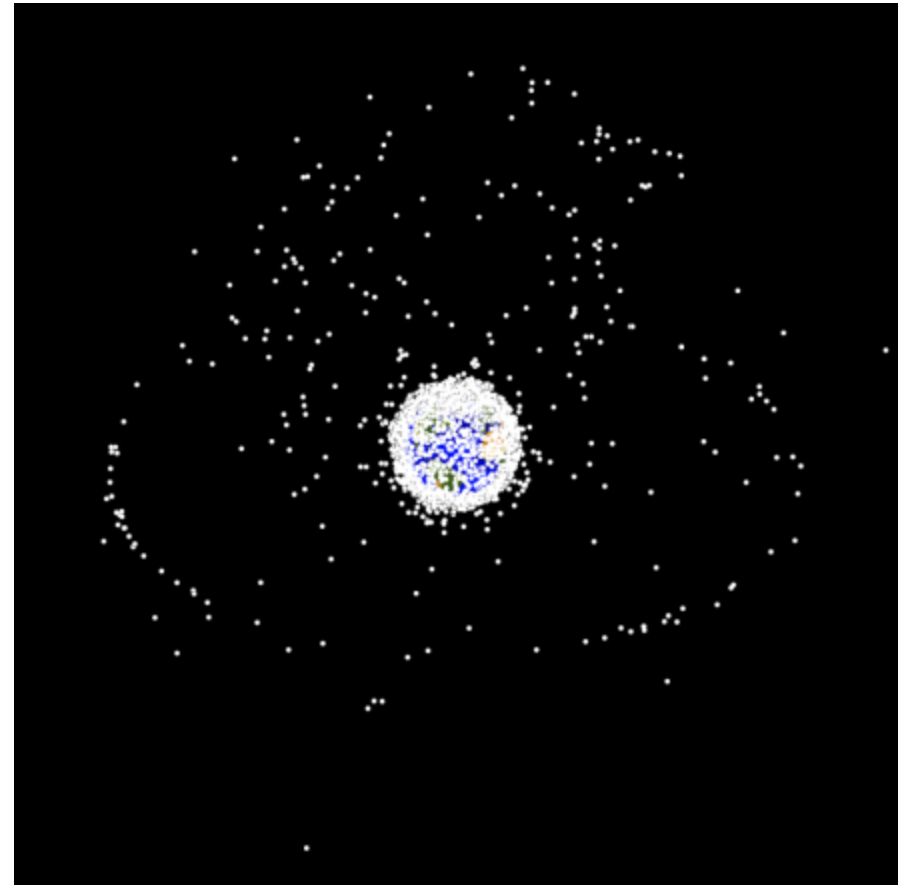
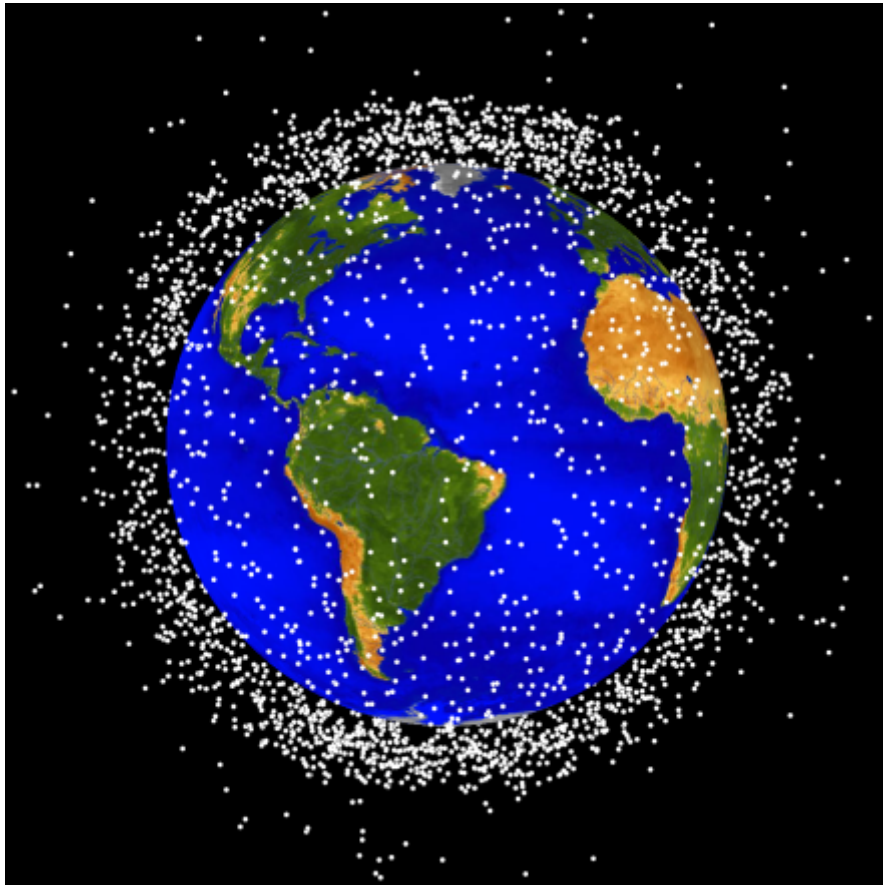

Cataloged objects >10 cm diameter

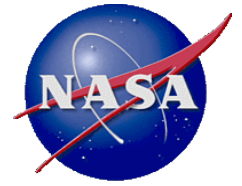

1990

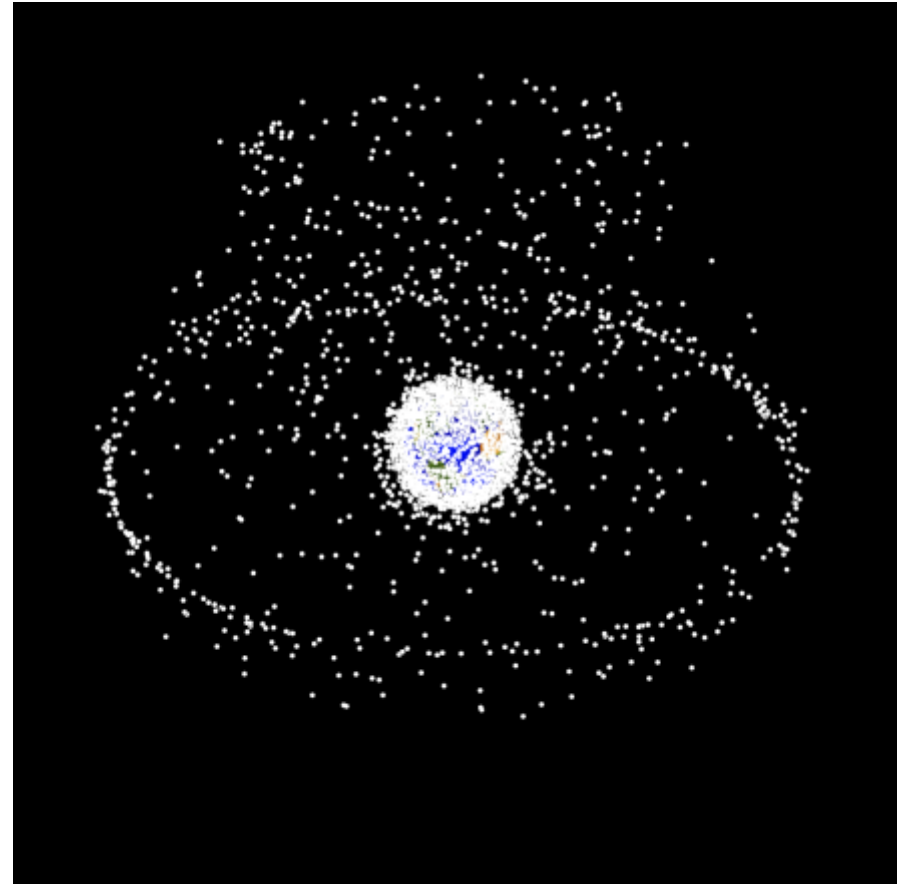
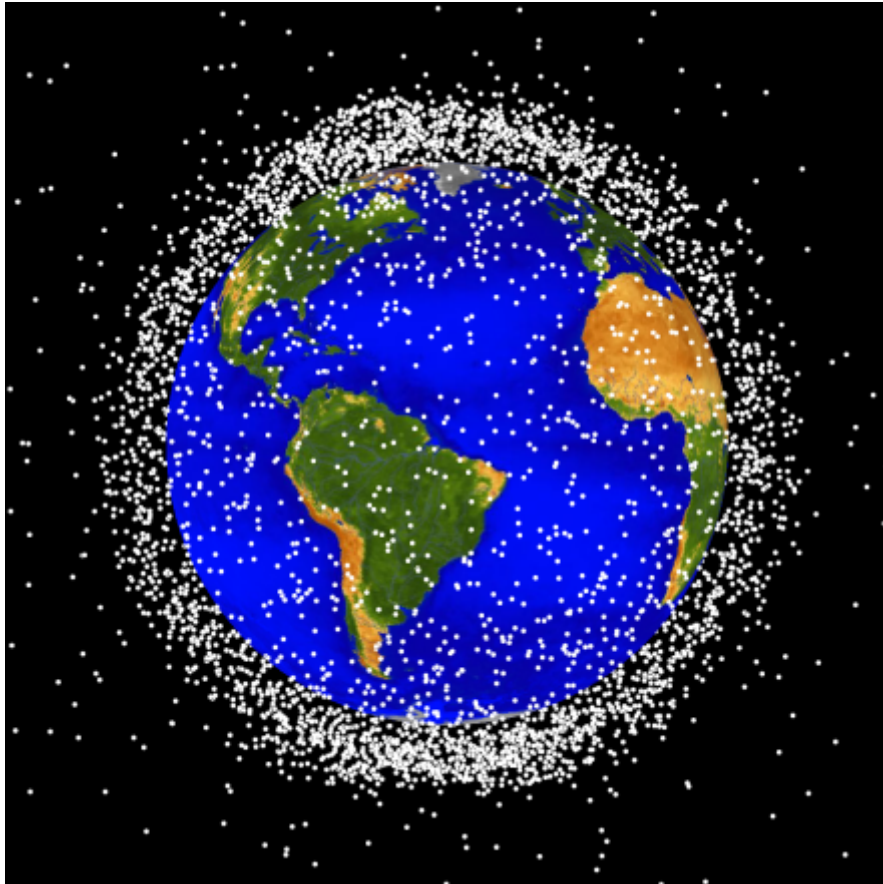

Cataloged objects >10 cm diameter

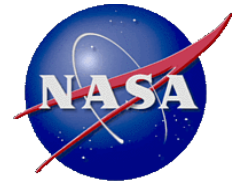

2000

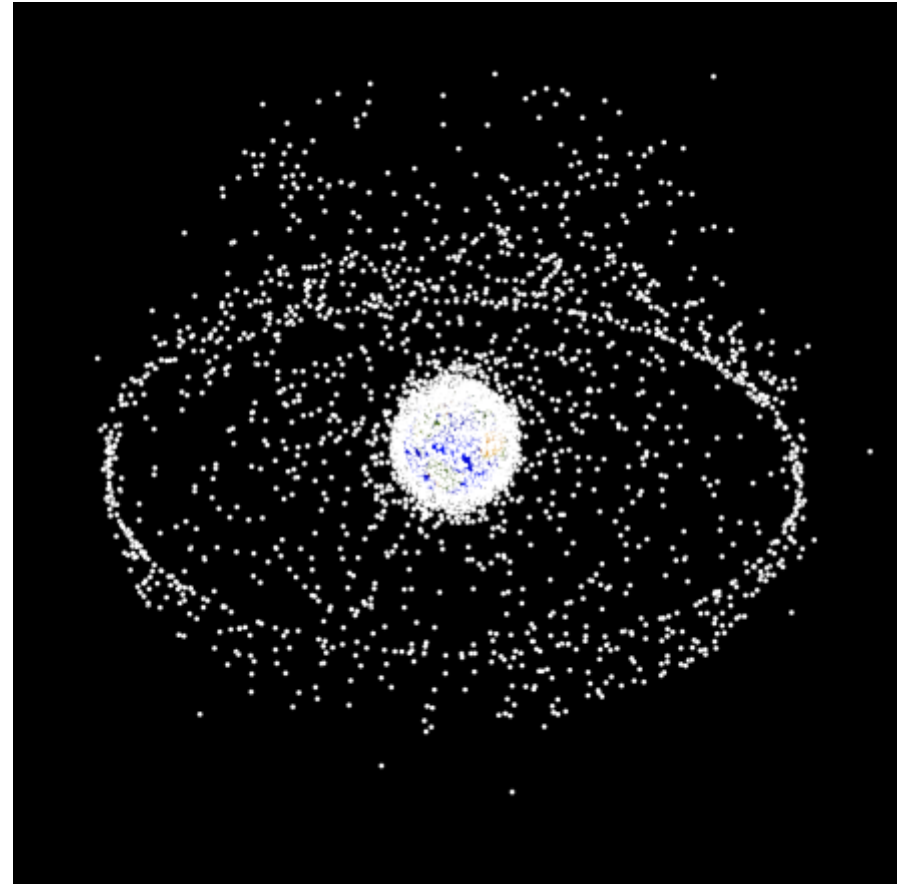
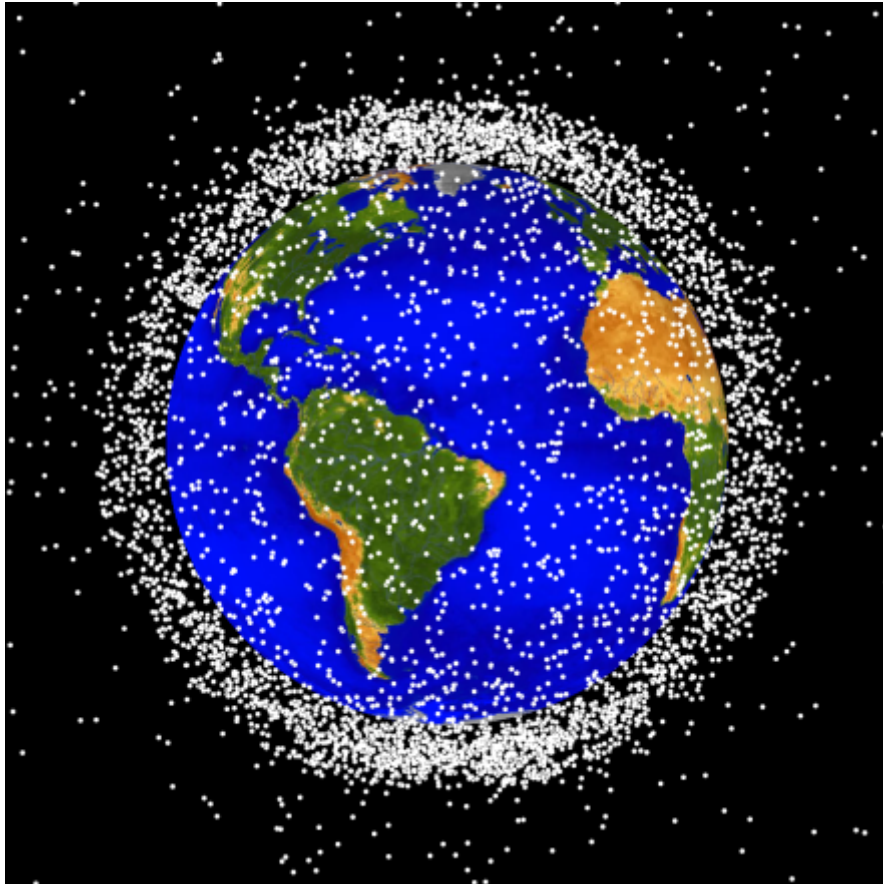

Cataloged objects >10 cm diameter

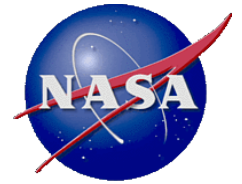

2010

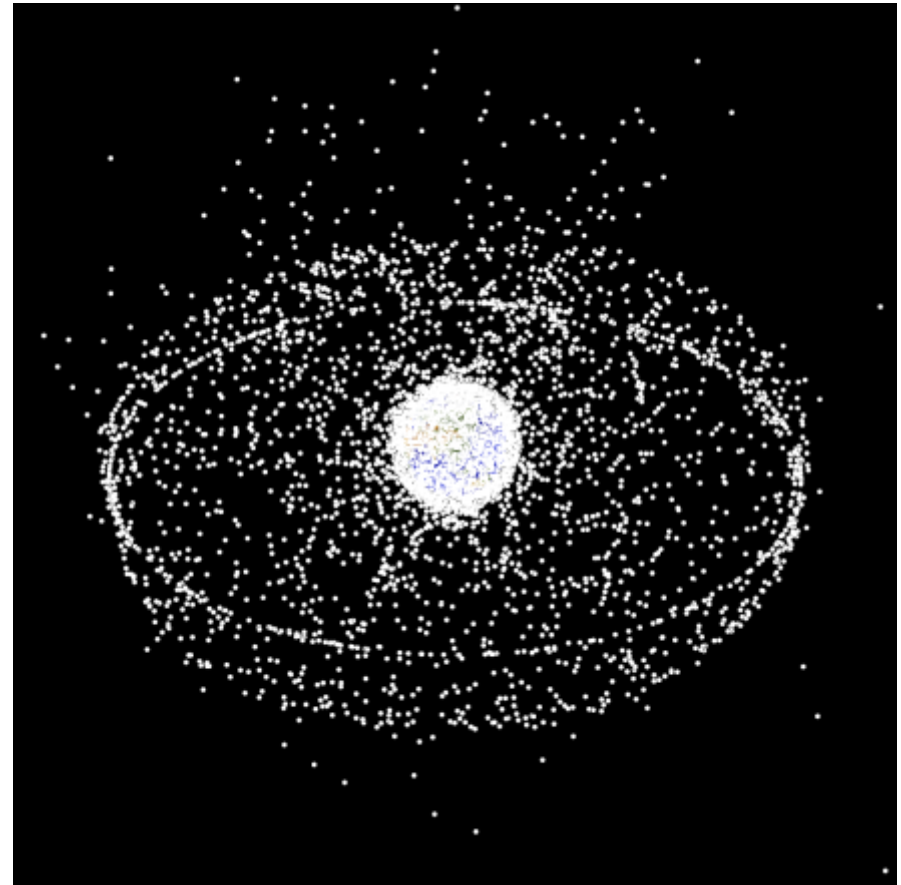
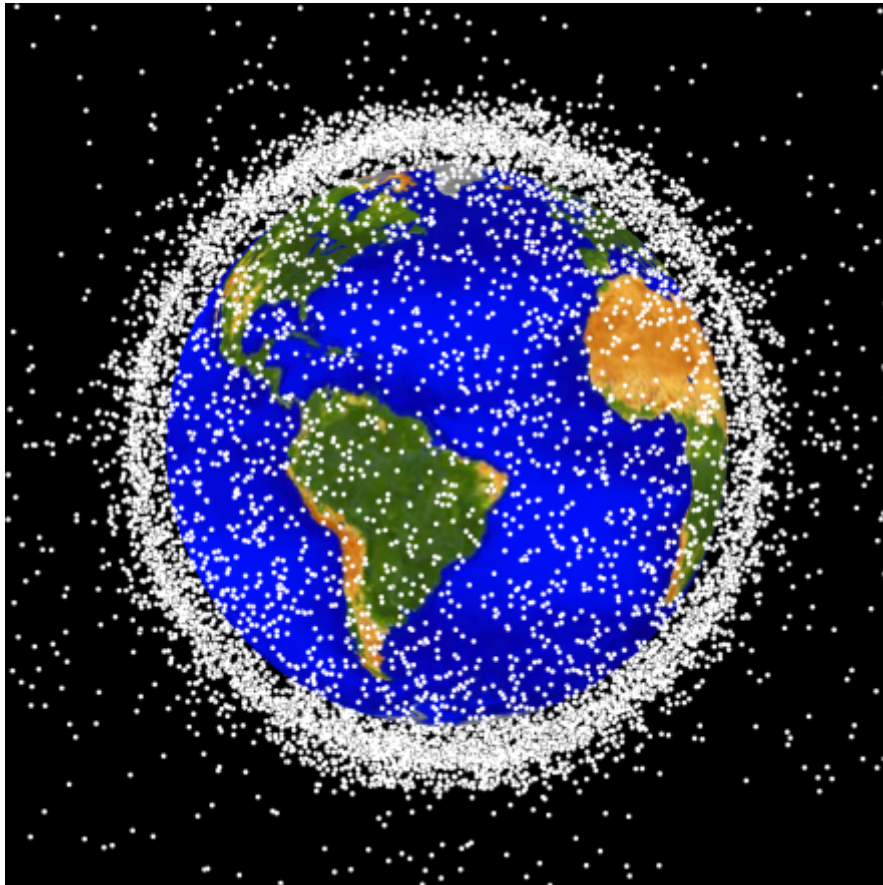

Cataloged objects >10 cm diameter

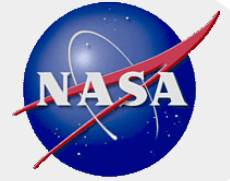

Debris movies

- Debris fly-through
- Iridium-Cosmos collision

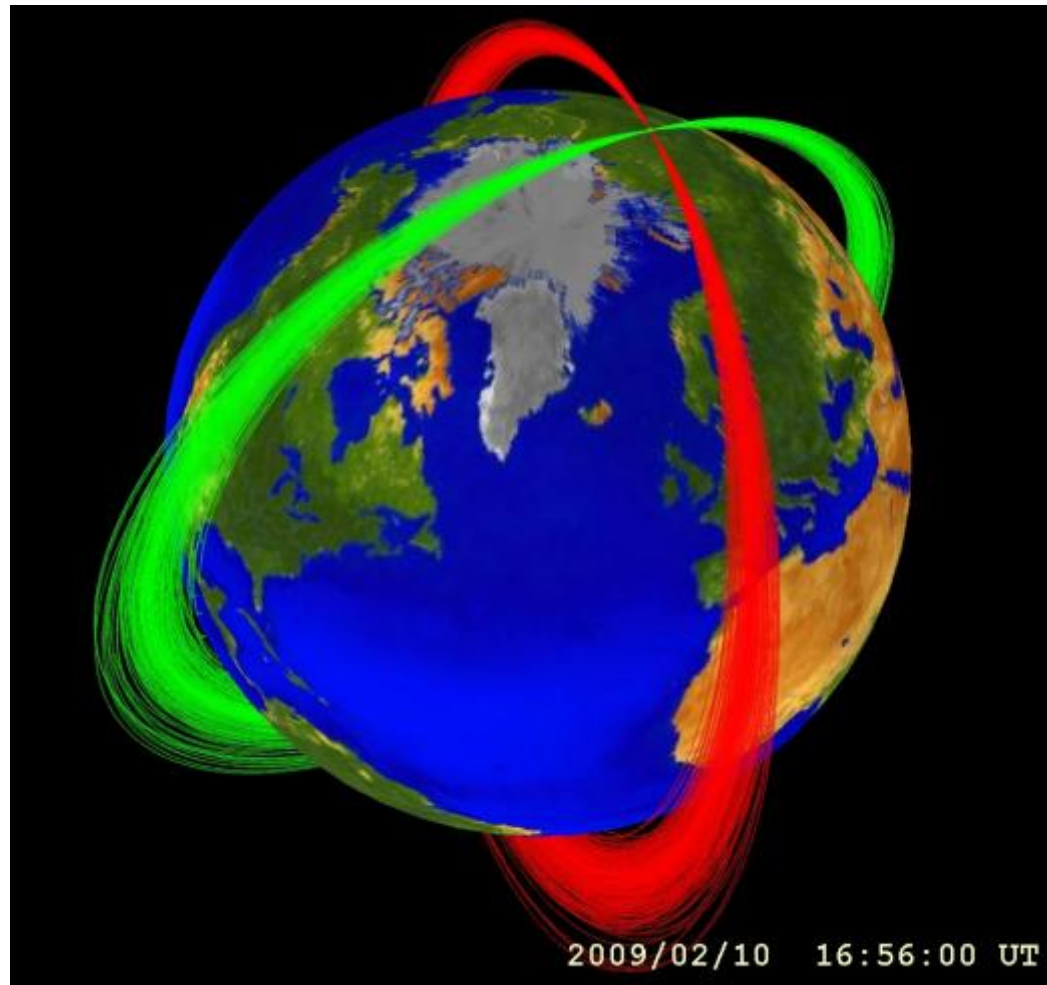

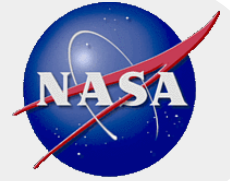

Orbital Debris Material Distributions - ISS

ORDEM Populations for 2013 ISS Flux as a Function of Debris Size

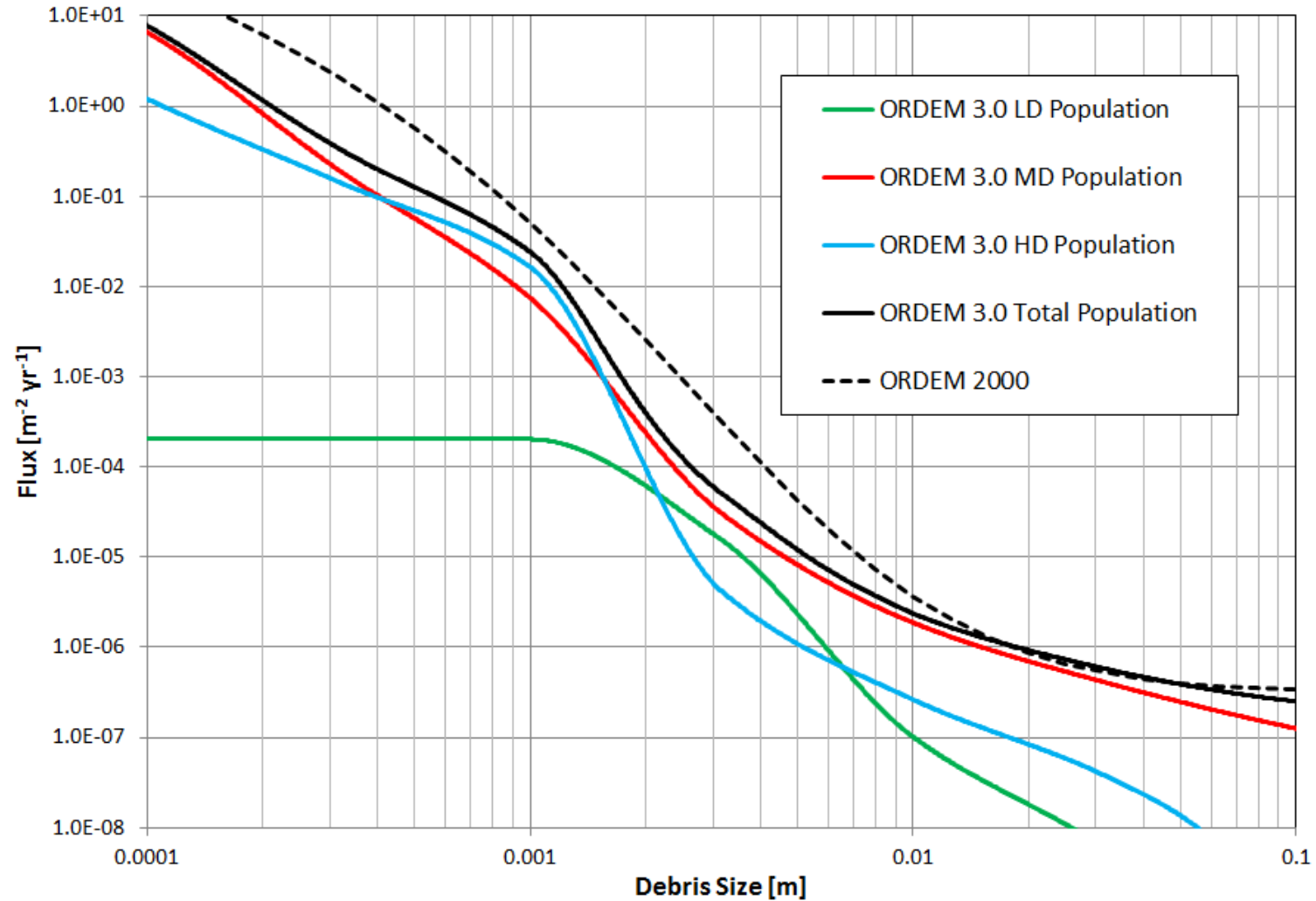

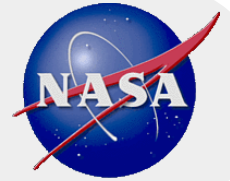

Growth of the Cataloged Populations

Monthly Number of Objects in Earth Orbit by Object Type

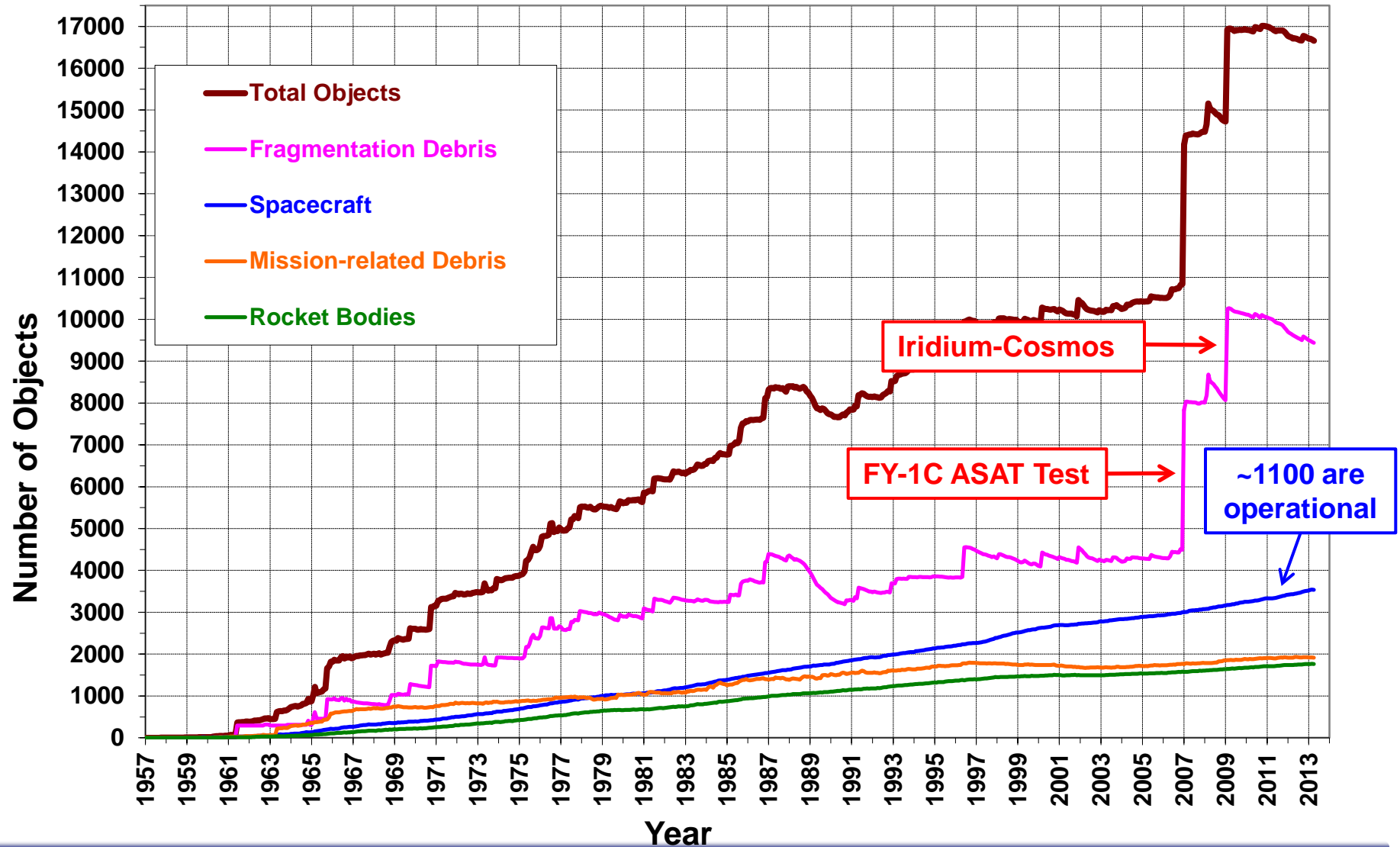



Mass in Space

Monthly Mass of Objects in Earth Orbit by Object Type

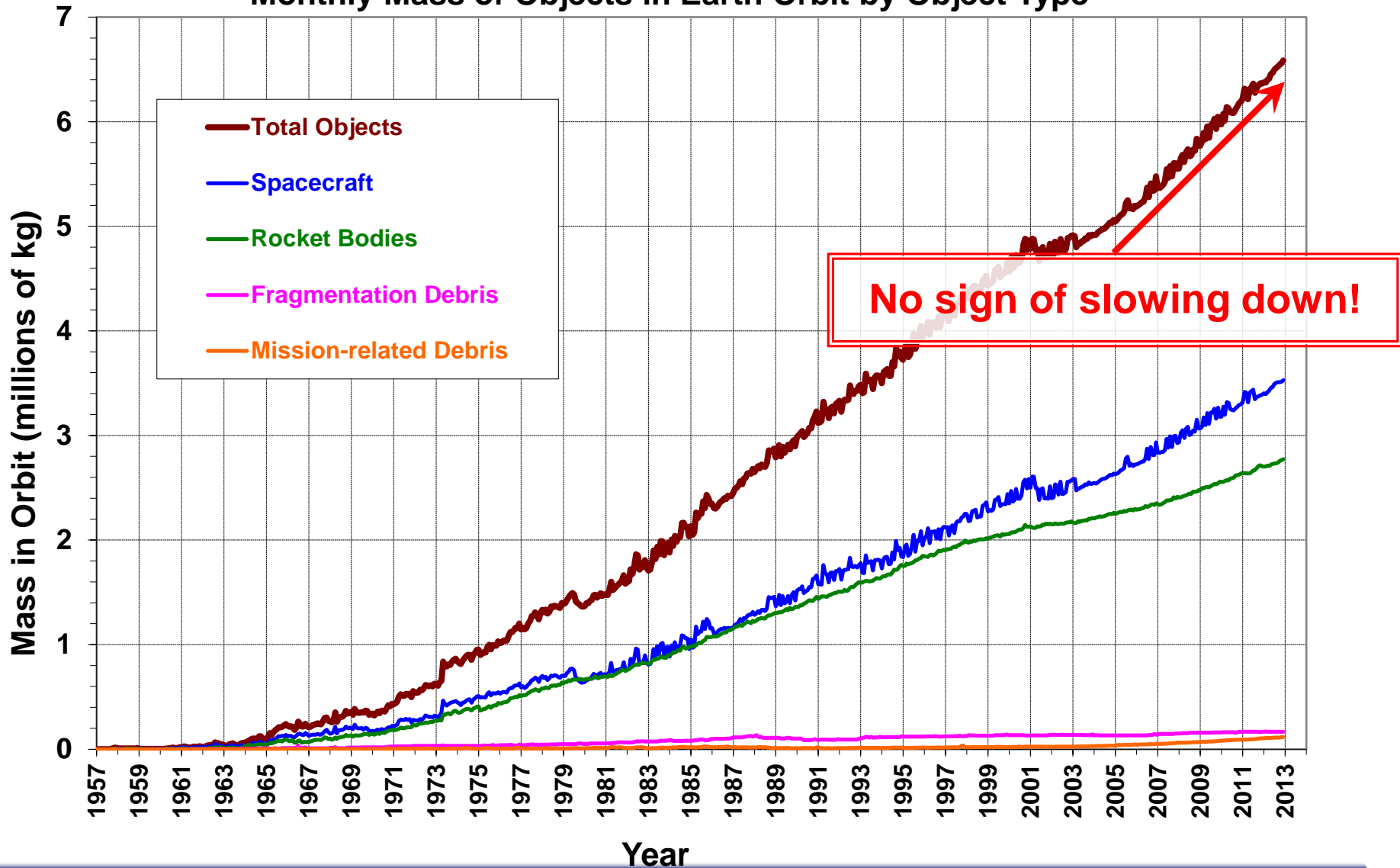



Long-Term Projection & the Kessler Syndrome

“The current debris population in the LEO region has reached the point where the environment is unstable and collisions will become the most dominant debris-generating mechanism in the future”

– Liou and Johnson, Science, 20 January 2006

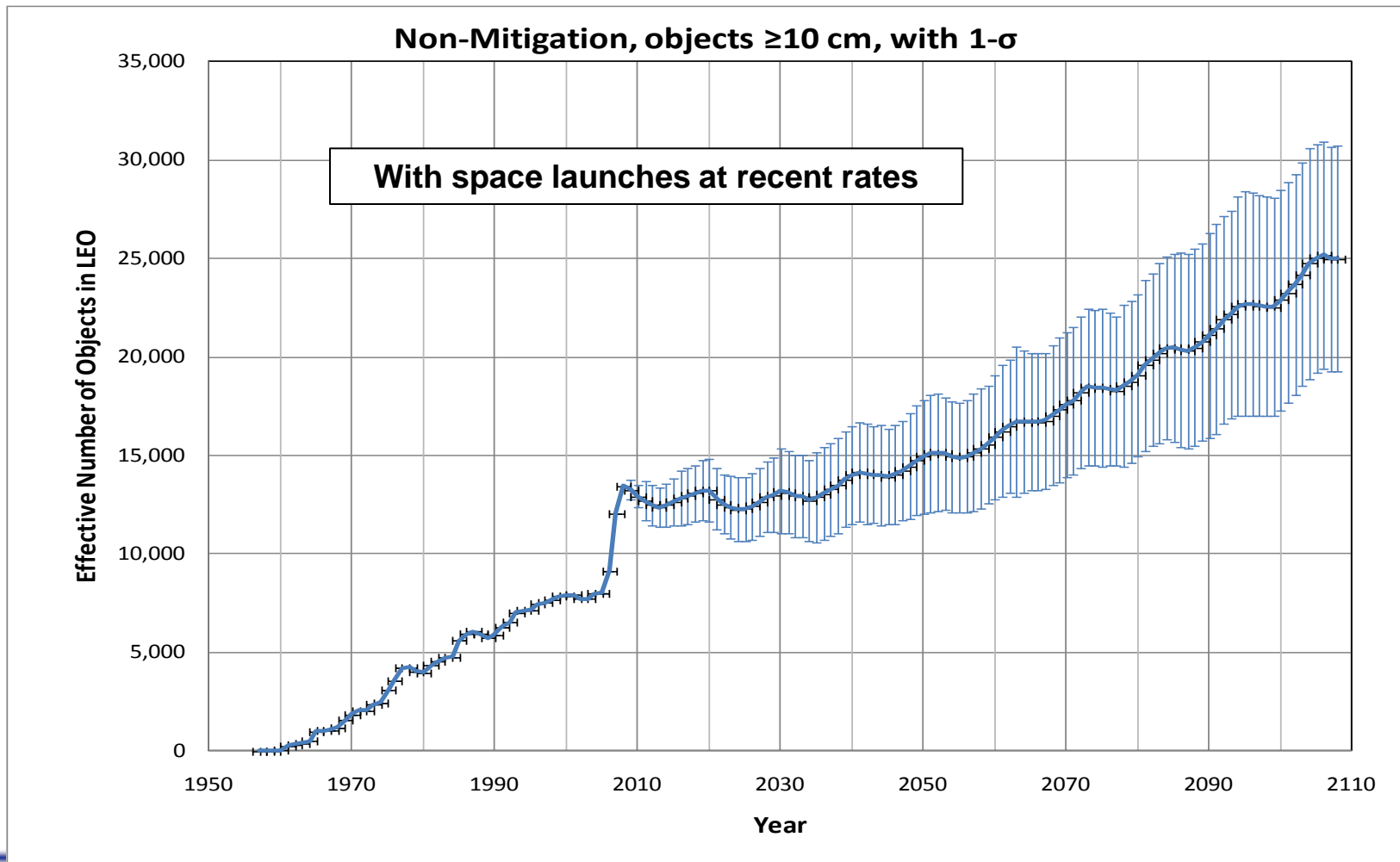



Agenda

- **Micrometeoroid and orbital debris (MMOD) environment overview**
- **Hypervelocity impact effects & MMOD shielding**
- **MMOD risk assessment process**
- **Requirements & protection techniques**
 - ISS
 - Shuttle
 - Orion/Commercial Crew Vehicles
- **MMOD effects on spacecraft systems & improving MMOD protection**
 - Radiators
 - Coatings
 - Thermal protection system (TPS) for atmospheric entry vehicles
 - Coatings
 - Windows
 - Solar arrays
 - Solar array masts
 - EVA Handrails
 - Thermal Blankets

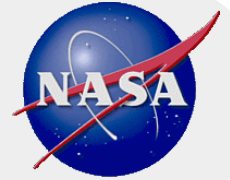

Hypervelocity impact effects

- **Even small MMOD impacts can cause a lot of damage**
 - Hypervelocity MMOD impacts represent a substantial threat to spacecraft
 - Rule of thumb: at 7km/s, aluminum sphere can penetrate completely through an aluminum plate 4x the sphere's diameter
 - A multi-layer spaced shield provides more effective protection from hypervelocity impact than single layer

Comparison of size of projectile to size of impact crater

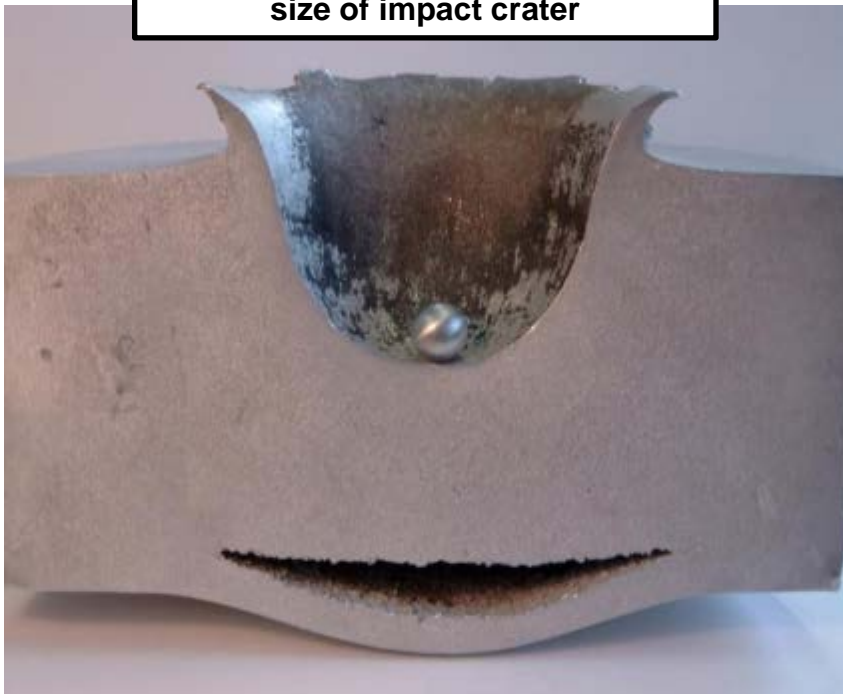

Damage from a 1.3cm diameter sphere at 7km/s

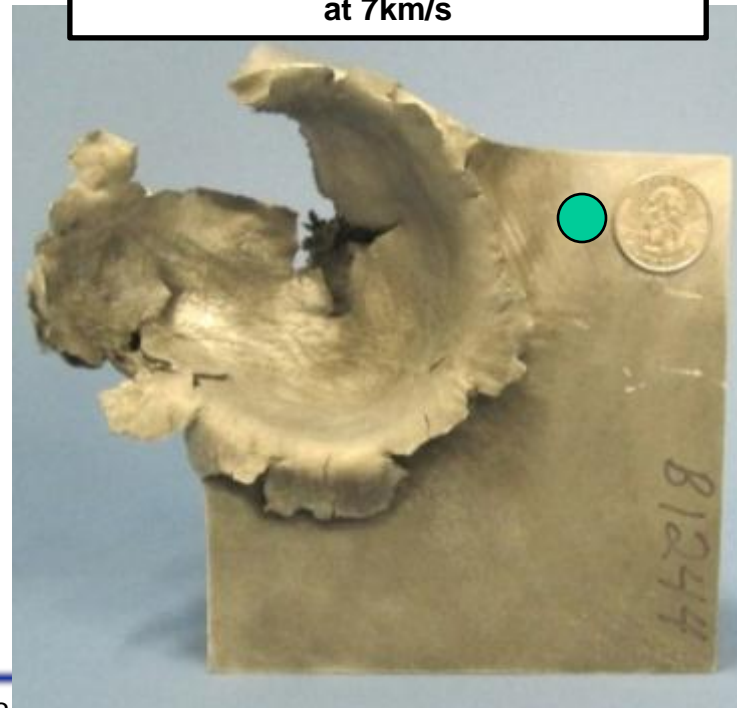

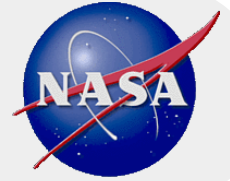

MMOD Shielding

- **Several types of shielding applied to spacecraft MMOD protection**
 - Whipple shields
 - Nextel/Kevlar “Stuffed Whipple” shields
 - Multi-Shock shields
- **Protection performance characterized by impact tests, simulations**
 - Defined by “ballistic limit” equations (BLEs)

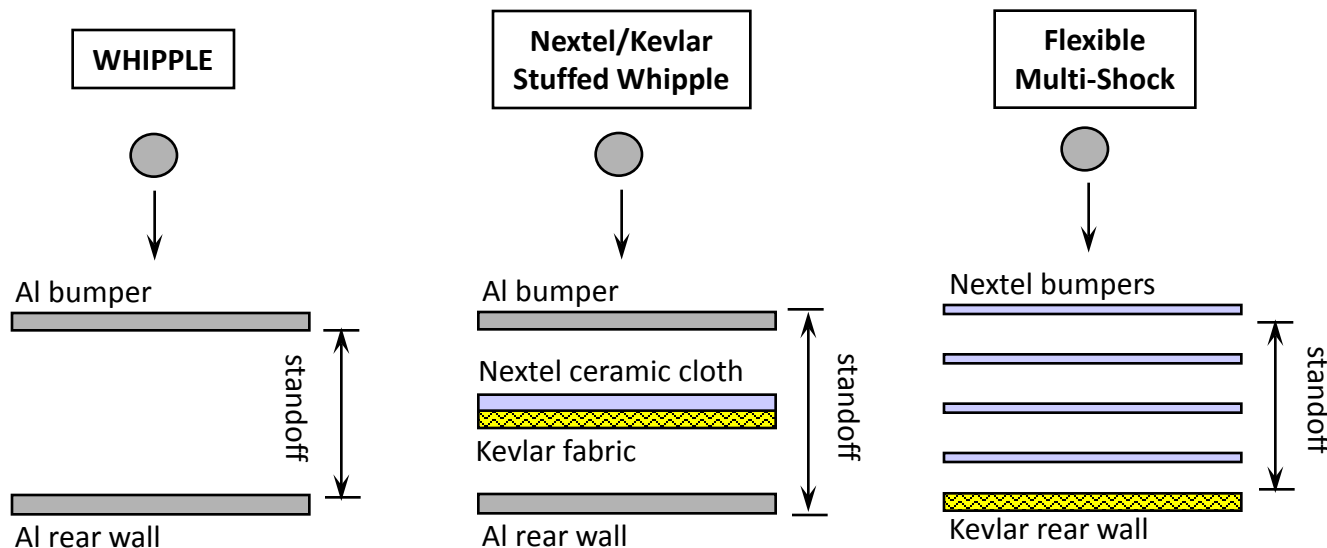

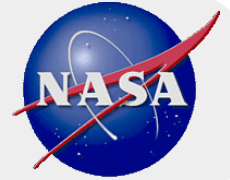

Monolithic versus Stuffed Whipple Shield Weight Comparison of Equal-Performance Shielding

Aluminum "Monolith" Shield 29.1 pounds per square foot

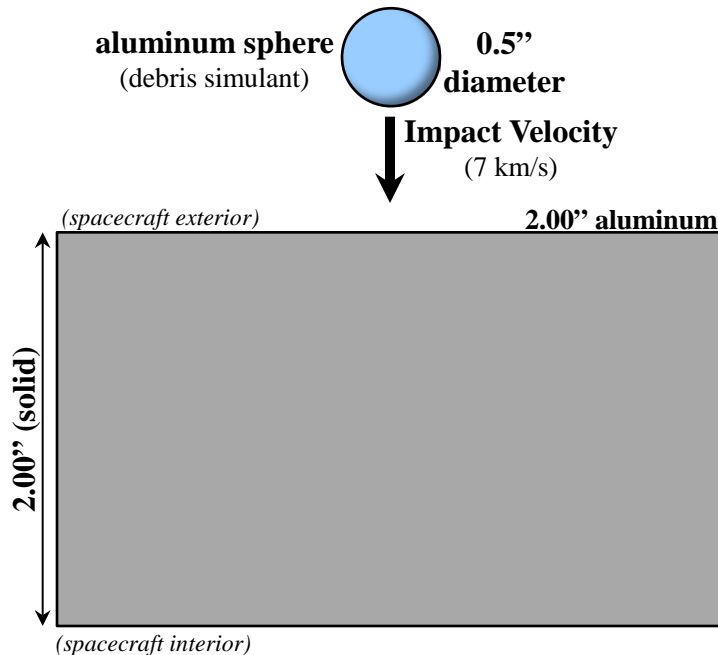

Stuffed Whipple Shield 4.5 pounds per square foot

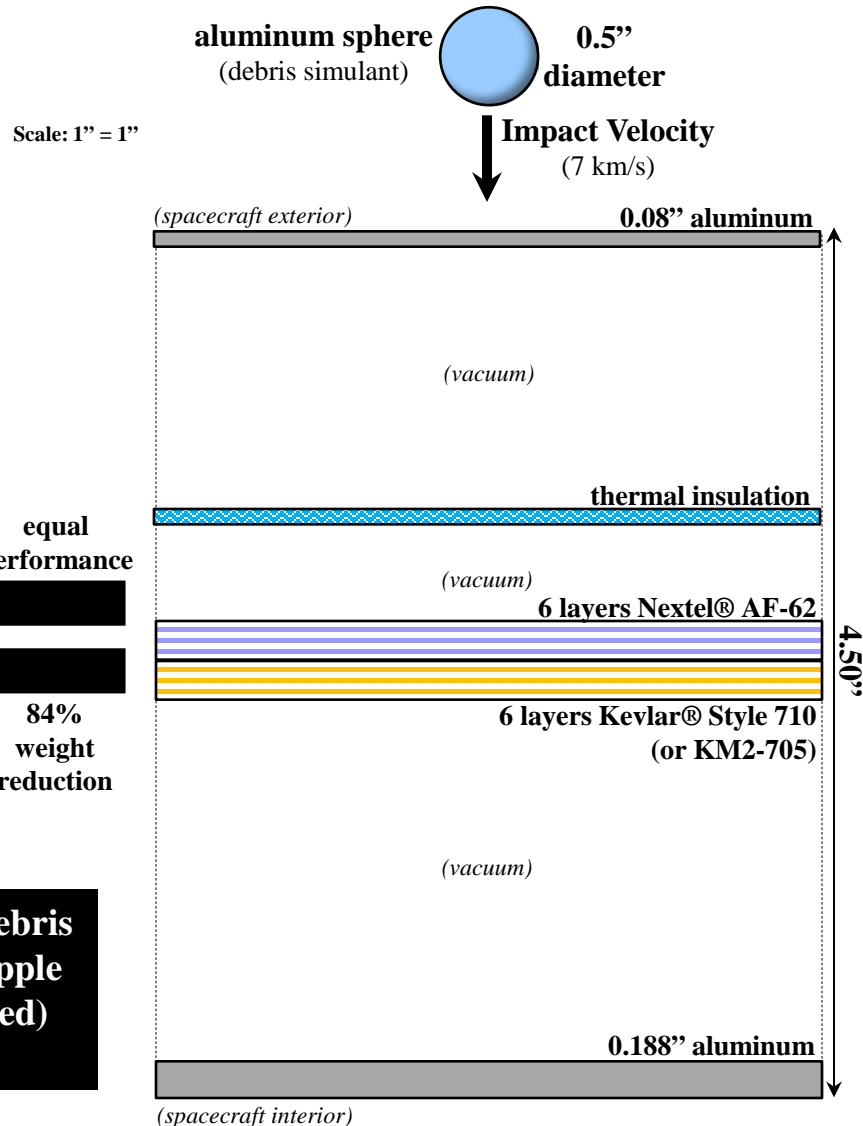

These shields can stop a 0.5" diameter aluminum debris projectile impacting at 7km/s, but the Stuffed Whipple shield weighs 84% less (94% if rear wall is excluded) and costs much less to launch to orbit

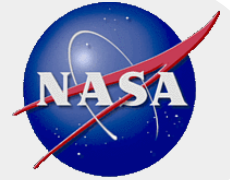

MMOD shielding background

- **MMOD shields typical composed of bumper(s), standoff, and rear wall (final protection layer)**
 - Exclude multi-layer insulation (MLI) thermal blanket

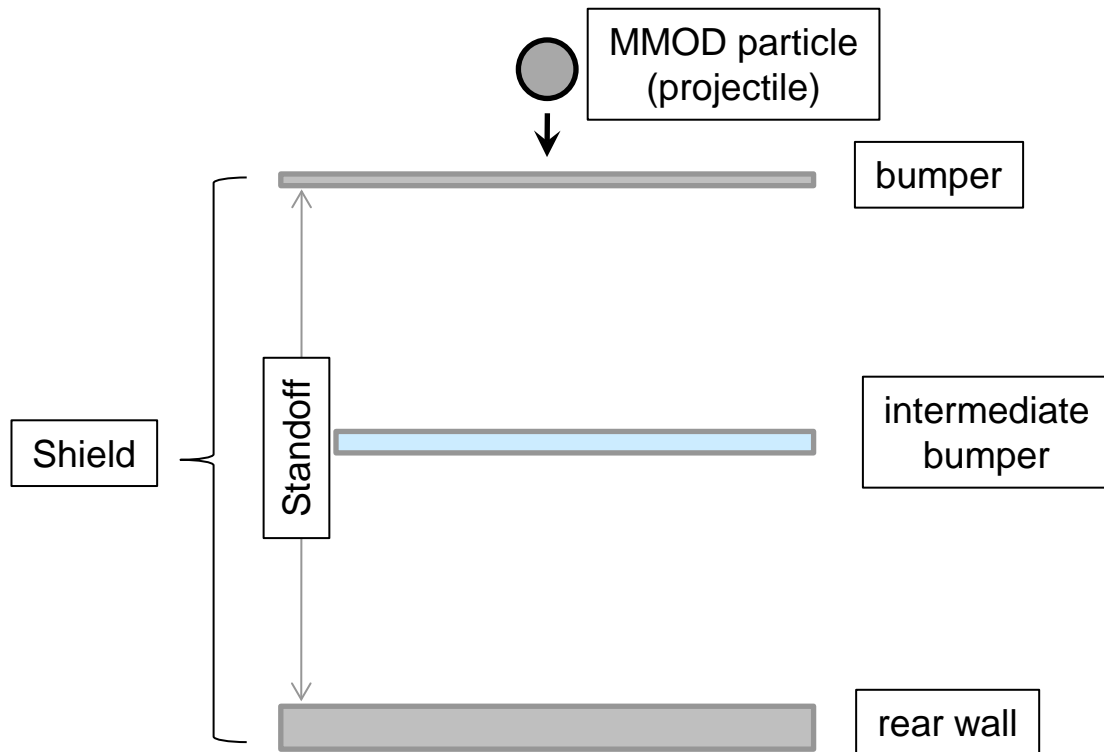

Purpose: Breakup MMOD particle, laterally disperse resulting debris

Key material & physical parameters ($V \geq 7$ km/s): density, thickness to projectile diameter ratio, thermal properties

Purpose: Further breakup debris from first impact, slow expansion of debris cloud

Key material & physical parameters ($V \geq 7$ km/s): combination of first bumper and rear wall properties

Purpose: Stop debris from MMOD & bumper(s)

Key material & physical parameters ($V \geq 7$ km/s): strength, toughness, thickness

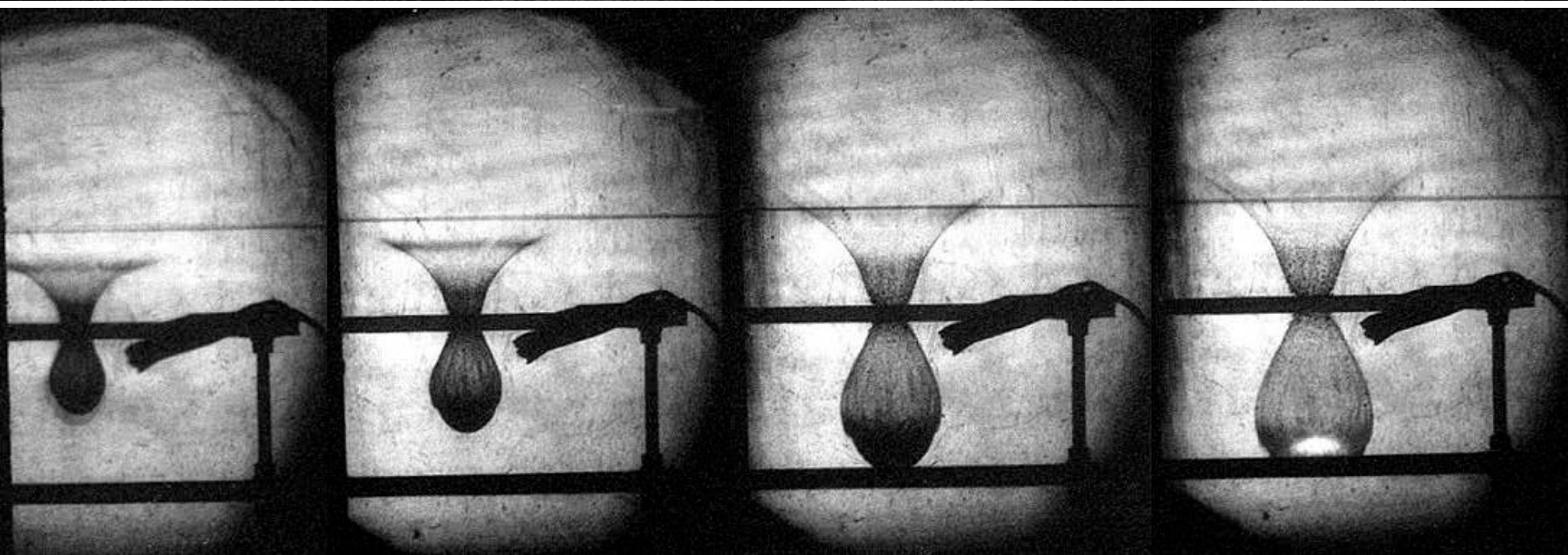
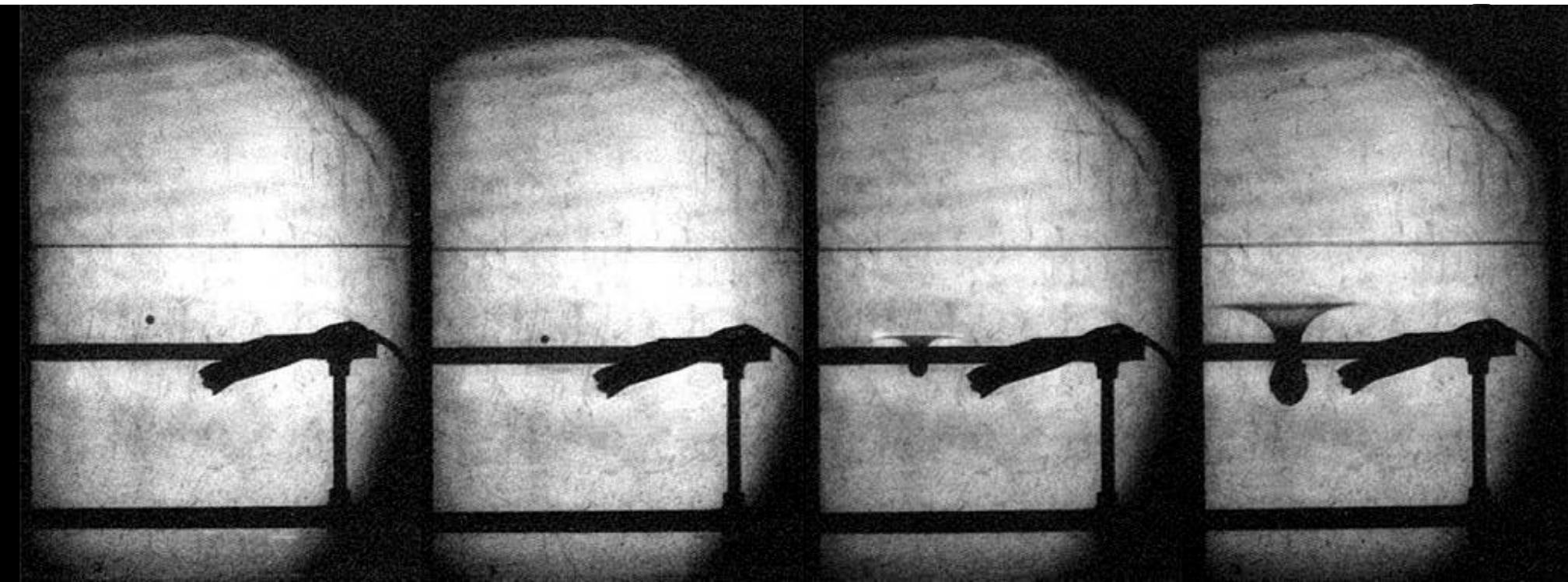

Ballistic Limits for Whipple Shield & equal mass Monolithic

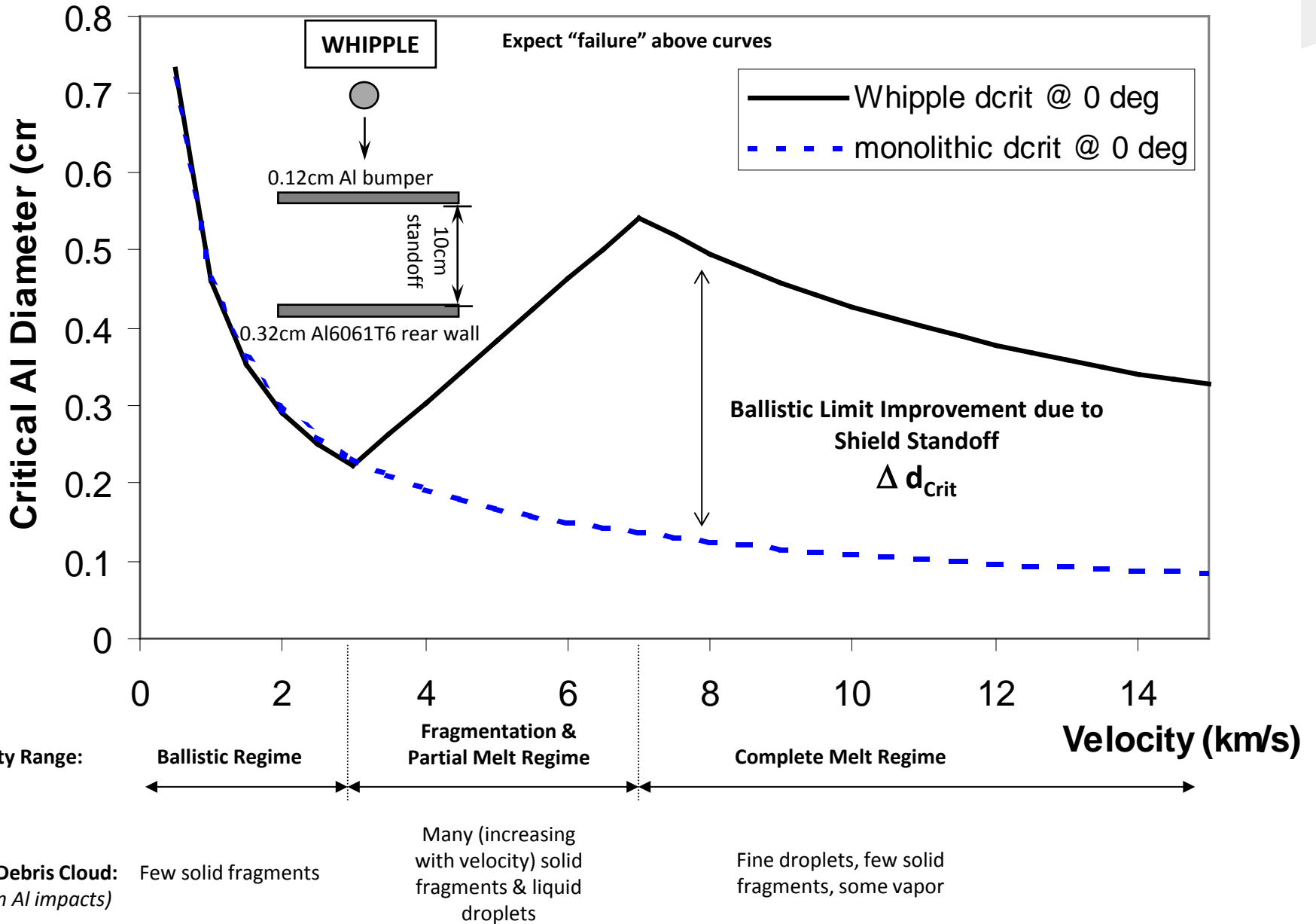



ISS shielding overview

- Several hundred MMOD shields protect ISS, differing by materials, standoff distance, and capability
- Heavier shields on front & sides (where we expect most MMOD impacts), less capable shielding on aft, nadir and visiting vehicles

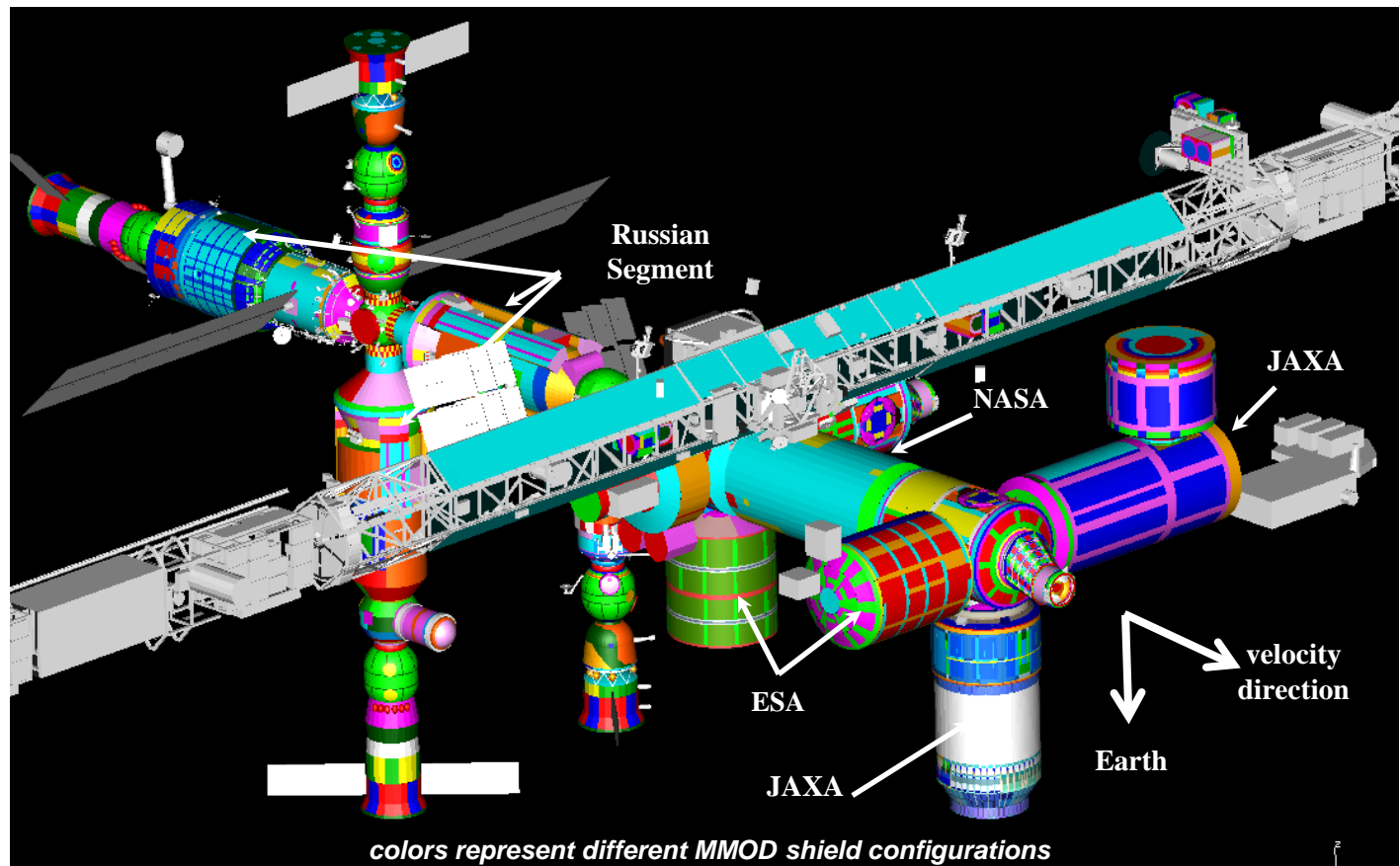

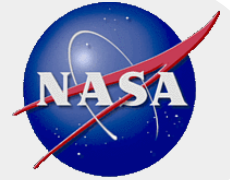

MMOD directionality

- **The Long-Duration Exposure Facility (LDEF) [1984-1990] provided the first detailed assessment of small particle debris in low Earth orbit**
 - LDEF maintained its orientation relative to the velocity vector, Earth/Space for its entire mission
- **Over 30,000 observable MMOD strikes were identified on the exterior of LDEF (damage diameter $\geq 0.3\text{mm}$)**
- **Of these MMOD impacts, approximately 20x more impacts were found on the forward face relative to the aft face, and 200x more on the forward than Earth**

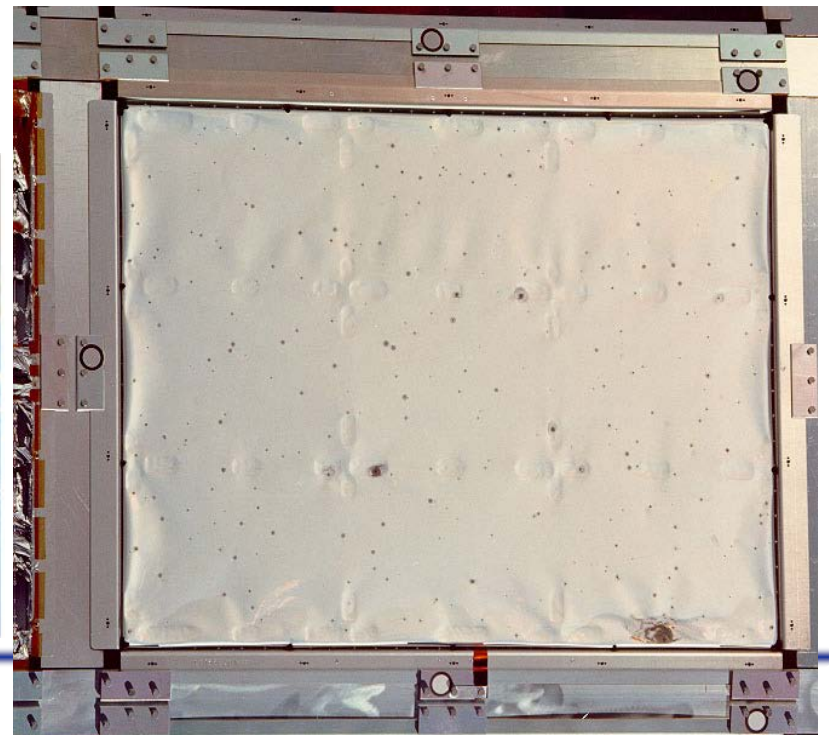

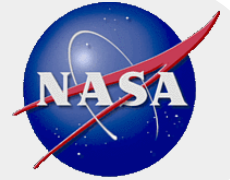

ISS “Stuffed Whipple” Shielding

(Typical Configurations Illustrated)

- US, JAXA and ESA employ “Stuffed Whipple” shielding on the areas of their modules exposed to greatest amount of orbital debris & meteoroids impacts
 - Nextel and Kevlar materials used in the intermediate bumper
 - shielding capable of defeating 1.3cm diameter aluminum sphere at 7 km/s, normal impact

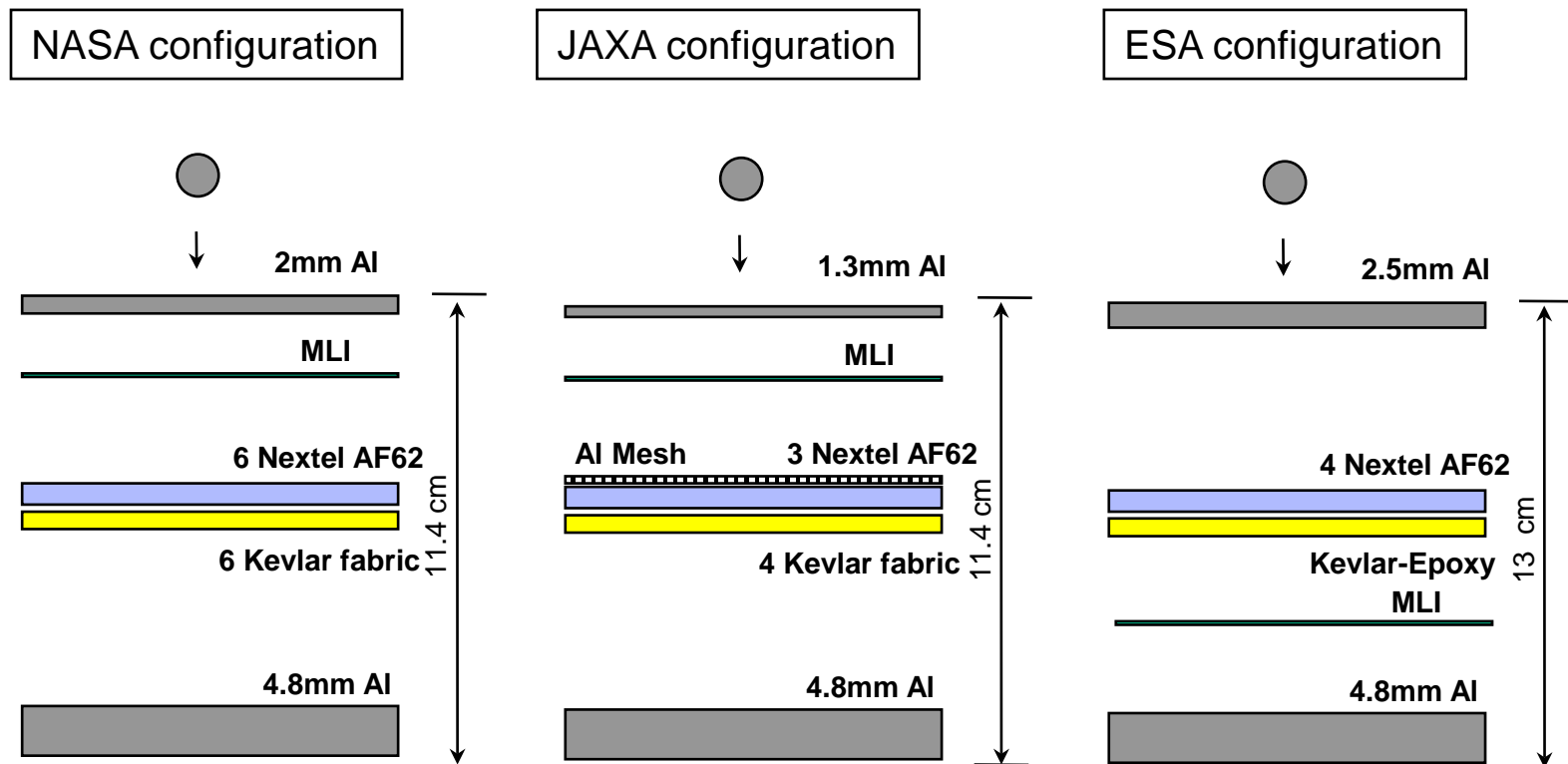



Shielding materials

- **Nextel (3M Inc. trade mark): fabric consisting of alumina-boria-silica ceramic fibers**
 - Other ceramic and glass fabrics tested, and will provide adequate MMOD protection (substitute equal mass for Nextel)
- **Kevlar aramid fabric: highest hypervelocity protection performance found using Kevlar KM2 fabrics**
 - Other high-strength to weight materials incorporated in MMOD shields include Spectra, Vectran, carbon fabric and carbon-composites



FGB and Service Module (SM) Mesh & Multi-Shock MMOD Shields

- Majority of FGB shields include 2 or more bumpers spaced in front of the module pressure shell or propellant tank wall (superior to single bumper shields)
 - Metal mesh layers provide additional protection in many FGB shields (a mesh causes greater spread to the debris cloud resulting from high velocity collision)
 - SM augmentation shields rely on multi-shock ceramic fabric layers
- FGB shields & SM augmentation shields provide protection from 1-1.5cm diameter aluminum projectiles (typical).
 - Unaugmented SM shields protect from ~0.3cm aluminum projectiles (typical)

FGB Zone 11c,d,f

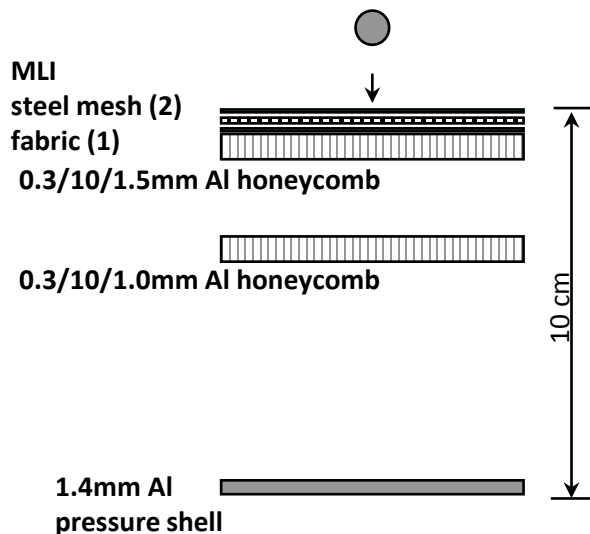

SM deployable shield/zone 6
orientation of zone 8 not parallel to 4 augmentation bumpers

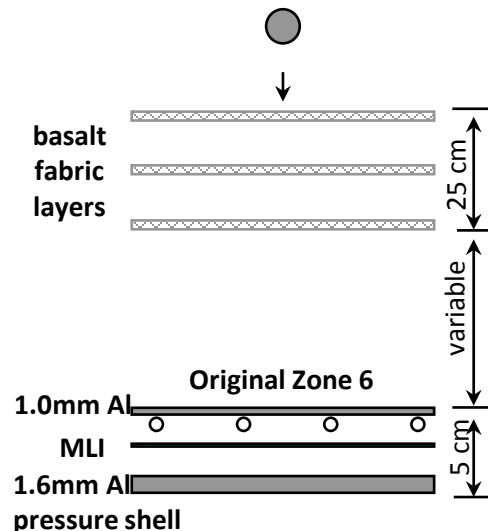

SM conformal shield/zone 8

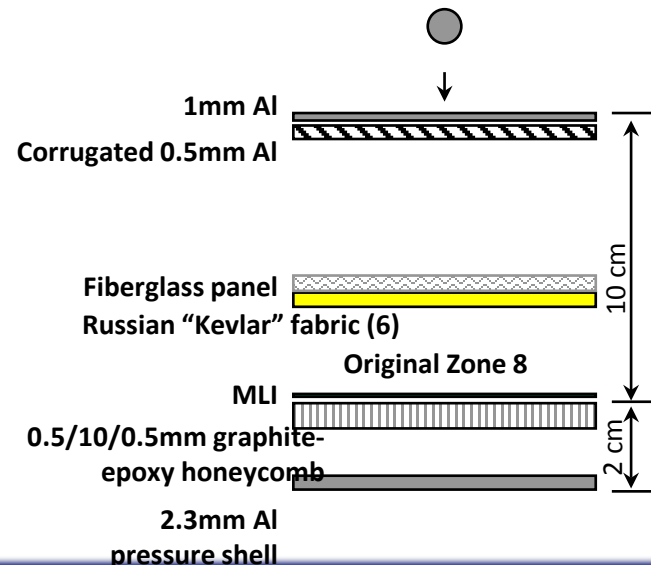

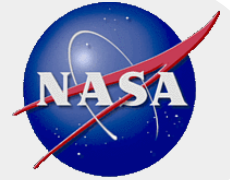

ISS Service Module Shielding

- **Service Module (SM) identified as high penetration risk using Bumper risk analysis**
 - large cone region
 - forward sides of small diameter cylinder
- **Shields designed and tested, EVA installed**
 - 23 augmentation shields for the cone region
 - 5 augmentation shields for the cylinder region
- **28 shields reduced SM MMOD risk by 30%**

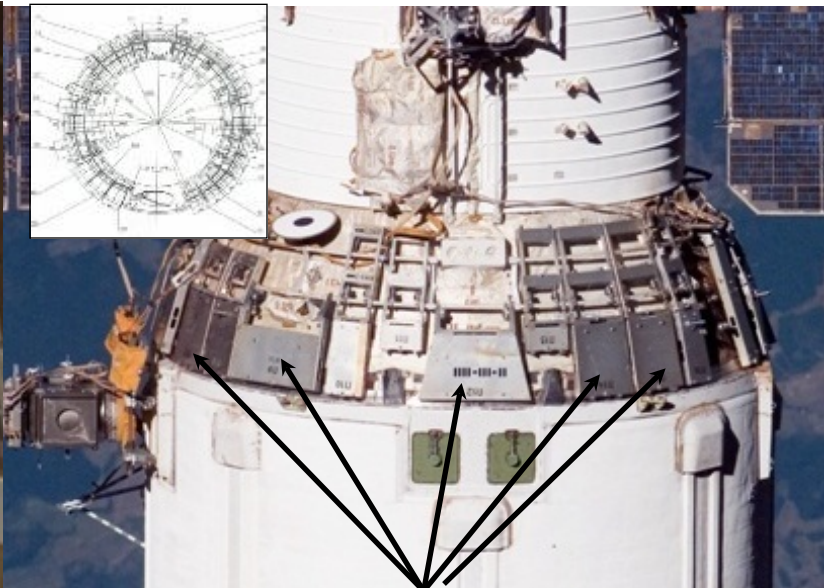
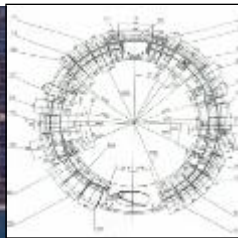
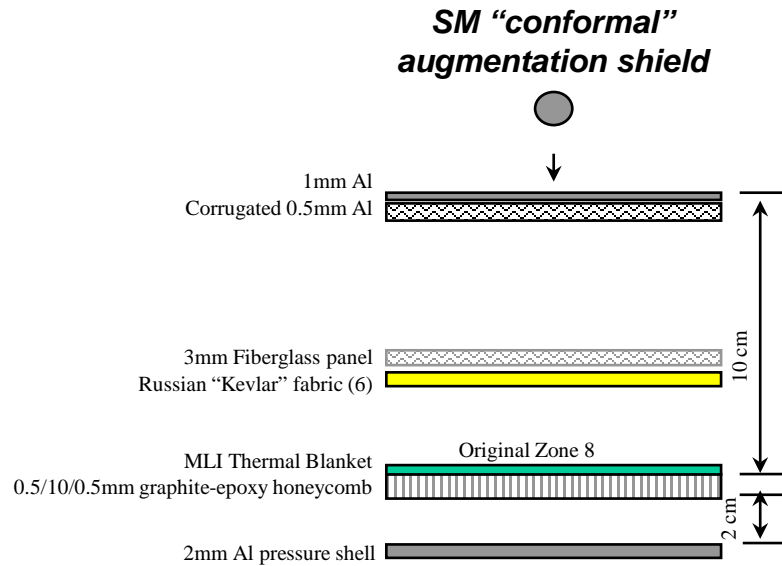

EVA Installation

23 "conformal" panels on cone region

5 panels on small diameter cylinder

Docking Compartment (DC) MMOD Shield & Performance Capability

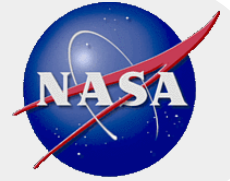

BUMPER Code Finite Element Model

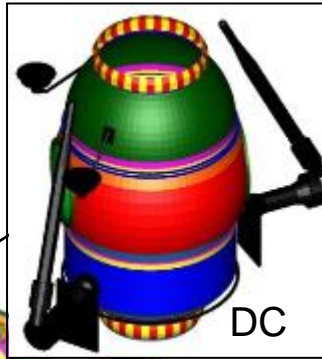
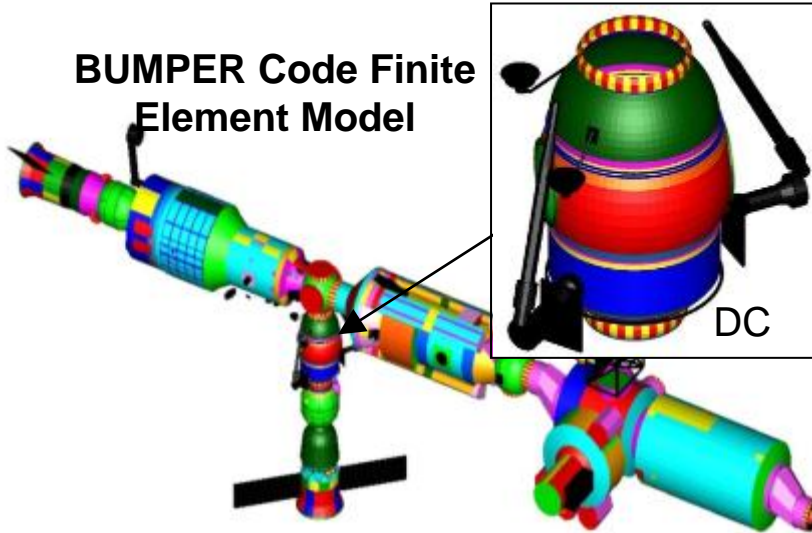

DC

DC-1 Ballistic Limit Equations (BLEs) and HVI Test Data

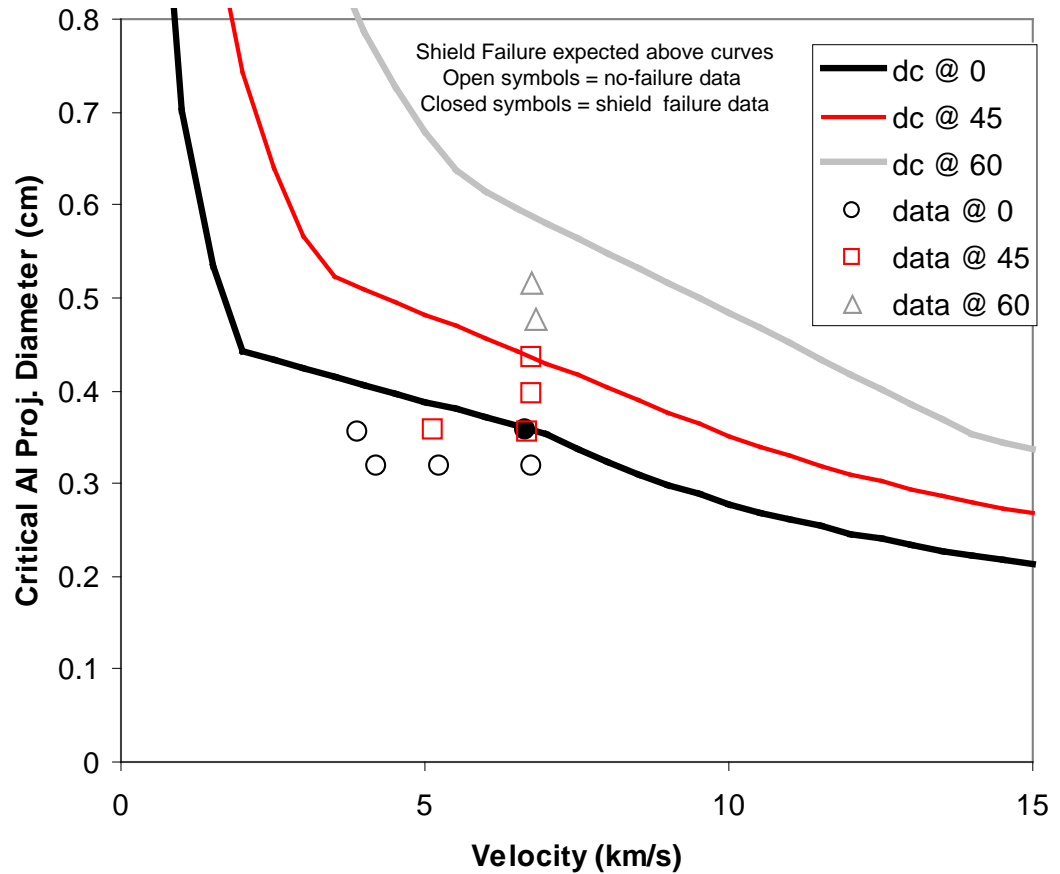

Typical DC Shield

(Whipple shield with MLI thermal blankets)

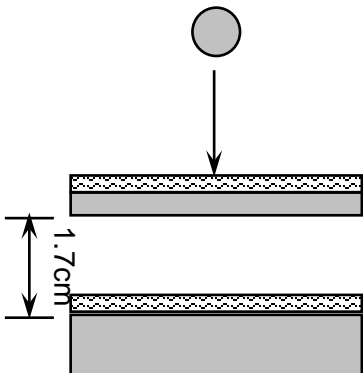

Ballistic Limit of shield (typical):
0.35cm Al projectile @ 7km/s, 0°

MLI
0.1cm Aluminum AMG6 bumper

MLI
0.4cm Aluminum AMG6 pressure shell



Foam sandwich MMOD shielding

- Honeycomb core sandwich structures are used extensively on spacecraft
- Honeycomb core tends to “channel” debris cloud and results in a relatively poor MMOD shield
- Replacing the honeycomb core with a metallic or ceramic foam provides improved MMOD protection

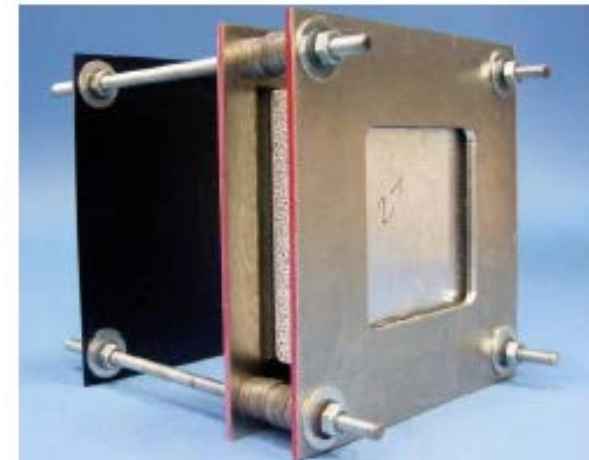
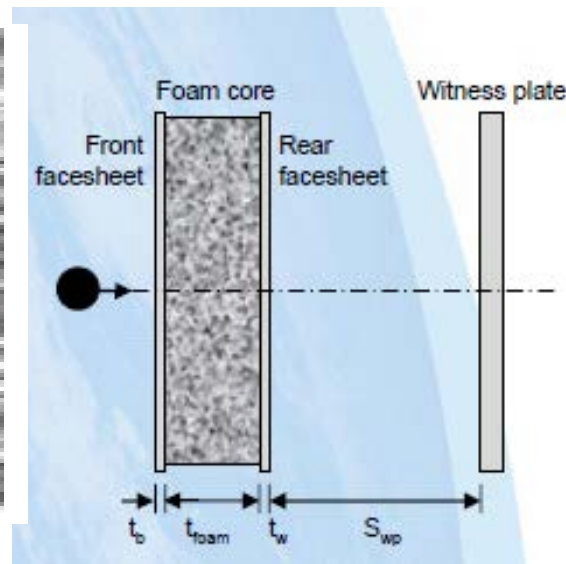
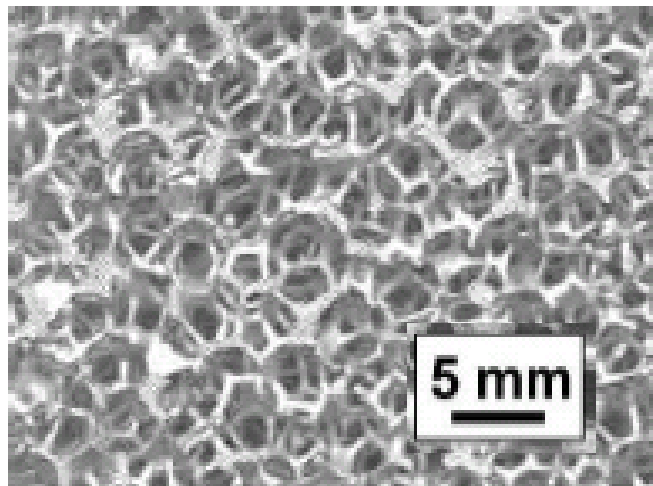

Foam sandwich hypervelocity test

3.6mm diameter Al2017T4 sphere at 6.2-6.8 km/s, 0-deg

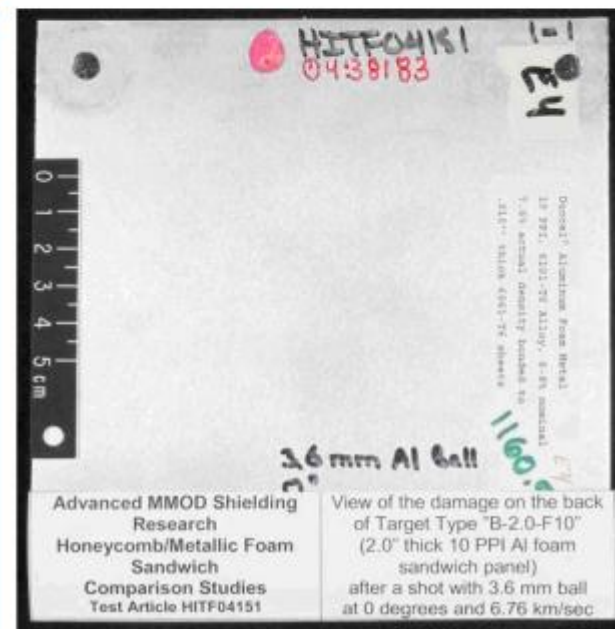
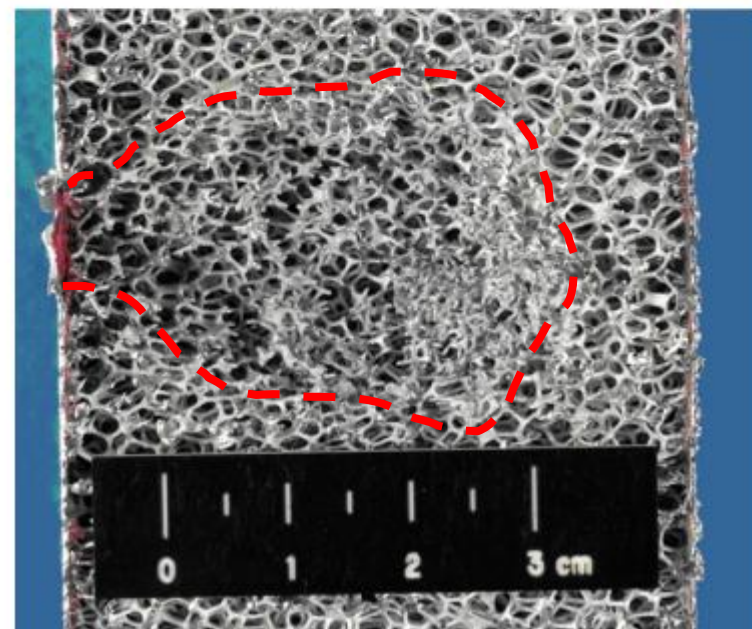
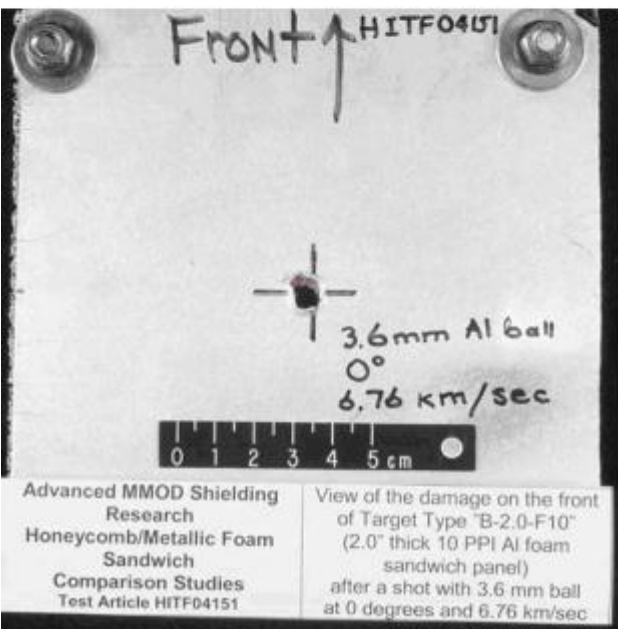
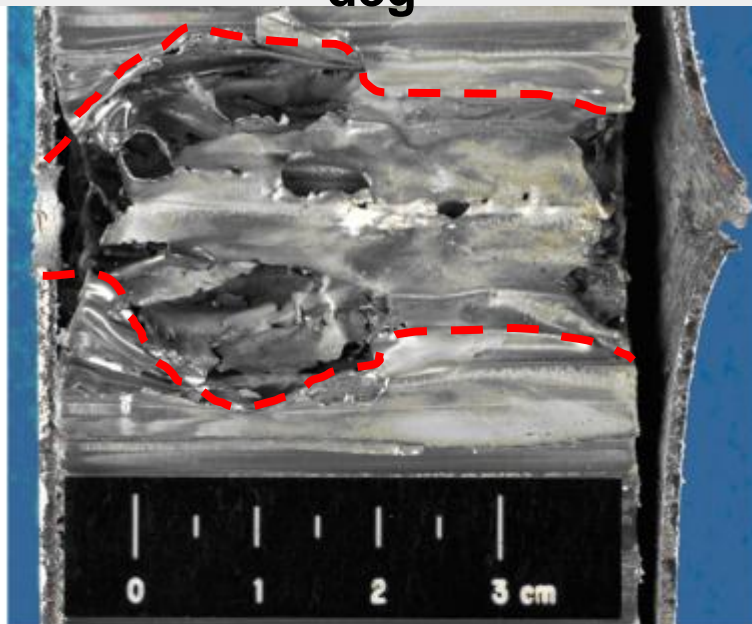
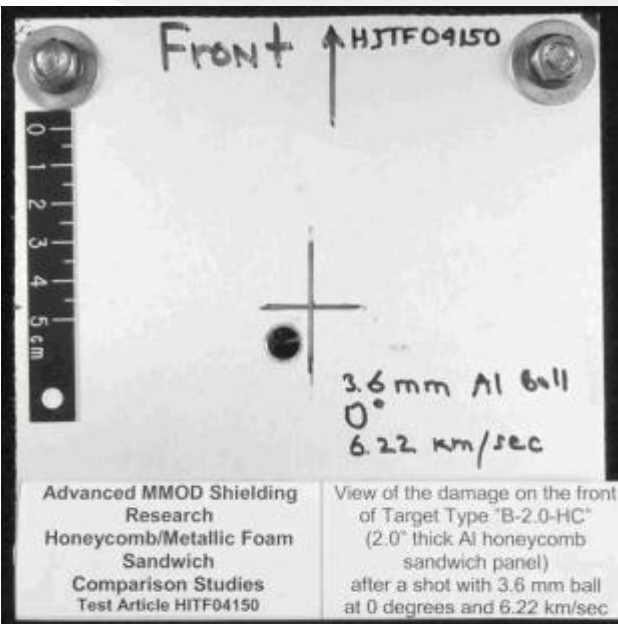
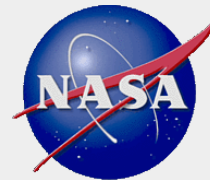



Smart MMOD shields

- **Implementing impact damage detection/location sensors is a high-priority**
 - Successfully added wireless accelerometer sensor detection system to Shuttle to monitor ascent and MMOD impacts on wing leading edge
 - Other methods to detect/locate impact damage available based on sensors to detect: acoustic emissions, fiber-optic & electrical grids, piezoelectric PVDF film, impact flash, radiofrequency emissions
 - Working to implement/integrate impact sensors into MMOD protection shields on next generation spacecraft



Test article (2'x2') with integrated sensors & piezoelectric sensor array

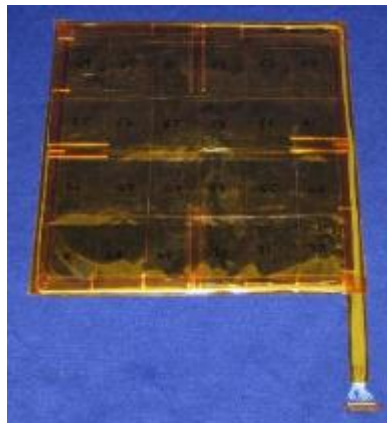

Distributed impact detection system (DIDS)

Shielding Summary

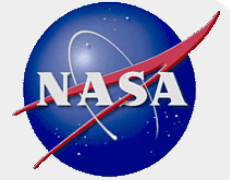

- **MMOD shielding capability influenced by both:**
 1. Configuration – “standoff” (more is better), number of bumper shield layers
 2. Material selection – ceramics/metals on exterior of shield, high-strength to weight ratio (fabrics & composites) on interior of shield

- **More information available (including many BLEs):**
 - NASA TP-2003-210788, Meteoroid/Debris Shielding
 - NASA TM-2009-214785, Handbook for Designing MMOD Protection
 - NASA TM-2003-212065, Integration of MMOD Impact Protection Strategies into Conceptual Spacecraft Design
 - NASA TM-2009-214789, MMOD Shield Ballistic Limit Analysis Program
 - NASA/TM-2014-218268, Volume I & II, Micrometeoroid and Orbital Debris (MMOD) Design and Analysis Improvements, NASA Engineering and Safety Center Report NESC-RP-12-00780
 - E.L. Christiansen and J.H. Kerr, Ballistic Limit Equations for Spacecraft Shielding, *International Journal of Impact Engineering*, Vol. 26, pp. 93-104, 2001



Agenda

- Micrometeoroid and orbital debris (MMOD) environment overview
- Hypervelocity impact effects & MMOD shielding
- **MMOD risk assessment process**
- Requirements & protection techniques
 - ISS
 - Shuttle
 - Orion/Commercial Crew Vehicles
- **MMOD effects on spacecraft systems & improving MMOD protection**
 - Radiators
 - Coatings
 - Thermal protection system (TPS) for atmospheric entry vehicles
 - Coatings
 - Windows
 - Solar arrays
 - Solar array masts
 - EVA Handrails
 - Thermal Blankets

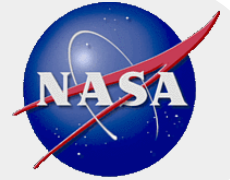

MMOD Risk Assessment Process

- Process used to identify MMOD risk drivers, evaluate risk mitigation options & optimization, verify compliance with protection requirements

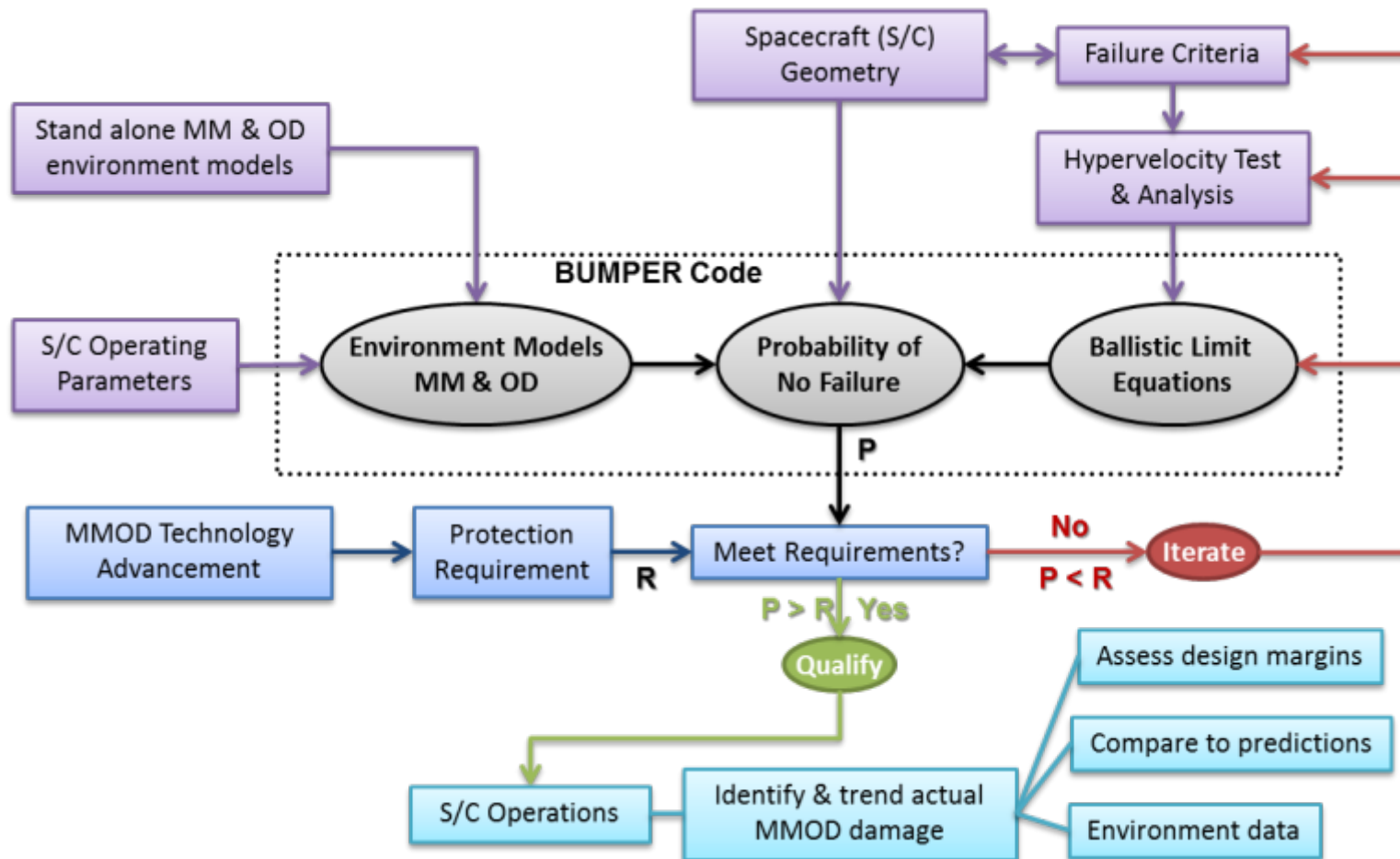

ISS Finite Element Model for MMOD risk assessment Block 7 (2017-2028)

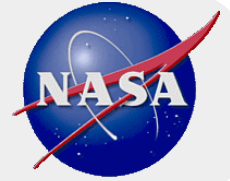

PMM relocated to N3f, add BEAM, IDA-1 & IDA2

Each color represents a different shield type

Progress @ MRM2

Progress @ SM

Soyuz @ MRM1

Soyuz @ NM

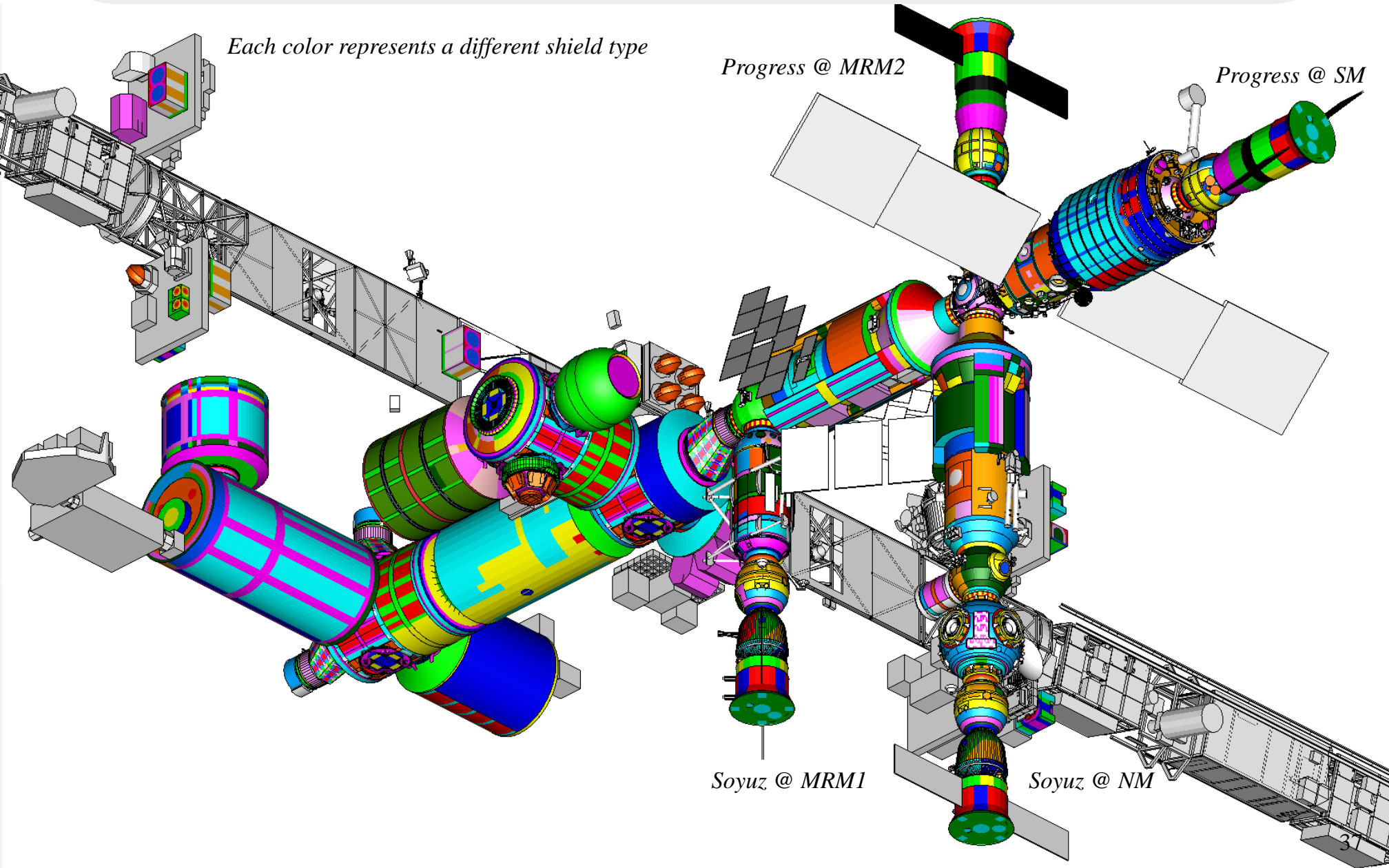

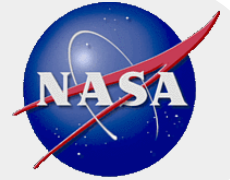

Failure criteria

- **Failure criteria required for each zone of spacecraft that clearly defines the limits of allowable damage (or failure threshold)**
 - Basis of impact tests/analysis, ballistic limit equations, risk assessments
- **Typically defined by Engineering & Program/Project (not by MMOD)**
- **ISS crew module pressure shell**
 - Typically failure is defined as detached spall or through-hole of pressure shell



Damage Class C3: Detached spall



Damage Class C4: Perforation

- Loss-of-crew (LOC) assessments for ISS include analysis of internal effects of penetrations, with criteria established for LOC due to fatal crew injury, hypoxia, fragmentation/explosion of pressure vessels (internal and external), and several other failure modes



Failure criteria (cont.)

- **Reentry vehicles, crew return vehicles**

- Loss-of-crew (LOC) failure include: (a) pressure vessel puncture and/or rupture leading to immediate on-orbit loss-of-vehicle/crew, (b) damage to thermal protection system (TPS) leading to loss-of-vehicle during reentry
- Loss-of-mission (LOM) failure includes: (a) radiator/coolant leaks, (b) others

STS-135 MMOD Failure Criteria for RCC WLE, NC, chin panel

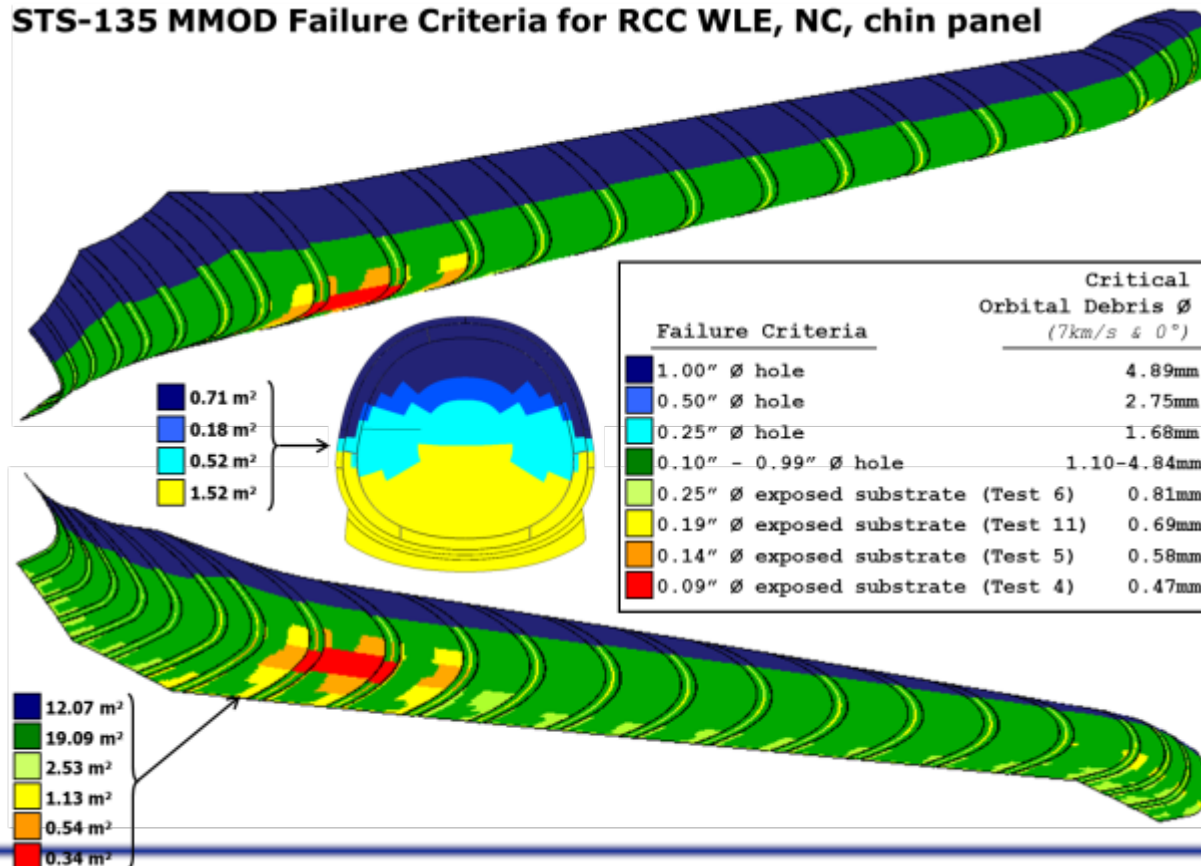

Hypervelocity Impact Test Results Anchor Analysis



- **JSC-KX plans and performs over 400 impact tests per year**
 - Primarily WSTF two-stage light gas-guns up to 8 km/s
 - University of Dayton Research Institute 3-stage launcher to 10 km/s
 - Southwest Research Institute shaped-charge launcher to 11 km/s
- **Data used to develop and verify ballistic limit equations used in Bumper code on range of different spacecraft components and subsystems**

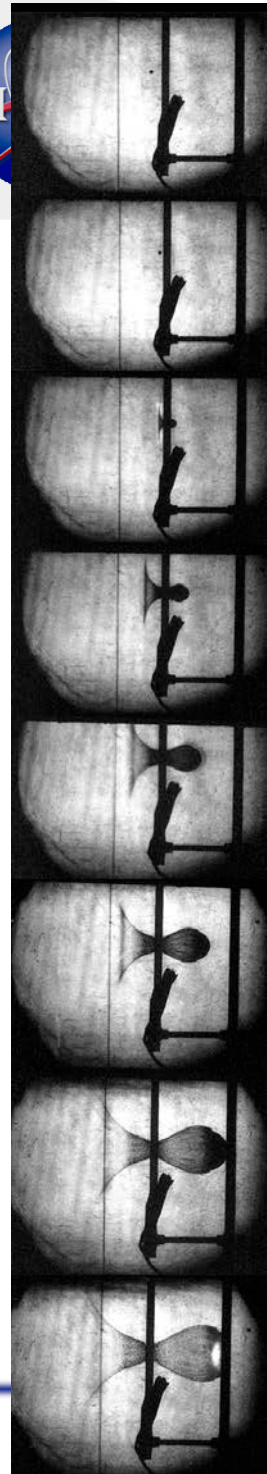
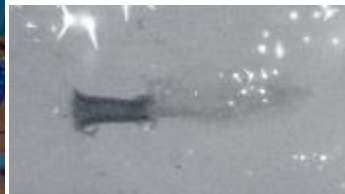
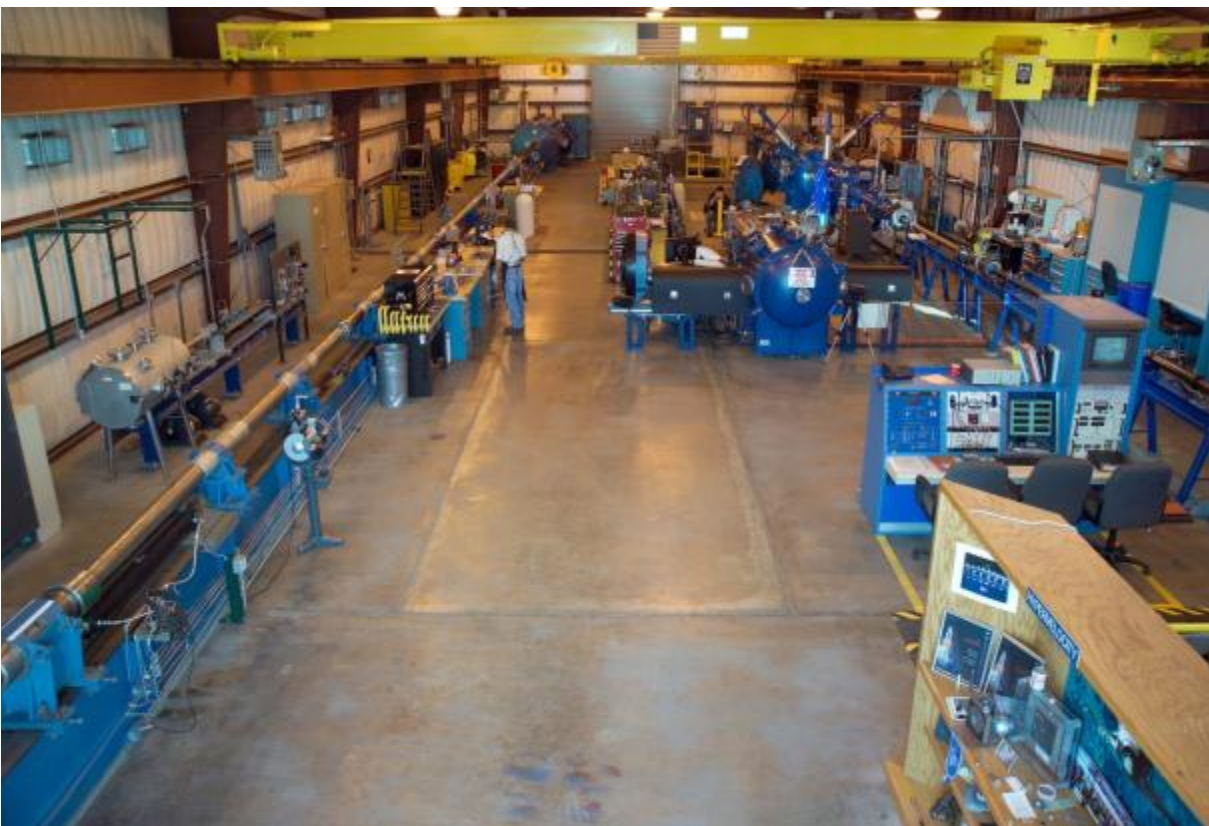

Hypervelocity Impact Results: Reinforced Carbon-Carbon (RCC) Example

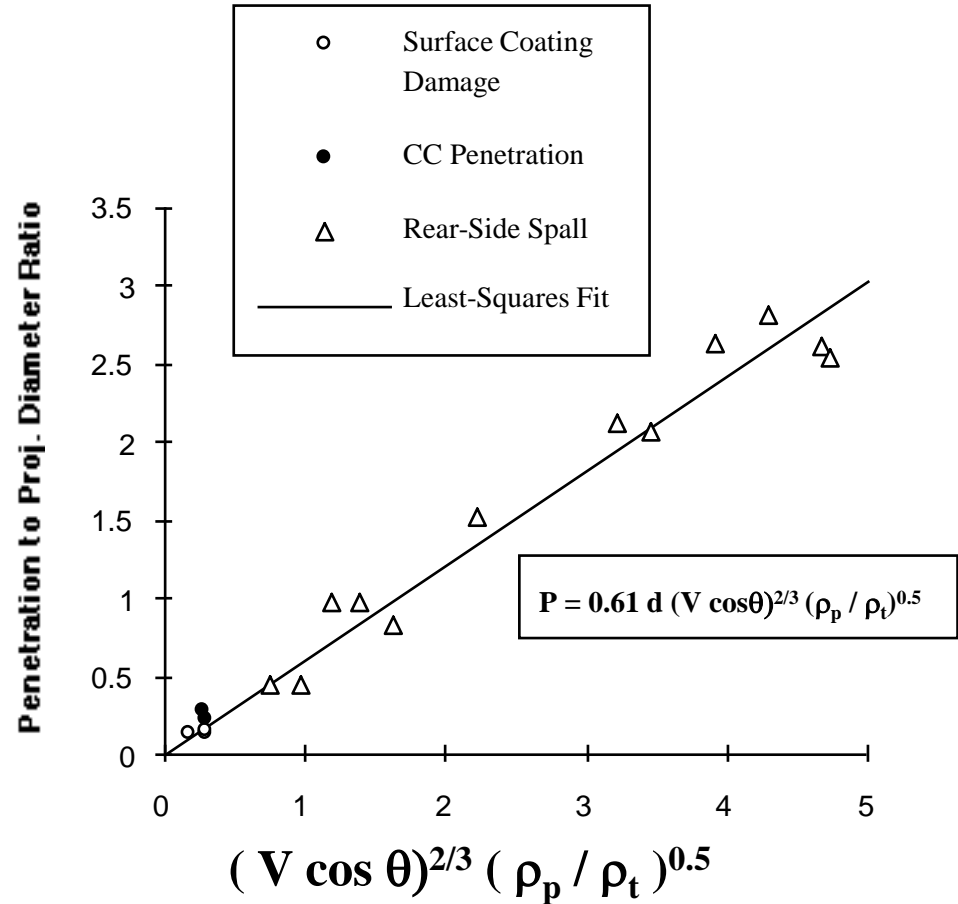
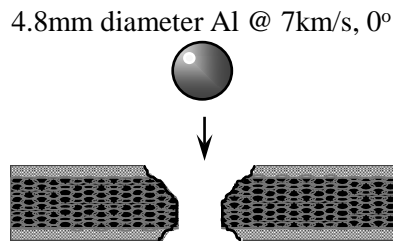
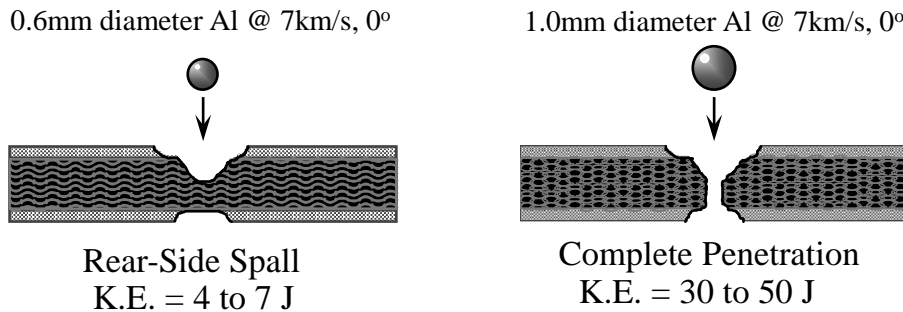
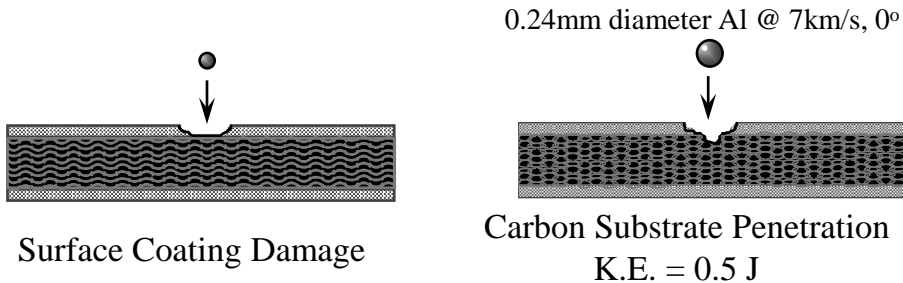
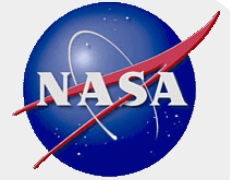

RCC Penetration depth $P = 0.61 d (V \cos \theta)^{2/3} (\rho_p / \rho_t)^{0.5}$
 Thickness to Prevent Complete Penetration $t_p = 2.3 * P$
 Thickness to Prevent Rear-Side Spall $t_s = 4.5 * P$



MMOD Risk Assessment Tools

- **Bumper Code** – Perform penetration & damage risk assessments
- **MSC-Surv** – Assess consequences of penetration for ISS: loss-of-crew, evacuation risk
- **Hydrocodes (CTH, Exos, others)** – Numerical simulation of hypervelocity impact (virtual test shots)

Bumper Code

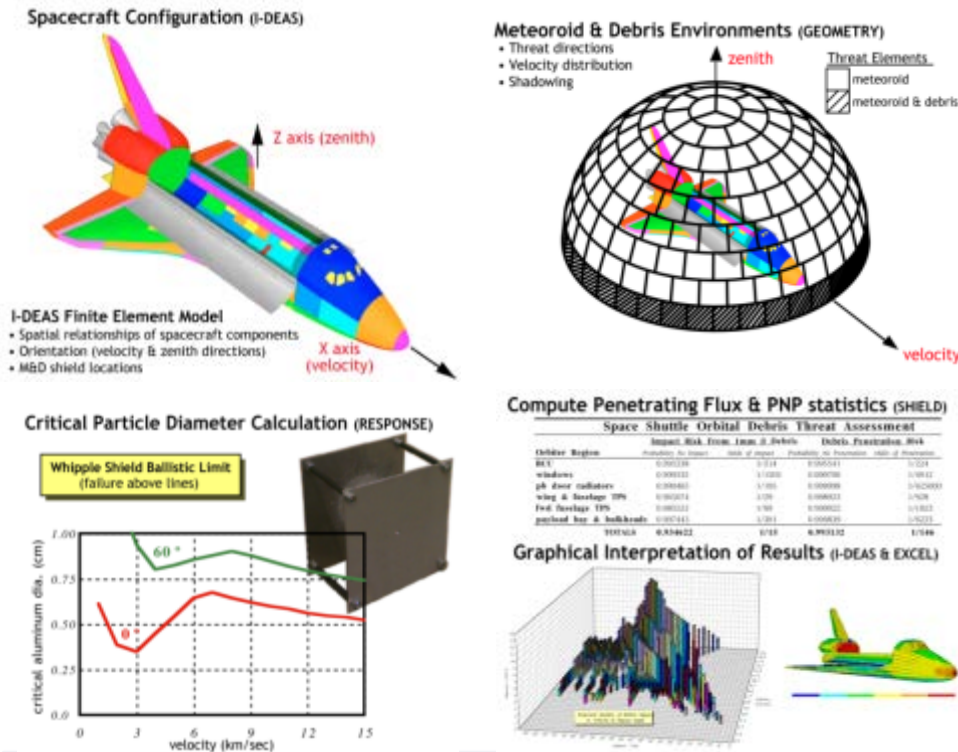

CTH Code

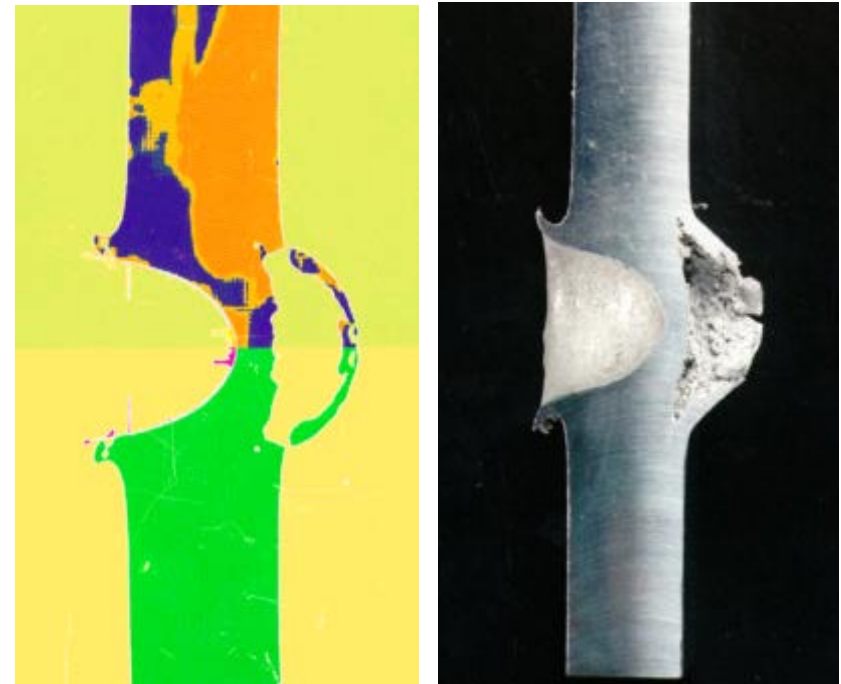

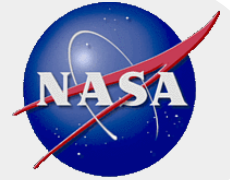

Analysis Products

- **Ballistic limit equations, damage equations**
- **Risk quantification:**
 - Spacecraft damage and/or loss
 - Penetration of pressure shell – air leak
 - Crew evacuation
 - Loss of crew
 - Uncertainties
- **Requirements verification**
- **Risk drivers – what area of vehicle controls risk, focus of more analysis and/or shielding modifications**
- **Assess operational methods to control risk:**
 - Flight attitude, altitude
 - Dock location, orientation
 - Thermal protection system (TPS) inspection/damage mitigation

ISS Soyuz Penetration Risk Color Contour
Red=high risk, Blue=low risk

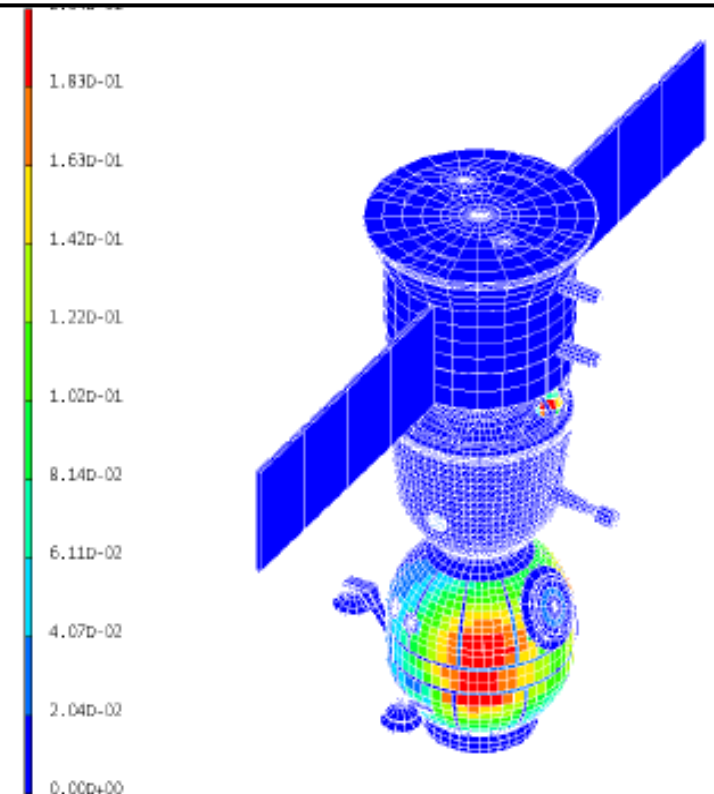

Post Flight MMOD Inspection: STS-130

	Number of MMOD impacts	Largest MMOD impacts
Windows	15 craters	W1, 4.2 x 3.6 mm 6 R&R's (W1,2,6,7,8 & 11)
Radiators	25 MMOD damages reported	1 face sheet perforation
Wing leading edge & nose cap	9 MMOD indications (reviewed by LESS PRT)	Panel 18R, 3.2 x 2.8 mm, max depth = 0.46 mm no exposed substrate

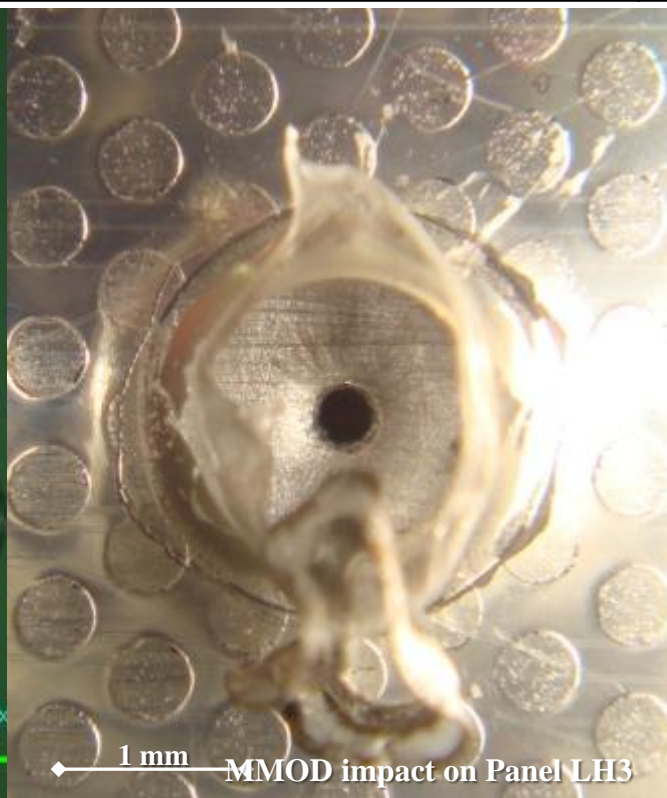
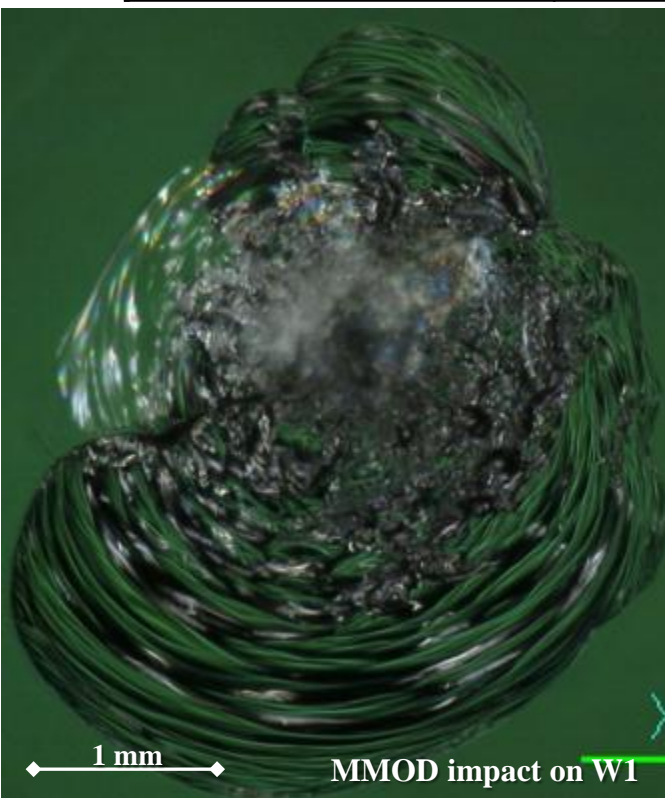

Post Flight MMOD Inspection: ISS



MPLM



Pump Module (PM)



PM Adapter Plate

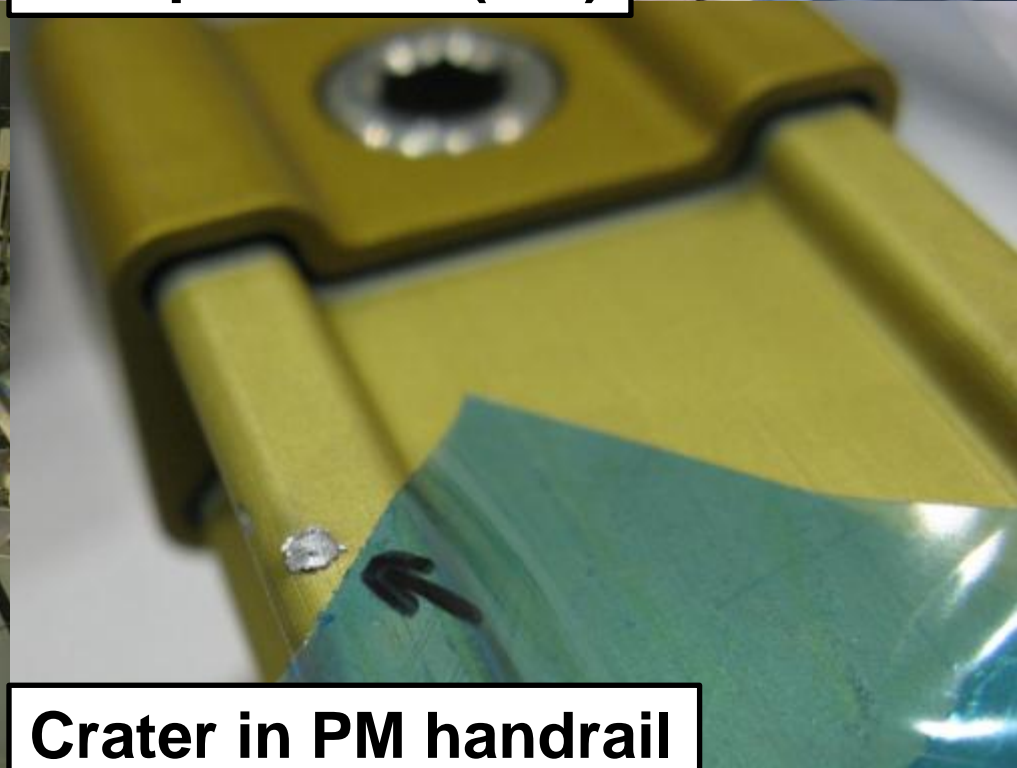

Crater in PM handrail

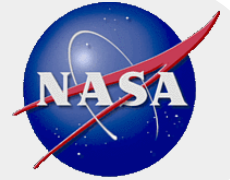

Agenda

- Micrometeoroid and orbital debris (MMOD) environment overview
- Hypervelocity impact effects & MMOD shielding
- MMOD risk assessment process
- **Requirements & protection techniques**
 - ISS
 - Shuttle
 - Orion/Commercial Crew Vehicles
- **MMOD effects on spacecraft systems & improving MMOD protection**
 - Radiators
 - Coatings
 - Thermal protection system (TPS) for atmospheric entry vehicles
 - Coatings
 - Windows
 - Solar arrays
 - Solar array masts
 - EVA Handrails
 - Thermal Blankets

International Space Station (ISS) MMOD Requirements

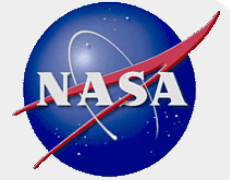

- **MMOD requirements are key aspect of providing adequate MMOD protection**
- **ISS MMOD requirement (SSP 41000): 0.76 probability of no penetration (PNP) or better over 10 years**
 - No more than 24% penetration risk allowed over 10years for all MMOD critical items which include crew modules and external stored energy devices (pressure vessels & control moment gyros)
- **No more than 0.8% penetration risk allowed on average over 10years per MMOD critical item**
- **Loss-of-crew and crew evacuation risk assessments performed for input into ISS Probabilistic Risk Assessment (PRA)**
 - Risk informed decisions based on PRA
- **Requirements for functional equipment set on case-by-case basis (functional = failure does not lead to loss-of-crew)**

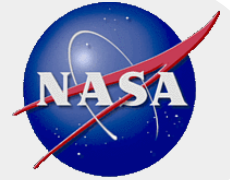

ISS MMOD protection approach

- **Multi-faceted approach to mitigating MMOD Risk on ISS**

1. Robust shielding

- ISS has best shielding ever flown: US/ESA/Japan Nextel/Kevlar “stuffed” Whipple shields effective for 1.3cm diameter debris impacting at typical impact conditions
- Augmentation shields added by extravehicular activity (EVA) to Russian Service Module
- Upgrades to Soyuz and Progress MMOD protection
- Redundant & hardened external systems; e.g. US Radiators



0.5” diameter hypervelocity projectile penetrates nearly 2” thick aluminum block, but is stopped by NASA stuffed Whipple shields which weigh far less (same as 3/8” thick aluminum)

2. Collision avoidance

- Maneuver to avoid ground-trackable orbital debris (typically $\geq 10\text{cm}$ diameter)

3. Sensors & crew response to leak if needed

- Leak detection, isolation, repair

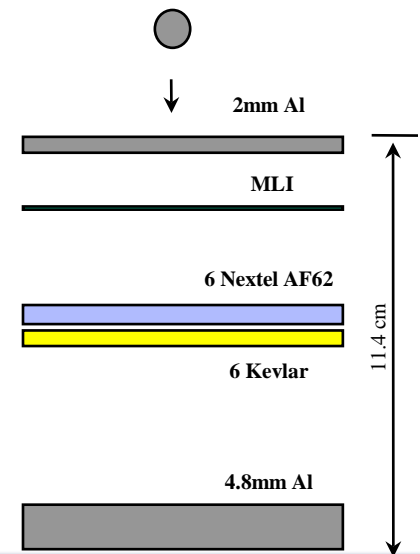

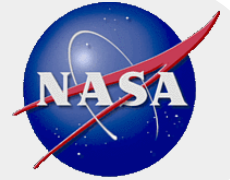

Visiting Vehicle Requirements

- **Shuttle MMOD requirements were two fold:**
 - Loss-of-crew (LOC) risk should not exceed 1 in 200 per mission
 - Driving loss-mode for LOC was MMOD damage to thermal protection system (TPS) materials leading to loss-of-vehicle during reentry
 - Loss-of-mission (LOM) due to radiator tube leaks should not exceed 1 in 61 per mission
- **ISS commercial crew transport vehicle MMOD requirements:**
 - Penetration risk causing crew-module leak &/or tank failure while docked to ISS should not exceed $1 - 0.99999^{(\text{surface area}_m^2 * \text{duration}_\text{years})}$
 - MMOD LOC/LOM requirements are derived from overall vehicle LOC/LOM requirements, and cover the risk to TPS & loss of vehicle during reentry



Shuttle MMOD protection strategy

- **Design improvements:**

- Added thermal protection to wing leading edge structural attach fittings
- Added doublers to radiator flow tubes
- Added protective sleeves to radiator interconnect lines
- Added automatic isolation valves to thermal loops

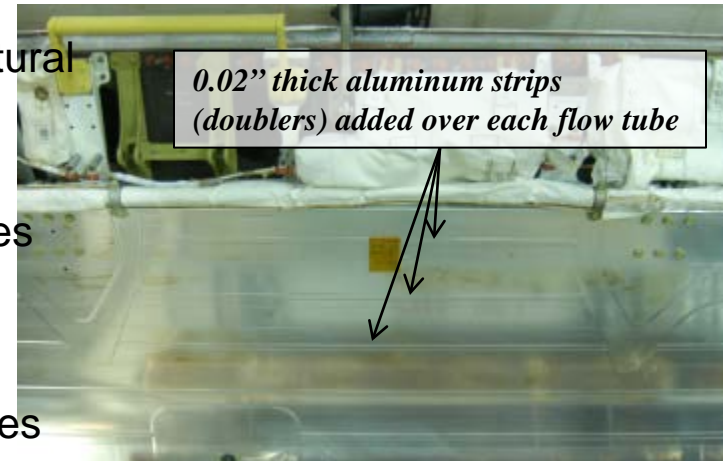

- **Attitude/orientation selection:**

- Implemented flight rules to fly low-risk MMOD attitudes during free-flight
- Flew ISS-Shuttle stack backwards after dock, to reduce MMOD risk to Shuttle TPS

- **Inspection/sensors in high MMOD risk areas:**

- Implemented late mission inspection of wing leading edge and nose cap for critical MMOD damage
- Added sensors to wing leading edge to monitor for impact damage (ascent & MMOD)

- **Collision avoidance:**

- Collision avoidance from ground-trackable debris (10 and larger)

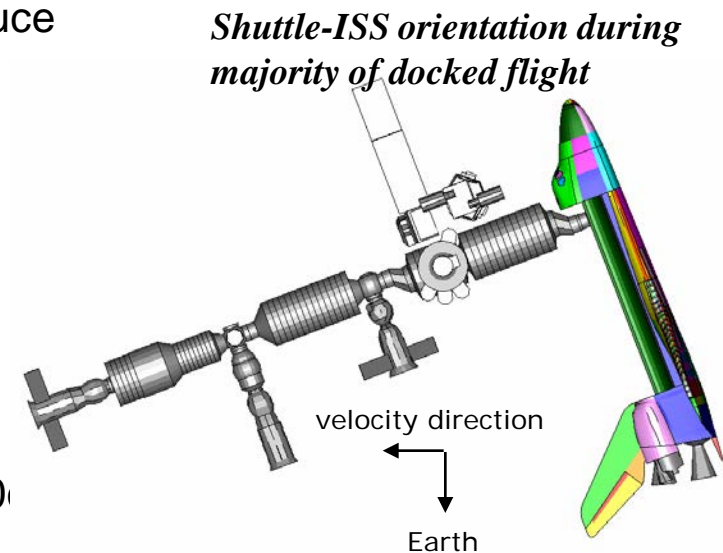



Agenda

- Micrometeoroid and orbital debris (MMOD) environment overview
- Hypervelocity impact effects & MMOD shielding
- MMOD risk assessment process
- Requirements & protection techniques
 - ISS
 - Shuttle
 - Orion/Commercial Crew Vehicles
- **MMOD effects on spacecraft systems & improving MMOD protection**
 - Radiators
 - Coatings
 - Thermal protection system (TPS) for atmospheric entry vehicles
 - Coatings
 - Windows
 - Solar arrays
 - Solar array masts
 - EVA Handrails
 - Thermal Blankets



MMOD Considerations for Radiators

- **Radiator flow loops are subject to penetration by MMOD**
 - Radiators are large and will be impacted by MMOD during each flight
 - Radiator flow tube area is smaller, but still experiences MMOD damage
 - Leaks can result in degraded spacecraft function and early mission termination
 - Radiator flow paths can be hardened to reduce the risk of leaks from MMOD damage
 - Radiator interconnect lines also subject to MMOD failure, and can be hardened from damage by increasing thermal insulation, adding beta-cloth sleeves, thicker walls, increasing flexible braiding, or wrapping with Nextel/Kevlar
- **Radiator coatings typically either spall or delaminate around impact site**
 - Silver-teflon (Shuttle radiator panels) delaminate
 - Z93 paint (ISS radiator panels) spall
 - Diameter of spall/delamination typically large compared to impactor diameter (4-15x), but area covered by spall/delamination small relative to radiator area, even for long-duration missions (a few percent of coating is damaged over 10-30year ISS missions), therefore not likely to result in major thermal issue

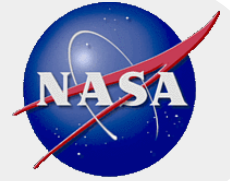

Radiator coating damage typical hypervelocity impact test results

Z-93 paint

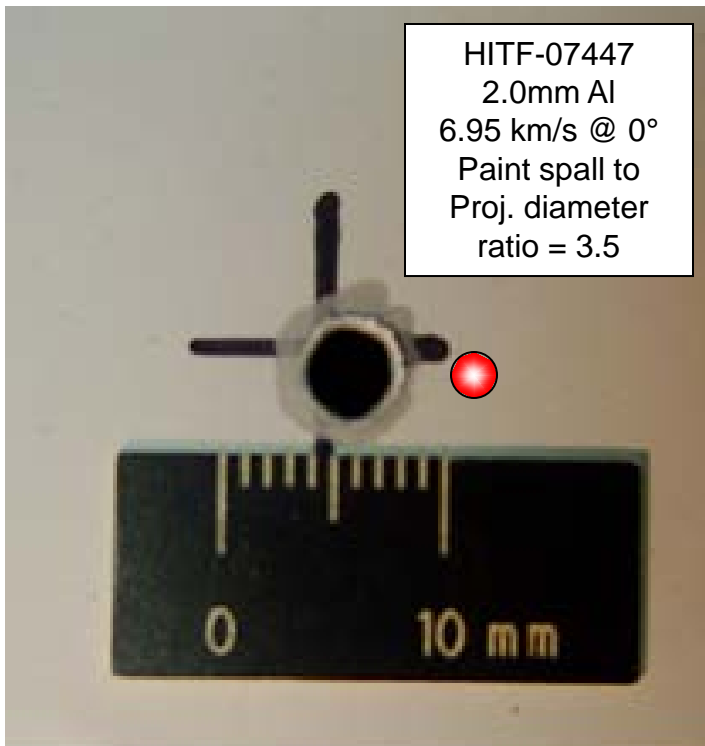

Silver-Teflon tape





Issues: MMOD Damage to ISS Radiators

- **MMOD impact damages observed to ISS radiator panels during Russian EVA (June 2013)**

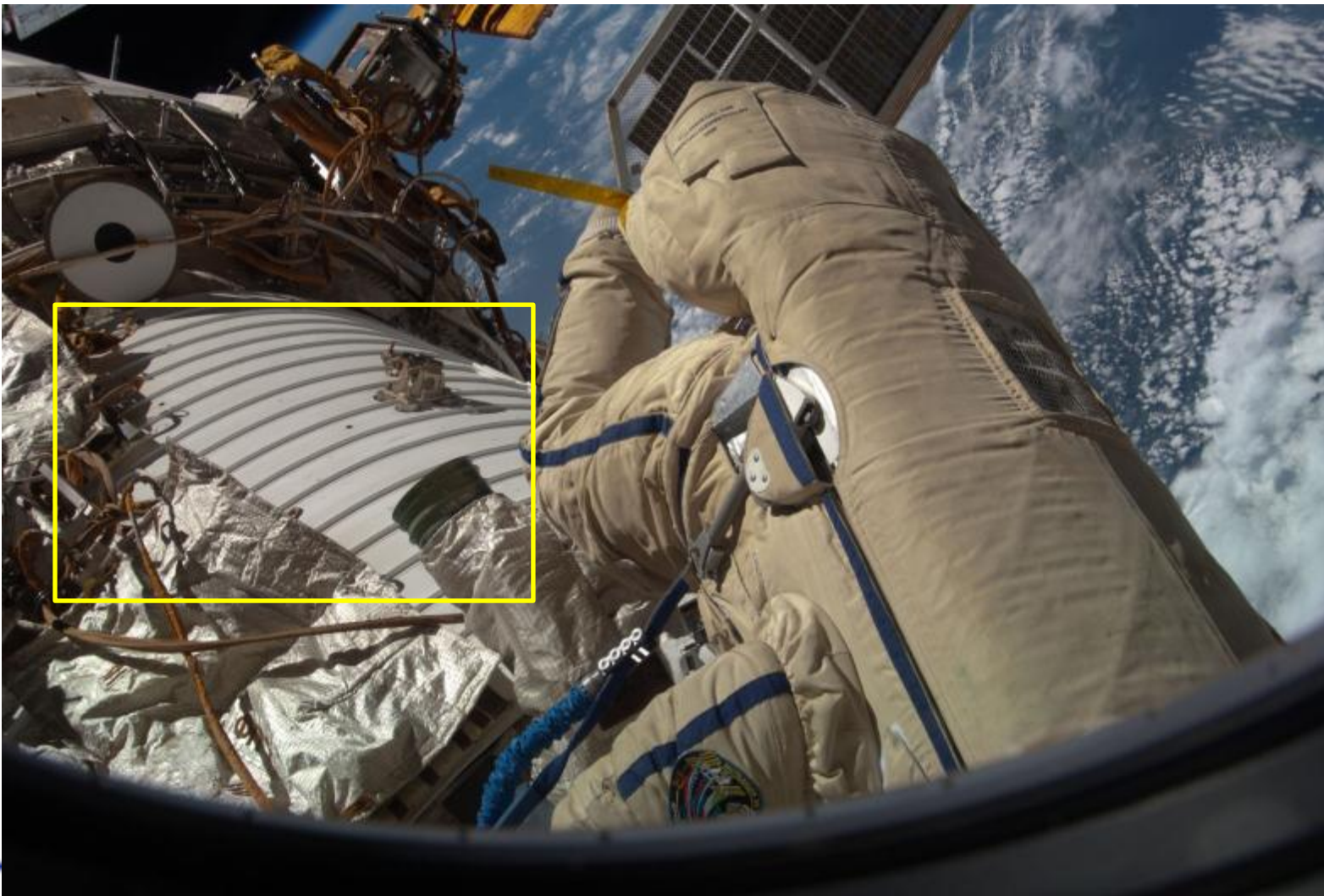

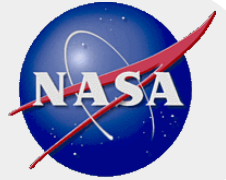

MMOD Damage to ISS Radiators



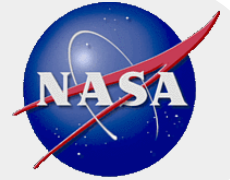

MMOD Damage to ISS

- **MMOD impact damages observed to radiator panel during EVA-20 (Nov. 2012)**

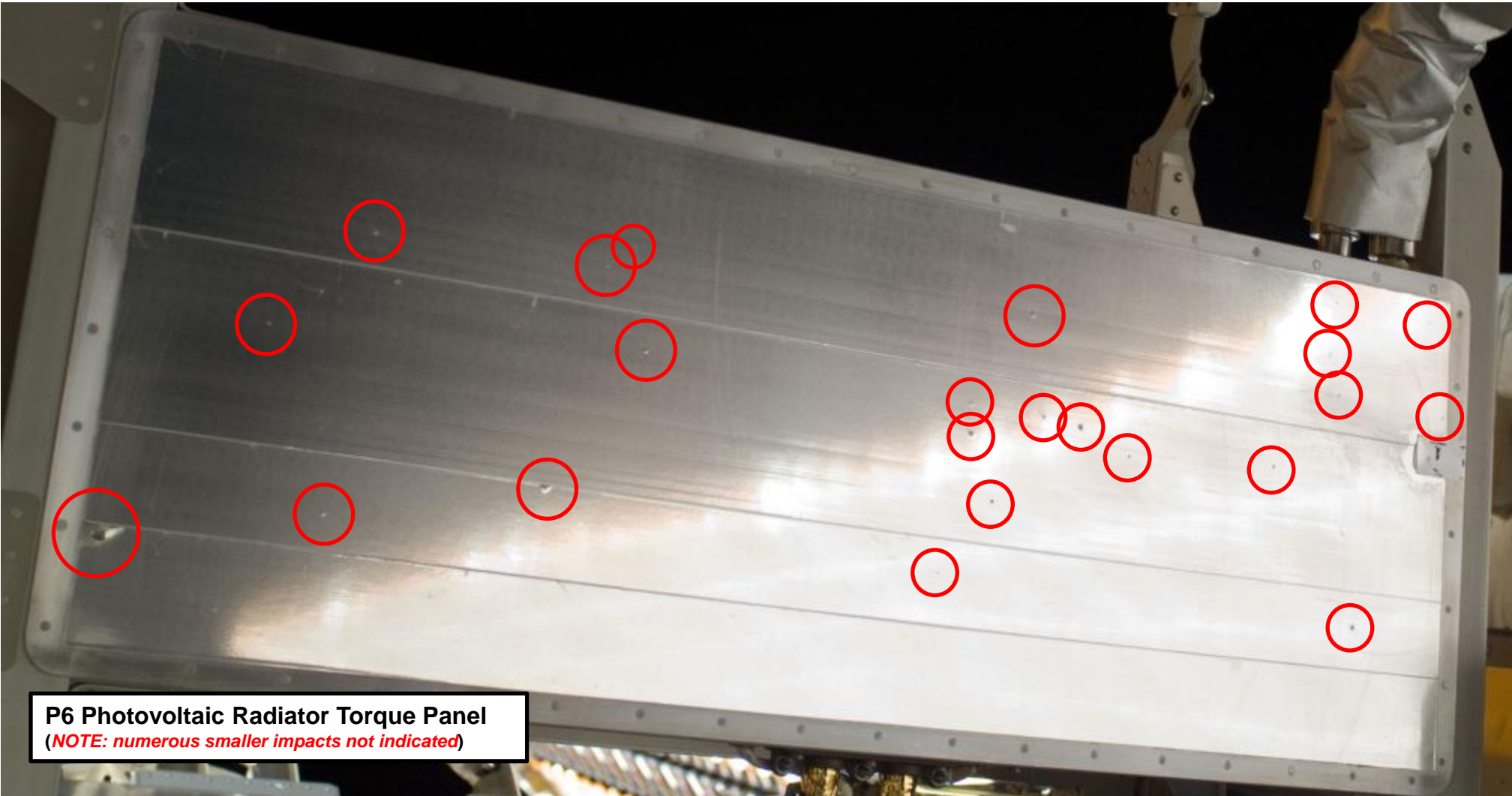

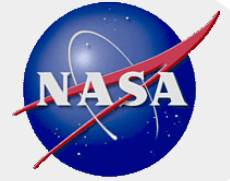

MMOD Damage to ISS Radiators (US)

- **MMOD impact damages observed to ISS radiator panels (Aug. 2013)**

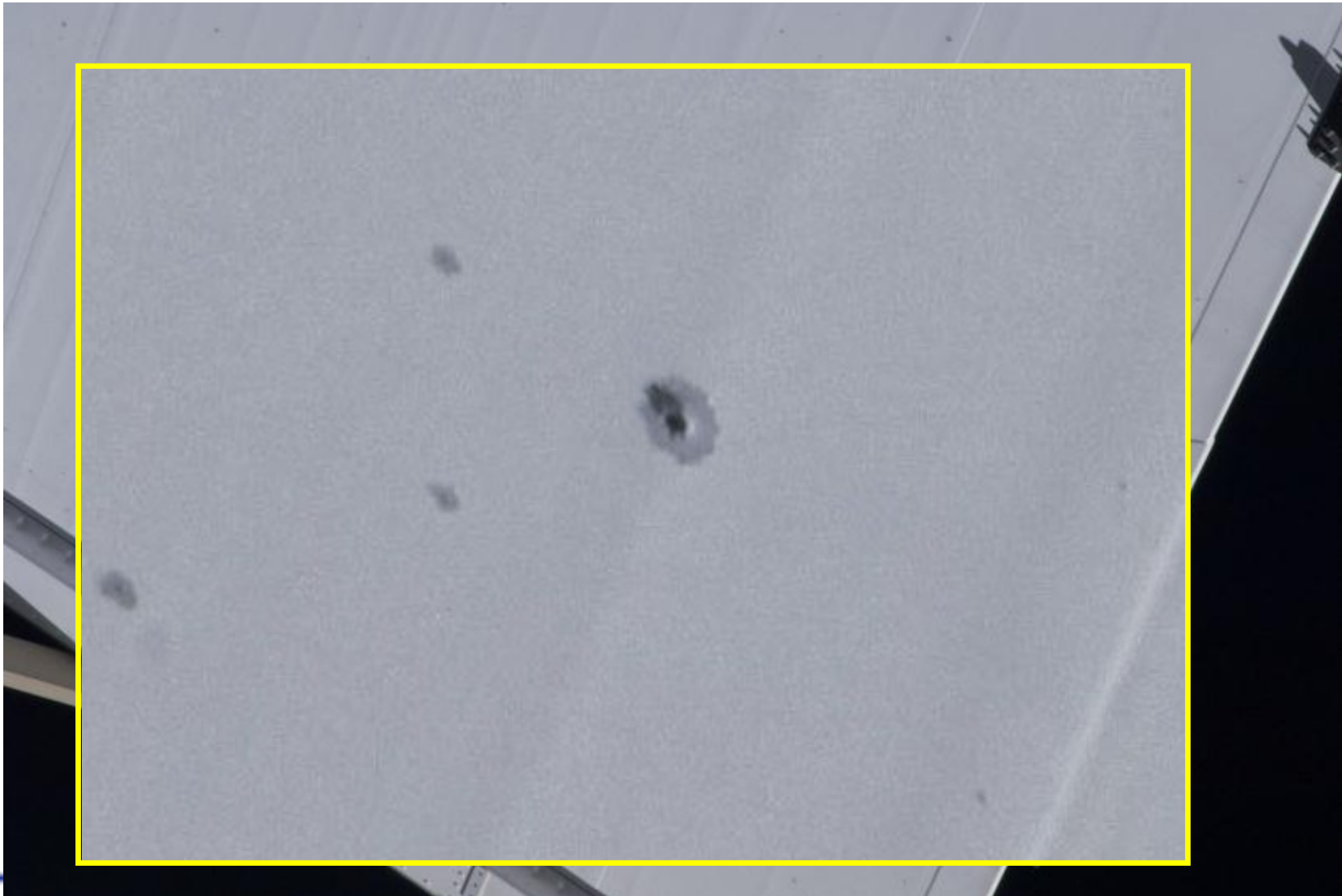

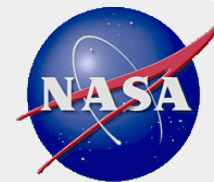

P4 photovoltaic radiator

- **Initial indication found on 6/30/2014**

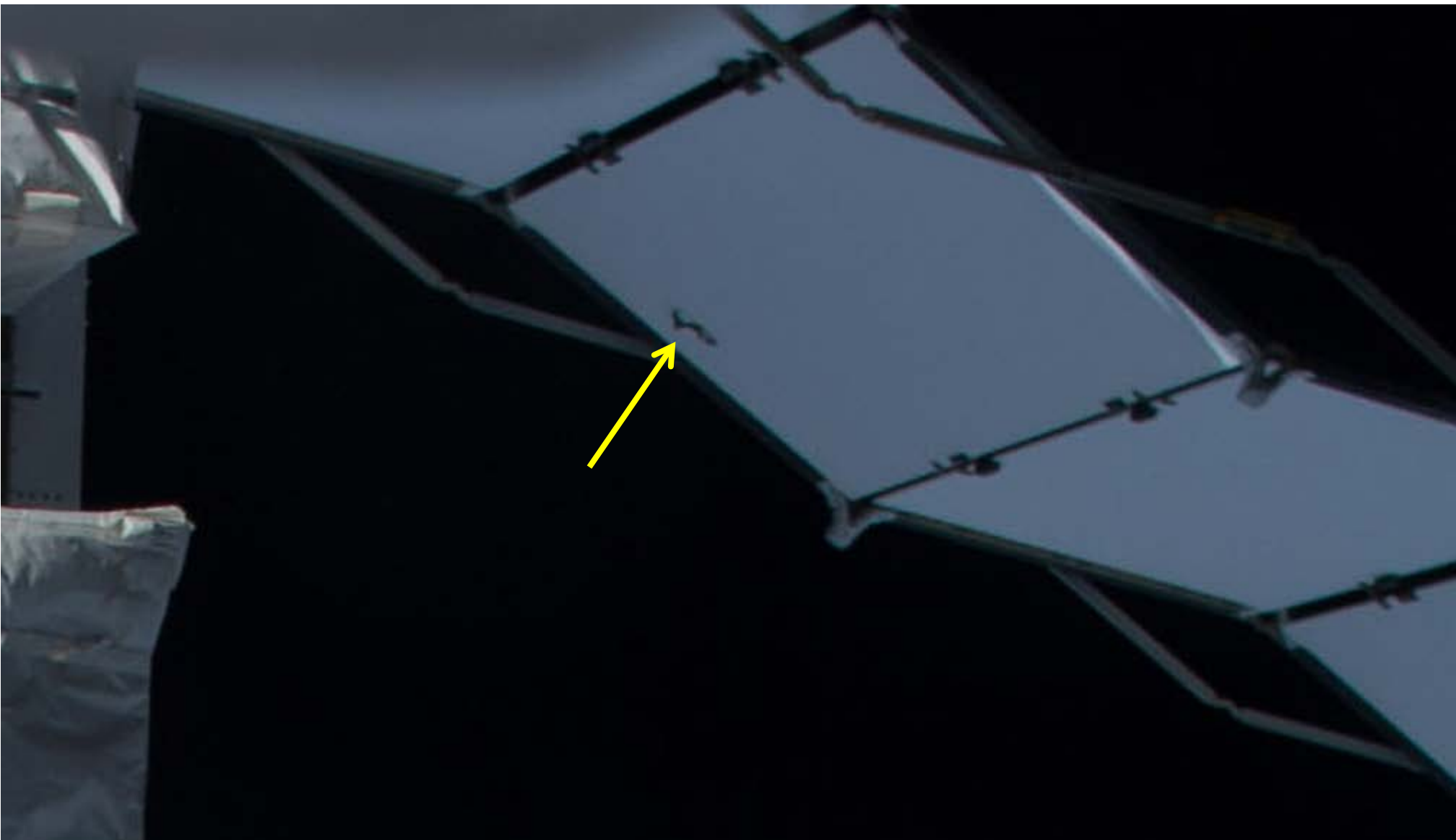

Measurement of P4-PVR Radiator Damage "2A" Side of Panel 3

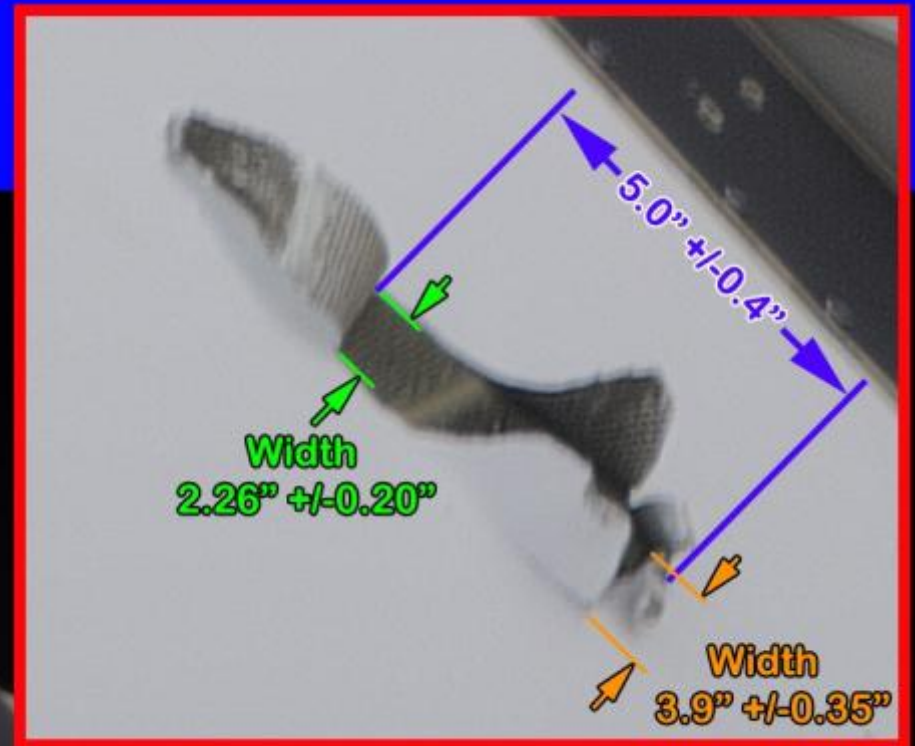

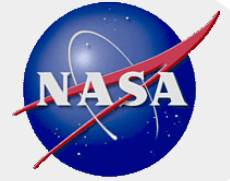

ISS PVR Panel Construction

- **124" x 70" x 0.69" thick panel**
- **Aluminum face sheet**
 - Z93 white paint
- **Aluminum flow tube housing extrusion with Inconel flow tube**
 - Evenly spaced 2.6 inches except outermost tube spaced 3.5 inches
- **Note, flow tube relatively thick wall (>0.05") and in well protected location at center of panel**

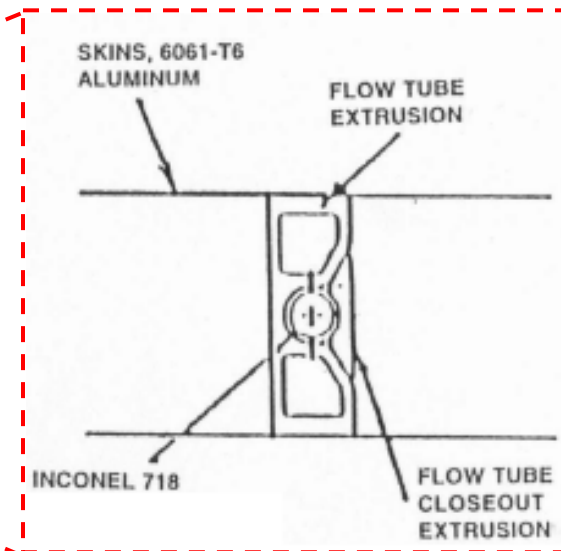
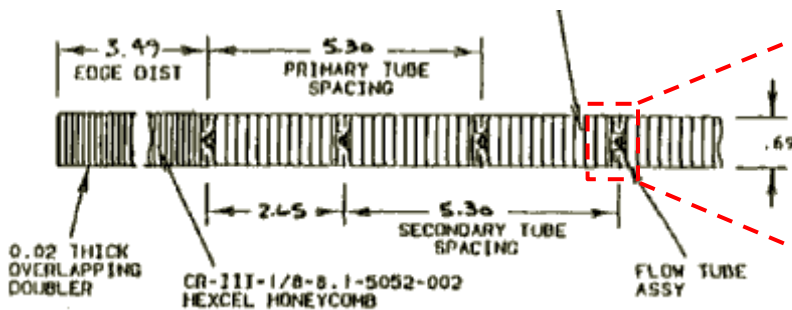
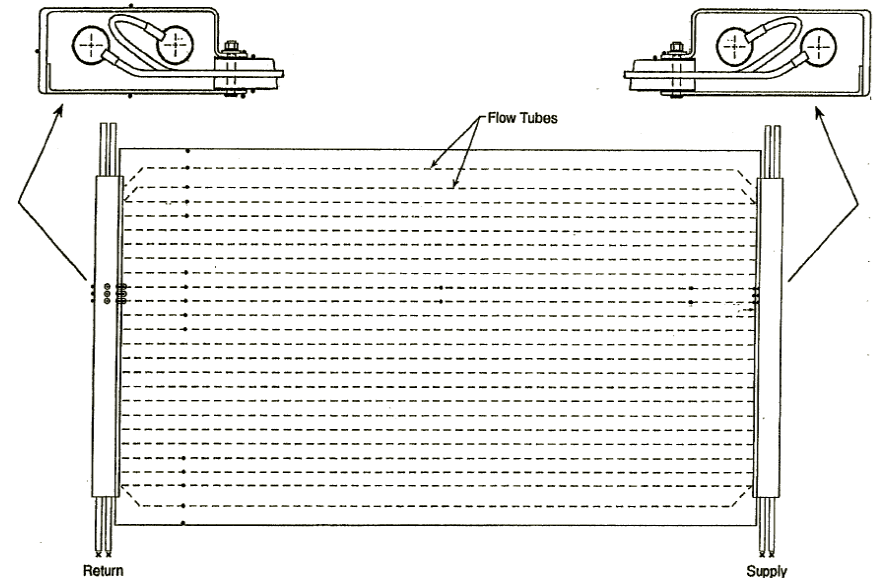



Shuttle Radiator Panels

- Shuttle radiator flow tubes are located directly below facesheet and are relatively thin-walled (0.02" thick)
- Shuttle flow tubes are more vulnerable than ISS radiators to MMOD failure
- Aluminum doublers adhesively bonded to Shuttle radiator facesheets over each flow tube to improve MMOD penetration resistance & decrease leak risk
- Completed modification in 1999-2000 across Orbiter fleet

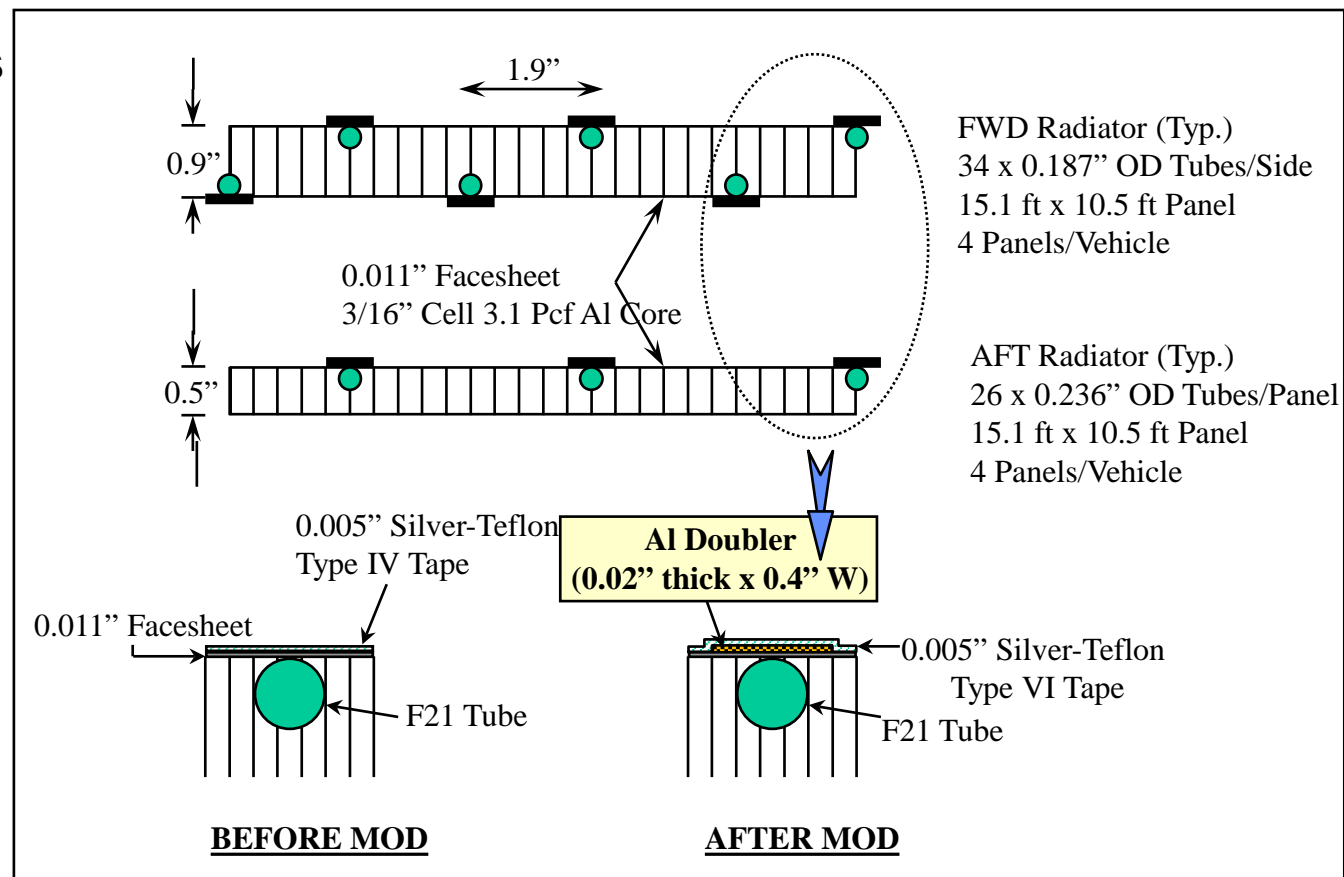

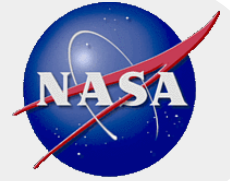

STS-128 Shuttle Radiator Impact

shows why adding protection to vulnerable areas of spacecraft is a good thing

- **During STS-128, an impact occurred on center-line of a radiator doubler, which protects the Shuttle radiator flow tubes from MMOD**
 - Impact crater penetrated through the thermal tape, completely through the 0.02" thick doubler, and damaged the facesheet below the doubler
 - Analysis indicates this impact would have penetrated the flow tube if the doublers were not present
 - Doublers added in 1997-1999 time period, to provide additional protection for ISS missions
 - Conclusion: Doublers performed as designed, preventing a radiator tube puncture

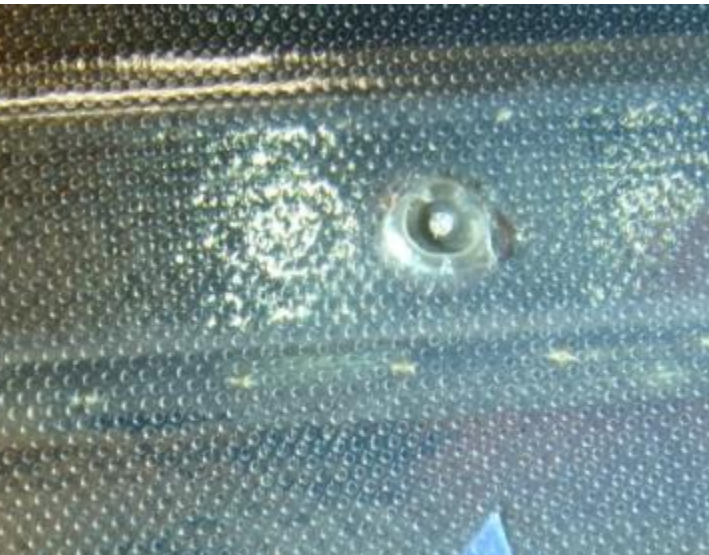
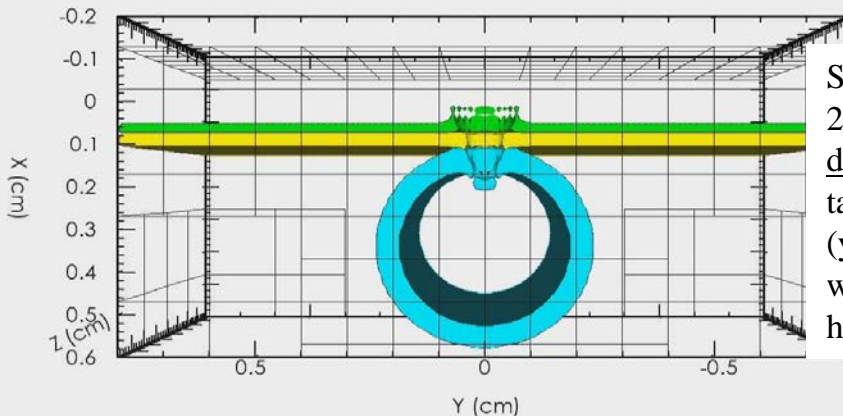
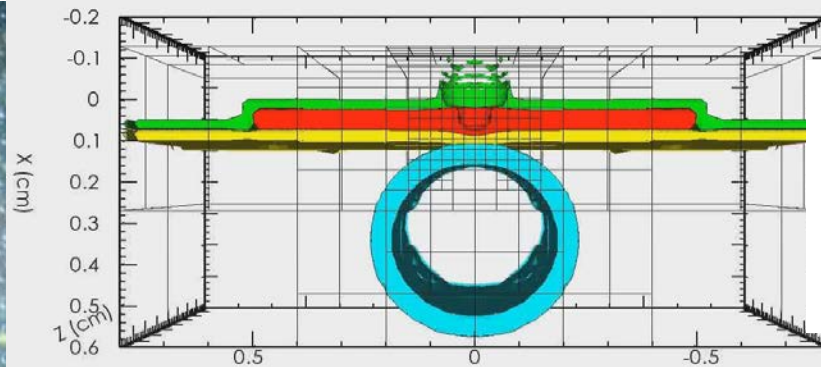
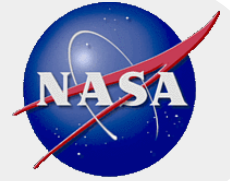

Image of MMOD impact into LH1 Radiator doubler protecting flow-tubes

Crater diameter in Al doubler = 0.8 mm
 Crater depth = 0.58 mm
 Doubler thickness = 0.51 mm





Radiator Hypervelocity Impact References

- J. Hyde, E. Christiansen, D. Lear, J. Herrin, Recent Shuttle Post-Flight MMOD Inspection Highlights, IAC-10.A6.3.1, presented at the 61st International Astronautical Congress, Prague, CZ, 2010
- J.L. Hyde, E.L. Christiansen, D.M. Lear, J.H. Kerr, Micrometeoroid and Orbital Debris Threat Mitigation Techniques for the Space Shuttle Orbiter, Fifth European Conference on Space Debris, 2009
- D. Lear, E. Christiansen, J. Hyde, J. Herrin, F. Lyons, J. Kerr, S. Ryan, Investigation of Shuttle Radiator Micro-Meteoroid & Orbital Debris Damage, AIAA 2009-2361, 50th AIAA/ASME/ASCE/AHS/ASC Structures, Structural Dynamics, and Materials Conference, 4 - 7 May 2009, Palm Springs, California, 2009
- NASA JSC-66365, Radiator Hypervelocity Impact (HVI) Crater Characterization Study Test Program, Phase – 2, 2012
- NASA JSC-66366, Radiator Hypervelocity Impact (HVI) Crater Characterization Study Test Program, Phase – 1, 2012
- NASA JSC-28524, Hypervelocity impact testing of betacloth covers on Orbiter radiator external lines, 2001
- E.L. Christiansen, R. Bernhard, and N. Hartsough, Orbiter Meteoroid/Orbital Debris Impacts: STS-50 (6/92) through STS-86 (10/97), NASA JSC-28033, August 1998
- E.L. Christiansen, J.L. Hyde, and R.P. Bernhard, Space Shuttle Debris and Meteoroid Impacts, Advances in Space Research, Vol. 34, Issue 5, pp. 1097-1103, 2004, presented at World Space Congress, 2002
- J.P. Loftus, E. Christiansen, W.C. Schneider, and M. Hasselbeck, Shuttle Modifications for Station Support, IAF-97-IAF.I.3.08, 48th International Astronautical Congress, October 6-10, 1997
- T.E. Jensen, S.E. Loyd, D.W. Whittle, E.L. Christiansen, Visible Effects of Space Debris on the Shuttle Program, IAA-97-IAA.6.4.02, 48th International Astronautical Congress, October 6-10, 1997
- E.L. Christiansen, R.P. Bernhard, J.L. Hyde, J.H. Kerr, K.S. Edelstein, J. Ortega, and J.L. Crews, Assessment of High Velocity Impacts on Exposed Space Shuttle Surfaces, ESA Report on proceedings of the First European Conference on Space Debris, ESA SD-01, pp.447-452, April 5-7, 1993
- J.L. Rhatigan, E.L. Christiansen, and M.L. Fleming, On Protection of Freedom's Solar Dynamic Radiator From the Orbital Debris Environment: Part I - Preliminary Analysis and Testing, Journal of Solar Energy Engineering, Vol.114, p.135, August 1992
- J.L. Rhatigan, E.L. Christiansen, and M.L. Fleming, On Protection of Freedom's Solar Dynamic Radiator From the Orbital Debris Environment: Part II - Further Testing and Analysis, Journal of Solar Energy Engineering, Vol.114, p.142, August 1992
- J.L. Rhatigan, E.L. Christiansen, and M.L. Fleming, On Protection of Freedom Solar Dynamic Radiator from the Orbital Debris Environment: Part 2 – Further Testing and Analyses, NASA TM-104514, April 1992
- J.L. Rhatigan, E.L. Christiansen, and M.L. Fleming, On Protection of Freedom Solar Dynamic Radiator from the Orbital Debris Environment: Part I - Preliminary Analysis and Testing, NASA TM-102458, April 1990

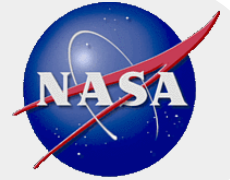

Thermal protection systems (TPS) for crew return vehicles

- **MMOD risk to thermal protection system (TPS) of ISS crew return vehicles (Soyuz, Commercial vehicles) is high**
 - Concern is TPS damage that can lead to loss-of-vehicle during reentry
 - Issue can be mitigated by inspection and repair or safe-haven (not Program baseline)

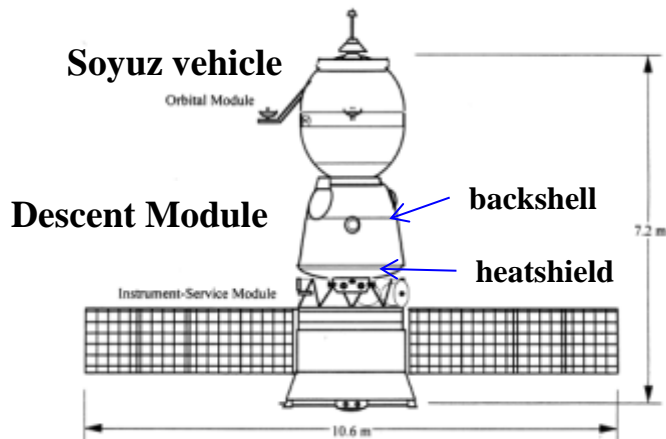

INC 37 Soyuz 35S
Cupola W5
DSs w/180mm lens
October 25, 2013



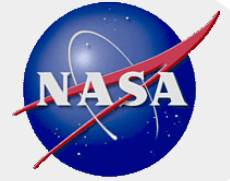

Thermal protection systems (TPS) for crew return vehicles (cont.)

- **TPS example: Low-density ceramic tiles cover backshell of Orion crew module**
- **Impact penetrations into TPS that extend to bondline with substrate are limits of allowable damage**
- **Typical hypervelocity damage: craters with “fingers” of higher density debris that extend beyond crater boundary**
- **Inspection and or sensors could be used to find critical damage before reentry**
- **TPS repair or rescue flight needed if critical damage found in inspection**

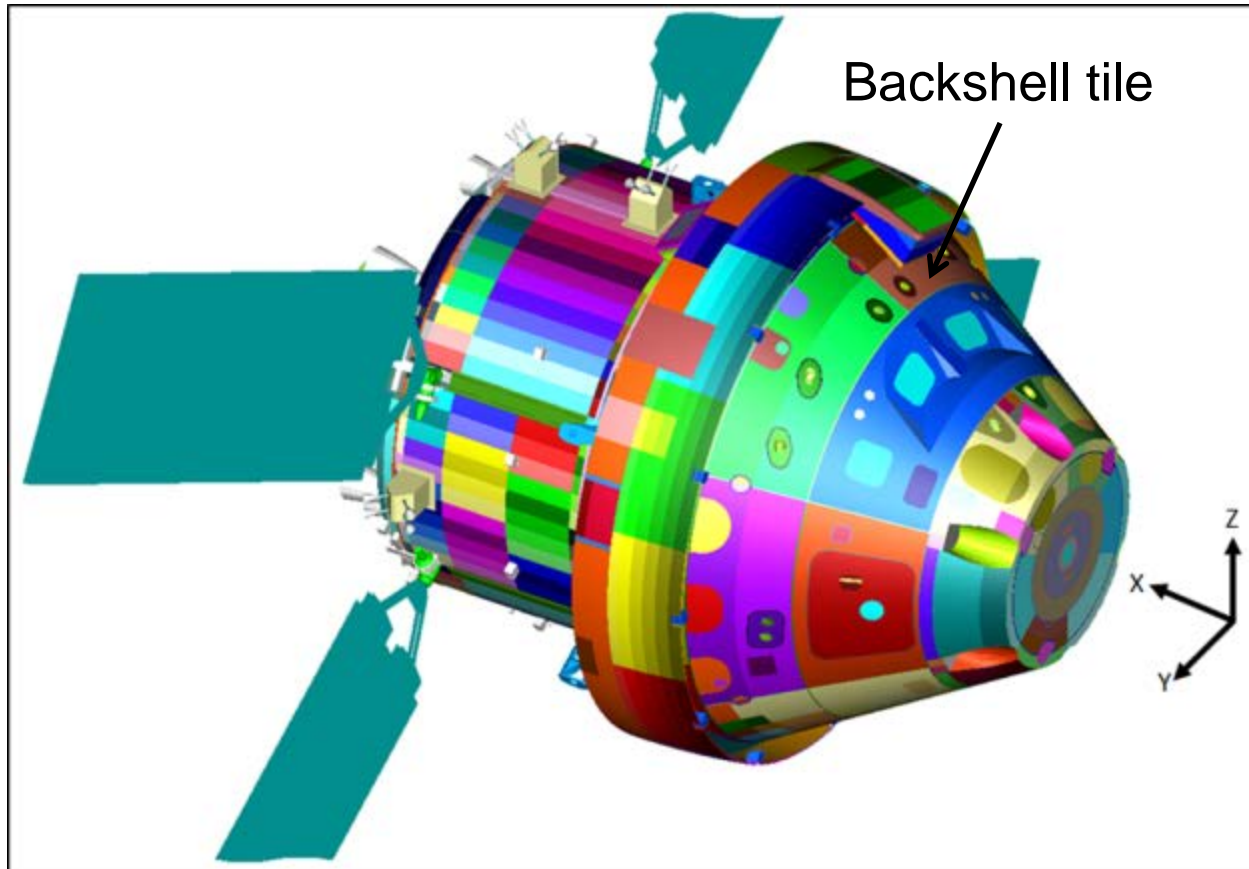



Typical Thermal Protection System (TPS) Tile Impact Damage

Tile Test HITF-7469

projectile: 2.4mm (3/32") diameter Al 2017T4, 7.00 km/s, 0° impact angle



Top view

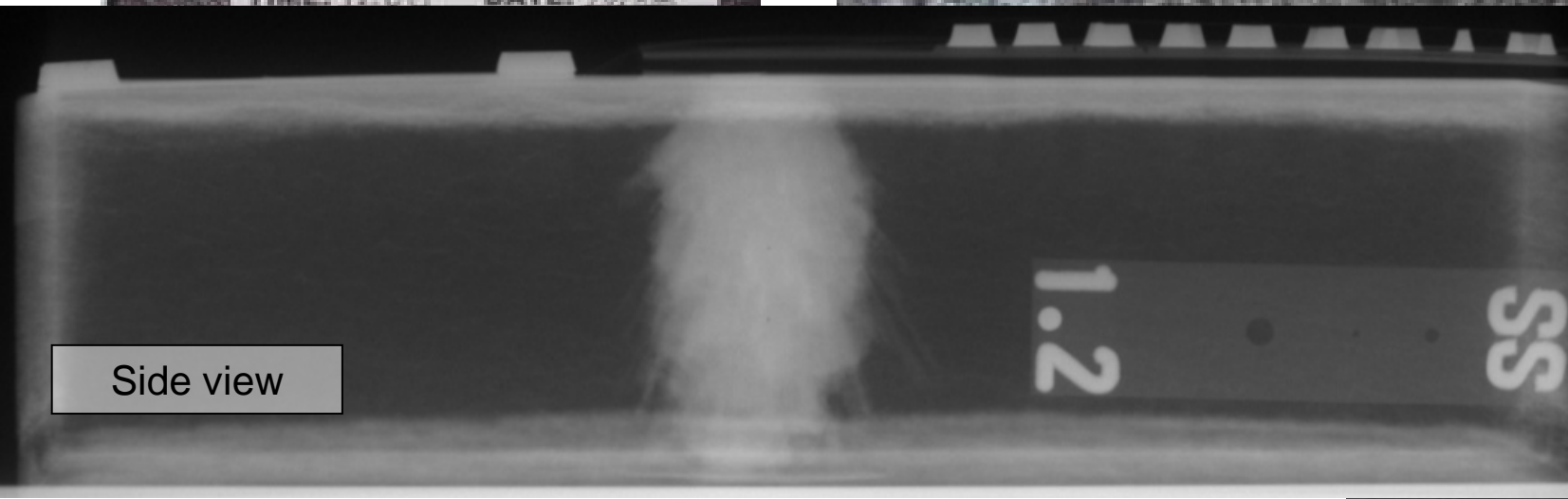
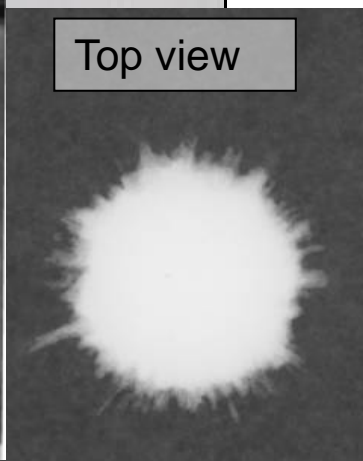

Side view

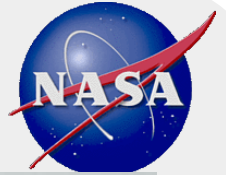

CT Scans of Tile Damage

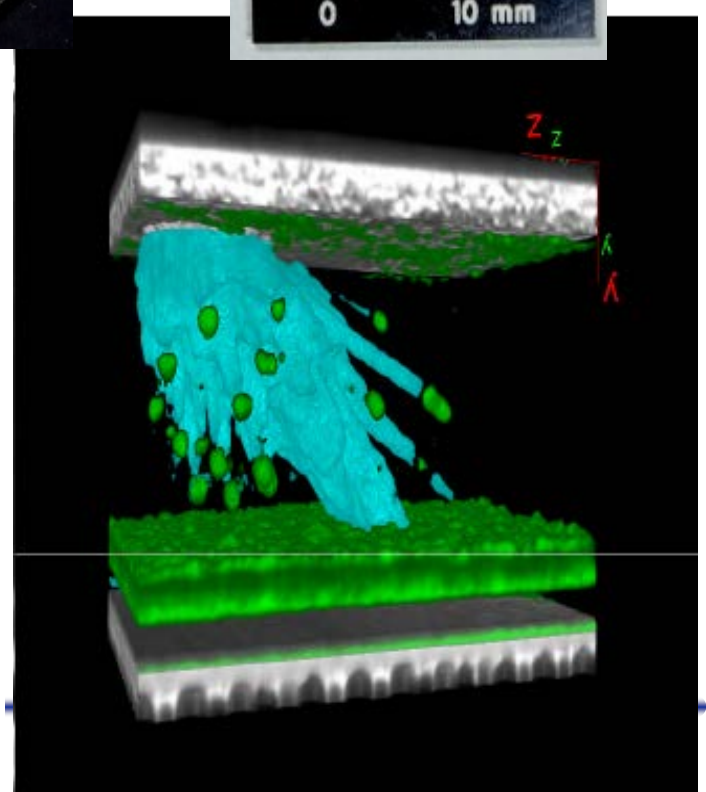
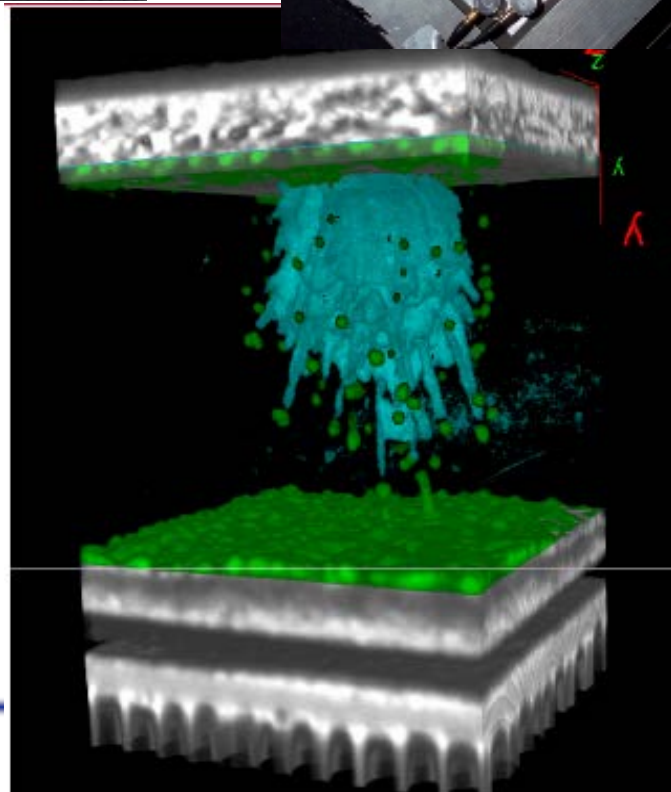
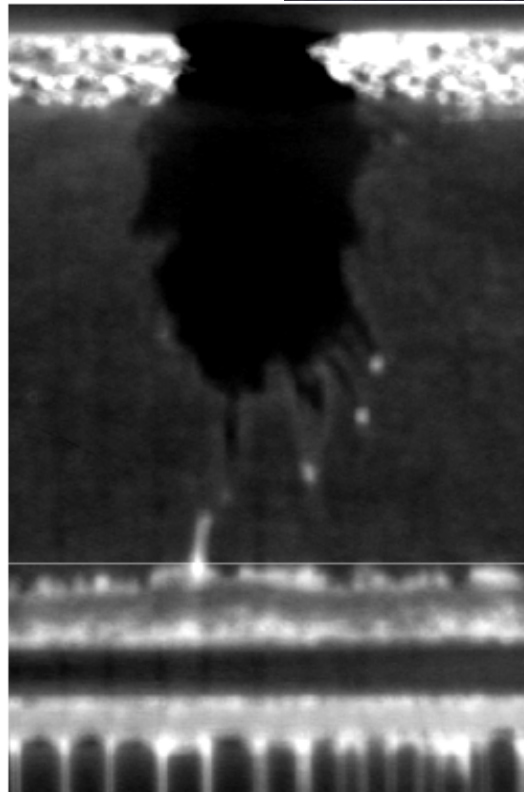
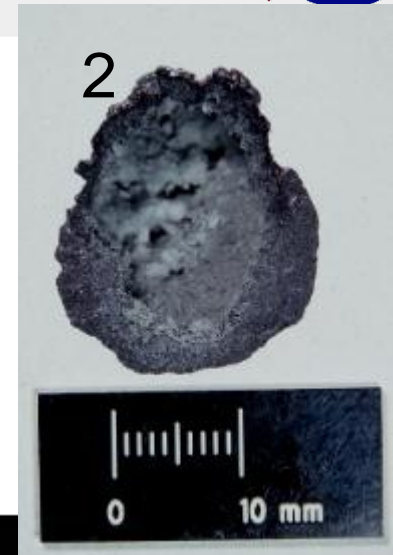
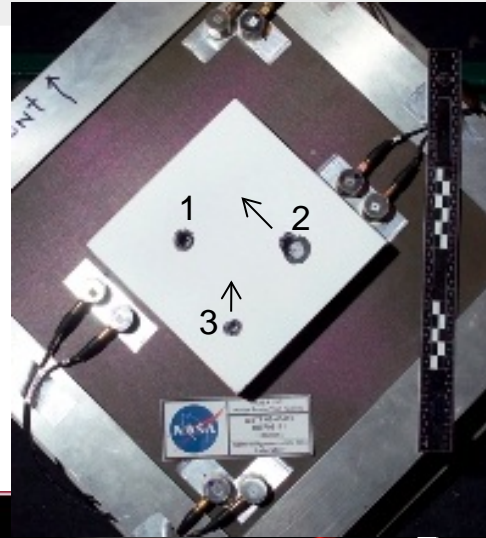
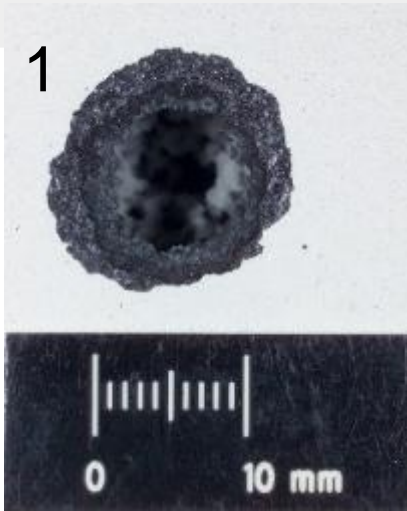

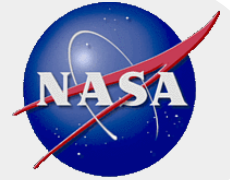

TPS Coating Damage

- Coatings on TPS can be important in reentry survivability
- Example: Si-C coating on Reinforced Carbon-Carbon of Shuttle wing-leading edge and nose cap
- Coating damage was considered limits of acceptable damage for “hot” areas of wing leading edge and nose cap based on results of hypervelocity impact tests and arc-jet tests, as well as thermal analysis

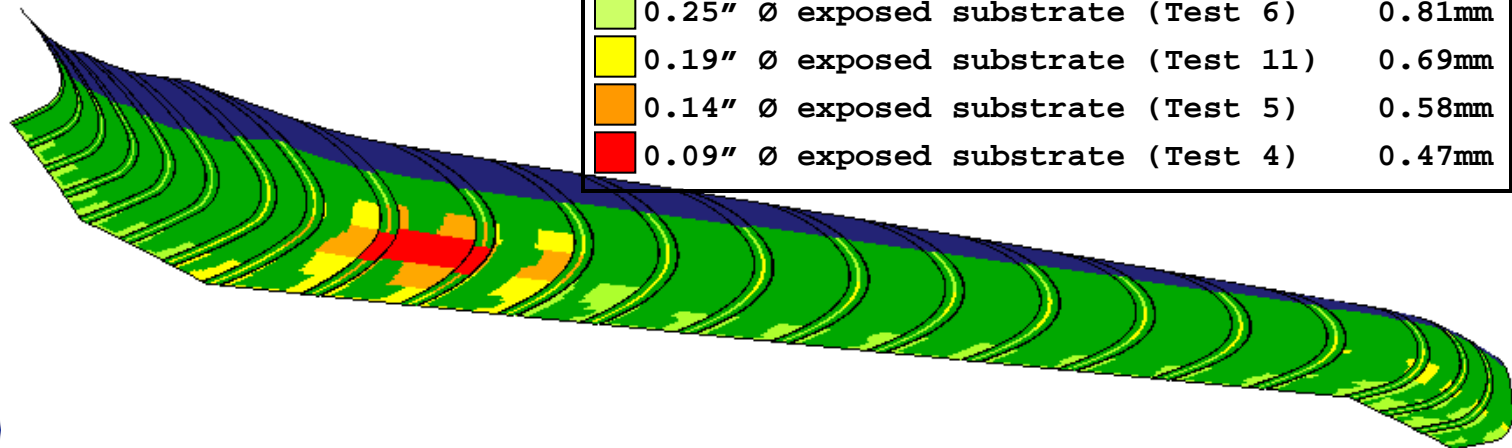

<u>Failure Criteria</u>	<u>Critical Orbital Debris \emptyset (7km/s & 0°)</u>
1.00" \emptyset hole	4.89mm
0.50" \emptyset hole	2.75mm
0.25" \emptyset hole	1.68mm
0.12" - 0.99" \emptyset hole	1.10-4.84mm
0.25" \emptyset exposed substrate (Test 6)	0.81mm
0.19" \emptyset exposed substrate (Test 11)	0.69mm
0.14" \emptyset exposed substrate (Test 5)	0.58mm
0.09" \emptyset exposed substrate (Test 4)	0.47mm



RCC Failure Criteria "Test 6" Model 2238 (Front)

Test Condition: 2700F/100 psf **FAILED WITH SMALL BREACH (0.125")**

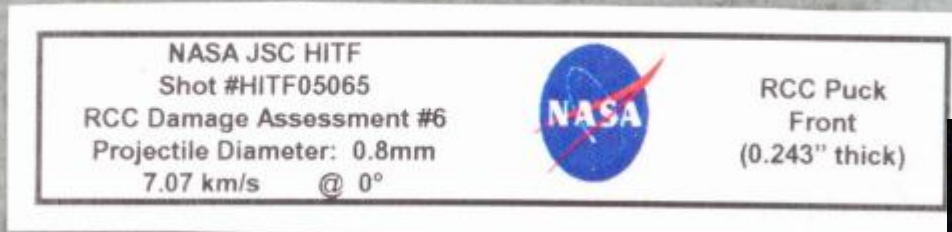

●
↑
Representative
of
Projectile size



Pre-Arc-Jet Test A308-9
Model 2238
Exposed Substrate: 0.25" x 0.26"

Post Arc-Jet Test (0.125" through-hole)
Test Notes: No surface activity until 811 sec. Small hole developed but arrested by glass flow. Total test duration: 900 sec.





Window Damage & MMOD Protection

- **Spacecraft windows typically are multiple panes of glass/transparent materials**
 - Thermal pane or debris pane
 - Redundant pressure panes (typical)
- **MMOD impacts on fused-silica glass creates large diameter craters relative to impactor size**
 - Typical crater diameters 30-50x impactor diameter in HVI tests
 - Issue for pressure panes and for re-use of thermal panes (e.g. Shuttle)
- **Window protection:**
 - Thermal panes for reentry vehicles, debris panes for spacecraft, exterior of pressure pane(s)
 - Shutters (ISS): US Lab window has single wall shutter, Cupola has multiwall shutters
 - Window materials
 - Fused-silica: conventional window material for both thermal/debris panes and pressure panes, brittle, good optical qualities
 - Polycarbonate (Hyzod): hatch window external cover
 - Acrylic: pressure pane alternative
 - Tempered glass (Chemcor): high-strength but very-low MMOD damage tolerance

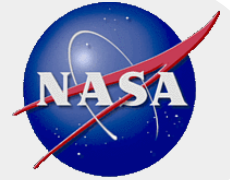

Observed Spacecraft MMOD Impacts Shuttle Windows

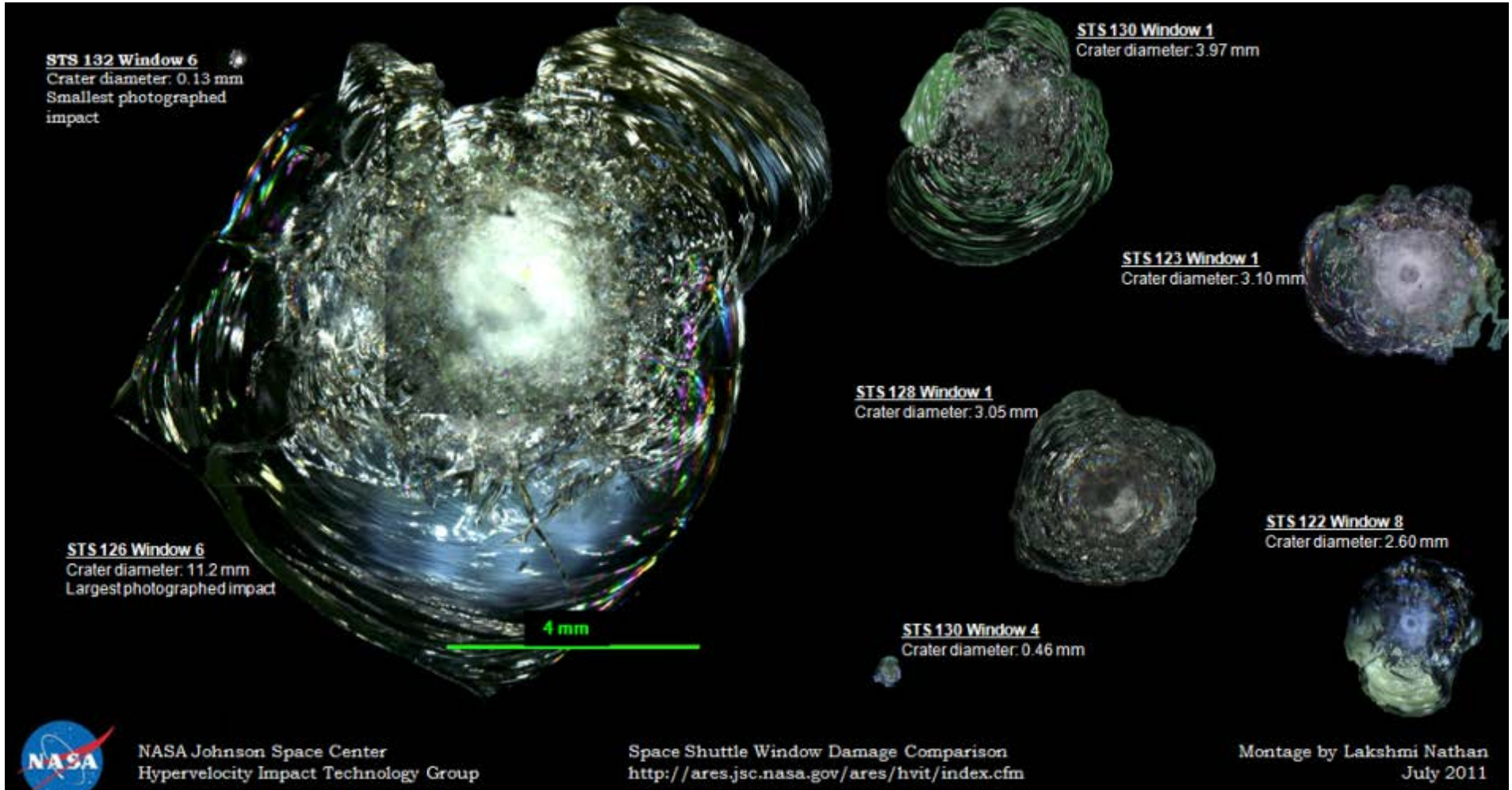

Sampling of Shuttle Window MMOD Impact Craters
(all displayed on same dimensional scale)

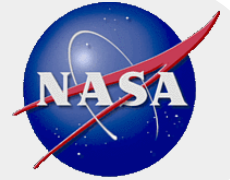

MMOD Impacts on Windows

- **Window ports are exposed to meteoroid/orbital debris impact**
 - Over 1500 hypervelocity pits identified on Shuttle windows and ~130 of these large enough to caused window replacement

Service Module Window 7 Impact
~7mm across outer crack features



STS-94 Window damage observed on-orbit
0.6mm deep, Al impactor

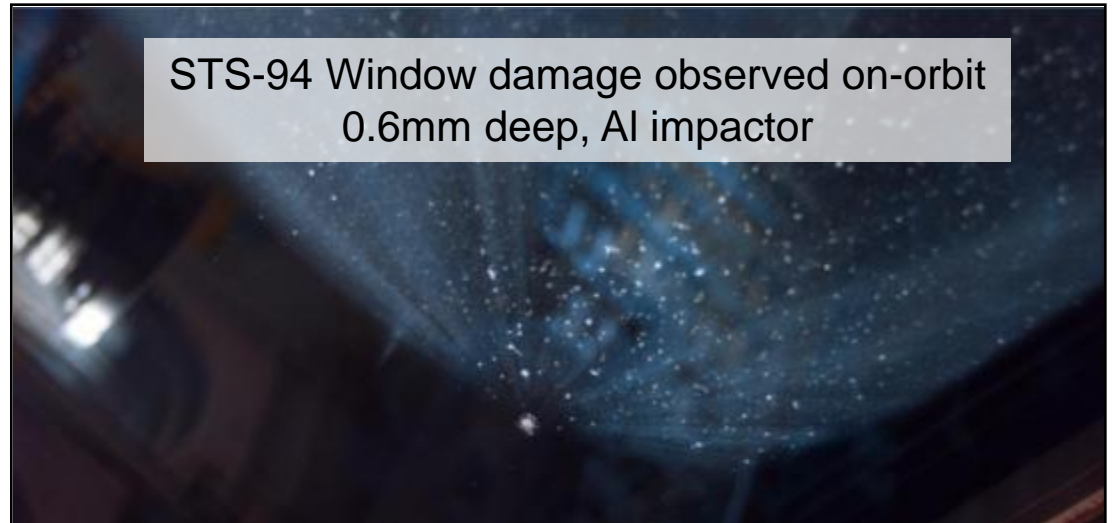

STS-59 Side Hatch Window Damage

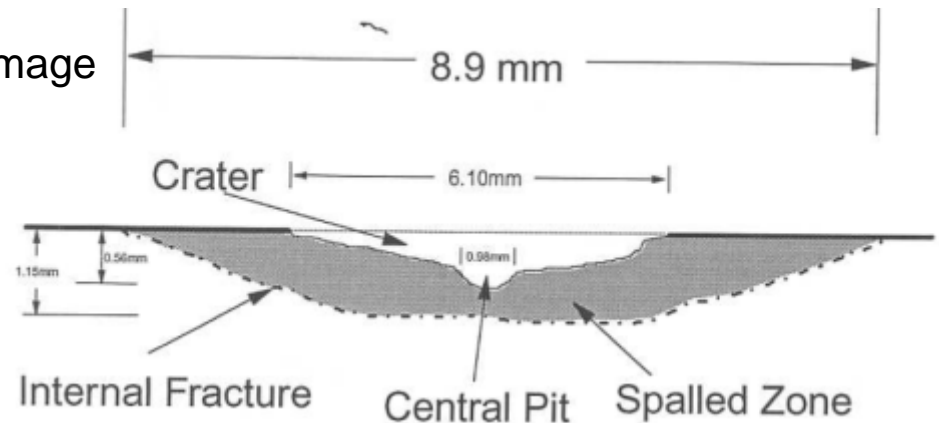
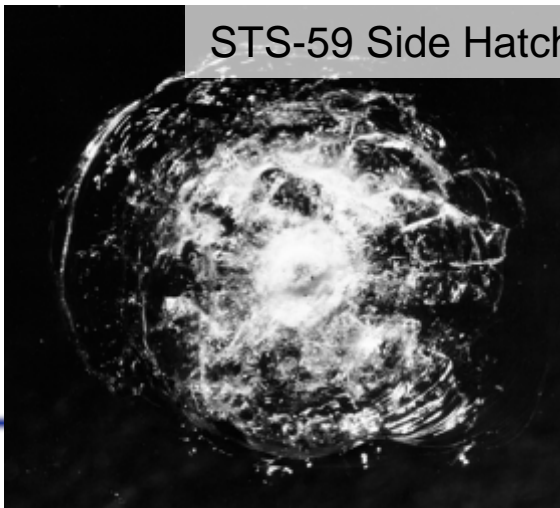

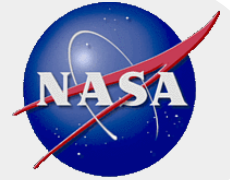

Fused-Silica Internal Glass Damage

- **Internal crack studies performed by polishing the sides of impacted samples and measuring internal damage**

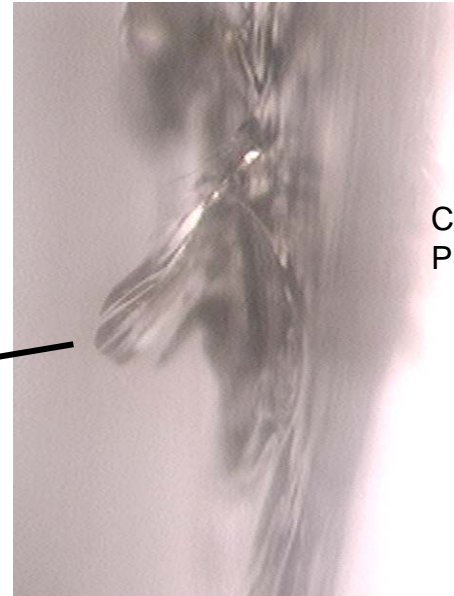
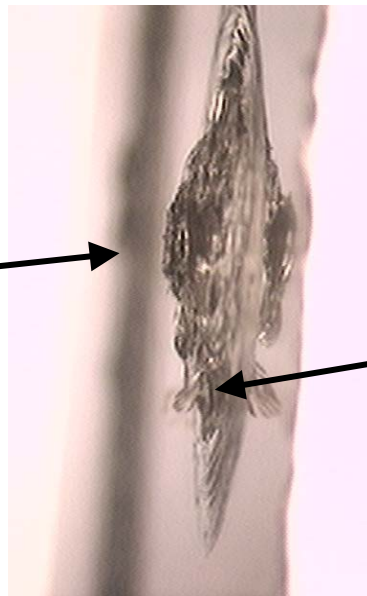

Test: JSC-120069
Crater: 15.8mm dia. by 0.9mm deep
Projectile: 0.4mm dia. Al, 5.24km/s, 0°

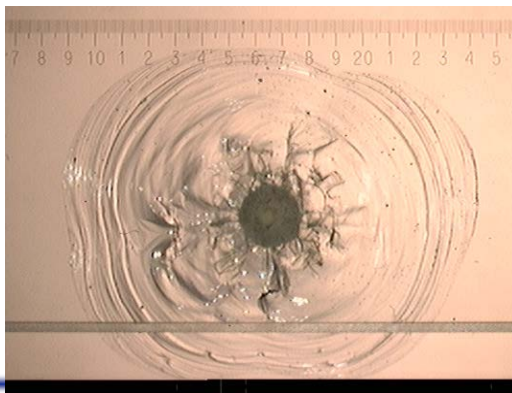

Back-lit

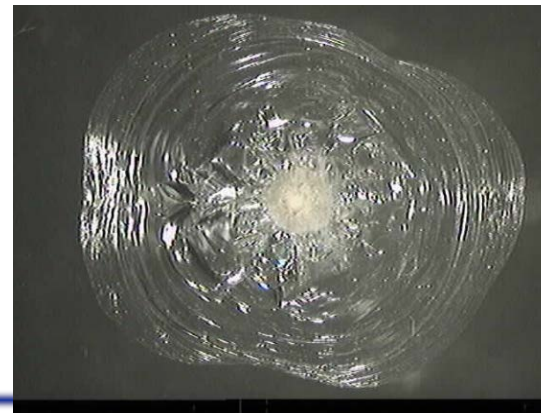

Front-lit



Test Results (Unpressurized vs. Pressurized)

- **Projectile Conditions: 0.8 mm diameter Al 2017T4, 6.9 km/s, 0°**

Unpressurized – Glass Unstressed

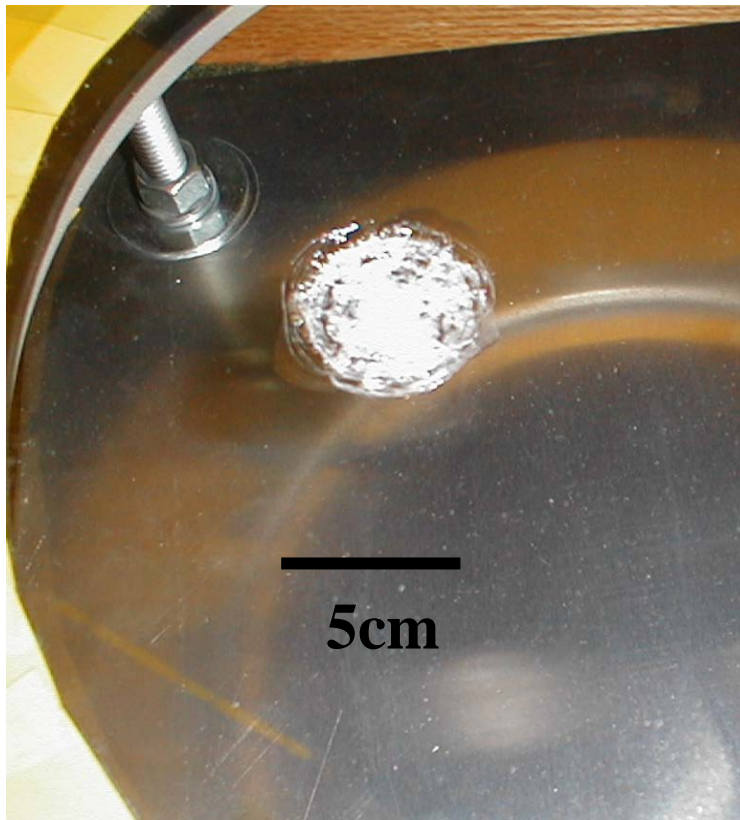

Pressurized – Glass Stressed

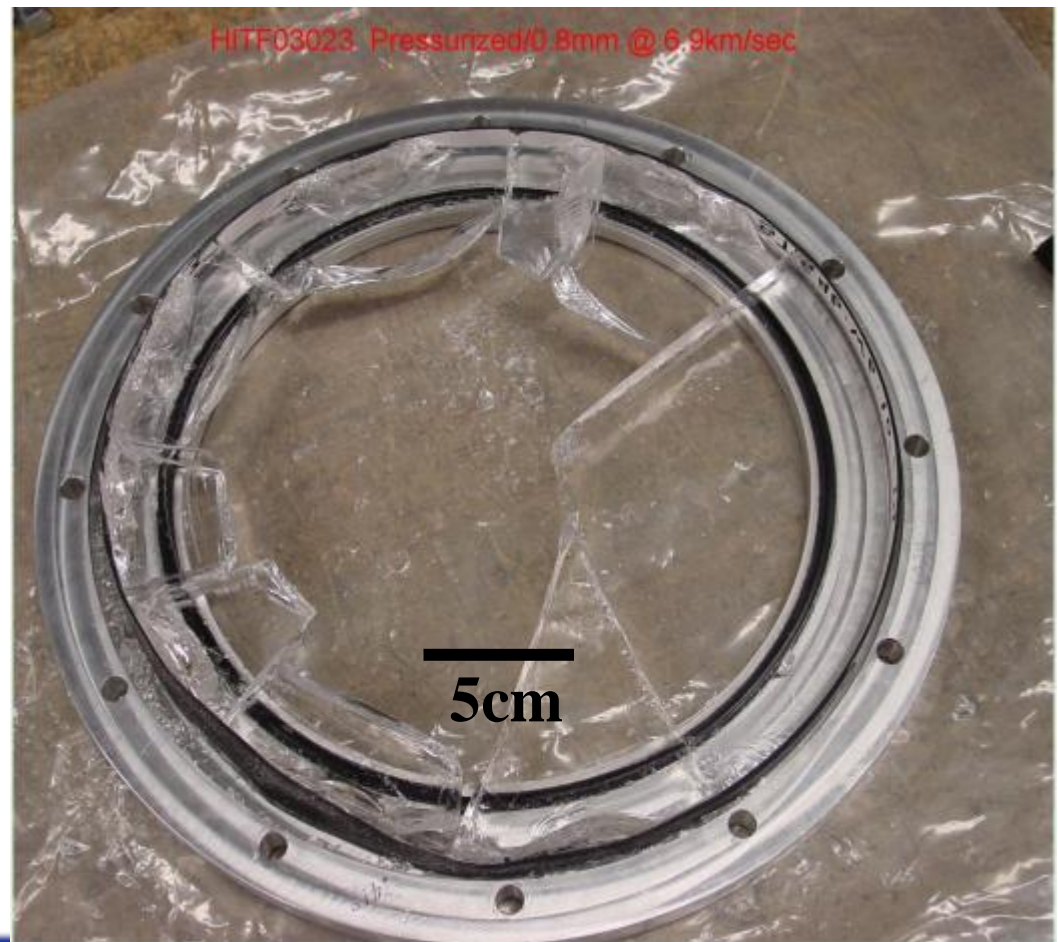



Cupola Shutters

- ISS Cupola have multi-layer Shutters that provide MMOD protection of the windows, when the shutters are closed



1.3cm Al particle on
Ballistic Limit @ 7km/s, 0°



Al Shutter Hat (0.2cm)

2nd Al layer (0.127cm)

Nextel AF62 (3 sheets)

Kevlar KM2 (14 sheets)

Al 6061 Catcher Plate (0.25cm)

Debris Pane
(t=0.37" overhead, 0.38" sides)

Redundant
Pressure Pane
(t=1.45" overhead, 1.00" sides)

Primary
Pressure Pane
(t=1.45" overhead, 1.00" sides)

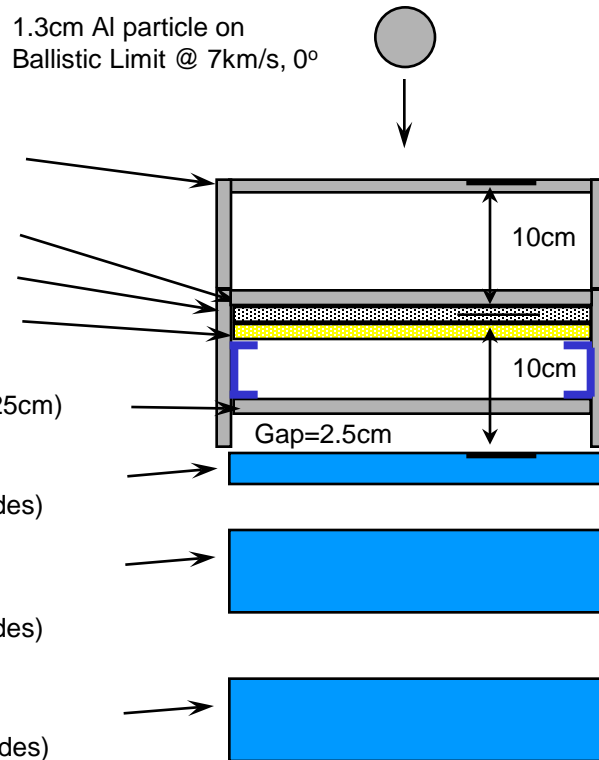

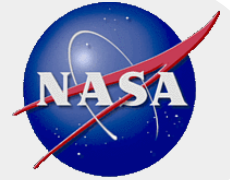

ISS Solar Array Damage

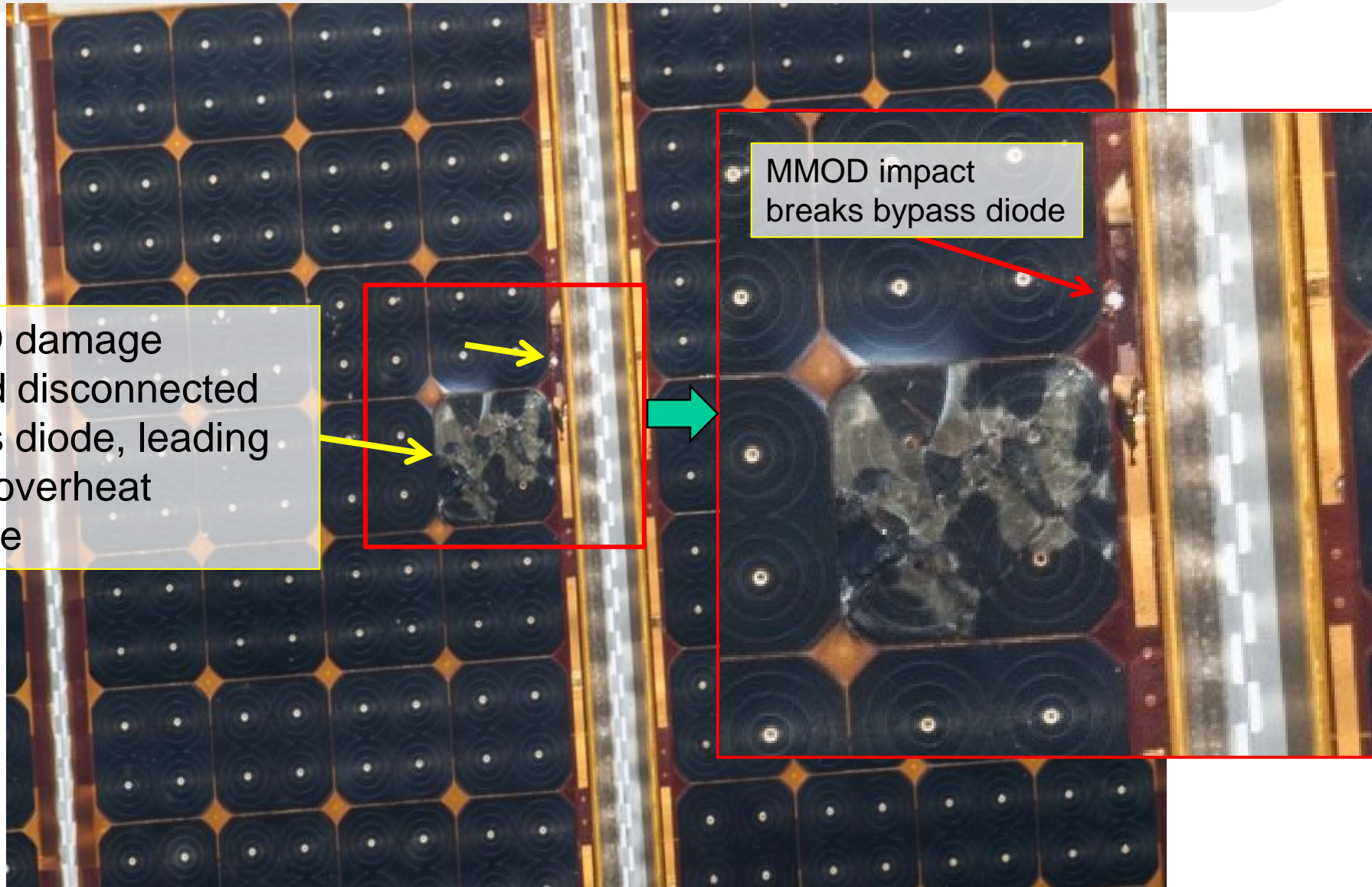

MMOD damage caused disconnected bypass diode, leading to cell overheat damage

MMOD impact breaks bypass diode

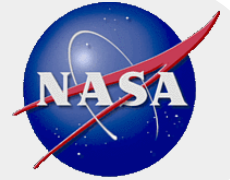

Solar Array Damage

MMOD impact breaks bypass diode causing overheat

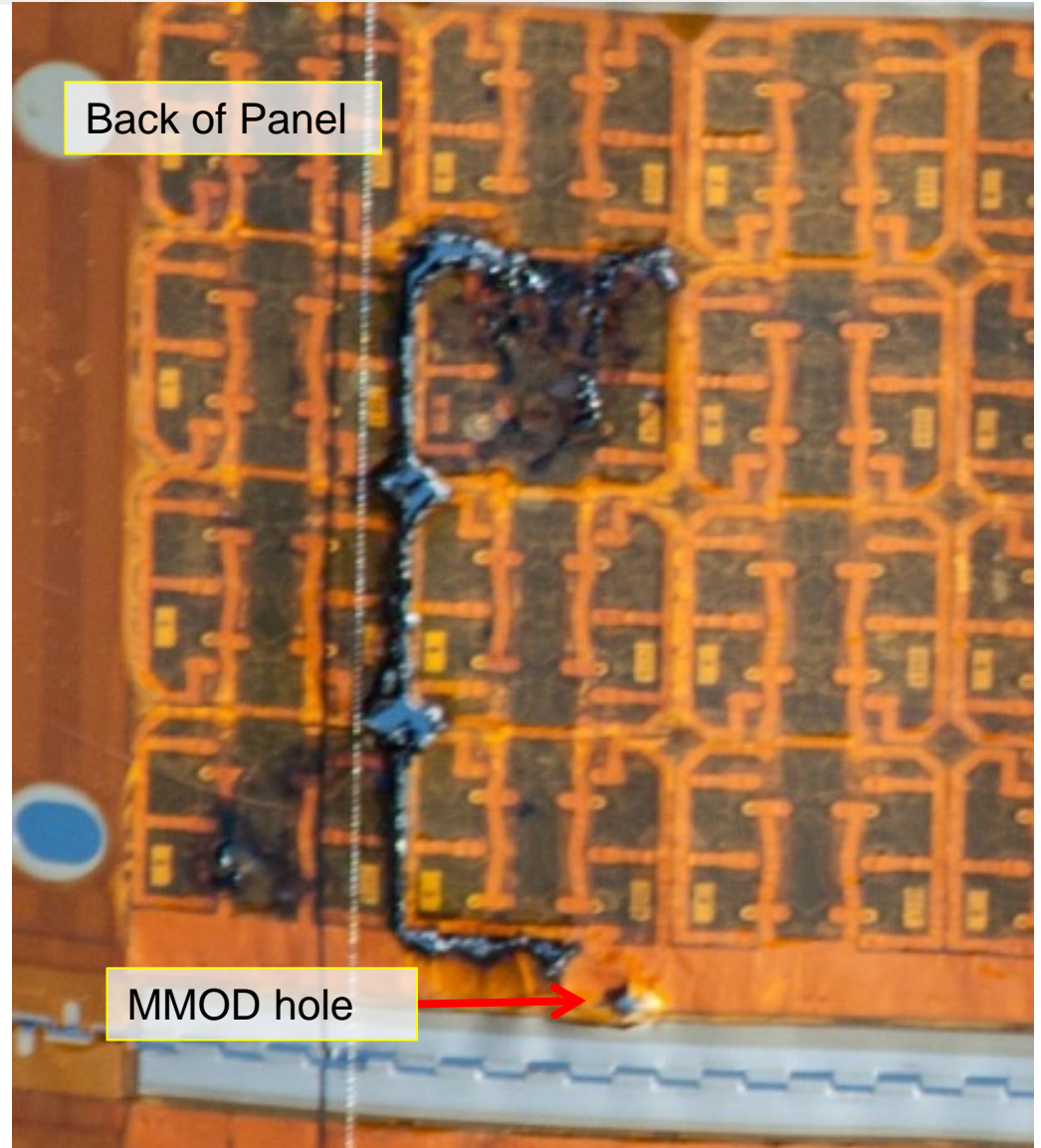
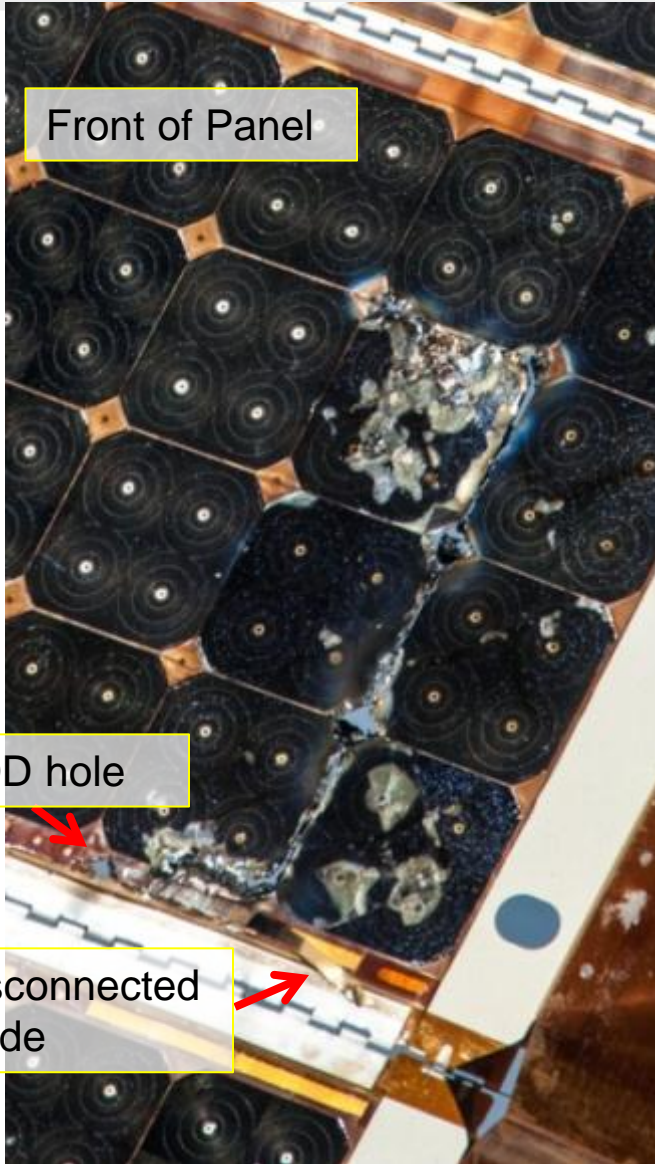

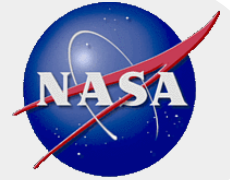

ISS Solar Array Mast

- **Deployable structural booms or masts used to support ISS solar arrays**

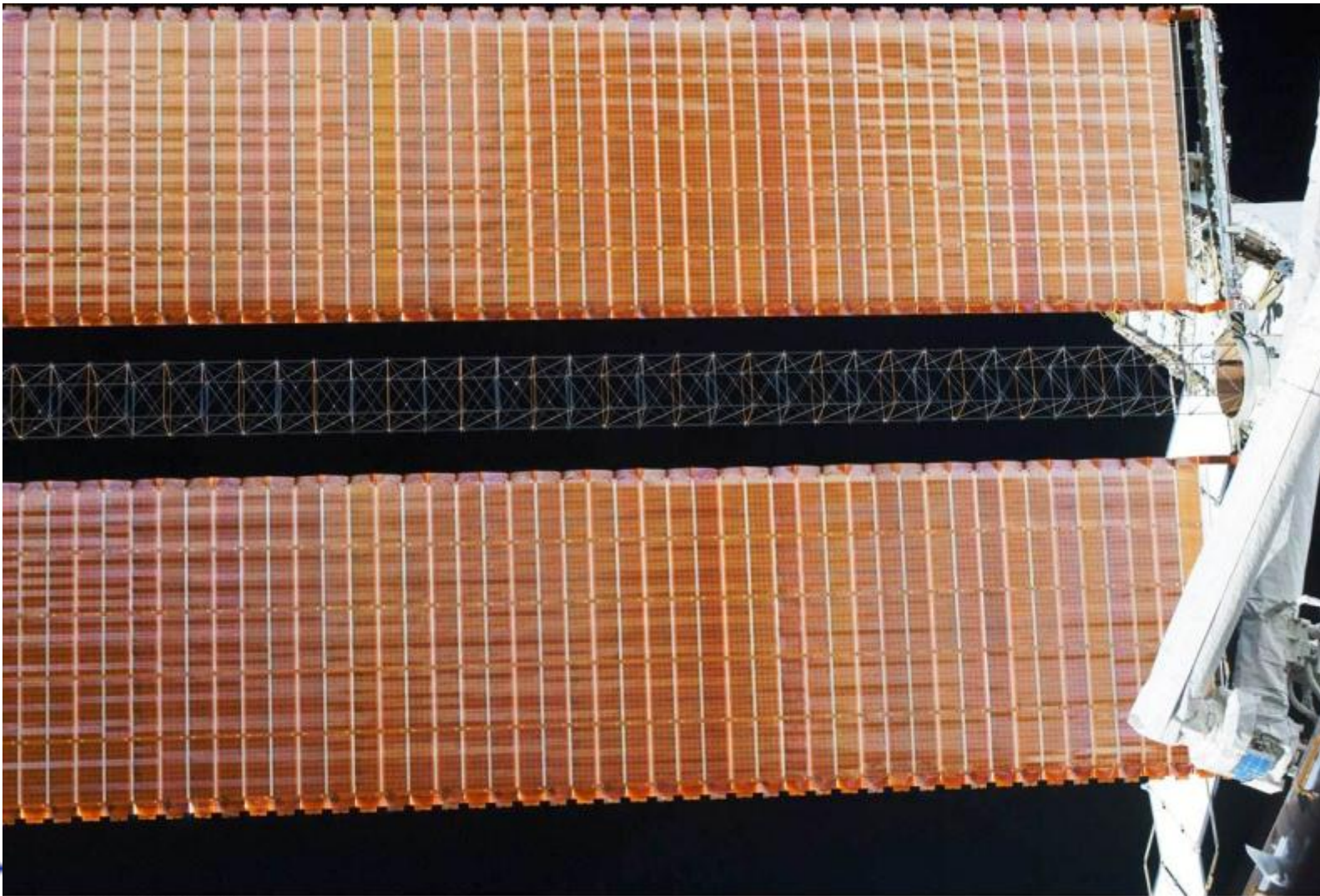

ISS022E067792



MMOD Damage to ISS Solar Array Masts

- Elements of the solar array masts have been damaged from MMOD impacts
- If critical damage to mast elements found during inspection, solar array will need to be operated under restricted/protect flight rules

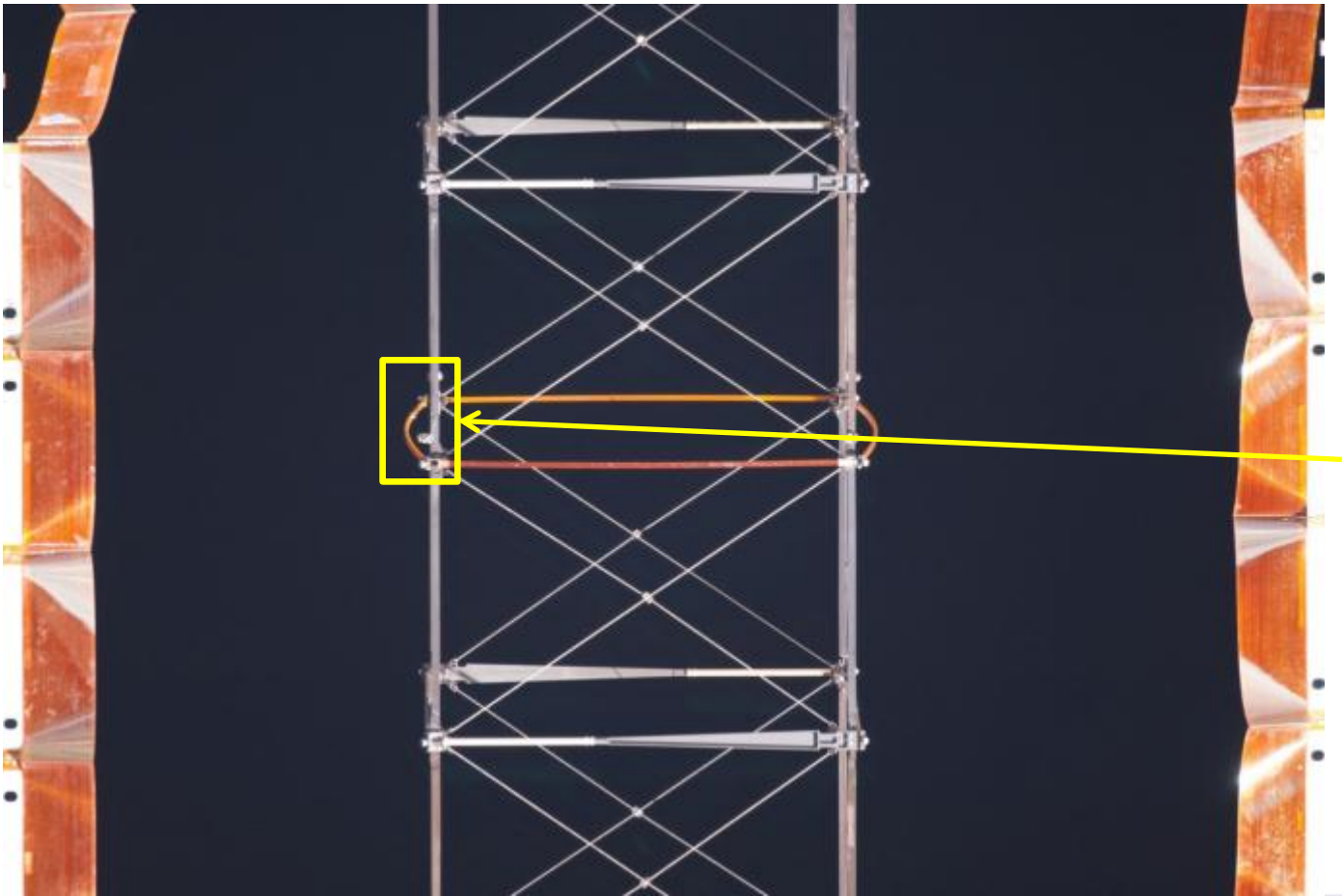



Hypervelocity impact tests

- **Mast elements have been hypervelocity impact tested and structurally tested to assess residual strength for ISS life extension**

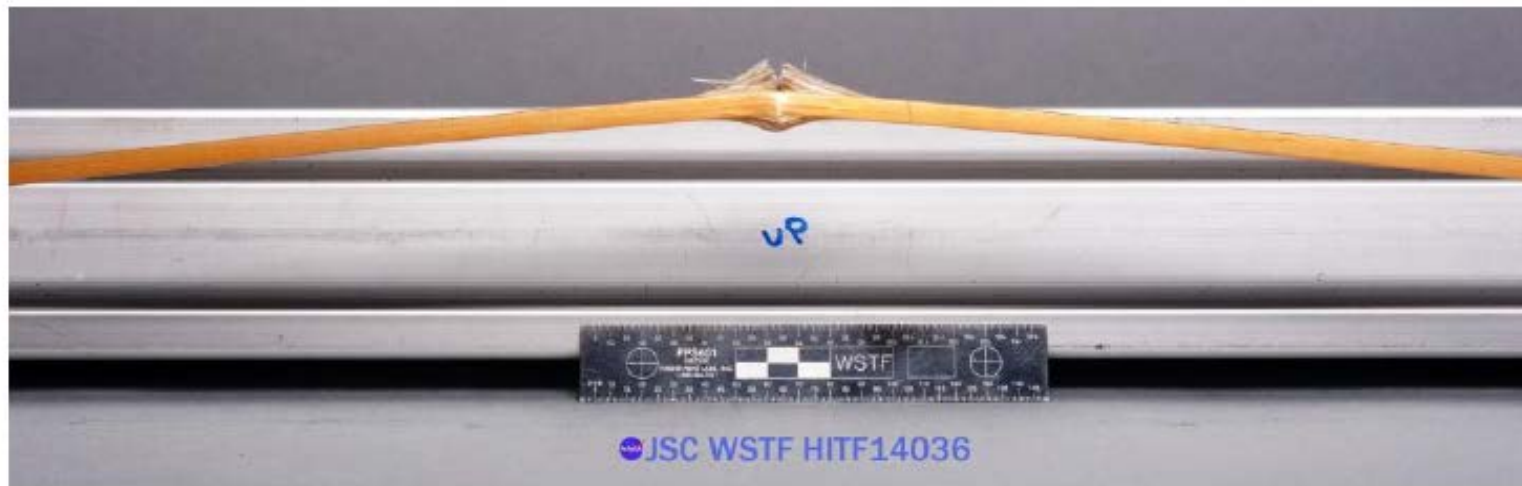

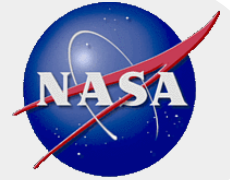

Handrail and EVA tool MMOD damage

- Many craters noted to ISS handrails and EVA tools
- Sharp crater lips have lead to cuts on EVA gloves
- EVA terminated early on STS-118 due to glove cuts
- Modifications to EVA suit and ISS EVA procedures necessary to reduce cut glove risk from MMOD damage

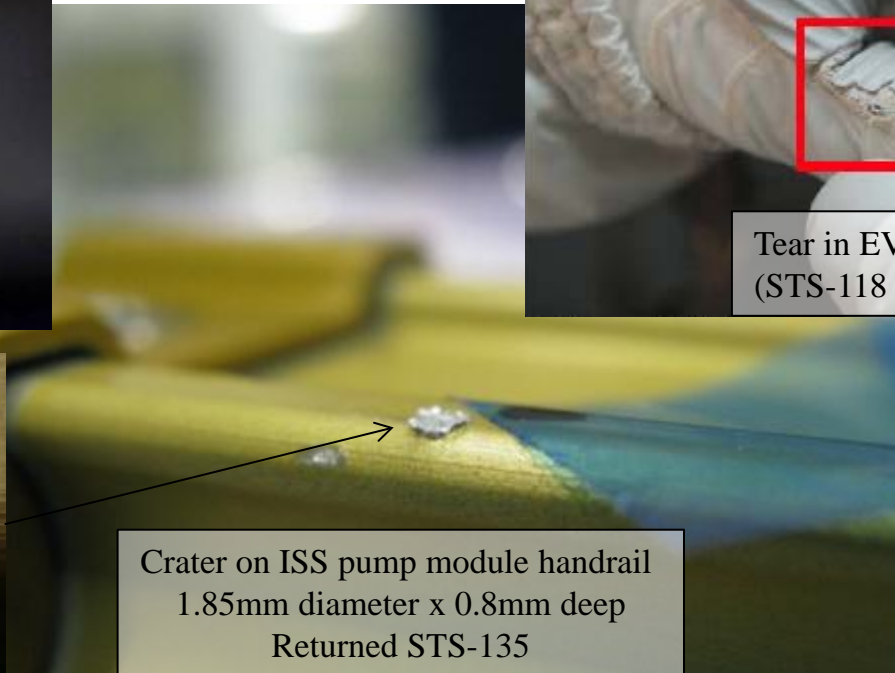

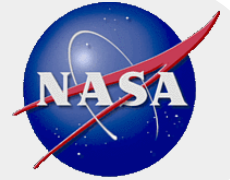

Thermal Blankets

- **Thermal blankets are typically light-weight and easily penetrated by MMOD impacts**
- **Toughened thermal blankets incorporate additional MMOD layers to improve projectile breakup and stopping capability**
 - Additional data available in NASA/TM-2014-218268, Volume I & II, Micrometeoroid and Orbital Debris (MMOD) Design and Analysis Improvements, NASA Engineering and Safety Center Report NESC-RP-12-00780

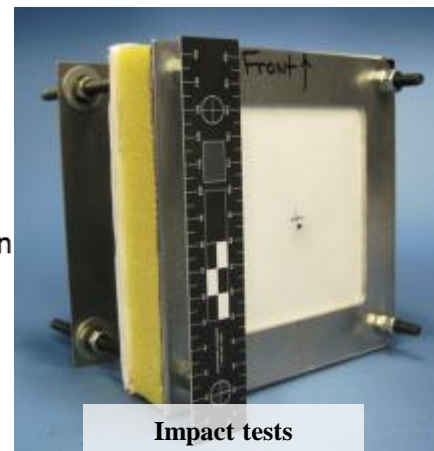
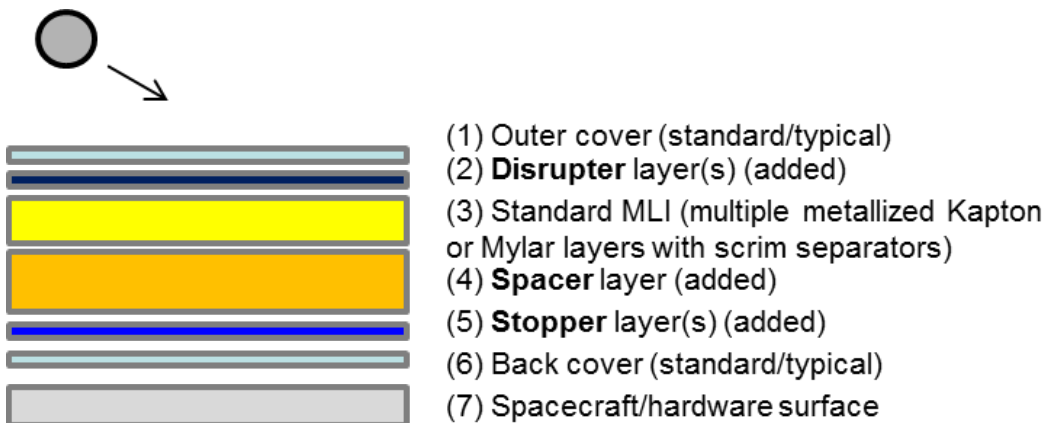
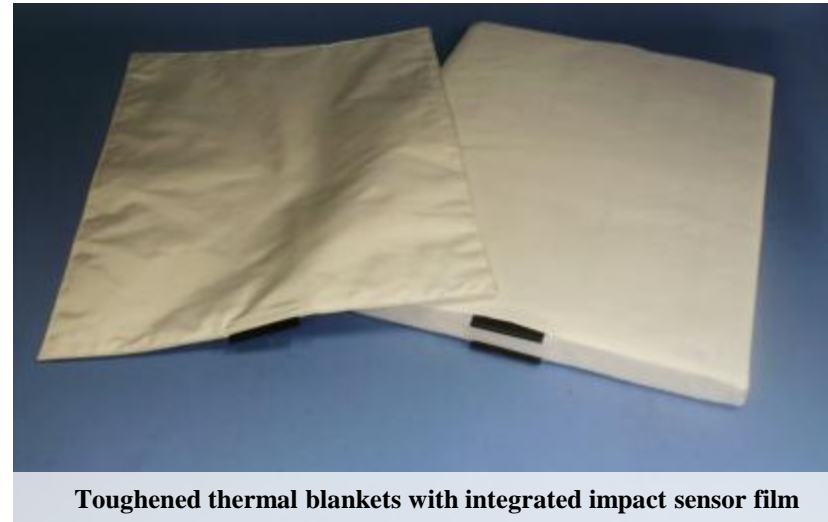

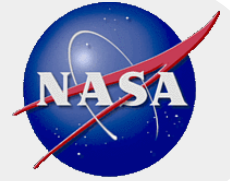

Concluding Remarks

- **Highly effective MMOD shields have been developed & implemented on ISS and commercial vehicles**
- **Toughened radiator systems have been developed & implemented**
- **Reentry vehicles are sensitive to MMOD damage and require combination of improved design as well as operations (low-risk attitudes, on-orbit inspection) to reduce MMOD risk:**
 - Thermal protection systems
 - Windows
 - Radiators



BACKUP CHARTS

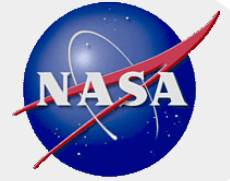

Progress CM Shielding

30deg impact data for Aluminum and Steel Projectiles

- Tests indicate approximately 2mm diameter aluminum projectile penetrates Progress CM shielding (creating hole in pressure shell), whereas 1mm diameter steel projectile penetrates Progress CM
 - Aluminum used with ORDEM 2000, steel with ORDEM 3.0
 - Risk increases substantially as MMOD penetration size decreases

Progress CM ballistic limits for Al Projectiles

No failure predicted below curves,
open data points = test no failure, closed data points = test fail

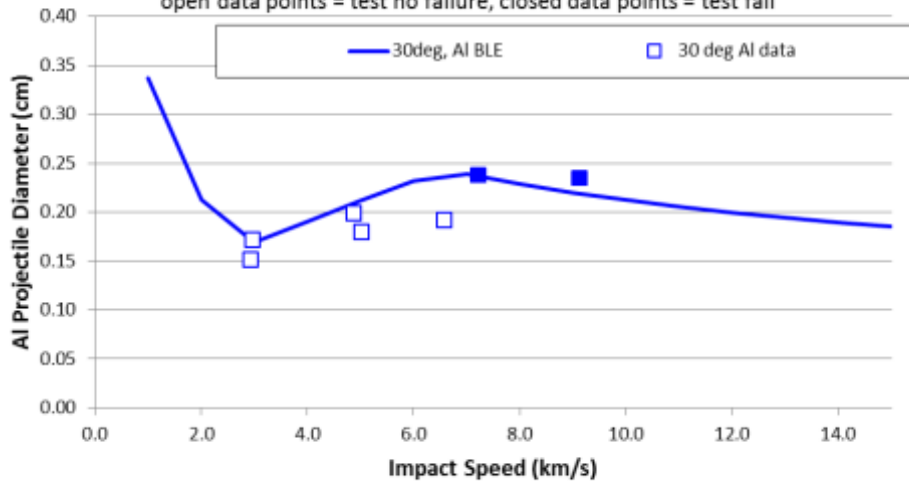

Progress CM ballistic limits for Steel Projectiles

No failure predicted below curves,
open data points = test no failure, closed data points = test fail

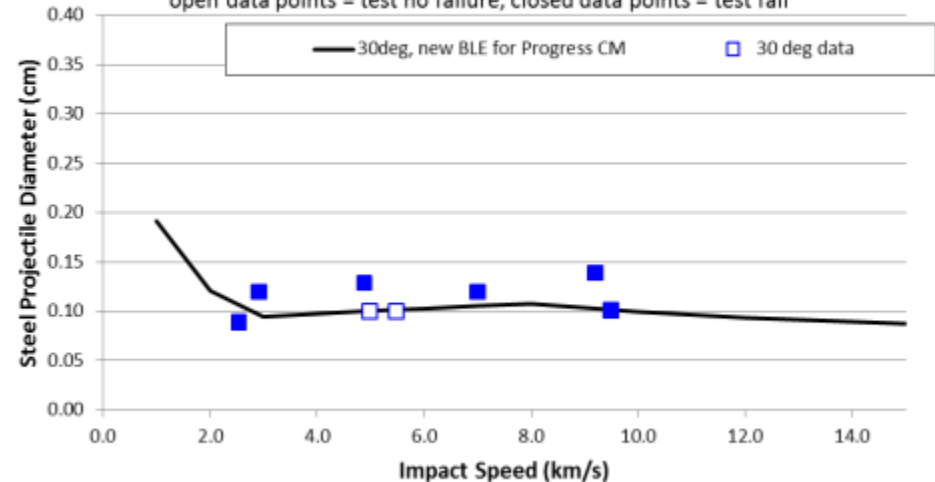



Ku-band antenna

- **An MMOD Strike was seen on the ISS Ku Antenna Gimbal Gear Cover. The image was captured during Mission ULF2 / STS-126.**
- **Interior damage?**

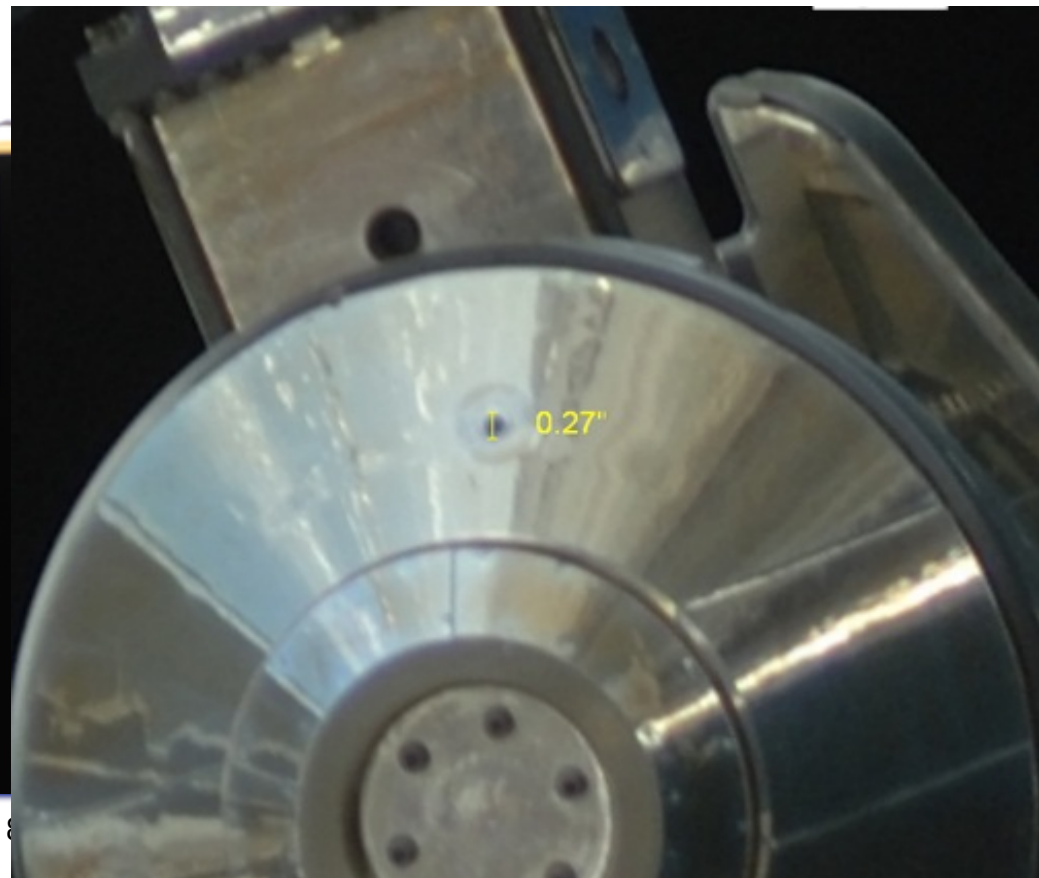
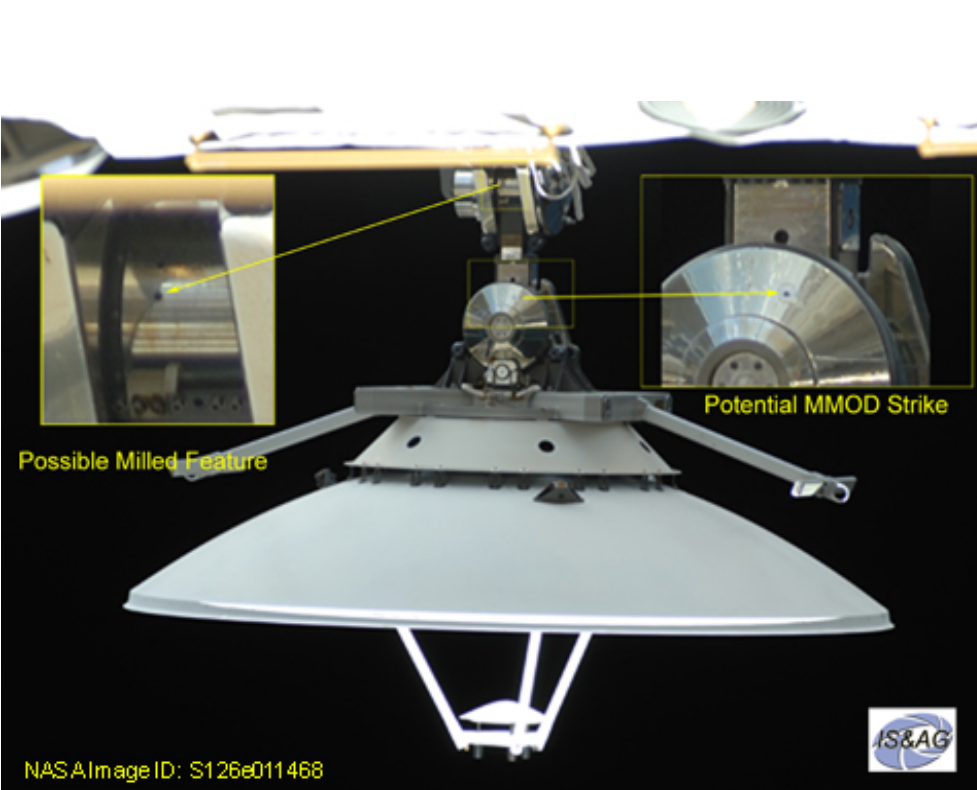



STS-120 Solar Array Wing (SAW) EVA repair was caused by MMOD impact damage

During STS-120 two solar array wings were removed from Z1 truss and relocated to P6 location. During re-deployment, the 4B solar array wing was torn in two places, due to a snagged guide wire. The guide wire was removed and “cuff-links” added to stabilize the array.

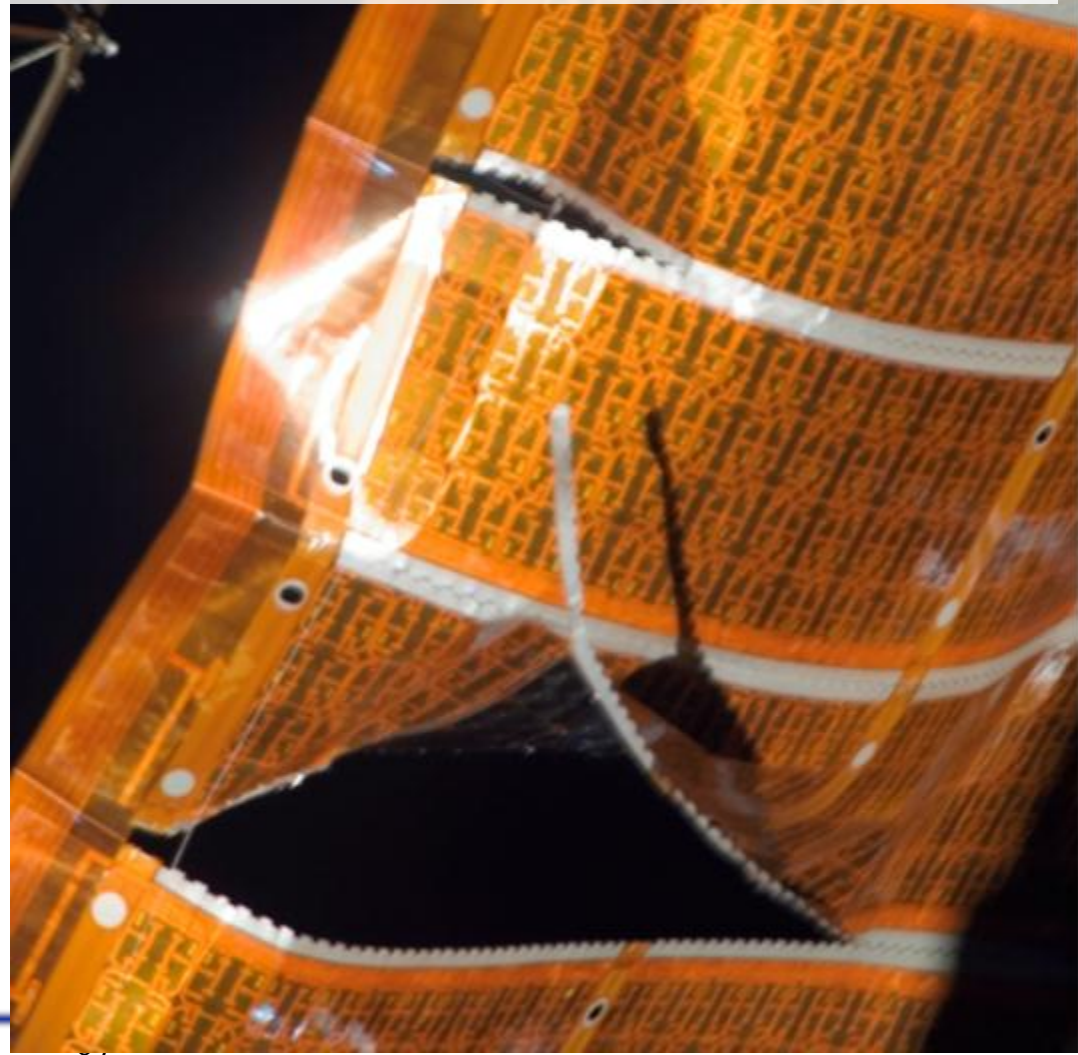

ISS016E009184

S120E008247



Scanning Electron Microscope EDXA Evaluation of retrieved guide wire

7 of 21 wires in the guide wire cable were broken, causing the guide wire to hang-up in a solar array grommet.
3 of the 7 cut wires exhibited evidence of extensive melt at broken ends, indicative of MMOD impact.

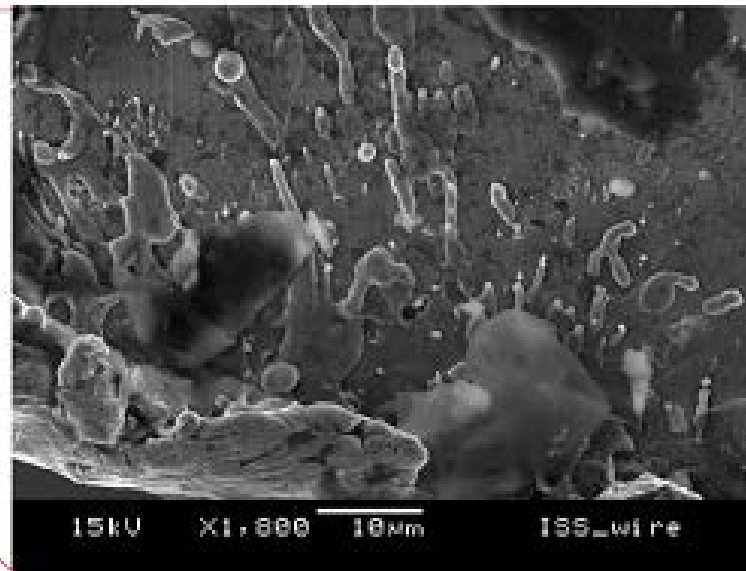
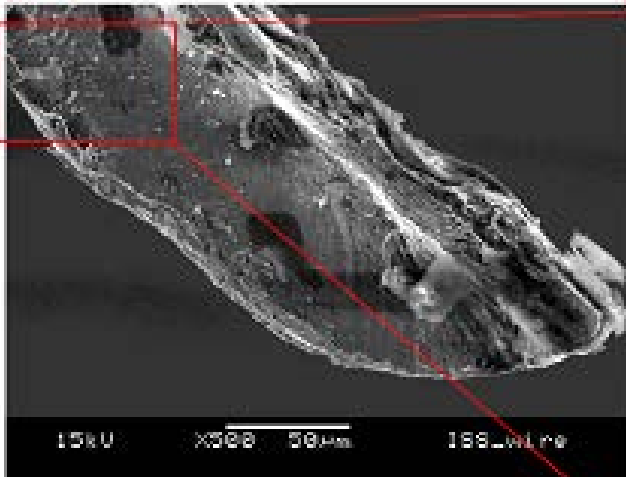
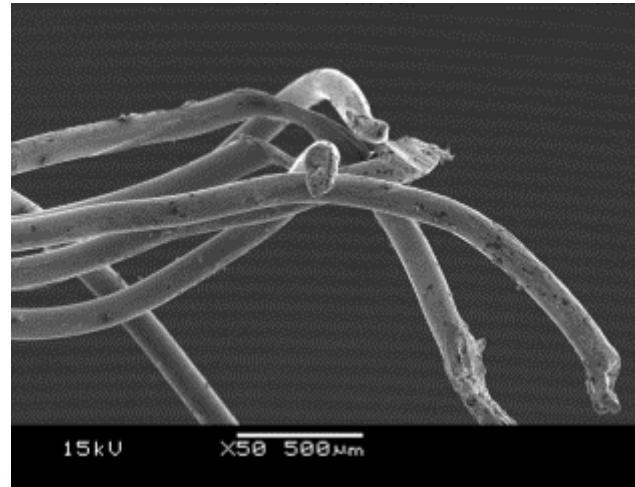
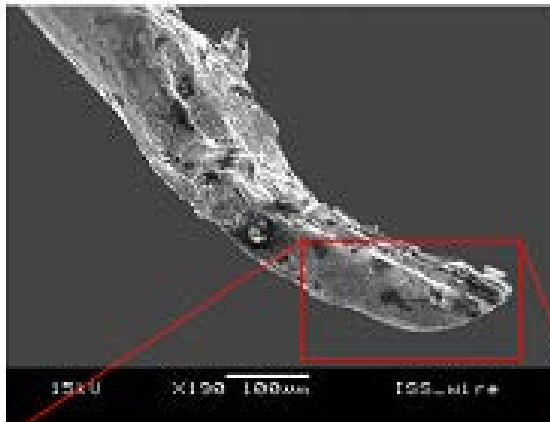

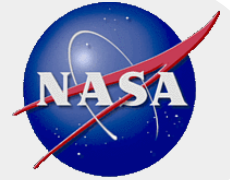

ISS Service Module Shielding

- **Service Module (SM) identified as high penetration risk using Bumper risk analysis**
 - large cone region
 - forward sides of small diameter cylinder
- **Shields designed and tested, EVA installed**
 - 23 augmentation shields for the cone region
 - 5 augmentation shields for the cylinder region
- **28 shields reduced SM MMOD risk by 30%**

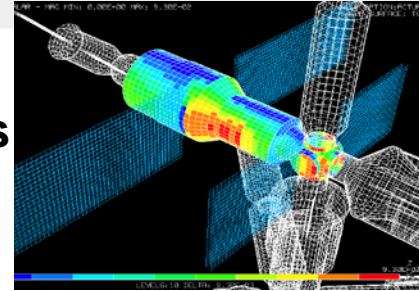

High-risk (red)
Low-risk (blue)

SM “conformal”
augmentation shield

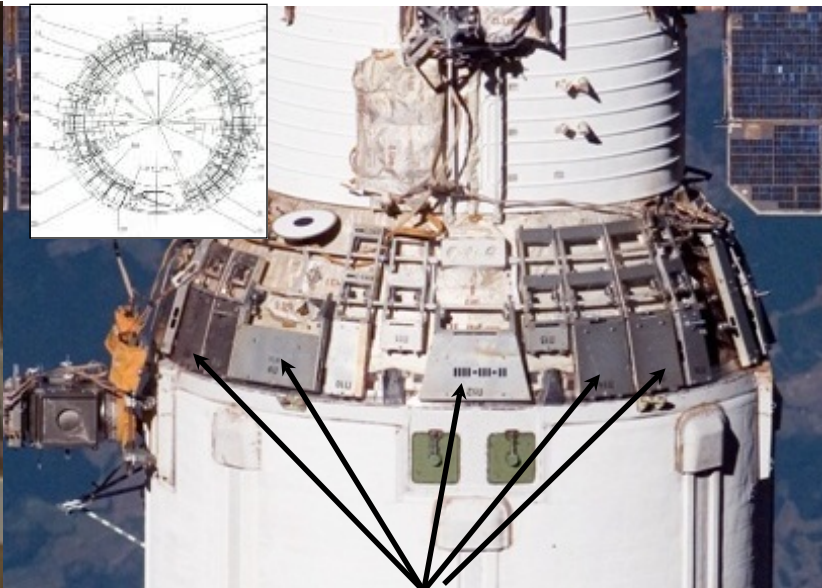
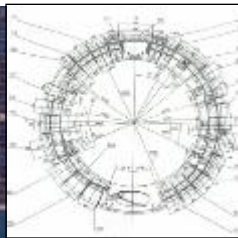
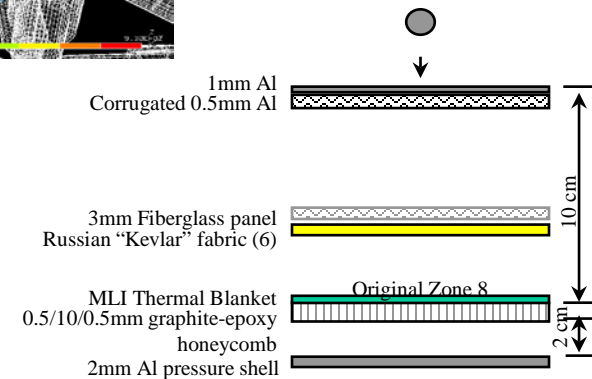

EVA Installation

23 “conformal” panels on cone region

5 panels on small diameter cylinder



HVIT Team: HVI Testing and MMOD Risk Assessments

Hypervelocity Impact Testing:

- Objective: understand how a spacecraft surface and underlying structure “shield” responds to impact from an orbital debris or micrometeoroid
- Inputs: impact velocity (mostly 3-8 km/s), impact angle (usually 0°, 30°, 45°, 60°), projectile diameter (aluminum, nylon, ruby, steel)
- Product: a ballistic limit equation (BLE) that calculates a critical particle diameter that will fail the shield as defined by the specific failure criteria

MMOD Risk Assessments:

- Objective: use the Bumper risk assessment code to estimate the micrometeoroid and orbital debris (MMOD) risk to a spacecraft for a given set conditions.
- Bumper inputs:
 - spacecraft geometry
 - altitude, inclination, orientation
 - start year, exposure duration
 - debris or meteoroid
 - BLE and failure criteria
- Product:
 - MMOD risk results
 - Impact (NI, PNI, odds)
 - Penetration (NP, PNP, odds)
 - Color risk contours & VBETA

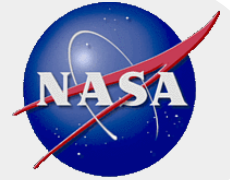

Hypervelocity Impact Testing

Testing at WSTF:

- 3,500 HVI tests completed 2004-2011
- average 440 tests per year
- testing performed on WSTF two-stage light gas guns (2SLGG)
 - range selection driven by projectile size, test sample size, and budget
 - .17-cal, .50-cal, 1" ranges
 - turnaround times vary



JSC-KX Hypervelocity Impact Technology (HVIT) Team:

- develops test matrix
- completes test readiness review
- prepares (builds up) test samples
- ships samples and projectiles to WSTF
- daily coordination with WSTF
- performs post test sample analysis
- documents test series in report
- develops ballistic limit equations



WSTF Remote Hypervelocity Test Laboratory (RHTL)

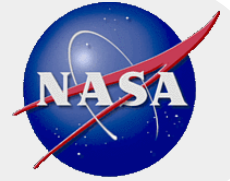

WSTF Remote Hypervelocity Test Laboratory (RHTL)

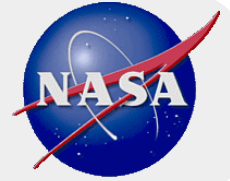

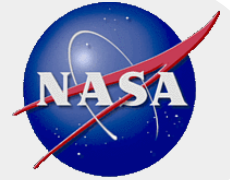

WSTF .17-cal range

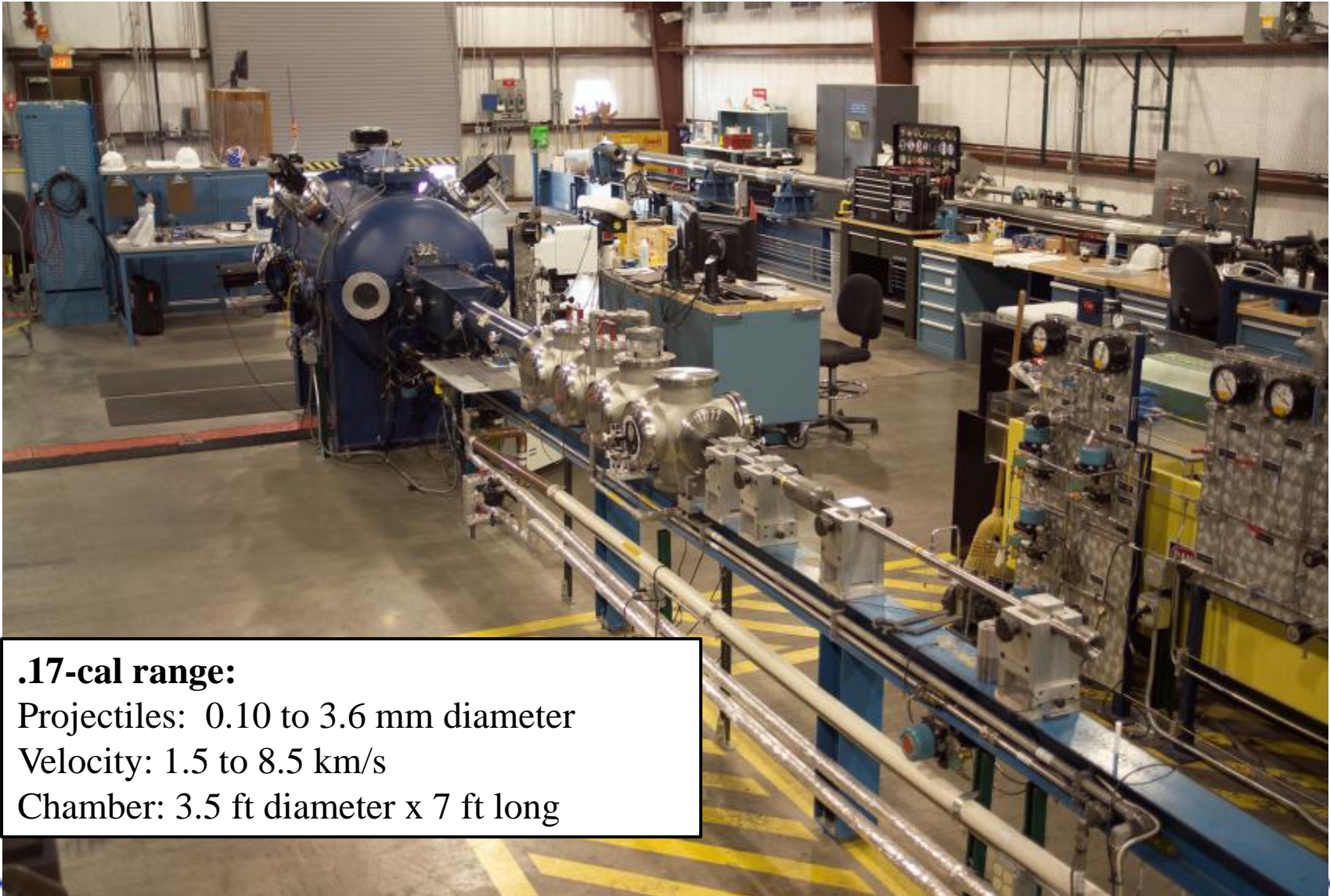

.17-cal range:

Projectiles: 0.10 to 3.6 mm diameter

Velocity: 1.5 to 8.5 km/s

Chamber: 3.5 ft diameter x 7 ft long

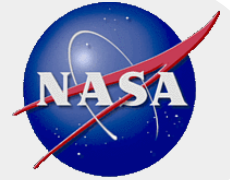

WSTF .50-cal range

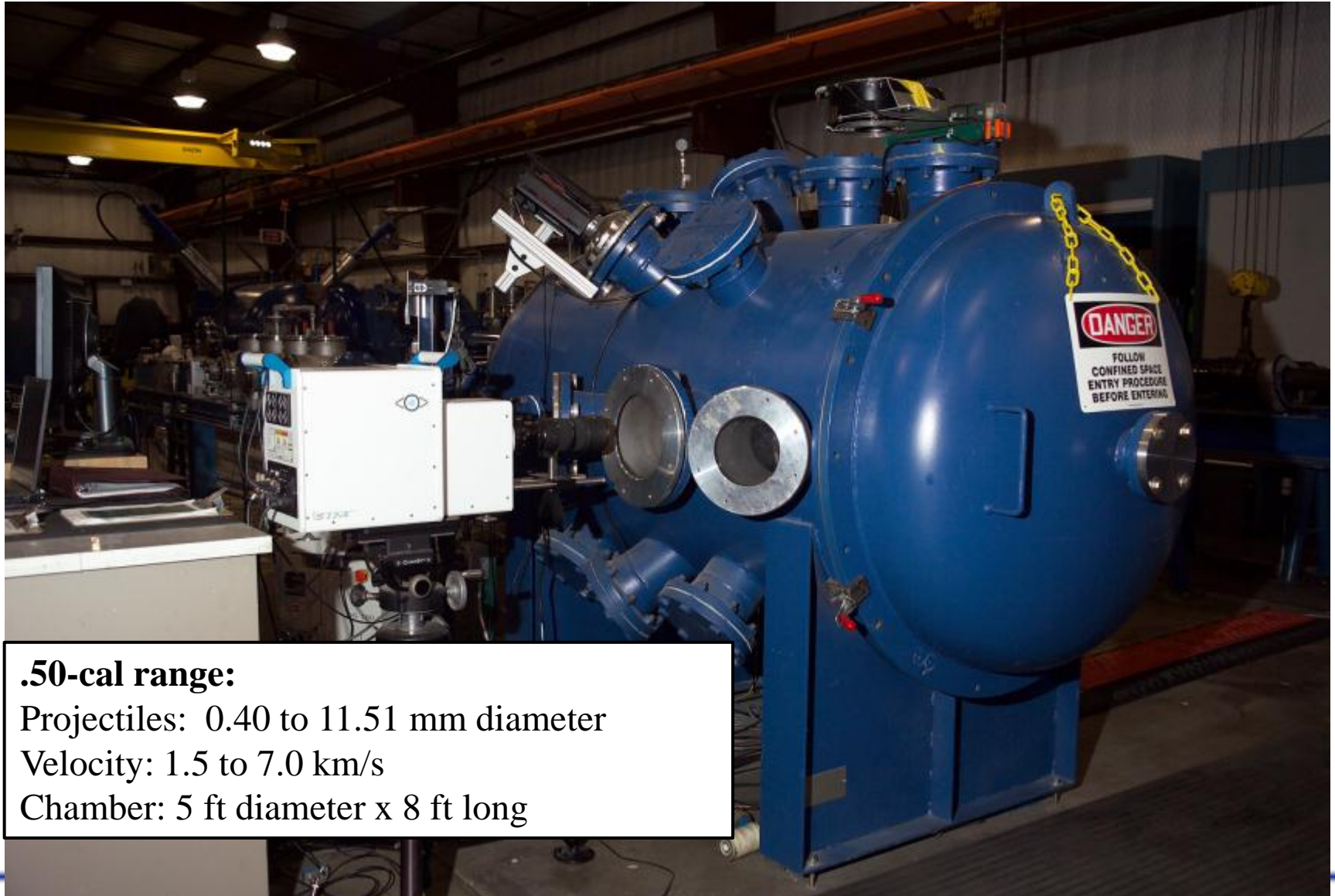

.50-cal range:

Projectiles: 0.40 to 11.51 mm diameter

Velocity: 1.5 to 7.0 km/s

Chamber: 5 ft diameter x 8 ft long

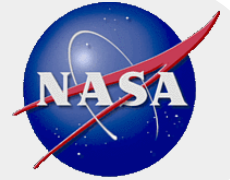

WSTF 1" range



1"range:

Projectiles: 0.40 to 22 mm diameter

Velocity: 1.5 to 7.0 km/s

Chamber: 9 ft diameter x 30 ft long

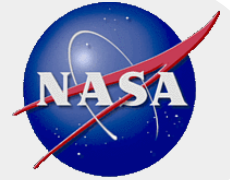

.50-cal Test

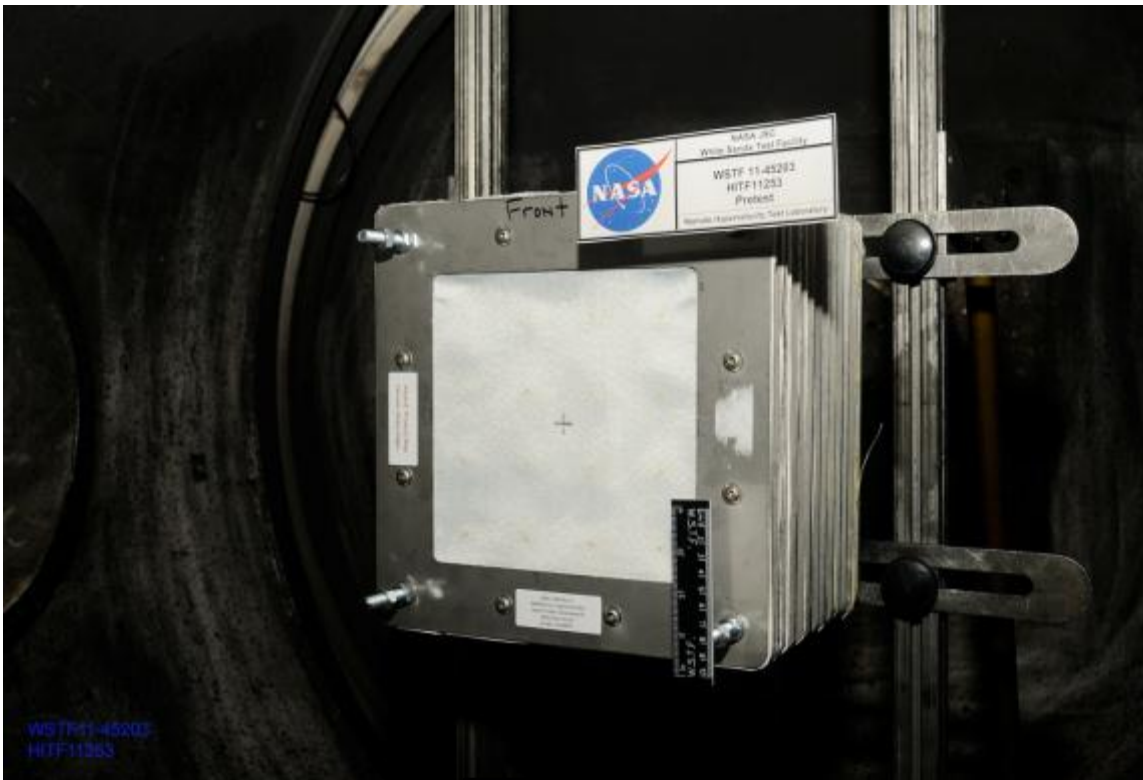

Pretest photo

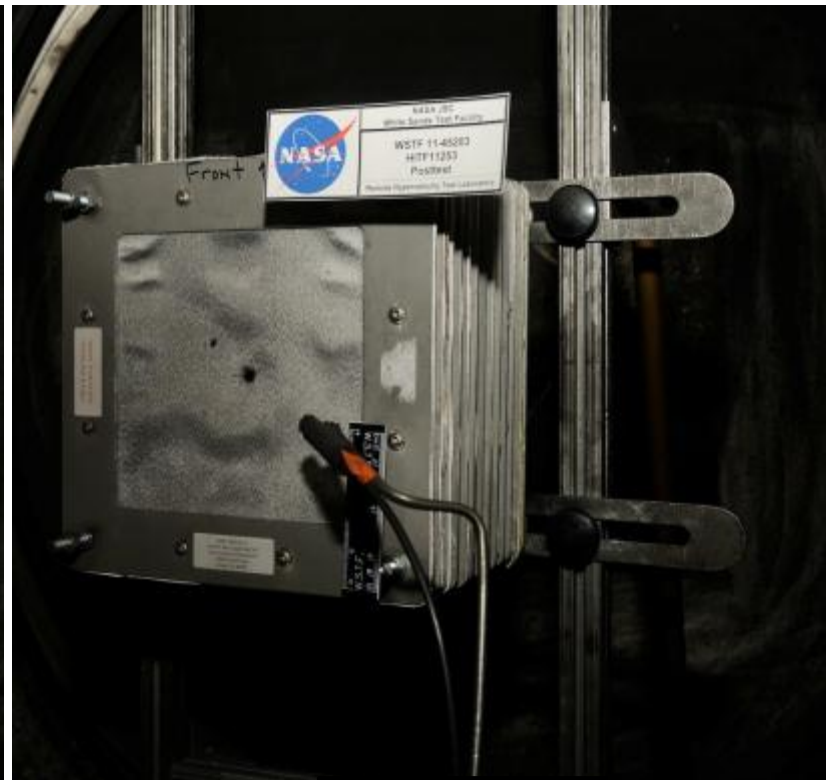

Post Test Photo

[Phantom camera impact video \(67 kfps\)](#)

HVIT Team: MMOD Risk Assessments

Bumper Code

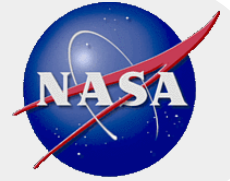

```

Intel(R) Fortran Compiler for applications running on IA-32, Version 10.1.013 build environm...
INTERNATIONAL DISTRIBUTION FOR SPACE STATION USE ONLY

      N O T I C E

This technical data is considered subject to the United States export control laws and/or to be proprietary. It is furnished on the condition that it will be used and disclosed by the receiving Cooperating Agency and its contractors and subcontractors only for the purposes of fulfilling the Cooperating Agency's responsibilities under the Space Station Intergovernmental Agreement and Memorandum of Understanding. It shall not be for any other purpose, nor disclosed or retransferred to any other entity or government without prior written permission of the United States acting through NASA.

<CR> TO CONTINUE

BUMPERII UNIX VERSION 1.98.5 <21 MAR 2011>

RUN WHICH MODULE ?
 1 - GEOMETRY
 2 - RESPONSE
 3 - SHIELD
 4 - CONTOUR
 5 - BAICH-COM
 6 - RPLOT
 7 - EXIT
CHOICE ? <1, 2, 3, 4, 5, 6, OR 7> > 1

GEOMETRY OUTPUT SUMMARY FILENAME ? <<CR>=geometry.sum> > t_d.gsum

ANALYSIS TYPE ?
 1 - MAN-MADE DEBRIS <CR>
 2 - METEOROIDS
 3 - BOTH
CHOICE ? <1, 2, OR 3> > 1

ENVIRONMENT DEFINITION ?
 1 - JSC-20001 & JSC-6000
 2 - SSP 30425
 3 - TM 104825 <ORDEM96> OR ORDEM2000
CHOICE ? <1, 2, OR 3> > 2

MODEL FILE FORMAT ?
 1 - SUPERTAB UNIVERSAL <CR>
 2 - PATRAN NEUTRAL
CHOICE ? <1 OR 2> > 1

SUPERTAB UNIVERSAL FILENAME ? <<CR>=model.unv> >
  
```

Running Bumper interactively (single run)

```

ATV_req_resp4a_deb.pl - WordPad
# /usr/bin/perl

use Switch; # req'd for case statement

# -----
# ATV_v4 Requirements Debris Response Script (08/10/11) (0.12 cm bumper)
# -----
#
# constants
{version="ATV_v4a"}
{run_type=1;      # Run Types: (1=debris, 2=meteoroid)}
{env_def=2;      # Environment Definitions: (2=SSP-30425, Rev.B)}
{density=1;      # Debris density (g/cm^3)}
{env="d";        # Run Type Filename Suffix: (d=debris, w=meteoroid)}
{met_dens=3;     # Meteoroid Density: (1=constant 1.0 g/cm2, 2=constant 0.5 g/cm2, 3=SSP-30425 Size Function)}
{angle=89.9;    # angle cut off}
{goodbye=7;     # exit option #7}
#
{run_path="D:\\SCRATCH\\ATV\\080911\\req\\"};
{code_path="{run_path" . "code\\"};
{fem_path="{run_path" . "fem\\"};
{gem_path="{run_path" . "gem\\"};
{geom_path="{run_path" . "geom\\"};
{rsp_path="{run_path" . "rsp\\"};
{rsum_path="{run_path" . "rsum\\"};
{sum_path="{run_path" . "sum\\"};
{unl_path="{run_path" . "unl\\"};
#
# build output file names
{rsum_file = "{rsum_path" . "{version" . "{env" . ".rsum";
{rsp_file = "{rsp_path" . "{version" . "{env" . ".rsp";
{rplot_file = "{rsp_path" . "{version" . "{env" . ".rplot";
# -----
# run response
{module=2;      # 1-geom, 2-resp, 3-shield, 6-rplot

open(BUMPER, "| bumper"); # open bumper2 for writing, filehandle=BUMPER
print BUMPER <<"eof";

{module
{run_type
{env_def
{angle
{density
{rsum_file
  
```

Running Bumper automatically with scripts (multiple runs)

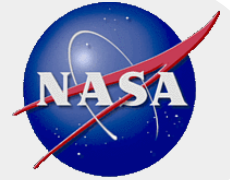

HVIT Team: I-DEAS Modeling Software

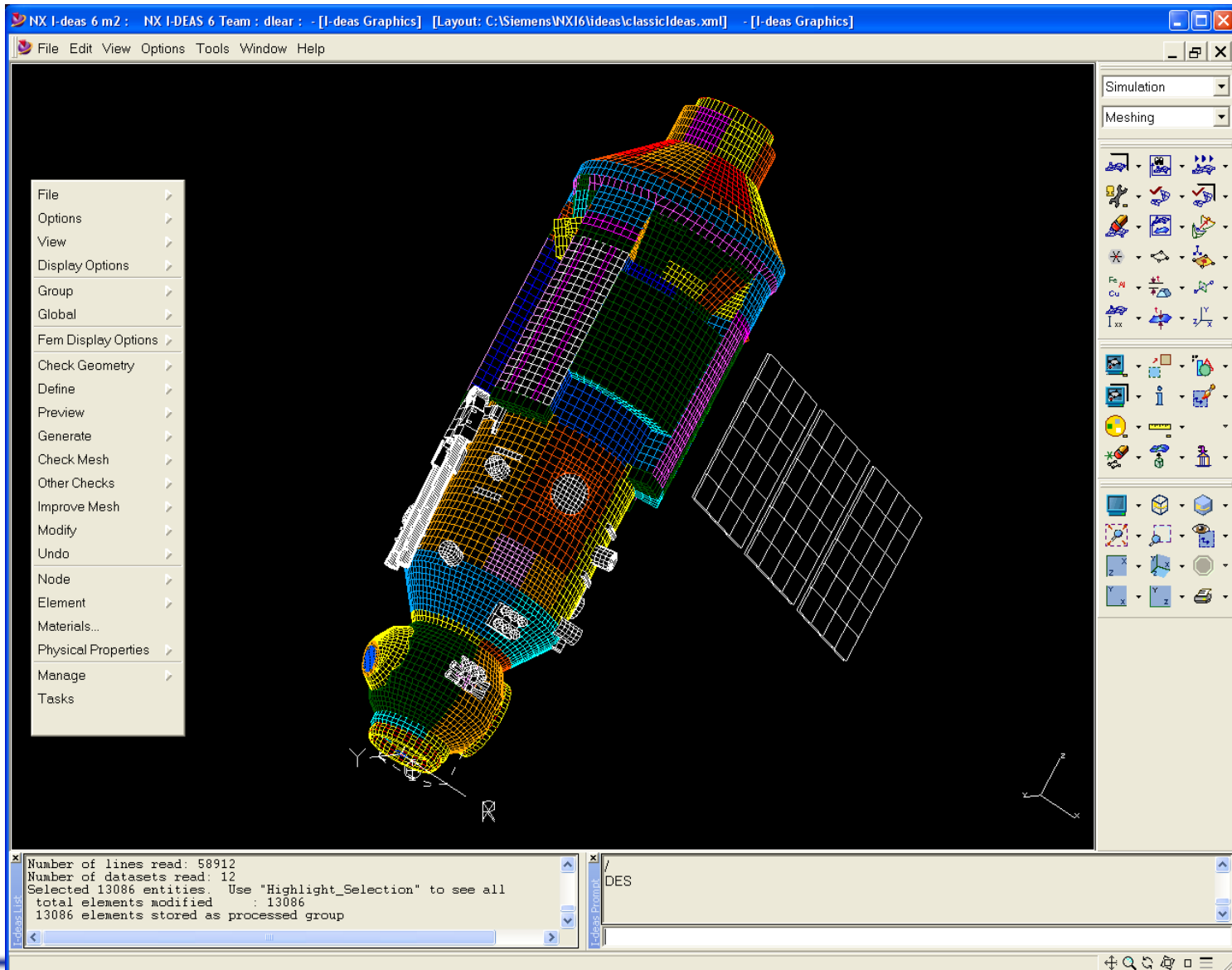

I-DEAS Graphical User Interface

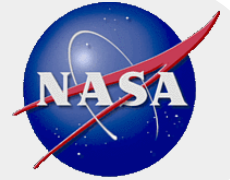

HVIT Team: Finite Element Model (FEM)

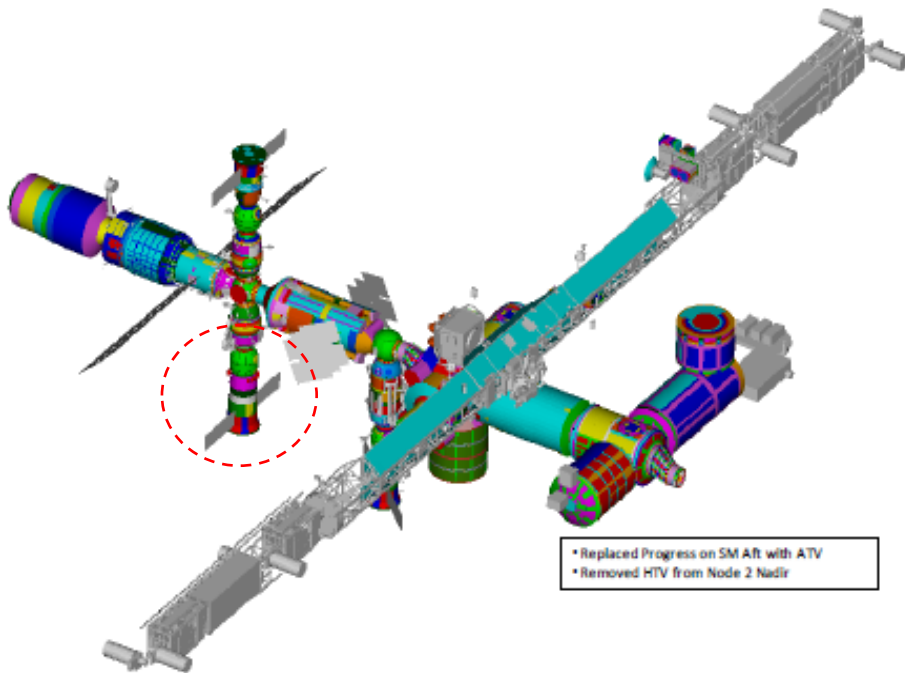

ISS MMOD Risk Assessment FEM
(representing current configuration)

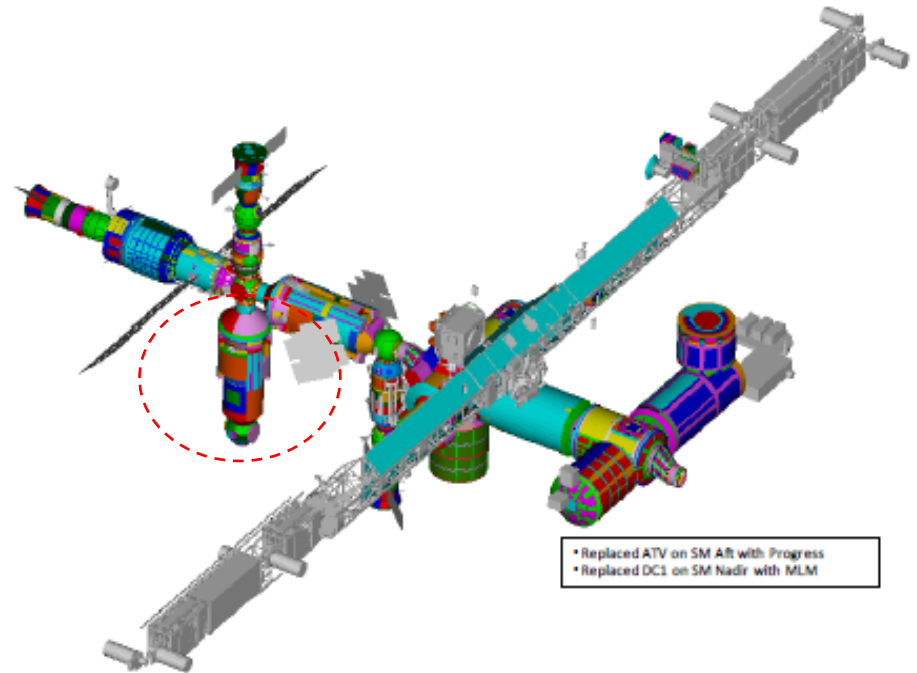

ISS MMOD Risk Assessment FEM
(representing configuration after MLM launch)



HVIT Team: Finite Element Model (FEM)

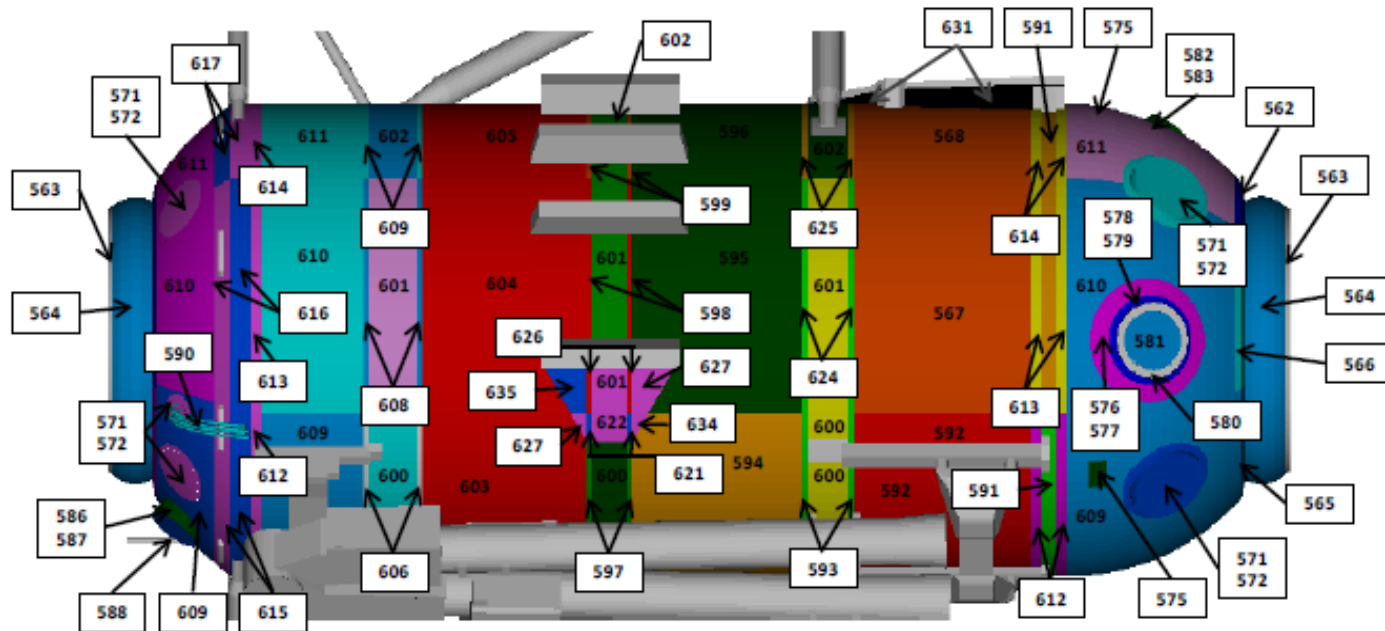

PID 1 - SHADOWING	PID 582-585 - ZEN SPHERE	PID 604 - CENTRAL-NAD CYL (STBD/PORT)	PID 620 - RING 3A THIN (PORT)
PID 562 - ZEN RING LOW FIRM	PID 586 - ZEN/NAD SPHERE	PID 605 - CENTRAL-NAD CYL (AFT)	PID 621 - RING 4A THIN (FWD)
PID 563 - SHPANGOUT I	PID 587 - ZEN SPHERE	PID 606 - RING 5A THIN (FWD)	PID 622 - RING 4A THICK (FWD)
PID 563 - SHPANGOUT IV	PID 588 - ZEN/NAD SPHERE	PID 607 - RING 5A THIN (STBD/PORT)	PID 623 - RING 5A THIN (PORT)
PID 564 - DOCKING MECHANISM	PID 588 - NAD SPHERE	PID 608 - RING 5A THIN (AFT)	PID 624 - RING 3A THIN (STBD/PORT)
PID 565 - ZEN RING HIGH FIRM	PID 589 - ZEN SPHERE	PID 609 - ZEN/NAD SPHERE/CYL (FWD)	PID 625 - RING 3A THIN (AFT)
PID 566 - ZEN RING MIDDLE FIRM	PID 590 - NAD SPHERE STEEL TUBES	PID 610 - ZEN/NAD SPHERE/CYL (STBD/PORT)	PID 626 - RING 4A THIN (STBD)
PID 567 - ZEN CYLINDER MIDDLE FIRM	PID 591 - RING 2A THICK	PID 611 - ZEN/NAD SPHERE/CYL (AFT)	PID 627 - CENTRAL-ZEN CYL (STBD)
PID 568 - ZEN CYLINDER LOW FIRM	PID 592 - ZEN CYLINDER	PID 612 - RING 2A,6A THIN (FWD)	PID 628 - CENTRAL-NAD CYL (FWD)
PID 569,570 - ZEN SPHERE	PID 593 - RING 3A THIN	PID 613 - RING 2A,6A THIN (STBD/PORT)	PID 629 - PRM LONG STANDOFF
PID 571,572 - ZEN/NAD SPHERE	PID 594-596 - CENTRAL-ZEN CYL	PID 614 - RING 2A,6A THIN (AFT)	PID 630 - PRM SHORT STANDOFF
PID 573,574 - ZEN SPHERE	PID 597 - RING 4A THIN (FWD)	PID 615 - RING 6A/NAD CONE,RING (FWD)	PID 631 - PRM SIDE
PID 575 - ZEN/NAD SPHERE	PID 598 - RING 4A THIN (STBD/PORT)	PID 616 - RING 6A/NAD CONE,RING (PORT/STBD)	PID 632 - ZEN CYLINDER (PORT)
PID 576 - ROUND PLATE RING 1	PID 599 - RING 4A THIN (AFT)	PID 617 - RING 6A/NAD CONE,RING (AFT)	PID 633 - CENTRAL-NAD CYL (PORT)
PID 577 - ROUND PLATE RING 2	PID 600 - RING 3A,4A,5A THICK (FWD)	PID 618 - RING 2A THIN (PORT)	PID 634 - CENTRAL-ZEN CYL (FWD)
PID 578 - ROUND PLATE RING 3	PID 601 - RING 3A,4A,5A THICK (STBD/PORT)	PID 619 - RING 3A THICK (PORT)	PID 635 - CENTRAL-NAD CYL (STBD)
PID 579,580 - ROUND PLATE RING 4	PID 602 - RING 3A,4A,5A THICK (AFT)		
PID 581 - ROUND PLATE	PID 603 - CENTRAL-NAD CYL (FWD)		

Mini-Research Module (MRM-1) MMOD Shield Type Map

National Aeronautics and
Space Administration

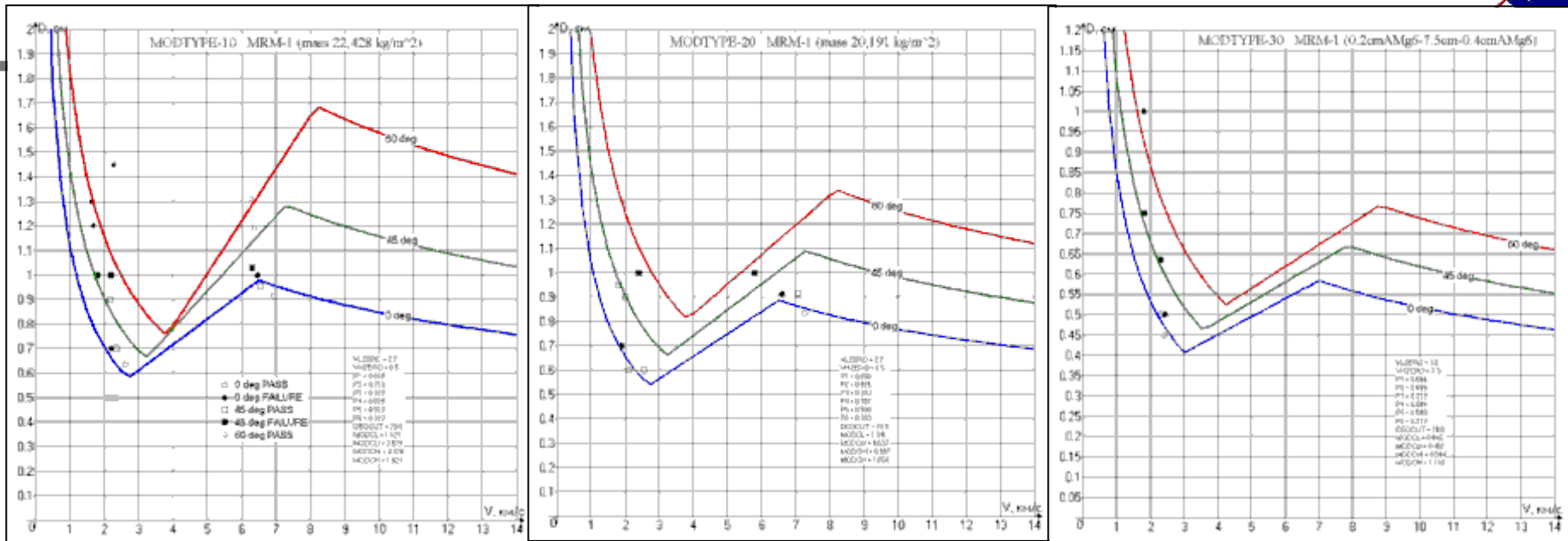

MODTYPE10

Basalt Fabric BT-13H (18)
Industrial Fabric 8353/11 (6 layers)
4-mm AMr6 rear wall (scaling
factor=1.0)

MODTYPE20

Basalt Fabric BT-13H (9 layers)
Industrial Fabric 8353/11 (6 layers)
4-mm AMr6 rear wall (scaling
factor=1.0)

MODTYPE30

Basalt Fabric BT-13H (NONE)
Industrial Fabric 8353/11 (NONE)
4-mm AMr6 rear wall (scaling
factor=1.0)

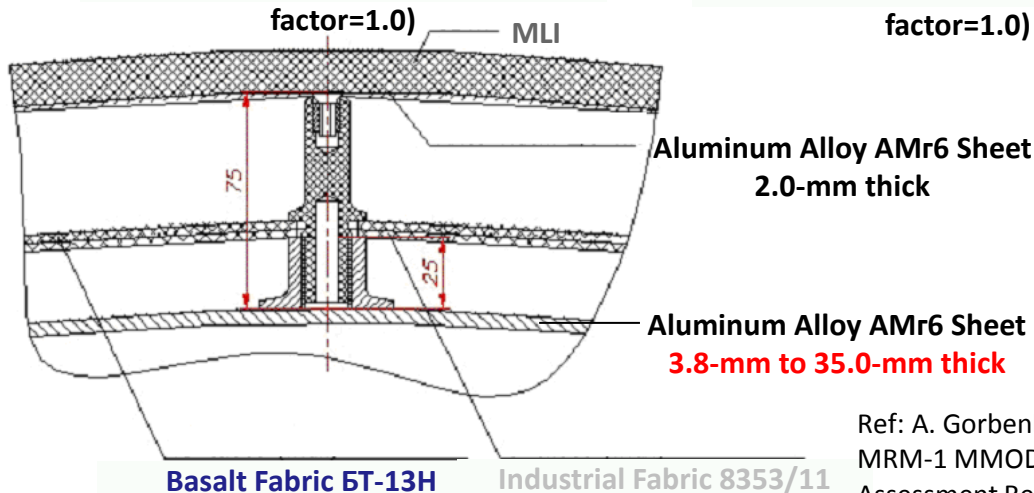

Ref: A. Gorbenko, RSC-E
MRM-1 MMRD PNP
Assessment Report
P41491, April 2010.

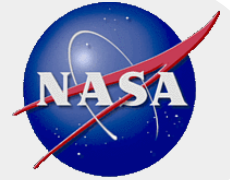

HVIT Team: Finite Element Model (FEM)

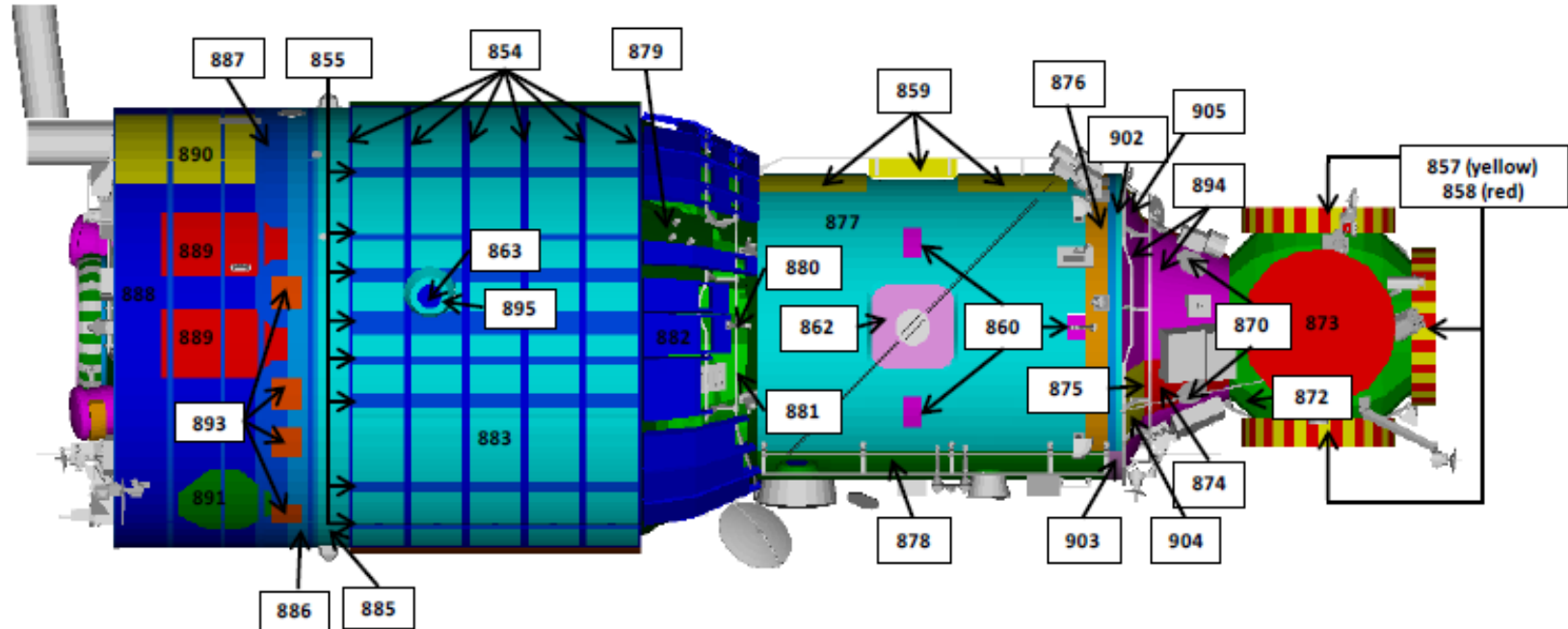

PID 1 - SHADOWING	PID 871 - WINDOW #9	PID 888 - POWER MODULE AFT (16) PID675
PID 854 - WORKING MODULE PANEL EDGES (6.0 MM)	PID 872 - TRANSFER MODULE "SPHERE"	PID 889 - PROPELLANT TANKS
PID 855 - WORKING MODULE PANEL CROSS MEMBERS (3.5 MM)	PID 873 - PORT COVER	PID 890 - COMPRESSOR UNITS
PID 856 - WORKING MODULE "ZENITH CYL"	PID 874 - TRANSFER MODULE "CONE"	PID 891 - WATER TANKS
PID 857 - DOCKING MECH PID	PID 875 - WORKING MODULE "BOTTOM"	PID 892 - TRANSVERSE CHAMBER "COVER"
PID 858 - DOCKING MECH PID	PID 876 - WORKING MODULE "FWD CYL"	PID 893 - SPHERICAL TANKS
PID 859 - WORKING MODULE ZENITH	PID 877 - WORKING MODULE "RADIATOR CYL"	PID 894 - THICK PLATE@TRANSFER MOD. CONE
PID 860 - WORKING MODULE RECTANGULAR EQUIPMENT PLATES	PID 878 - WORKING MODULE "NADIR CYL"	PID 895 - WINDOWS #1 AND 2 UNSHIELDED REGION
PID 861 - WORKING MODULE CIRCULAR EQUIPMENT PLATES	PID 879 - WORKING MODULE "CONE" PANELS - 4.5 MM	PID 896 - SM POWER MODULE - CONE
PID 862 - PV ARRAY BASES	PID 880 - WORKING MODULE "CONE" PANELS - 4.0 MM	PID 897 - SM POWER MODULE - DOCKING MECH FRAME
PID 863 - WINDOW #1 AND 2	PID 881 - WORKING MODULE "CONE" PANELS - 2.3 MM	PID 898 - SM POWER MODULE - DOCKING MECH (THICK WALL)
PID 864 - WINDOW #3 AND 5	PID 882 - CONFORMAL SHIELD	PID 899 - SM POWER MODULE - DOCKING MECH (THIN WALL)
PID 865 - WINDOW #4	PID 883 - WORKING MOD "RADIATOR CYL"	PID 900 - SM POWER MODULE - DOCKING MECH FRAME
PID 866 - WINDOW #6	PID 884 - WORKING MODULE "NADIR CYL"	PID 901 - POWER MODULE "VERY LONG S.O. CYL"
PID 867 - WINDOW #26	PID 885 - POWER MODULE "VERY SHORT S.O. CYL"	PID 902 - SM WORKING MODULE FWD CYL - THK RING WALL
PID 868 - WINDOW #7	PID 886 - POWER MODULE "SHORT S.O. CYL"	PID 903 - SM WORKING MODULE NADIR CYL - THK RING WALL
PID 869 - WINDOW #8	PID 887 - POWER MODULE "LONG S.O. CYL"	PID 904 - SM WORKING MODULE BOTTOM RING
PID 870 - WINDOW #12, 13 AND 14	PID 888 - POWER MODULE "VERY LONG S.O. CYL"	PID 905 - SM THICK PLATE TRANSFER MODULE CONE RING

ISS Service Module FEM Property Identification (PID) Map (partial)



HVIT Team: PID Table

Region	Start ID	End ID	# of Elements	PID #	Area (m2)	Shield Type	Bumper (cm)	Bumper Mat'l	Standoff (cm)	Rear Wall (cm)	Rear Wall mat'l	MOD Type	Curve Adj	Drift (cm)
Service Module	30,001	56,196	127,228	-	506.98	-	-	-	-	-	-	-	-	-
transfer module "sphere" (1)	30,001	30,080	80	872	6.48	NNO	0.20	AMg6	2.0	0.60	AMg6	-	-	0.485
transfer module "cover" (2)	30,081	30,160	80	873	5.57	NNO	0.10	AMg6	10.0	0.50	AMg6	-	-	0.735
transfer module "cone" (3a)	30,161	30,368	208	874	1.44	NNO	0.10	AMg6	2.0	0.40	AMg6	-	-	0.370
working module "bottom" (4)	30,369	30,464	96	875	0.94	NNO	0.10	AMg6	2.0	0.35	AMg6	-	-	0.339
working module "fwd cyl" (5)	30,465	30,580	116	876	1.39	NNO	0.10	AMg6	2.0	0.16	AMg6	-	-	0.201
working module "radiator cyl" (6)	30,581	31,730	1,150	877	19.66	SM NASA	-	-	-	-	-	60	-	0.364
working module zenith plate aft (6)	31,731	31,754	24	859	0.52	NNO	0.15	AMg6	9.0	0.16	AMg6	-	-	0.332
working module zenith plate fore (6)	31,755	31,778	24	859	0.52	NNO	0.15	AMg6	9.0	0.16	AMg6	-	-	0.332
working module zenith box (6)	31,779	31,792	14	859	0.61	NNO	0.15	AMg6	9.0	0.16	AMg6	-	-	0.332
working module rectangular equipment plates	31,793	31,808	16	860	0.32	NNO	0.30	AMg6	2.0	0.16	AMg6	-	-	0.201
working module circular equipment plates (port)	31,809	31,816	8	861	0.20	NNO	0.30	AMg6	2.0	0.16	AMg6	-	-	0.201
working module "nadir cyl" (7)	31,817	32,465	649	878	5.97	NNO	0.10	AMg6	5.0	0.16	AMg6	-	-	0.273
working module "cone" panel 1 (8) - 4.5 mm	32,466	32,604	139	879	0.58	NNO	0.10	AMg6	2.0	0.45	AMg6	-	-	0.401
working module "cone" panel 1 (8) - 4.0 mm	32,605	32,616	12	880	0.06	NNO	0.10	AMg6	2.0	0.40	AMg6	-	-	0.370
working module "cone" panel 1 (8) - 2.3 mm	32,617	32,800	184	881	0.84	NNO	0.10	AMg6	2.0	0.23	AMg6	-	-	0.256
working module "cone" panel 2 (8) - 4.5 mm	32,801	32,969	169	879	0.72	NNO	0.10	AMg6	2.0	0.45	AMg6	-	-	0.401
working module "cone" panel 2 (8) - 4.0 mm	32,970	33,019	50	880	0.24	NNO	0.10	AMg6	2.0	0.40	AMg6	-	-	0.370
working module "cone" panel 2 (8) - 2.3 mm	33,020	33,139	120	881	0.52	NNO	0.10	AMg6	2.0	0.23	AMg6	-	-	0.256
working module "cone" panel 3 (8) - 4.5 mm	33,140	33,278	139	879	0.57	NNO	0.10	AMg6	2.0	0.45	AMg6	-	-	0.401
working module "cone" panel 3 (8) - 4.0 mm	33,279	33,329	51	880	0.24	NNO	0.10	AMg6	2.0	0.40	AMg6	-	-	0.370
working module "cone" panel 3 (8) - 2.3 mm	33,330	33,474	145	881	0.65	NNO	0.10	AMg6	2.0	0.23	AMg6	-	-	0.256
working module "cone" panel 4 (8) - 4.5 mm	33,475	33,612	138	879	0.59	NNO	0.10	AMg6	2.0	0.45	AMg6	-	-	0.401
working module "cone" panel 4 (8) - 4.0 mm	33,613	33,658	46	880	0.22	NNO	0.10	AMg6	2.0	0.40	AMg6	-	-	0.370
working module "cone" panel 4 (8) - 2.3 mm	33,659	33,804	146	881	0.66	NNO	0.10	AMg6	2.0	0.23	AMg6	-	-	0.256
working module "cone" panel 5 (8) - 4.5 mm	33,805	33,978	174	879	0.72	NNO	0.10	AMg6	2.0	0.45	AMg6	-	-	0.401
working module "cone" panel 5 (8) - 4.0 mm	33,979	34,003	25	880	0.12	NNO	0.10	AMg6	2.0	0.40	AMg6	-	-	0.370
working module "cone" panel 5 (8) - 2.3 mm	34,004	34,104	101	881	0.49	NNO	0.10	AMg6	2.0	0.23	AMg6	-	-	0.256
working module "cone" window area (8) - 4.5 mm	34,105	34,462	358	879	1.46	NNO	0.10	AMg6	2.0	0.45	AMg6	-	-	0.401
working module "cone" panel 6 (8) - 4.5 mm	34,463	34,587	125	879	0.53	NNO	0.10	AMg6	2.0	0.45	AMg6	-	-	0.401
working module "cone" panel 6 (8) - 4.0 mm	34,588	34,602	15	880	0.07	NNO	0.10	AMg6	2.0	0.40	AMg6	-	-	0.370
working module "cone" panel 6 (8) - 2.3 mm	34,603	34,721	119	881	0.55	NNO	0.10	AMg6	2.0	0.23	AMg6	-	-	0.256
working module "cone" panel 7 (8) - 4.5 mm	34,722	34,860	139	879	0.60	NNO	0.10	AMg6	2.0	0.45	AMg6	-	-	0.401
working module "cone" panel 7 (8) - 4.0 mm	34,861	34,897	37	880	0.18	NNO	0.10	AMg6	2.0	0.40	AMg6	-	-	0.370
working module "cone" panel 7 (8) - 2.3 mm	34,898	35,050	153	881	0.70	NNO	0.10	AMg6	2.0	0.23	AMg6	-	-	0.256
working module "cone" panel 8 (8) - 4.5 mm	35,051	35,188	138	879	0.57	NNO	0.10	AMg6	2.0	0.45	AMg6	-	-	0.401

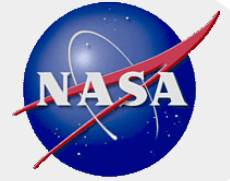

HVIT Team: Graphical Risk Maps “color contour”

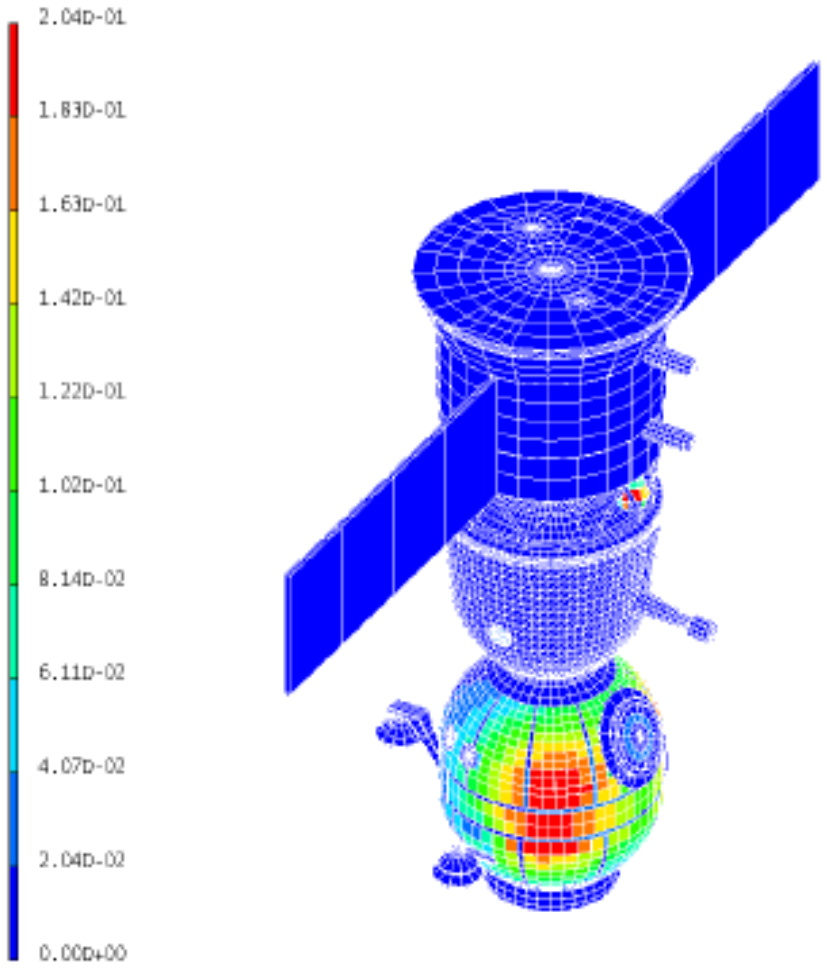

ISS Soyuz Penetration Risk Color Contour

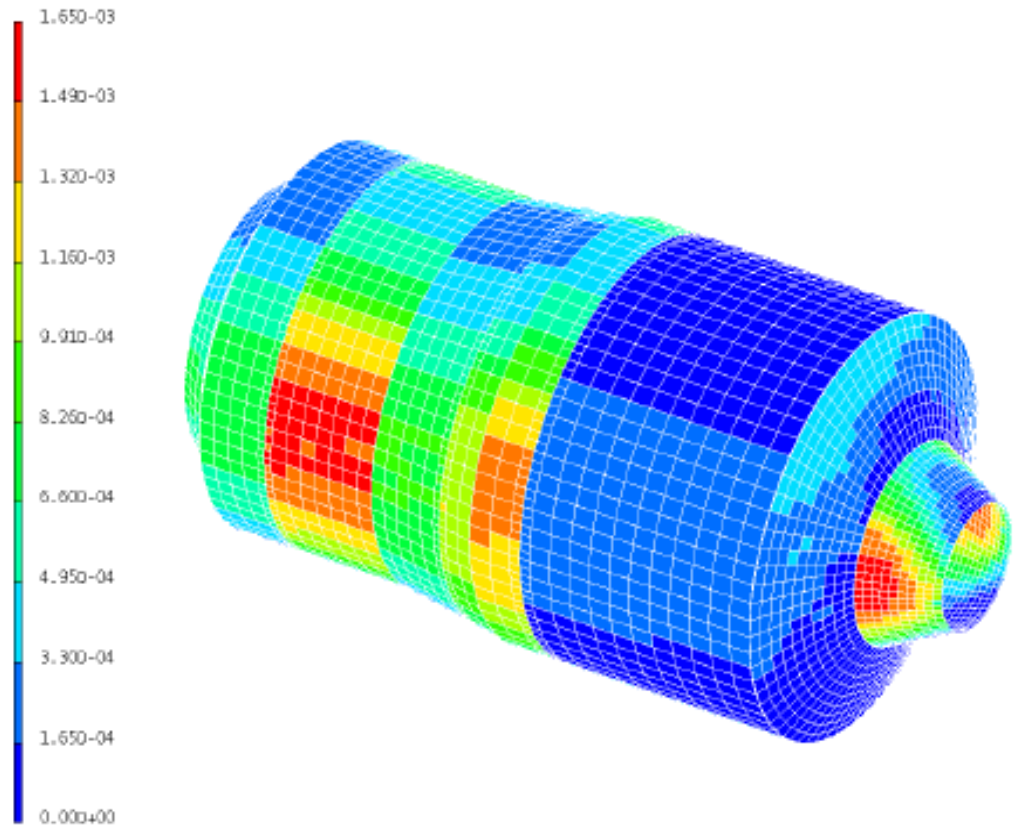

ISS ATV Penetration Risk Color Contour

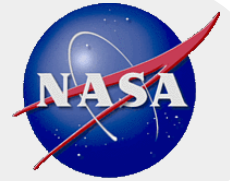

ORDEM 3.0 Debris Model Graphics

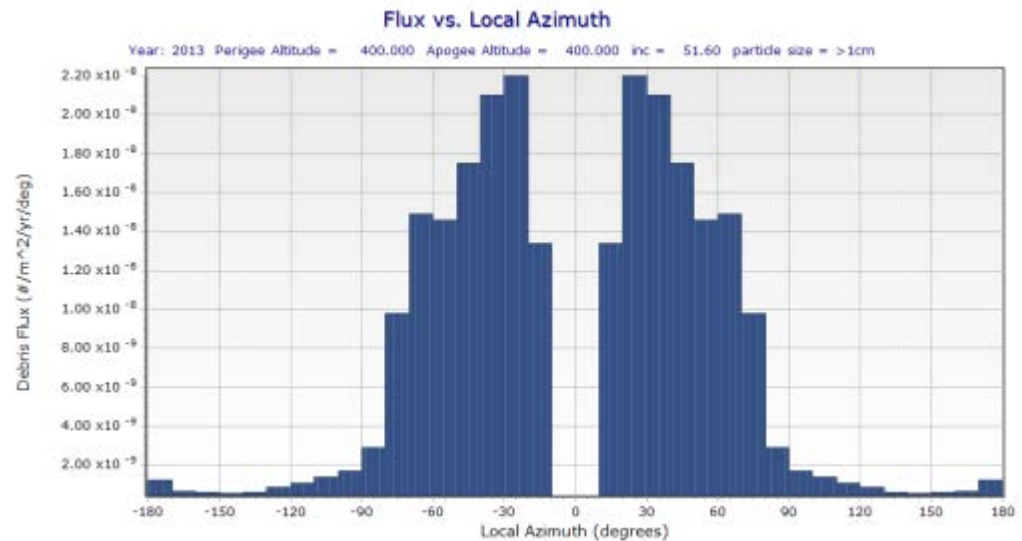
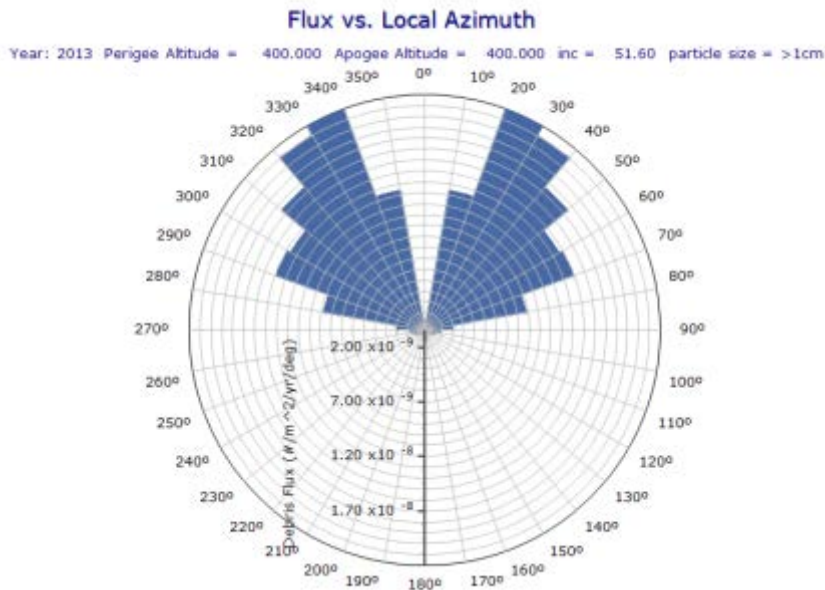
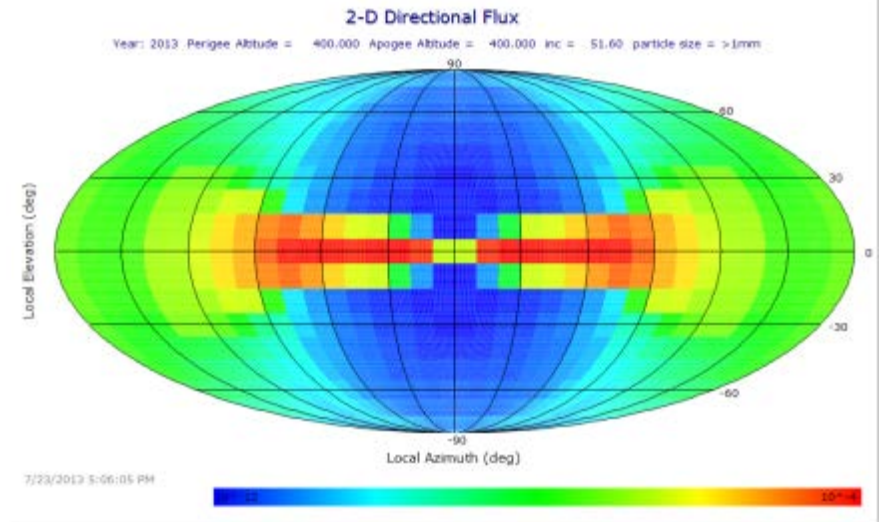
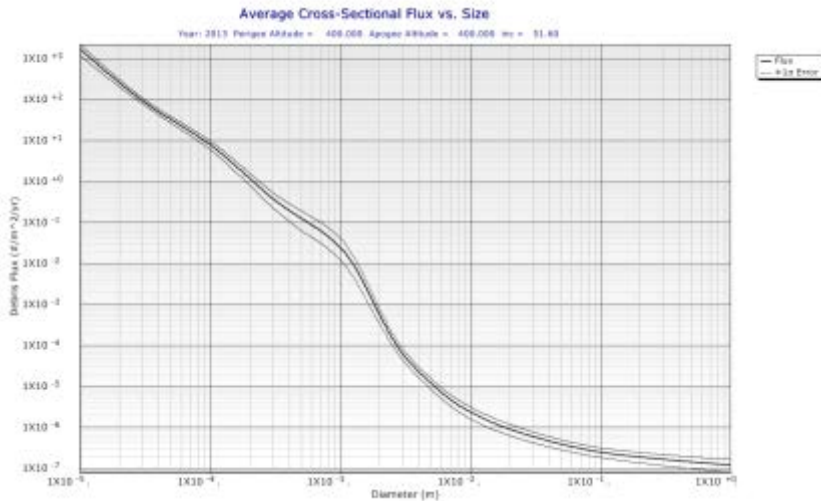



Hypervelocity Impact Test Parameters for Orion Tiles, Phase 3

Test Number / HITF Number / Tile ID	Shot Sequence	Projectile Type	Projectile Diameter (cm)	Projectile Mass (g)	Actual Velocity (km/s)	Impact Angle (deg)	Damage Measurements (mm)
#1 HITF09189	1	Al 2017-T4	0.16	0.00597	7.13	0°	Paint damage diameter = 15 x 16, RCG surface damage = 13 x 12 Entry hole diameter = 9 x 8 (0.35" x 0.31") Primary cavity depth = TBD Max. penetration depth = 24.1 Max cavity diameter = 20 (estimated)
#2 HITF09190	2	Al 2017-T4	0.318	0.04704	3.64	45°	Paint damage diameter = 24 x 20.5 RCG surface damage = 21 x 15 Entry hole diameter = 17 x 14 (0.67" x 0.55") Primary cavity depth = 38.1 (tile perforated) Max. penetration depth = 38.1 (tile perforated) Max cavity diameter = 35 (estimated)
#3 HITF09191	3	440C SS	0.1	0.00405	4.19	45°	Paint damage diameter = 12 x 13 RCG surface damage = 8 x 9 Entry hole diameter = 6 x 5 (0.24" x 0.20") Primary cavity depth = TBD Max. penetration depth = 20.5 (calculated) Max cavity diameter = 12 (estimated)

ISS MPLM and ATA MMOD Impact Damage



Inspected after STS-131 mission	Duration exposed to MMOD	Number of MMOD impacts	Largest MMOD impacts
Multi-Purpose Logistics Module (MPLM)	8 days attached to ISS, 7 days in payload bay	75 impact craters from 0.1mm to 1.5mm diameter	1.5mm diameter through-hole in outer 0.8mm thick Al bumper
Ammonia Tank Assembly (ATA)	7 years attached to ISS	49 impact craters from 0.1mm to 1.0mm diameter	1.0mm diameter crater (elliptical) in an aluminum label

MPLM perforation A3 corner panel (exterior)



MPLM perforation (side view)



ATA impact



ISS MPLM and PMIA MMOD Impact Damage



Inspected after STS-135	MMOD Exposure	Number of MMOD Impacts	Largest MMOD Impacts
Multi-Purpose Logistics Module (MPLM)	7.0 days on ISS, 5.7 days in payload bay	64 craters between 0.1mm and 0.7mm diameter	0.7mm dia. crater in 0.8mm thick Al bumper
Pump Module Integrated Assembly (PMIA)	8.7 years on ISS	PM: 36 impact features LAPA: 19 impact features	PM: 0.8mm dia. perforation in Al tag LAPA: 1.8 x 1.8mm crater in Al handrail

MPLM grapple fixture coating spall dia. = 0.6 mm



Pump Module ID tag Hole dia. = 0.8 mm

