

NASA/TP-2014-218279



General Aviation Flight Test of Advanced Operations Enabled by Synthetic Vision

*Louis J. Glaab and Monica F. Hughes
Langley Research Center, Hampton, Virginia*

*Russell V. Parrish
Raytheon Company, Hampton, Virginia*

*Mohammad A. Takallu
Lockheed Martin Corporation, Hampton, Virginia*

NASA STI Program . . . in Profile

Since its founding, NASA has been dedicated to the advancement of aeronautics and space science. The NASA scientific and technical information (STI) program plays a key part in helping NASA maintain this important role.

The NASA STI program operates under the auspices of the Agency Chief Information Officer. It collects, organizes, provides for archiving, and disseminates NASA's STI. The NASA STI program provides access to the NASA Aeronautics and Space Database and its public interface, the NASA Technical Report Server, thus providing one of the largest collections of aeronautical and space science STI in the world. Results are published in both non-NASA channels and by NASA in the NASA STI Report Series, which includes the following report types:

- **TECHNICAL PUBLICATION.** Reports of completed research or a major significant phase of research that present the results of NASA Programs and include extensive data or theoretical analysis. Includes compilations of significant scientific and technical data and information deemed to be of continuing reference value. NASA counterpart of peer-reviewed formal professional papers, but having less stringent limitations on manuscript length and extent of graphic presentations.
- **TECHNICAL MEMORANDUM.** Scientific and technical findings that are preliminary or of specialized interest, e.g., quick release reports, working papers, and bibliographies that contain minimal annotation. Does not contain extensive analysis.
- **CONTRACTOR REPORT.** Scientific and technical findings by NASA-sponsored contractors and grantees.

- **CONFERENCE PUBLICATION.** Collected papers from scientific and technical conferences, symposia, seminars, or other meetings sponsored or co-sponsored by NASA.
- **SPECIAL PUBLICATION.** Scientific, technical, or historical information from NASA programs, projects, and missions, often concerned with subjects having substantial public interest.
- **TECHNICAL TRANSLATION.** English-language translations of foreign scientific and technical material pertinent to NASA's mission.

Specialized services also include organizing and publishing research results, distributing specialized research announcements and feeds, providing information desk and personal search support, and enabling data exchange services.

For more information about the NASA STI program, see the following:

- Access the NASA STI program home page at <http://www.sti.nasa.gov>
- E-mail your question to help@sti.nasa.gov
- Fax your question to the NASA STI Information Desk at 443-757-5803
- Phone the NASA STI Information Desk at 443-757-5802
- Write to:
STI Information Desk
NASA Center for AeroSpace Information
7115 Standard Drive
Hanover, MD 21076-1320

NASA/TP-2014-218279



General Aviation Flight Test of Advanced Operations Enabled by Synthetic Vision

*Louis J. Glaab and Monica F. Hughes
Langley Research Center, Hampton, Virginia*

*Russell V. Parrish
Raytheon Company, Hampton, Virginia*

*Mohammad A. Takallu
Lockheed Martin Corporation, Hampton, Virginia*

National Aeronautics and
Space Administration

Langley Research Center
Hampton, Virginia 23681-2199

July 2014

Available from:

NASA Center for Aerospace Information
7115 Standard Drive
Hanover, MD 21076-1320
443-757-5802

Table of Contents

1.0	ABSTRACT	11
2.0	INTRODUCTION	11
3.0	METHOD	13
3.1	FLIGHT TEST AIRCRAFT AND APPARATUS	13
3.2	DISPLAY CONCEPTS	14
3.3	SVS TERRAIN PORTRAYAL	21
3.4	EVALUATION PILOTS	21
3.5	SCENARIOS, TRAINING, AND OPERATIONS	22
3.5.1	<i>VFR Approach</i>	24
3.5.2	<i>ILS Approach</i>	24
3.5.3	<i>VMC-Like Approach</i>	24
3.5.4	<i>Training</i>	25
3.5.5	<i>Operations</i>	25
3.6	INDEPENDENT VARIABLES	26
3.7	TEST MATRIX	26
3.8	DEPENDENT MEASURES	28
3.8.1	<i>Qualitative Measures</i>	28
3.8.2	<i>Quantitative Measures</i>	29
4.0	DATA ANALYSES AND RESULTS	31
4.1	SITUATION AWARENESS	32
4.1.1	<i>VFR approach</i>	33
4.1.2	<i>ILS approach, all pilots</i>	33
4.1.3	<i>VMC-Like approach</i>	35
4.1.4	<i>ILS approach, without VFR pilot data</i>	35
4.1.5	<i>ILS and VMC-Like approach analysis, all pilots, advanced displays</i>	36
4.1.6	<i>Test condition analysis</i>	36
4.2	SUBJECTIVE WORKLOAD	38
4.2.1	<i>VFR approach</i>	39
4.2.2	<i>ILS approach, all pilots</i>	39
4.2.3	<i>VMC-Like approach</i>	40
4.2.4	<i>ILS approach without VFR pilot data</i>	41
4.2.5	<i>ILS and VMC-Like approach analysis, all pilots, advanced displays</i>	41
4.2.6	<i>Test condition analysis</i>	42
4.3	DISPLAY READABILITY RATING	43
4.3.1	<i>VFR approach, all pilots</i>	46
4.3.2	<i>ILS approach, all pilots</i>	46
4.3.3	<i>VMC-Like approach, all pilots</i>	46
4.3.4	<i>ILS approach without low-time VFR pilot data</i>	47
4.3.5	<i>ILS and VMC-Like approach analysis, all pilots, advanced displays</i>	48
4.3.6	<i>Test condition analysis</i>	48
4.4	TERRAIN AWARENESS	49
4.4.1	<i>VFR approach discussion</i>	51
4.4.2	<i>ILS approach, all pilots</i>	52
4.4.3	<i>VMC-Like approach, all pilots</i>	53
4.4.4	<i>ILS approach without low-time VFR pilot data</i>	53
4.4.5	<i>ILS and VMC-Like approach analysis, all pilots, advanced displays</i>	54

4.4.6	Test condition analysis	55
4.5	PTS RESULTS.....	57
4.5.1	ILS approach, all pilots	58
4.5.2	VMC-Like approach, all pilots, advanced displays.....	60
4.5.3	ILS approach Segment 3 without VFR pilot data.....	61
4.5.4	ILS and VMC-Like approaches, Segment 3, all pilots, advanced displays.....	61
4.5.5	Test condition analysis, Segment 3	64
4.6	LOCALIZER ERROR.....	65
4.6.1	VFR approach, all pilots.....	65
4.6.2	ILS approach, all pilots	68
4.6.3	VMC-Like approach, all pilots.....	70
4.6.4	ILS approach, Segment 3, no VFR pilots	72
4.6.5	ILS and VMC-Like approach analysis, Segment 3, all pilots.....	73
4.6.6	Test condition analysis, Segment 3	75
4.7	GLIDESLOPE ERROR.....	77
4.7.1	VFR approach, all pilots.....	77
4.7.2	ILS approach, all pilots	80
4.7.3	VMC-Like approach	82
4.7.4	ILS approach, Segment 3, no VFR pilots	85
4.7.5	ILS and VMC-Like approach analysis, Segment 3, all pilots.....	86
4.7.6	Test condition analysis, Segment 3	89
4.8	INDICATED AIRSPEED ERROR.....	91
4.8.1	VFR approach all pilots, S2 and 3	92
4.8.2	ILS approach, all pilots, Segments 2 and 3	95
4.8.3	ILS approach, Segment 3, no VFR pilots	97
4.8.4	VMC-Like approach, all pilots, Segments 2 and 3	97
4.8.5	ILS and VMC-Like approach analysis, Segment 3, all pilots.....	98
4.8.6	Test condition analysis, Segment 3	101
4.9	LATERAL FLIGHT-PATH ERROR.....	102
4.9.1	VFR approach	103
4.9.2	ILS approach, all pilots	105
4.9.3	VMC-Like approach, all pilots.....	108
4.9.4	ILS approach, Segment 3, without VFR pilot data.....	111
4.9.5	ILS and VMC-Like approach analysis, Segment 3, all pilots.....	112
4.9.6	Test condition analysis, Segment 3	113
4.10	VERTICAL FLIGHT PATH ERROR	115
4.10.1	VFR approach.....	115
4.10.2	ILS approach, all pilots	118
4.10.3	VMC-Like approach, all pilots	120
4.10.4	ILS approach, Segment 3, without VFR pilot data	122
4.10.5	ILS and VMC-Like approach analysis, Segment 3, all pilots	122
4.10.6	Test condition analysis, Segment 3.....	123
5.0	SUMMARY OF RESULTS	125
6.0	LIMITATIONS OF CURRENT STUDY	125
7.0	CONCLUSIONS	126
8.0	REFERENCES	129
APPENDIX A:	SINGLE-CUE FLIGHT DIRECTOR DESCRIPTION	132
APPENDIX B:	HIGHWAY-IN-THE-SKY GUIDANCE SYSTEM.....	135

APPENDIX B REFERENCES:	135
APPENDIX C: QUESTIONNAIRES.....	136
C.1 GENERAL	136
C.2 EVALUATION PILOT QUESTIONNAIRE (EPQ) TOOL	136
C.3 POST-RUN QUESTIONNAIRES, BASIC BLOCK:	137
APPENDIX D: INDIVIDUAL SUBJECTIVE DATA PLOTS.....	141

List of Figures

FIGURE 1: NASA LANGLEY CESSNA 206	14
FIGURE 2: BASELINE ROUND-DIAL DISPLAY CONCEPT	15
FIGURE 3: SINGLE-CUE FLIGHT DIRECTOR DISPLAY CONCEPT.....	16
FIGURE 4: PATHWAY-BASED GUIDANCE DISPLAY CONCEPT.....	17
FIGURE 5: SYNTHETIC VISION SYSTEM DISPLAY CONCEPT.....	17
FIGURE 6: CLOSE-UP OF DISPLAY CONCEPTS	19
FIGURE 7A: EXPANDED VIEW OF SVS DISPLAY CONCEPT PFD.....	20
FIGURE 8A: VFR SECTIONAL MAP VIEW WITH APPROACHES OVERLAID.....	23
FIGURE 9: SART RESULTS, ALL DISPLAY CONCEPTS, ALL PILOTS AND ALL APPROACHES	33
FIGURE 10: TLX RESULTS, ALL DISPLAY CONCEPTS, ALL PILOTS, AND ALL APPROACHES	39
FIGURE 11: CUMULATIVE PERCENTAGE OF DRR, ALL DISPLAY CONCEPTS AND ALL PILOTS	45
FIGURE 12: TERRAIN AWARENESS RESULTS FOR ALL DISPLAY CONCEPTS, ALL PILOTS AND ALL APPROACHES.....	51
FIGURE 13: PERCENT TIME WITHIN IFR PTS PERFORMANCE METRICS, ALL PILOTS, SEGMENTS 2 AND 3.....	58
FIGURE 14: PERCENT TIME WITHIN IFR PTS PERFORMANCE METRIC, ALL PILOTS, SEGMENT 3 ONLY	62
FIGURE 15: VFR APPROACH, LOCALIZER ERROR, BY DISPLAY CONCEPT AND PILOT GROUP.....	67
FIGURE 16: ILS APPROACH, LOCALIZER ERROR, BY DISPLAY CONCEPT AND PILOT GROUP	69
FIGURE 17: VMC-LIKE APPROACH, LOCALIZER ERROR, BY DISPLAY CONCEPT AND PILOT GROUP	71
FIGURE 18: LOCALIZER ERROR, SEGMENT 3 FOR ILS AND VMC-LIKE APPROACHES, ALL PILOTS.....	73
FIGURE 19: VFR APPROACH, GLIDESLOPE ERROR, BY DISPLAY CONCEPT AND PILOT GROUP.....	79
FIGURE 20: ILS APPROACH, GLIDESLOPE ERROR, BY DISPLAY CONCEPT AND PILOT GROUP	81
FIGURE 21: VMC-LIKE APPROACH, GLIDESLOPE ERROR, BY DISPLAY CONCEPT AND PILOT GROUP	84
FIGURE 22: GLIDESLOPE ERROR FOR SEGMENT 3, FOR APPROACHES 2 AND 3, ALL PILOTS	86
FIGURE 23: VFR APPROACH, IAS PERFORMANCE FOR ALL PILOTS AND DISPLAY CONCEPTS	94
FIGURE 24: ILS APPROACH, IAS PERFORMANCE FOR ALL PILOTS AND DISPLAY CONCEPTS.....	96
FIGURE 25: VMC-LIKE APPROACH, IAS PERFORMANCE FOR ALL PILOTS AND DISPLAY CONCEPTS	100
FIGURE 26: IAS ERROR FOR SEGMENT 3, ALL PILOTS, ALL APPROACHES	101
FIGURE 27: VFR APPROACH LATERAL ERROR FOR EACH DISPLAY, EACH PILOT GROUP	104
FIGURE 28: IFR APPROACH LATERAL ERROR, BY DISPLAY CONDITION AND PILOT GROUP.....	107
FIGURE 29: VMC-LIKE APPROACH LATERAL ERROR, BY DISPLAY CONCEPT AND PILOT GROUP	110
FIGURE 30: LATERAL ERROR FOR SEGMENT 3 FOR THE ILS AND VMC-LIKE APPROACH, ALL PILOTS	111
FIGURE 31: VFR APPROACH, VERTICAL ERROR, BY DISPLAY CONCEPT AND PILOT GROUP	117
FIGURE 32: ILS APPROACH, VERTICAL ERROR, BY DISPLAY CONCEPT AND PILOT GROUP.....	119
FIGURE 33: VMC-LIKE APPROACH, VERTICAL ERROR, BY DISPLAY CONCEPT AND PILOT GROUP.....	121
FIGURE 34: VERTICAL ERROR, SEGMENT 3, FOR APPROACHES 2 AND 3, ALL PILOTS	124
FIGURE A- 1: SINGLE CUE FLIGHT DIRECTOR.....	132
FIGURE A- 2: SINGLE-CUE FLIGHT DIRECTOR PITCH AND ROLL ATTITUDE COMMAND BLOCK DIAGRAM.	133
FIGURE B- 1: SVS PRIMARY FLIGHT DISPLAY SHOWING HITS GUIDANCE SYMBOLOGY.	135
FIGURE C- 1: EXAMPLE IMAGE OF THE EVALUATION PILOT QUESTIONNAIRE TOOL.	136
FIGURE C- 2: HAYWORTH-NEWMAN MODIFIED COOPER HARPER (DISPLAY READABILITY).....	140
FIGURE D- 1:SART AS A FUNCTION OF DISPLAY CONCEPT AND PILOT TYPE FOR EACH EVALUATION, VFR APPROACH.	142
FIGURE D- 2: SART AS A FUNCTION OF DISPLAY CONCEPT AND PILOT TYPE FOR EACH EVALUATION, ILS APPROACH.....	143
FIGURE D- 3: SART AS A FUNCTION OF DISPLAY CONCEPT AND PILOT TYPE, VMC-LIKE APPROACH.	144
FIGURE D- 4 TLX AS A FUNCTION OF DISPLAY CONCEPT AND PILOT TYPE, VFR APPROACH.....	145
FIGURE D- 5: TLX AS A FUNCTION OF DISPLAY CONCEPT AND PILOT TYPE, ILS APPROACH.	146
FIGURE D- 6: TLX AS A FUNCTION OF DISPLAY CONCEPT AND PILOT TYPE, VMC-LIKE APPROACH.....	147

FIGURE D- 7: DRR AS A FUNCTION OF DISPLAY CONCEPT AND PILOT TYPE, VFR APPROACH148
FIGURE D- 8: DRR AS A FUNCTION OF DISPLAY CONCEPT AND PILOT TYPE, ILS APPROACH.149
FIGURE D- 9: DRR AS A FUNCTION OF DISPLAY CONCEPT AND PILOT TYPE, VMC-LIKE APPROACH.....150
FIGURE D- 10: TERRAIN AWARENESS AS A FUNCTION OF DISPLAY CONCEPT AND PILOT TYPE, VFR APPROACH.151
FIGURE D- 11: TERRAIN AWARENESS AS A FUNCTION OF DISPLAY CONCEPT AND PILOT TYPE, ILS APPROACH.....152
FIGURE D- 12: TERRAIN AWARENESS AS A FUNCTION OF DISPLAY CONCEPT AND PILOT TYPE, VMC-LIKE APPROACH.153

List of Tables

TABLE 1: EVALUATION PILOT DATA	22
TABLE 2: INDEPENDENT VARIABLES USED FOR THIS EXPERIMENT	26
TABLE 3: TEST MATRIX	27
TABLE 4: DEFINITION OF TEST CONDITION VARIABLE	28
TABLE 5: SART DESCRIPTIVE STATISTICS (ALL PILOTS).....	32
TABLE 6: MEAN SART SNK RESULTS FOR ALL PILOTS, ILS APPROACH	34
TABLE 7: MEAN SART SNK RESULTS FOR ALL PILOTS FOR ALL DISPLAY CONCEPTS, ILS APPROACH	34
TABLE 8: MEAN SART SNK RESULTS FOR ALL PILOTS FOR ALL DISPLAY CONCEPTS, VMC-LIKE APPROACH	35
TABLE 9: MEAN SART RESULTS FOR IFR AND H-IFR PILOTS FOR THE ILS APPROACH	35
TABLE 10: MEAN SART SNK RESULTS FOR DISPLAY CONCEPT FOR IFR AND H-IFR PILOTS FOR THE ILS APPROACH.....	36
TABLE 11: MEAN SART SNK RESULTS FOR ADVANCED DISPLAY CONCEPTS FOR ALL PILOTS FOR ILS AND VMC-LIKE APPROACH	36
TABLE 12: MEAN SART SNK RESULTS FOR TEST CONDITION.....	37
TABLE 13: TLX DESCRIPTIVE STATISTICS (ALL PILOTS)	38
TABLE 14: MEAN TLX SNK RESULTS FOR DISPLAY CONCEPT FOR ALL PILOTS AND DISPLAY CONCEPTS, ILS APPROACH.....	40
TABLE 15: MEAN TLX SNK RESULTS FOR THE ADVANCED DISPLAY CONCEPTS FOR THE VMC-LIKE APPROACH	40
TABLE 16: MEAN TLX SNK RESULTS FOR PILOT TYPE FOR THE VMC-LIKE APPROACH.....	41
TABLE 17: MEAN TLX SNK RESULTS FOR DISPLAY CONCEPT FOR IFR AND H-IFR PILOTS FOR ALL DISPLAY CONCEPTS FOR THE ILS APPROACH.....	41
TABLE 18: MEAN SNK TLX RESULTS FOR DISPLAY CONCEPT FOR ALL PILOTS FOR THE ILS AND VMC-LIKE APPROACH (ADVANCED DISPLAY CONCEPTS)	42
TABLE 19: MEAN TLX SNK RESULTS FOR TEST CONDITION	43
TABLE 20: DISPLAY READABILITY PERCENTAGE OF TIME SELECTED RESULTS (ALL PILOTS).....	44
TABLE 21: DISPLAY READABILITY RESULTS FOR THE ILS APPROACH, IFR AND H-IFR PILOTS	47
TABLE 22: DRR RESULTS FOR TEST CONDITION.	49
TABLE 23: TA DESCRIPTIVE STATISTICS (ALL PILOTS).....	50
TABLE 24: MEAN TA SNK RESULTS FOR DISPLAY CONCEPT, FOR ALL PILOTS FOR THE VFR APPROACH	52
TABLE 25: MEAN TA SNK RESULTS FOR DISPLAY CONCEPT, FOR ALL PILOTS FOR THE ILS APPROACH	52
TABLE 26: MEAN TA SNK RESULTS FOR DISPLAY CONCEPT FOR ALL PILOTS FOR THE VMC-LIKE APPROACH	53
TABLE 27: MEAN TA SNK RESULTS FOR THE ILS APPROACH, IFR AND H-IFR PILOTS	54
TABLE 28: MEAN TA SNK RESULTS FOR PILOT TYPE FOR THE ILS AND VMC-LIKE APPROACH FOR ALL PILOTS	54
TABLE 29: MEAN TA SNK RESULTS FOR DISPLAY CONCEPT FOR THE ILS AND VMC-LIKE APPROACH, ALL PILOTS	55
TABLE 30: MEAN TA SNK RESULTS FOR TEST CONDITION.....	56
TABLE 31: PTS DESCRIPTIVE STATISTICS (% TIME), SEGMENTS 2 AND 3 FOR ALL PILOTS	57
TABLE 32: MEAN PTS (% OF TIME) SNK RESULTS FOR DISPLAY CONCEPT FOR ALL PILOTS, ILS APPROACH.	59
TABLE 33: MEAN PTS (% OF TIME) SNK RESULTS FOR PILOT TYPE FOR ALL DISPLAY CONCEPTS, ILS APPROACH.	59
TABLE 34: MEAN PTS (% OF TIME) RESULTS FOR PILOT TYPE AND DISPLAY CONCEPT, ILS APPROACH.	60
TABLE 35: MEAN PTS (% OF TIME) SNK RESULTS FOR DISPLAY CONCEPT FOR ALL PILOTS, VMC-LIKE APPROACH	60
TABLE 36: MEAN PTS (% OF TIME) SNK RESULTS FOR PILOT TYPE FOR ALL DISPLAY CONCEPTS, VMC-LIKE APPROACH	61
TABLE 37: PTS (% OF TIME) RESULTS FOR DISPLAY CONCEPT FOR SEGMENT 3 OF THE ILS APPROACH, IFR AND H-IFR PILOTS ONLY....	61
TABLE 38: PTS (% OF TIME) CRITERIA FOR DISPLAY CONCEPT AND APPROACH INTERACTIONS, ILS AND VMC-LIKE APPROACHES, SEGMENT 3	63
TABLE 39: PTS (% OF TIME) CRITERIA RESULTS FOR DISPLAY CONCEPT AND PILOT TYPE INTERACTIONS, ILS AND VMC-LIKE APPROACHES, SEGMENT 3.....	63
TABLE 40: PTS (% OF TIME) CRITERIA RESULTS FOR APPROACH AND PILOT TYPE INTERACTIONS, ILS AND VMC-LIKE APPROACHES, SEGMENT 3	63
TABLE 41: MEAN PTS (% OF TIME) SNK CRITERIA RESULTS FOR TC, ALL PILOTS, SEGMENT 3	64
TABLE 42: LOCALIZER ERROR (DOTS) DESCRIPTIVE STATISTICS FOR ALL PILOTS	65
TABLE 43: MEAN LOCALIZER ERROR (DOTS) SNK RESULTS FOR DISPLAY CONCEPT VFR APPROACH FOR ALL PILOTS	66
TABLE 44: MEAN LOCALIZER ERROR (DOTS) SNK RESULTS FOR DISPLAY CONCEPT FOR ILS APPROACH FOR ALL PILOTS	68

TABLE 45: LOCALIZER ERROR RESULTS (DOTS) FOR DISPLAY CONCEPT AND PILOT TYPE INTERACTIONS FOR THE ILS APPROACH	70
TABLE 46: MEAN LOCALIZER ERROR (DOTS) SNK RESULTS FOR DISPLAY CONCEPT FOR THE VMC-LIKE APPROACH FOR ALL PILOTS	70
TABLE 47: MEAN LOCALIZER ERROR (DOTS) SNK RESULTS FOR THE ILS APPROACH FOR THE IFR AND H-IFR PILOTS	72
TABLE 48: MEAN AND STANDARD DEVIATION FOR LOCALIZER ERROR (DOTS) FOR THE ILS AND VMC-LIKE APPROACH, ALL PILOTS.....	74
TABLE 49: MEAN LOCALIZER ERROR (DOTS) SNK RESULTS, ILS AND VMC-LIKE APPROACH FOR ALL PILOTS	74
TABLE 50: MEAN AND STANDARD DEVIATION RESULTS FOR LOCALIZER ERROR (DOTS) FOR THE ILS AND VMC-LIKE APPROACH FOR ALL PILOTS	75
TABLE 51: MEAN LOCALIZER ERROR (DOTS) SNK RESULTS FOR TEST CONDITION	76
TABLE 52: GLIDESLOPE ERROR (DOTS) DESCRIPTIVE STATISTICS FOR ALL PILOTS.....	77
TABLE 53: MEAN GLIDESLOPE ERROR (DOTS) SNK RESULTS FOR DISPLAY CONCEPT FOR THE VFR APPROACH FOR ALL PILOTS.....	78
TABLE 54: MEAN GLIDESLOPE ERROR (DOTS) SNK RESULTS FOR DISPLAY CONCEPT, ILS APPROACH FOR ALL PILOTS	80
TABLE 55: MEAN GLIDESLOPE ERROR (DOTS) SNK RESULTS FOR DISPLAY CONCEPT, VFR APPROACH FOR ALL PILOTS	80
TABLE 56: MEAN GLIDESLOPE ERROR (DOTS) SNK RESULTS FOR DISPLAY CONCEPT, VMC-LIKE APPROACH FOR ALL PILOTS	83
TABLE 57: MEAN GLIDESLOPE ERROR (DOTS) SNK RESULTS FOR THE ILS APPROACH, IFR AND H-IFR PILOTS	85
TABLE 58: MEAN GLIDESLOPE ERROR (DOTS) SNK RESULTS FOR THE ILS AND VMC-LIKE APPROACHES FOR ALL PILOTS.....	87
TABLE 59: STATISTICAL INTERACTION RESULTS FOR GLIDESLOPE ERROR (DOTS) FOR DISPLAY CONCEPT AND PILOT TYPE FOR THE ILS AND VMC-LIKE APPROACHES	88
TABLE 60: STATISTICAL INTERACTION GLIDESLOPE ERROR (DOTS) DATA FOR DISPLAY CONCEPT AND APPROACH FOR THE ILS AND VMC-LIKE APPROACHES	89
TABLE 61: MEAN GLIDESLOPE ERROR (DOTS) SNK RESULTS FOR TEST CONDITION	90
TABLE 62: IAS ERROR (KTS) DESCRIPTIVE STATISTICS FOR SEGMENT 2 FOR ALL PILOTS.....	91
TABLE 63: IAS ERROR (KTS) DESCRIPTIVE STATISTICS FOR SEGMENT 3 FOR ALL PILOTS.....	92
TABLE 64: MEAN IAS ERROR (KTS) SNK RESULTS FOR THE VFR APPROACH, SEGMENT 3 FOR ALL PILOTS.....	93
TABLE 65: MEAN IAS ERROR (KTS) SNK RESULTS FOR THE ILS APPROACH, SEGMENT 2 FOR ALL PILOTS	95
TABLE 66: MEAN IAS ERROR (KTS) SNK RESULTS FOR THE ILS APPROACH, SEGMENT 3 FOR ALL PILOTS	95
TABLE 67: INCREASE IN MEAN IAS ERROR (KTS) FOR THE VFR PILOTS COMPARED TO THE AVERAGE OF THE IFR AND H-IFR PILOTS FOR THE ILS APPROACH, SEGMENTS 2 AND 3	97
TABLE 68: MEAN IAS ERROR (KTS) FOR SEGMENT 2 AND SEGMENT 3 OF THE ILS APPROACH, IFR AND H-IFR PILOTS.....	97
TABLE 69: IAS ERROR (KTS) FOR SEGMENT 2 AND SEGMENT 3 OF THE VMC-LIKE APPROACH FOR ALL PILOTS	98
TABLE 70: PERCENT IAS ERROR INCREASE COMPARED TO ILS EVALUATION OF BRD DISPLAY CONCEPT (IFR AND H-IFR PILOTS) FOR SEGMENT 3 FOR ILS AND VMC-LIKE APPROACHES (ALL PILOTS).....	99
TABLE 71: MEAN IAS ERROR (KTS) SNK RESULTS FOR TC	102
TABLE 72: LATERAL FLIGHT-PATH ERROR (FT) DESCRIPTIVE STATISTICS FOR ALL PILOTS.....	103
TABLE 73: MEAN LATERAL FLIGHT-PATH ERROR (FT) SNK RESULTS FOR DISPLAY CONCEPT FOR ALL PILOTS FOR THE VFR APPROACH	105
TABLE 74: MEAN LATERAL FLIGHT-PATH ERROR (FT) SNK RESULTS FOR DISPLAY CONCEPT FOR ALL PILOTS FOR THE ILS APPROACH ..	108
TABLE 75: MEAN LATERAL FLIGHT-PATH ERROR (FT) SNK RESULTS FOR DISPLAY CONCEPT FOR ALL PILOTS FOR THE VMC-LIKE APPROACH	109
TABLE 76: MEAN LATERAL FLIGHT-PATH ERROR (FT) SNK RESULTS, FOR THE ILS APPROACH, IFR AND H-IFR PILOTS	112
TABLE 77: MEAN LATERAL FLIGHT-PATH ERROR (FT) SNK RESULTS, SEGMENT 3 OF THE ILS AND VMC-LIKE APPROACHES FOR ALL PILOTS	113
TABLE 78: LATERAL FLIGHT-PATH ERROR STATISTICAL RESULTS (FT), SEGMENT 3 OF THE ILS AND VMC-LIKE APPROACHES FOR ALL PILOTS.....	113
TABLE 79: MEAN LATERAL FLIGHT-PATH ERROR (FT) SNK RESULTS FOR TC.....	114
TABLE 80: VERTICAL PATH ERROR (FT) DESCRIPTIVE STATISTICS FOR ALL PILOTS	115
TABLE 81: MEAN VERTICAL FLIGHT-PATH ERROR (FT) SNK RESULTS FOR DISPLAY CONCEPT FOR ALL PILOTS FOR THE VFR APPROACH	116
TABLE 82: MEAN VERTICAL FLIGHT PATH ERROR (FT) SNK RESULTS FOR DISPLAY CONCEPT FOR ALL PILOTS, ILS APPROACH.....	118
TABLE 83: MEAN VERTICAL FLIGHT-PATH ERROR (FT) SNK RESULTS FOR THE ILS APPROACH, IFR AND H-IFR PILOTS ONLY.....	122
TABLE 84: MEAN VERTICAL FLIGHT-PATH ERROR (FT) SNK RESULTS FOR PILOT TYPE, ILS AND VMC-LIKE APPROACHES FOR ALL PILOTS	123
TABLE 85: MEAN VERTICAL FLIGHT-PATH ERROR (FT) SNK RESULTS FOR THE ADVANCED DISPLAY CONCEPTS, ILS AND VMC-LIKE APPROACHES FOR ALL PILOTS	123
TABLE 86: MEAN VERTICAL FLIGHT-PATH ERROR (FT) SNK RESULTS FOR TC	124

Abbreviations

2-D	Two Dimensional
3-D	Three Dimensional
AC	Advisory Circular
ADAHRS	Air Data, Attitude, and Heading Reference System
AGL	Above Ground Level
ANOVA	Analysis of Variance
ATC	Air Traffic Control
BRD	Baseline Round Dials
C206	Cessna 206 aircraft
CDI	Course Deviation Indicator
CFIT	Controlled Flight Into Terrain
DEM	Digital Elevation Model
DH	Decision Height
DRR	Display Readability Rating
EBG	Elevation-Based Generic terrain texturing
EP	Evaluation Pilot
EPQ	Evaluation Pilot Questionnaire tool
F	F-ratio: a test statistic with a known probability distribution (the F-distribution) used to test for overall differences between group means in experiments
FAA	Federal Aviation Administration
ft	Feet
GA	General Aviation
GAMA	General Aviation Manufacturers Association
GPS	Global Positioning System
H-IFR	High-time Instrument Rated Pilots
HF	Human Factors
HITS	Highway-In-The-Sky guidance
IAS	Indicated Airspeed
IFD	Integration Flight Deck Simulator
IFR	Instrument Flight Rules
ILS	Instrument Landing System
IMC	Instrument Meteorological Conditions
kts	Knots
KROA	FAA 4-letter identifier for Roanoke Woodrum Airport
LCD	Liquid Crystal Display
MA	Missed Approach
MSL	Mean Sea Level
NAS	National Airspace System
ND	Navigation Display
nm	Nautical Mile
p	Degree of significance of the results from the analysis of variance

PBG	Pathway-Based Guidance
PFD	Primary Flight Display
PTS	Practical Test Standards
Q	Questionnaire
RMS	Root Mean Square
RNP	Required Navigation Performance
SA	Situation Awareness
SART	Situation Awareness Rating Technique
SCFD	Single-Cue Flight Director
SNK	Student-Newman-Keuls post-hoc analysis technique
SP	Safety Pilot
SVS	Synthetic Vision System
TA	Terrain Awareness
TAWS	Terrain Awareness and Warning System
TC	Test Condition
TE	Test Engineer
TLX	Task Load Index
VFR	Visual Flight Rules
VMC	Visual Meteorological Conditions
WAAS	Wide-Area Augmentation System

1.0 Abstract

A flight test was performed to compare the use of three advanced primary flight and navigation display concepts to a baseline, round-dial concept to assess the potential for advanced operations. The displays were evaluated during visual and instrument approach procedures including an advanced instrument approach resembling a visual airport traffic pattern. Nineteen pilots from three pilot groups, reflecting the diverse piloting skills of the General Aviation pilot population, served as evaluation subjects. The experiment had two thrusts: 1) an examination of the capabilities of low-time (i.e., <400 hours), non-instrument-rated pilots to perform nominal instrument approaches, and 2) an exploration of potential advanced Visual Meteorological Conditions (VMC)-like approaches in Instrument Meteorological Conditions (IMC). Within this context, advanced display concepts are considered to include integrated navigation and primary flight displays with either aircraft attitude flight directors or Highway In The Sky (HITS) guidance with and without a synthetic depiction of the external visuals (i.e., synthetic vision). Relative to the first thrust, the results indicate that using an advanced display concept, as tested herein, low-time, non-instrument-rated pilots can exhibit flight-technical performance, subjective workload and situation awareness ratings as good as or better than high-time Instrument Flight Rules (IFR)-rated pilots using Baseline Round Dials for a nominal IMC approach. For the second thrust, the results indicate advanced VMC-like approaches are feasible in IMC, for all pilot groups tested for only the Synthetic Vision System (SVS) advanced display concept. These findings are valid for the conditions tested and that this test only examined nominal operations and did not include traffic separation, hazardous weather, equipment failures, etc. Other related factors not addressed were pilots' decision-making ability or possible overconfidence.

2.0 Introduction

Synthetic Vision Systems (SVS) primary flight displays present a continuous computer-generated image of the external scene topography from the perspective of the flight deck, albeit possibly minified, creating an electronic means of continuous visual-like information for the pilot/flight crew. When combined with integrated guidance symbology, SVS have been shown to significantly increase situation awareness (SA) and pilot performance while decreasing workload during operations in Instrument Meteorological Conditions (IMC) (Ref. 1-12) compared to traditional flight instrument display concepts. Throughout this paper, for brevity, this combination of flight path guidance with SVS terrain information will be referred to as SVS displays or the SVS display concept.

A critical component of SVS displays is the appropriate presentation of terrain to the pilot. References 1-4, 6, 9, and 12 examined the effects of two primary elements of terrain portrayal on the primary flight display (PFD): 1) variations of digital elevation model (DEM) resolution; and, 2) terrain texturing, along with other aspects of SVS displays. Higher resolution DEMs can enable more terrain features to be represented in the SVS terrain especially in mountainous areas. Different texturing concepts can be employed to convey various types of information to the pilot. One type of texturing, referred to as photo-realistic, applies ortho-rectified imagery to produce SVS terrain that appears very similar to the outside world, thereby conveying cultural feature information. Other terrain texturing concepts employ elevation-based terrain texturing concepts which can enhance the terrain height cues. References 1-4, 6, 9, and 12 reported on several generic as well as photo-realistic concepts. References 4 and 12 expanded the analysis to include interactions between different symbology, both 2-dimensional (2-D) and 3-dimensional (3-D), along with various SVS terrain portrayal concepts. Results from these studies indicated that significant improvements in SA can be realized over a wide range of DEMs and texturing concepts, and established recommended best practices for SVS terrain portrayal. Results from References 3, 4, 8, and 12 also indicated that 3-D guidance symbology, that combined a minimal

highway-in-the-sky (HITS) depiction along with a flight path vector with guidance, provided significant benefits compared to other guidance concepts.

Traditional IMC operations feature approaches with long straight legs, gradual descents and large airspace requirements to accommodate historical surveillance, navigation, and flight technical performance considerations. These factors can be particularly restrictive at airports in mountainous areas. Several references (see Ref. 3-5, 7, 8, 10, 11, and 12) explored the benefits of SVS displays to enable advanced IMC approaches. These advanced IMC approaches resembled Visual Meteorological Conditions (VMC)-style approaches requiring more aggressive maneuvering than traditional IMC operations. If proven, these VMC-style approaches would allow a drastic reduction in the Instrument Flight Rules (IFR) ceiling and visibility landing minima below what would normally be in effect at terrain-challenged airports during periods of poor visibility. While it is possible that approach operations could be conducted with advanced autopilots, it is considered that keeping the pilots in the aircraft control loop provides a superior alternative both for safety of flight as well as potential implementation into the GA fleet. Results from these studies indicated that VMC-style approaches may be possible with SVS displays.

The current effort obtained flight test data for advanced displays and approaches not traditionally available for General Aviation (GA) operations. This new data evaluated the potential of SVS displays to effectively transform IMC flight and enable advanced operations. Unlike previous research in this area that endeavored to show a significant improvement due to SVS display technology compared to a conventional baseline for specific IMC test conditions, this flight test investigated several points to more effectively measure, assess, and interpret the results. While the “gold standard” of IMC operations was included (the Instrument Landing System (ILS) approach), a nominal Visual Flight Rules (VFR) approach was also included. This establishes the relationship between IMC and VMC operations within several common Human Factors (HF) measures and a metric to evaluate advanced approaches and display concepts. Two other conditions were included within the data set of significant note: 1) VFR-rated pilots flying an ILS approach in IMC with the baseline round dial display concept, and 2) an VMC-like approach flown with the advanced display concepts in simulated IMC. The value of #1 was to establish a condition within the data set of unquestionably high risk that unfortunately arises in real-world operations. This condition also enables an evaluation of the effect of IFR pilot training across a wide range of display concepts. The VMC-like approach (#2) in simulated IMC was included to create a direct comparison of out-the-window visibility along with enabling the evaluation of a potentially advanced IMC approach with substantial operational benefits. The selection of pilots provided evaluated the effect of advanced display concepts on low-time VFR pilots along with low-time and high-time IFR-rated pilots.

The recent advent of affordable electronic displays, with dimensions and other characteristics suitable for installation in small airplanes, offers GA avionics and airplane manufacturers more flexibility in presentation and placement of cockpit instruments and system controls than ever before possible according to the General Aviation Manufacturers Association (GAMA) (Ref. 13). These new technologies, which include SVS displays, can provide dramatic improvements in the capabilities of GA airplanes flown by a single pilot in IMC according to Reference 13. The Federal Aviation Administration (FAA) has also published an Advisory Circular (AC) [14] relating to the standardization of advanced displays, acknowledging Reference 13, and an AC on the acceptable means of compliance for synthetic vision and pathway depictions (Ref. 15). Overall, while AC23-26 (Ref. 15) defines criterion of how SVS displays can replace traditional displays, it does so within the realm of improved safety and does not discuss potential operational benefits due to this technology.

This paper documents the results of a flight test that was conducted to examine the hypothesis that SVS displays may significantly transform approach operations in IMC flight. The flight test was conducted using a representative GA aircraft modified to enable evaluation of four primary display

concepts in rapid succession. Those primary display concepts were: 1) a baseline round-dial display concept; 2) a single-cue flight director display concept (without SVS terrain); 3) a pathway-based guidance display concept (without SVS terrain), and 4) the SVS display concept. The subject pilot population was as follows: 1) low-time VFR-rated pilots; 2) pilots just exceeding the minimum training and experience requirements to possess an IFR rating; and 3) very high-time, highly experienced IFR-rated pilots. The evaluation tasks were: 1) a VFR approach; 2) a nominal Instrument Landing System (ILS) approach performed in simulated IMC and 3) a VMC-like approach performed in simulated IMC. The research location was one with substantial terrain-induced operational restrictions, especially in IMC.

Three sub-hypotheses were examined to characterize and quantify the transformation of approach operations in IMC flight provided by advanced display concepts, especially those employing SVS.

- 1) *Using SVS displays, the workload and SA of all pilots flying approaches in IMC will be as good as, or better than, the same pilots flying in VMC using baseline round-dial displays.*

It is well-known that the reduced visibility in IMC has a substantial impact on pilot workload and SA compared to VMC flight. By demonstrating that this hypothesis is true, one could imply that SVS displays significantly transform approach operations in IMC flight by reducing pilot workload and increasing SA to levels better than or comparable to VMC.

- 2) *Using SVS displays, low-time, non-instrument-rated pilots flying nominal ILS approaches in IMC will achieve flight technical error, workload, and SA results as good as, or better than, ratings from instrument-rated pilots conducting the same ILS approach using baseline, round-dial displays.*

It should be noted that this experiment only examined nominal approaches and did not include traffic separation, hazardous weather, equipment failures, etc. Also, other important factors, such as objective measures of pilots' decision-making ability or possible overconfidence were not evaluated. However, considering the substantial training and high standards to obtain an IFR type rating, demonstrating that this hypothesis is true could imply that SVS displays have the potential to significantly transform flying for low-time VFR pilots, perhaps even enabling them to fly safely in IMC.

- 3) *Using SVS displays, all pilots, including low-time, non-instrument-rated pilots, will be able to conduct IMC approaches with geometries similar to a VFR pattern with flight technical error, workload, and SA results as good as, or better than, results from instrument rated pilots conducting ILS approaches using baseline round-dial displays.*

The third hypothesis concerns flight performance using SVS displays to conduct IMC landing approaches with geometries other than traditional long, straight-in final approach segments. Again, considering the substantial training and high standards required to obtain an IFR type rating, demonstrating that this hypothesis is true could imply that SVS displays have the potential to significantly transform flying for all pilots, perhaps even enabling low-time VFR pilots to fly approaches with curved segments safely in IMC.

3.0 Method

A coordinated simulation and flight-test effort was conducted using the NASA Langley Research Center Integration Flight Deck simulator (IFD) and the NASA Langley Cessna 206 (C206) aircraft. This report presents results from the flight test effort (see Reference 11 for the IFD simulator results).

3.1 Flight Test Aircraft and Apparatus

A C206 aircraft (see Figure 1) was modified for this flight test through installation of a 10.4 inch diagonal Liquid Crystal Display (LCD) research display on the right side of the instrument panel; a 6.4

inch LCD research display in the top of the center radio stack; two electro-mechanical, simulator-grade, round-dial gauges; two general-purpose computers; and an air data and attitude and heading reference system. The two electro-mechanical round-dial gauges were required since the 10.4 inch LCD, that was the largest that could be installed, was not large enough to simultaneously display all of the round-dial gauges. These modifications established an Evaluation Pilot (EP) station on the right side of the aircraft, as shown in Figure 2, as well as the required infrastructure to support research operations. In the conventional display configuration, seven 3 inch-diameter Baseline Round Dials (BRDs) displayed airspeed, attitude, altitude, turn and bank, heading, vertical speed, and localizer/glideslope course deviation indicators (CDIs). To allow rapid comparison with the other displays, most of the round-dial gauges were computer-generated and displayed on the 10.4 inch LCD. For the advanced display configurations, the research display system enabled evaluations of dual 6.4 inch advanced displays (using only a portion of the 10.4 inch LCD), such as a Navigation Display (ND) and Primary Flight Display (PFD) with HITS symbology. The conventional display and advanced display concept configurations could be changed rapidly in flight through computer configuration files. As configured for this flight test, the EP occupied the front right seat of the aircraft, and the safety pilot (SP) occupied the front left seat. A Test Engineer (TE) occupied the middle row right seat and was provided with display, keyboard, and mouse interfaces to operate the research system and direct the test. The third seating row of the C206 aircraft was removed.



Figure 1: NASA Langley Cessna 206.

3.2 Display Concepts

Four display concepts were evaluated:

- 1) Conventional Baseline Round Dials (hereinafter referred to as BRD);
- 2) ND and PFD with Single-Cue Flight Director (hereinafter referred to as SCFD);
- 3) ND and PFD with HITS providing Pathway-Based Guidance (hereinafter referred to as PBG);
- 4) ND and SVS PFD with HITS (hereinafter referred to as SVS).

Photographs of the four display concepts as implemented in the C206 are provided in Figures 2 through 6. Note that the ND display was invariant for the SCFD, PBG, and SVS advanced display concepts.



Figure 2: Baseline Round-Dial Display Concept

The SCFD display concept was included in this experiment since it is included in many commercially available glass-cockpit displays and offers a significant improvement over the minimum required baseline round dials. It also serves as a secondary baseline for comparison with the PBG and SVS display concepts. The attitude-based SCFD is driven by a compensatory flight director control law as described in Appendix A.



Figure 3: Single-Cue Flight Director Display Concept

Based upon results of research conducted on SVS displays to date, such as References 1 through 12, perspective pathway-based guidance symbologies have been used with SVS display concepts to enhance integration with the 3-D SVS terrain. This integration not only improves terrain awareness relative to the desired route, but also enhances pilots' overall SA since route and outside terrain are provided in the same frame of reference. As a result, the PBG display concept was included to create a clear evaluation of the differences between a single-cue attitude-based flight director and pathway-based pursuit-based guidance symbology as well as the direct effect of SVS terrain (i.e., the only difference between the PBG and SVS display concepts was the SVS terrain). The HITS guidance used for this test is known as the Crow's-Foot tunnel with tadpole guidance cue (driven using a modified pursuit control law) and is described in References 3, 4, 8, 9, 11, and 12. Right-angle magenta triads formed the corner points of the desired flight path tunnel. The tunnel was set to 2 dots of localizer error and 1 dot of glideslope error and limited to 600 ft wide and 350 ft tall. See Appendix B for a description of the HITS guidance system employed herein.



Figure 4: Pathway-Based Guidance Display Concept



Figure 5: Synthetic Vision System Display Concept

Some minor variations from what could be considered to be standard baseline round-dial displays were used, including: 1) use of a sky pointer (vs. turn pointer) for the bank-angle indication on the attitude indicator; 2) expanded pitch scale on the attitude indicator, resulting in a potentially more precise pitch

scale than is common; and, 3) use of graphics displays to present airspeed, attitude, turn and bank, and directional gyro gauges with simulator-grade electro-mechanical gauges for altitude and vertical speed. When considering the level and quality of pilot training involved in this flight test (discussed below), the BRD variations were considered minimal, and that the BRD display concept evaluations were representative of pilot performance with conventional displays.

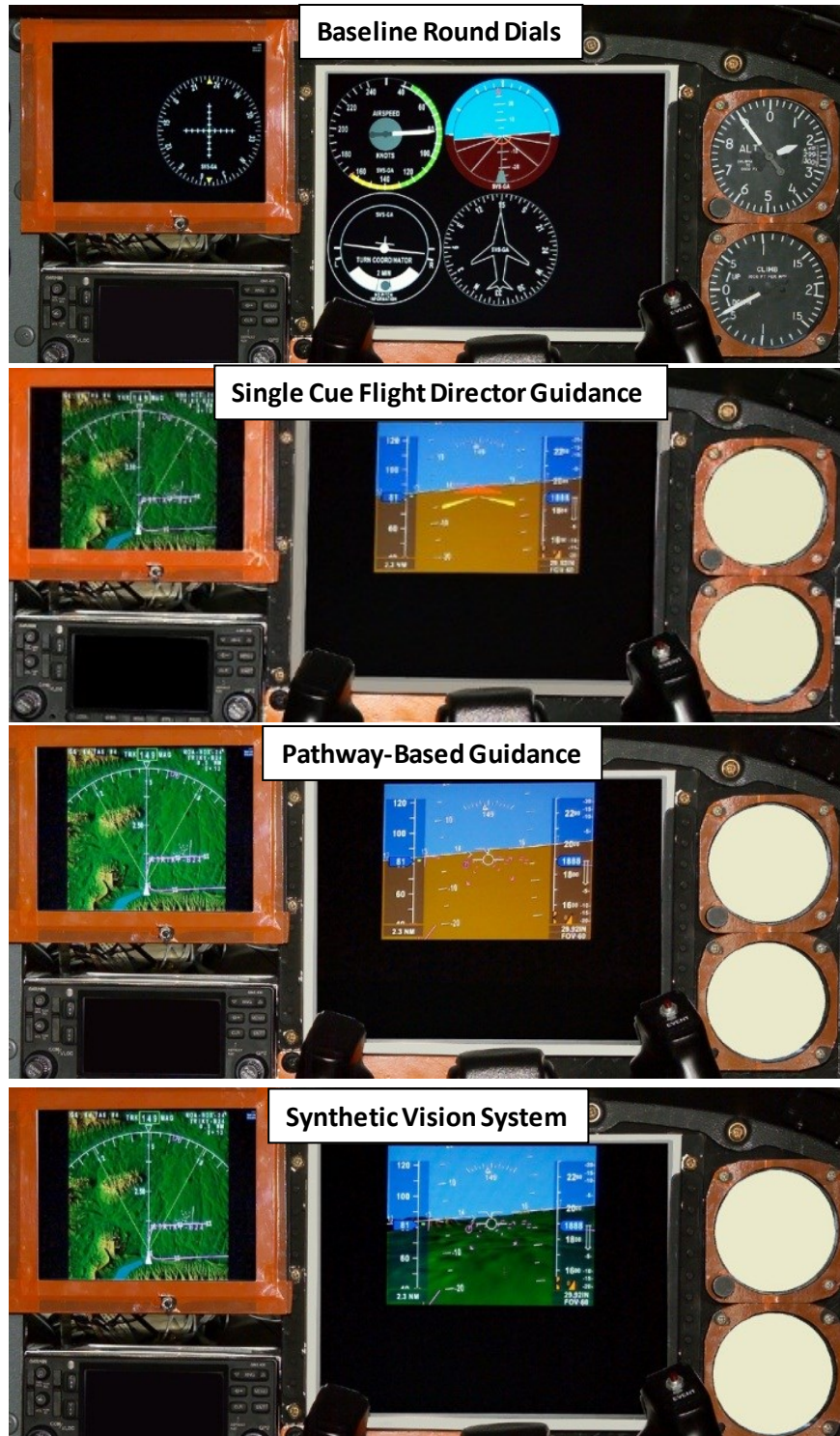

Figure 6: Close-up of Display Concepts

The PFD and ND display concepts were presented over a display area of approximately 6.4 inch diagonal. This size display is representative of the smaller range of displays being developed for GA. All

of the advanced display concepts incorporated the same ND, and each PFD used a 60-degree horizontal field of regard and a corresponding vertical field of regard of 45 degrees. The track-up ND used the same terrain database as the SVS PFD and included: 1) a god’s-eye view of terrain; 2) terrain awareness and warning system (TAWS) “peaks mode” speckling on the moving map (see References 16 and 17 for background on TAWS); 3) flight path and waypoints; ownship symbol and turn predictor “noodle;” 4) route information; 5) traffic symbology; and 6) PFD viewing wedge. Traffic symbology was not driven by actual data but used pre-recorded simulated aircraft trajectories that would initiate movement when the C206 crossed over a specific start point for the approach.

The SCFD concept had integrated airspeed and altitude tapes along with a sky-pointer/roll scale and a single-cue flight director. The PBG concept included the crow’s foot tunnel pathway or HITS with tadpole guidance command and a pitch-quickened velocity vector, as well as air traffic symbology. The SVS concept included the features of the PBG concept with a terrain background in place of the blue-sky/brown-ground presentation. This particular combination of SVS terrain and guidance symbology was selected based on results of previous experiments (Ref. 2-5). Close-up photographs of the four display concepts are provided in Figure 6. In order to provide the details of the SVS PFD and ND computer generated screen captures are presented in Figures 7a and 7b.

For all display concepts, maximum displayed localizer and glideslope error was set to 2.0 dots deflection for the ILS approaches. Indicated angular error was based on the lateral and vertical distance from the centerline of the desired flight path and the distance along-path to a notional ILS navigation beam source (i.e., localizer and glideslope) and only displayed for the ILS approach evaluations.



Figure 7a: Expanded view of SVS Display Concept PFD

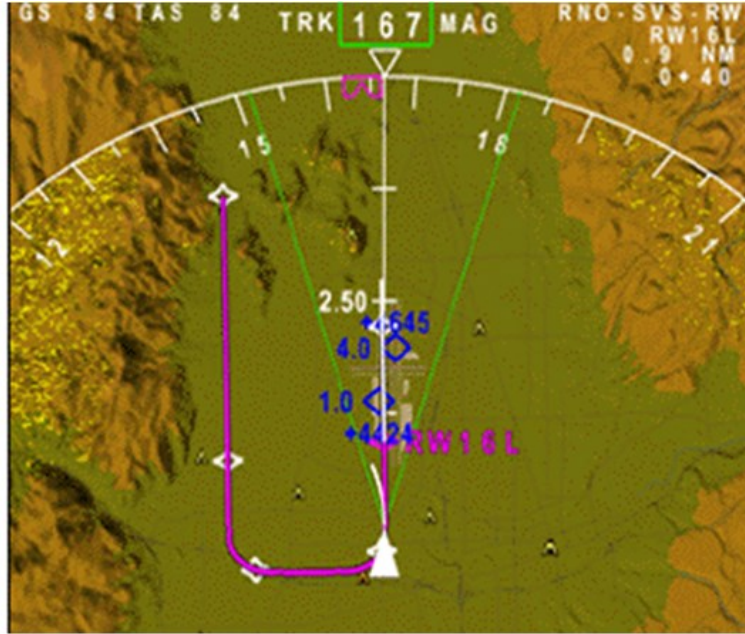

Figure 7b: Expanded View of Navigation Display

3.3 SVS Terrain Portrayal

The SVS terrain portrayal used for this study is referred to as the Elevation-Based Generic (EBG) terrain portrayal concept, developed and evaluated in earlier studies (Ref. 1-4, 6, 9, 11, and 12). The Digital Elevation Model (DEM) used three arc-second resolution (approximately 295 ft (90m) post-spacing) terrain data. Based on results from References 2 and 3, this level of DEM resolution provides good terrain awareness during IMC flight.

The EBG texturing concept consisted of twelve equal-height coloration bands. These bands corresponded to different absolute terrain elevation levels. The coloration bands were based on VFR sectional charts and applied to the various local-area altitude elevation bands, where lower terrain levels were rendered with darker colors, while higher terrain levels were assigned lighter colors. A specific shade of green was set to the field elevation of 1,175 ft above Mean Sea Level (MSL). The lightest VFR sectional color was set to the highest terrain within 50 nm of the research airport, approximately 4000 ft MSL. Cultural features, such as roads and rivers, were included as objects in the terrain database. Simulated daylight shading was also used to accentuate the terrain features. An example of the EBG texturing concept is provided in Figure 7a. This view was taken from the south east looking back towards the airport where the flight test was conducted.

The airport model included runways with markings along with visually prominent airport buildings. All models were overlaid on top of the underlying elevation database. Obstacles greater than 200 ft high within 20 nm of the airport were represented by narrow rectangular barber-pole striped objects portraying their height and location, as provided within the FAA's published obstacle database.

3.4 Evaluation Pilots

Nineteen EPs with a minimum of a current FAA pilot's certificate and Class III medical certificate, or equivalent, participated. EPs were categorized into pilot types by their experience level. The pilot categories and mean total number of flight hours of experience are shown in Table 1. The pilot spectrum was selected to enable an evaluation of SVS display technology with application to the diverse GA

population. The VFR, IFR, and H-IFR rated pilots represented the spectrum of pilot skills currently operating within the National Airspace System (NAS).

Low-time VFR-rated pilots were included to test the hypothesis that SVS displays can enable them to achieve flight technical error, workload and SA ratings that are as good as, or better than, IFR pilots flying in IMC using baseline round dials. Instrument-rated pilots with flight time less than 1,000 hours were included to establish a baseline characterization of minimum IFR-rated performance as well as to ascertain the effect that SVS, and other advanced display technologies, would have on this segment of the pilot population. Very experienced pilots with instrument ratings and flight time greater than 2,000 hours (hereinafter referred to as H-IFR pilots) were also included to determine the effect that SVS and other advanced display technologies would have on highly-experienced airline and professional test pilots and also to facilitate comparison of results from this study with other studies. All H-IFR pilots were current or retired professional pilots.

Table 1 Evaluation Pilot Data

Pilot Type	Number of EPs	Mean Flight Time, Hours	Minimum Flight Time, Hrs	Maximum Flight Time, Hrs	Standard Deviation, Hours
VFR (<400 hrs)	6	241	102	400	107
IFR (<1000 hrs)	6	468	267	620	131
H-IFR (1000+ hrs)	7	4019	1980	7000	1811
Total	19		102	7000	2141

3.5 Scenarios, Training, and Operations

Flight tests were conducted using Roanoke Woodrum Field in Roanoke, Virginia (FAA identifier KROA). It was selected due to the presence of significant terrain and obstructions in its vicinity and convenient proximity to NASA Langley Research Center. In particular, Runway 24 was selected since terrain and obstacles pose significant operational challenges for approaches to this runway. Runway 24 was not equipped with visual approach slope indicator lights or a precision approach path indicator.

Three approach scenarios were created. Two were conventional approaches, and one represented an advanced operational concept. The conventional scenarios included a VFR traffic pattern approach in VMC and an ILS approach in simulated IMC. The advanced operational concept was an IMC approach that used the same flight path flown for the conventional VFR traffic pattern approach; however, this “VMC-like” approach was flown in simulated IMC. Figure 8 shows a plan view and side views of the evaluation approaches. The three approaches are described in the following sections.



Figure 8a: VFR Sectional Map View with Approaches Overlaid

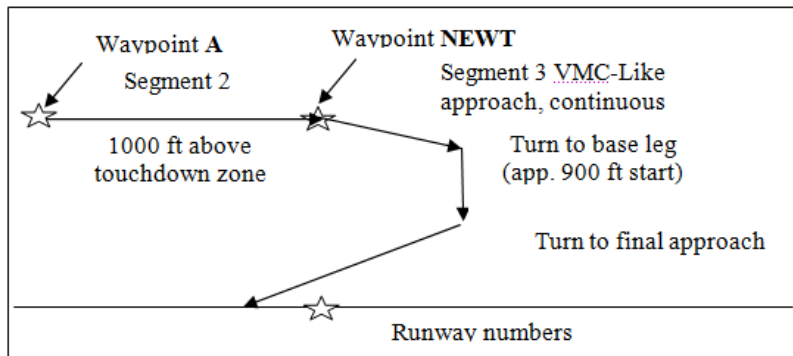

Figure 8b: Sideview of VFR and VMC-like Approaches

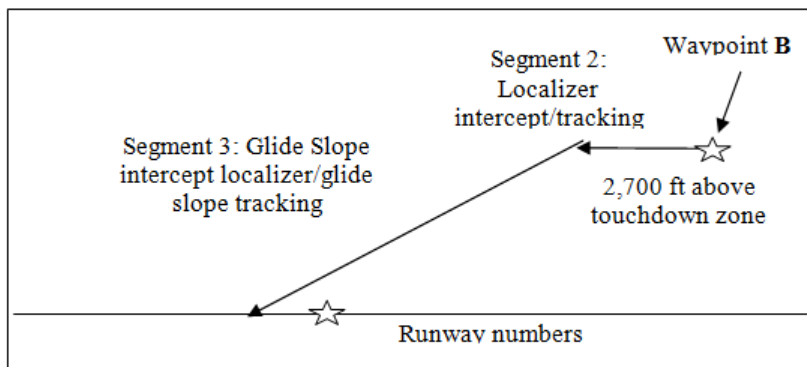

Figure 8c: Sideview of ILS approach

3.5.1 VFR Approach

The VFR traffic pattern incorporated a downwind leg displaced approximately 1.4 nm abeam the runway at 1,000 ft above the touchdown zone, a base leg, and a 1.5 nm final approach segment. Data runs were initiated at 100 kts indicated airspeed (IAS) at 1,000 ft above the touchdown zone on the downwind leg heading at Point A in Figure 8. EPs were instructed to use visual references primarily to navigate through this approach. They were instructed to fly parallel to the runway and maintain airspeed and altitude with flaps retracted. Once abeam the runway numbers, EPs were to select 10 degrees of flaps, reduce speed to 90 kts IAS, establish a 1.5 nm final approach, and complete the approach. EPs were instructed to continue the approach to 50 ft above ground level (AGL), or to actual touchdown, depending on their level of experience and prevailing conditions. The VFR traffic pattern approach was included in this evaluation to provide a comparison to current VMC operations.

3.5.2 ILS Approach

The ILS approach included a 90-degree base leg, a 30-degree localizer intercept, and a 3.0-degree glideslope intercept point approximately nine nm from the runway touchdown markers. This approach was performed with restricted visibility through the use of an IFR training visor, which eliminated out-the-window visibility.

Because an ILS was not available for Runway 24 at KROA, Global Positioning System (GPS) Wide-Area Augmentation System (WAAS) information was used to calculate and display simulated ILS localizer and glideslope data. The altitude above the touchdown zone elevation along with the distance to the touchdown zone generated ILS glideslope-like deviation data. Lateral linear flight path error, combined with the distance along the flight path to a point 1,000 ft beyond the far (departure end) end of Runway 24, was used to generate ILS localizer-like deviation data. Although an ILS localizer is nominally scaled for a course width of (full scale fly-left to a full scale fly-right) of 700 feet at the runway threshold, the maximum simulated localizer deflection was established as +/-250 ft at the runway threshold (+/-2.0 degrees course width). Maximum glideslope deflection was set to +/- 0.7 degrees.

The ILS approach task started at approximately 2,700 ft above the touchdown zone at 100 kts IAS on the base leg heading at Point B in Figure 8. EPs would immediately turn to the intercept heading, once the research approach was started at Point B, and intercept the localizer. Once established on the localizer, EPs were to select 10 degrees of flaps, reduce speed to 90 kts, intercept the glideslope and complete the approach. Pilots were instructed to continue to the decision height (DH) at 200 ft AGL and then call out "DH." At the DH, the safety pilot would say, "Continue to 50 ft AGL," "Continue to landing," or "Runway not in sight," depending on pilot skill and prevailing conditions and whether or not a simulated missed approach (MA) was required as indicated by the test matrix. Calling out the "DH" and potentially initiating a MA was included in the flight test to enhance the realism of the approach and to provide data regarding pilots' ability to identify the "DH" as well as minimize further descent during the MA. (These data were analyzed and no effects were observed and are subsequently not reported.) The test matrix was designed such that approximately half of the IMC approach runs (ILS and VMC-like) included an MA. Each run ended either at touchdown or when positive rate of climb was established on the MA. The ILS approach was included to enable data comparisons with current precision approach operations.

3.5.3 VMC-Like Approach

The VMC-like approach used the same flight path as the VFR approach; however, it was performed with GPS navigation and restricted visibility through the use of an IFR training visor. A waypoint ("NEWT") was created for the VMC-like approach on the downwind approach path (see Figure 8) abeam the runway numbers to designate the point at which the EPs were to select 10 degrees of flaps and

decelerate to 90 kts IAS. Localizer and glideslope errors were generated in the same manner as for the ILS approach. All EPs flew the VMC-like approach with each of the experimental display concepts except the BRD. The VMC-like approach had the same termination options as the ILS approach (i.e., continue to 50 ft, land, or MA). Each run ended either at touchdown or when positive rate of climb was established on the MA. The VMC-like approach represented a potential future operation that could be enabled by SVS displays.

3.5.4 Training

Evaluation pilots received training prior to data collection to minimize learning effects. Training included a one-hour briefing regarding the characteristics of the experiment along with a description of all display concepts, evaluation approaches, and subjective and objective measures. Next, EPs received approximately 2.5 hours of training using a desktop simulator where all test conditions were practiced. Pilots could elect to retry test conditions until they were completely comfortable with all aspects of the experiment. In general, EPs did not elect to retry training runs and were able to demonstrate acceptable performance. Acceptable performance was defined as CDI deflections within 1.75 dots for the ILS approach and controlling the velocity vector to be within approximately 5 degrees combined displacement of the guidance cue for the HITS display concepts (i.e., PBG and SVS). For the SCFD display concept, acceptable performance was approximately 5 degrees displacement between the guidance cue and reference waterline for both pitch and roll. During the portions of the BRD evaluations that did not have ILS data (i.e., VFR and initial segment of the ILS approaches) acceptable altitude performance was +/- 200 ft. Airspeed control within +/-10 kts was acceptable for all training scenarios. In addition, acceptable performance included pilot awareness and comfort with the displays, test conditions, and approaches. Once the training simulation was completed, EPs received approximately 1.2 hours of flight training in the C206 to become familiar with the aircraft, flight-crew protocol, research apparatus and scenarios. A specific set of training scenarios was selected to provide EPs with exposure to both types of advanced guidance symbologies (i.e., SCFD and PBG), baseline round dials, and both research approach flight paths (i.e., the VFR/VMC-like and ILS). Other general airwork was also conducted during the flight. No vision-restriction devices were used for the flight training sessions.

3.5.5 Operations

For all scenarios, EPs were isolated from actual air traffic control (ATC) communication and asked to monitor a simulated ATC channel that would play pre-recorded ATC messages based on aircraft location. They answered questions about simulated air traffic and provided other qualitative data (i.e., situation awareness, workload, display readability, terrain awareness) immediately after each run. (An evaluation of the simulated air traffic responses indicated no usable data to differentiate between approaches, pilot types, or display concepts and is not reported herein. Even though pilots were briefed to expect questions about ATC instructions to other aircraft, that type of mental recall was found to be very different from what pilots are accustomed to and they simply did not recall any ATC instructions for other aircraft.) Isolating the EPs from actual ATC communications provided a more uniform workload. For the simulated-IMC scenarios, the EPs wore an IFR training visor. No vision restriction was used for the VFR approach.

During each approach, the SPs would establish the aircraft approximately 1.0 nm from the starting waypoint (i.e., Waypoint A for the VFR/VMC-like approaches or Waypoint B for the ILS approach in Figure 8) on the appropriate heading, altitude, and speed, at which time control would be transferred to the EP. The EP would then complete the approach setup and perform the evaluation approach. Once the approach was completed, the SP took control of the aircraft and the EP answered the post-run questionnaires using an electronic questionnaire tool implemented on a pocket personal computer (described in Appendix C).

The order of test condition presentation was randomized (subject to some operational efficiencies) to further minimize learning, fatigue, and environmental effects. Generally, data collection was performed during two approximately 1.2-hour flights to avoid fatigue, though a few pilots completed the entire test matrix in one 2-hour flight. EP participation in the flight test usually spanned two days with training occurring on the first day. A substantial effort was made to conduct the formal research evaluations within four hours after sunrise in order to reduce atmospheric variability effects within the resulting data. Most of the data acquired during this flight test fell within this timeframe. All flight operations were conducted in clear day conditions. There were no wind limitations established for the data collection operations.

3.6 Independent Variables

Several independent variables were used for this test. Display concept, approach, and pilot type were explicitly controlled in the test matrix. The test condition (TC) variable was based on combinations of approach, display concept and pilot type. A summary listing of the independent variables of the study is provided in Table 2.

Table 2: Independent Variables Used for This Experiment

#	Name	Levels
1	Display Concept (4 total)	BRD, SCFD, PBG, or SVS
2	Approach (3 total)	VFR, ILS, or VMC-like approaches
3	Pilot Type (3 total)	VFR, IFR, or H-IFR
4	Test Condition (13 total)	VFR approach with BRD VFR approach with SCFD VFR approach with PBG VFR approach with SVS ILS approach with BRD for IFR and H-IFR pilots only ILS approach with SCFD ILS approach with PBG ILS approach with SVS VMC-like approach with SCFD VMC-like approach with PBG VMC-like approach with SVS ILS approach with SVS for VFR pilots only VMC-like approach with SVS

3.7 Test Matrix

The test matrix for approach, display concept, visibility, and pilot type is provided in Table 3. Note that the BRD display concept was not included in the test matrix for the VMC-like approach because of anticipated very poor performance that could involve safety of flight concerns. The poor performance was expected as a result of the piloting strategy required for traditional IMC operations with the BRD display concept. This method uses selected headings to fly, evaluated for tracking performance over at least 10 to 20 seconds before updating to manage lateral error. The relatively rapid pace for the VMC-like approach would have been highly challenging for the BRD display concept, especially for the VFR pilots. In Table 3, “VMC” indicates that no vision restriction device was used to restrict the EP’s

visibility. Similarly, “Sim IMC” indicates that a standard IFR training vision restriction device was used by the EPs.

The VFR and IFR pilots evaluated the BRD display concept for the ILS approach twice while the H-IFR pilots evaluated the BRD display concept for the VFR traffic pattern twice. The repeat evaluations of these test conditions were included to provide more data for a multivariate discriminant analysis technique employed and described in Reference 18. Overall, each EP flew 12 total data-collection runs to complete the run matrix (four VFR traffic patterns, four ILS approaches, three VMC-like approaches, 1 repeat).

Table 3: Test Matrix

Ident #	Approach	Display Concept	Visibility	Pilot Type
1	VFR	BRD	VMC	VFR Pilots
2	VFR	SCFD	VMC	
3	VFR	PBG	VMC	
4	VFR	SVS	VMC	
5	ILS	BRD	Sim IMC	
6	ILS	SCFD	Sim IMC	
7	ILS	PBG	Sim IMC	
8	ILS	SVS	Sim IMC	
9	VMC-Like	SCFD	Sim IMC	
10	VMC-Like	PBG	Sim IMC	
11	VMC-Like	SVS	Sim IMC	
12	VFR	BRD	VMC	IFR Pilots
13	VFR	SCFD	VMC	
14	VFR	PBG	VMC	
15	VFR	SVS	VMC	
16	ILS	BRD	Sim IMC	
17	ILS	SCFD	Sim IMC	
18	ILS	PBG	Sim IMC	
19	ILS	SVS	Sim IMC	
20	VMC-Like	SCFD	Sim IMC	
21	VMC-Like	PBG	Sim IMC	
22	VMC-Like	SVS	Sim IMC	
23	VFR	BRD	VMC	H-IFR Pilots
24	VFR	SCFD	VMC	
25	VFR	PBG	VMC	
26	VFR	SVS	VMC	
27	ILS	BRD	Sim IMC	
28	ILS	SCFD	Sim IMC	
29	ILS	PBG	Sim IMC	
30	ILS	SVS	Sim IMC	
31	VMC-Like	SCFD	Sim IMC	
32	VMC-Like	PBG	Sim IMC	
33	VMC-Like	SVS	Sim IMC	

The TC variable was composed of combinations of specific approaches, display concepts, and pilot types, as defined in Table 4. The purpose of the TC variable was to provide explicit comparisons across

approaches and provide key reference conditions in the data. One reference condition, TC 5, was defined by the IFR and H-IFR pilots flying the ILS approach with the BRD display concept. This condition represents the current standard for operations in IMC. As such, the VFR pilots' data are not included in TC 5. In addition, to draw conclusions regarding the ability of the VFR pilots to pilot an aircraft with SVS displays in IMC, TC 12 and TC 13 were created for the ILS and VMC-like approaches, respectively. Note that the data for the VFR pilots' evaluations of the SVS display concept for the ILS and VMC-like approaches are also included in TCs 8 and 11.

Table 4: Definition of Test Condition Variable.

Test Condition	Approach	Display Concept	Visibility	Pilot Types
1	VFR	BRD	VMC	VFR, IFR, H-IFR
2	VFR	SCFD	VMC	VFR, IFR, H-IFR
3	VFR	PBG	VMC	VFR, IFR, H-IFR
4	VFR	SVS	VMC	VFR, IFR, H-IFR
5	ILS	BRD	Sim IMC	IFR, H-IFR
6	ILS	SCFD	Sim IMC	VFR, IFR, H-IFR
7	ILS	PBG	Sim IMC	VFR, IFR, H-IFR
8	ILS	SVS	Sim IMC	VFR, IFR, H-IFR
9	VMC-Like	SCFD	Sim IMC	VFR, IFR, H-IFR
10	VMC-Like	PBG	Sim IMC	VFR, IFR, H-IFR
11	VMC-Like	SVS	Sim IMC	VFR, IFR, H-IFR
12	ILS	SVS	Sim IMC	VFR
13	VMC-Like	SVS	Sim IMC	VFR

3.8 Dependent Measures

Quantitative and qualitative dependent measures were collected in this study. These measures are explained below.

3.8.1 Qualitative Measures

Post-run questionnaire results analyzed in this report consisted of the 3-dimensional Situation Awareness Rating Technique (SART, see Reference 19), 6-dimensional Task Load Index (TLX, see Reference 20), Display Readability Rating (DRR, see Reference 21) and Terrain Awareness (TA) question. All of the post-run questionnaires are included in Appendix C. The SART questionnaire was applied to measure the EP's perceived ability to understand the current situation (i.e., situation awareness). All references to SA herein are from SART results.

The SART results are calculated by adding the results from the responses of the perceived supply of attentional resources and understanding of the situation questions and then subtracting the response from the demand on attentional resources question. However, an unconventional implementation of SART was employed using a 0 to 100 scale rather than the nominal 7-pt Likert scale. In this implementation, the three SART components (supply, understanding, and demand) were rated 0 to 100 by each pilot with 100 representing "high" and a score of 0 representing "low." As such, the SART scores can vary from a

maximum of 200 to -100. A SART score of 200 would indicate that a pilot had the maximum perceived supply of attentional resources and understanding of the situation while also experiencing virtually no demand on attentional resources. A SART score of -100 would indicate the pilot had a maximum perceived demand on attentional resources and the least possible supply of attentional resources and understanding of the situation.

Pilot subjective workload was assessed through use of the TLX scale. Pair-comparisons of the TLX factors were not administered to the EPs to obtain an individualized workload metric; instead, the TLX results were calculated by determining the average response to the six questions: 1) Mental demand; 2) Physical demand; 3) Temporal demand; 4) Performance; 5) Effort; 6) Frustration level. See Appendix C for details. TLX results can vary from a maximum of 100, that would indicate the highest (worst) results for all 6 questions, to a minimum of zero (best), which would result from the lowest response for all 6 questions.

The DRR scale was applied to assess the workload associated with obtaining information from the various research displays. Pilots were provided a definition of desired and adequate performance for the DRR scale and self-rated their own performance. Ratings are generated through the use of a decision tree. It requires the EPs to answer yes or no to series of questions that ultimately create a phrase association that best describes the pilot's perception of a specific condition in the test matrix. The DRR ratings begin from a maximum (worst) of 10 which would indicate that "mandatory improvements to the display are required" combined with the statement that "the display symbology cannot be used for the required task". The best rating, a DRR rating of 1, would indicate that the display was "satisfactory without improvement" combined with the statement that "pilot compensation was not a factor for desired performance". The DRR is a slightly different form of pilot workload measure than TLX, and attempts to assess the amount of mental workload expended to absorb flight information from the display device to meet desired and/or adequate performance. In this sense, "absorb" means to comprehend the information being supplied and transform that information into useable situation awareness and cognitive processing.

A specific question regarding terrain awareness was also included to acquire data specific to this element of SA. The TA results was based on the EP's overall understanding of the terrain environment they were operating within. Terrain Awareness results could vary from a maximum (best) of 100, that would indicate that the EP had the best perceived understanding of the terrain environment, down to a minimum of zero (worst) that would indicate the least possible terrain awareness.

3.8.2 Quantitative Measures

Quantitative data recorded included flight path and airspeed errors. Parameters included: linear flight path errors (lateral and vertical in ft), angular flight path errors (localizer and glideslope in dots of deflection), and indicated airspeed errors (in knots). Quantitative error parameters are discussed for combined Segments 2 and 3 as well as Segment 3 alone (see Figure 8 for definitions of Segments 2 and 3). Indicated airspeed errors are discussed separately for Segments 2 and 3 due to data analysis limitations. Root-mean-square (RMS) values of these error variables are included in the analyses performed and reported herein.

Linear lateral and vertical flight path and track-angle errors were calculated using a technique that determined the shortest lateral distance from the aircraft to the flight path centerline. The intersection of this line with the desired flight path was then used to establish reference conditions to generate error parameters. The linear errors were combined with range to the runway touchdown point to calculate glideslope errors, and the range to a point 1,000 ft beyond the far (departure end) end of Runway 24 for localizer errors. Proceeding in this manner enabled localizer and glideslope errors to be calculated, displayed, and analyzed the ILS approach and calculated and analyzed for the VFR and VMC-like approaches. Note that the localizer and glideslope error was only displayed for the ILS approach.

For the simulated-IMC approaches (i.e., ILS and VMC-like) the FAA IFR Practical Test Standards (PTS) were applied. To earn an instrument rating, pilots must demonstrate the ability to maintain flight path and airspeed errors within criteria outlined in the PTS. The accepted and desired IMC performance conditions were based on the FAA PTS criteria defined in Reference 22. The resulting “IFR PTS boundary” used for both the ILS and the VMC-like approaches began at a specified entry gate and ended at the DH. It was bounded by $\frac{3}{4}$ -scale maximum deflections (1.5 dots) of localizer and glideslope indicators, and +/-10 kts of IAS error. Note that the instantaneous required airspeed change during the glideslope intercept from 100 +/-10 kts to 90 kts to +/-10 kts resulted in a potential limitation of the maximum amount of time pilots’ could achieve PTS performance. If a pilot was within the PTS IAS limit during the localizer tracking segment, but with an IAS above 100 kts, then at the point of glideslope intercept he would no longer be within the PTS criteria until he reduced IAS to be below 100 kts. It is considered that this momentary IAS exceedance would be acceptable performance during an IFR checkride. However, for the analysis performed herein the amount of time required to bring IAS back to within +/-10 kts error detracts from the time within PTS criteria. This artifact would also apply to the VMC-Like approaches since a speed change is required for that maneuver too. While exceeding the IFR PTS does not directly imply an imminent accident, boundary violation does provide an indication of an unstable approach and an increased accident risk or exposure. PTS results for all three approaches are discussed as the percentage of time the evaluation pilots were able to satisfy all three parameters simultaneously.

Linear lateral flight path error analysis for the various display concepts and approaches was valuable in support of RNP-style approaches that are currently being developed and used within the NAS. For RNP operations, the aircraft, avionics, and crew must be certified by the FAA to be capable of remaining within linear lateral limits of the centerline of the desired flight path 95% of the time. The required total system performance can be achieved by various combinations of flight management systems, navigation sensors, flight guidance systems, cockpit displays and other equipment, together with monitoring and alerting capabilities and additional training, which distinguishes performance-based navigation from other navigation methods. RNP aircraft certification typically specifies an accuracy level, such as 0.10 nm or 0.30 nm, at which the aircraft can navigate (Reference 23). This is the combination of airframe and autoflight system for coupled operations. For manual operations, the crew is allocated part of the total system error budget. This is different compared to angularly-defined airspace limits consistent with most of the traditional IMC approach operations. For this report, a flight technical error criterion of 0.1 nm is used as a reference to compare and contrast results from the different display concepts, approaches, and pilot types for manually flown approaches. The results discussed herein only deal with the ability of the pilot to interact with the display concepts and minimize flight path error (i.e., only accounting for what is known as flight technical error) and does not account for errors within the navigational system (e.g., GPS). Dynamic taxi testing along the runway centerline at KROA showed that the installed Air Data, Attitude, and Heading Reference System (ADAHRS) equipment performance exhibited errors on the order of 10 to 20 ft (i.e., 0.0016 to 0.0033 nm). These errors were considered negligible for the in-flight results discussed herein

For the ILS Approach, Segment 3 extended from the glideslope intercept point at 8.4 nm and ended at the decision height (i.e., 200 ft AGL, approximately 0.66 nm from the glideslope intercept point). For the advanced display concepts, guidance was provided throughout the entire ILS approach. However, for the BRD display concept, evaluation pilots flew a specified heading and altitude until intercepting the localizer from the start point, then flew a specified altitude while tracking the localizer to intercept the glideslope. The ILS approach was completed with the EPs following the localizer and glideslope signals to decision height. While all ILS evaluations were initiated from the same location, the guidance for the BRD display concept was not consistent for the entire approach and did not have positive lateral and vertical guidance throughout the localizer intercept and localizer tracking phases of the approach (Segment 2). To compensate for the inconsistent guidance of the BRD display concept, comparisons of

the flight path error data from the BRD display concept were limited to the localizer and glideslope tracking phases of the ILS approach (Segment 3).

If, during a run, the localizer and glideslope indicators were simultaneously at their upper limits and the path error was increasing, the EP was deemed to have lost all flight path awareness and the TE would terminate the run. The SP was prepared to take control immediately in any situation involving safety-of-flight concerns; however, no runs were aborted by the SP due to safety-of-flight issues during the test.

4.0 Data Analyses and Results

Results are presented in this section for subjective situation awareness, workload, display readability, and terrain awareness. Quantitative results include percent of time within the PTS, localizer errors, glideslope errors, indicated airspeed errors, lateral path errors, and vertical path errors. The advanced display concepts provide guidance to minimize linear flight path errors. In order to best compare pilot performance when using the advanced display concepts linear path errors analyses are used. Linear pathway error analyses also provides the ability to assess performance compared to RNP criteria that could be associated with future advanced landing approaches. However, linear path error analyses adversely penalize displays that minimize angular pathway errors, such as the BRD with the localizer and glideslope errors. For this report both linear and angular pathway errors are employed. PTS criteria are employed for the localizer, glideslope and IAS error analyses. Required Navigation Performance criteria of +/-0.1 nm and +/-100 ft are used for the linear lateral and vertical error analyses, respectively.

For all parameters, analyses are performed separately for each approach (i.e., VFR, ILS, and VMC-like approaches) using all of the pilot group's data. This enables a clear view of the display concepts and pilot types without considering operational task (i.e., approach types) effects. Then, in an effort to describe the results within a framework aligned with current operations, the VFR pilots' data are removed from the ILS approach. To provide increased statistical power to identify effects of display concept, approach, and pilot type, data for the IMC approaches (i.e., ILS and VMC-like approaches) are analyzed together. To provide a direct comparison of the advanced display concepts and approaches with current IMC and VMC operations, the test condition analyses are provided. Recall that the test condition independent variable is a combination of approach and display concept (i.e., VFR approach + BRD, etc.).

During the course of the flight test experiment, one run had to be terminated due to the pilot losing complete awareness of the desired flight path. The test condition for this run was for a VFR pilot flying the ILS approach with the BRD display concept. For this ILS approach run, the pilot was able to maneuver near the desired flight path for several minutes and make some progress through the localizer intercept and localizer tracking phase of the approach. When the added workload of intercepting and tracking the glideslope was added, the pilot was apparently overloaded and never began the descent. The run was terminated at that time. The pilot had difficulties from the beginning of the approach with consistently poor performance up to the point of termination at approximately 2.5 nm from touchdown. The results were consistent throughout this ILS approach attempt and were included in the data.

Analyses of variance (ANOVAs) were conducted using the SPSS™ software package to test for statistical significance among the independent variables for the different measures. Results due to the independent variables are referred to as main effects and are differentiated from those resulting from interactions between the independent variables. In cases where the statistical significance factor (p) was less than 0.05, the independent variable differences were considered to be significant for the measure being evaluated. For cases where "p" was less than 0.01, differences were considered to be highly significant. Student-Newman-Keuls (SNK) post-hoc analysis results were used when "p" was less than 0.05 and there were more than 2 items being compared. SNK analysis provides subsets of the results based on their statistical relationship to each other. Results in the same subset are considered to not be statistically different from others in that subset. Those in different subsets are considered to be

statistically different. For the ordinal DRR data, a descriptive analysis of the medians, maximums, minimums, and percentiles was performed.

4.1 Situation Awareness

SART results for the four display concepts and three approaches are presented in Figure 9 along with Table 5. Individual SART results for each evaluation are provided in Appendix D.

Table 5: SART Descriptive Statistics (all Pilots)

Display Concept	Approach	Mean	Standard Deviation	Number of Data Points
BRD	VFR	104	54.3	24
	ILS	32.6	49.9	29
	Total	67.5	60.1	53
SCFD	VFR	78.2	54.1	19
	ILS	75.8	33.9	18
	VMC-Like	62.4	55.0	18
	Total	72.3	48.4	55
PBG	VFR	115	45.6	18
	ILS	83.1	46.6	17
	VMC-Like	87.6	46.5	19
	Total	95.3	47.5	54
SVS	VFR	113	48.5	19
	ILS	114	53.6	21
	VMC-Like	108	44.8	19
	Total	112	48.5	59
Total	VFR	101	52.0	75
	ILS	78.5	54.0	74
	VMC-Like	86.6	51.5	56
	Total	88.8	53.2	205

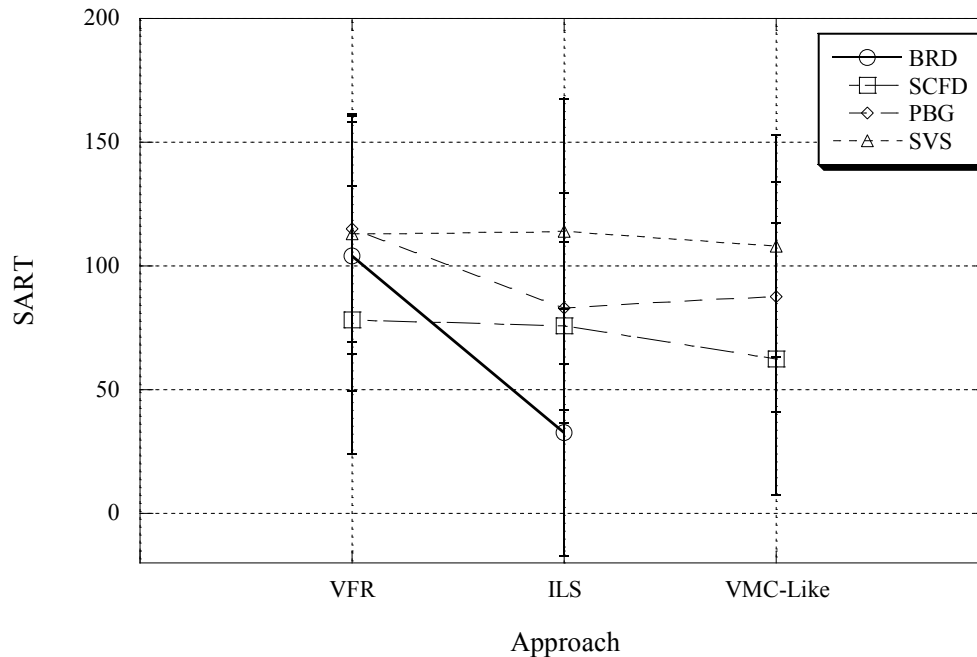

Figure 9: SART Results, All Display Concepts, All Pilots and All Approaches

4.1.1 VFR approach

For the VFR approaches, EPs were instructed to navigate the aircraft using outside visual cues and to cross check with the guidance when it was provided by the advanced displays. An ANOVA conducted on the SART data for this approach for the main effects of display concept and pilot type resulted in no significant ($p > 0.05$) results. VFR evaluations of the PBG and SVS display concepts showed trends toward increased SA, though not significant, compared to the BRD results. The pilots' favorable SA ratings were most likely due to the presence of the HITS symbology, even though they were primarily performing a VFR task. Evaluation pilots were able to cross check their VFR-style navigation with the HITS information and easily confirm their position. In the case of the SCFD display concept, the evaluation pilots were unable to easily confirm their relative position with respect to the desired path since flight director commands are a function of both track-angle and lateral offset errors. As a result, a given roll command did not provide intuitive direct indication of how far pilots were away from the desired flight path, leading to poorer ratings for the SCFD for the VFR approach compared to the other display concepts, including the BRD.

4.1.2 ILS approach, all pilots

An ANOVA conducted on the SART results for the main effects of pilot type and display concept for the ILS approach revealed that display concept ($F(3,85)=22.4$, $p < 0.01$) was highly significant but was not significant for pilot type ($p > 0.05$). There were no significant interactions between the main effects. A Student-Newman-Keuls (SNK) post-hoc analysis on the SART ratings resulted in the three unique subsets shown below in Table 6. The BRD display concept was rated as providing the least SA of the four display concepts tested. The middle subset was comprised of the SCFD and the PBG display concepts. The SCFD and PBG display concepts were rated as providing improved SA compared to the BRD display concept but there were no significant differences between these two display concepts. The

significant increase in SA for the SCFD and PBG display concepts compared to the baseline round-dial concept is most likely due to the presence of the moving map ND and/or integrated PFD compared to the separate gauges of the baseline round-dial display concept. The SVS display concept was rated as providing the highest SA among the concepts tested. The significant difference in SA between the SVS and the PBG display concepts can be attributed to the addition of SVS terrain since this was the only difference between these two concepts.

Situation Awareness results for the SVS concept used to fly the ILS approach were higher than those for the BRD display concept for the ILS approach. This result may reflect the intuitive integration of the outside environment, as provided by SVS terrain, with the desired flight path and aircraft state data.

Table 7 provides SART results for the three pilot groups for the ILS approach for each of the display concepts along with the mean for all display concepts. These data are presented to show that SA from the three pilots groups had some variability, although it was not significant. Overall, the H-IFR pilot group reported higher SA than the other two pilot groups, which may be attributed to the H-IFR pilots' order-of-magnitude higher amount of flying time, as presented in Table 1. IFR pilots, however, reported lower SA than the VFR pilots for three of the four display concepts evaluated, even though they had received the training required to acquire an IFR rating. An analysis of the constituent elements of SART for all display concepts for the ILS approach revealed that the VFR pilots reported significantly higher results ($F(2,85)=4.3, p=0.02$) for the 3rd SA question (understanding of the situation) for the BRD display concept than the IFR pilots and were included in the subset with the H-IFR pilots. There were no other significant differences for the other SART questions for all the other display concepts (i.e., $p>0.05$). While the VFR pilots had not acquired the training to become IFR pilots, for all of the display concepts they reported SA results that were an average of 10 SA units higher than the IFR pilots as a group (but not statistically significant). All pilot groups exhibited similar trends in their SART results for the different display concepts with the BRD being the worst and SVS display the best and the SCFD and PBG display concepts in between. The bias in the VFR pilots' SART results needs to be considered when drawing conclusions that compare pilot groups. An example of comparisons across pilot groups is provided during the test condition analysis shown in this report.

Table 6: Mean SART SNK Results for all Pilots, ILS Approach

Display Concept	Number of Data Points	Subset		
		1	2	3
BRD	29	32.6		
SCFD	18		75.8	
PBG	17		83.1	
SVS	21			113.5
Significance		1.0	0.5	1.0

Table 7: Mean SART SNK Results for All Pilots for All Display Concepts, ILS Approach

EP-type	Number of data points	SART	SART BRD	SART SCFD	SART PBG	SART SVS
IFR	30	58.7	14.1	69.8	76.4	100.5
VFR	29	69.2	32.3	66.0	95.0	114.2
H-IFR	26	90.1	62.3	91.7	76.8	127.9
Significance		0.26				

4.1.3 VMC-Like approach

An analysis of the VMC-like approach data was performed to determine the effect of display concept and pilot type for this advanced IMC approach. An ANOVA revealed that display concept was highly significant ($F(2,56)=5.5$, $p<0.01$) for SART ratings but pilot type was not significant ($p>0.05$). There were no significant interactions between display concept and pilot type. An SNK post-hoc analysis on SA resulted in two overlapping subsets as shown in Table 8. The SVS display provided significantly more SA than the SCFD but there were no differences between the PBG and SVS displays. The SA improvements with the SVS display concept over the SCFD were most likely due to the combination of HITS guidance symbology and presence of SVS terrain.

Table 8: Mean SART SNK Results for All Pilots for All Display Concepts, VMC-Like Approach

Display Concept	Number of Data Points	Subset	
		1	2
SCFD	18	62.4	
PBG	19	87.6	87.6
SVS	19		108.4
Significance		0.08	0.15

4.1.4 ILS approach, without VFR pilot data

An analysis of the ILS approach data without the low-time VFR pilots' data was performed to create a baseline reflecting current operations. An ANOVA conducted on SA for the IFR and H-IFR pilot data revealed that the main effect on SA was statistically significant ($F(1,56)=6.247$, $p<0.017$) for pilot type and highly significant ($F(3,56)=12.475$, $p<0.01$) for display concept. There were no significant interactions between pilot type and display concept. The IFR-rated pilots reported significantly lower SA than the high-time pilots for all display concepts as shown in Table 9. This result may reflect the total number of flight hours for the high-time pilots, their overall level of skill with the BRD display concept, and also their ability to adapt to the advanced display concepts, resulting in greater overall situation awareness. An SNK post-hoc analysis on the SA revealed three unique subsets for display concept as shown below in Table 10. The BRD display concept provided the pilots with significantly lower SA than all other concepts tested as indicated in Figure 9. The SCFD and PBG display concepts were rated as providing significantly better SA than the BRD display concept, but there were no significant differences among the SCFD and PBG display concepts. The SVS concept provided the pilots with significantly higher SA than all other concepts tested, and this result was most likely due to the presence of the SVS terrain.

Table 9: Mean SART results for IFR and H-IFR Pilots for the ILS Approach

Pilot Type	Number of Data Points	Mean
IFR	30	63.7
H-IFR	26	90.9

Table 10: Mean SART SNK Results for Display Concept for IFR and H-IFR Pilots for the ILS Approach

Display Concept	Number of Data Points	Subset		
		1	2	3
BRD	18	32.8		
PBG	11		76.6	
SCFD	12		80.8	
SVS	15			113.3
Significance		1.000	0.77	1.000

4.1.5 ILS and VMC-Like approach analysis, all pilots, advanced displays

For the VMC-like approach, no data were acquired for the BRD display concept, as discussed previously. An ANOVA was conducted on the main factors of advanced display concepts (PBG, SCFD, SVS) and approach (ILS, VMC-like) for the SART ratings. Results indicate that display concept was highly significant ($F(2,112)=10.851, p<0.01$) and approach was not significant ($p>0.05$). Post-hoc analysis, shown in Table 11, revealed two unique subsets for the SA results. As shown in Figure 9, the SVS display provided significantly better SA than the PBG display due to the addition of terrain on the SVS display. Recall that the only difference between the SVS and PBG display concepts was the SVS terrain. There were no significant SA differences between the PBG and SCFD concepts.

Overall, the effect of ILS or VMC-like approach was fairly small for the PBG and SVS display concepts as compared to the SCFD display concept as shown in Figure 9. For the VMC-like approach, SART results for the SCFD, PBG, and SVS display concepts were as good or better than those for the BRD display concept for the ILS approach without the VFR pilots' data. In addition, SA results for the SVS display concept as shown in Figure 9 were similar for all evaluations (i.e., VFR, ILS and VMC-like).

Table 11: Mean SART SNK Results for Advanced Display Concepts for All Pilots for ILS and VMC-Like Approach

Display Concept	Number of Data Points	Subset	
		1	2
SCFD	36	69.1	
PBG	36	85.5	
SVS	40		111.1
Significance		0.086	1.000

4.1.6 Test condition analysis

A subsequent analysis of the SART data was performed based on test condition (TC), with post-hoc results presented in Table 12. An ANOVA performed on the SART data indicated that TC was highly significant ($F(12,221)=5.585, p<0.01$). In Table 12, three subsets were identified. TC 5, the ILS approach flown with the BRD concept, was rated as providing significantly less SA than the VFR evaluations of all display concepts. The SVS concepts (regardless of which approach was flown) were rated as providing the highest SA and were not found to be statistically different from TC 1 (i.e., VFR evaluation of the BRD display concept). The VMC-like evaluation of the SCFD display concept (TC 9)

was rated as providing significantly less SA for the VMC-like approach than the VFR evaluations of the other display concepts.

Table 12: Mean SART SNK Results for Test Condition

Test Condition Name	Test Condition	Number of Data Points	Subset		
			1	2	3
ILS Approach + BRD (no VFR pilots)	5	18	32.8		
VMC-like Approach + SCFD	9	18	62.4	62.4	
ILS Approach + SCFD	6	18		75.8	75.8
VFR Approach + SCFD	2	19		78.2	78.2
ILS Approach + PBG	7	17		83.1	83.1
VMC-like Approach + PBG	10	19		87.6	87.6
VFR Approach + BRD	1	24		104.0	104.0
VMC-like Approach + SVS	11	19		108.4	108.4
VFR Approach + SVS	4	19			112.6
ILS Approach + SVS	8	21			113.5
ILS Approach + SVS (only VFR pilots)	12	6			114.2
VFR Approach + PBG	3	18			114.9
VMC-like Approach + SVS (only VFR pilots)	13	6			115.5
Significance			0.064	0.065	0.315

4.2 Subjective Workload

Subjective workload results for the four display concepts and three approaches for all pilots are presented in Figure 10 and Table 13 and were generated through use of the TLX questionnaire and calculation process described in Appendix C. (Error bars in Figure 10 represent one Standard Deviation (SD).) Individual TLX results for each evaluation are provided in Appendix D.

Table 13: TLX Descriptive Statistics (all Pilots)

Display Concept	Approach	Mean	Standard Deviation	Number of Data Points
BRD	VFR	27.2	14.1	24
	ILS	46.2	20.4	29
	Total	36.1	19.1	53
SCFD	VFR	36.4	16.1	19
	ILS	36.1	17.1	18
	VMC-Like	39.3	19.4	18
	Total	37.3	17.3	55
PBG	VFR	27.3	12.4	18
	ILS	28.9	16.0	17
	VMC-Like	34.8	15.9	19
	Total	30.5	14.9	54
SVS	VFR	27.8	14.8	19
	ILS	25.4	15.7	21
	VMC-Like	29.7	14.4	19
	Total	27.6	14.9	59
Total	VFR	29.7	14.9	75
	ILS	33.8	18.3	74
	VMC-Like	34.5	16.8	56
	Total	33.1	17.3	221

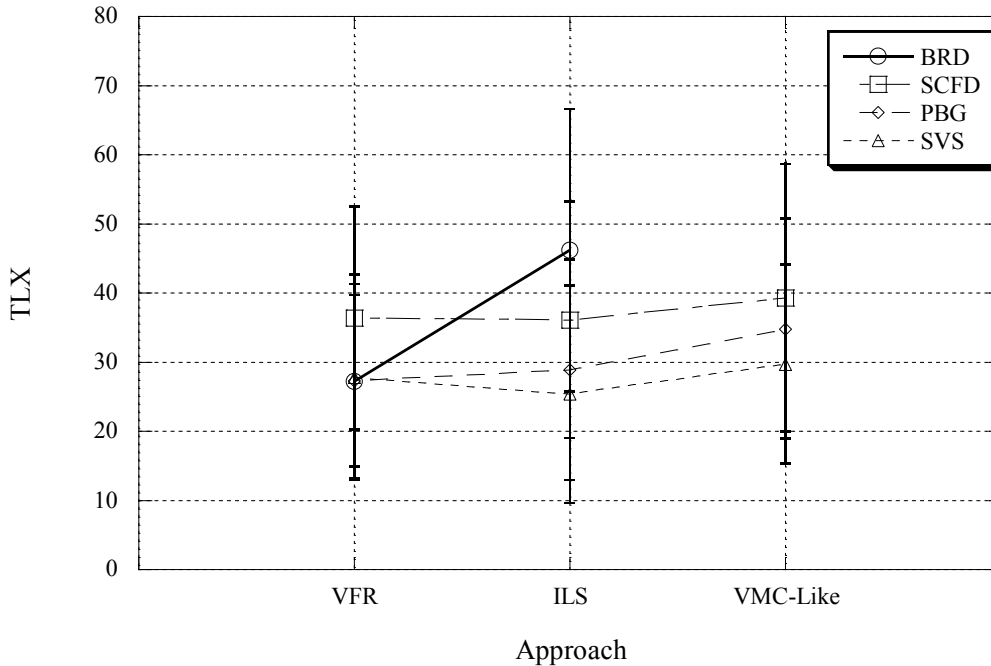

Figure 10: TLX Results, All Display Concepts, All Pilots, and All Approaches

4.2.1 VFR approach

Results for all of the display concepts indicated low workload for the VFR approach. This result was expected since the VFR approach was conducted without the vision restriction device in clear day VMC. An ANOVA conducted on the TLX results for the VFR approach for the main effects of display concept and pilot type resulted in no significant ($p>0.05$) results.

4.2.2 ILS approach, all pilots

An ANOVA conducted on the TLX results for all pilots and display concepts for the ILS approach revealed that the main effect was highly significant for display concept ($F(3,85)=18.3, p<0.01$) but not for pilot type ($p>0.05$). A SNK post-hoc analysis on the TLX data resulted in the three unique subsets for display concept shown below in Table 14. For the ILS approach for all pilots, workload was significantly decreased by 10 units for the SCFD display concept compared to the BRD display concept most likely reflecting the improvements due to the moving map and the integrated single-cue flight director on the PFD display. Workload was also significantly reduced by 7.2 units for the PBG display concept compared to the SCFD display concept reflecting the intuitive guidance provided by the HITS and flight path guidance symbology. Incorporation of the terrain on the SVS display concept provided a small 3.5 unit decrease in workload as compared to the PBG display concept.

Table 14: Mean TLX SNK Results for Display Concept for all Pilots and Display Concepts, ILS Approach

Display concept	Number of Data Points	Subset		
		1	2	3
SVS	21	25.4		
PBG	17	28.9		
SCFD	18		36.1	
BRD	29			46.2
Significance		0.302	1.000	1.000

4.2.3 VMC-Like approach

An analysis of the VMC-like approach data was performed to determine the effect of display concept and pilot type for this advanced IMC approach. An ANOVA conducted on the TLX results for all pilots and display concepts revealed that the main effect was highly significant for display concept ($F(2,56)=5.5, p<0.01$) and also for pilot type ($F(2,56)=8.5, p<0.01$). There were no significant interactions between the main effects. An SNK post-hoc analysis on the TLX results revealed two overlapping subsets for display concept and two unique subsets for pilot type, as shown in Tables 15 and 16. While the PBG guidance symbology decreased workload by approximately 4.5 units compared to the SCFD for this approach, this improvement was not statistically significant. The effect of SVS terrain also decreased workload compared to the PBG display concept by a similar amount. The decreased workload for the SVS display, due to the combination of HITS guidance symbology and SVS terrain, created a significant 9.4 unit reduction compared to the SCFD display concept. This can be seen in Table 15, which shows that the SVS display concept was in the lower (best) workload subset while the SCFD display concept was in the higher (worst) subset. The PBG display concept was similar to both and included in each subset. It is believed that the higher demand of the VMC-like approach contributed to the significant results for pilot type as compared to the ILS approach. Overall, the VFR pilots provided significantly lower TLX results than the IFR and H-IFR pilots. It is speculated that the VFR pilots perceived the workload of the VMC-like approach flown with the advanced display concepts to be closer to the VFR approach, which is the only approach they are accustomed to flying.

Table 15: Mean TLX SNK Results for the advanced Display Concepts for the VMC-Like Approach

Display Concept	Number of Data Points	Subset	
		1	2
SVS	19	29.7	
PBG	19	34.8	34.8
SCFD	18		39.3
Significance		0.075	0.112

Table 16: Mean TLX SNK Results for Pilot type for the VMC-Like Approach

Pilot Type	Number of Data Points	Subset	
		1	2
VFR	18	28.1	
H-IFR	20		35.8
IFR	18		39.5
Significance		1.000	0.192

4.2.4 ILS approach without VFR pilot data

Results from an ANOVA conducted on the TLX data without the VFR pilot data indicated that pilot type ($F(1,56)=5.0$, $p=0.032$) was significant and display concept ($F(3,56)=6.19$, $p<0.01$) was highly significant for TLX results for this analysis. The IFR pilots reported significantly higher workload (7 unit increase) than the H-IFR pilots. This result reflects the total flight hours for the high-time pilots, their overall level of skill with the BRD display concept, and possibly their ability to adapt to the advanced display concepts, resulting in lower overall subjective workload. An SNK post-hoc analysis on the TLX data for display concept resulted in the two overlapping subsets shown in Table 17. The BRD display concept was rated as providing significantly higher workload than the SVS and PBG concepts, but it was not significantly different from the SCFD concept. The SCFD was rated as having no significant workload differences from any of the other display concepts. Pilots appear to more easily follow the HITS pathway guidance. While not significant, the addition of the SVS terrain lowered subjective workload four units compared to the PBG display concept while also significantly improving SA as noted above.

Table 17: Mean TLX SNK Results for Display Concept for IFR and H-IFR Pilots for all Display Concepts for the ILS approach

Display Concept	Number of Data Points	Subset	
		1	2
SVS	15	27.6	
PBG	11	31.6	
SCFD	12	36.4	36.4
BRD	18		44.8
Significance		0.15	0.073

4.2.5 ILS and VMC-Like approach analysis, all pilots, advanced displays

For the VMC-like approach, no data were acquired for the BRD display concept as discussed previously. An ANOVA was conducted on the data for the three advanced display concepts for the ILS and VMC-like approach for all pilot types. Results indicated that display concept was highly significant ($F(2,112)=8.558$, $p<0.01$) and approach was significant ($F(1,112)=5.544$, $p=0.021$) for the workload ratings. The effect of display concept and approach are shown in Figure 10, where the SVS display provides the lowest workload for both approaches and the workload for the VMC-like approach increases for all of the advanced display concepts. Results from the SNK post-hoc analysis are presented in Table 18. Both the PBG and SVS display concepts significantly reduced workload compared to the SCFD display concept, most likely due to the HITS pathway guidance. The workload for the SVS display concept was reduced by 4.5 units compared to the PBG display concept. The VMC-like approach

increased workload compared to the ILS approach for all advanced displays by 3.2, 5.9, and 4.3 units for the SCFD, PBG, and SVS displays, respectively, as shown in Table 13 and Figure 10.

Table 18: Mean SNK TLX Results for Display Concept for all Pilots for the ILS and VMC-Like Approach (Advanced Display Concepts)

Display Concept	Number of Data Points	Subset	
		1	2
SVS	40	27.5	
PBG	36	32.0	
SCFD	36		37.7
Significance		0.068	1.000

4.2.6 Test condition analysis

An analysis was performed based on TC with post-hoc results presented in Table 19. Test Condition was highly significant for TLX results ($F(12,221)=4.172, p<0.01$). Four overlapping subsets were formed from post-hoc TC analysis. The VFR evaluations of BRD, PBG, and SVS display concepts, the ILS evaluations of the PBG and SVS display concepts and the VMC-like evaluation of the SVS display concept were rated as providing the lowest workload and contained in subset 1. The ILS approach with the BRD display concept (TC 5) was rated as requiring the highest workload. Test Condition 5 grouped with the VMC-Like approach evaluations of the PBG and SCFD display concepts, the ILS approach evaluation of the SCFD display concept, and the VFR approach evaluation of the SCFD display concept. Workload ratings for all of the TCs in the highest workload subset were significantly higher than those in the lowest workload subset. These results indicate that for the ILS approach the SVS and PBG display concepts (but not the SCFD concept) offer significantly reduced workload compared to the BRD display concept. Only the SVS display concept provides significantly reduced workload for the VMC-like approach compared to the BRD display concept for the ILS approach (TC 5). For the ILS approach, the SVS display concept provides workload as low or lower than for the VFR approach with the BRD display concept (TC 1). The advanced display concepts may potentially enable advanced IMC operations, such as the VMC-like approach, since their workload results were less than the ILS approach with BRD display concept (TC 5).

Table 19: Mean TLX SNK Results for Test Condition

Test Condition Name	TC #	Number of Data Points	Subset			
			1	2	3	4
ILS Approach + SVS (only VFR pilots)	12	6	19.8			
VMC-Like Approach + SVS (only VFR pilots)	13	6	23.7	23.7		
ILS Approach + SVS	8	21	25.4	25.4		
VFR Approach + BRD	1	24	27.2	27.2	27.2	
VFR Approach + PBG	3	18	27.3	27.3	27.3	
VFR Approach + SVS	4	19	27.8	27.8	27.8	
ILS Approach + PBG	7	17	28.9	28.9	28.9	
VMC-Like Approach + SVS	11	19	29.7	29.7	29.7	
VMC-Like Approach + PBG	10	19		34.8	34.8	34.8
ILS Approach + SCFD	6	18		36.1	36.1	36.1
VFR Approach + SCFD	2	19		36.4	36.4	36.4
VMC-Like Approach + SCFD	9	18			39.3	39.3
ILS Approach + BRD (no VFR pilots)	5	18				44.8
Significance			0.2	0.1	0.1	0.1

4.3 Display Readability Rating

Display readability rating (DRR) results for the four display concepts and three approaches are presented in Figure 11 and Table 20 and were generated through use of the DRR questionnaire in Appendix C. Table 20 presents the percentage of the time that pilots selected a specific DRR rating for the combinations of display concept and approach. The median and total number of data points are also given. Figure 11 presents the cumulative percentage that pilots selected specific DRR ratings for each display concept for the VFR, ILS, and VMC-Like approaches. Discussion is provided regarding the minimum, maximum, and median ratings received for each display concept and test condition. Further discussion is provided regarding the range of ratings required to capture at least 60% and 80% of the ratings to provide insight into the distribution of the results. Individual DRR results for each evaluation are provided in Appendix D.

Table 20: Display Readability Percentage of Time Selected Results (all Pilots)

DRR	VFR Approach				ILS Approach				VMC-L Approach		
	BRD	SCFD	PBG	SVS	BRD	SCFD	PBG	SVS	SCFD	PBG	SVS
1	25.0	15.8	27.8	45.0	10.3	22.2	17.6	57.1	21.1	26.3	41.2
2	33.3	31.6	44.4	35.0	20.7	50.0	47.1	28.6	42.1	42.1	35.3
3	29.2	21.1	22.2	10.0	20.7	11.1	29.4	9.5	5.3	15.8	5.9
4	8.3	26.3	5.6	10.0	17.2	11.1	0.0	0.0	15.8	10.5	11.8
5	4.2	0.0	0.0	0.0	13.8	5.6	0.0	4.8	0.0	5.3	5.9
6	0.0	0.0	0.0	0.0	6.9	0.0	5.9	0.0	10.5	0.0	0.0
7	0.0	0.0	0.0	0.0	3.4	0.0	0.0	0.0	5.3	0.0	0.0
8	0.0	5.3	0.0	0.0	6.9	0.0	0.0	0.0	0.0	0.0	0.0
9	0.0	0.0	0.0	0.0	0.0	0.0	0.0	0.0	0.0	0.0	0.0
10	0.0	0.0	0.0	0.0	0.0	0.0	0.0	0.0	0.0	0.0	0.0
Median	2	3	2	2	3	2	2	1	2	2	2
Total	24	19	18	20	29	18	17	21	19	19	17

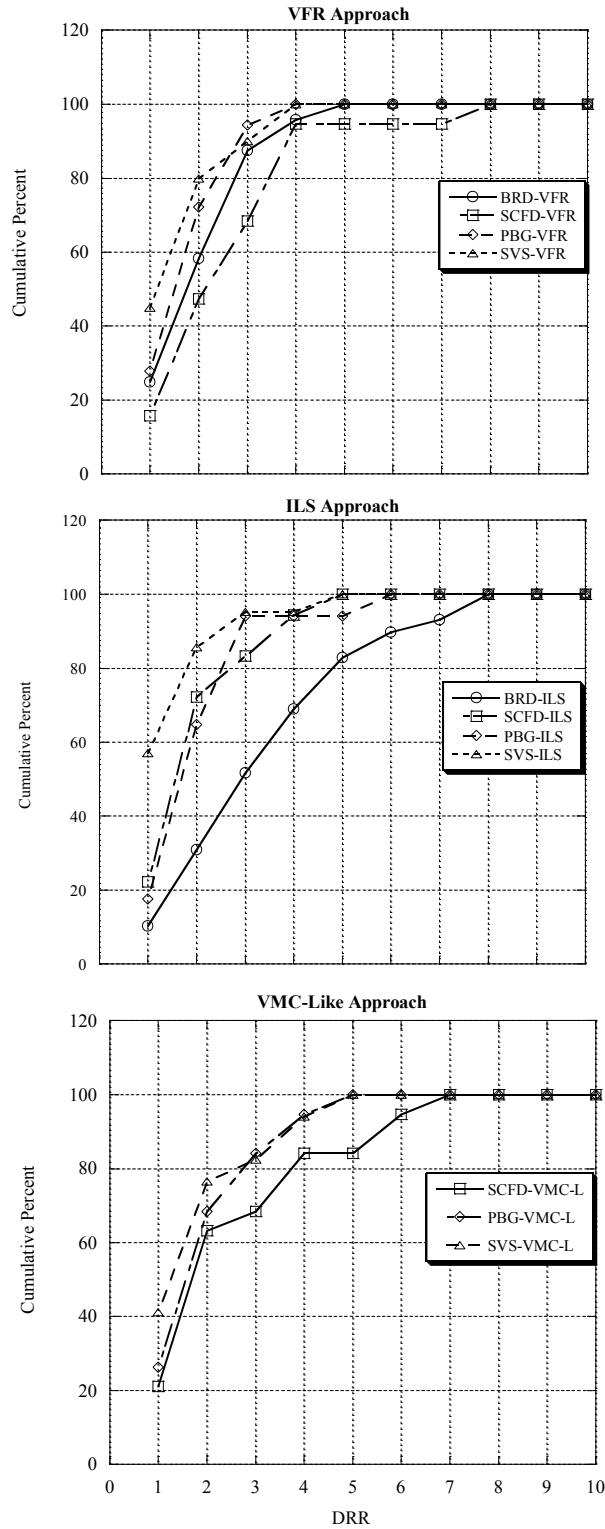

Figure 11: Cumulative Percentage of DRR, All Display Concepts and All Pilots

4.3.1 VFR approach, all pilots

For all the display concepts, the best rating received was a 1 “Excellent, Highly Desirable” characteristics. The PBG and SVS display concepts received a rating of 3 “Fair, Some Mildly Unpleasant Deficiencies” as the worst rating. The worst rating received for the BRD display concept was a 5 “Moderately Objectionable Deficiencies”. One pilot rated the SCFD as having characteristics of an 8 “Major Deficiencies”. For the VFR approach, DRR results indicate that all display concepts were rated as “satisfactory without improvement” or better (i.e., DRR ratings of 1 or a 2) at least 60% of the time as indicated in Figure 11. Display readability rating results for the SVS display concept indicate that it was rated as a 1 “Excellent, Highly Desirable” characteristics 45% of the time and either a 1 or a 2 “Good, Negligible Deficiencies” 80% of the time. The BRD and PBG display concept results needed to also include a rating of 3 “Fair, Some Mildly Unpleasant Deficiencies” to capture at least 80% of the ratings. The SCFD display concept results needed to also include ratings of 4 “Minor but Annoying Deficiencies” to capture 80% of the ratings. All display concepts, except the SCFD received a median DRR rating of 2 which is “good with negligible deficiencies” for this approach. The SCFD display concept received a median DRR rating of 3, which is “fair, some mildly unpleasant deficiencies” due to frustration involving the inability to differentiate lateral flight path from flight-path track-angle errors.

4.3.2 ILS approach, all pilots

For all the display concepts, the best rating received was a 1 - “Excellent, Highly Desirable” characteristics. The worst rating received for the SCFD and SVS display concepts was a 5 “Moderately Objectionable Deficiencies”. The worst rating for the PBG display concept was a 6 “Very Objectionable But Tolerable Deficiencies”. The BRD display concept received several ratings of 8 “Major Deficiencies” for the ILS approach as the worst rating. Display readability results indicate that all display concepts, except the BRD, were rated as “satisfactory without improvement” or better (i.e., DRR ratings of 1 or a 2) at least 60% of the time as indicated in Figure 11. The BRD display concept was rated as having “Minor But Annoying Deficiencies” or better (i.e., DRR ratings of 1 through 4) at least 60% of the time and having “Moderately Objectionable Deficiencies” (i.e., DRR ratings of 1 through 5) or better 80% of the time. The SVS display concept was rated as a 1 having “Excellent, Highly Desirable” characteristics 57% of the time and DRR ratings of either a 1 or a 2 80% of the time. The PBG and SCFD display concepts were rated as “Fair, Some Mildly Unpleasant Deficiencies” or better 80% of the time. The SVS display concept was the only one to achieve 80% of the ratings being either a 1 or a 2. The SVS display concept was also the only one to receive a median rating of 1 for the ILS approach. Comparing the PBG and SVS display concepts reveals that the effect of the SVS terrain lead to a 40% increase in the percentage of DRR 1 ratings. It is believed that the presence of the SVS terrain facilitated integration of the other information elements on the display leading to the improved ratings. The BRD display concept received a median DRR rating of 3 “Fair, Some Mildly Unpleasant Deficiencies” for the ILS approach and the SCFD and PBG display concepts received median ratings of 2.

4.3.3 VMC-Like approach, all pilots

For all the display concepts, the best rating received was a 1 “Excellent, Highly Desirable” characteristics. The worst rating received for the PBG and SVS display concepts was a 5 “Moderately Objectionable Deficiencies”. The worst rating for the SCFD display concept was a 7 “Major Deficiencies”. All display concepts were rated as a 2 with “Good, Negligible Deficiencies” or better at least 60% of the time as shown in Figure 11. Only the SVS and PBG display concepts received ratings of a 3 “Fair, Some Mildly Unpleasant Deficiencies” or better 80% of the time. The SCFD display concept received ratings of a 4 “Minor but Annoying Deficiencies” or better 80% of the time. It is believed that the lack of turn anticipation of the SCFD display concept contributed towards the degraded DRR results. Comparing the

PBG with the SVS display DRR results in Figure 11 concept revealed that the effect of SVS terrain increased the percentage of DRR 1 ratings by 17%. All display concepts received median ratings of 2 “Good, Negligible Deficiencies”.

4.3.4 ILS approach without low-time VFR pilot data

The DRR data were also analyzed for the ILS approach without the VFR pilot data. Table 21 presents the percentage of the time pilots selected a specific DRR rating for each display concept for the ILS approach without the VFR pilot data (along with the median and total number of data points). The best rating received for all four display concepts was a 1 - “Excellent, Highly Desirable” characteristics. The worst ratings for the SVS and SCFD display concepts was a 5 “Moderately Objectionable Deficiencies” whereas the worst rating for the PBG display concept was a 6 “Very Objectionable But Tolerable Deficiencies”. As was illustrated for all the pilots’ data, the effect of SVS terrain contributed to increase the percentage of DRR 1 ratings by approximately 40% compared to the PBG display concept. This result is a similar result to the data for all of the pilots. However, the SVS display was one DRR 1 rating short of receiving a median rating of 1. At least 60% and 80% of the time, the SVS display concept was rated as a 2 or better. The PBG display concept required the inclusion of DRR 3 “Fair, Some Mildly Unpleasant Deficiencies” results to capture at least 60% and 80% percent of the responses. The SCFD was rated as a 2 or better 60% of the time and a 3 or better 80% of the time and considered similar to the PBG results. The BRD display concept received the worst ratings and was rated as a 4 “Minor But Annoying Deficiencies” or better 60% of the time and a 5 “Moderately Objectionable Deficiencies” or better 80% of the time. Results in Table 21 show that all display concepts, except for the BRD, received a median DRR rating of 2 “Good, Negligible Deficiencies” while the BRD received a median DRR rating of 3 “Fair, Some Mildly Unpleasant Deficiencies”.

Table 21: Display Readability Results for the ILS Approach, IFR and H-IFR pilots

DRR	ILS Approach			
	BRD	SCFD	PBG	SVS
1	10.5	16.7	9.1	46.7
2	21.1	58.3	45.5	40.0
3	26.3	8.3	36.4	6.7
4	10.5	8.3	0.0	0.0
5	15.8	8.3	0.0	6.7
6	5.3	0.0	9.1	0.0
7	5.3	0.0	0.0	0.0
8	0.0	0.0	0.0	0.0
9	0.0	0.0	0.0	0.0
10	0.0	0.0	0.0	0.0
Median	3	2	2	2
Total	19	12	11	15

4.3.5 ILS and VMC-Like approach analysis, all pilots, advanced displays

Comparing the results for the ILS approach with the results from the VMC-Like approach reveals that the best rating received by the SCFD, PBG, and SVS display concepts were identical. The worst rating received for the SCFD display concept increased to a 7 (“Major Deficiencies”) from a 5 (“Moderately Objectionable Deficiencies”) for the ILS approach. The worst rating received for the PBG display concept improved from a 6 (“Very Objectionable But Tolerable Deficiencies”) to a 5 (“Moderately Objectionable Deficiencies”) and the worst rating for the SVS display concept remained unchanged at a DRR of 5. Comparing the DRR results in Figure 11 for the ILS and VMC-Like approaches reveals that the SCFD, PBD, and SVS display concepts were rated as a 2 (“Good, Negligible Deficiencies”) at least 60% of the time. There was a slight increase in the ratings for the SVS and SCFD display concepts for the VMC-Like approach compared to the ILS approach. The SVS display received a rating of 3 (“Fair, Some Mildly Unpleasant Deficiencies”) or better 80% of the time instead of a 2. The SCFD display concept was rated as a 4 “Minor But Annoying Deficiencies” or better 80% of the time instead of a 3. The SVS display concept median rating increased to a 2 from a 1 for the VMC-Like approach compared to the ILS approach. The median ratings for the SCFD and PBG display concepts was a 2 “Good, Negligible Deficiencies” for both the ILS and VMC-Like approaches. These increases in ratings are attributed to the higher workload of the VMC-Like approach.

4.3.6 Test condition analysis

Test condition analysis was conducting using a 4-level ranking method. First, the TCs were ranked based on median DRR received, then on the DRR required to capture at least 60% of the results, then on the DRR required to capture 80% of the results. Lastly, the TCs were ranked based on the maximum DRR rating received. The results of this analysis is presented in Table 22. The most favorably rated TCs were those for the VFR pilots only for the ILS and VMC-Like approaches with the SVS display concept that received median DRR results of 1 - “Excellent, Highly Desirable” characteristics. It is believed that the VFR pilots rated these conditions favorably due to the presence of the SVS terrain that provided them with flight information in an intuitive out-the-window manner they are most accustomed to. The ILS approach with the SVS display concept for all pilots also received a median DRR rating of 1. The VFR approach test conditions with the SVS and PBG display concepts received median DRR ratings of 2 (“Good, Negligible Deficiencies”). The presence of the SVS terrain on the SVS display concept is believed to provide a higher level of information integration during IMC conditions than in VMC conditions which leads to the lower DRR ratings for most of the IMC TCs. The SCFD was rated slightly better than the PBG display concept for the ILS approach but slightly worse for the VMC-Like approach. It is believed that the presence of the highway-in-the-sky tunnel of the PBG display concept provides substantial benefits for curved approaches. The presence of the SVS terrain provided a larger reduction in the DRR ratings for the ILS approach than for the VMC-Like approach. For the ILS approach the reduction of DRR ratings due to the SVS terrain resulted in a lowering of the median rating to a 1 from a 2 as well as reducing the range of DRR rating required to capture 80% results and maximum ratings. For the VMC-Like approach PBG and SVS displays concepts were rated identically to each other. All of the IMC TCs were rated better than the ILS + BRD display concept baseline, which does not include VFR pilots data for the test condition analysis. This indicates that the SCFD, PBG, and SVS display concepts provide improved display readability for the ILS approach, compared to what is currently the minimum required equipment, and could be expected to facilitate advanced IMC approaches similar to the VMC-Like approach considered herein.

Table 22: DRR Results for Test Condition.

Test Condition Name	TC	Median	<60%	<80%	Max
ILS Approach + SVS (only VFR pilots)	12	1	1	1	3
VMC-Like Approach + SVS (only VFR pilots)	13	1	1	3	4
ILS Approach + SVS	8	1	2	2	5
VFR Approach + SVS	4	2	2	2	4
VFR Approach + PBG	3	2	2	3	4
ILS Approach + SCFD	6	2	2	3	5
VMC-Like Approach + PBG	10	2	2	3	5
VMC-Like Approach + SVS	11	2	2	3	5
ILS Approach + PBG	7	2	2	3	6
VMC-Like Approach + SCFD	9	2	2	4	7
VFR Approach + BRD	1	2	3	3	5
VFR Approach + SCFD	2	3	3	4	8
ILS Approach + BRD	5	3	3	5	7

4.4 Terrain Awareness

The EPs were asked to rate their overall understanding of the terrain environment within which they were operating. Items to consider were the quantity and quality of the terrain information available to them and how comfortable they were with their terrain awareness. These data were acquired to augment other results and facilitate the determination of the effect that terrain awareness provides to overall SA. Terrain Awareness (TA) ratings for the four display concepts and three approaches are presented in Figure 12 and Table 23 and were generated through use of the TA question in Appendix C. (Error bars in Figure 12 represent one SD.) Individual TA results for each evaluation are provided in Appendix D.

Table 23: TA Descriptive Statistics (all Pilots)

Display Concept	Approach	Mean	Standard Deviation	Number of Data Points
BRD	VFR	84.5	11.9	24
	ILS	9.2	9.7	29
	Total	48.0	40.2	37
SCFD	VFR	61.3	26.2	19
	ILS	48.1	22.5	18
	VMC-Like	46.1	23.0	18
	Total	52.0	24.5	55
PBG	VFR	69.0	23.5	18
	ILS	51.7	30.2	17
	VMC-Like	55.4	28.7	19
	Total	58.8	28.1	54
SVS	VFR	87.8	10.6	19
	ILS	84.8	17.5	21
	VMC-Like	79.7	25.1	19
	Total	84.1	18.6	59
Total	VFR	75.9	22.0	75
	ILS	49.8	34.5	74
	VMC-Like	60.7	29.1	56
	Total	60.2	32.1	221

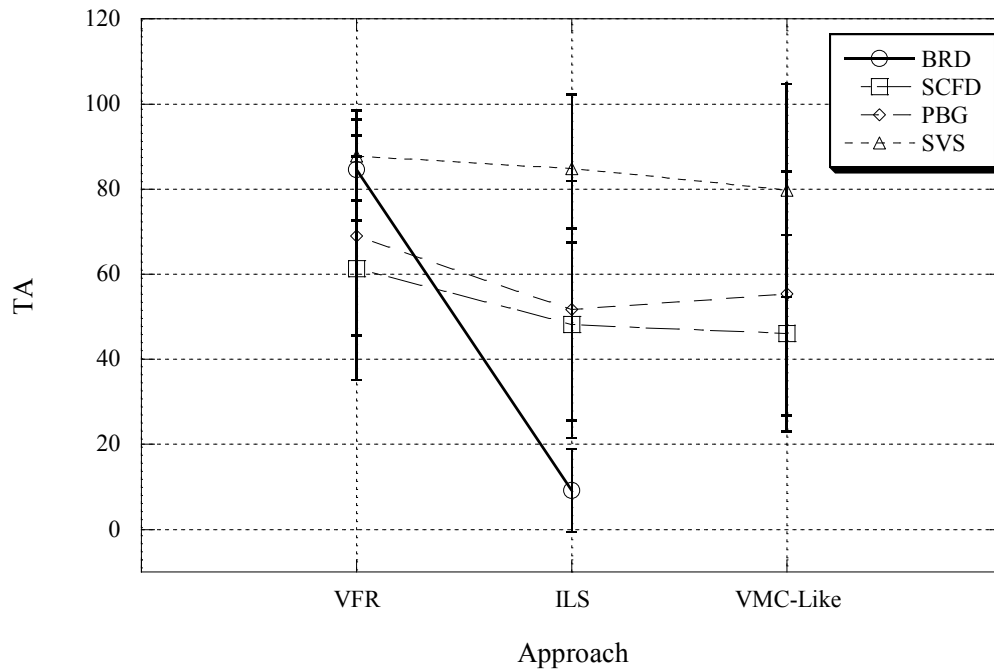

Figure 12: Terrain Awareness Results for All Display Concepts, All Pilots and All Approaches

4.4.1 VFR approach discussion

For the VFR approach, TA ratings were high for the BRD display concept (84.5) but decreased for the SCFD and PBG display concepts. Even though evaluation pilots were instructed to fly a VFR approach using the out-the-window environment for navigation, EPs occasionally used the guidance provided by the advanced display concepts (SCFD, PBG, and SVS) to cross check their flight path. An ANOVA conducted on the TA results for the VFR approach for the main effects of display concept and pilot type resulted in highly significant results for display concept ($F(3,80)=8.75, p<0.01$) but not for pilot type. A subsequent SNK post-hoc analysis resulted in two unique subsets shown in Table 24. Evaluation pilots noted that the increased attention allocated to looking at the displays for cross-check information versus out-the-window navigation reduced their terrain awareness, especially for the SCFD display concept. In Table 24 terrain awareness significantly decreased 15.5 units for the PBG display concept compared to the BRD. Terrain awareness also decreased another 7.7 units for the SCFD compared to the PBG display concept. However, for the SVS display concept, terrain awareness ratings were slightly higher than for the BRD display concept. Traditionally pilots needed to look outside the aircraft to see terrain, and other threats such as traffic, and inside the aircraft for flight and navigation information. The ratio of the time pilots look outside the aircraft to within is frequently used as a evaluation criterion for new avionics and procedures. However, the presence of SVS terrain on the PFD alters this paradigm since terrain information is provided in both eyes-out and eyes-in locations.

Table 24: Mean TA SNK Results for Display Concept, for all Pilots for the VFR Approach

Display Concept	Number of Data Points	Subset	
		1	2
SCFD	19	61.3	
PBG	18	69.0	
BRD	24		84.5
SVS	19		87.8
Significance		0.20	0.58

4.4.2 ILS approach, all pilots

An ANOVA conducted on the TA results for the ILS approach for the main effects of display concept and pilot type resulted in highly significant results for display concept ($F(3,85)=59.18, p<0.01$) but not for pilot type. A subsequent SNK post-hoc analysis resulted in three unique subsets shown in Table 25. From Table 25 it can be seen that the BRD display concept was rated much worse in terms of TA with a 38.9 unit decrease compared to the SCFD display concept for the ILS approach and was the only member of this subset. This reflects the EPs very low awareness of the terrain environment within which they were operating with the BRD display concept without out-the-window visibility. For this condition, EPs created a mental model of the terrain outside the aircraft through their knowledge of where they were along the ILS approach path combined with their mental recall of the operational area and paper charts. Compared to the BRD display concept, the SCFD and PBG display concepts yielded significant increases in terrain awareness of 38.9 and 42.5 units respectively, and were the only two members of the intermediate terrain awareness subset, reflecting the incorporation of the ND. Terrain awareness for the SVS display concept was significantly increased by 33.1 units compared to the PBG display concept for the ILS approach. This result is due to the presence of a perspective display of 3-D terrain on the PFD and its intuitive integration with the flight information and guidance symbology. Note that the level of terrain awareness for the SVS display concept for the ILS approach was virtually identical to the level of terrain awareness for the BRD display concept for the VFR approach as shown in Figure 12.

Table 25: Mean TA SNK Results for Display Concept, for all Pilots for the ILS Approach

Display Concept	Number of Data Points	Subset		
		1	2	3
BRD	29	9.2		
SCFD	18		48.1	
PBG	17		51.7	
SVS	21			84.8
Significance		1.00	0.55	1.00

4.4.3 VMC-Like approach, all pilots

An ANOVA conducted on the TA results for all pilots and display concepts revealed that the main effect was highly significant for display concept ($F(2,56)=10.1$, $p<0.01$) but not for pilot type ($p>0.05$). There were no significant interactions between the main effects. An SNK post-hoc analysis on the TA results provided two unique subsets for display concept as shown in Table 26. Even though the outside terrain was provided in a gods-eye-view format on the ND, the addition of the SVS terrain on the PFD significantly improved perceived terrain awareness for the SVS display concept compared to the PBG display concept. Overall, the SVS display concept was the only member of the highest (best) terrain awareness subset due to the effective integration of terrain with guidance and flight information symbology. The improvement in terrain awareness due to guidance symbology for the PBG display concept was approximately 9 units and not statistically different compared to the SCFD display concept. It is likely that the improved terrain awareness was related to the reduced workload for the PBG display concept that allowed pilots more time to absorb terrain information from the ND.

Table 26: Mean TA SNK Results for Display Concept for all Pilots for the VMC-Like Approach

Display Concept	Number of Data Points	Subset	
		1	2
SCFD	18	46.1	
PBG	19	55.4	
SVS	19		79.7
Significance		0.228	1.00

4.4.4 ILS approach without low-time VFR pilot data

Results for TA were analyzed without the low-time VFR pilot data, enabling a more direct comparison of the four display concepts within current operations. Results from an ANOVA indicated that display concept was highly significant ($F(3,56)=43.26$, $p<0.01$) for TA. Pilot type was not significant for TA ($p>0.05$). As can be seen in the Table 27, three unique subsets were formed. The lowest (worst) TA was for the BRD display concept and represents the nominal level of terrain awareness for operations with traditional avionics. Compared to the BRD display concept, the incorporation of the gods-eye view of terrain on the ND combined with more intuitive flight path information significantly increased terrain awareness 39.9 and 47.7 units for the SCFD and PBG display concepts, respectively. However, for the SVS display concept, terrain awareness increased an additional 26.8 units compared to the PBG display concept. Subsequent SNK results, provided in Table 27, show that the SVS display concept was the only member of the highest (best) TA rating group. The SCFD and PBG display concepts were statistically similar and were in the middle subset.

Table 27: Mean TA SNK Results for the ILS Approach, IFR and H-IFR Pilots

Display Concept	Number of Data Points	Subset		
		1	2	3
BRD	18	10.9		
SCFD	12		50.8	
PBG	11		58.6	
SVS	15			85.5
Significance		1.00	0.30	1.00

4.4.5 ILS and VMC-Like approach analysis, all pilots, advanced displays

In an effort to compare the advanced display concepts with each other and also to evaluate the potential of these displays to support an advanced IMC approach for all pilot types, an ANOVA was performed on the TA data for the advanced displays with all pilots' data for the ILS and VMC-like approaches. Results indicated that display concept was highly significant ($F(2,112)=29.606, p<0.01$) for this measure. Pilot type was significant ($F(2,112)=2.91, p=0.01$), but approach was not for the TA ratings. Post-hoc SNK analysis revealed no significant TA differences for pilot type. However, in Table 28, it can be seen that the VFR pilots reported lower TA than the IFR pilots, and that the IFR pilots reported lower TA than the H-IFR pilots. This trend could be attributed to pilots' experience, with the more experienced pilots having the ability to better control the aircraft while absorbing terrain information from the various displays.

Table 28: Mean TA SNK Results for Pilot Type for the ILS and VMC-Like Approach for all Pilots

EP-type	Number of Data Points	Mean
VFR	36	57.7
IFR	37	61.6
H-IFR	39	65.8
Significance		0.22

Post-hoc SNK analysis for display concept revealed two unique subsets for the TA ratings (see Table 29). The SVS display concept was rated as providing the most terrain awareness. While the mean TA ratings were higher for the PBG display concept compared to the SCFD concept, the difference was not enough to be significant. The addition of SVS terrain appears to have increased TA for the two IMC approaches, with an increase in TA of almost 29 units.

Table 29: Mean TA SNK Results for Display Concept for the ILS and VMC-Like Approach, All Pilots

Display Concept	Number of Data Points	Subset	
		1	2
SCFD	36	47.1	
PBG	36	53.7	
SVS	40		82.4
Significance		0.18	1.00

4.4.6 Test condition analysis

A subsequent analysis on TA was performed based on TC with post-hoc results presented in Table 30. Test Condition was highly significant for TA results ($F(12,221)=20.583, p<0.01$). Four overlapping subsets were formed from post-hoc analysis. The highest (best) rated group included all of the VFR test conditions, as would be expected, except for the SCFD display concept. As noted previously, evaluation pilots reported some frustration with the SCFD for the VFR approach. As a result TC 2 (VFR approach with SCFD) had lower TA results, which put it in the next lower subset. All of the simulated IMC evaluations of the SVS display concept were grouped with the highly rated VFR evaluations. This indicates that, for TA, out-the-window visibility had little effect for the SVS display concept. Terrain Awareness results may also indicate that advanced IMC approaches, like the VMC-like approach, are feasible with SVS.

The worst TA subset was comprised of only TC 5 (ILS approach evaluation of the BRD display concept). While this type of result has been observed for the other variables (i.e., SART, TLX, DRR), the separation of TC 5 from the others is much more pronounced for TA. Subset 2 is comprised of ILS and VMC-like evaluations of the SCFD and PBG display concepts and is only slightly different in composition than subset three. Note that subset three includes TC 3 (VFR approach with the PBG display concept) and doesn't include TC 9 (VMC-like approach with the SCFD display concept). Overall, the TC analysis of terrain awareness indicates that all the advanced display concepts provided superior TA than TC 5 (ILS approach, BRD display concept) for both ILS and VMC-like approaches, most likely due to the presence of terrain on the ND. However, the SVS display concept provides additional significant improvements in terrain awareness with results for simulated IMC that are as good or better than those for the VFR approach with the BRD.

Table 30: Mean TA SNK Results for Test Condition

Test Condition Name	TC #	Number of Data Points	Subset			
			1	2	3	4
ILS Approach + BRD (no VFR pilots)	5	18	10.9			
VMC-Like Approach + SCFD	9	18		46.1		
ILS Approach + SCFD	6	18		48.1		
ILS Approach + PBG	7	17		51.7	51.7	
VMC-Like Approach + PBG	10	19		55.4	55.4	
VFR Approach + SCFD	2	19		61.3	61.3	
VFR Approach + PBG	3	18			69.0	69.0
VMC-Like Approach + SVS	11	19				79.7
VMC-Like Approach + SVS (only VFR pilots)	13	6				80.7
ILS Approach + SVS (only VFR pilots)	12	6				82.8
VFR Approach + BRD	1	24				84.5
ILS Approach + SVS	8	21				84.8
VFR Approach + SVS	4	19				87.8
Significance			1.0	0.2	0.1	0.1

4.5 PTS Results

This section discusses the results against IFR Practical Test Standard (PTS) criteria. Recall that the PTS criteria are composed of a combination of lateral, vertical, and airspeed errors. PTS results are presented in terms of a percentage of time the evaluation pilots were able to satisfy all three criterion simultaneously during Segments 2 and 3 (i.e., from points A and B in Figure 8 down to 200 ft AGL). PTS results are shown in Figure 13 and presented in Table 31. (In Figure 13, the error bars represent one SD.) Subsequent sections of this report discuss each of the parameters employed for the PTS criteria analyses, sometimes focusing only on the final approach segment of the total approach (i.e., Segment 3, simultaneous localizer and glideslope tracking).

Table 31: PTS Descriptive Statistics (% Time), Segments 2 and 3 for all Pilots

Display Concept	Approach	Mean	Standard Deviation	Number of Data Points
BRD	ILS	73.4	23.7	30
	Total	73.4	23.7	30
SCFD	ILS	88.2	9.9	18
	VMC-Like	89.5	10.5	18
	Total	88.8	10.1	36
PBG	ILS	90.4	9.8	16
	VMC-Like	90.1	12.5	19
	Total	90.2	11.2	35
SVS	ILS	90.7	7.9	27
	VMC-Like	92.0	10.5	19
	Total	91.2	9.0	46
Total	ILS	84.5	17.2	91
	VMC-Like	90.5	11.1	56
	Total	86.8	15.4	147

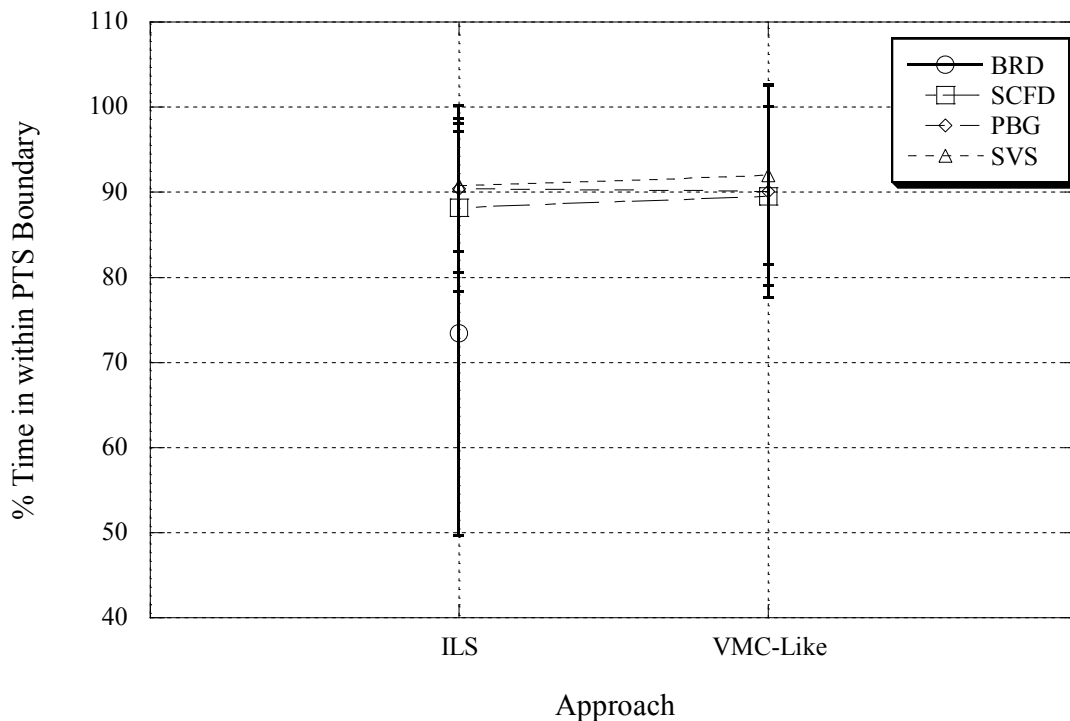

Figure 13: Percent Time within IFR PTS Performance Metrics, All Pilots, Segments 2 and 3

4.5.1 ILS approach, all pilots

An ANOVA conducted on the PTS data for all pilots for the ILS approach for the main effects of display concept and pilot type resulted in highly significant results for display concept ($F(3,85)=8.28$, $p<0.01$) and significant results for pilot type ($F(2,85)=3.64$, $p=0.03$). There were no significant interactions between the main effects. Subsequent SNK post-hoc analysis revealed two unique subsets for both display concept and pilot type as shown in Tables 32 and 33. The BRD display concept was the only member of the worst PTS performance group. The incorporation of the ND, with desired flight path and ownship symbology, combined with the SCFD guidance or HITS pathway presentations of the advanced display concepts, greatly facilitated the evaluation pilots' ability to remain within the PTS criteria. All of the advanced display concepts (i.e., SCFD, PBG, and SVS) were included in the best PTS performance group. A significant 14.8% improvement in PTS results occurred for the SCFD display concept compared to the BRD. The PBG and SVS display concepts improved PTS results by 2.2% and 2.9%, respectively, compared to the SCFD.

As anticipated for the ILS approach, the VFR pilots' PTS performance was significantly worse than the IFR and H-IFR pilots. Table 34 presents PTS results for display concept and pilot type and the difference between results for the VFR pilots compared to the average results for the IFR and H-IFR pilot groups and shows that differences between the different pilot types were much larger for the BRD display concept than the advanced display concepts. The decrease in VFR pilot performance was 4.6 times worse (i.e., $23.7/5.2=4.6$) for the BRD display concept compared to SCFD and 9.9 times (i.e., $23.7/2.4=9.9$)

worse than the SVS display concept. This result can be attributed to the VFR pilots' lack of training in integrating disparate information from the individual BRD display gauges. However, the highly-integrated and intuitive display of information of the advanced display concepts greatly improved the VFR pilots ability to fly without outside visual cues. This was especially true for the SVS display concept. Subsequent sections of this report provide analyses of the constituent elements of the PTS criteria (i.e., localizer, glideslope and IAS errors) providing insight into the distribution of exceedances along the approach.

Table 32: Mean PTS (% of Time) SNK Results for Display Concept for all Pilots, ILS Approach.

Display Concept	Number of Data Points	Subset	
		1	2
BRD	30	73.4	
SCFD	18		88.2
PBG	16		90.4
SVS	21		91.1
Significance		1.00	0.797

Table 33: Mean PTS (% of Time) SNK Results for Pilot Type for All Display Concepts, ILS Approach.

Pilot Type	Number of Data Points	Subset	
		1	2
VFR	29	75.9	
H-IFR	27		88.0
IFR	29		88.7
Significance		1.00	0.849

Table 34: Mean PTS (% of Time) Results for Pilot Type and Display Concept, ILS Approach.

Display Concept	Pilot Type	Mean	VFR pilots results compared to the average of IFR and H-IFR pilots	Number of Data Points
BRD	VFR	58.5	-23.7	11
	IFR	82.8		11
	H-IFR	81.1		8
SCFD	VFR	84.7	-5.2	6
	IFR	90.8		6
	H-IFR	89.0		6
PBG	VFR	85.7	-6.7	6
	IFR	94.4		4
	H-IFR	92.5		6
SVS	VFR	89.4	-2.39	6
	IFR	92.4		8
	H-IFR	91.1		7

4.5.2 VMC-Like approach, all pilots, advanced displays

An ANOVA conducted on the PTS results for the main effects of display concept ($F(2,56)=1.25$, $p=0.30$) and pilot type ($F(2,56)=0.88$, $p=0.42$) resulted in no significant ($p<0.05$) differences for either and no significant interactions. Tables 35 and 36 provide the mean results for display concept and pilot type. While not statistically significant, the SVS display concept enabled pilots to remain within the PTS criteria 2.5% longer than the SCFD. In addition, the VFR pilots were able to generate similar PTS results to the IFR pilots and only 3.9% worse than the H-IFR pilots, even though the VMC-like approach included two 90-degree descending turns during the last 3.4 nm of the approach.

Table 35: Mean PTS (% of Time) SNK Results for Display Concept for all Pilots, VMC-Like Approach

Display Concept	Number of Data Points	Subset
SCFD	18	89.5
PBG	19	90.1
SVS	19	92.0
Significance		0.503

Table 36: Mean PTS (% of Time) SNK Results for Pilot Type for All Display Concepts, VMC-Like Approach

Pilot Type	Number of Data Points	Subset
IFR	18	89.0
VFR	18	89.2
H-IFR	20	93.1
Significance		0.169

4.5.3 ILS approach Segment 3 without VFR pilot data

An ANOVA was conducted on the ILS approach Segment 3 results without the VFR pilot data for the main effects of display concept and pilot type. Results of the ANOVA indicated no significant effect of display concept or pilot type ($p > 0.05$). It is likely that instrument training for the IFR and H-IFR pilots enabled them to maintain acceptable performance even with the BRD display concept. However, while the results for the display concept were not statistically significant, the BRD display concept tended toward the worst PTS performance of the tested concepts, as shown in Table 37. IFR and H-IFR pilots were only able to satisfy all three of the PTS criteria simultaneously 83.1% of the time. This establishes the baseline minimum required PTS performance within the data set considered herein. The SCFD display concept improved PTS results by 7.8% compared to the BRD and reflects the improved capabilities due to the ND and integrated PFD with the single-cue flight director. The PBG and SVS display concepts improved PTS results by 1.8% and 3.3% compared to the SCFD display concept, respectively.

Table 37: PTS (% of Time) Results for Display Concept for Segment 3 of the ILS Approach, IFR and H-IFR Pilots Only

Display Concept	Mean
BRD	83.1*
SCFD	89.2
SVS	90.9
PBG	92.0

*Note: This value is used herein as the baseline performance for an ILS Approach.

In contrast to the analysis with the VFR pilot data, the effect of display concept was substantially reduced, as can be seen through comparison of the ANOVA results as well as Tables 32 and 37. This result indicates that the VFR pilots had a much harder time with the BRD display concept than the instrument rated pilots.

4.5.4 ILS and VMC-Like approaches, Segment 3, all pilots, advanced displays

Figure 14 presents PTS criteria results for Segment 3 of the ILS- and VMC-Like approach maneuvers for all display concepts. An ANOVA was performed on the PTS data for the advanced displays for

segment 3 of the ILS and VMC-like approaches in an effort to compare the advanced display concepts with each other and also to evaluate their ability to support advanced IMC approaches for all pilot types. Display concept, approach, and pilot type were not significant ($p>0.05$) for this analysis and there were no significant interactions. While not significant, Tables 38, 39, and 40 provide information to assess the interactions between display concept, approach and pilot type. General trends in the data indicate that the VFR pilots performed 2 to 6% worse than the IFR and H-IFR pilots and that the effect of pilot type was the smallest for the SVS display concept. Overall, PTS performance results for the VMC-like approach with the advanced display concepts were as good or better than the acceptable PTS performance for the ILS approach as established herein. This result indicates that the advanced display concepts can potentially enable pilots to accurately perform approaches other than classic ILS-type approaches, with long straight legs, across a broad range of pilot skills.

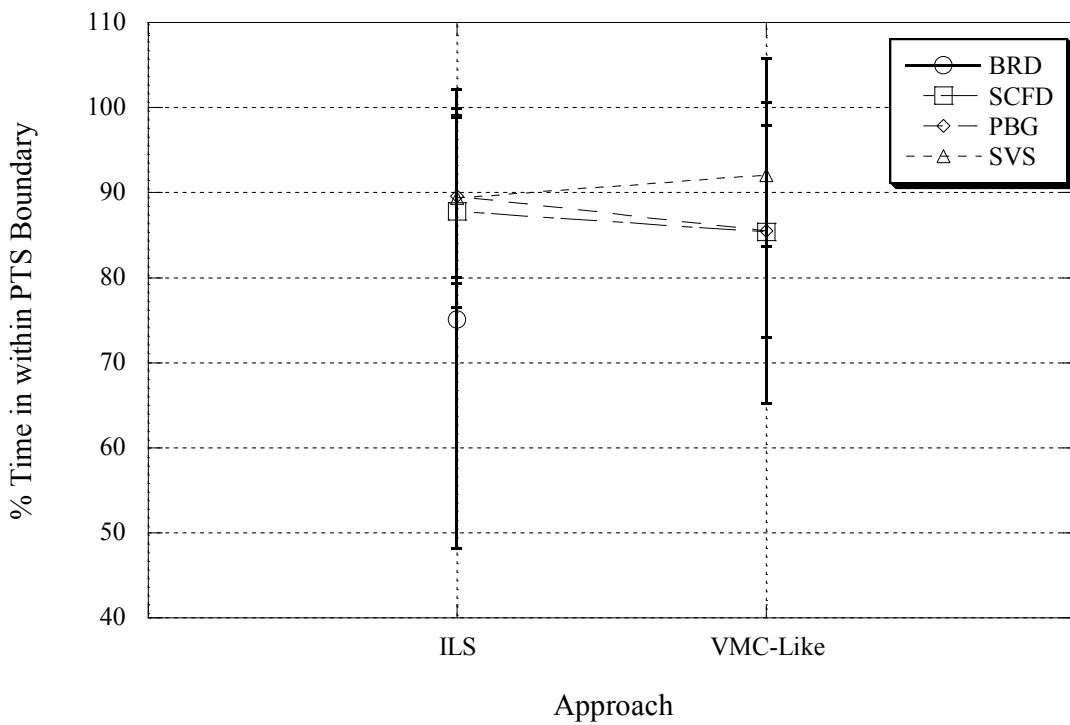

Figure 14: Percent Time within IFR PTS performance Metric, All Pilots, Segment 3 Only

Table 38: PTS (% of Time) Criteria for Display Concept and Approach interactions, ILS and VMC-Like Approaches, Segment 3

Display Concept	Approach	Mean
SCFD	ILS	87.8
	VMC-Like	85.4
PBG	ILS	89.6
	VMC-Like	85.5
SVS	ILS	89.9
	VMC-Like	92.1

Table 39: PTS (% of Time) Criteria Results for Display Concept and Pilot Type Interactions, ILS and VMC-Like Approaches, Segment 3

Display Concept	Pilot Type	Mean
SCFD	VFR	84.3
	IFR	86.8
	H-IFR	88.7
PBG	VFR	84.5
	IFR	86.8
	H-IFR	90.4
SVS	VFR	88.9
	IFR	91.3
	H-IFR	92.4

Table 40: PTS (% of Time) Criteria Results for Approach and Pilot Type Interactions, ILS and VMC-Like Approaches, Segment 3

Approach	Pilot Type	Mean
ILS	VFR	86.1
	IFR	91.7
	H-IFR	89.6
VMC-Like	VFR	85.7
	IFR	85.4
	H-IFR	91.5

4.5.5 Test condition analysis, Segment 3

An ANOVA was performed on the PTS results for TC with SNK post-hoc results presented in Table 40. The analysis was limited to segment 3. Test Condition was not significant ($p > 0.5$) for PTS results. From Table 40, it can be seen that the worst PTS results were for TC 5 (ILS approach with BRD display concept) and the best results were for TC 11 (VMC-like approach for the SVS display concept). Of the simulated-IMC evaluations, TC 5 was again the worst while all combinations of advanced display concepts and IMC approaches (i.e., ILS or VMC-like) were better, though not significantly. Not only did the advanced display concepts slightly improve PTS results compared to the BRD, but this improvement was accomplished when also including the VFR pilot data. Note that TC 8 (ILS approach with SVS display concept) was 2.2% worse than TC 11 (VMC-like approach with SVS display concept). One possible explanation for this result involves the VFR pilots and their increased familiarity with the VMC-like approach, due to its similarity to the VFR approach, compared to the ILS approach. Occasionally, VFR evaluation pilots would forget to reduce their airspeed from 100 kts to 90 kts when intercepting the glideslope for the ILS approach, but never missed the airspeed reduction at waypoint NEWT for the VMC-like approach. Recall that waypoint NEWT was located abeam the runway numbers on the downwind leg and was a significant event location for the VFR approach. It is also worthwhile to note that the effect of the SVS terrain led to a 7% improvement in evaluation pilots' performance compared to the PBG display concept for the VMC-like approach. This is likely due to the increased awareness provided by the SVS terrain background for this highly dynamic approach segment. It is believed that the SVS terrain served as an integrator for the other disparate pieces of information provided on the PFD (i.e., attitude, altitude, flight path, heading, etc.) and was particularly valuable for the VFR pilots. Further discussion regarding the elements of the PTS metric are provided in subsequent sections. In particular it is shown that the effect of the SVS terrain enables a significant improvement in the pilots ability to minimize glideslope error. Results for the VFR pilot evaluations of the SVS display concept for the ILS and VMC-like approaches were better than TC 5 (ILS approach with BRD display concept). Although the PTS results were not statistically significant, they indicate that advanced IMC approaches may be possible for the advanced display concepts, especially for the SVS display concept.

Table 41: Mean PTS (% of Time) SNK Criteria Results for TC, All pilots, Segment 3

Test Condition Name	TC	Number of Data Points	Mean
ILS Approach + BRD (no VFR pilots)	5	19	83.1
VMC-Like Approach + SCFD	9	18	85.4
VMC-Like Approach + PBG	10	19	85.5
ILS Approach + SVS (VFR pilots)	12	6	87.7
ILS Approach + SCFD	6	18	87.8
ILS Approach + PBG	7	16	89.6
ILS Approach + SVS	8	21	89.9
VMC-Like Approach + SVS (VFR pilots)	13	6	90.2
VMC-Like Approach + SVS	11	19	92.1
Significance			0.715

4.6 Localizer Error

Using localizer error results to describe the differences between the different display concepts and approaches is beneficial because the large majority of traditional IMC operations employ this type of guidance strategy. It is an especially valuable parameter to work with since the BRD display concept only displayed angular errors to the pilots. Comparing display concepts only on linear lateral errors substantially skews results towards the advanced display concepts since their guidance cue displacements are based on linear lateral error and are not affected by range to touchdown. Localizer error results for the four display concepts and three approaches are presented in Figure 15, 16, 17, and 18 along with Table 42.

Table 42: Localizer Error (dots) Descriptive Statistics for all Pilots

Display Concept	Approach	Mean	Standard Deviation	Number of Data Points
BRD	VFR	2.78	1.30	19
	ILS	0.75	0.46	18
	Total	1.65	1.37	37
SCFD	VFR	0.40	0.37	19
	ILS	0.17	0.09	18
	VMC-Like	0.43	0.30	18
	Total	0.34	0.30	55
PBG	VFR	0.18	0.08	18
	ILS	0.09	0.03	16
	VMC-Like	0.19	0.07	19
	Total	0.16	0.08	53
SVS	VFR	0.20	0.15	18
	ILS	0.10	0.03	20
	VMC-Like	0.17	0.07	19
	Total	0.15	0.10	58
Total	VFR	1.03	1.38	79
	ILS	0.34	0.41	85
	VMC-Like	0.26	0.22	56
	Total	0.57	0.93	220

4.6.1 VFR approach, all pilots

As can be seen in Figure 15 and Table 43, the VFR approach evaluation of the BRD display concept resulted in large localizer error values compared to the advanced display concepts. This increase in localizer error is again due to the EPs' flight path navigation being driven totally by the out-the-window view for the BRD display concept. A primary source of localizer error for the VFR approach evaluation of the BRD display concept occurred during the base leg. EPs would fly base legs that sometimes were inside of the intended flight path while still maintaining reasonable VFR approach conditions. Providing EPs with moving maps, desired flight path and ownship representation as included in the navigation display, along with flight path error and flight path guidance symbologies on the advanced display concepts, greatly reduced localizer error, as indicated in Figure 15 and Table 43. This result was generated even though the EPs were primarily flying a VFR eyes-out approach and using the guidance

information to cross check their out-the-window navigation. Note that the PBG and SVS display concepts produced the lowest level of localizer error (approximately 0.19 dots mean). An ANOVA conducted on the localizer error data for the VFR approach for the main effects of display concept and pilot type resulted in highly significant results for display concept ($F(3,79)=162.79$, $p<0.01$) and non-significant results for pilot type ($p>0.05$).

Table 43: Mean Localizer Error (dots) SNK results for Display Concept VFR Approach for All pilots

Display Concept	Number of Data Points	Subset	
		1	2
PBG	18	0.18	
SVS	18	0.20	
SCFD	19	0.40	
BRD	24		2.78
Significance		0.328	1.000

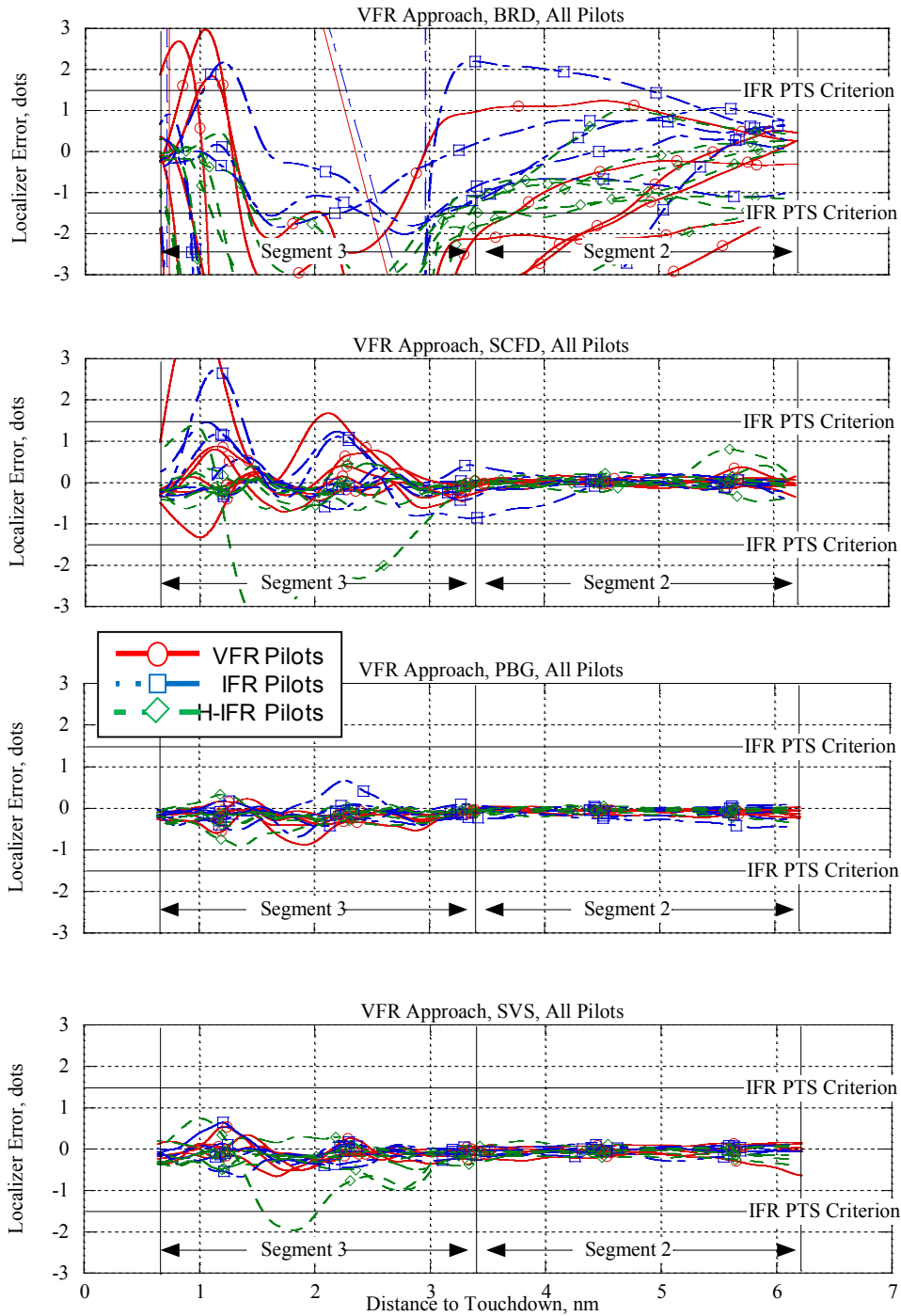

Figure 15: VFR Approach, Localizer Error, By Display Concept and Pilot Group

4.6.2 ILS approach, all pilots

For the ILS approach for all pilots, the localizer error decreased for all display concepts compared to the results for the VFR approach, as shown in Figures 15 and 16 and Table 44. The largest decrease was for the BRD display concept, which decreased from 2.8 dots for the VFR approach to 0.49 dots for the ILS approach. This reduction was due primarily to the increased level of flight path precision associated with IMC operations where pilots relied entirely on flight path guidance and error cues to minimize flight path error, along with the different nature of the ILS approach with long, straight approach legs. Figure 16 also shows that the effect of pilot group was eliminated for the advanced display concepts. This result was not the case for the BRD display concept, where the VFR pilot data indicates a difference compared to the IFR and H-IFR pilot data. Figure 16 also shows that the 1.5 dot IFR PTS criterion was met for the advanced display concepts for both Segment 2 and 3 of the ILS approach and not met for the BRD display concept for the VFR pilots for Segment 3. Again, Segment 2 did not include specific guidance cues for the BRD display concept and pilots were merely flying a localizer intercept heading after approach initialization, then tracking the localizer and maintaining altitude until intercepting the glideslope.

An ANOVA conducted on the localizer error data for the ILS approach for the main effects of display concept and pilot type revealed that display concept was highly significant ($F(3,85)=40.9$, $p<0.01$) and pilot type was not significant ($p>0.05$). There was a significant interaction between display concept and pilot type ($F(6,85)=2.63$, $p=0.025$). Post-hoc analysis resulted in the two subsets shown in Table 44. The worst subset was comprised of only the BRD display concept. The advanced display concepts comprised the best subset with the SCFD reducing localizer error by 77% compared to the BRD. The PBG and SVS display concepts reduced localizer error further compared to the SCFD by 41% and 47%, respectively.

The relatively poor performance of the BRD compared to the advanced display concepts can be partially attributed to the lack of guidance during Segment 2 of the ILS approach, along with the incorporation of the VFR pilot data. Table 45 provides results to support the pilot/display-concept interaction and shows that for the BRD display concept, the VFR EPs flew much worse than the IFR and H-IFR pilots. The data seems indicative of the lack of IFR training for the VFR pilots. They did receive the same training associated with this flight test, but it can also be stated that for the VFR-rated EPs, the out-the-window view is key to integrating and assimilating all the information they are being presented. When that out-the-window view is no longer available, VFR EPs had a challenging time integrating the information presented via the BRD display concept. However, the integrated presentation of flight information on the advanced display concepts enabled the VFR pilots to produce localizer error results similar to the IFR and H-IFR pilot groups.

Table 44: Mean Localizer Error (dots) SNK results for Display Concept for ILS Approach for all Pilots

Display Concept	Number of Data Points	Subset	
		1	2
PBG	16	0.09	
SVS	21	0.10	
SCFD	18	0.17	
BRD	30		0.75
Significance		0.596	1.000

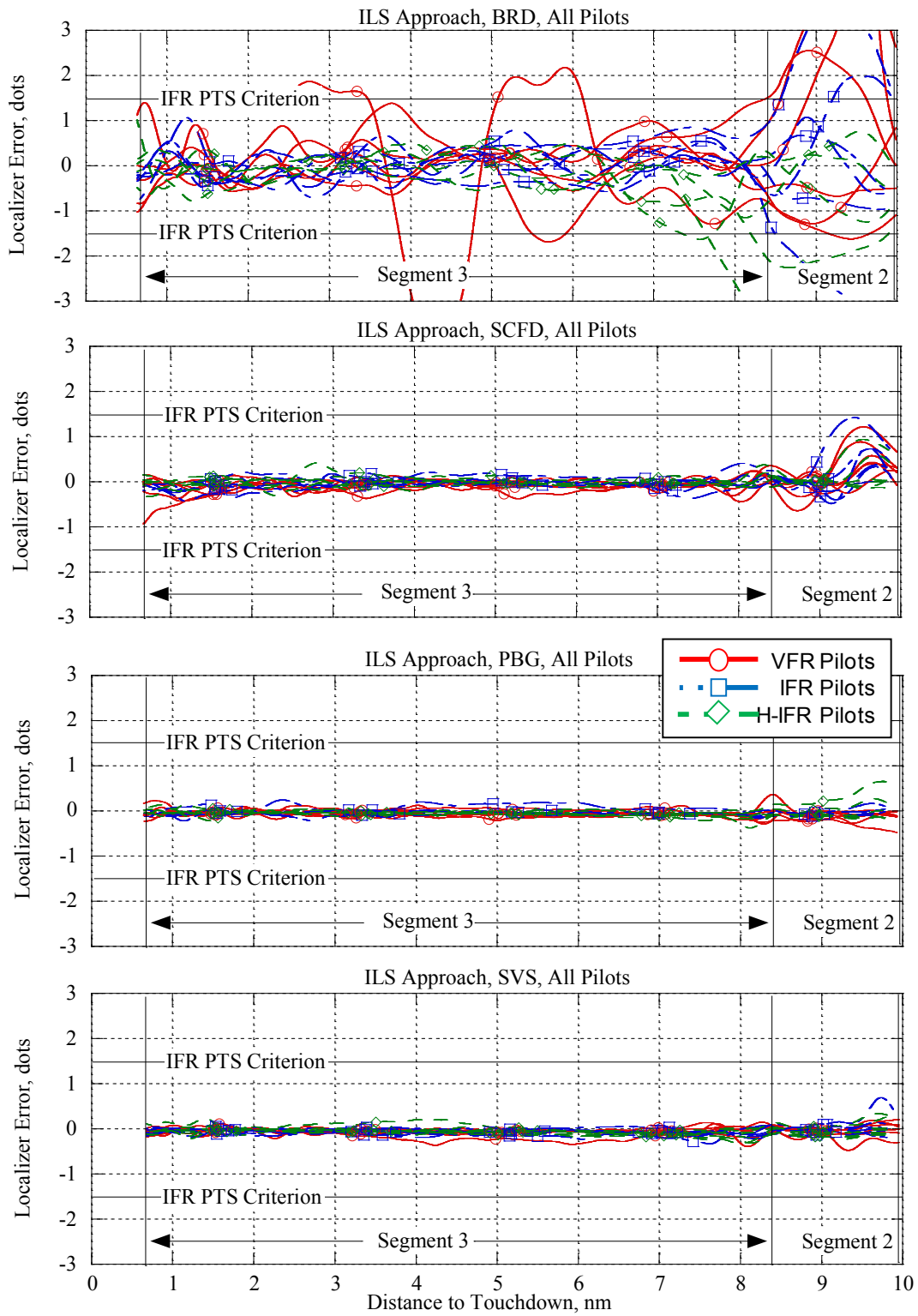

Figure 16: ILS Approach, Localizer Error, By Display Concept and Pilot Group

Table 45: Localizer Error Results (dots) for Display Concept and Pilot Type Interactions for the ILS Approach

Display Concept	Pilot Type	Mean	Standard Deviation	Number of Data Points
BRD	VFR	1.04	0.51	11
	IFR	0.57	0.28	11
	H-IFR	0.60	0.41	8
SCFD	VFR	0.21	0.08	6
	IFR	0.18	0.11	6
	H-IFR	0.11	0.08	6
PBG	VFR	0.10	0.03	6
	IFR	0.08	0.03	4
	H-IFR	0.10	0.04	6
SVS	VFR	0.10	0.05	6
	IFR	0.09	0.03	8
	H-IFR	0.10	0.03	7

4.6.3 VMC-Like approach, all pilots

Figure 17 shows very different results for the three advanced display concepts for the VMC-like approach. While results are very similar for Segment 2 (i.e., the straight, constant-altitude leg), substantial differences are evident in Segment 3 (i.e., two descending 90-degree turns). The differences apparent for the SCFD display concept compared to the PBG and SVS display concepts are located at the turns to base leg and final approach and can be attributed to the lack of turn anticipation for this display concept. All of the advanced display concepts included the ND with the moving map, flight path and ownship symbology. It is evident from these data that the evaluation pilots were not looking at the ND very much during this approach, especially for Segment 3, due to the rapid pace and relatively high workload. An ANOVA conducted on the localizer data for the VMC-like approach for the main effects of display concept and pilot type revealed highly significant results for display concept ($F(2,56)=13.69$, $p<0.01$) and non-significant results for pilot type ($p>0.05$). There was no significant interaction between display concept and pilot type. Subsequent post-hoc analysis, as shown in Table 46, reveals two unique subset-groups. The lowest (best) subset was comprised of the SVS and PBG display concepts, while the SCFD was the only member of the higher (worst) subset with localizer error 2.4 times larger than the mean for the SVS and PBG display concepts.

Table 46: Mean Localizer Error (dots) SNK results for Display Concept for the VMC-Like Approach for all Pilots

Display Concept	Number of Data Points	Subset	
		1	2
SVS	19	0.17	
PBG	19	0.19	
SCFD	18		0.43
Significance		0.655	1.000

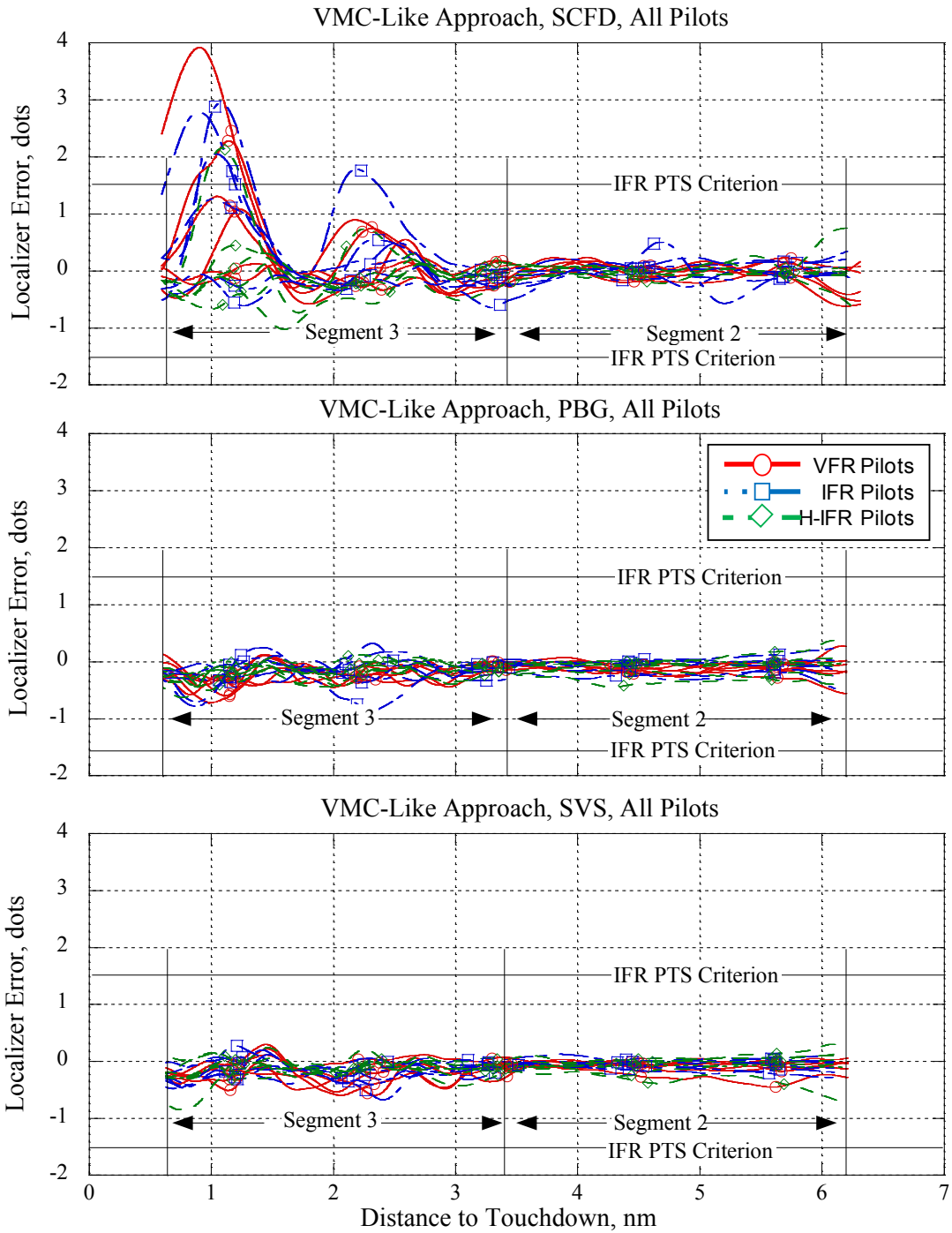

Figure 17: VMC-Like Approach, Localizer Error, By Display Concept and Pilot Group

4.6.4 ILS approach, Segment 3, no VFR pilots

Results for localizer error were analyzed without the VFR pilot data for Segment 3 (glideslope and localizer tracking), enabling a more direct comparison of the four display concepts within current IMC operations. Results from an ANOVA revealed that display concept was highly significant ($F(3,56)=38.847$, $p<0.01$) and that pilot type (i.e., IFR or H-IFR) was not significant for localizer error. In addition, there were no significant ($p>0.05$) interactions between pilot type and display concept for this measure. Subsequent post-hoc analysis produced two unique subsets, as shown in Table 47. The advanced display concepts (i.e., PBG, SVS, and SCFD) all produced significantly lower localizer error than the BRD display concept. This statistically significant result is visually supported by Figure 16, which shows the improvement in localizer error for the advanced display concepts. The average localizer error for the advanced display concepts was approximately one-fifth the result for the BRD display concept. This substantial decrease in localizer error could possibly enable meaningful decreases in the obstacle clearance provisions required for ILS approaches due to flight technical error considerations. The range of localizer error for the advanced display concept subset was 0.03 dots. Note that the baseline minimum required level of localizer error as defined by the IFR and H-IFR pilot data for the ILS BRD test herein is 0.39 dots.

Table 47: Mean Localizer Error (dots) SNK results for the ILS Approach for the IFR and H-IFR Pilots

Display Concept	Number of Data Points	Subset	
		1	2
PBG	10	0.07	0.39*
SVS	15	0.09	
SCFD	12	0.10	
BRD	19		
Significance		0.82	1.00

*Note: This value is used herein as the baseline performance for an ILS Approach

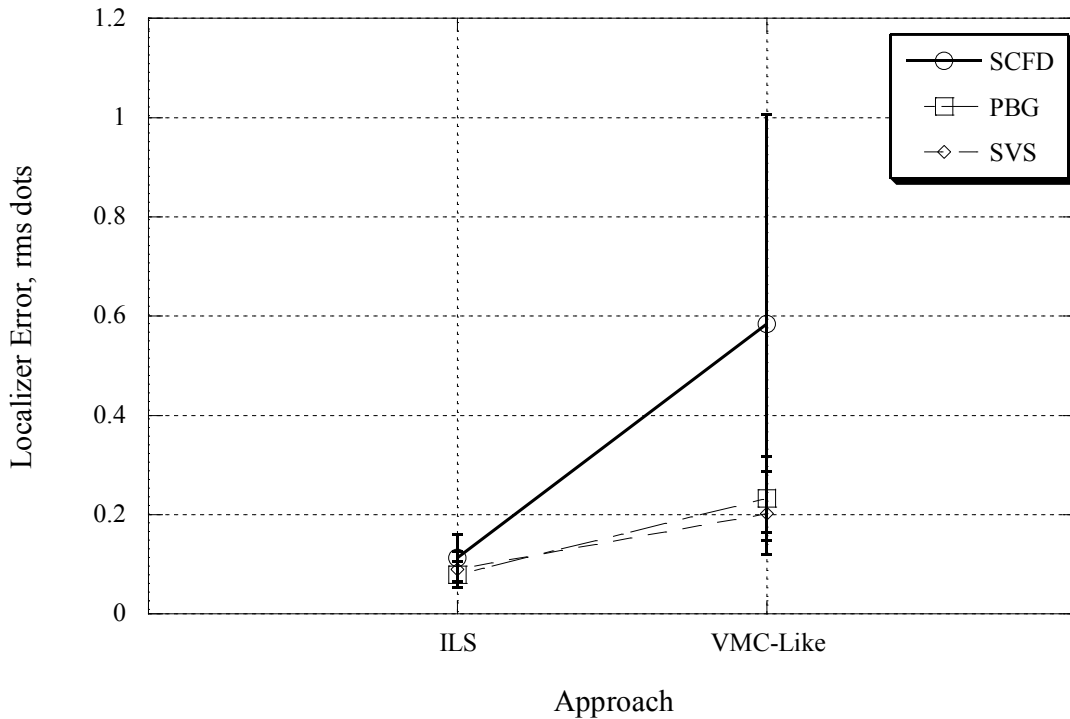

Figure 18: Localizer Error, Segment 3 for ILS and VMC-Like Approaches, All Pilots

4.6.5 ILS and VMC-Like approach analysis, Segment 3, all pilots

Figures 16 and 17 show a visual comparison of localizer error results for the ILS and VMC-like approaches, respectively. Note that in Figure 17 a large increase in localizer error is shown for the SCFD display concept. This large increase in localizer error was due to the turning nature of the VMC-like approach and the general lack of turn anticipation of the SCFD display concept (even though desired flight path information was provided on the ND). An ANOVA was conducted on the localizer error data for all pilots for Segment 3 of the ILS and VMC-like approaches to compare and contrast each advanced display concept as well as to assess the capabilities of advanced display concepts to support advanced IMC operations. The ANOVA analysis indicated that approach ($F(1, 111)=56.034, p<0.01$) and display concept ($F(2,111)=15.733, p<0.01$) were highly significant and pilot type was not significant for this measure. The lack of effect due to pilot type is important and indicates that all types of pilots performed the ILS and VMC-like approaches similarly with the advanced display concepts with respect to localizer error. This result was not the case for the ILS evaluations of the BRD display concept, as shown in Figure 16. There was also a significant interaction between display concept and approach ($F(2,111)=12.071, p<0.01$) for localizer error. As can be seen in Figures 16, and 17 and Table 48, localizer error results for the ILS approach were lower than for the VMC-like approach.

Table 48: Mean and Standard Deviation for Localizer Error (dots) for the ILS and VMC-Like Approach, All Pilots

Approach	Mean	Standard Deviation
ILS	0.09	0.04
VMC-Like	0.34	0.30

Figures 16 and 17 and Table 49 also show the effect of display concept for the ILS and VMC-like approaches. It can be seen that the higher (worse) results were for the SCFD. Results for the SCFD were approximately twice as large as those for the PBG and SVS display concepts. This result was most likely due to the lack of turn anticipation for the SCFD display concept that was an issue for Segment 3 of the VMC-like approach and Segment 2 of the ILS approach. Frequently, EPs would overshoot the base leg and/or final approach and in doing so they exceeded the IFR PTS criteria.

Table 49: Mean Localizer Error (dots) SNK results, ILS and VMC-Like Approach for all Pilots

Display Concept	Number of Data Points	Subset	
		1	2
SVS	40	0.14	
PBG	35	0.16	
SCFD	36		0.34
Significance		0.623	1.000

The interaction between approach and display concept can be seen by comparing Figures 16 and 17 and Table 50. Mean localizer error increased for all display concepts for the VMC-like approach as compared to the ILS approach. However, a much larger increase was experienced for the SCFD display concept than for the PBG or SVS display concepts. Localizer error increased by factors of 5.2, 2.9, and 2.3 for the SCFD, PBG, and SVS display concepts, respectively, for the VMC-like approach as compared to the ILS approach. As stated previously, the lack of turn anticipation of the SCFD appears to be the reason for the much larger increase in localizer error for this display concept, yielding results that exceeded those generated by IFR and H-IFR pilots flying the BRD display concept for the ILS approach (i.e., 0.39 dots).

Increases in localizer error due to approach type differences, as described by the ratio of localizer error for the VMC-like to ILS approach, were much larger than lateral flight path error under the same conditions. This discrepancy between localizer error and lateral flight path error results was due to the fact that there were two turns included in the VMC-like approach occurring at different ranges to touchdown. In essence, localizer error can be described as range-weighted lateral flight path error with more emphasis placed on errors closer to touchdown. Lateral flight path errors during the turn to final for the VMC-Like approach generated larger localizer errors than for the turn to base leg.

Figures 16 and 17 and Table 49 indicate that, for the VMC-like approach, the increase in localizer error for the SVS display concept was smaller than for the PBG display concept. While this was not statistically significant, it does suggest that the increase of SA provided by the SVS terrain may actually help pilots negotiate the turns of the VMC-like approach. Overall, localizer error results would suggest that the VMC-like approach is feasible, but only for the PBG and SVS display concepts.

Table 50: Mean and Standard Deviation Results for Localizer Error (dots) for the ILS and VMC-Like Approach for all Pilots

Display Concept	Approach	Mean	Standard Deviation
SCFD	ILS	0.113	0.047
	VMC-Like	0.584	0.421
PBG	ILS	0.079	0.026
	VMC-Like	0.233	0.085
SVS	ILS	0.089	0.033
	VMC-Like	0.202	0.084

4.6.6 Test condition analysis, Segment 3

An ANOVA was performed on localizer error for TC with post-hoc results presented in Table 51. Test Condition was revealed to be highly significant for localizer error results ($F(12,220)=37.76$, $p<0.01$). Post-hoc analysis only generated two unique subsets. The highest (worst) subset was TC 1, VFR approach with BRD display concept, which had significantly higher localizer error than all other display concept and approach combinations evaluated. This result is again not surprising since pilots used only the out-the-window view for navigation. There were no significant localizer error differences among the other TCs and those mean localizer errors covered a range from 0.584 dots (TC 9) to 0.079 dots (TC 7). TC 7 (ILS approach with PBG display concept) localizer error was only 13.5% of the localizer error for TC 9 (VMC-like approach with SCFD display concept). Comparing TC 5 (ILS approach with BRD display concept) with the other TCs shows that all evaluations by all pilots of the advanced display concepts resulted in lower localizer error for the ILS and VMC-like approaches, except for TC 9 (VMC-like approach with SCFD display concept). This result, again, is probably due to the lack of turn anticipation of the SCFD. Another substantial result was that even though IMC evaluations of the PBG and SVS display concept included VFR pilot data (TCs 7, 8, 10, and 11), the resulting localizer error was less than for the BRD display concept for the ILS with only IFR and H-IFR pilot data. Results for only the VFR pilots for the SVS display concept evaluations for the ILS and VMC-like approaches were also less than TC 5. The localizer error data suggest that advanced IMC operations, such as the VMC-like approach, are feasible with the PBG and SVS advanced display concepts tested, but not for the SCFD display concept.

Table 51: Mean Localizer Error (dots) SNK results for Test Condition

Test Condition	TC #	Number of Data Points	Subset	
			1	2
ILS Approach + PBG	7	16	0.079	
ILS Approach + SVS	8	21	0.089	
ILS Approach + SVS (VFR pilots)	12	6	0.092	
ILS Approach + SCFD	6	18	0.113	
VMC-Like Approach + SVS	11	19	0.202	
VFR Approach + PBG	3	18	0.226	
VMC-Like Approach + PBG	10	19	0.233	
VMC-Like Approach + SVS (VFR pilots)	13	6	0.239	
VFR Approach + SVS	4	18	0.260	
ILS Approach + BRD (no VFR pilots)	5	19	0.391	
VFR Approach + SCFD	3	19	0.536	
VMC-Like Approach + SCFD	9	18	0.584	
VFR Approach + BRD	1	24		4.036
Significance			0.888	1.000

4.7 Glideslope Error

Comparison of glideslope error results for the various display concepts and approaches is also valuable in a similar manner to localizer error (i.e., linear vertical error comparisons favor the advanced display concepts since their guidance cues are not affected by range to touchdown). In addition, glideslope error analysis and comparisons are valuable due to the linkages with traditional IMC operations. Glideslope error results for the four display concepts and two simulated-IMC approaches are presented in Figures 19, 20, 21, and 22 and Table 52. Note that the glideslope error results for the VFR approach are not plotted in Figure 22 for plotting clarity reasons.

Table 52: Glideslope Error (dots) Descriptive Statistics for all Pilots

Display Concept	Approach	Mean	Standard Deviation	Number of Data Points
BRD	VFR	1.24	0.88	24
	ILS	0.89	0.66	30
	Total	1.05	0.78	54
SCFD	VFR	0.32	0.25	19
	ILS	0.16	0.07	18
	VMC-Like	0.30	0.17	18
	Total	0.26	0.19	55
PBG	VFR	0.33	0.14	18
	ILS	0.24	0.11	16
	VMC-Like	0.42	0.23	19
	Total	0.34	0.18	53
SVS	VFR	0.47	0.38	18
	ILS	0.21	0.09	21
	VMC-Like	0.32	0.11	19
	Total	0.33	0.25	58
Total	VFR	0.63	0.66	79
	ILS	0.45	0.52	85
	VMC-Like	0.35	0.18	56
	Total	0.49	0.53	220

4.7.1 VFR approach, all pilots

As can be seen in Figure 19 and Table 52, the VFR approach evaluation of the BRD display concept resulted in larger glideslope error values compared to the advanced display concepts. This result is most likely due to the nature of the EPs flight path navigation being driven totally by the out-the-window view for the BRD display concept along with altimeter checks at the turn to final from the base leg. Altimeter information included in the BRD display concept helped to keep the mean glideslope error to only 1.24 dots. The apparent increases in glideslope error with decreasing range to touchdown was due to the fact that vertical flight path error remained relatively constant throughout the VFR approaches with the advanced display concepts as range decreased. An ANOVA conducted on the glideslope error results for the main effects of display concept and pilot type revealed highly significant results for display concept ($F(3,79)=21.5, p<0.01$) and non-significant results for pilot type ($p>0.05$). Subsequent post-hoc analysis

resulted in two subsets, as shown in Table 53. As expected, the BRD was the sole member of the worst subset, and the advanced display concepts comprised the best subset. Note that glideslope error for the SVS display concept was 0.14 dots worse than the PBG. This may be attributed to the evaluation pilots frequently comparing the outside visual scene to that provided by the SVS terrain and paying slightly less attention to the guidance cues.

Table 53: Mean Glideslope Error (dots) SNK results for Display Concept for the VFR Approach for all Pilots

Display Concept	Number of Data Points	Subset	
		1	2
SCFD	19	0.32	
PBG	18	0.33	
SVS	18	0.47	
BRD	24		1.235
Significance		0.55	1.000

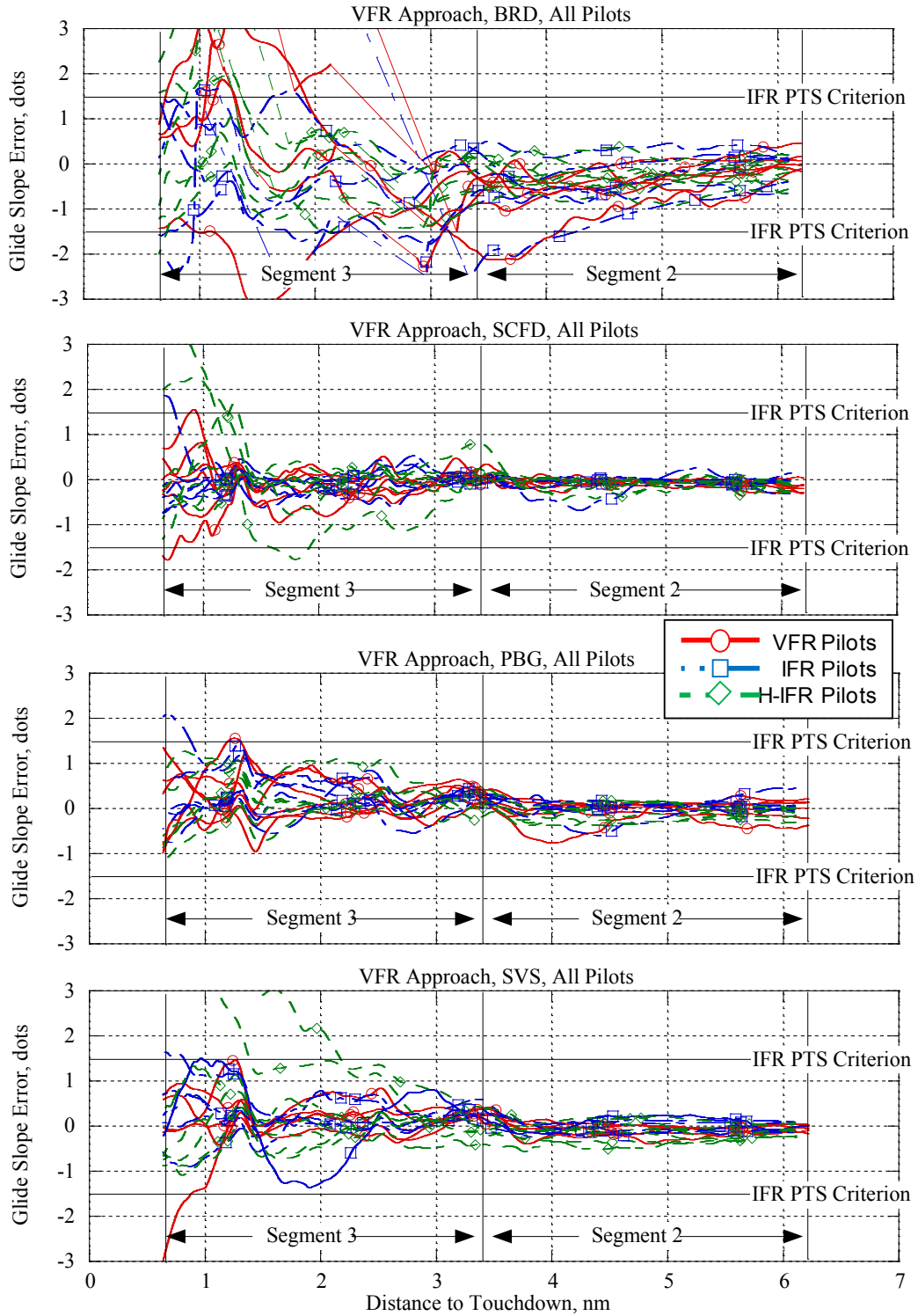

Figure 19: VFR Approach, Glideslope Error, By Display Concept and Pilot Group

4.7.2 ILS approach, all pilots

For the ILS approach for all pilots, the glideslope error decreased for all display concepts compared to the VFR approach, as can be seen by comparing Table 54 with Table 53 and by comparing Figures 19 and 20. Figure 20 shows glideslope error for the four display concepts for all pilots for the ILS approach. Note that glideslope error results for the BRD display concept occasionally exceeded the IFR PTS criteria. While most of the evaluations that exceeded the IFR PTS criteria were for VFR pilots flying with the BRD display concept, one was for an H-IFR EP. Figure 20 also shows that results for the advanced display concepts were all well within the IFR PTS criteria. A slight decrease in glideslope error is also visible for the SVS compared to the PBG display concept, potentially indicating the effect of SVS terrain to improve glideslope error. An ANOVA conducted on the glideslope error results for the main effects of display concept and pilot type revealed highly significant results for display concept ($F(3,85)=20.8, p<0.01$) and non-significant results for pilot type ($p>0.05$). There were no significant interactions. The lowest glideslope error was for the SCFD display concept (0.16 dots) and the highest was for the BRD display concept (0.89 dots). The advanced display concepts had a range of glideslope error results of approximately 0.16 to 0.24 dots and were included in the lowest (best) subset, while the BRD was the only member of the higher (worst) subset. This result was expected due to the integrated nature of the advanced display concepts along with their guidance cues. The inclusion of the VFR pilot data also degrades the results for the BRD display concept.

Table 54: Mean Glideslope Error (dots) SNK results for Display Concept, ILS Approach for all Pilots

Display Concept	Number of Data Points	Subset	
		1	2
SCFD	18	0.16	
SVS	21	0.21	
PBG	16	0.24	
BRD	30		0.89
Significance		.779	1.000

While results were not statistically significant for pilot type, post-hoc analysis did produce two subsets as shown below in Table 55. There was a 0.27 dot difference in glideslope error for the VFR pilots compared to the mean for the H-IFR and IFR pilots for all displays tested. Figure 20 shows that much of the difference in glideslope error due to pilot type was likely due to the BRD display concept.

Table 55: Mean Glideslope Error (dots) SNK results for Display Concept, VFR Approach for all Pilots

Pilot Type	Number of Data Points	Subset	
		1	2
H-IFR	27	0.32	
IFR	29	0.39	
VFR	29		0.62
Significance		0.475	1.000

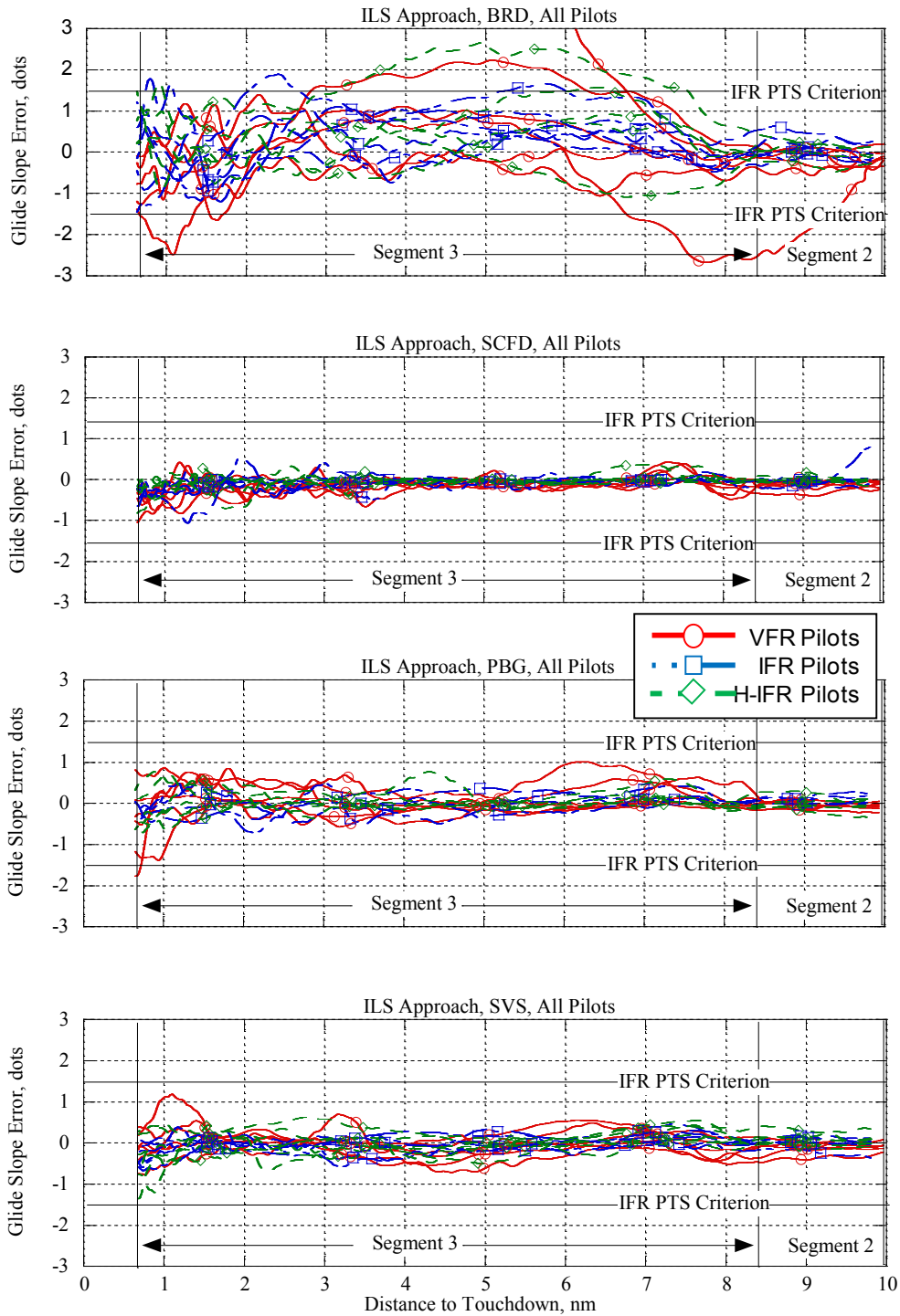

Figure 20: ILS Approach, Glideslope Error, By Display Concept and Pilot Group

4.7.3 VMC-Like approach

Unlike localizer error results, Figure 21 shows that glideslope error was fairly similar for all three advanced display concepts for the VMC-like approach. However, the worst results were for the PBG display concept with several excursions above the PTS criteria evident in Figure 21 during the final approach leg (approximately 1.8 nm to the 0.66 nm). An ANOVA conducted on the glideslope error data for the VMC-like approach for the main effects of display concept and pilot type revealed significant results for display concept ($F(2,56)=3.52$, $p=0.04$) and non-significant results for pilot type ($p>0.05$). There was no significant interaction between display concept and pilot type. Subsequent post-hoc analysis resulted in two subsets, as shown in Table 56. However, in this case the highest (worst) subset-group was comprised of only the PBG display concept, with the SVS display concept being grouped with the SCFD in the lowest (best) subset. Part of this result is due to the improved vertical flight path error control of the single-cue flight director compared to the HITS guidance discussed previously. However, for glideslope results, the inclusion of the SVS terrain with the HITS guidance significantly reduced glideslope error by 0.10 dots compared to the PBG display concept. This reduction of the glideslope error resulted in the SVS display concept grouping with the SCFD. The fact that this is significant here as opposed to the vertical flight path error is likely due to the range-weighted nature of glideslope error combined with the increased presence of the SVS terrain with runway models on final approach.

Vertical flight path errors generate larger glideslope errors as range to the runway touchdown zone decreases. As a result glideslope error is more sensitive to vertical error during the last several miles during final approach than at the beginning of the approach. If results for vertical flight path error varied similarly during the approach for all display concepts, then statistical analysis results for vertical flight path and glideslope errors would produce similar SNK groupings. However, as shown in Tables 84 (vertical flight path error) and 56 (glideslope error) the SVS display grouped in the worst group for vertical flight path error and in the best group for glideslope error. In order for this to occur, vertical flight path error results had to decrease during the approach for the SVS display concept more than the SCFD and PBG display concepts. The distribution of vertical flight path and glideslope errors can be seen in Figures 33 and 21. From Figure 33, it can be observed that vertical flight path error for the SVS display concept appears to become similar to the SCFD as range to touchdown decreases. Results for the PBG display concept appear to remain constant and even increase during the last 1.5 nm of the approach. From Figure 21, it can be seen that the glideslope error results for the SVS display closely resemble those for the SCFD and remain within IFR PTS criteria throughout the approach. Figure 21 also reveals that results for the PBG display concept not only increased but exceeded IFR PTS criteria during the last 1.5 nm of the approach. It is considered that the ability to integrate information is different for the VFR, IFR, and H-IFR pilots groups. Pilot training associated with achieving an IFR pilot rating combined with thousands of hours of actual IMC flight time develops the ability to integrate information provided by separate displays. While PFDs provide information in a more integrated manner than the BRD, the background SVS terrain further facilitates the pilots' ability to mentally process the data. Results for pilot type were not significant for this analysis, however, from Figure 21 it can be seen that the VFR pilots and one of the IFR pilots were having difficulty remaining within the PTS criteria with the PBG display concept. Glideslope error results for the SVS display concept reveal similar performance for all pilot groups. Again, it is believed that the SVS terrain serves as an integrator of other information allowing all pilot groups to achieve not only superior situation awareness but also improved performance.

Table 56: Mean Glideslope Error (dots) SNK results for Display Concept, VMC-Like Approach for all Pilots

Display Concept	Number of Data Points	Subset	
		1	2
SCFD	18	0.30	
SVS	19	0.32	
PBG	19		0.42
Significance		0.675	1.000

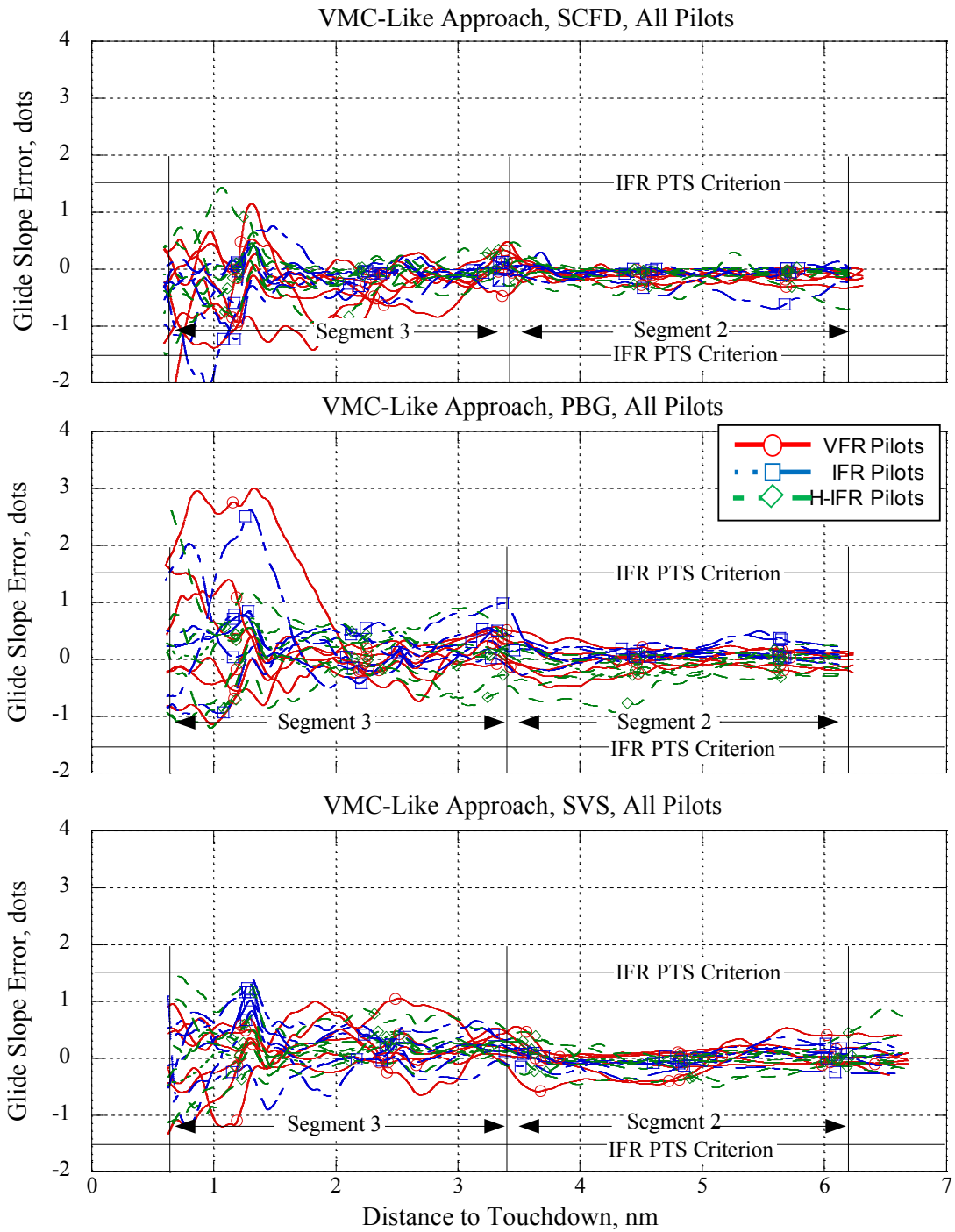

Figure 21: VMC-Like Approach, Glideslope Error, By Display Concept and Pilot Group

4.7.4 ILS approach, Segment 3, no VFR pilots

Results for glideslope error were analyzed without the VFR pilot data, enabling a more direct comparison of the four display concepts within current IMC operations. Results from an ANOVA revealed that display concept was highly significant ($F(3,56)=16.68$, $p<0.01$) and that pilot type (i.e., IFR or H-IFR) was not significant ($p>0.05$). In addition, there were no significant interactions between pilot type and display concept. Subsequent post-hoc analysis produced two unique subsets, as shown in Table 57. With a mean of 0.76 dots error, the BRD display concept had significantly higher glideslope error than the advanced display concepts. There were no significant glideslope error differences among the SCFD, SVS, and PBG concepts. The average mean glideslope error for the advanced display concepts was approximately one quarter of glideslope error for the BRD display concept. These results are visually supported by Figure 20. Again, as with localizer error, the reduction in glideslope error for the advanced display concepts may support reductions in the amount of airspace required for ILS approaches with the advanced display concepts. As discussed previously for vertical flight path error results, while other limitations may apply, obstacle clearance margins could be reduced by a factor of four. Note that the baseline minimum required level of glideslope error defined by the IFR and H-IFR BRD pilot data for the test herein is 0.76 dots.

Table 57: Mean Glideslope Error (dots) SNK results for the ILS Approach, IFR and H-IFR Pilots

Display Concept	Number of Data Points	Subset	
		1	2
SCFD	12	0.14	
SVS	15	0.20	
PBG	10	0.21	
BRD	19		0.76*
Significance		0.759	1.000

*Note: This value is used herein as the baseline performance for an ILS Approach

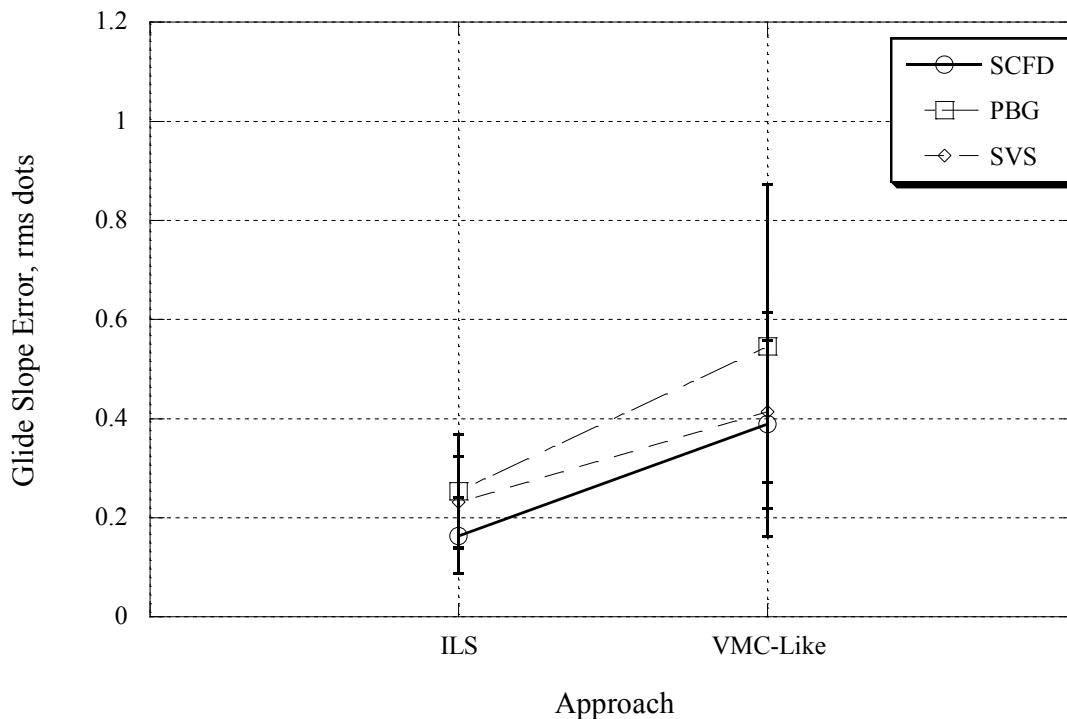

Figure 22: Glideslope Error For Segment 3, for Approaches 2 and 3, All Pilots

4.7.5 ILS and VMC-Like approach analysis, Segment 3, all pilots

Comparison of Figures 20 and 21 provides a visual indication of the effect of approach and display concept for the advanced display concepts and the ILS and VMC-like approaches. From these figures, it can be seen that glideslope error increased for all the advanced display concepts, with the largest increase for the PBG display concept. While the HITS guidance concept provided a good blending of lateral and vertical flight path error performance overall, the VMC-like evaluation of the PBG display concept resulted in higher levels of glideslope error with several evaluations exceeding the IFR PTS criteria. Figure 21 appears to indicate that the presence of the SVS background limited the increase in glideslope error for the SVS display concept while flying the VMC-like approach from 2.0 nm to the end of the approach.

An ANOVA was performed on the glideslope error data for all pilots for segment 3, for the ILS and VMC-like approaches for the main effects of pilot type, display concept, and approach to assess the capabilities of advanced display concepts to support advanced IMC operations. The ANOVA analysis revealed that approach ($F(1,111)=60.084$, $p<0.01$) was highly significant and that display concept ($F(2,111)=4.729$, $p=0.011$) and pilot type ($F(2,111)=3.220$, $p=0.045$) were also significant but at lower levels. Unlike most of the previous analysis for the ILS and VMC-like approaches, pilot type was significant for this analysis. There were no significant interactions. Subsequent post-hoc analysis generated two unique subsets for display concept, as shown in Table 58, but no subsets for pilot type. The PBG display concept had significantly higher glideslope error compared to the SVS and SCFD display concepts. There were no significant glideslope error differences between the SVS and SCFD

concepts. This result reflects the inclusion of SVS terrain information in the SVS display concept, which appears to have significantly reduced glideslope error compared to the PBG display concept. Much of this result was due to the superior performance, or lack of substantial degradation of performance, for the VFR pilots for the VMC-like approach with the SVS display concept. The integration of SVS terrain with HITS guidance symbology most likely produced an environment where the VFR evaluation pilots were able to perform the VMC-like approach as well as the other pilot groups.

During initial system checkout, several pilots evaluated the research displays during the checkout flights to determine if the flight test implementation was similar to what was implemented in the simulation. Pilots were asked to provide qualitative inputs regarding flight path tracking error performance and workload. Flight path and angular errors gains of the SCFD were adjusted to achieve representative performance. The gains used for the research flights are listed in Appendix A.

As implemented for this flight test, the SCFD provided significantly improved glideslope error results compared to the PBG display concept. This was due to the single-cue flight director drive equations combined with the prominent display of pitch attitude commands on the SCFD display that provided a large emphasis on vertical error control. Results for glideslope error for the PBG and SVS display concepts could potentially be improved through adjustment of the tadpole guidance cue (see Appendix B for description of guidance cue). For this study, the tadpole guidance cue was located along the desired flight path 15 seconds in front of ownship. This timing parameter was established from work with large transport-type aircraft (Reference 8) and could potentially be reduced for GA applications. Having the guidance cue located closer to ownship would help to reduce flight path error. Overall, the guidance cue of the HITS symbology was designed to provide a good blending of lateral and vertical error control, which it accomplished. It provided much better results than the SCFD, when considering combined lateral and vertical errors, SA, and TLX, and DRR results.

Table 58: Mean Glideslope Error (dots) SNK results for the ILS and VMC-Like Approaches for all Pilots

Display Concept	Number of Data Points	Subset	
		1	2
SCFD	36	0.28	
SVS	40	0.31	
PBG	35		0.41
Significance		0.334	1.000

The interactions between display concept and pilot type are illustrated in Figures 20 and 21 and Table 59. It can be seen that the VFR pilots performed worse in terms of glideslope error than the IFR and H-IFR pilots for all display concepts with VFR pilot data being worse than the data from the other two pilot groups. However, the level of increase of glideslope error for the VFR pilots compared to the average of the means of the IFR and H-IFR pilots data was not the same for all display concepts, with increases of 0.12, 0.09, and 0.04 dots for the SCFD, PBG, and SVS display concepts, respectively. The increase in glideslope error for the VFR pilots for the SVS display concept was only approximately one third to one half of the increase for the SCFD and PBG display concepts. This lower level of increase for the SVS display concept is likely due to the presence of the SVS terrain providing the VFR pilots with SA unavailable for the other advanced display concepts due to the simulated-IMC test conditions.

Table 59: Statistical Interaction Results for Glideslope Error (dots) for Display Concept and Pilot Type for the ILS and VMC-Like approaches

Display Concept	Pilot Type	Mean	Standard Deviation	Number of Data Points
SCFD	VFR	0.36	0.21	12
	IFR	0.25	0.22	12
	H-IFR	0.23	0.17	12
	Total	0.28	0.20	36
PBG	VFR	0.47	0.39	12
	IFR	0.41	0.25	10
	H-IFR	0.36	0.20	13
	Total	0.41	0.29	35
SVS	VFR	0.34	0.17	12
	IFR	0.28	0.16	14
	H-IFR	0.32	0.14	14
	Total	0.31	0.15	40
Total	VFR	0.39	0.27	36
	IFR	0.31	0.21	36
	H-IFR	0.30	0.18	39
	Total	0.33	0.23	111

Table 60 shows the glideslope error results for the advanced display concepts for each IMC approach. As stated previously, the largest increase in glideslope error was for the PBG display concept, which experienced a 0.29 dot increase for the VMC-like approach vs. the ILS approach. The smallest increase in glideslope error was for the SVS display concept with a 0.19 dot increase for the VMC-like approach. This positive result for the SVS display concept glideslope error was primarily because the VFR pilots performed much better using the SVS display concept for the VMC-like approach than they did using other display concepts. Overall, glideslope errors for all display concepts for the VMC-like approach were less than the ILS evaluation of the BRD display concept for the IFR and H-IFR pilots (i.e., 0.76 dots), indicating that the VMC-like approach may be feasible for these display concepts.

Table 60: Statistical Interaction Glideslope Error (dots) Data for Display Concept and Approach for the ILS and VMC-Like Approaches

Display Concept	Approach	Mean	Standard Deviation	Number of Data Points
SCFD	ILS	0.16	0.08	18
	VMC-Like	0.39	0.23	18
	Total	0.28	0.20	36
PBG	ILS	0.25	0.11	16
	VMC-Like	0.55	0.33	19
	Total	0.41	0.29	35
SVS	ILS	0.22	0.09	21
	VMC-Like	0.41	0.14	19
	Total	0.31	0.15	40
Total	ILS	0.21	0.10	55
	VMC-Like	0.45	0.25	56
	Total	0.33	0.23	111

4.7.6 Test condition analysis, Segment 3

An ANOVA was performed on glideslope error for TC with post-hoc results presented in Table 61. TC was highly significant for glideslope error results ($F(12,220)=14.266, p<0.01$). Post-hoc analysis of the glideslope error generated two unique subsets. The VFR approach with the BRD (TC 1) had significantly higher glideslope error than all other approach and display concept combinations tested. Most likely, this result is because the pilots used the out-the-window method of navigation. No significant differences were seen in this test. All of the other TCs were grouped into one subset, and they had a range of mean RMS glideslope errors of approximately 0.6 dots (from 0.163 dots to 0.760 dots). TC 6 (ILS approach with SCFD display concept) yielded the lowest glideslope error of 0.16 dots. Test Condition 5 (ILS approach with the BRD display concept, no VFR pilots) had the highest glideslope error of 0.76 dots for this subset, which was 4.7 times larger than the result for TC 6. Overall, all IMC evaluations of the advanced display concepts (TC 6, 7, 8, 9, 10, and 11) yielded lower glideslope errors than TC 5, including the IMC VFR-only pilot evaluations of the SVS display concept (TC 12 and 13). This result indicates that the advanced display concepts provided all pilot types the ability to control glideslope error as well or better than the current baseline standard (BRD display concept for the ILS approach for IFR and H-IFR pilots) employed in this test. The VFR approach results for the advanced display concepts (i.e., TC 2, 3, and 4) were also as good or better than TC 5, even though EPs were performing out-the-window navigation combined with cross checking from their displays.

Table 61: Mean Glideslope Error (dots) SNK results for Test Condition

Test Condition	TC #	Number of Data Points	Subset	
			1	2
ILS Approach + SCFD	6	18	0.163	
ILS Approach + SVS	8	21	0.220	
ILS Approach + PBG	7	16	0.254	
ILS Approach + SVS (VFR pilots)	12	6	0.272	
VMC-Like Approach + SCFD	9	18	0.388	
VMC-Like Approach + SVS (VFR pilots)	13	6	0.406	
VMC-Like Approach + SVS	11	19	0.414	
VFR Approach + SCFD	2	19	0.416	
VFR Approach + PBG	3	18	0.426	
VMC-Like Approach + PBG	10	19	0.546	
VFR Approach + SVS	4	18	0.629	
ILS Approach + BRD (no VFR pilots)	5	19	0.760	
VFR Approach + BRD	1	24		1.840
Significance			0.177	1.000

4.8 Indicated Airspeed Error

Airspeed error is valuable to describe the differences between the display concepts, approaches, and pilot types. It can be viewed as a consistent measure of pilot awareness, since the task of controlling airspeed is similar from one approach to the next. Airspeed results are presented in Figures 23, 24, and 25 for the VFR, ILS, and VMC-like approaches, respectively. Figure 26 along with Tables 62 and 63 present mean RMS airspeed error results. Recall that for Segment 2, pilots were asked to maintain 100 kts and then decelerate and change speed to 90 kts for Segment 3. Due to limitations in data processing, airspeed errors are only presented separately for Segment 2 and Segment 3 of the approaches evaluated.

Table 62: IAS Error (kts) Descriptive Statistics for Segment 2 for all Pilots

Display Concept	Approach	Mean	Standard Deviation	Number of Data Points
BRD	VFR	4.6	1.5	24
	ILS	5.0	2.3	30
	Total	4.9	2.0	54
SCFD	VFR	4.7	1.9	19
	ILS	5.8	2.9	18
	VMC-Like	4.6	2.4	18
	Total	5.0	2.4	55
PBG	VFR	3.9	2.3	18
	ILS	4.4	3.2	16
	VMC-Like	4.5	2.1	19
	Total	4.3	2.5	53
SVS	VFR	3.6	1.9	18
	ILS	4.5	1.6	21
	VMC-Like	4.6	2.6	19
	Total	4.3	2.1	58
Total	VFR	4.3	1.9	79
	ILS	5.0	2.5	85
	VMC-Like	4.6	2.3	56
	Total	4.6	2.4	220

Table 63: IAS Error (kts) Descriptive Statistics for Segment 3 for all Pilots

Display Concept	Approach	Mean	Standard Deviation	Number of Data Points
BRD	VFR	3.6	1.4	24
	ILS	5.9	2.5	30
	Total	4.9	2.3	54
SCFD	VFR	5.6	2.2	19
	ILS	6.3	2.9	18
	VMC-Like	6.1	2.2	18
	Total	6.0	2.4	55
PBG	VFR	5.0	1.6	18
	ILS	5.6	2.1	16
	VMC-Like	6.1	2.9	19
	Total	5.6	2.3	53
SVS	VFR	5.7	2.1	18
	ILS	5.6	2.1	21
	VMC-Like	5.4	1.6	19
	Total	5.6	1.9	58
Total	VFR	4.9	2.0	79
	ILS	5.8	2.4	85
	VMC-Like	5.9	2.3	56
	Total	5.5	2.3	220

4.8.1 VFR approach all pilots, S2 and 3

As can be seen from Figure 23 and Tables 62 and 63, the difference in airspeed error for the BRD and the advanced display concepts was much less pronounced than for other data measures discussed previously. The BRD display concept produced less error than the other display concepts as shown in Figure 23 where the pilots were able to maintain airspeed well within the +/-10 kts PTS criterion most of the time. The difference in IAS error between the BRD and advanced display concepts was likely related to the manner in which airspeed was presented to the pilot and also the content and use of that information for the advanced display concepts. For the BRD display concept, airspeed was a simple gauge that pilots looked at for current airspeed (position) and trend information (rate of movement). For the advanced display concepts, current airspeed was presented digitally on the airspeed tape, which also provided airspeed rate information (tape movements, acceleration trend line). The acceleration arrow on the velocity vector also provided airspeed rate information for the PBG and SVS display concepts (see Figure 6). ANOVAs conducted on Segment 2 and 3 IAS errors for the main effects of display concept and pilot type resulted in non-significant results for Segment 2, but highly significant results for display concept ($F(3,79)=6.65, p<0.01$) for Segment 3. Subsequent post-hoc results are shown in Table 64, where it can be seen that two unique subsets were formed. The lowest (best) subset was comprised only of the BRD display concept with the advanced display concepts being included within the highest (worst) subset. IAS error was 1.4 kts less for the BRD display concept compared to the PBG, and 2.2 kts less compared to the SVS display concept. These results show that the round-dial method of airspeed presentation may be superior to the integrated digital readouts and tapes of the advanced display concepts

for the VFR approach where a relatively low number of disparate pieces of information need to be integrated (i.e., out-the-window-view, airspeed, and altitude).

Table 64: Mean IAS Error (kts) SNK results for the VFR Approach, Segment 3 for all Pilots

Display Concept	Number of Data Points	Subset	
		1	2
BRD	24	3.6	
PBG	18		5.0
SCFD	19		5.6
SVS	18		5.7
Significance		1.000	0.37

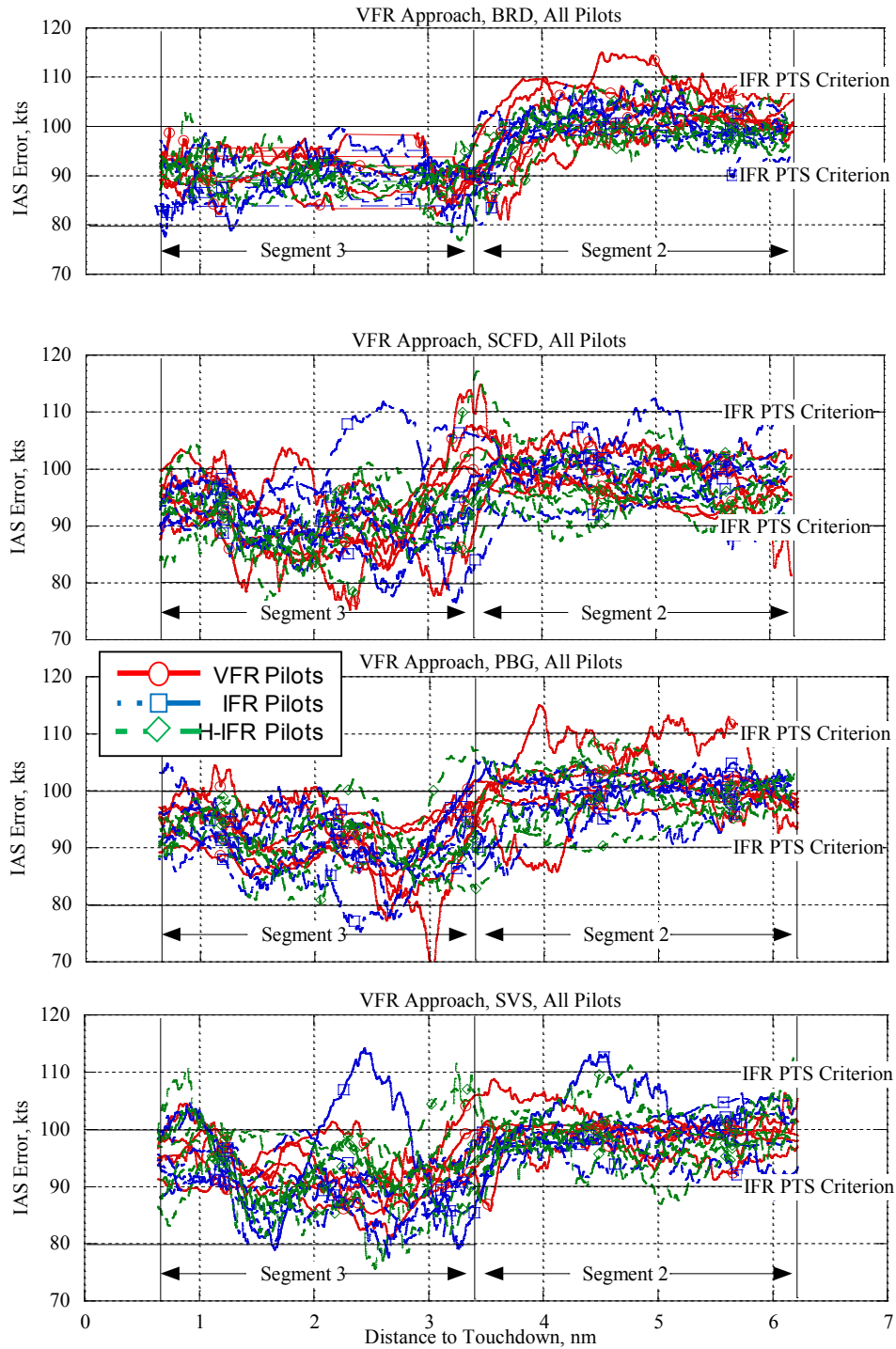

Figure 23: VFR Approach, IAS Performance for All Pilots and Display Concepts

4.8.2 ILS approach, all pilots, Segments 2 and 3

Figures 23 and 24 and Tables 62 and 63 provide a visual comparison of airspeed control performance for the VFR and ILS approaches, respectively. For the ILS approach for all pilots, IAS error increased for all display concepts except for the SVS display concept compared to the VFR approach. The largest increase was for the BRD display concept with an increase of 2.3 kts (Segment 3). The advanced display concepts led to much lower increases of IAS error for the ILS approach compared to the VFR approach. IAS error increased 0.7 kts and 0.4 kts for the SCFD and PBG display concepts, respectively. IAS error actually decreased for the SVS display concept for the ILS approach, but only slightly, 0.1 kts. The fact that IAS error increased much more for the BRD display concept than for the advanced display concepts indicates that while the IAS gauge potentially provided improved airspeed awareness compared to the integrated airspeed tapes of the advanced display concepts, it was integrated within the BRD display concept, resulting in increased overall workload. This resulted in a larger effect of approach in IAS error for this display concept. An ANOVA conducted on the IAS error for Segments 2 and 3 revealed that pilot type was significant for Segment 2 ($F(2,85)=4.76$, $p=0.012$) and Segment 3 ($F(2,85)=4.45$, $p=0.016$) and non-significant for display concept. The interaction between display concept and pilot type was not statistically significant. Tables 65 and 66 show the results from the SNK post-hoc analysis and that the VFR pilots had significantly worse IAS error than the IFR or H-IFR pilots. While the results presented in Tables 65 and 66 indicate a significant difference between the VFR and IFR/H-IFR pilots, the increased IAS error for the VFR pilots was not the same for all display concepts. Table 67 provides the IAS error increase for the VFR pilots compared to the average of the IFR and H-IFR pilots for all of the display concepts. From Table 67, it can be seen that the increase of IAS error for the VFR pilots was lower for the SVS display concept compared to all the others, which could reflect the lower workload and increased situation awareness of the SVS display concept. While the statistical analysis revealed no significant interactions between display concept and pilot type, results provided in Table 67 do show a trend in the data that indicates that the degraded VFR-pilot IAS error control was mitigated for the SVS display concept.

Table 65: Mean IAS Error (kts) SNK results for the ILS Approach, Segment 2 for all Pilots

Pilot Type	Number of Data Points	Subset	
		1	2
H-IFR	27	3.9	
IFR	29	4.9	
VFR	29		6.2
Significance		0.115	1.000

Table 66: Mean IAS Error (kts) SNK results for the ILS Approach, Segment 3 for all Pilots

Pilot Type	Number of Data Points	Subset	
		1	2
IFR	29	5.1	
H-IFR	27	5.7	
VFR	29		6.8
Significance		0.264	1.000

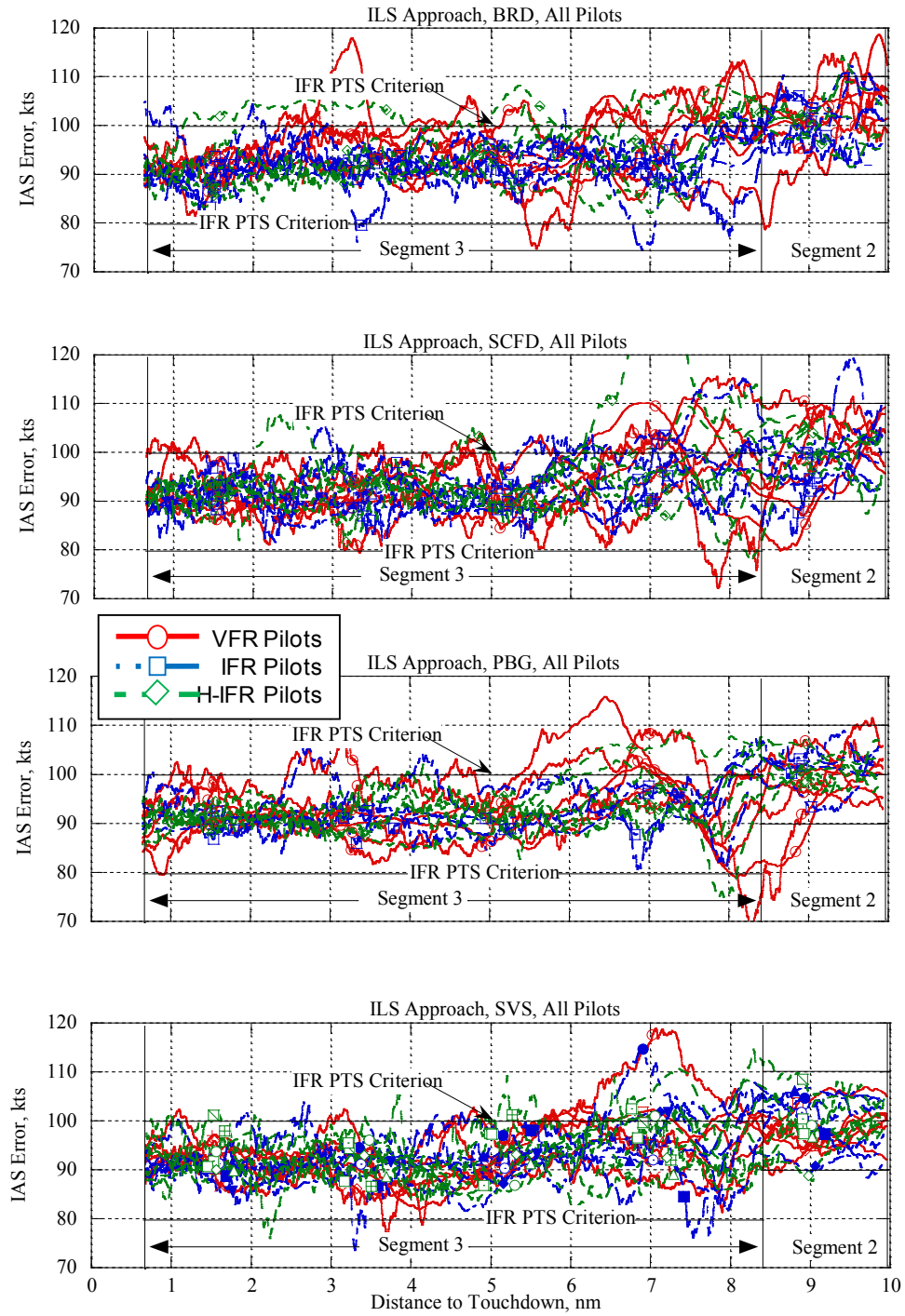

Figure 24: ILS Approach, IAS Performance for All Pilots and Display Concepts

Table 67: Increase in mean IAS Error (kts) for the VFR Pilots Compared to the Average of the IFR and H-IFR Pilots for the ILS Approach, Segments 2 and 3

Display Concept	Segment	
	2	3
BRD	1.9	1.9
SCFD	2.4	1.0
PBG	3.5	1.6
SVS	0.2	0.9

4.8.3 ILS approach, Segment 3, no VFR pilots

Results for IAS error were analyzed without the VFR pilot data, enabling a more direct comparison of the four display concepts within current IMC operations. Results from an ANOVA with display concept and pilot type as main effects revealed no significant ($p > 0.05$) differences for IAS error for either the main effects or their interactions for segment 2 or segment 3. Although not statistically significant, H-IFR pilots controlled IAS approximately 1.0 kts better than the IFR pilots for Segments 2 and 3. Table 68 shows the mean IAS error for the ILS approach without the VFR pilot data. The lowest IAS error was for the PBG display concept for both segments and the worst was for the SCFD display concept. Note that IAS error for Segment 3 for the BRD display concept was 5.2 kts, which establishes the baseline minimum required level for ILS approaches for the data herein. Unlike previous measures, the BRD display concept did not produce the worst performance. While the PBG and SVS display concepts were within +/-4% of the BRD display concept result, the IAS error for the SCFD was 15% higher than the BRD display concept.

Table 68: Mean IAS Error (kts) for Segment 2 and Segment 3 of the ILS Approach, IFR and H-IFR Pilots

Display Concept	Number of Data Points	Mean Segment 2	Mean Segment 3
PBG	10	3.1	5.0
BRD	19	4.5	5.2*
SVS	15	4.7	5.3
SCFD	12	5.0	6.0

*Note: This value is used herein as the baseline performance for an ILS Approach

4.8.4 VMC-Like approach, all pilots, Segments 2 and 3

An ANOVA conducted on the IAS error results for the main effects of display concept and pilot type revealed no statistically significant results for either Segment 2 or Segment 3. Table 69 provides IAS error results for the three advanced display concepts for the VMC-like approach.

Table 69: IAS Error (kts) for Segment 2 and Segment 3 of the VMC-Like Approach for All Pilots

Display Concept	Number of Data Points	Mean Segment 2	Mean Segment 3
PBG	19	4.5	6.1
SVS	19	4.6	5.4
SCFD	18	4.6	6.1

4.8.5 ILS and VMC-Like approach analysis, Segment 3, all pilots

Figure 25 provides airspeed results for the VMC-like approach for the advanced display concepts. Figures 24 and 25 provide a visual comparison of the pilots’ ability to control airspeed for the ILS and VMC-like approaches, respectively. An ANOVA was conducted on the IAS error data for all pilots for Segment 3 of the ILS and VMC-like approaches for the main effects of pilot type, display concept, and approach to assess the capabilities of advanced display concepts to support advanced IMC operations. There were no significant ($p>0.05$) main effects or interaction effects for IAS error. However, the highest (worst) IAS error for these two approaches was for the VFR pilots (6.3 kts), with the IFR pilots and H-IFR pilots generating the same IAS error (5.7 kts). While this result was not statistically or operationally significant, it appears to be a trend in the data and reflects pilot training and hours of experience. Overall, the VFR pilots’ IAS error was 10% worse than the other two pilot groups. With regard to display concept, the worst (largest) IAS error was for the SCFD (6.3 kts) while the best (smallest) was for the SVS (5.5 kts). This result is supported by Figure 25, which shows that the airspeed control for the SCFD display concept would exceed the PTS criteria more often than for the PBG or SVS display concepts. The IAS error for the PBG display concept (5.8 kts) was very close to the SVS display concept. This result implies that the SA provided by the SVS terrain, which yields no information regarding airspeed, did not affect the pilots’ ability to control airspeed. The SVS display concept decreased IAS error by 13% compared to the SCFD for the ILS and VMC-like approaches. For all advanced display concepts, the average IAS error for each approach (i.e., ILS or VMC-Like) was virtually identical at 5.9 kts. This implies that any increase in workload due to the VMC-like approach was not reflected at all in the airspeed error data.

Table 70 provides a description of the IAS errors for the advanced display concepts with the VFR pilot data included compared to the ILS BRD display concept baseline (i.e., BRD display concept for the ILS approach for the IFR and H-IFR pilots). This comparison is presented in order to discuss the capability of the advanced display concepts to accommodate low-time VFR pilots and enable advanced IMC approaches. As can be seen in Table 70, the largest increase in the IAS error was for SCFD display concept, which was 22.9% and 18.2% higher than the baseline for the ILS and VMC-like approaches, respectively. The smallest increase in IAS error was for the SVS display concept, which was only 5.6% and 5.4% higher than the baseline error for the ILS and VMC-like approaches, respectively. The fact that the SVS display concept was the only one to limit increases in IAS error for VMC-like approach suggests that this display concept was the only one of those tested that could potentially enable advanced IMC operations for virtually all currently certificated pilots. While none of these results were statistically significant, they do show trends in the data that support workload and situation awareness results discussed previously.

Table 70: Percent IAS Error Increase Compared to ILS Evaluation of BRD Display Concept (IFR and H-IFR Pilots) for Segment 3 for ILS and VMC-Like Approaches (all Pilots)

Display Concept	Approach	
	ILS	VMC-Like
SCFD	22.9%	18.2%
PBG	8.3%	18.2%
SVS	5.6%	5.4%

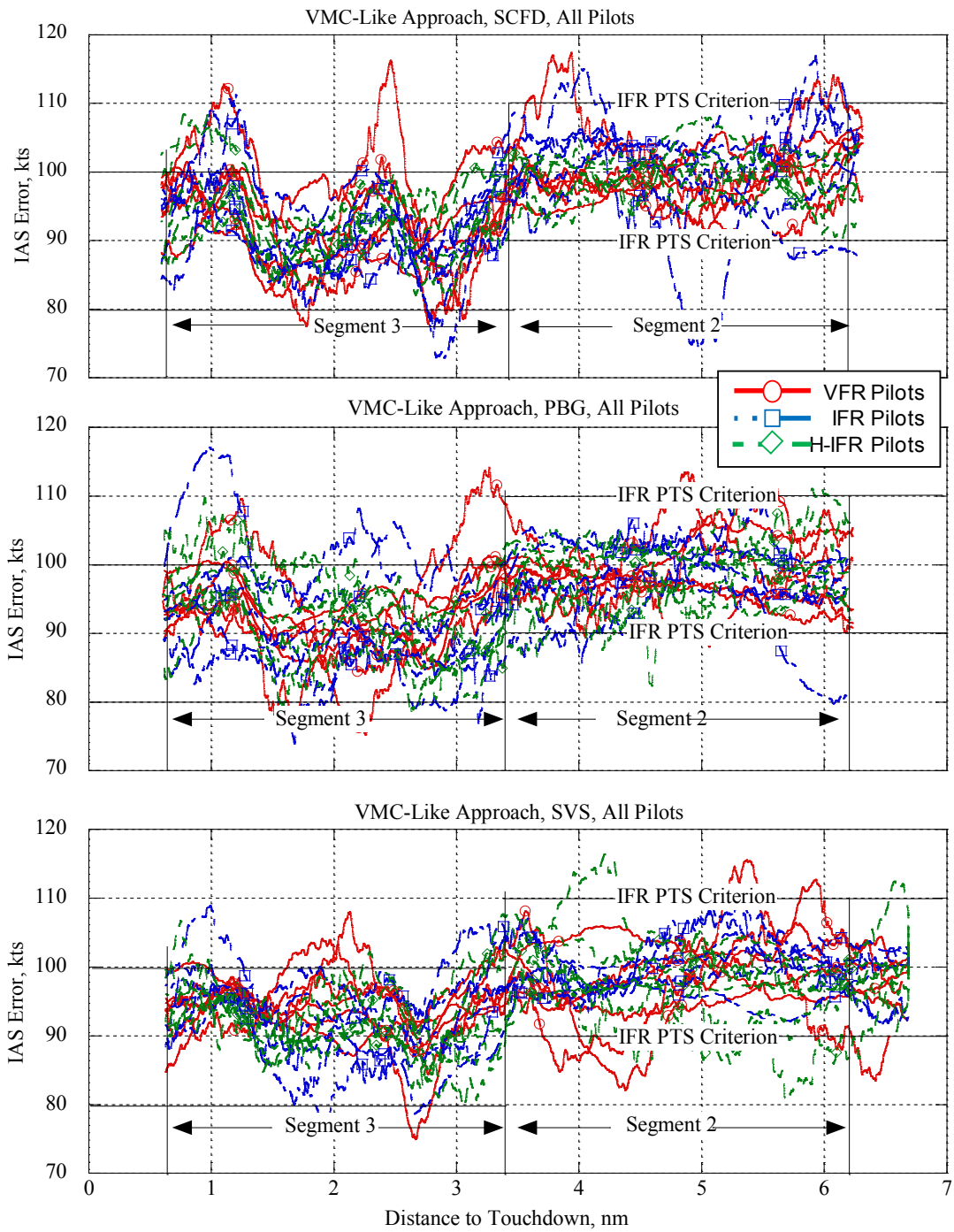

Figure 25: VMC-Like Approach, IAS Performance for all Pilots and Display Concepts

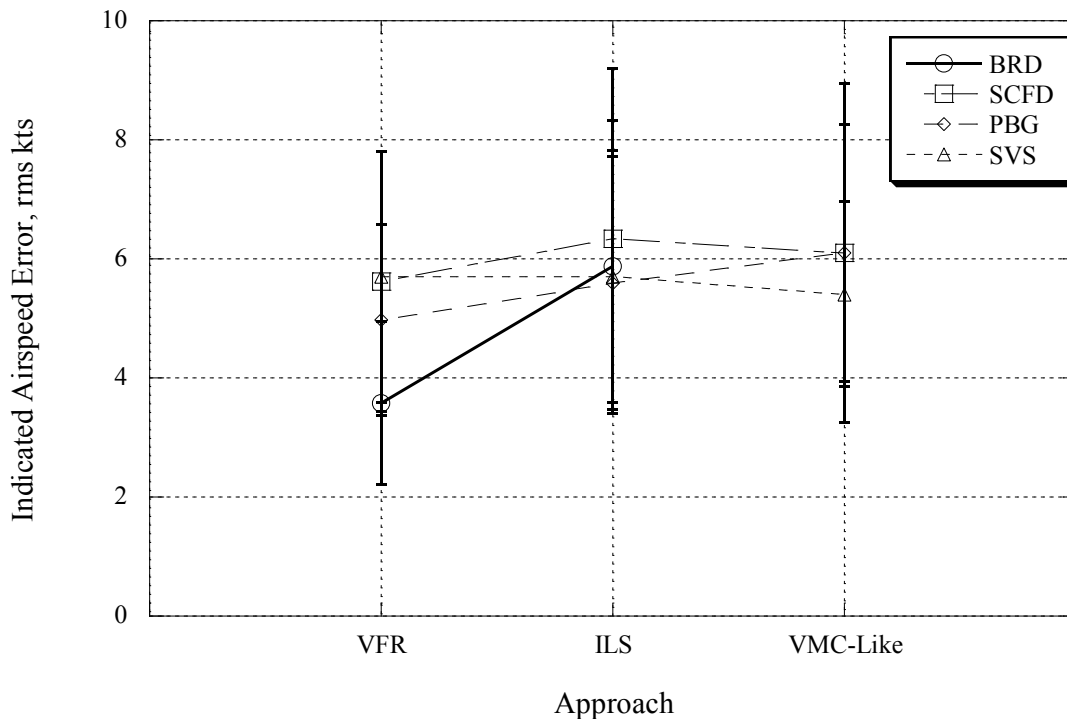

Figure 26: IAS Error for Segment 3, All Pilots, All Approaches

4.8.6 Test condition analysis, Segment 3

A subsequent analysis was performed on IAS error based on TC, with post-hoc results presented in Table 71. As previously performed for other analyses, VFR pilot data was not included for TC 5 (BRD display concept for the ILS approach) in order to provide a more comprehensive measure with strong ties to current operations. Test Condition was highly significant for IAS error results ($F(12,220)=2.73$, $p<0.01$). As can be seen in Table 71, two overlapping subsets were formed from SNK post-hoc analysis. The subset with the lowest IAS error was comprised of TC 1 (VFR approach with BRD display concept), TC 3 (VFR approach with PBG display concept), and TC 5 (ILS approach with BRD display concept, IFR and H-IFR pilots only). The result is not surprising and reflects the low-workload environment of the VFR approach and superior presentation of airspeed information to the pilot afforded by the BRD display concept. Results for the VFR approach for the PBG display concept being included in the low- and high-IAS error groups is a little surprising and is potentially due to the lack of SVS terrain background for this display concept. During the research evaluations, pilots would periodically check and verify that the SVS terrain inside matched the terrain outside and may have become slightly distracted. This distraction was not there for the PBG display concept, since there was no terrain presented on the PFD. TC 5 was also included in the low- and high-IAS error groups even though there was a 1.6 kts increase compared to TC 1. Note that the increase in airspeed error due to outside visibility was smaller for the advanced display concepts than for the BRD. The highest IAS error subset was comprised of all the other TCs (i.e., 2 through 13). As discussed previously, the ILS BRD baseline condition (i.e., TC 5) provided lower airspeed error than the other TCs in simulated IMC, but these differences were not significant. The difference between TC 5 and SVS IMC evaluations (i.e., TC 8 and 11) is smaller compared to differences from the other advanced display concepts. It also needs to be recognized that the advanced display

concepts included the VFR pilot data, whereas TC 5 did not. Results for the VFR pilot evaluations of the SVS display concept for the ILS and VMC-like approaches were higher than TC 5, but not significantly. This implies that advanced IMC operations may be possible for the advanced display concepts.

Table 71: Mean IAS Error (kts) SNK results for TC

Test Condition	TC #	Number of Data Points	Subset	
			1	2
VFR Approach + BRD	1	24	3.6	
VFR Approach + PBG	3	18	5.0	5.0
ILS Approach + BRD (no VFR pilots)	5	19	5.2	5.2
VMC-Like Approach + SVS	11	19		5.4
ILS Approach + SVS	8	21		5.6
ILS Approach + PBG	7	16		5.6
VFR Approach + SCFD	2	19		5.6
VFR Approach + SVS	4	18		5.7
VMC-Like Approach + SVS (VFR pilots)	11	6		5.7
VMC-Like Approach + SCFD	9	18		6.1
VMC-Like Approach + PBG	10	19		6.1
ILS Approach + SVS (VFR pilots)	12	6		6.2
ILS Approach + SCFD	6	18		6.3
Significance			0.054	0.686

4.9 Lateral Flight-Path Error

Lateral flight path error results for the four display concepts and three approaches are presented in Table 72. Figures 27, 28, and 29 show real-time lateral flight path error for the VFR, ILS, and VMC-like approaches, respectively. Figure 30 illustrates RMS lateral flight path error results for the ILS and VMC-like approaches. Error results for the VFR approach evaluation of the BRD were too large to plot conveniently as they were approximately five times greater than other results.

Table 72: Lateral Flight-Path Error (ft) Descriptive Statistics for all Pilots

Display Concept	Approach	Mean	Standard Deviation	Number of Data Points
BRD	VFR	1096.4	501.4	24
	ILS	624.1	428.2	30
	Total	834.0	515.4	54
SCFD	VFR	141.2	117.1	19
	ILS	140.1	95.5	18
	VMC-Like	138.6	84.2	18
	Total	140.0	98.4	55
PBG	VFR	70.2	36.5	18
	ILS	73.8	35.0	16
	VMC-Like	80.2	38.2	19
	Total	74.9	36.2	53
SVS	VFR	79.7	54.2	18
	ILS	72.9	30.7	21
	VMC-Like	70.9	36.8	19
	Total	74.4	40.6	58
Total	VFR	401.2	540.9	79
	ILS	281.9	361.8	85
	VMC-Like	95.8	63.3	56
	Total	277.4	411.6	220

4.9.1 VFR approach

Evaluation pilots were instructed to fly the VFR approach and cross check their out-the-window navigation with the guidance and navigation information provided from the ND and PFD. As can be seen from Figures 27 and Table 72, lateral flight path error for the VFR approach for the BRD display concept was approximately an order of magnitude larger than for the advanced display concepts, which is not an unexpected result. An ANOVA performed on the lateral flight path error for the main effects of display concept and pilot type resulted in highly significant results for display concept ($F(3, 79)=72.0, p<0.01$) and non-significant results for pilot type ($p>0.05$). Subsequent post-hoc analysis produced two subsets, as shown in Table 73. For the VFR approach with the BRD display concept, evaluation pilots relied completely on out-the-window navigation techniques to perform the approach, which resulted in a mean RMS lateral error of 1,096 ft. The data for the VFR approach for the BRD display concept exhibits some unusual characteristics due to the method of lateral flight path error calculation.

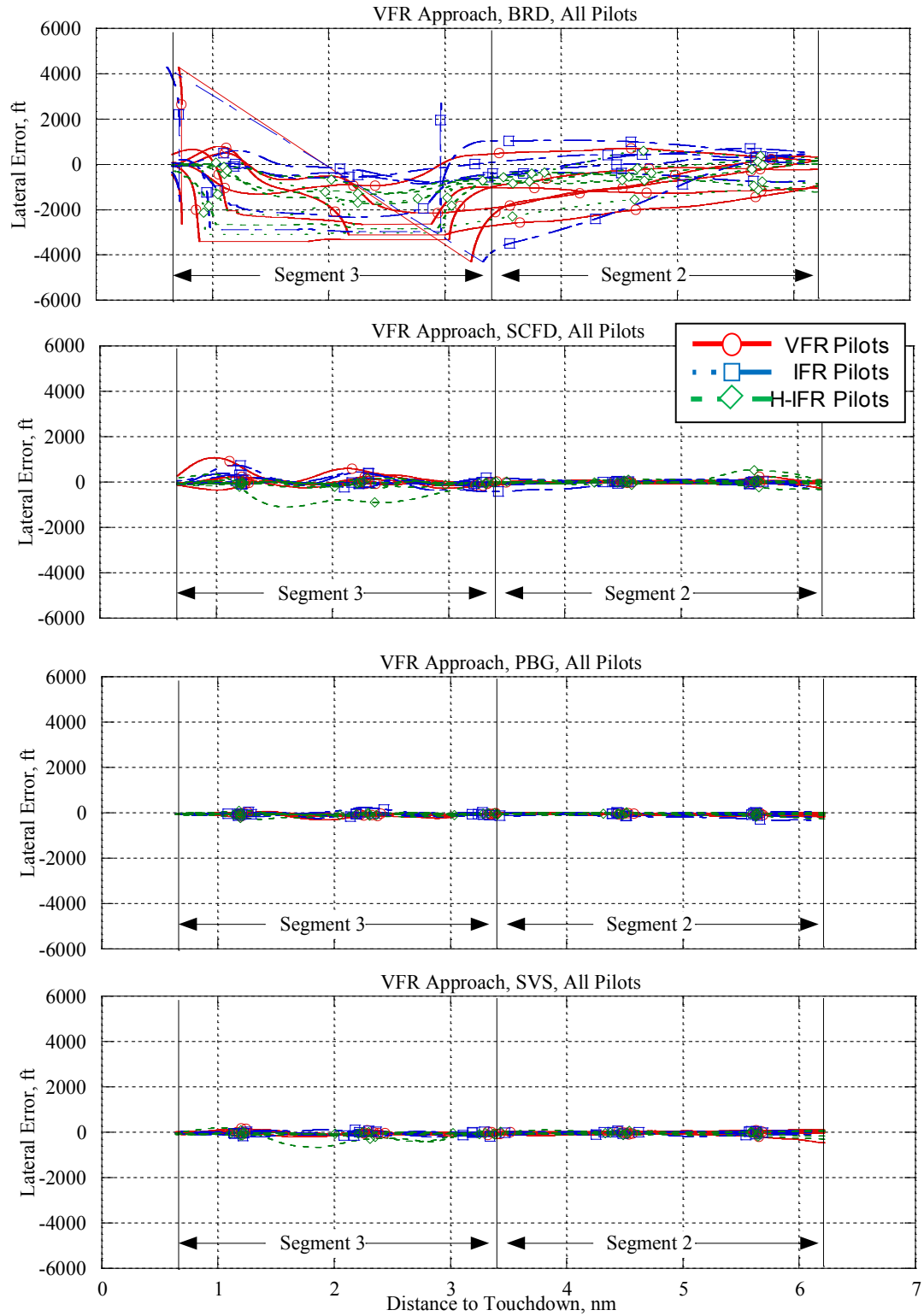

Figure 27: VFR Approach Lateral Error for Each Display, Each Pilot Group

During the VFR approaches with the BRD display concept, pilots would sometimes cut the corner from the downwind leg to the base leg and again from the base leg to final approach, which resulted in a tighter approach than desired. If the aircraft became closer to the final approach leg than the downwind leg, the lateral flight path error calculation reference would jump from the downwind leg to the final approach leg. However, since the aircraft was still flying a track angle closer to the downwind leg than final approach, the sign on the error would jump from negative to positive. The primary effect was that the magnitude of the resulting flight path error was less than it should have been. For example, if the EP departed prematurely from the downwind leg and had a lateral error of 0.8 nm, the recorded lateral error would have been approximately 0.6 nm since that point may have been referenced to the final approach course. While this does bring into question the accuracy of the lateral error data for this approach with the BRD display concept, the data are considered useable for the intent of this report to approximately describe the ability of pilots to fly a specific VFR approach path with the BRD display concept.

For the advanced display concepts, EPs had several other sources of guidance and navigation to work with during the VFR approach and were able to achieve much lower levels of lateral flight path error as can be seen in Figure 27. The SCFD reduced lateral flight path error to 141.2 ft. The PBG and SVS display concepts reduced lateral flight path error further to 70.2 and 79.7 ft, respectively. Note that the increased lateral flight path error for the SCFD, compared to the PBG and SVS display concepts, although not significant, was likely associated with the lack of turn anticipation and flight path awareness for this display concept.

Table 73: Mean Lateral Flight-Path Error (ft) SNK Results for Display Concept for all Pilots for the VFR Approach

Display Concept	Number of Data Points	Subset	
		1	2
PBG	18	70.2	
SVS	18	79.7	
SCFD	19	141.2	
BRD	24		1096.4
Significance		0.35	1.00

4.9.2 ILS approach, all pilots

An ANOVA performed on the lateral flight path error for the main effects of display concept and pilot type resulted in highly significant results for display concept ($F(3,85)=25.7, p<0.01$) and non-significant results for pilot type ($p>0.05$). Subsequent post-hoc analysis produced two subsets, as shown in Table 74. In Figure 28, note that the lateral flight path error for the BRD display concept frequently exceeded the 0.1 nm FTE criterion, especially for Segment 2 and initial stages of Segment 3 of the approach. (The label “RNP 0.1 criterion” is used for illustration to place significance on 0.1 nm FTE. The data are time history data and do not imply 95% probability of exceedance or confidence levels.) Part of the reason that the BRD display concept exceeded the RNP 0.1 criterion from approximately 7.0 to 8.4 nm was due to the low sensitivity of the localizer course deviation indicator (CDI) at this range to touchdown. During

Segment 2, pilots were flying a localizer intercept heading with the BRD display concept and had no direct indication regarding the location of the desired path which contributed to large lateral flight path errors.

The effect of pilot group can also be seen in Figure 28, but only for the BRD display concept, where the VFR pilots exhibited worse lateral flight path error than the IFR or H-IFR pilots groups. No discernible difference is observable for pilot type for the other display concepts. One ILS approach that required termination can be seen in Figure 28 by the red line that terminates at about 2.5 nm from touchdown. For this run, the VFR pilot had no awareness of desired heading or relationship to the intended course, as evidenced by a failure to capture and track the ILS resulting in crossing back and forth across the final approach flight path.

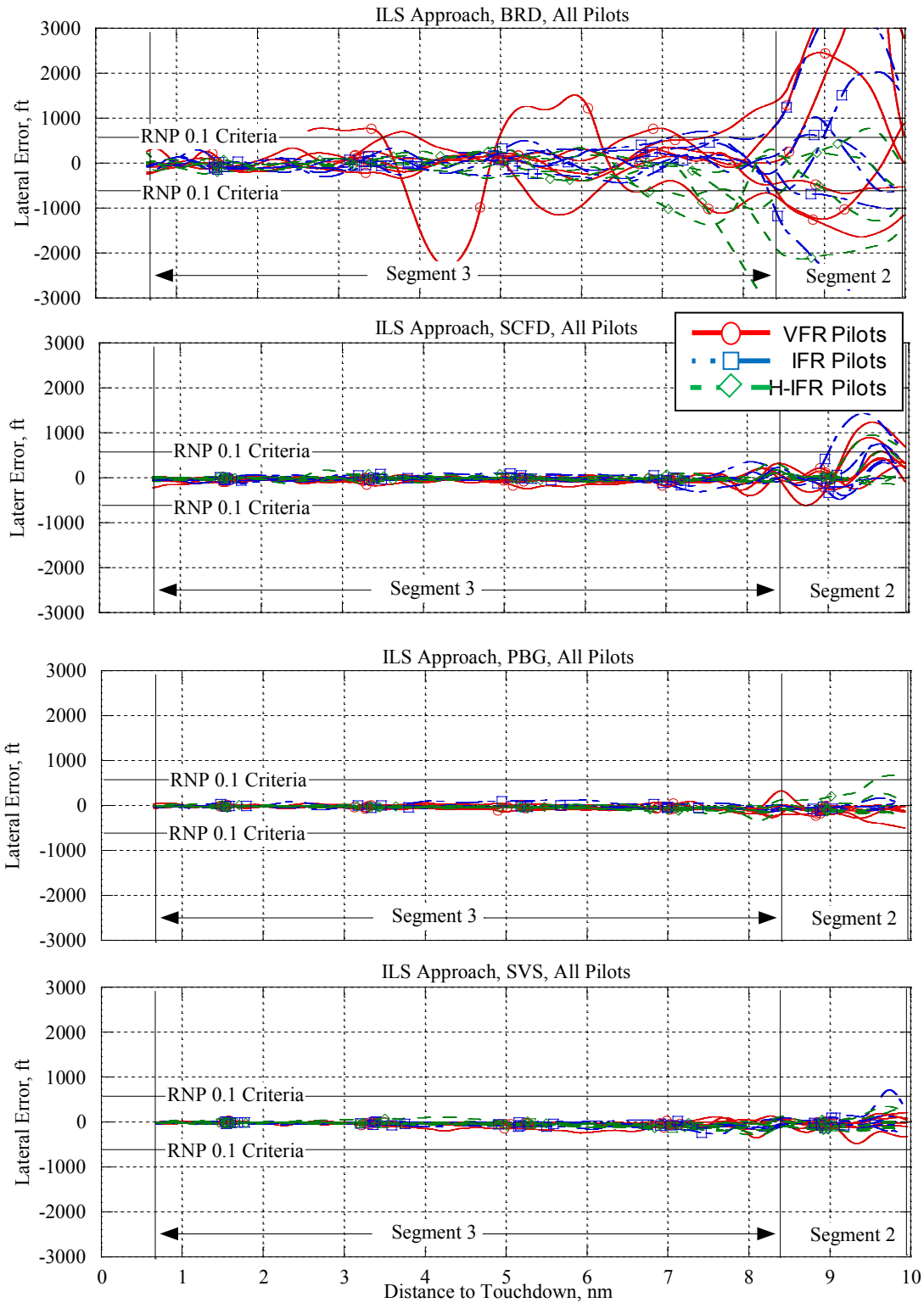

Figure 28: IFR Approach Lateral Error, By Display Condition and Pilot Group

The SCFD display concept reduced lateral flight path error approximately 78% to only 140.1 ft compared to the BRD display concept, as shown in Figure 28 and Table 74. However, results in Figure 28 indicate that the SCFD display concept exceeded the 0.1 nm (i.e., FTE) criterion in Segment 2, likely the result of the lack of turn anticipation for this display concept. Lateral flight path error results for the PBG concept were better than the SCFD, reducing lateral flight path error by 47%. The SVS display concept had the lowest lateral error of all and was slightly better than the PBG. Except for a few very brief times during the initial stages of the approach, the PBG and SVS display concepts were well within the 0.1 nm FTE criterion for all pilot groups. For lateral flight path error results, it should be noted that evaluation pilots were responding to CDI needle deflections for the BRD display concept, and, at large distances from the runway, small angular CDI deflections represented large flight path errors. Conversely, SCFD, PBG, and SVS display guidance concepts were based on rectilinear flight path errors and provided consistent guidance cues throughout the approach. Figure 28 also illustrates that the only display concept to indicate a difference between the different pilot groups was the BRD display concept.

Table 74: Mean Lateral Flight-Path Error (ft) SNK Results for Display Concept for all Pilots for the ILS Approach

Display Concept	Number of Data Points	Subset	
		1	2
SVS	21	72.9	
PBG	16	73.8	
SCFD	18	140.1	
BRD	30		624.1
Significance		0.684	1.000

4.9.3 VMC-Like approach, all pilots

Figure 29 presents lateral flight path error results for the VMC-like approach. It can be seen from Figure 29 that the SCFD display concept exceeded the RNP 0.1 criterion, especially during the turn to final approach (i.e., at 1.0 nm), but also during the turn to base leg to a lesser degree (i.e., at 2.4 nm). Results from Figure 29 also show that all three pilot types performed similarly. An ANOVA performed on the lateral flight path error for the main effects of display concept and pilot type resulted in highly significant results for display concept ($F(3,56)=11.9$, $p<0.01$) and non-significant results for pilot type ($p>0.05$). Subsequent post-hoc analysis produced two unique subsets, as shown in Table 75. Unlike results for the ILS approach, which indicated no statistical difference between the advanced display concepts, results for the VMC-like approach indicate that the SCFD display concept was significantly worse than the PBG and SVS display concepts. This result is again attributable to the lack of turn anticipation of the SCFD display concept. The inclusion of SVS terrain resulted in an 11.6% reduction in lateral flight path error compared to the PBG display concept. Lateral flight path error results for the SVS display concept were nearly one half of (48.8% less) those for SCFD display concept.

Table 75: Mean Lateral Flight-Path Error (ft) SNK Results for Display Concept for all Pilots for the VMC-Like Approach

Display Concept	Number of Data Points	Subset	
		1	2
SVS	19	70.9	
PBG	19	80.2	
SCFD	18		138.6
Significance		0.560	1.000

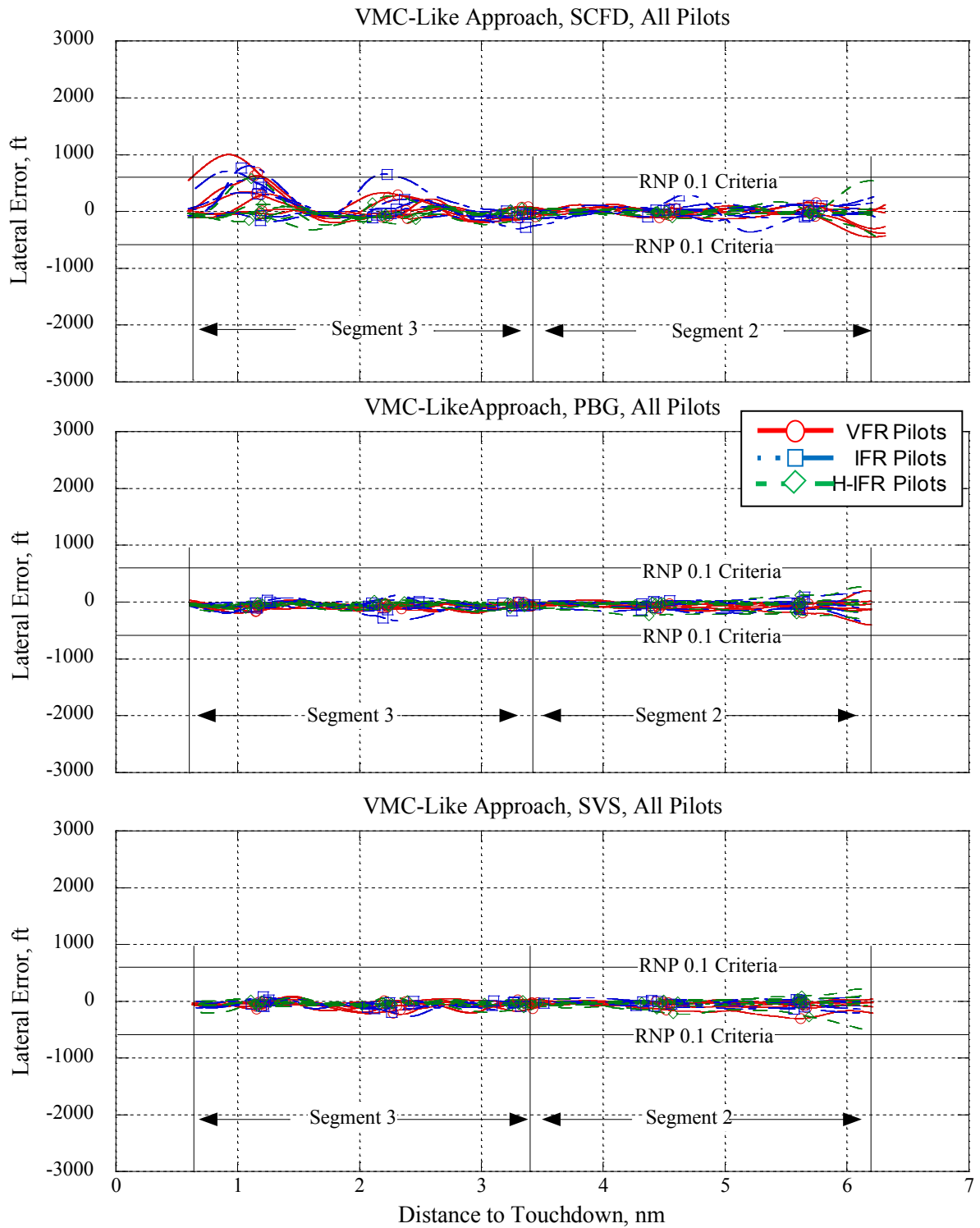

Figure 29: VMC-Like Approach Lateral Error, By Display Concept and Pilot Group

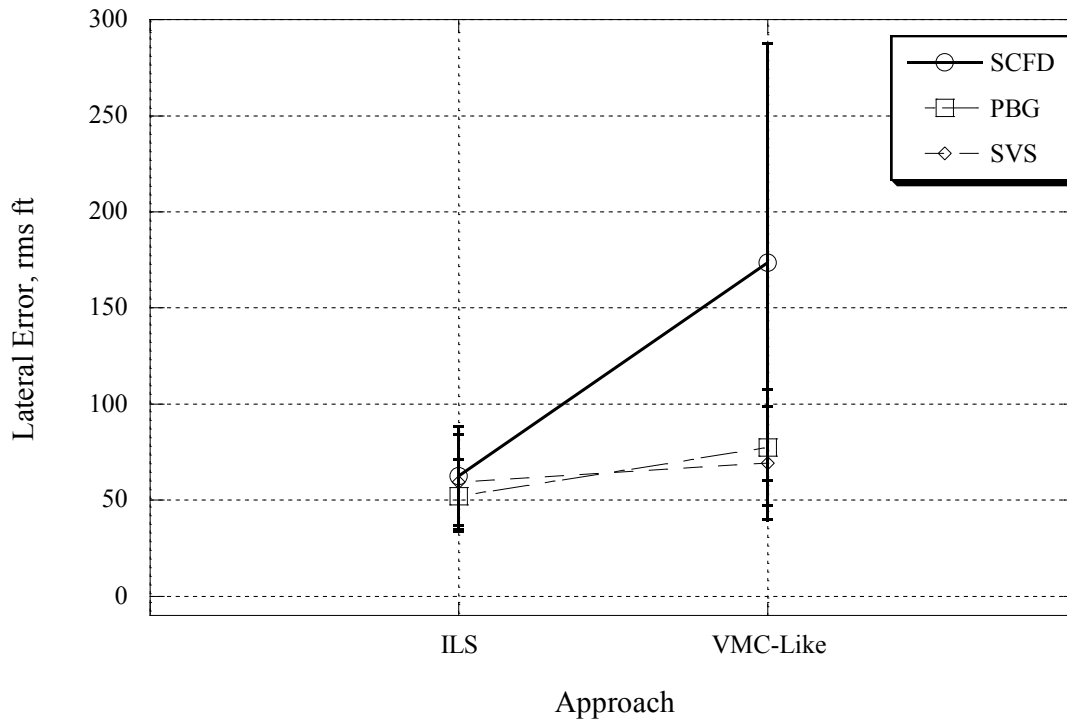

Figure 30: Lateral Error for Segment 3 for the ILS and VMC-Like Approach, All Pilots

4.9.4 ILS approach, Segment 3, without VFR pilot data

Results for lateral flight path error were analyzed without the VFR pilot data during Segment 3, enabling a more direct comparison of the four display concepts within current IMC operations. Results from an ANOVA performed on the lateral flight path error results for the main effects of display concept and pilot type revealed that display concept was highly significant ($F(3,56)=22.92$, $p<0.01$) while pilot type was not significant ($p>0.05$). There were no significant interactions between display concept and pilot type. A subsequent SNK post-hoc analysis yielded two unique subsets, as shown in Table 76. The lowest (best) subset was composed of all of the advanced display concepts with an average mean of approximately 54 ft, which was only one fifth of the lateral flight path error for the BRD display concept. This result is consistent with previous research and indicates that large decreases in flight path error are possible with advanced display concepts. The highest (worst) subset contained only the BRD display concept with a mean of 272 ft, which, for the purposes of this report, establishes the acceptable performance for the ILS approach in today's operations. Also note that the effect of pilot type is only apparent for the BRD display concept in Figure 28, indicating the capability of the advanced display concepts, especially the PBG and SVS, to greatly enhance the ability of VFR pilots to maintain lateral path error as good as higher-hour better-trained pilots, for the ILS approach.

Table 76: Mean Lateral Flight-Path Error (ft) SNK results, for the ILS Approach, IFR and H-IFR Pilots

Display Concept	Number of Data Points	Subset	
		1	2
PBG	10	49.1	
SCFD	12	54.5	
SVS	15	59.3	
BRD	19		272.4*
Significance		0.96	1.00

*Note: This value is used herein as the baseline performance for an ILS Approach

4.9.5 ILS and VMC-Like approach analysis, Segment 3, all pilots

An analysis of the Segment 3 data for the ILS and VMC-like approaches was performed to compare the differences between nominal ILS localizer and glideslope tracking to the turning and descending flight of the VMC-like approach. Figures 28 and 29 provide a visual comparison of the results for the ILS and VMC-like approaches to assess the capabilities of advanced display concepts to support advanced IMC operations. Note that results for the SCFD display concept show that the “RNP 0.1 criterion” (i.e., FTE of 0.1 nm) was frequently exceeded in several runs at approximately 0.9 nm during the turn to final approach. There was also one run for an IFR pilot that exceeded the RNP 0.1 criterion during the turn to base leg at approximately 2.2 nm. Results for the PBG and SVS display concepts indicate reduced lateral flight path error compared to the SCFD display concept and remained well within the 0.1 nm FTE (“RNP 0.1 criterion”). There was also an increase for lateral flight path error for the VMC-like approach compared to the ILS approach for Segment 3. This was expected due to the nature of the VMC-like approach with two turns during Segment 3.

An ANOVA was conducted on the lateral flight path error data for all pilots for Segment 3 of the ILS and VMC-like approaches. The ANOVA analysis indicated that display concept ($F(2,111)=15.05$, $p<0.01$) and approach ($F(1,111)=28.63$, $p<0.01$) were highly significant for lateral path error while pilot type ($F(2,111)=2.15$, $p=0.12$) was not significant. The interactions between display concept and approach were also highly significant ($F(2,111)=12.29$, $p<0.01$); however, the interaction between pilot type and display concept, and pilot type and approach, were not significant. Subsequent post-hoc analysis yielded two subsets as shown in Table 77. In the lower (best) subset were the SVS and PBG display concepts with an average mean lateral flight path error of approximately 65 ft, which was approximately one half of the error for SCFD. One reason for the reduced lateral flight path error for the SVS and PBG display concepts involves the turn anticipation provided by the HITS guidance. Even in the presence of the ND that provided route and turn anticipation information to the evaluation pilots, the HITS guidance was especially valuable for the VMC-like approach.

Table 77: Mean Lateral Flight-Path Error (ft) SNK results, Segment 3 of the ILS and VMC-Like Approaches for all Pilots

Display Concept	Number of Data Points	Subset	
		1	2
SVS	40	64.2	
PBG	35	65.8	
SCFD	36		118.0
Significance		0.88	1.000

Table 78, along with Figures 28, 29, and 30, provides information regarding the effect of approach and display concept that illustrates the increase in lateral flight path error for the VMC-like approach compared to the ILS approach. Both the SCFD and PBG display concepts exhibited larger increases in lateral flight path error than the SVS display concept due to approach in Segment 3. Lateral flight path error for the VMC-like approach increased by factors of 2.78, 1.48, and 1.16 for the SCFD, PBG, and SVS display concepts, respectively, compared to the ILS approach. The smaller increase in lateral error for the VMC-like approach can be attributed to the increased situation awareness provided by the HITS guidance and SVS terrain for the VMC-like approach.

Table 78: Lateral Flight-Path Error Statistical Results (ft), Segment 3 of the ILS and VMC-Like Approaches for all Pilots

Display Concept	Approach	Mean	Standard Deviation
SCFD	ILS	62.4	25.7
	VMC-Like	173.6	113.7
PBG	ILS	52.2	18.8
	VMC-Like	77.3	30.2
SVS	ILS	59.5	23.7
	VMC-Like	69.3	29.6

4.9.6 Test condition analysis, Segment 3

An ANOVA analysis was performed on lateral flight path error for TC for Segment 3 for all three approaches with post-hoc results presented in Table 79. Test Condition was revealed to be highly significant for lateral flight path error results ($F(12,220)=34.724$, $p<0.01$) and was not significant for pilot type ($p>0.05$). Two unique subsets were formed in subsequent post-hoc analysis. The highest (worst) subset was comprised of TC 1 (VFR approach with BRD display concept). This result was expected in that the EPs had to rely exclusively on their out-the-window navigation to negotiate the VFR approach and is consistent with current VFR operations. There were no significant lateral path error differences among the other test conditions. It is important to note that results for TCs 3, 4, 6, 7, 8, 10, and 11 had a group average mean of 70 ft, which was only approximately one third of the lateral flight path error results for TCs 2, 5, and 9, with an average mean of 206 ft. Although not statistically significant, the TCs for the advanced display concepts for the IMC approaches (i.e., TCs 6 through 11) were all lower than for

TC 5 (ILS approach for BRD). In addition, results for the VFR pilots' evaluations of the SVS display concept for the ILS and VMC-like approaches were also lower than TC 5. Based on lateral flight path error, advanced IMC approaches, such as the VMC-like approach, appear feasible for the PBG and SVS advanced displays tested in this study. From Figure 29, it can be seen that results for the SCFD display concept violated the RNP 0.1 criterion (i.e., 0.1 nm FTE) for the VMC-like approach, indicating that this type of manually-flown approach may not be appropriate for this display concept.

Table 79: Mean Lateral Flight-Path Error (ft) SNK results for TC

Test Condition	TC #	Number of Data Points	Subset	
			1	2
ILS Approach + PBG	7	16	52.2	
ILS Approach + SVS	8	21	59.5	
ILS Approach + SVS (VFR pilots)	12	6	59.8	
ILS Approach + SCFD	6	18	62.4	
VMC-Like Approach + SVS	11	19	69.3	
VMC-Like Approach + PBG	10	19	77.3	
VFR Approach + PBG	3	18	77.9	
VMC-Like Approach + SVS (VFR pilots)	13	6	84.2	
VFR Approach + SVS	4	18	89.7	
VFR Approach + SCFD	2	19	172.7	
VMC-Like Approach + SCFD	9	18	173.6	
ILS Approach + BRD (no VFR pilots)	5	19	272.4	
VFR Approach + BRD	1	24		1454.9
Significance			0.747	1.000

4.10 Vertical Flight Path Error

No clear criterion were available for the vertical flight path error for the IMC approaches. For the discussions herein, +/-100 ft will be used as a relevant criterion for comparisons and assessments. Figures 31, 32, and 33 show real-time vertical flight path error data for the VFR, ILS and VMC-like approaches, respectively. Figure 34 and Table 80 show mean RMS results for vertical flight path error.

Table 80: Vertical Path Error (ft) Descriptive Statistics for all Pilots

Display Concept	Approach	Mean	Standard Deviation	Number of Data Points
BRD	VFR	99.6	46.6	24
	ILS	171.8	117.6	30
	Total	139.7	99.1	54
SCFD	VFR	25.2	15.0	19
	ILS	25.6	15.0	18
	VMC-Like	26.6	15.1	18
	Total	25.8	14.8	55
PBG	VFR	31.7	12.3	18
	ILS	40.7	19.2	16
	VMC-Like	35.2	16.7	19
	Total	35.7	16.3	53
SVS	VFR	36.9	22.4	18
	ILS	39.7	18.0	21
	VMC-Like	30.1	13.8	19
	Total	35.7	18.4	58
Total	VFR	51.9	43.0	79
	ILS	83.5	96.4	85
	VMC-Like	30.7	15.4	56
	Total	58.7	68.8	220

4.10.1 VFR approach

For the VFR approach, the EPs were instructed to maintain altitude until abeam the runway numbers, then descend through base leg and final approach segments. For the BRD display concept, no guidance information was provided to the EPs and they relied on the out-the-window view to manage flight path along with cross checking their altimeter at specific points along the approach. As can be seen in Figure 31 and Table 81, vertical flight path error for the BRD display concept was approximately 100 ft, which is reasonable for this type of approach.

Note that issues with the VFR approaches that were flown with cut-corners at the turn to base leg from the downwind leg created some problems with the vertical flight path error data as well. This was previously described for the lateral flight path error. The main problem was that when the lateral flight path error calculation shifted the desired flight path reference point to the final approach leg when the corner between the downwind leg and base leg was cut, the desired altitude also changed. Unlike lateral

flight path error, this anomaly usually increased the magnitude of the vertical flight path error results for the BRD display concept. However, the data does approximately represent the capability of pilots to fly a VFR approach with the BRD display concept especially for Segment 2.

Provisions of guidance cues and vertical flight path error information within the advanced display concepts enabled EPs to substantially lower their vertical flight path errors to approximately 40% of the results for the BRD display concept, as shown in Figure 31 and Table 81. An ANOVA conducted on the vertical flight path error data for the VFR approach for the main effects of display concept and pilot type resulted in significant results for display concept ($F(3, 79)=45.0, p<0.01$) but not for pilot type ($p>0.05$) or the interaction of pilot type with display concept.

Table 81: Mean Vertical Flight-Path Error (ft) SNK Results for Display Concept for all Pilots for the VFR Approach

Display Concept	Number of Data Points	Subset	
		1	2
SCFD	19	25.2	
PBG	18	31.7	
SVS	18	25.2	
BRD	24		99.6
Significance		0.313	1.000

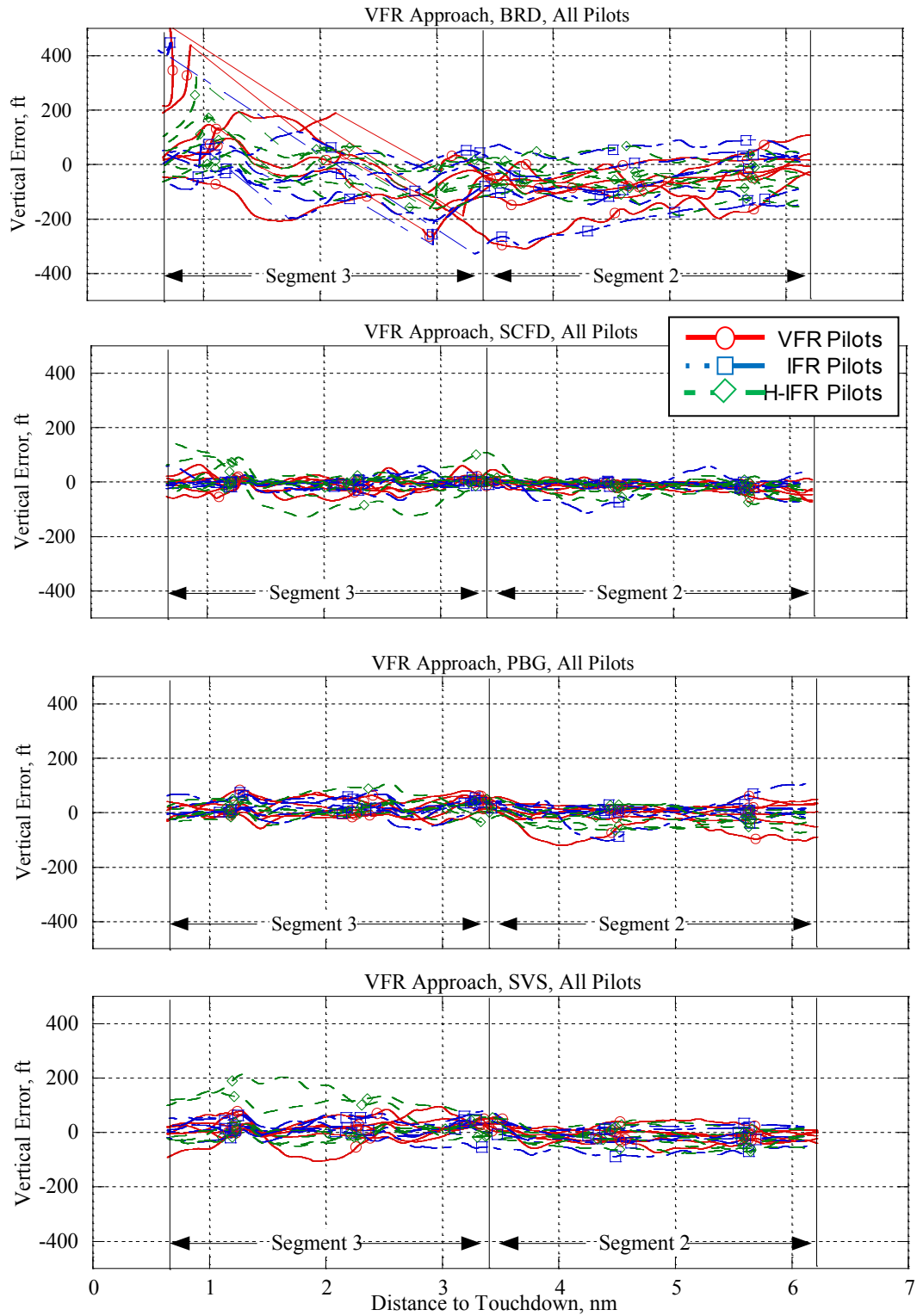

Figure 31: VFR Approach, Vertical Error, By Display Concept and Pilot Group

4.10.2 ILS approach, all pilots

An ANOVA conducted on the vertical flight path error data for the ILS approach for the main effects of display concept and pilot type produced highly significant results for display concept ($F(3, 85)=25.7$, $p<0.01$) but not for pilot type ($p>0.05$). There was no significant interaction between display concept and pilot type. Subsequent post-hoc analysis on display concept resulted in two unique subsets, as shown in Table 82. For the advanced display concepts, vertical flight path error was reduced approximately by a factor of five compared to the BRD display concept, as shown in Figure 32. This result was partially due to the SCFD and HITS guidance systems providing constant sensitivity to vertical flight path errors for the entire ILS approach and the advanced display concepts integrated information format. Note that one dot of vertical CDI deflection corresponds to approximately 360 ft of vertical flight path error at the glideslope intercept point. There is also an indication that the SCFD display concept had lower vertical flight path error than the PBG and SVS display concepts which had pathway-based guidance as indicated in Figure 32. The reduced vertical flight path error results for the SCFD was due to the combination of the prominent single-cue-flight-director symbology with the pitch-attitude command system that emphasized attitude and vertical error control. While the effect of pilot type was not statistically significant, the operational effect of pilot type can be observed in Figure 32 where the VFR pilots' results can be seen to be somewhat worse than the other two pilot groups for the BRD and PBG display concepts. The effect of pilot group was reduced for the SVS display concept as seen in Figure 32, which appears to show the positive effect of SVS terrain to aid in vertical error reductions when compared to results for the PBG display concept. The presence of the SVS terrain significantly increased pilots' situation awareness and their ability to integrate the information provided, likely leading to reduced vertical flight path error.

Table 82: Mean Vertical Flight Path Error (ft) SNK Results for Display Concept for all Pilots,ILS Approach

Display Concept	Number of Data Points	Subset	
		1	2
SCFD	18	25.6	
SVS	21	39.7	
PBG	16	40.7	
BRD	30		171.8
Significance		0.761	1.000

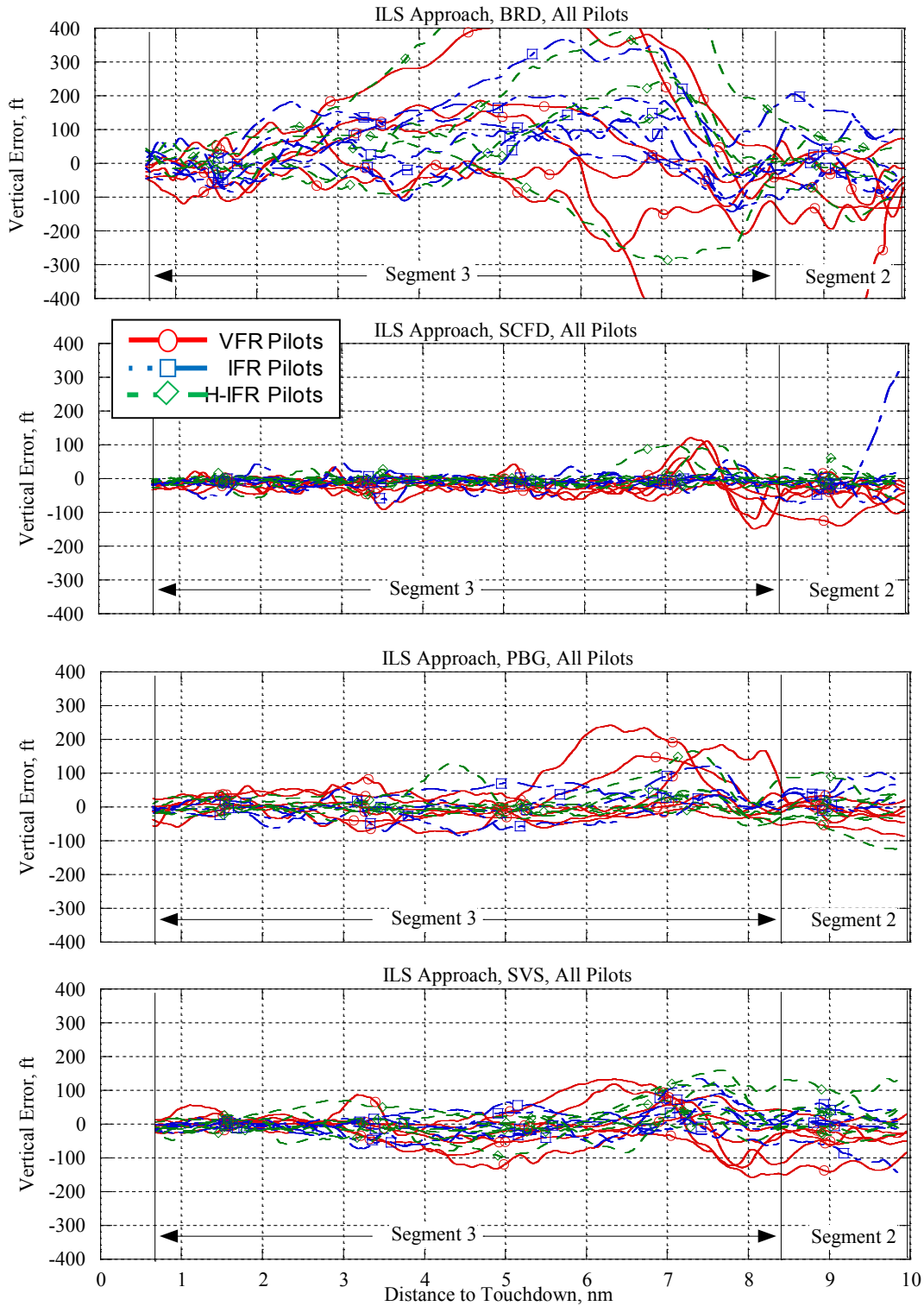

Figure 32: ILS Approach, Vertical Error, By Display Concept and Pilot Group

4.10.3 VMC-Like approach, all pilots

Results for vertical flight path error, illustrated in Figure 33, indicate somewhat similar characteristics for all display concepts for the VMC-like approach. However, the PBG display concept does show some degraded performance compared to the SCFD, with several vertical error excursions in excess of +/-100 ft. An ANOVA conducted on the vertical flight path error data for the VMC-like approach for the main effects of display concept and pilot type did not produce any significant ($p>0.5$) results for display concept, pilot type, or interaction between these two factors.

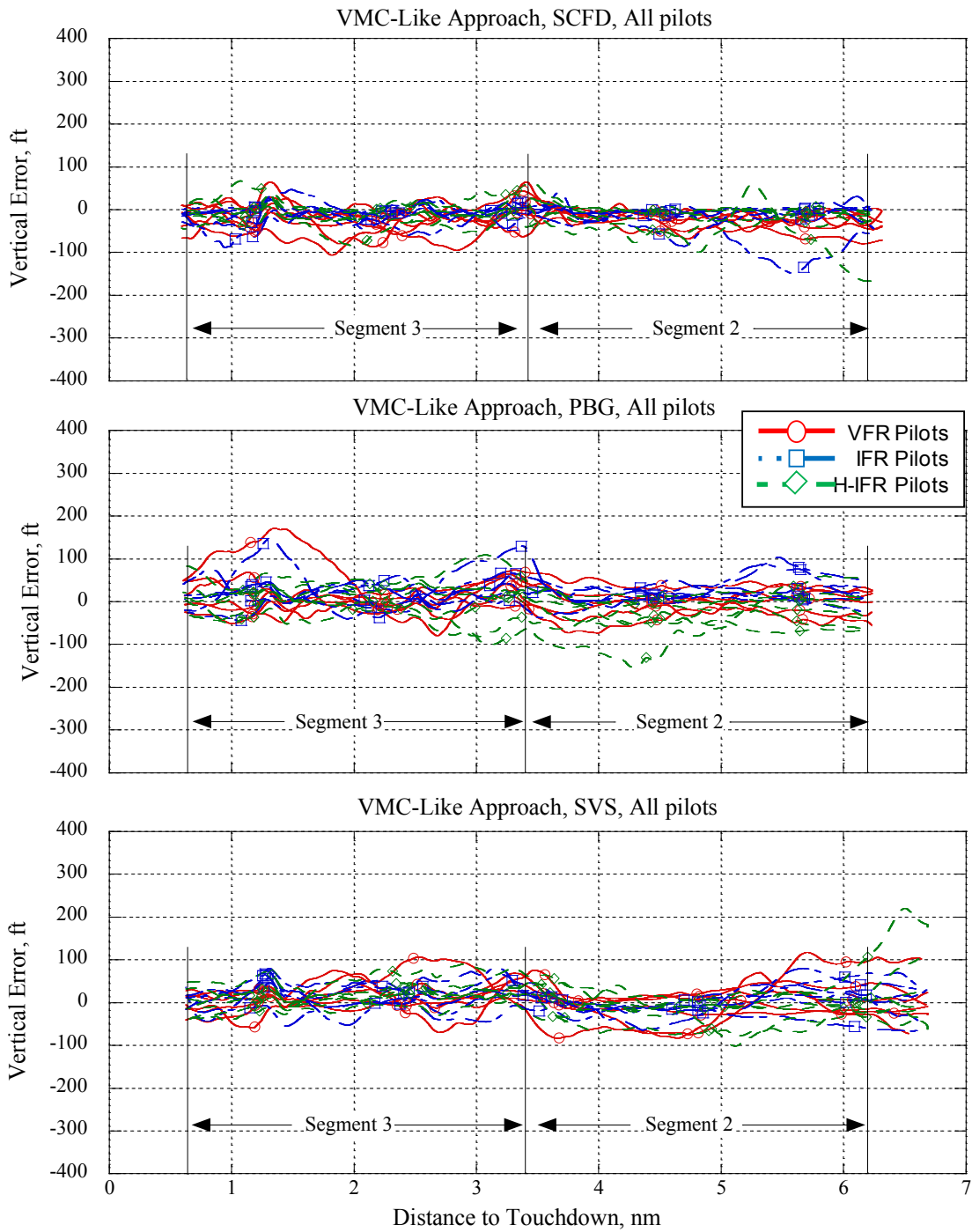

Figure 33: VMC-Like Approach, Vertical Error, By Display Concept and Pilot Group

4.10.4 ILS approach, Segment 3, without VFR pilot data

Vertical flight path error was analyzed without the VFR pilot data. Results from an ANOVA revealed that display concept was highly significant ($F(3,56)=19.634, p<0.01$) for vertical path error. Neither pilot type (i.e., either IFR or H-IFR) nor the interaction between pilot type and display concept were significant ($p>0.05$) for this measure. These results match the effects shown in Figure 32. Subsequent post-hoc analysis yielded two unique subsets, as shown in Table 83. The advanced display concepts comprised the lower (best) vertical path error subset with the BRD display concept being the only member of the higher (worst) subset. The lowest vertical flight path error was for the SCFD display concept with results being approximately one half as high as the results for the PBG and SVS display concepts. The differences between the SCFD, PBG, and SVS display concepts were not statistically significant, but this result may indicate the ability of the SCFD display concept to improve vertical flight path error for this approach segment. The highest (worst) subset contained only the BRD display concept with a mean error of 145 ft, which established the nominal performance for the ILS approach in today’s operations for the data considered in this report. Overall, the average of the mean vertical flight path error for the advanced display concepts was 27.2 ft, which was less than one-fifth of the error for the BRD display concept. Again, this result is likely due to the variable sensitivity of the CDI needle movement in response to vertical flight path error with range during the ILS approach and the integrated, intuitive guidance provided by the SCFD and HITS guidance systems. These results suggest that terrain clearance margins required for ILS operations today could be greatly reduced with advanced display concepts. Currently, approach procedures are designed according to Reference 24 (FAA Order 8260.3, United States Standard for Terminal Instrument Procedures (TERPS)). For a nominal 3-degree glideslope, the altitude clearance is approximately 892 ft at the beginning of Segment 3 (i.e., 8.4 nm from touchdown). If it is assumed that total system error is composed of navigation system error and flight technical error, then it is possible that this amount of margin could be reduced if flight technical error is significantly reduced.

Table 83: Mean Vertical Flight-Path Error (ft) SNK results for the ILS Approach, IFR and H-IFR Pilots Only

Display Concept	Number of Data Points	Subset	
		1	2
SCFD	12	16.2	
PBG	10	32.5	
SVS	15	33.0	
BRD	19		145.0*
Significance		0.70	1.0

*Note: This value is used herein as the baseline performance for an ILS Approach

4.10.5 ILS and VMC-Like approach analysis, Segment 3, all pilots

Figures 32 and 33 show a visual comparison of the vertical flight path errors for the advanced display concepts for the ILS and VMC-like approaches. An ANOVA was conducted on the vertical flight path error data for all pilots for Segment 3 of the ILS and VMC-like approaches for the main effects of pilot type, display concept, and approach to compare and contrast each advanced display concept as well as assess the capabilities of advanced display concepts to support advanced IMC operations. The ANOVA analysis indicated that pilot type ($F(2,111)=7.701, p<0.01$) and display concept ($F(2,111)=8.96, p<0.001$) were highly significant and approach was not ($p>0.05$) for vertical path error. There were no significant

interactions between the main effects for this measure. Table 84 shows that the IFR and H-IFR pilot groups exhibited significantly less vertical flight path error than the VFR pilot group. The VFR pilots' vertical flight path error was approximately 10 ft, or 37%, more than the IFR and H-IFR pilots. Table 84 provides SNK results for display concept for the ILS and VMC-like approaches and shows that the SCFD had significantly less vertical path error (approximately 12 ft) than the PBG and SVS display concepts. There were no significant vertical path error differences between the PBG and SVS display concepts. This result is likely due to the superior vertical flight path guidance provided by the SCFD system for these approaches. The SCFD symbology provided a compelling indication of the commanded pitch attitude to control vertical flight path error. However, as shown previously, the SCFD did exhibit poor lateral flight path error results primarily due to the lack of turn anticipation. Overall, vertical flight path error results indicate that the VMC-like approach may be feasible for the advanced display concepts.

Table 84: Mean Vertical Flight-Path Error (ft) SNK results for Pilot Type, ILS and VMC-Like Approaches for all Pilots

Pilot Type	Number of Data Points	Subset	
		1	2
IFR	36	27.6	
H-IFR	39	28.6	
VFR	36		39.1
Significance		0.765	1.0

Table 85: Mean Vertical Flight-Path Error (ft) SNK results for the Advanced Display Concepts, ILS and VMC-Like Approaches for all Pilots

Display Concept	Number of Data Points	Subset	
		1	2
SCFD	36	23.6	
SVS	40		33.9
PBG	35		37.6
Significance		1.000	0.252

4.10.6 Test condition analysis, Segment 3

A subsequent analysis was performed on vertical flight path error based on TC, with post-hoc results presented in Table 86. TC was highly significant for vertical flight path error results ($F(12,209)=20.555$, $p<0.01$). Three unique subsets were formed from SNK post-hoc analysis of the vertical flight path error. The lowest vertical path error was recorded for the advanced display concepts regardless of approach (VMC-like, ILS, or VFR). The VFR approach evaluation of the BRD display concept had significantly worse vertical path error than any of the advanced displays for any approaches, but had significantly better vertical-path error than TC 5 (ILS approach with BRD display concept without the VFR pilots). The BRD display concept for the ILS approach had significantly worse vertical path error than all other display concept and approach combinations. These results appear to indicate that advanced IMC approaches similar to the VMC-like approach, are feasible with the advanced display concepts from the standpoint of vertical flight path error, since all IMC evaluations of these display concepts (i.e., TCs 9, 10, 11) were significantly lower than the results for ILS approach with the BRD display concept (TC 5).

Results for the VFR pilots' evaluation of the SVS display concept for both the ILS and VMC-like approaches were significantly better than TC 5.

Table 86: Mean Vertical Flight-Path Error (ft) SNK results for TC

Test Condition	TC #	Number of Data Points	Subset		
			1	2	3
ILS Approach + SCFD	6	18	21.7		
VMC-Like Approach + SCFD	9	18	25.5		
VFR Approach + SCFD	2	19	25.9		
VMC-Like Approach + SVS	11	19	29.7		
VMC-Like Approach + SVS (VFR pilots)	13	6	30.9		
VFR Approach + PBG	3	18	31.1		
VMC-Like Approach + PBG	10	19	36.0		
ILS Approach + SVS	8	21	37.6		
ILS Approach + PBG	7	16	39.4		
VFR Approach + SVS	4	18	40.2		
ILS Approach + SVS (VFR pilots)	12	6	49.0		
VFR Approach + BRD	1	24		116.7	
ILS Approach + BRD (no VFR pilots)	5	19			145.0
Significance			0.704	1.000	1.000

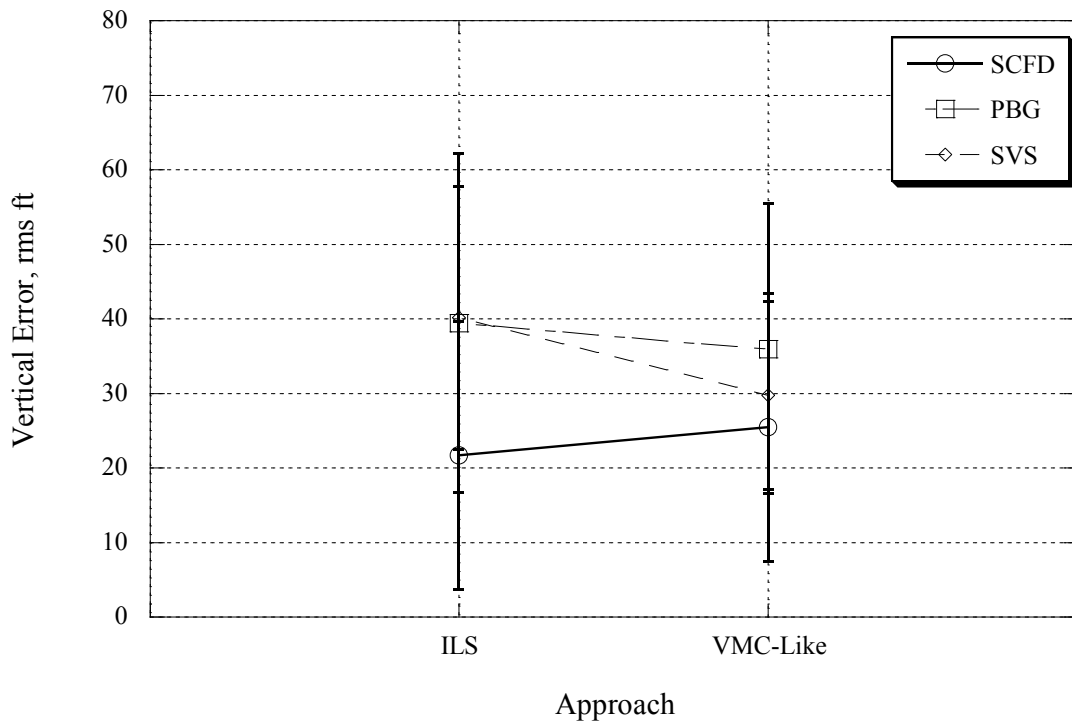

Figure 34: Vertical Error, Segment 3, for Approaches 2 and 3, All Pilots

5.0 Summary of Results

Qualitative results for the SVS display concept evaluations in simulated IMC were not statistically different from the VMC evaluations, but were statistically different from the IMC evaluations of the BRD display concept. This was true for all qualitative parameters used for this study (i.e., SART, TLX, DRR, and TA). Note that the reference condition for the IMC evaluation of the BRD did not include the VFR-rated pilots' data to provide a better comparison metric that had strong ties to existing operations. The incorporation of SVS terrain provided a significant improvement in the results compared to the PBG display concept for situation awareness measures (SART and TA). The effect of the SVS terrain depiction decreased workload measures (TLX, DRR) compared to the PBG display concept, but not significantly.

Quantitative results, such as PTS, lateral, vertical, localizer and glideslope errors, indicate that the advanced display concepts (SCFD, PBG, and SVS) provided significantly better performance than the BRD display concept for the ILS approach. Lateral and vertical error results for the advanced displays were reduced by approximately a factor of 4 for the ILS approach compared to the BRD display concept. Significant effects of pilot type were observed in several parameters, such as PTS, localizer, glideslope, and IAS errors; however, those effects were primarily limited to results from the BRD display concept, with the VFR-rated pilots performing significantly worse than the IFR and H-IFR pilots. The SCFD display concept generated significantly worse lateral flight path and localizer error results compared to the PBG and SVS display concept evaluations for the VMC-like approach. This is thought to be due to a lack of turn anticipation of the SCFD. While RMS values of lateral flight path and localizer errors were not statistically different from those from the BRD ILS evaluations by the IFR and H-IFR pilots, graphical results indicated that PTS and FTE standards were exceeded for the SCFD display concept during the turns to base leg and final approach for the VMC-like approach. Several exceedances of the IFR PTS criteria were also observed for the PBG display concept for the VMC-like approach during the last 2 nm. This indicates that the SCFD and PBG display concepts would not likely be suitable for advanced IMC approaches, such as the VMC-like approach. Results for the SVS display concept indicate that all pilots can fly an advanced VMC-like approach and generate flight technical error (i.e., lateral, vertical, localizer, glideslope and IAS errors) results as good as or better than IFR and H-IFR pilots using the BRD display concept for the ILS approach. Glideslope error results for the SCFD display concept were significantly superior to the PBG display concept results due to the emphasis on attitude control and the underlying flight director guidance algorithm performance. However, pilot workload was increased significantly for the SCFD compared to the PBG display concept. The incorporation of SVS terrain for the SVS display concept improved flight path control and significantly reduced glideslope error compared to the PBG display concept while maintaining workload. Glideslope error results for the SVS display concept were similar to results for the SCFD. The depiction of terrain on the SVS display concept greatly improved the performance of VFR-rated pilots.

6.0 Limitations of Current Study

The current investigation evaluated scenarios in which all systems were functioning nominally over a small, but critical, range of conditions and with a limited, but representative, sample of the pilot population. Results from this flight test are intended to be applicable to other real-world conditions; however, several limitations of the current study dictate that subsequent applications of these results need to be performed carefully.

Issues related to off-nominal system performance were not addressed, such as ADAHRS failures, display failures, and communication failures. One particular off-nominal system issue with SVS display technology not addressed in this report was the risk of terrain database errors. Terrain database errors could influence a pilot to deviate from the intended flight path due to false SVS terrain cues. It needs to be realized that the concept of operations considered herein still involves a visual segment of the approach and landing, similar to current ILS approaches. Visually verifying the condition of the runway prior to landing will still be performed by the pilot, whether they are using SVS or not, under conceivable GA operations in the foreseeable future.

Potentially increased heads-down time during marginal VMC operations is not explicitly addressed within the current study, although some discussion is provided regarding the presence of terrain heads-up and heads-down with SVS displays for VMC operations. While a safety of flight issue, VMC mid-air collisions are less prevalent than IMC Controlled Flight Into Terrain (CFIT) accidents. As a result, while operations in VMC flight may need to be evaluated with SVS displays, it is proposed that significant improvements in IMC flight could potentially more than offset this issue and improve the overall safety situation. While not part of this research effort, careful concept of operations development and training would be needed to effectively deal with issues such as overconfidence and decision making with SVS displays. The current work documented herein does reflect the potential benefits from SVS display concepts, and other advanced display concepts, and does support the need for further study as well as operational evaluations.

A total of 19 pilots participated overall in this flight test, generating 219 research evaluations. More evaluation pilots would have helped to add to the statistical power of the subsequent analyses, especially those that compared across pilot groups. The use of pilot hours and officially logged training as a control variable to establish pilot type could be improved. For example, some low-time VFR pilots acknowledged that they frequently used desktop simulation tools to practice IFR approaches. This type of auxiliary experience could be mitigated through pre-testing of subject pilots (i.e., to see that they provide consistent performance for their group) and also pre-test screening (to screen-out pilots with known discrepancies).

Another more basic limitation of the study was the ability of current HF tools (e.g., SART, TLX, DRR) that were employed to accurately differentiate the effects of all of the factors involved. In general, these HF parameters are used to compare human performance using one display or operational concept to another display or operational concept. Results are usually limited to saying that one display, operational concept, etc. is as good, as or better than, another display or operational concept. There is some concern about using these metrics for comparisons across largely different scenarios, such as encountered between VMC and IMC flight.

7.0 Conclusions

A flight test was performed to compare the use of three advanced primary flight and navigation display concepts to a baseline, round-dial concept to assess the potential for advanced operations. The displays were evaluated during visual and instrument approach procedures including an advanced instrument approach resembling a visual airport traffic pattern. Nineteen pilots from three pilot groups, reflecting the diverse piloting skills of the General Aviation pilot population, served as evaluation subjects. Specifically, three hypotheses characterizing potential transformations were defined. The hypotheses can be summarized as follows:

1. *Using SVS displays, the workload and SA results of all pilots flying landing approaches in IMC will be as good as, or better than, the same pilots flying in VMC using baseline round-dial displays.*

2. *Using SVS displays, low-time, non-instrument-rated pilots flying nominal ILS approaches in IMC will achieve flight technical error, workload, and SA results as good as, or better than, ratings from instrument-rated pilots conducting the same ILS approach using baseline, round-dial displays.*
3. *Using SVS displays, all pilots, including low-time, non-instrument-rated pilots, will be able to conduct IMC approaches with geometries similar to a VFR pattern with flight technical error, workload, and SA results as good as, or better than, results from instrument rated pilots conducting ILS approaches using baseline round-dial displays.*

The flight test had four unique elements to assess these hypotheses. The first was including non-instrument-rated pilots in the evaluation of instrument procedures in simulated IMC. This inclusion allowed direct comparison of the performance and ratings of non-IFR-rated pilots using SVS displays and IFR-rated pilots using conventional instrumentation. The second element was including operations in both VMC and simulated IMC. This aspect of the test enabled direct comparisons of workload and situation awareness ratings across these very different operational environments. The third element was the inclusion of an instrument approach pattern that overlaid a typical VFR airport traffic pattern. Including this element allowed direct comparison of this advanced operation conducted with SVS display versus conventional operations and displays. The fourth element was including a progression of advanced display concepts. This aids in assessing display elements that are essential towards enabling significant operational changes.

Relative to the three hypotheses, the results of the test can be summarized as follows:

Hypothesis 1 is supported by the analyses for SART (situation awareness) and TLX (pilot workload). Results for the SVS display concept evaluations for the ILS and VMC-like approaches were significantly better than the SCFD and PBG display concepts for these measures. SART and TLX results for the SVS display concept IMC evaluations were as good as or better than the VFR evaluation of the BRD display concept. These results show that using as SVS display, the workload and SART ratings of all the subject pilots flying landing approaches in IMC were as good as, or better than, the same pilots flying in VMC using baseline round-dial displays.

Hypothesis 2 is supported by analysis that revealed that the VFR pilots' results for the SVS display concept ILS evaluations were improved for all of the flight technical error variables considered (PTS, lateral error, localizer error, and glideslope error), compared to those from the IFR and H-IFR pilots for the ILS evaluation of the BRD display concept. Also, VFR-pilot results for the SVS display concept during the ILS evaluations were significantly improved for vertical error as well as SART and TLX results. While a bias in the VFR pilots' results was encountered that illustrated a tendency of these pilots to provide higher SART ratings than the other two pilot groups, the increase in SA provided by SVS displays is considered much larger than the bias and more than compensated for this artifact in the data. IAS results indicate that VFR pilots' performance was slightly worse for the SVS display concept compared to the IFR and H-IFR pilots' evaluation of the BRD for the ILS approach, but not significantly. Regarding Hypothesis #2, these results show that using an SVS display, low-time, non-instrument-rated pilots flying nominal ILS approaches in IMC can achieve flight technical error, workload and SART ratings as good as, or better than, ratings from instrument-rated pilots conducting the same ILS approach using baseline round-dial displays.

Hypothesis 3 is supported by all pilot types, including low-time VFR-rated pilots, generating similar or much better flight-technical- and IAS-error results for the SVS display concept evaluations for the VMC-like approach compared to the IFR and H-IFR pilots using the BRD display concept for the ILS approach. Analysis also revealed that results for the VMC-like approach using the SVS display concept, evaluations were improved, but not significantly, for many of the variables considered (PTS, lateral error, localizer error, and glideslope error). Vertical error, as well as SART and TLX results, were significantly

improved for the SVS display for the VMC-like approach compared to the IFR and H-IFR pilot evaluations of the BRD display concept for the ILS approach. The IAS results indicate that performance was slightly worse for the SVS display concept for the VMC-like approach compared to the IFR and H-IFR pilots' evaluation of the BRD for the ILS approach, but again not significantly. With regard to hypothesis #3, these results show that using an SVS display, all the subject pilot types, including low-time, non-instrument rated pilots, were able to conduct IMC approaches with geometries similar to a VFR pattern with flight technical error, with workload and SART ratings as good as, or better than ratings from instrument-rated pilots conducting ILS approaches using the baseline round-dial display.

Considering all 3 hypotheses, all advanced display concepts were able to satisfy hypothesis #2 as a result of the VFR pilots being able to generate flight technical error results as good as or better than the IFR and H-IFR pilots' evaluation of the BRD display concept for the ILS approach. For the VMC-like approach only the SVS display concept was able to satisfy hypothesis #3 due to the poor lateral and localizer error results for the SCFD, and poor glideslope and vertical error for the PBG. Due to the SVS displays' significantly improved SART results, the SVS display was able to satisfy hypothesis #1 and was the only one to be able to satisfy all three hypotheses simultaneously.

Several other noteworthy observations can be made from the results. While improvements due to the moving map ND and integrated PFD were observed compared to the baseline round-dial display concept, the results indicate additional variability among the advanced guidance concepts (i.e., SCFD and PBG). As a result of the improved flight path awareness, the HITS guidance provided improved results for qualitative measures, such as SART and TLX, and also quantitative measures, such as lateral flight path error and localizer error. While the SCFD display concept did provide significantly reduce vertical flight path and glideslope error compared to the PBG display concept, overall, the improvements in lateral flight path and localizer error provided by the HITS guidance provided superior performance enabling more potential applications for future RNP based procedures with curved segments. In addition to the expected improvements in situation awareness (including terrain) with SVS terrain displayed, improvements in glideslope error were also evident with SVS display concept for the VMC-like approach. This suggests that the terrain background improves the ability of pilots (in particular VFR pilots) to perceive and control glideslope error as compared to a HITS without terrain. This effect was particularly apparent during dynamic approach segments such as the turn to final of the VMC-like approach. Pilots were able to use the SVS terrain to better monitor attitude, turn rate, and flight path angle during the turns. On final approach the presence of the runway model complemented use of the velocity vector and HITS guidance.

Support for the hypotheses considered in this test suggests that SVS does have a significant effect on flight in IMC and may enable new types of operations and significantly alter the training needed to safely and comfortably operate in IMC. At the same time, it is important to recognize that this test only examined nominal approaches and did not include traffic separation, hazardous weather, equipment failures, etc. Also, other important rating factors, such as measures of pilots' decision-making ability or possible overconfidence were not considered. It is recommended that future studies build on this study by investigating the transformative properties of SVS displays in the presence of more comprehensive operational considerations and while stressing the importance of effective decision making by pilots of all experience levels.

8.0 References

- [1] Glaab, L.; and Hughes, M.: Terrain Portrayal for Head-Down Displays Flight Test., Proceedings of the 22nd Digital Avionics Systems Conference, 2003.
- [2] Hughes, M.; and Glaab, L.: Terrain Portrayal for Head-Down Displays Simulation Experiment Results, Proceedings of the 22nd Digital Avionics Systems Conference, 2003.
- [3] Takallu, M.; Wong, D.; Bartolone, A.; Hughes, M.; and Glaab, L.: Interaction Between Various Terrain Portrayals and Guidance/Tunnel Symbology Concepts for General Aviation Synthetic Vision Displays During a Low En-Route Scenario, Proceedings of the 23rd Digital Avionics Systems Conference, 2004.
- [4] Wong, D.; Takallu, M.; Hughes, M.; Bartolone, A.; and Glaab, L.: Simulation Experiment for Developing the Symbology for the Approach and Missed Approach Phases of Flight for Head-Down Synthetic Vision Systems Displays. Proceedings of the AIAA Modeling and Simulation Technologies Conference and Exhibit, AIAA-2004-5440, 2004.
- [5] Kramer, L.; Prinzel, L.; Bailey, R.; Arthur, J.: Synthetic Vision Enhances Situation Awareness and RNP Capabilities for Terrain-Challenged Approaches. Proceedings of the AIAA Third Aviation Technology, Integration, and Operations Technical Forum, AIAA-2003-6814, 2003.
- [6] Lemos, K.; and Schnell, T.: Synthetic Vision Systems: Human Performance Assessment of the Influence of Terrain Density and Texture. Proceedings of the 22nd Digital Avionics Systems Conference, October 2003.
- [7] Schnell, T.; Etherington, T.; Vogl, T.; and Postnikov, A.: Field Evaluation of A Synthetic Vision Information System Onboard the NASA ARIES 757 at Eagle County Regional Airport, Proceedings of 21st Digital Avionics Systems Conference, October 2002.
- [8] Prinzel, L.; Arthur, J.; Kramer, L.; and Bailey, R.: Pathway Concepts Experiment for Head-Down Synthetic Vision Displays, Proceedings of the International Society For Optical Engineering, Volume 5424, 2004.
- [9] Glaab, L.; Kramer, L.; Arthur, J.; and Parrish, R.: Flight Test Evaluation of Synthetic Vision Display Concepts at Dallas/Fort-Worth Airport, NASA/TP-2003-212177, 2003.
- [10] Bailey, R.; Kramer, L.; and Prinzel, L.: Crew and Display Concepts Evaluation for Synthetic / Enhanced Vision Systems. Proceedings of the International Society For Optical Engineering, Volume 6226, 2006.
- [11] Bartolone, A.; Glaab, L.; Hughes, M.; and Parrish, R.: Initial Development of a Metric to Describe the Level of Safety Associated With Piloting An Aircraft With Synthetic Vision Systems (SVS) Displays. Proceedings of the International Society For Optical Engineering, Volume 5802, May 2005.
- [12] Takallu, M.; Glaab, L.; Hughes, M.; Wong, D.; and Bartolone, A.: Piloted Simulation of Various Synthetic Vision Systems Terrain Portrayal and Guidance Symbology Concepts for Low Altitude En-Route Scenario. NASA/TP-2008-215127, 2008.
- [13] General Aviation Manufacturers Association (GAMA), Publication #12: Recommended Practices and Guidelines for an Integrated Cockpit/Flight Deck in a 14 CFR Part 23 Certificated Airplane, GAMA, Washington, D.C., 2004.
- [14] AC 23-23, Standardization Guide for Integrated Cockpits in Part 23 Airplanes, Staff of the Federal Aviation Administration, 9/30/2004.
- [15] AC 23-26, Synthetic Vision and Pathway Depictions on the Primary Flight Display, Staff of the Federal Aviation Administration, 12/22/2005.
- [16] Glover, Howard: Terrain Displays for Enhanced Ground Proximity Warning Systems, AIAA-975557, 1997.
- [17] Breen, B.C.. Enhanced situation awareness. In C. Spitzer (Ed.), Avionics Handbook. Boca Raton, FL: CRC Press. 2001.
- [18] Glaab, Louis J.; Parrish, Russell V.; Hughes, Monica F.; Takallu, Mohammad A.: Effectively Transforming

IMC Flight Into VMC Flight: An SVS Case Study. Presented at the 25th Digital Avionics Systems Conference (DASC), Portland, OR., 2008-14170, 2006.

- [19] Guide to Human Performance Measurement. American Institute of Aeronautics and Astronautics, Washington D.C., 1993.
- [20] Hart, S.; and Staveland, L.: Development of the NASA Task Load Index (TLX): Results of Empirical and Theoretical Research, In P.A. Hancock & N. Meshkati (Eds.), Human Mental Workload, Elsevier Publishing, Amsterdam, Holland, 1988.
- [21] Chiappetti, C.: Evaluation of the Haworth-Newman Avionics Display Readability Scale, Naval Postgraduate School Thesis, Monterey, CA, 1994.
- [22] Instrument Rating Practical Test Standards for Airplane, Helicopter and Powered Lift, Staff of the Federal Aviation Administration, (2004).
- [23] DO-236A, Minimum Aviation System Performance Standards: Required Navigation Performance for Area Navigation, RTCA, 2000.
- [24] FAA Order 8260.3, United States Standard for Terminal Instrument Procedures (TERPS), Staff of the Federal Aviation Administration.

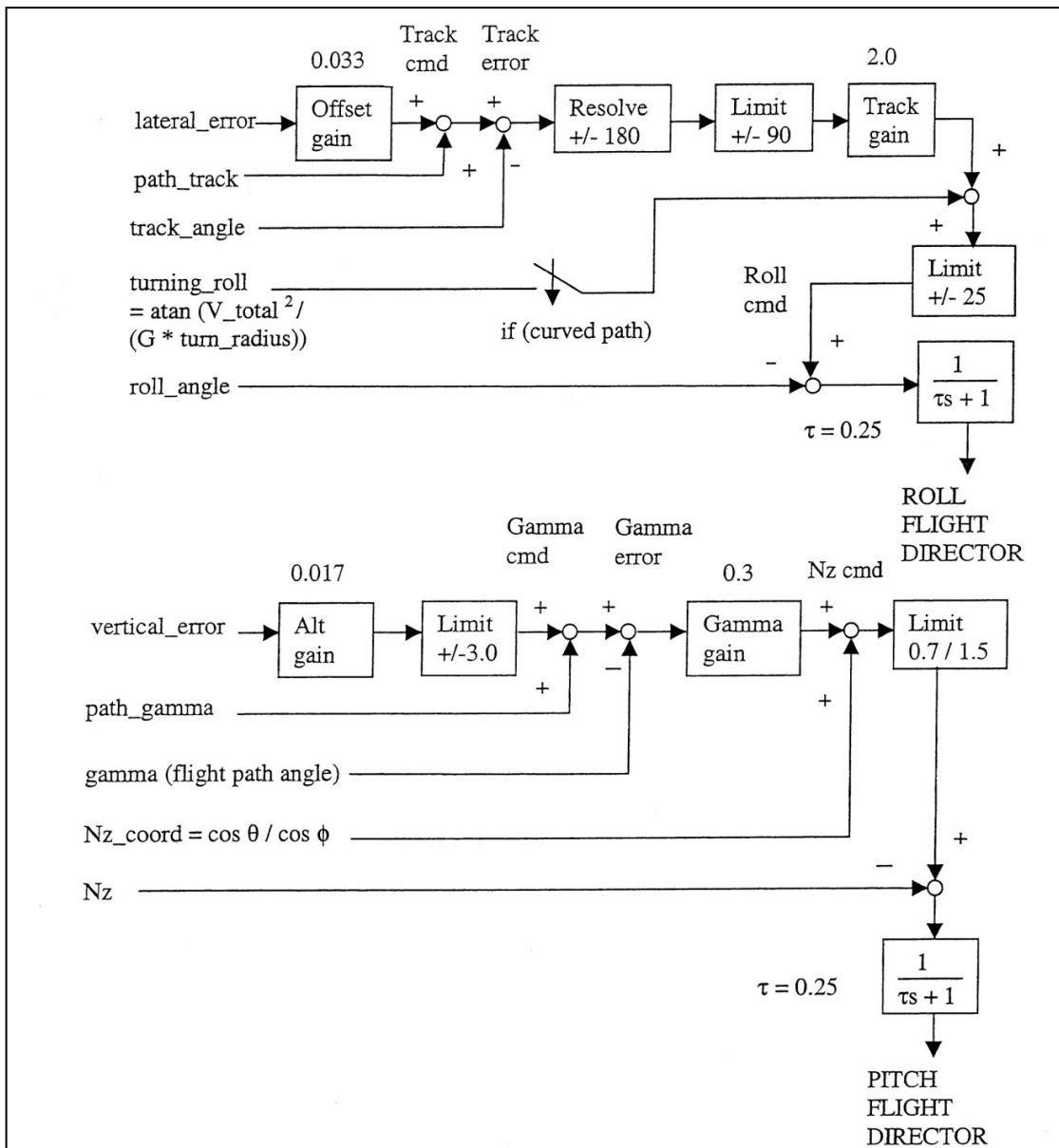

Figure A- 2: Single-Cue Flight Director pitch and roll attitude command block diagram.

Similarly, vertical flight path and flight path-angle errors were combined in the pitch attitude command system and added to the normal acceleration required to maintain a coordinated turn with the current pitch and roll attitudes. This signal was then compared to the current normal acceleration with the difference being scaled and used to drive the yellow pitch/roll command triangles up/down with respect to the orange reference triangle. The Offset, Track, Altitude and Gamma gain parameters were tuned to provide acceptable dynamic responses to linear (e.g., lateral and vertical) and angular (e.g., ground-track and flight path-angle) errors.

Table A-1 provides definitions of the various components of the SCFD system along with the actual values for the Offset, Track, Altitude and Gamma gains used for this flight test. These gains were

evaluated in flight during checkout operations and adjusted accordingly to provide reasonable qualitative performance of the SCFD system. No specific adjustments were made to this system to compare with the Highway-In-The-Sky guidance system used for the Pathway-Based Guidance and Synthetic Vision System display concepts.

Table A-1. Flight Director Parameters

Symbol	Type	Description	Unit/ Value
Lateral_error	Input	Ownship lateral distance closest to the flight path	ft
Path_track	Input	Flight plan track angle	deg
Track_angle	Input	Actual ownship track angle	deg
Turning_roll	Input	Desired roll angle (for curved path only)	deg
V_total	Var	True airspeed	ft/sec
G	Const	Gravitational acceleration	32.2 ft/sec ²
Turn_radius	Var	Turning radius from the flight path	Ft
Roll_angle	Input	Ownship actual roll angle	Deg
Offset gain	Const	Lateral error gain	0.033 deg/ft
Track gain	Const	Track error gain	2.0
vertical_error	Input	Current Ownship vertical flight path error	ft
path_gamma	Input	Commanded vertical flight path angle	deg
Gamma	Input	Actual vertical flight path angle	deg
ϕ	Input	Ownship roll angle	rad
θ	Input	Ownship pitch angle	rad
Nz_coord	Input	Normal acceleration of a coordinated turn = $\cos\theta / \cos\phi$	g
Nz	Input	Actual normal acceleration	g
Alt gain	Const	vertical_error gain	0.068deg/ft
gamma gain	Const	Vertical flight path angle gain	0.3 g/deg
τ	Const	Pitch/roll flight director filter time constant	sec

Appendix B: Highway-In-The-Sky Guidance System

The intent of the Highway-In-The-Sky (HITS) guidance system was to provide the general functionality of this type of flight guidance within the data set. In general, flight path guidance systems of this type provide lateral and vertical cues for the pilot to follow to achieve acceptable flight path errors. Figure B1 below shows what the Primary Flight Display (PFD) looked like for the Synthetic Vision System (SVS) display concept.

For the current study, a concept known as the Crows-Foot tunnel with tadpole guidance was selected. This concept provides good situation awareness of the intended flight path without cluttering the display and compromising the value of the SVS terrain and is described further in References 3, 4, 8, 9, 11 and 12. The right-angle magenta triads formed the corner points of the desired flight path tunnel. The tunnel was set to 2 dots of localizer error and 1 dot of glideslope error and limited to 600 ft wide and 350 ft tall.

The pilot's task was to adjust the aircraft's flight path and track angles to overlay the velocity vector (white circle with left, right, and top white fins) with the magenta guidance cue (tadpole). To provide enhanced flight path control, the velocity vector was quickened with pitch rate to eliminate the non-minimum phase response of the C206 to elevator commands. The tadpole guidance cue was located using modified pursuit guidance where the cue was located at a point along the desired flight path approximately 15 seconds in front of the aircraft's current location as described in Reference B1. The top of the magenta guidance cue (also known as a tadpole) would lean in the direction of the upcoming turn to provide additional turn awareness. This particular image is indicating that the pilot needs to roll the aircraft to the right to eliminate a lateral error.

Appendix B references:

- B1: Merrick, V.K., & Jeske, J.A., "Flight Path Synthesis and HUD Scaling for V/STOL Terminal Area Operations," NASA TM-110348, April 1995.

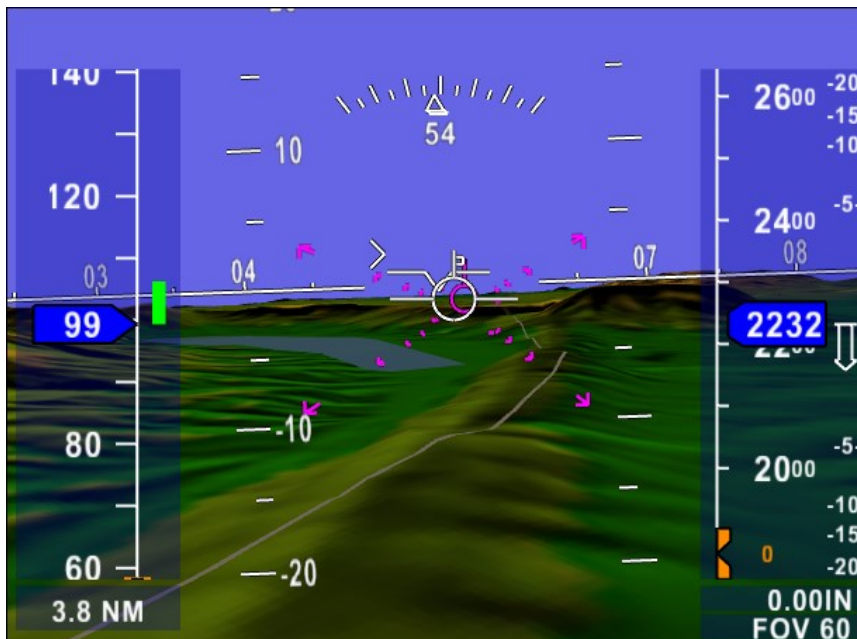

Figure B- 1: SVS Primary Flight Display showing HITS guidance symbology.

Appendix C: Questionnaires

C.1 General

The questionnaires administered in support of this test are included in this appendix. They are listed as either post-run or post-test. Post-run questionnaires were those administered immediately after each run. Evaluation pilots were provided as much time as they needed to answer the basic block of post-run questions. The extended post-run questions were answered whenever time permitted, such as during initializations of the ILS approach since it took extra time to perform this operation, or during ATC-induced delays. Post-test questionnaires were those administered following a short break after all testing was complete.

C.2 Evaluation Pilot Questionnaire (EPQ) Tool

In order to expedite the acquisition of qualitative pilot rating data during the flight test, a hand-held pocket personal computer was used. Evaluation pilots were instructed to read the question aloud and then move the response indicator marker using the stylus to the selected response location. Evaluation pilots were also asked to provide any additional verbal comments before selecting the next page. Figure C-1 shows what the EPQ looked like to the EP for the performance question of the TLX questionnaire section. The response scale was similar for most questions with the end descriptors adjusted accordingly (i.e., good/poor or high/low etc.). For the DRR question block, the EPs responded yes/no to a series of questions and ultimately selected a single numerical score.



Figure C- 1: Example image of the Evaluation Pilot Questionnaire tool.

For the DRR questions, EPs first responded to a series of yes/no questions to navigate through the decision tree logic. They then selected the most appropriate response from a limited subset of DRRs. For example, if EPs answered yes to “Is the Display Readable?” and yes to “Is adequate performance attainable with a tolerable workload” and yes to “Is it satisfactory without improvement?”, EPs could then select from DRRs of 1, 2, or 3 with the associated Characteristics of Display Parameters and Demands on Pilot During Scenario phrases.

C.3 Post-Run Questionnaires, basic block:

Instructions: Answer the following questions by moving the slider icon to the appropriate location. Press the “Next Question” button when finished.

Situation Awareness Rating Technique (SART)

SART 1: Demand on Attentional Resources: Rate your overall impression of the scenario in terms of how much attention and effort was required to successfully perform the task of piloting the aircraft. Items to consider include the likelihood of the situation to change suddenly (instability), the degree of complication associated with the scenario (complexity), and the number of variables changing during the scenario (variability).

SART 2: Supply of Attentional Resources: Rate your overall impression of the scenario in terms of how much spare attention was available for secondary tasks after the primary task of piloting the aircraft is accounted for. Items to consider include your degree of readiness for the primary task (arousal), your level of concentration during the primary task (concentration), the necessity and frequency of attention division between the primary task and any sub-tasks (division), and the amount of attention left over from the primary task to allocate to new variables of sub-tasks (spare capacity).

SART 3: Understanding of the Situation: Rate your overall understanding of what was occurring during the scenario. Items to consider are the amount of information received and understood during the scenario (quantity), the value of the information (quality), and the familiarity you may have had with what was taking place during the scenario.

The SART result is calculated by: $SART\ 2 + SART\ 3 - SART\ 1$

Terrain Awareness Question

Terrain Awareness: Rate your overall understanding of the terrain environment you were operating within. Items to consider are the quantity and quality of the terrain information available to you and how comfortable you were with your terrain awareness during this scenario.

NASA Task Load Index (TLX) Workload Measurement Questionnaire

Mental Demand: How much mental and perceptual activity was required (e.g. thinking, deciding, calculating, remembering, looking, searching, etc.)? Was the task easy or demanding, simple or complex, exacting or forgiving?

Physical Demand: How much physical activity was required (e.g. pushing, pulling, turning, controlling, activating, etc.)? Was the task easy or demanding, slow or brisk, slack or strenuous, restful or laborious?

Temporal Demand: How much time pressure did you feel due to the rate or pace at which the tasks or task elements occurred? Was the pace slow and leisurely or rapid and frantic?

Performance: How successful do you think you were in accomplishing the goals of the task set by the experimenter (or yourself)? How satisfied were you with your performance in accomplishing these goals?

Effort: How hard did you have to work mentally and physically to accomplish your level of performance?

Frustration Level: How insecure, discouraged, irritated, stressed, and annoyed versus secure, gratified, content, relaxed, and complacent did you feel during the task?

The TLX result is calculated by: $(\text{Mental Demand} + \text{Physical Demand} + \text{Temporal Demand} + \text{Performance} + \text{Effort} + \text{Frustration Level})/6.0$. Since the Performance scale was oriented in the same direction as the other scales, that parameter was subtracted from the summation of the other parameters.

Hayworth-Newman Display Readability Rating (DRR) Scale:

The Hayworth-Newman Display Readability Rating scale is shown below is Figure C2. This rating scale is also referred to as a Modified Cooper-Harper rating in some literature. Evaluation pilots responded to the DRR questions in a decision tree format starting with the first question “Is the display readable?”. The DRR scale can be described as having three levels of response. Level 1 corresponds to responses 1, 2, or 3 and requires the EP to answer “yes” to the question of “Is it satisfactory without improvement?”. Level 2 corresponds to responses 4, 5, or 6 and requires the EP to answer “yes” to the question “Is adequate performance attainable with a tolerable workload?” but answer “no” to “Is it satisfactory without improvement?”. Level 3 corresponds to 7, 8, 9. A DRR of 10 exceeds Level 3. Evaluation Pilots were able to select DRR scores from Level 1, Level 2, Level 3, or DRR=10 depending on their responses to the initial decision tree questions.

Post-run questions, extended block:

GEOGRAPHICAL SA - Provide an estimate of your geographical situation awareness while flying the approach. Items to consider when marking your response include: knowledge of the location of your aircraft; other aircraft; terrain features; airports; cities; waypoints; position relative to obstacles; path conflicts; and climb/descent points.

SPATIAL SA - Provide an estimate of your spatial situation awareness while flying the approach. Items to consider when marking your response include: knowledge of your aircraft's attitude; altitude; heading; velocity; vertical speed; and desired flight path.

TACTICAL SA - Provide an estimate of your tactical situation awareness while flying the approach. Items to consider when marking your response include: identification; location; and flight dynamics of other aircraft; own aircraft capabilities in relation to other nearby aircraft; and ATC communications.

PROJECTED SA - Provide an estimate of your ability to accurately predict the future state of your aircraft and the states of nearby aircraft while flying the approach. Items to consider when marking your response include: the projected status and dynamics of your aircraft; projected status and dynamics of other nearby aircraft; anticipation of possible future conflicts with traffic or obstacles; and threat prioritization.

MENTAL WORKLOAD - Provide an estimate of the amount of mental workload required to successfully complete the assigned task of flying the approach.

PHYSICAL WORKLOAD - Provide an estimate of the amount of physical workload required to successfully complete the assigned task of flying the approach.

SPARE CAPACITY - Provide an estimate of the amount of mental resources remaining that could be used to process new information after all the necessary mental tasks associated with successfully flying the approach have been accounted for.

STRESS - Provide an estimate of the amount of stress (physical and mental) you experienced while completing the assigned task of flying the approach.

DATA LOCATION - The location of flight data on the displays critical to the task of flying the approach was efficiently organized minimizing the effort required to gather information.

DATA VALUE- The flight data presented on the displays was complete, valuable, and had a significant impact on my ability to successfully fly the approach.

DATA CLARITY - The flight data presented on the displays while flying the approach was clear, simple to read, and easy to interpret.

DATA INTEGRATION - The flight data gathered from the displays was easily and rapidly integrated into a meaningful mental representation of the current and future operating status of my aircraft.

DATA CONTENT - The flight data presented on the displays was excessive and included unnecessary information

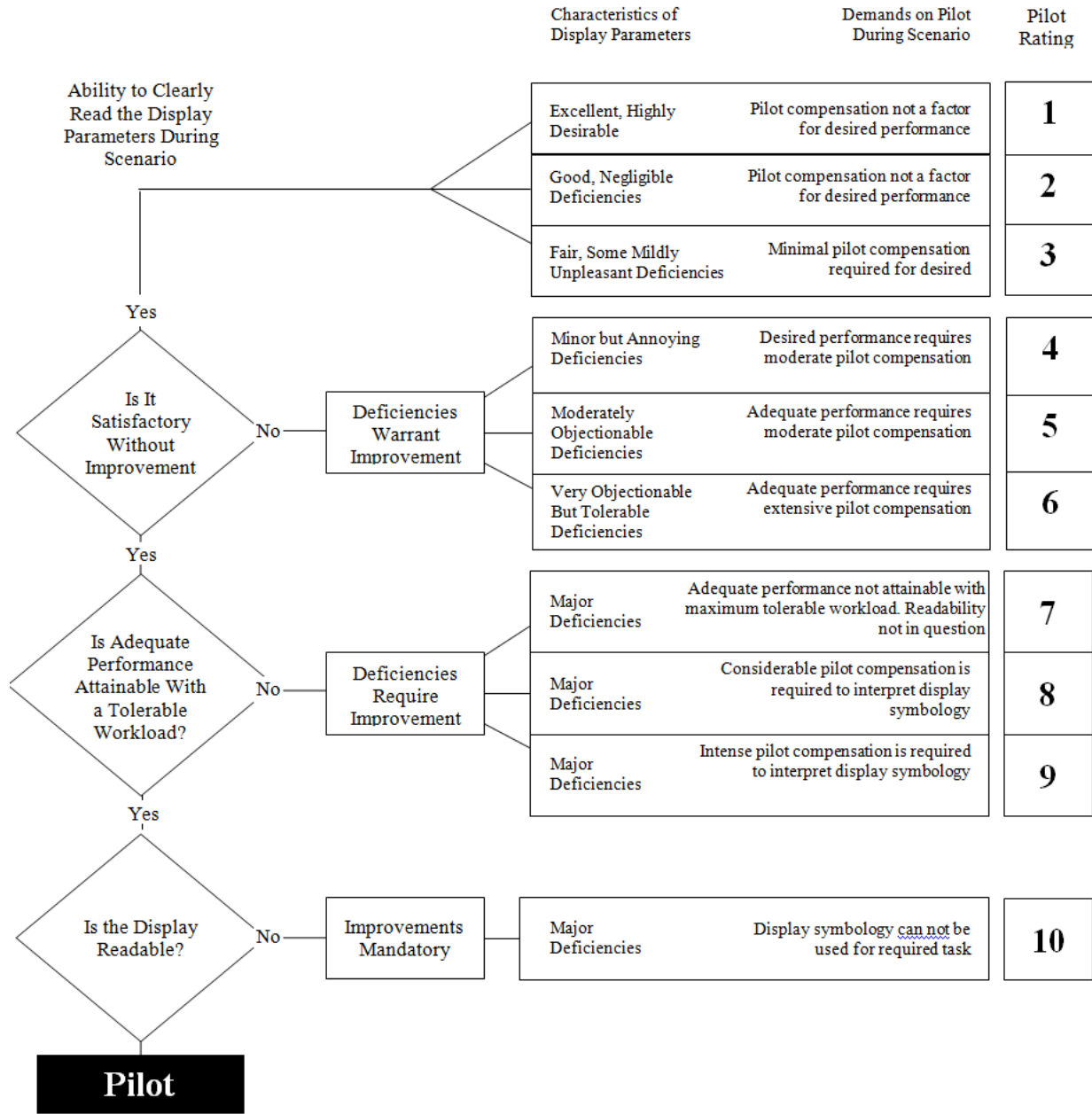

Figure C- 2: Hayworth-Newman Modified Cooper Harper (Display Readability).

Appendix D: Individual Subjective Data Plots

This appendix provides individual responses to the pilot questionnaires described in Appendix C and reported in the main body of the report. The data presented in this appendix include situation awareness (SART), subjective workload (TLX), display readability rating (DRR), and terrain awareness (TA). The plots are arranged by approach (i.e., VFR, IFR, and VMC-like) with four plots per parameter for a total of 12 plots. In the main body of the report, results and conclusions regarding the effects of display concept and approach are emphasized. The plots in this appendix are designed to show the effect of pilot groups and the variability of results across all pilots. The ranges of the SART, TLX, DRR, and TA variables are provided in Table D-1.

Table D- 1: Ranges of SART, TLX, DRR, and TA Parameters.

#	Variable	Max	Min
1	SART	200 (great)	-100 (none)
2	TLX	100 (high)	0 (low)
3	DRR	10 (very bad)	1 (excellent)
4	TA	100 (high)	0 (none)

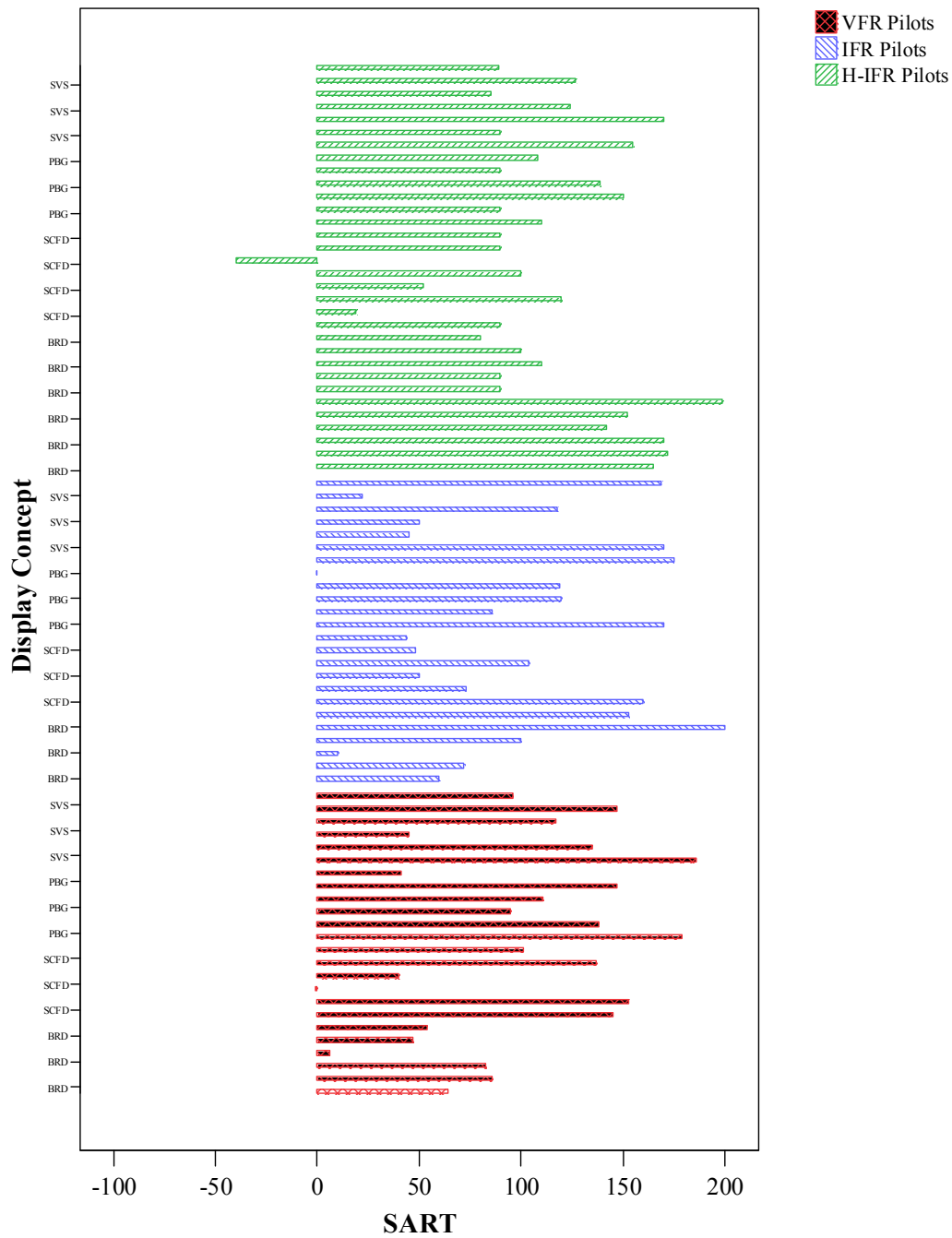

Figure D- 1: SART as a function of display concept and pilot type for each evaluation, VFR Approach.

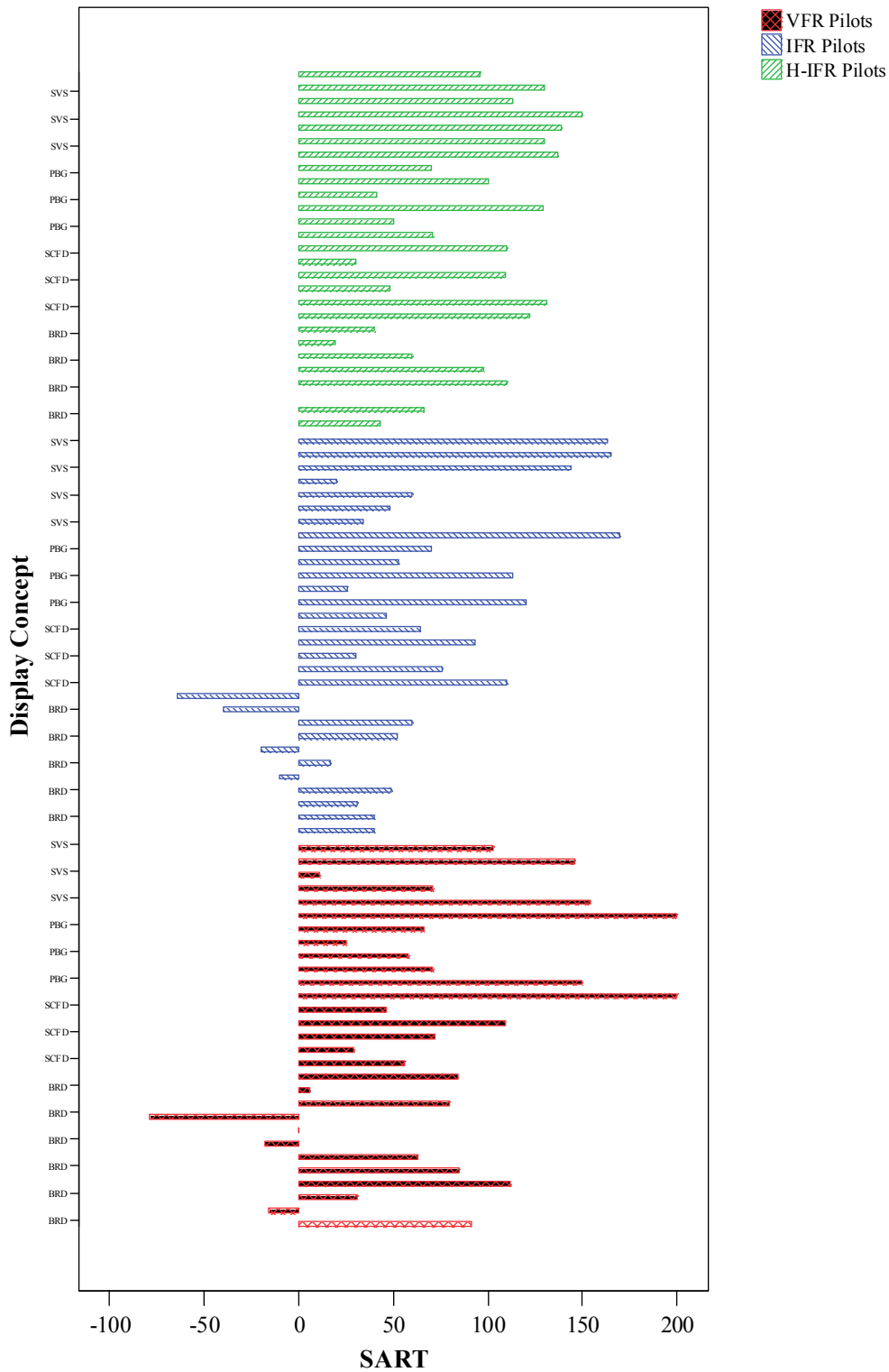

Figure D- 2: SART as a function of display concept and pilot type for each evaluation, ILS Approach.

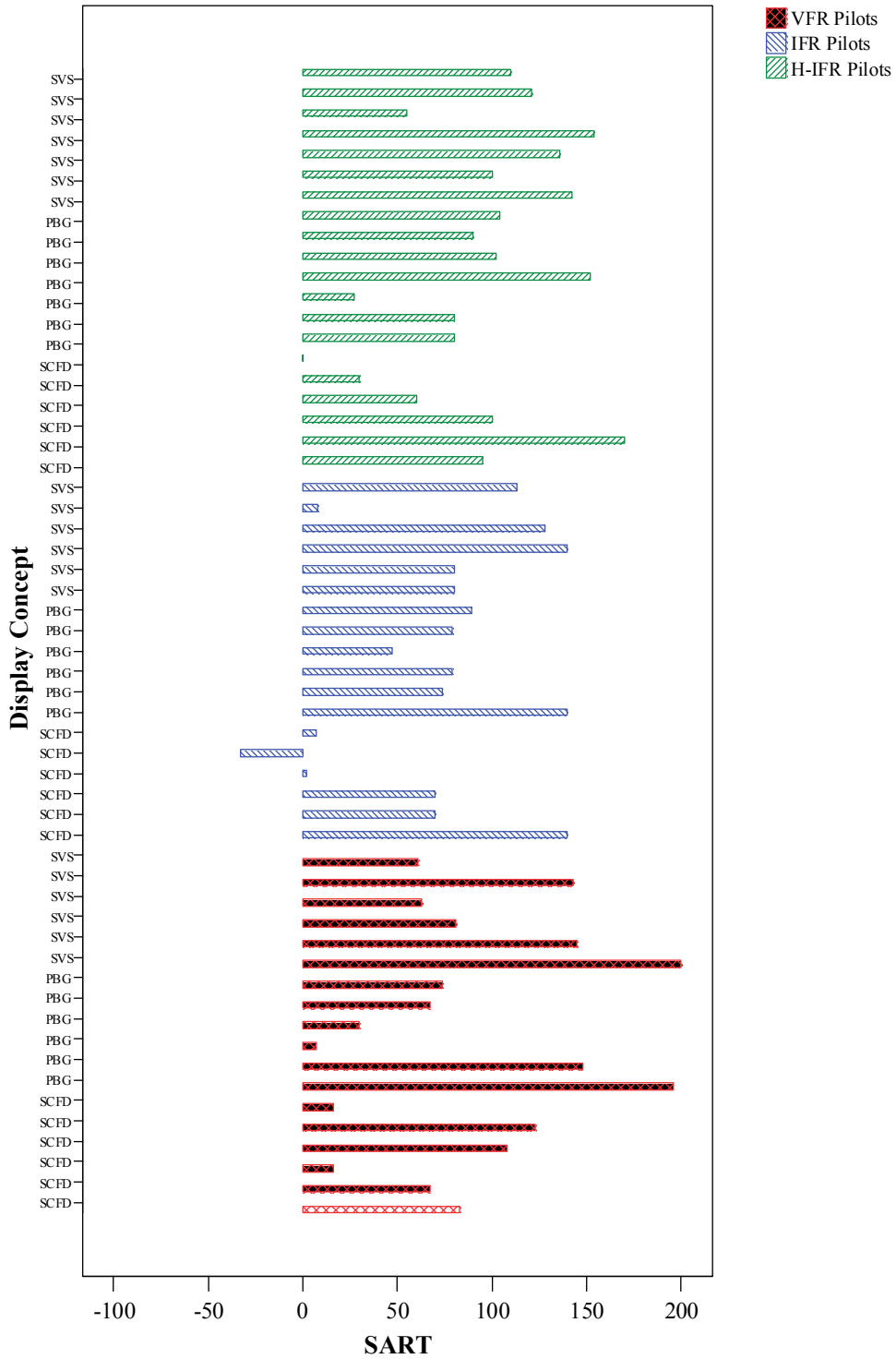

Figure D- 3: SART as a function of display concept and pilot type, VMC-like Approach.

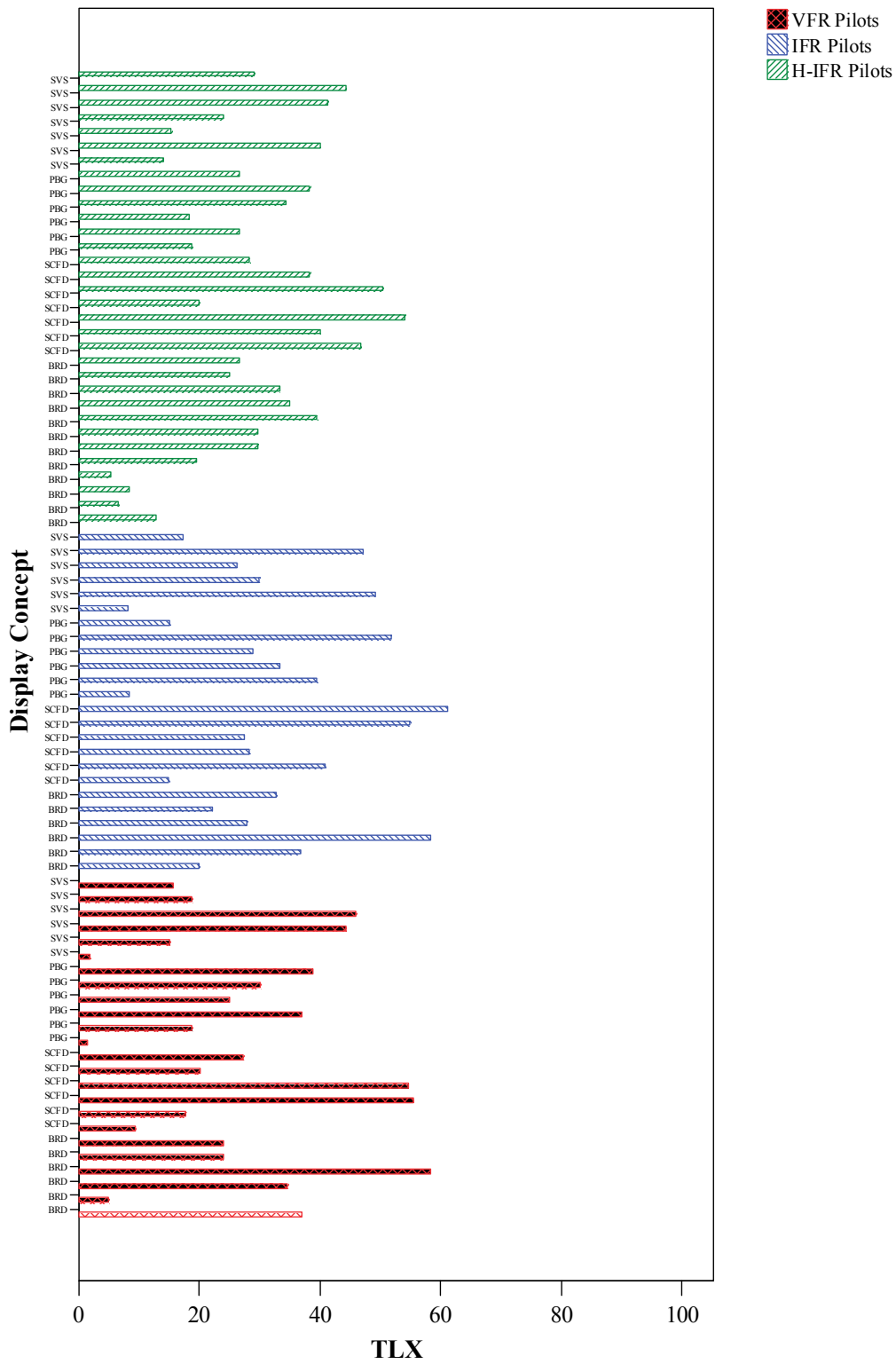

Figure D- 4 TLX as a function of display concept and pilot type, VFR Approach.

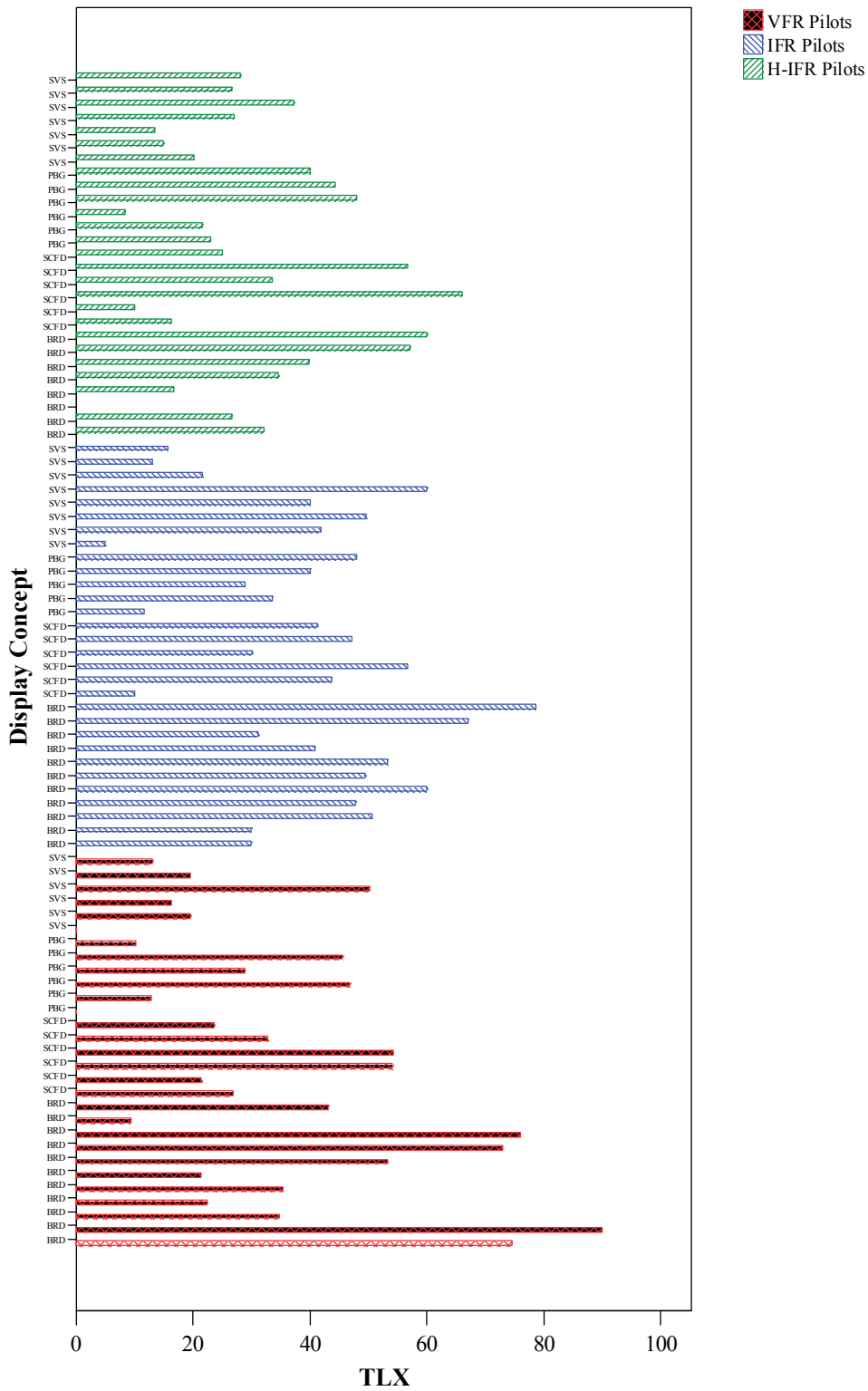

Figure D- 5: TLX as a function of display concept and pilot type, ILS Approach.

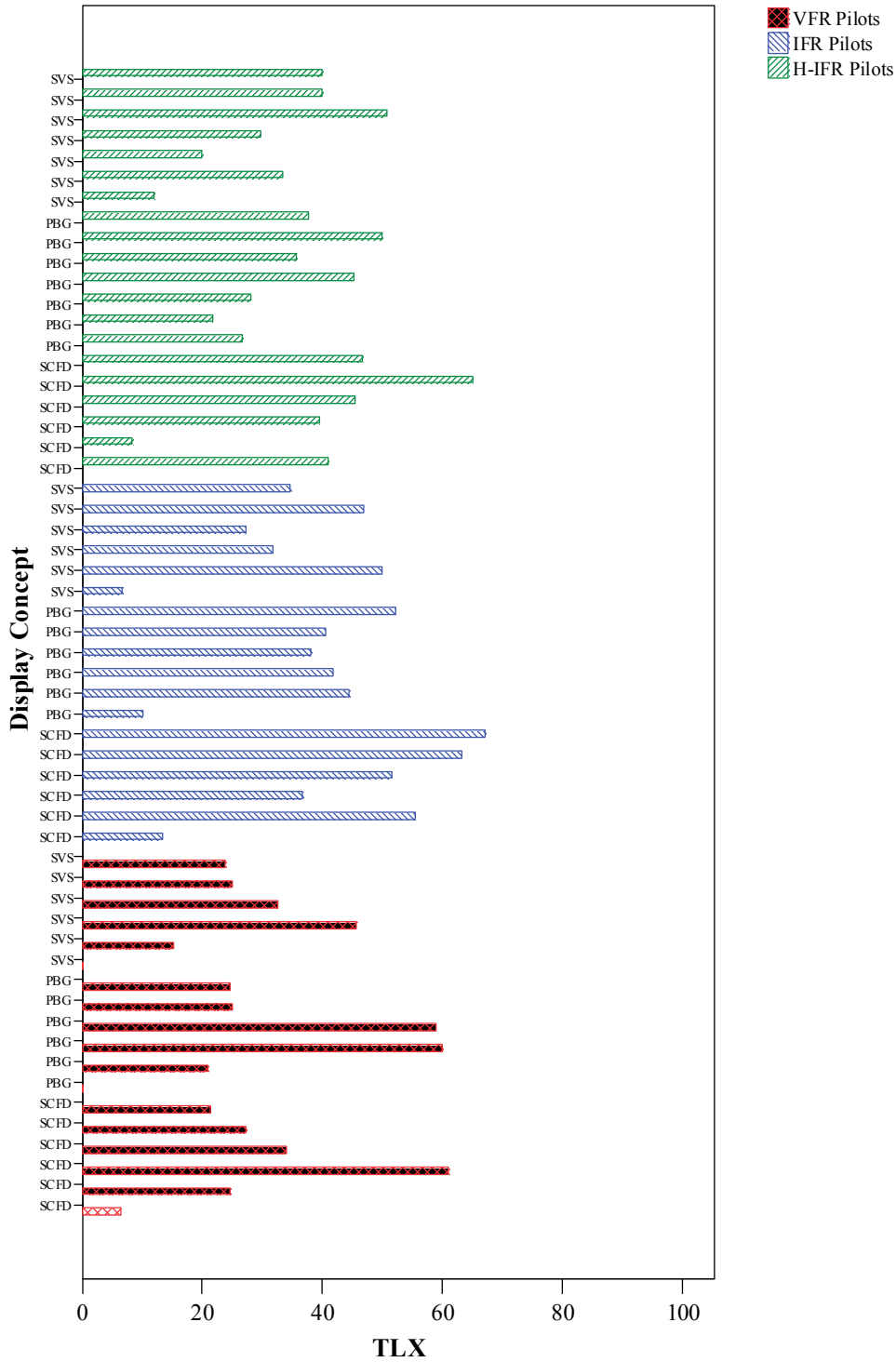

Figure D- 6: TLX as a function of display concept and pilot type, VMC-like Approach.

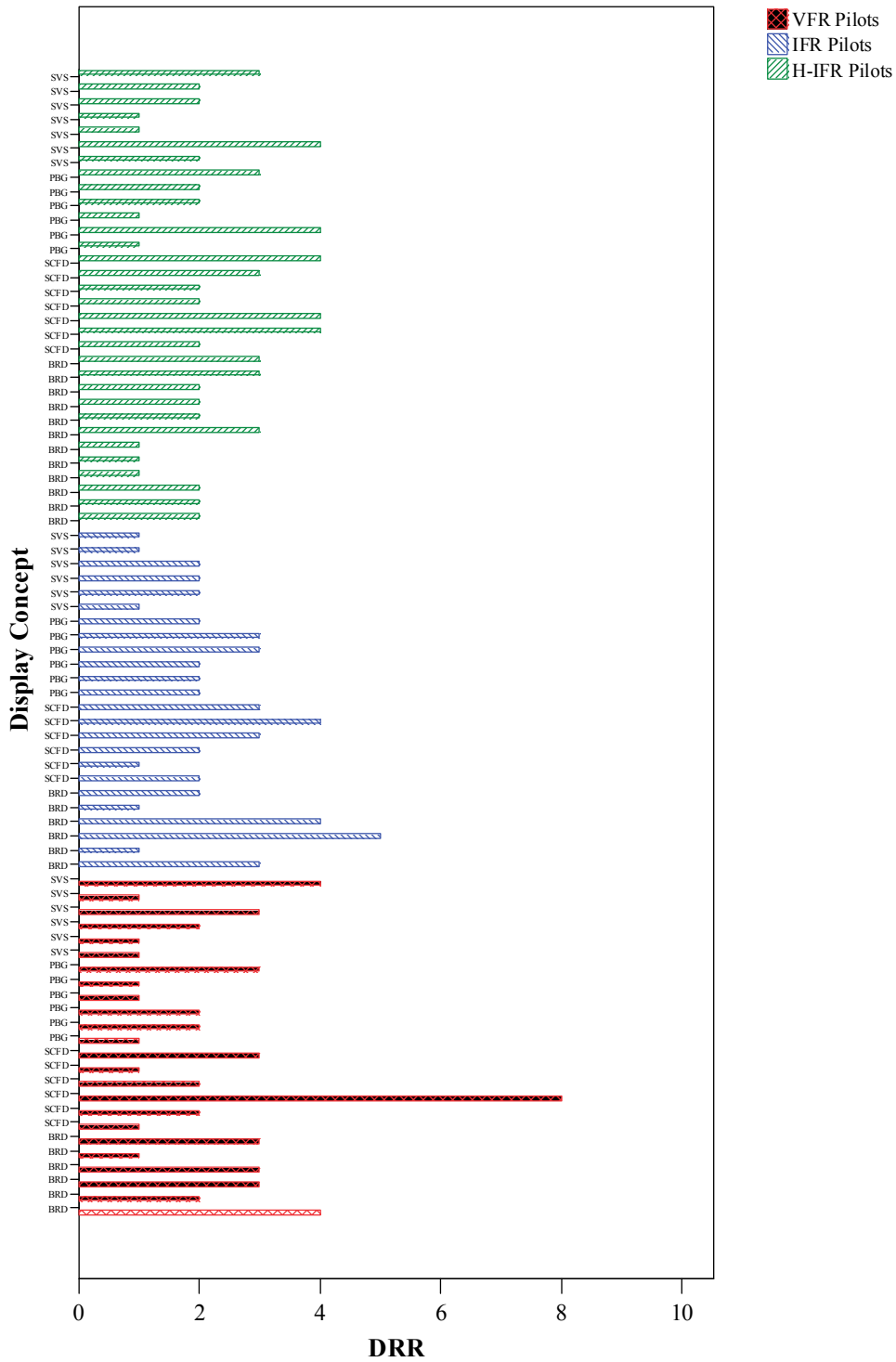

Figure D- 7: DRR as a function of display concept and pilot type, VFR Approach.

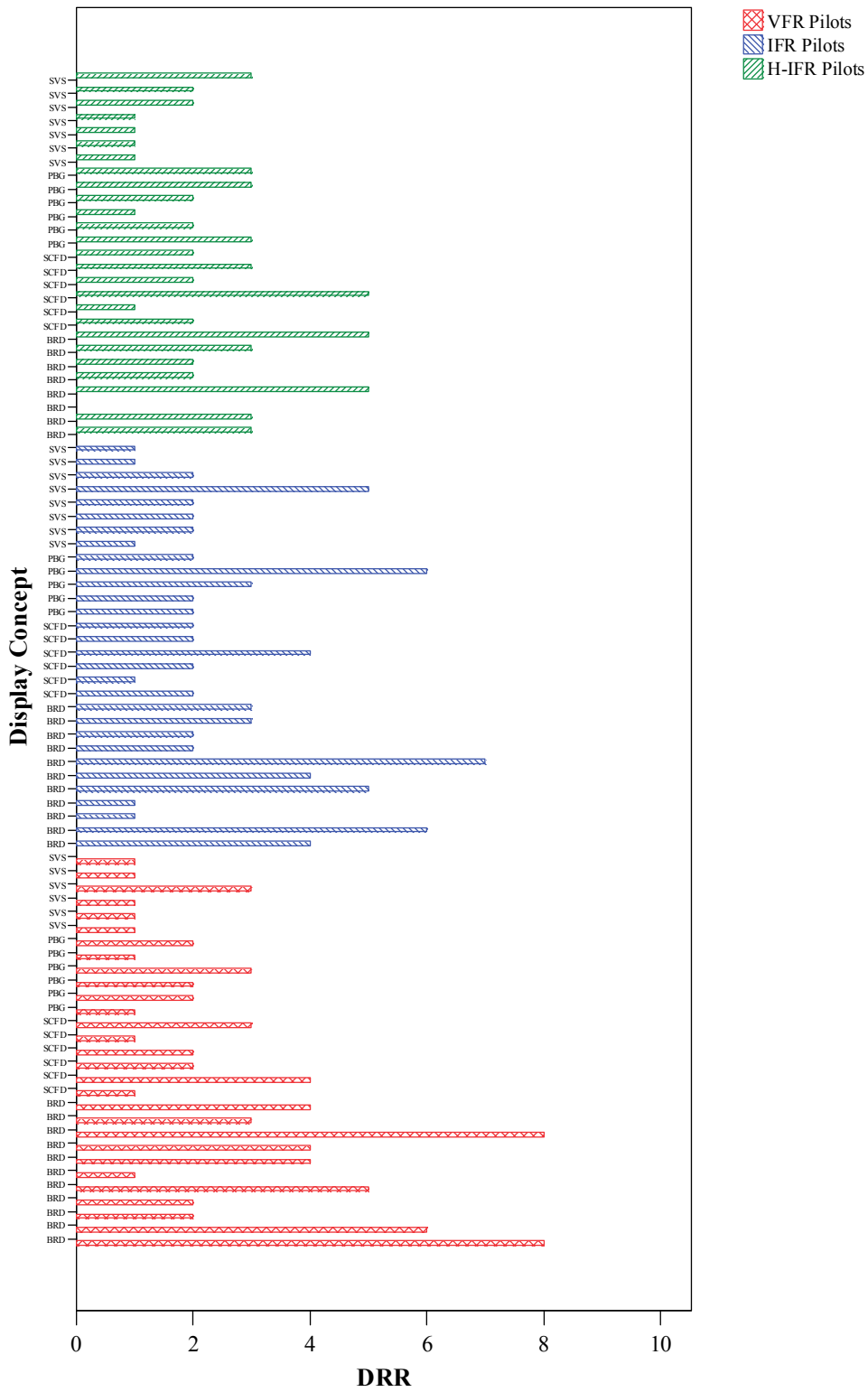

Figure D- 8: DRR as a function of display concept and pilot type, ILS Approach.

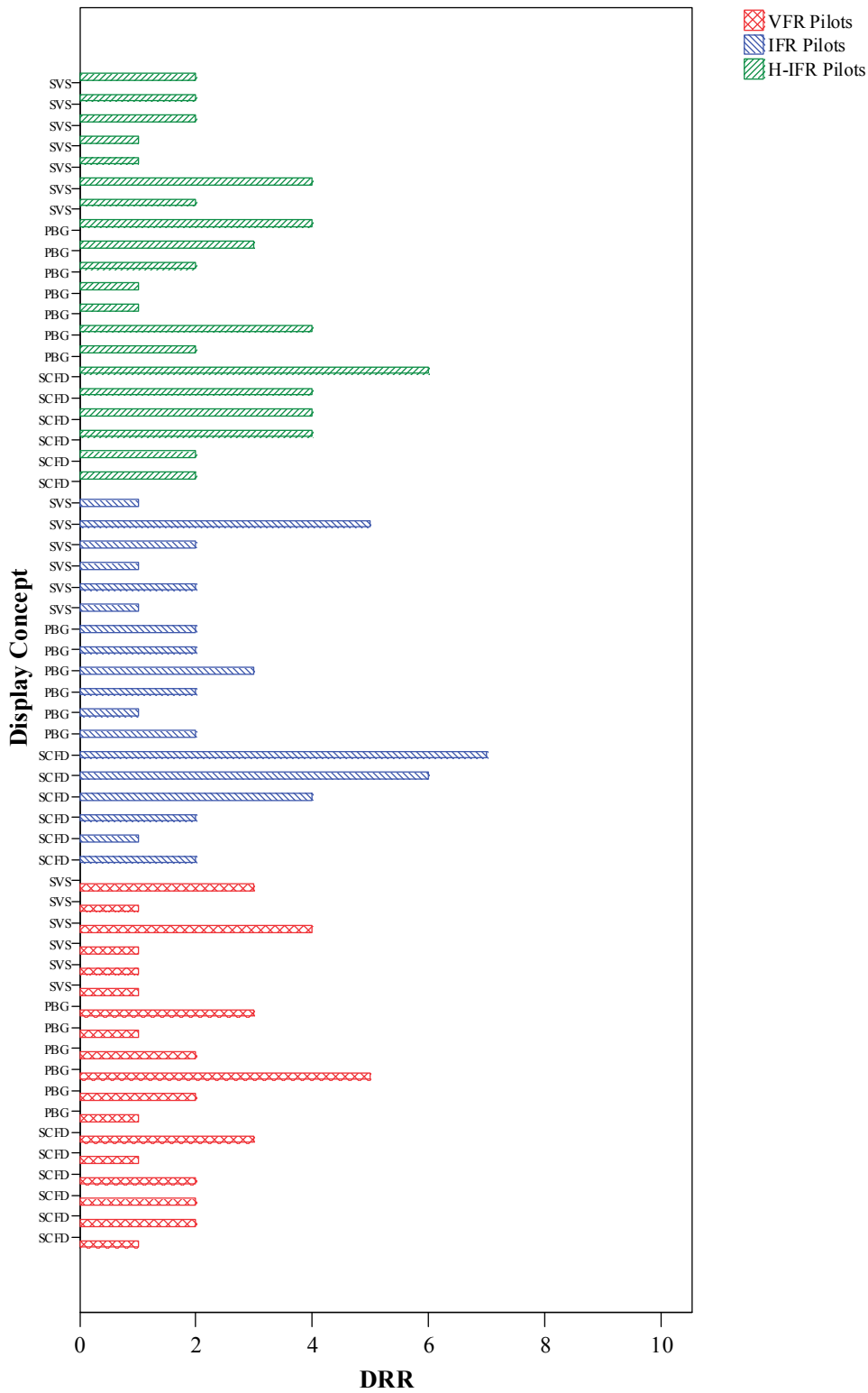

Figure D- 9: DRR as a function of display concept and pilot type, VMC-like Approach.

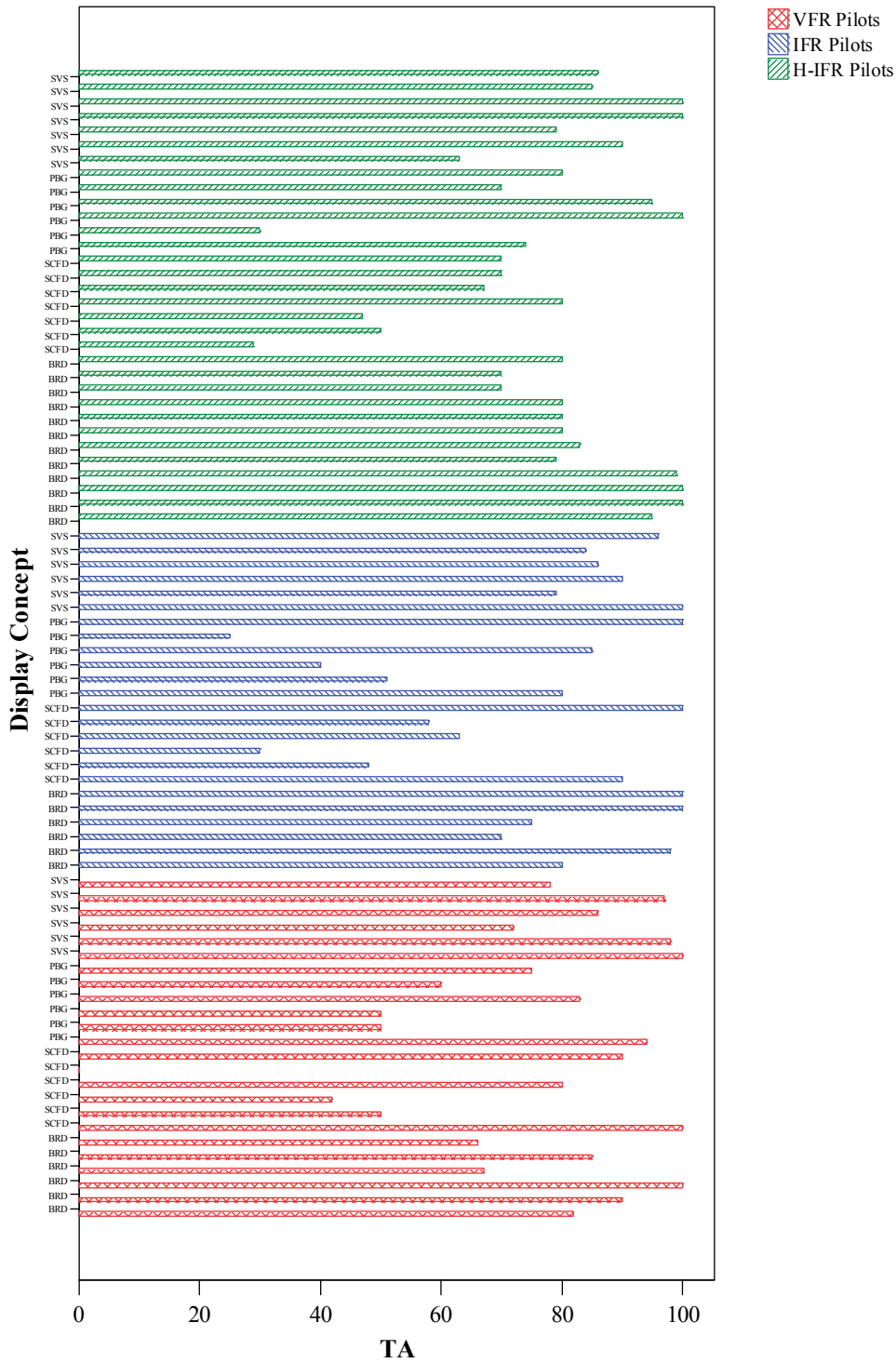

Figure D- 10: Terrain awareness as a function of display concept and pilot type, VFR Approach.

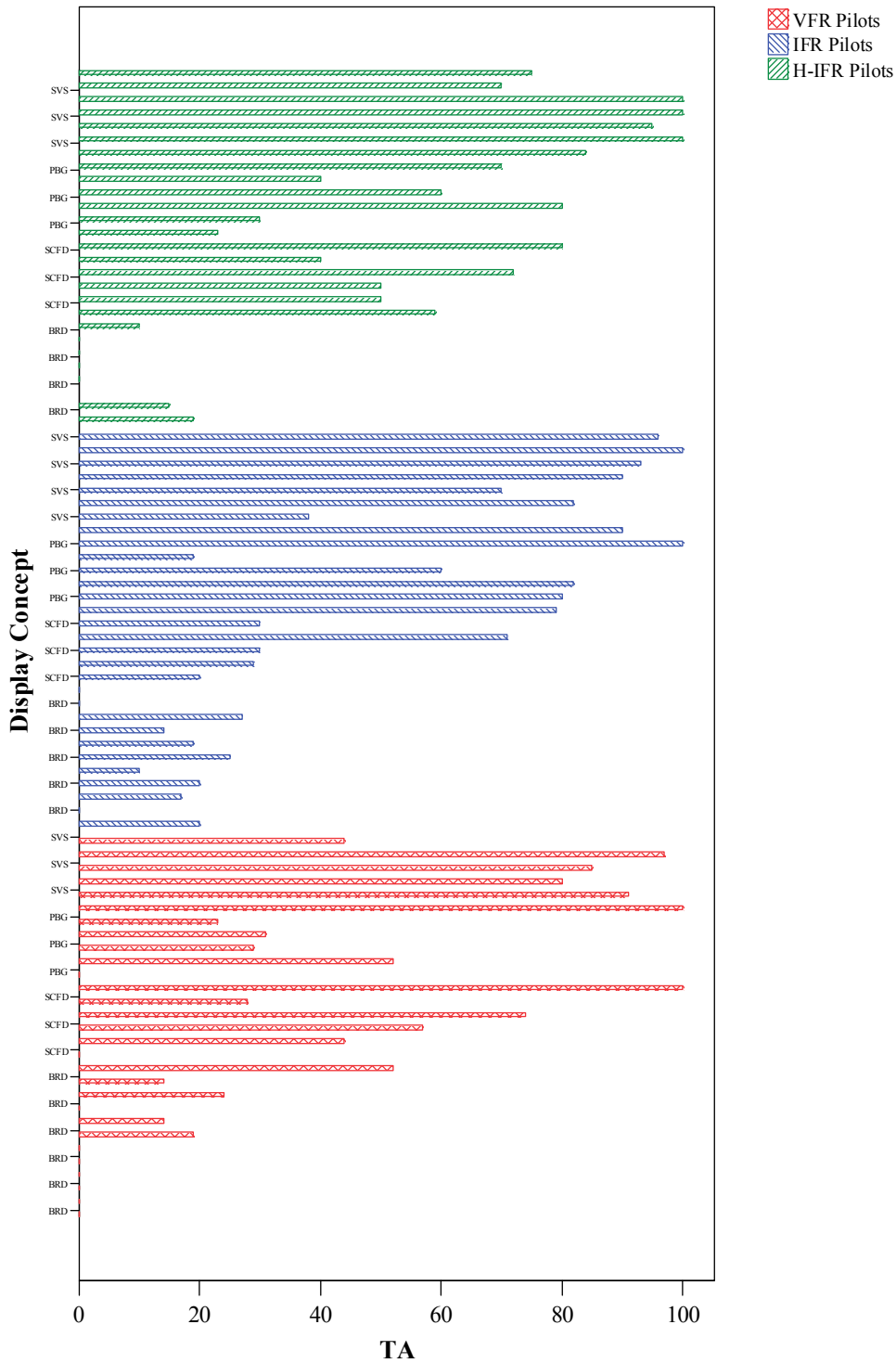

Figure D- 11: Terrain awareness as a function of display concept and pilot type, ILS Approach.

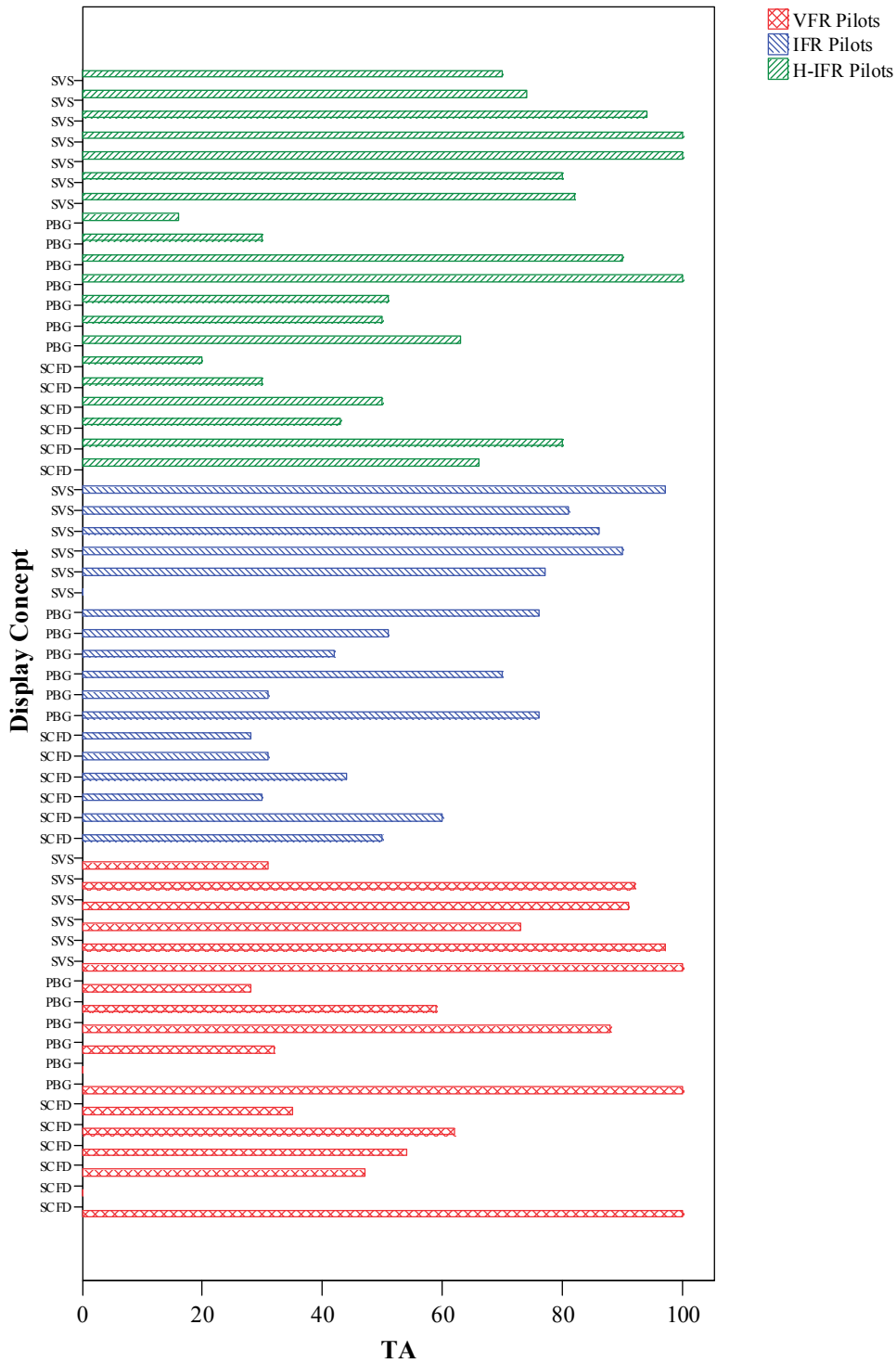

Figure D-12: Terrain awareness as a function of display concept and pilot type, VMC-like Approach.

REPORT DOCUMENTATION PAGE			Form Approved OMB No. 0704-0188		
<p>The public reporting burden for this collection of information is estimated to average 1 hour per response, including the time for reviewing instructions, searching existing data sources, gathering and maintaining the data needed, and completing and reviewing the collection of information. Send comments regarding this burden estimate or any other aspect of this collection of information, including suggestions for reducing this burden, to Department of Defense, Washington Headquarters Services, Directorate for Information Operations and Reports (0704-0188), 1215 Jefferson Davis Highway, Suite 1204, Arlington, VA 22202-4302. Respondents should be aware that notwithstanding any other provision of law, no person shall be subject to any penalty for failing to comply with a collection of information if it does not display a currently valid OMB control number.</p> <p>PLEASE DO NOT RETURN YOUR FORM TO THE ABOVE ADDRESS.</p>					
1. REPORT DATE (DD-MM-YYYY) 01-07-2014		2. REPORT TYPE Technical Publication		3. DATES COVERED (From - To)	
4. TITLE AND SUBTITLE General Aviation Flight Test of Advanced Operations Enabled by Synthetic Vision			5a. CONTRACT NUMBER		
			5b. GRANT NUMBER		
			5c. PROGRAM ELEMENT NUMBER		
6. AUTHOR(S) Glaab, Louis J.; Hughes, Monica F.; Parrish, Russell V.; Takallu, Mohammad A.			5d. PROJECT NUMBER		
			5e. TASK NUMBER		
			5f. WORK UNIT NUMBER 284848.02.04.07.01		
7. PERFORMING ORGANIZATION NAME(S) AND ADDRESS(ES) NASA Langley Research Center Hampton, VA 23681-2199			8. PERFORMING ORGANIZATION REPORT NUMBER L-20203		
9. SPONSORING/MONITORING AGENCY NAME(S) AND ADDRESS(ES) National Aeronautics and Space Administration Washington, DC 20546-0001			10. SPONSOR/MONITOR'S ACRONYM(S) NASA		
			11. SPONSOR/MONITOR'S REPORT NUMBER(S) NASA/TP-2014-218279		
12. DISTRIBUTION/AVAILABILITY STATEMENT Unclassified - Unlimited Subject Category 03 Availability: NASA CASI (443) 757-5802					
13. SUPPLEMENTARY NOTES					
14. ABSTRACT A flight test was performed to compare the use of three advanced primary flight and navigation display concepts to a baseline, round-dial concept to assess the potential for advanced operations. The displays were evaluated during visual and instrument approach procedures including an advanced instrument approach resembling a visual airport traffic pattern. Nineteen pilots from three pilot groups, reflecting the diverse piloting skills of the General Aviation pilot population, served as evaluation subjects. The experiment had two thrusts: 1) an examination of the capabilities of low-time (i.e., <400 hours), non-instrument-rated pilots to perform nominal instrument approaches, and 2) an exploration of potential advanced Visual Meteorological Conditions (VMC)-like approaches in Instrument Meteorological Conditions (IMC). Within this context, advanced display concepts are considered to include integrated navigation and primary flight displays with either aircraft attitude flight directors or Highway In The Sky (HITS) guidance with and without a synthetic depiction of the external visuals (i.e., synthetic vision). Relative to the first thrust, the results indicate that using an advanced display concept, as tested herein, low-time, non-instrument-rated pilots can exhibit flight-technical performance, subjective workload and situation awareness ratings as good as or better than high-time Instrument Flight Rules (IFR)-rated pilots using Baseline Round Dials for a nominal IMC approach. For the second thrust, the results indicate advanced VMC-like approaches are feasible in IMC, for all pilot groups tested for only the Synthetic Vision System (SVS) advanced display concept.					
15. SUBJECT TERMS Enhanced vision; Flight tests; General aviation aircraft; Instrument flight rules; Synthetic vision system; Thrust					
16. SECURITY CLASSIFICATION OF:			17. LIMITATION OF ABSTRACT	18. NUMBER OF PAGES	19a. NAME OF RESPONSIBLE PERSON
a. REPORT	b. ABSTRACT	c. THIS PAGE			STI Help Desk (email: help@sti.nasa.gov)
U	U	U	UU	158	19b. TELEPHONE NUMBER (Include area code) (443) 757-5802