

# Chromospheric Lyman-Alpha Spectro-Polarimeter

# CLASP

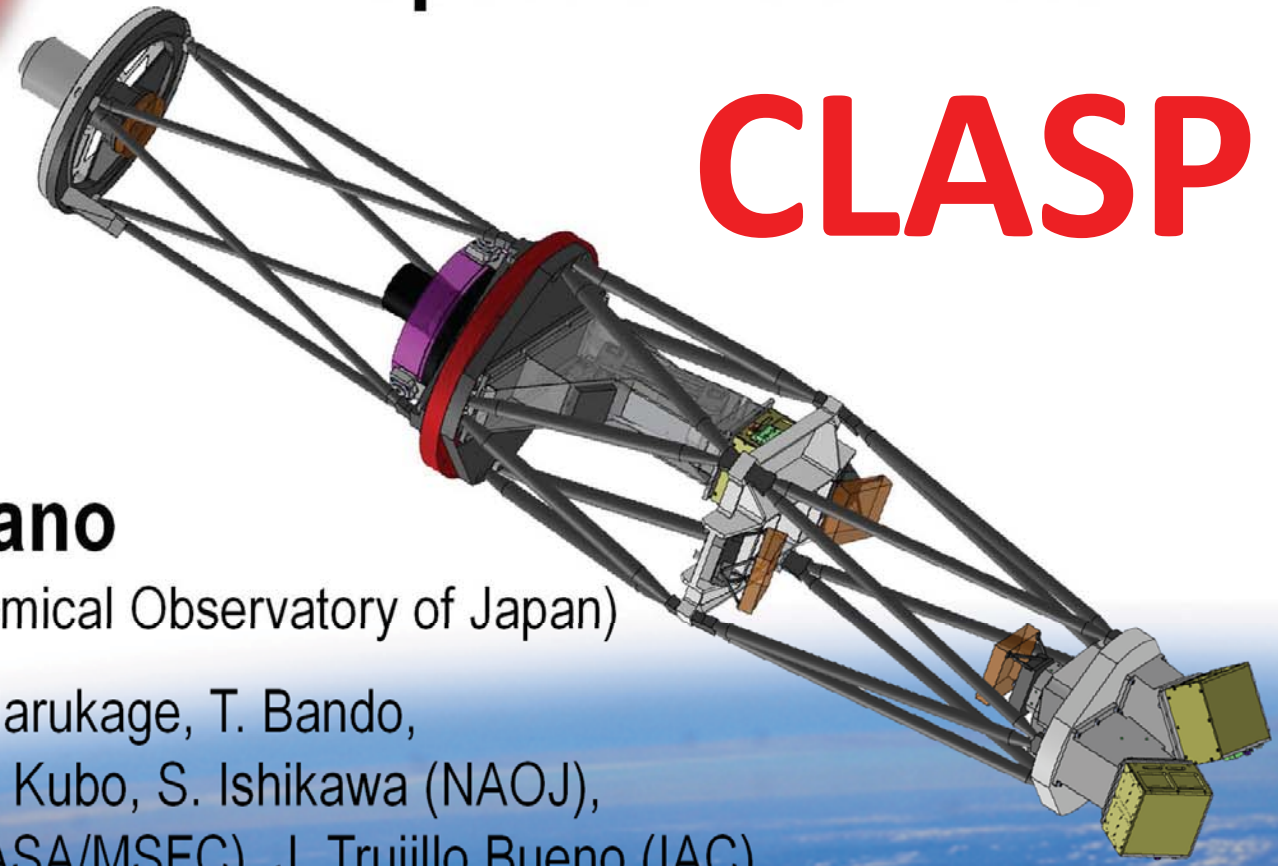

**Ryouhei Kano**

(National Astronomical Observatory of Japan)

R. Ishikawa, N. Narukage, T. Bando,  
Y. Katsukawa, M. Kubo, S. Ishikawa (NAOJ),  
K. Kobayashi (NASA/MSFC), J. Trujillo Bueno (IAC),  
F. Auchère (IAS), with the CLASP team

Active Chromosphere

Quiet Photosphere

We would like to have magnetic-field measurements in low- $\beta$  plasma.

20-Nov-2006  
21:54:52 UT



# Chromospheric Lyman-Alpha Spectro-Polarimeter (CLASP)

A sounding rocket experiment aiming the followings:

- **high-precision (0.1%)** measurements of linear **polarizations in vacuum-UV (VUV) lights**,
- the **first measurement** of the linear polarization induced by **atomic polarization and Hanle effect in the Lyman-alpha line (121.567nm)**, and
- the **first exploration** of **magnetic fields** in the upper **chromosphere and transition region** of the Sun.

The CLASP project was accepted by NASA in 2012, and CLASP will fly with NASA's sounding rocket in 2015!

# International Collaboration in **CLASP**

*12 institutes in 5 countries*

**Japan** : R.Kano (PI, NAOJ)



- All of **CLASP science instrument** (except **CCD camera system** and **concave grating**)
- Development of empirical tool to diagnose ch.-magnetic fields.

**USA**: K. Kobayashi (PI, NASA/MSFC)



- CCD camera system
- Sounding rocket & operation

**France** : F. Auchère (PI, IAS)



- Concave grating

**Norway** : M. Carlsson (Oslo U.)

- 3D modeling of solar atmosphere



**Spain** : J. Trujillo Bueno (PI, IAC)

- Modeling of spectro-polarimetric profile in Lyman-alpha with Hanle effect



Collaborations

# Why Ly $\alpha$ line?

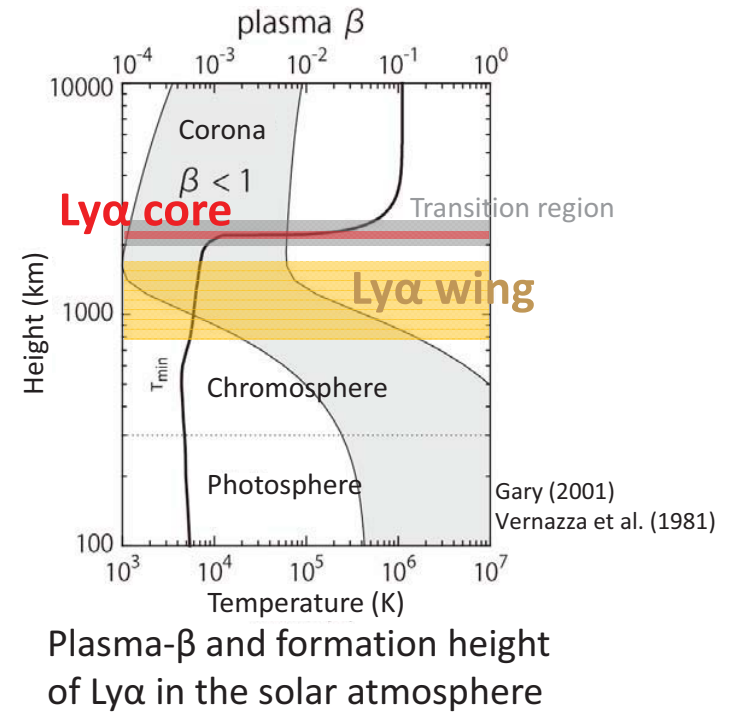
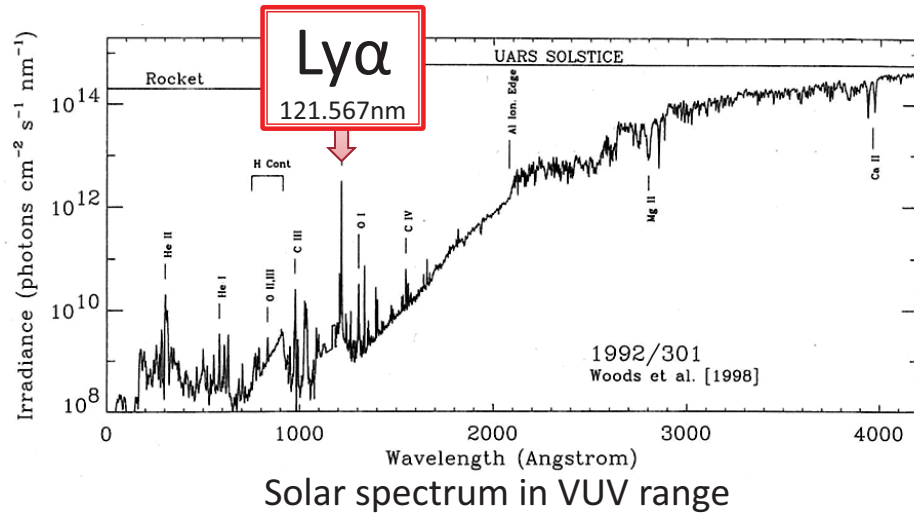

- **Brightest line** in VUV chromospheric emission lines.
- **Bright even in quiet Sun** as well as active regions.
- Line core is emitted by the plasma located between **higher chromosphere and transition region**.
- Good sensitivity to magnetic field of **10 – 250 G** via Hanle effect.
  - ➔ Ly $\alpha$  line is a best candidate to infer magnetic fields in low- $\beta$  plasma ( $\beta < 1$ ) over the entire solar disk.

# Origin of linear polarization in scattered lights

Step 1: Population imbalance between atomic sublevels induced by **anisotropic radiation** illuminating atom.

## isotropic radiation

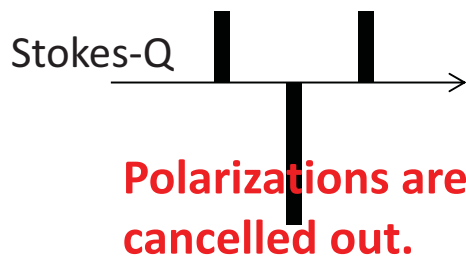
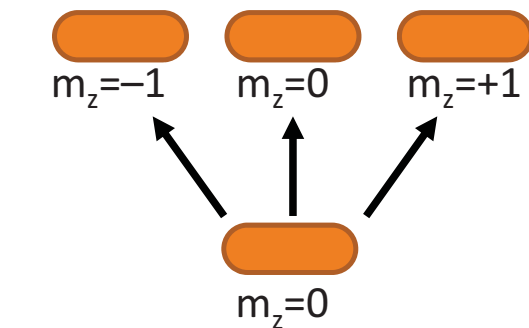

## anisotropic radiation

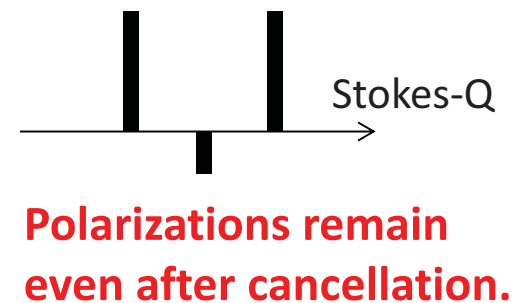
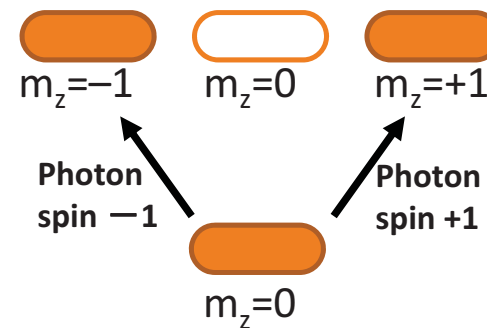

# Origin of linear polarization in scattered lights

Step2: Quantum coherency by rotation of quantization axes.

Step3: Magnetic fields dephase and decrease the coherence (Hanle effect).

It is a competition between Larmor motion and de-excitation.

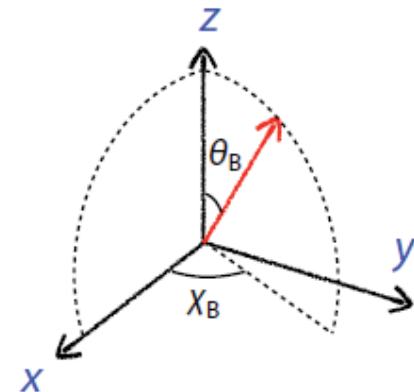

$\frac{1}{\omega_0}$	<b>VS.</b>	$\frac{1}{A}$
time scale to change coherency		time scale for de-excitation

$\frac{1}{\omega_0} \sim \frac{1}{A}$  **marginal field:** depolarization & rotation of linear polarization  
 **$B \sim 54G$  @ Ly-alpha**

$\frac{1}{\omega_0} \ll \frac{1}{A}$  **strong field (saturation regime):** depolarization

$\omega_0 = \frac{e}{2m} gB$  : Larmor frequency

A: Einstein coefficient for spontaneous decay

# Polarization of Hanle effect in Ly $\alpha$

based on **FAL-C model** & **CRD scattering**  
(Trujillo Bueno et al. 2011, ApJ)

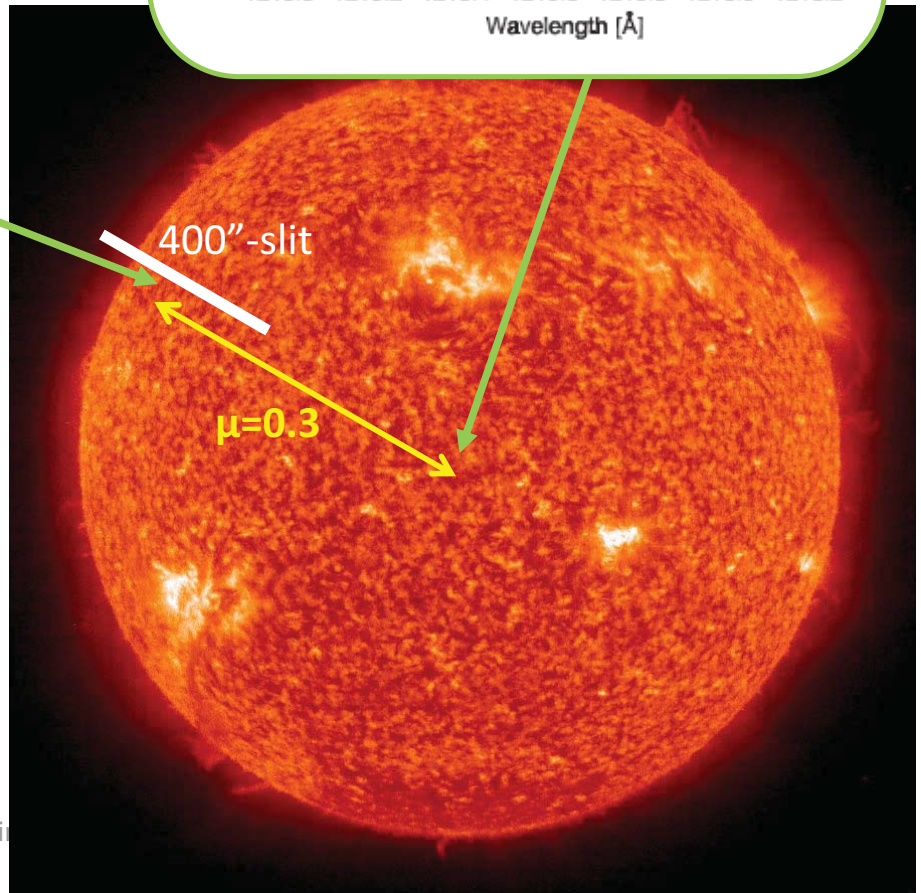
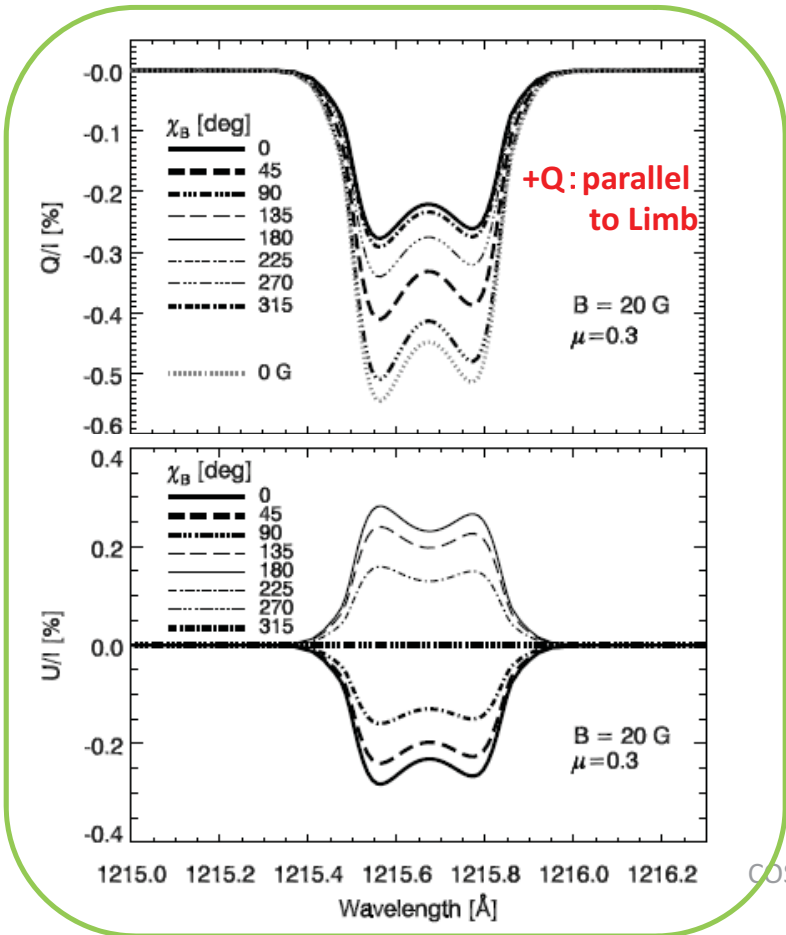
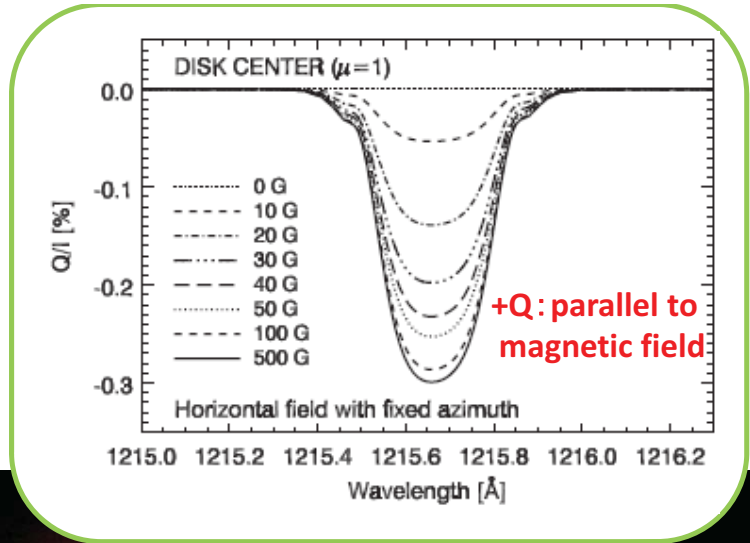



# CLASP Instrument: Optics

*Narukage, N. et al. (2014, Applied Optics, in preparation)*

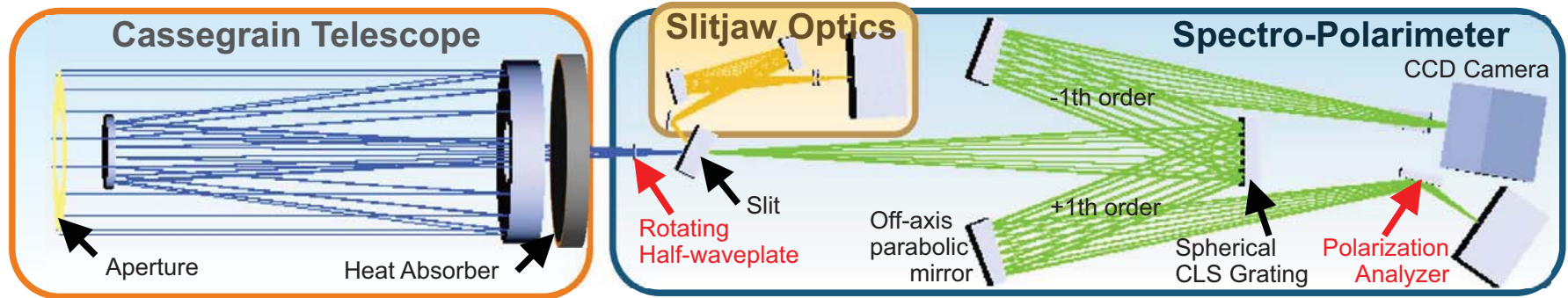

## Cassegrain Telescope

Aperture	$\phi 270.0$ mm
Effective Focal Length	2614 mm (F/9.68)
Visible light rejection	“Cold Mirror” coating on primary mirror

## Slitjaw Optics

Wavelength	121.567 nm (narrowband filter)
Plate scale	1.03"/pixel
FoV	527" $\times$ 527"

## Spectro-Polarimeter

Optics	<b>Dual beam</b> of Inverse Wadsworth mounting	
Wavelength	121.567 $\pm$ 0.61 nm	
Slit	1.45" (width), 400" (length)	
Grating	Spherical constant-line-spacing, 3000 lines/mm	
CCD camera	512 $\times$ 512 pixel	13 $\mu$ m/pixel
Plate scale	0.0048 nm/pixel	1.11"/pixel
Resolution	<b>0.01nm</b>	3"
Sensitivity	<b>0.1%</b>	

# Polarization Measurement

- CLASP is optimized for linear polarization, because  $V/I$  is expected to be too small ( $\sim 0.005\%$  @10G in the Ly-alpha by Zeeman effect).

## CLASP Polarimeter

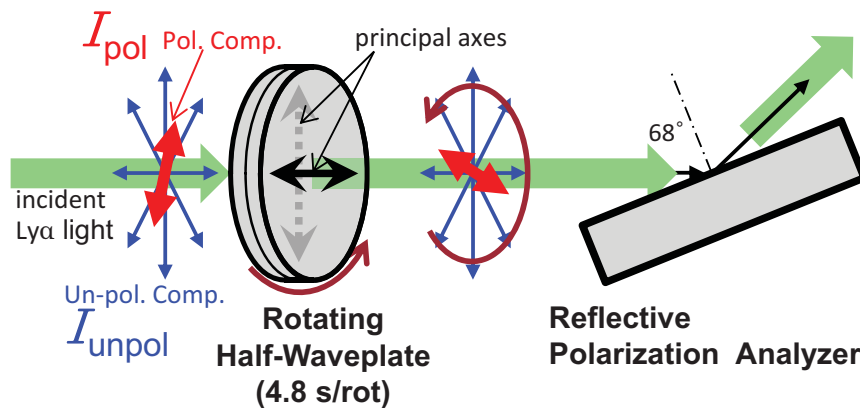

## Modulation

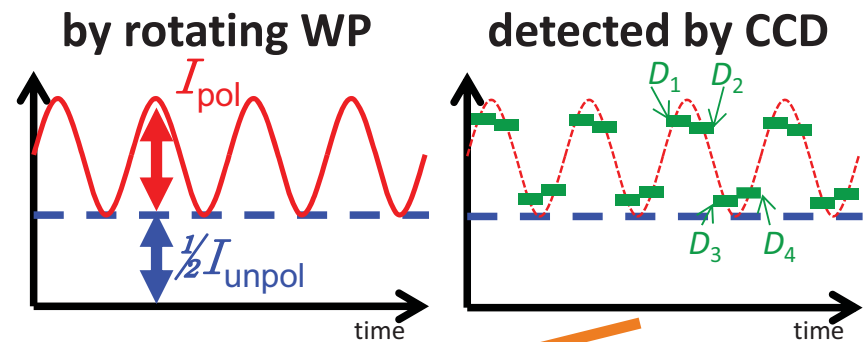

## Demodulation from CCD exposures

$$Q = aK\{(D_1 - D_2 - D_3 + D_4) + \dots\}$$

$$U = aK\{(D_2 - D_3 - D_4 + D_5) + \dots\}$$

$$I = K\{(D_1 + D_2 + D_3 + D_4) + \dots\}$$

a: modulation coefficient  
K: throughput value

# Dual-beam demodulation

- It will reduce spurious polarizations from time variations.

	t1	t2	t3	t4	...
Ch1	I+aQ+aU	I-aQ+aU	I-aQ-aU	I+aQ-aU	...
Ch2	I-aQ-aU	I+aQ-aU	I+aQ+aU	I-aQ+aU	...

$$\frac{Q}{I} = \left[ \frac{Q}{I} \right]_0 + \frac{\Delta^2}{2a} \cdot \frac{1}{I_0} \frac{d^2 I}{dt^2} \cdot \frac{K_2 - K_1}{K_2 + K_1}$$

Error term

Difference of throughput  $K$  between 2 Ch

- We expect that the symmetric optics reduces the difference .

Time variation of intensity of targets

- The modulation/demodulation scheme removes a sensitivity to the linear change.
- The 1.2s period to take one set for the demodulation (i.e. 4 exposures) may be short enough.

$\Delta$ : exposure interval (~0.3s)

# Error budget for spurious polarization

*Ishikawa, R., et al. (2014, Solar Physics, in press)*

Cause of error		error ( $1\sigma$ )
Random noise	<b>Photon noise at Ly-a center</b> (10" along slit and 200s obs. period )	<b>0.026%</b>
	<b>Readout noise of CCD cameras</b>	<b>0.011%</b>
	Fluctuation of exposure durations	$5 \times 10^{-5}\%$
$\frac{dI}{dt}$	Time variation of source intensity	$<0.018\%^\dagger$ ( $\sim 0\%$ )
	Intensity variation from pointing jitter	$<0.018\%^\dagger$ ( $\sim 0\%$ )
	Image shift from waveplate rotation	$\sim 0\%$
Tel.	Off-axis incidence with 200"	$\sim 10^{-4}\%$
	Non-uniformity of coating on primary	$10^{-3}\%$
SP	<b>Error in polarization calibration</b>	<b>0.017%</b>
<b>RSS</b>		<b><math>&lt;0.042\%</math> (<math>\sim 0.033\%</math>)</b>

†: These values are the case for the single channel demodulation, and can be reduced by dual channel modulations.

# Flight instrument is in fabrication.

Primary



Secondary



Telescope Structure



Slitjaw optics: mirror unit & filter unit

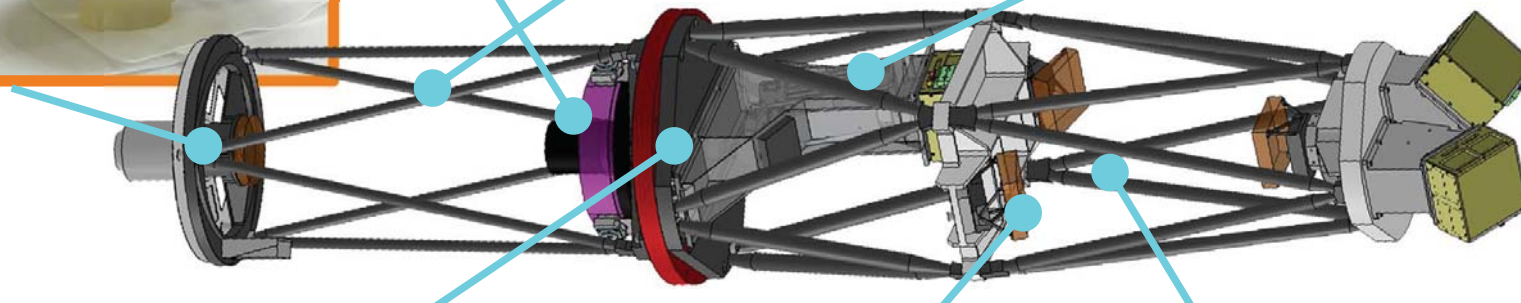
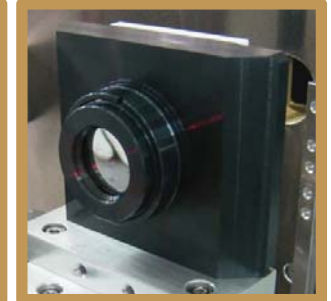

HWP motor (PMU) & driver



Off-axis Camera mirror

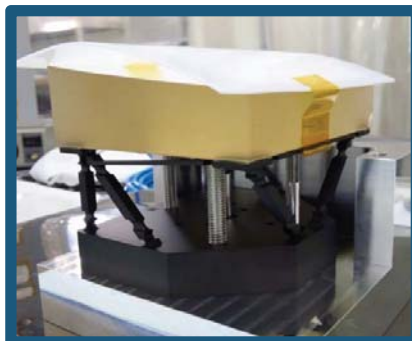

Spectro-Polarimeter Structure

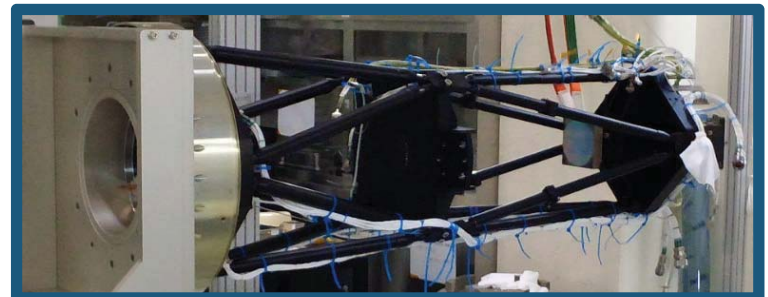

# Measurements of flight components are also in progress.

## Half waveplate

MgF<sub>2</sub> WP optimized by Ishikawa, R. et al. (2013, Applied Optics)

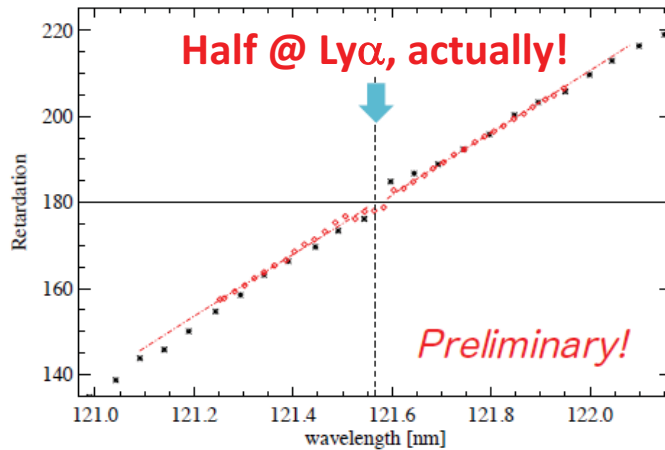

## Reflective pol. analyzer

Multi-layer designed by Bridou et al. (2011, Applied Physics A)

**High and uniform pol.-power = 98.9%**

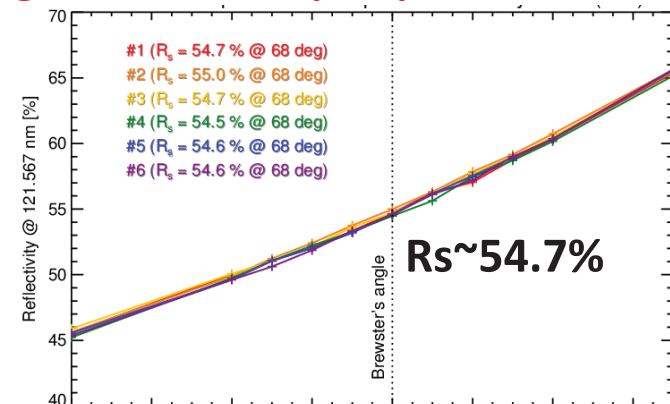

## “Cold mirror” coating for primary mirror

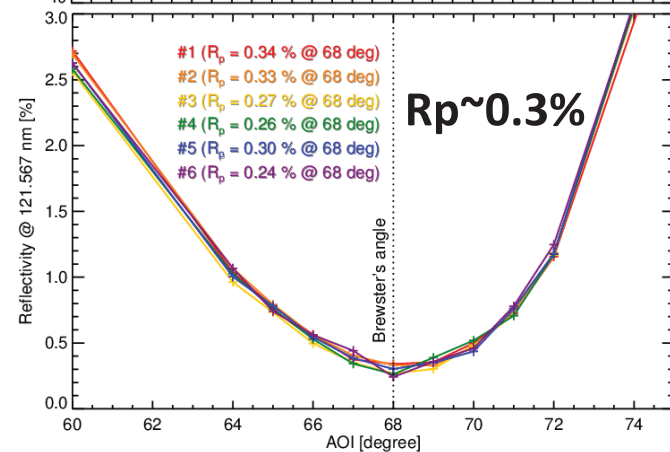
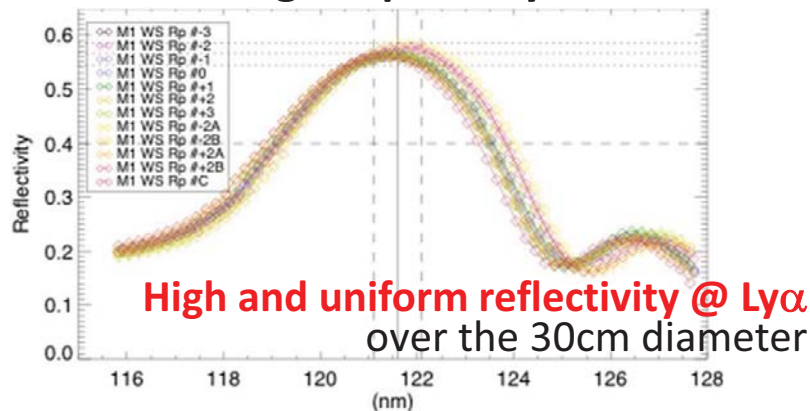

# How ambiguous is $B$ -inversion? How to solve the ambiguity?

*Ishikawa, R. et al. (2014, ApJ 787, 159)*

Close-to-limb ( $\mu=0.3$ ) obs. of  $B=50\text{G}$ ,  $\theta_B=90^\circ$ ,  $\chi_B=120^\circ$

Simulated observation

- $\lambda$ -res.:  $\sigma=0.013\text{nm}$
- noise :  $\sigma=0.033\%$

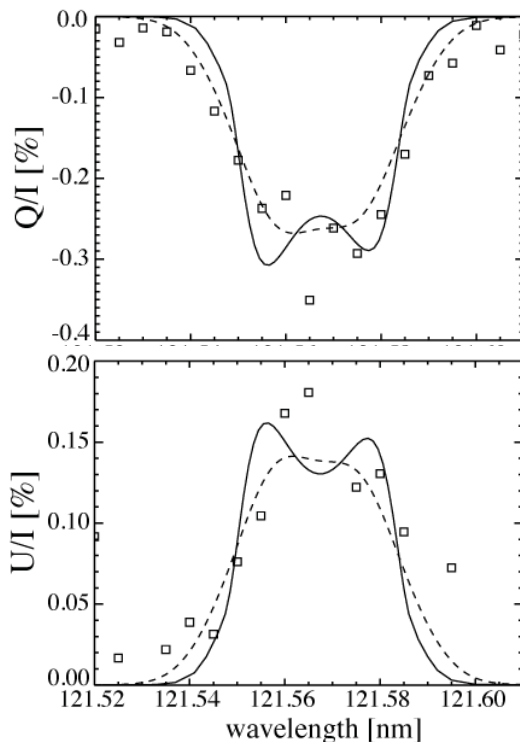

Take  $\chi^2$  with all synthetic profiles.

Black dots:  
 $\Delta\chi^2 \equiv \chi^2 - \chi^2_{\min} \leq 3.53$ ,  
which corresponds the confidence level of 63.8% ( $1\sigma$ ) for 3-degree of freedom.

COSPAR in Moscow

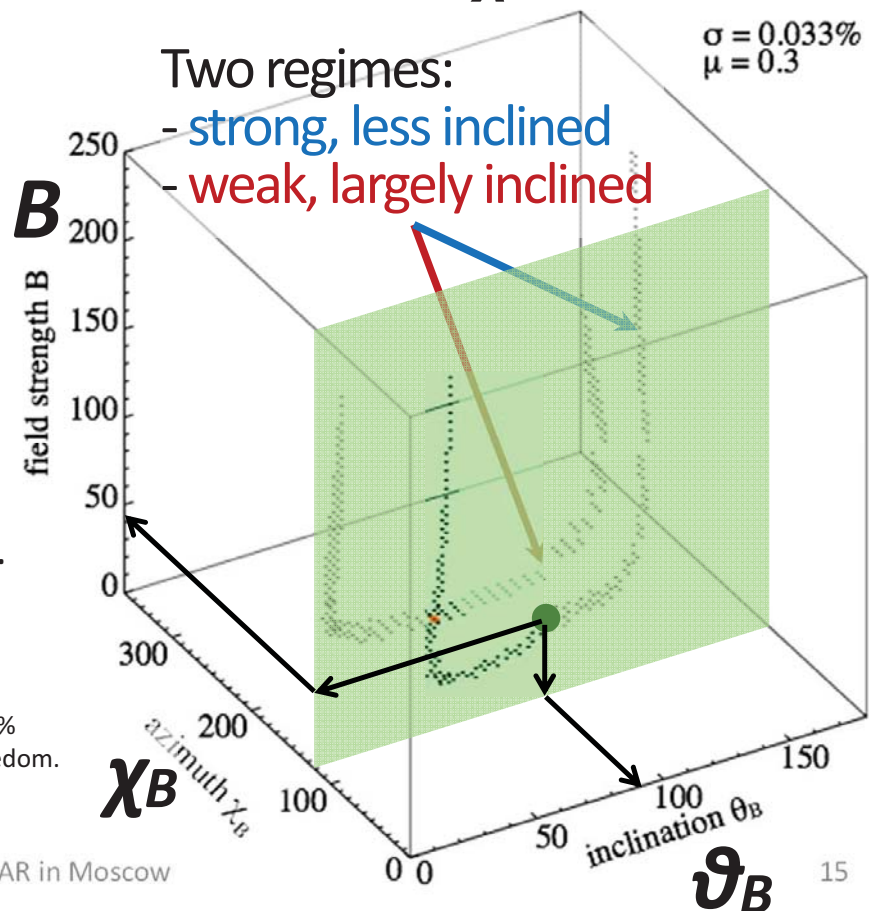

# Procedure to infer magnetic fields

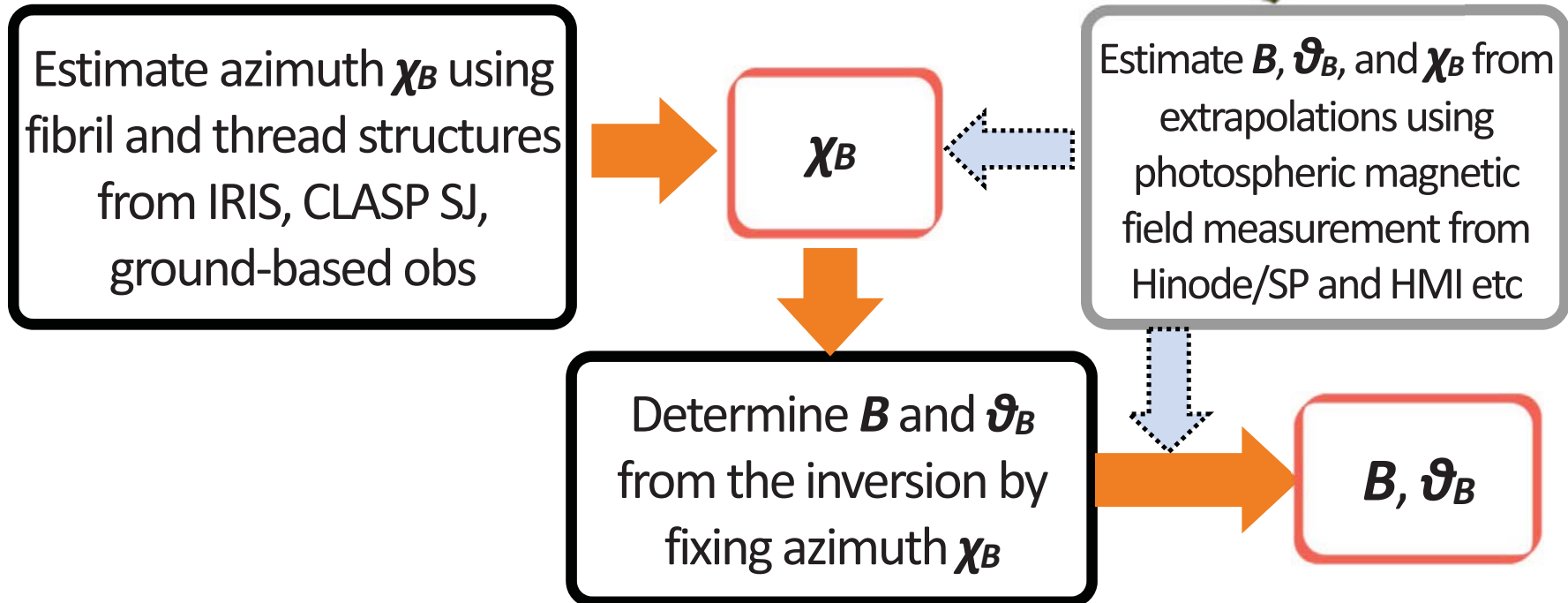
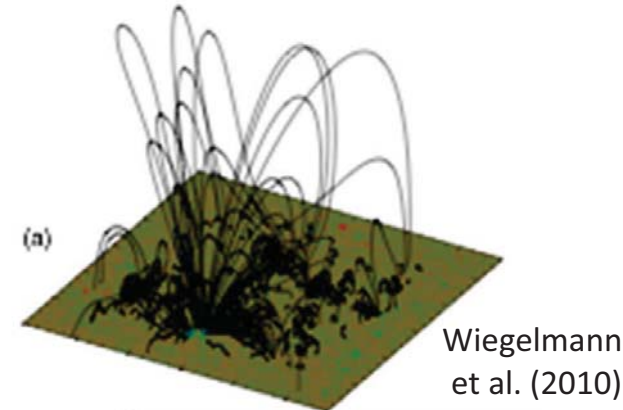



# What will CLASP observe?

Observables

C-to-L Variation of Polarization

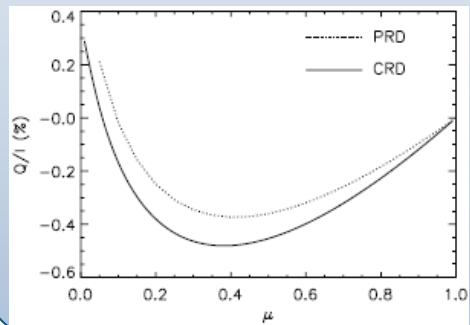

Polarization in Line Core

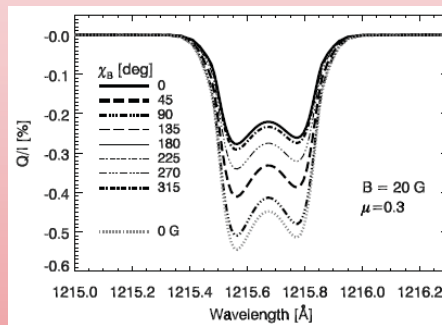

Polarization in Line Wing

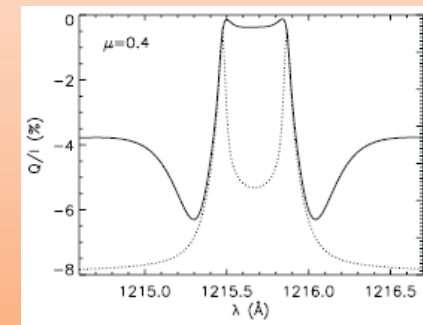

Solar Atmosphere

Global Structure  
 $T(\mathbf{h}), \rho(\mathbf{h})$

Magnetic fields in Chrom. & TR  
 $B, \vartheta_B, \chi_B$

Local Structure  
 $T(\vec{x}), \rho(\vec{x})$

# Draft for Coordinated Observation

## IRIS

- during the CLASP flight
  - Raster scan of 30''(scan)x175''(slit)
  - Near the limb:  $\mu \sim 0.4$  and 0.6 (Scat-pol is maximum at  $\mu \sim 0.4$ .)
  - Mg II h&k observation.

## Hinode/SOT

- before/after the CLASP flight
  - Near the limb:  $\mu \sim 0.4$ .
  - H $\alpha$  imaging & Photospheric Vector magnetic fields by SP.

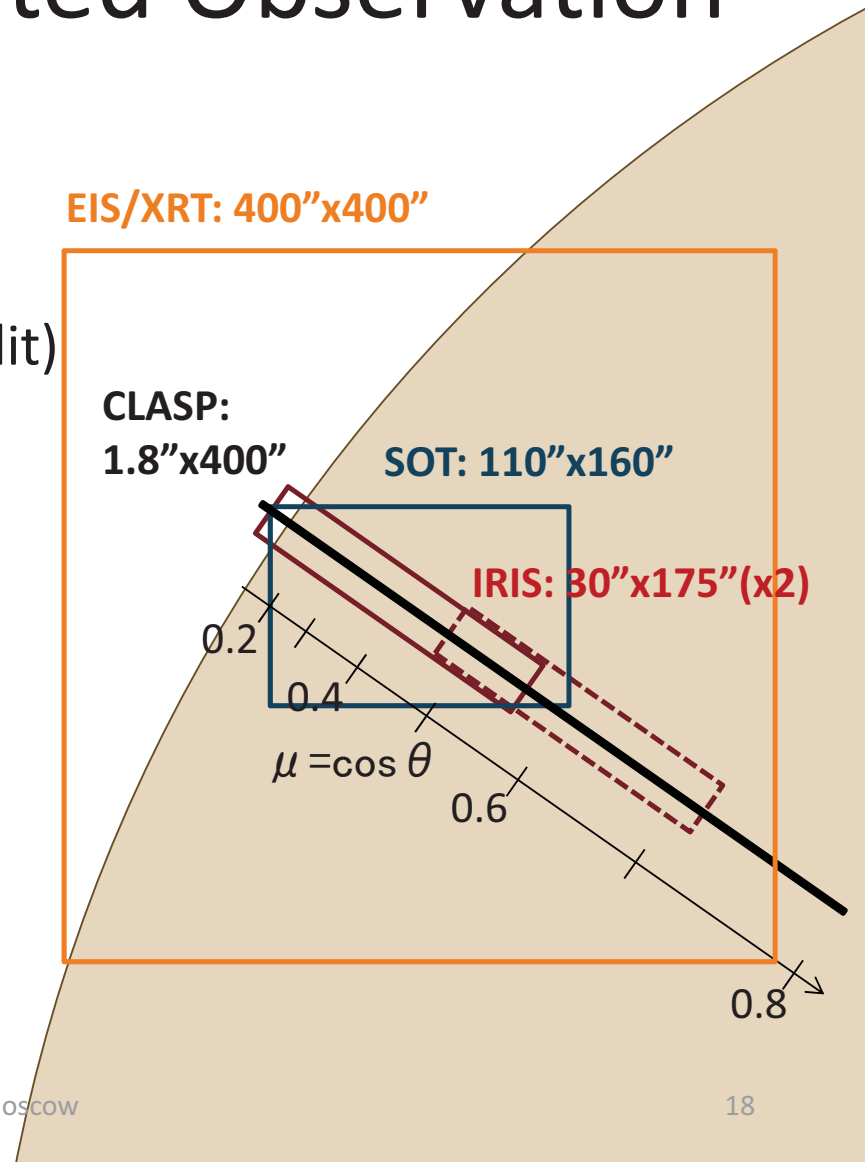

# Summary

- The CLASP project is on-going **to infer magnetic fields in upper-chromosphere and transition region.**
- The CLASP, a sounding rocket experiment, will be performed **in 2015 summer at White Sands** in USA.
- Coordinated imaging observations of chromosphere and photospheric magnetic fields are necessary.
- A quick inversion based on plane-parallel atmospheres will be tried at first, but will be followed by precise analysis collaborated with 3D simulations.