

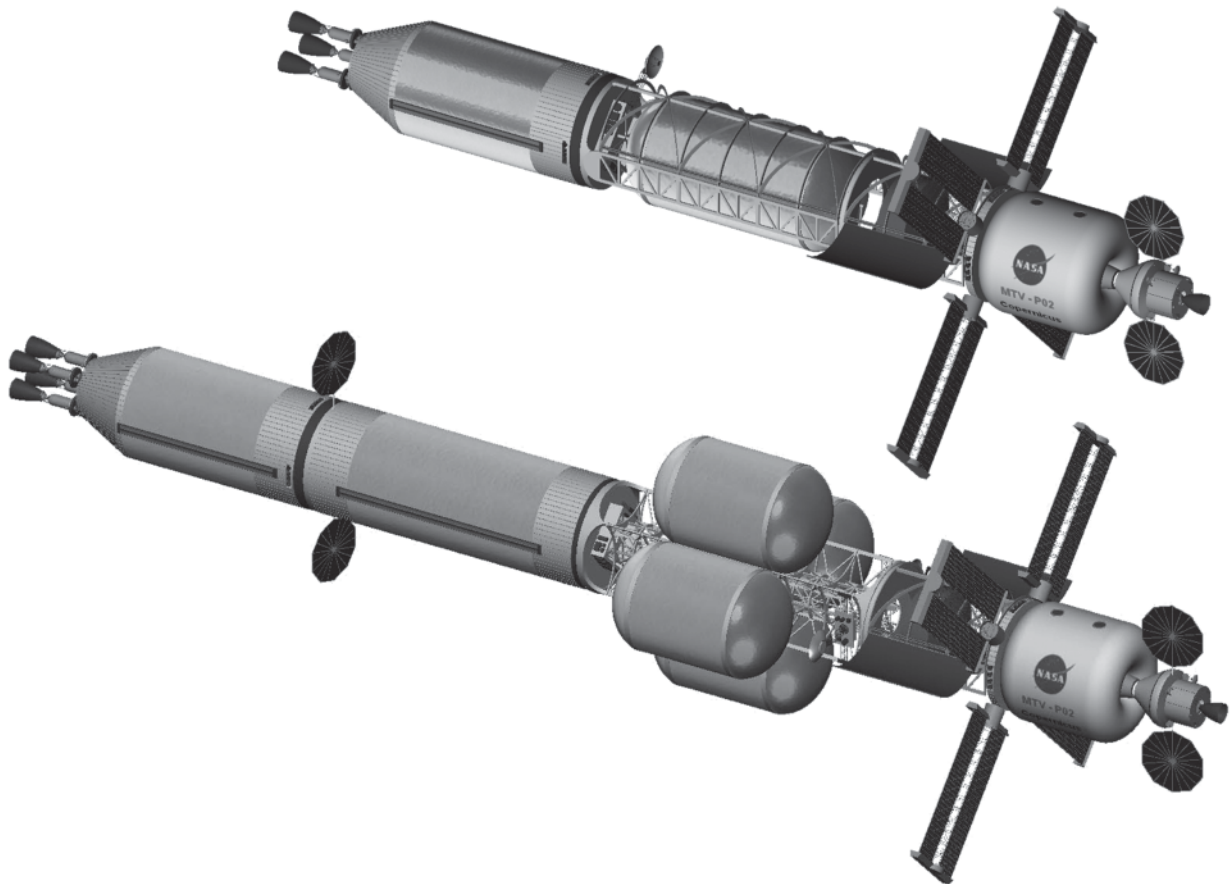

Nuclear Thermal Propulsion (NTP): A Proven, Growth Technology for “Fast Transit” Human Missions to Mars

*Stanley K. Borowski
Glenn Research Center, Cleveland, Ohio*

*David R. McCurdy and Thomas W. Packard
Vantage Partners, LLC, Brook Park, Ohio*



NASA STI Program . . . in Profile

Since its founding, NASA has been dedicated to the advancement of aeronautics and space science. The NASA Scientific and Technical Information (STI) program plays a key part in helping NASA maintain this important role.

The NASA STI Program operates under the auspices of the Agency Chief Information Officer. It collects, organizes, provides for archiving, and disseminates NASA's STI. The NASA STI program provides access to the NASA Aeronautics and Space Database and its public interface, the NASA Technical Reports Server, thus providing one of the largest collections of aeronautical and space science STI in the world. Results are published in both non-NASA channels and by NASA in the NASA STI Report Series, which includes the following report types:

- **TECHNICAL PUBLICATION.** Reports of completed research or a major significant phase of research that present the results of NASA programs and include extensive data or theoretical analysis. Includes compilations of significant scientific and technical data and information deemed to be of continuing reference value. NASA counterpart of peer-reviewed formal professional papers but has less stringent limitations on manuscript length and extent of graphic presentations.
- **TECHNICAL MEMORANDUM.** Scientific and technical findings that are preliminary or of specialized interest, e.g., quick release reports, working papers, and bibliographies that contain minimal annotation. Does not contain extensive analysis.
- **CONTRACTOR REPORT.** Scientific and technical findings by NASA-sponsored contractors and grantees.

- **CONFERENCE PUBLICATION.** Collected papers from scientific and technical conferences, symposia, seminars, or other meetings sponsored or cosponsored by NASA.
- **SPECIAL PUBLICATION.** Scientific, technical, or historical information from NASA programs, projects, and missions, often concerned with subjects having substantial public interest.
- **TECHNICAL TRANSLATION.** English-language translations of foreign scientific and technical material pertinent to NASA's mission.

Specialized services also include creating custom thesauri, building customized databases, organizing and publishing research results.

For more information about the NASA STI program, see the following:

- Access the NASA STI program home page at <http://www.sti.nasa.gov>
- E-mail your question to help@sti.nasa.gov
- Fax your question to the NASA STI Information Desk at 443-757-5803
- Phone the NASA STI Information Desk at 443-757-5802
- Write to:
STI Information Desk
NASA Center for AeroSpace Information
7115 Standard Drive
Hanover, MD 21076-1320



Nuclear Thermal Propulsion (NTP): A Proven, Growth Technology for “Fast Transit” Human Missions to Mars

*Stanley K. Borowski
Glenn Research Center, Cleveland, Ohio*

*David R. McCurdy and Thomas W. Packard
Vantage Partners, LLC, Brook Park, Ohio*

Prepared for the
Space 2013 Conference and Exposition
sponsored by the American Institute of Aeronautics and Astronautics
San Diego, California, September 10–12, 2013

National Aeronautics and
Space Administration

Glenn Research Center
Cleveland, Ohio 44135

Acknowledgments

The authors wish to thank Chris Moore and John Warren from NASA Headquarters, Mike Houts from NASA Marshall Space Flight Center, along with John Taylor and Gary Kelm from NASA Glenn Research Center for their continued encouragement and strong support of this work. The author Stanley K. Borowski also expresses his thanks to Bob Sauls (bob.sauls@xp4d.com) for artwork and images depicted in Figures 5, 6, and 7 of this paper.

Level of Review: This material has been technically reviewed by technical management.

Available from

NASA Center for Aerospace Information
7115 Standard Drive
Hanover, MD 21076-1320

National Technical Information Service
5301 Shawnee Road
Alexandria, VA 22312

Available electronically at <http://www.sti.nasa.gov>

Nuclear Thermal Propulsion (NTP): A Proven, Growth Technology for “Fast Transit” Human Missions to Mars

Stanley K. Borowski
National Aeronautics and Space Administration
Glenn Research Center
Cleveland, Ohio 44135

David R. McCurdy and Thomas W. Packard
Vantage Partners, LLC
Brook Park, Ohio 44142

Abstract

The “fast conjunction” long surface stay mission option was selected for NASA’s recent Mars Design Reference Architecture (DRA) 5.0 study because it provided adequate time at Mars (~540 days) for the crew to explore the planet’s geological diversity while also reducing the “1-way” transit times to and from Mars to ~6 months. Short transit times are desirable in order to reduce the debilitating physiological effects on the human body that can result from prolonged exposure to the zero-gravity ($0-g_E$) and radiation environments of space. Recent measurements from the RAD detector attached to the Curiosity rover indicate that astronauts would receive a radiation dose of ~0.66 Sv (~66 rem)—the limiting value established by NASA—during their 1-year journey in deep space. Proven nuclear thermal rocket (NTR) technology, with its high thrust and high specific impulse (I_{sp} ~900 s), can cut 1-way transit times by as much as 50 percent by increasing the propellant capacity of the Mars transfer vehicle (MTV). No large technology scale-ups in engine size are required for these short transit missions either since the smallest engine tested during the Rover program—the 25 klb_f “Pewee” engine is sufficient when used in a clustered arrangement of three to four engines. The “Copernicus” crewed MTV developed for DRA 5.0 is a $0-g_E$ design consisting of three basic components: (1) the NTP stage (NTPS); (2) the crewed payload element; and (3) an integrated “saddle truss” and LH₂ propellant drop tank assembly that connects the two elements. With a propellant capacity of ~190 t, Copernicus can support 1-way transit times ranging from ~150 to 220 days over the 15-year synodic cycle. The paper examines the impact on vehicle design of decreasing transit times for the 2033 mission opportunity. With a fourth “upgraded” SLS/HLV launch, an “in-line” LH₂ tank element can be added to Copernicus allowing 1-way transit times of 130 days. To achieve 100 to 120 day transit times, Copernicus’ saddle truss/drop tank assembly is replaced by a “star truss” assembly with paired modular drop tanks to further increase the vehicle’s propellant capacity. The HLV launch count increases (from ~5 to 7) and a fourth engine is needed to reduce total mission burn time and gravity losses. Using a “split mission” approach, the NTPS, in-line tank and the saddle truss/LH₂ drop tank elements can be configured as a pre-deployed Earth Return Vehicle/propellant tanker supporting 90-day crewed mission transits. The split mission approach also eliminates the need for on-orbit assembly. Mission scenario descriptions, key features and operational characteristics for five different vehicle configurations are presented.

Nomenclature

IMLEO	initial mass in low Earth orbit
K	temperature (degrees Kelvin)
klb _f	thrust (1000’s of pounds force)
LEO	low Earth orbit (= 407 km circular)
LOX/LH ₂	Liquid oxygen/liquid hydrogen propellant

RAD	Radiation Assessment Detector carried on Mars Science Laboratory’s Curiosity rover
SLS/HLV	Space Launch System/Heavy Lift Vehicle
Sv	Sievert (1 Sv = 100 rem)
t	metric ton (1 t = 1000 kg)
ΔV	velocity change increment (km/s)

1.0 Introduction and Background

In 2007 and 2008, NASA conducted a multi-center, agency-wide study that examined the mission, payload and transportation system options and requirements needed to land humans on Mars in the post-2030 timeframe. The Mars Design Reference Architecture (DRA) 5.0 study (Ref. 1) provided an update to NASA’s earlier DRM 3.0 and 4.0 studies (Refs. 2 to 5) and was conducted in two phases. In Phase I, key architectural approaches, mission drivers and technology options were evaluated to support a down-selection process. Selected architectural approaches and systems concepts were then further refined in Phase II while also evaluating different surface exploration strategies. A three mission set of Mars landing missions over an ~10 year period was assumed with each mission carrying a crew of six. Opposition and fast-conjunction trajectories supporting short and long surface stay landing missions were examined (shown in Fig. 1) during Phase I. Mission characteristics and features associated with each trajectory type were evaluated and compared against the in-space transportation system requirements and the amount of scientific investigation that could be achieved using each mission type. The scientific community overwhelmingly preferred going to different sites and staying as long as possible so the crew could sample the planet’s rich geological diversity and maximize the scientific return on each mission. While opposition trajectories typically have short round trip mission times, the stay times at Mars are also short. This trajectory class also usually has one short and one long transit leg with the latter involving a Venus swing-by (VSB) maneuver that can bring the spacecraft relatively close to the Sun. By contrast, fast conjunction trajectories have long round trip and surface stay times, but transit times to and from Mars can be relatively short and no VSB is required on either mission leg. The long surface stay mission also has a lower total ΔV requirement than the short stay option, and therefore requires less propellant and less mass delivered to LEO. Because of its attractive features—lower total ΔV , a long surface stay, short transit times, and no VSB—the fast conjunction/long stay mission option was selected as the baseline for DRA 5.0.

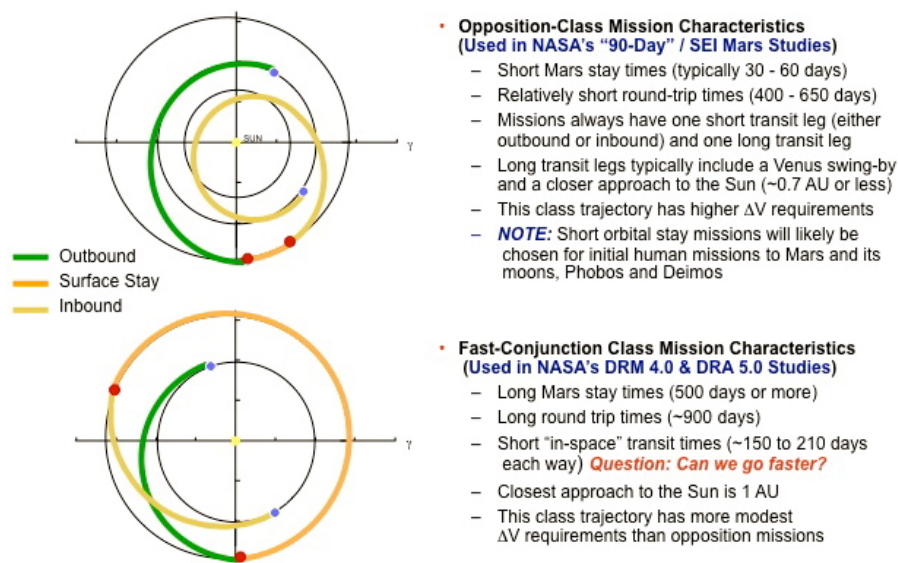

Figure 1.—Features and characteristics associated with opposition and fast conjunction Mars missions.

Recent measurements of the energetic particle radiation environment inside the Mars Science Laboratory (MSL) spacecraft during its 253-day journey to Mars were made by the RAD attached to the Curiosity rover located inside MSL (Ref. 6). The detector measured an average of $\sim 1.8 \times 10^{-3}$ Sv per day indicating that astronauts could receive a radiation dose of ~ 0.66 Sv (~ 66 rem)—the limiting value established by NASA—during a fast conjunction Mars mission involving a 1-year journey through deep space. This dose rate could also be higher depending on the time in solar cycle that the mission occurs. When coupled with the potential for additional crew dose received during the lengthy exploration phase on Mars, it is of interest to see what proven NTP can do to reduce transit times further. Can NTP cut transit times in half and if so what are the engine requirements and vehicle configuration impacts?

The NTP was selected as the propulsion system of choice in DRA 5.0 because of its high thrust (10's of klb_f) and high specific impulse ($I_{sp} \sim 900$ to 940 s), its increased tolerance to payload mass growth and architecture changes, and its lower IMLEO which is important for reducing the HLV launch count, overall mission cost and risk. With a 100 percent higher I_{sp} than today's best chemical rockets, the use of NTP reduced the required launch mass for the baseline long stay mission by over 400 t—the equivalent mass of the International Space Station. For the higher energy, short stay opposition missions examined during Phase I, NTP provided an even greater mass savings—over 530 t compared to chemical propulsion. This is important to note since short stay missions will likely be selected by NASA when it decides to *send humans to orbit Mars in the early 2030s* as outlined in the United States' National Space Policy (Ref. 7). Lastly, it should not be overlooked that NTP is a proven technology successfully ground tested at the performance levels required for a human mission to Mars. The smallest and highest performing engine tested during the Rover/NERVA programs (Ref. 8)—the 25 klb_f “Pewee” engine is sufficient for a wide variety of human mission to Mars when used in a clustered engine arrangement. This means there are no large scale-ups in size or performance needed for NTP as there are with other proposed non-chemical propulsion options.

DRA 5.0 featured separate cargo and crewed Mars transfer vehicles each using a common “core” NTPS with three 25 klb_f Pewee-class engines. Two cargo vehicles were used to pre-deploy surface and orbital assets to Mars ahead of the crew who arrived during the next mission opportunity (~ 26 months later). The “*Copernicus*” crewed MTV (Fig. 2) is a 0-g_E vehicle (Refs. 9 and 10) consisting of three basic components: (1) the NTPS; (2) the crewed payload element; and (3) an integrated “saddle truss” and LH₂ propellant drop tank assembly that connects the two elements. With a propellant capacity of ~ 190 t in its two tanks, *Copernicus* can achieve 1-way transit times to Mars and back ranging from ~ 150 to 220 days over a 15-year synodic cycle starting in 2033.



Figure 2.—“Copernicus” crewed MTV in LEO prior to departure.

This paper examines the possibilities for achieving short transit times by reconfiguring the *Copernicus* design to allow it to carry larger quantities of LH₂ propellant needed for these more demanding missions. The paper covers the following topic areas. First, the operational principles and performance characteristics of the baseline 25 klb_f Pewee-class engine used in this analysis are presented along with a summary of the Rover/NERVA programs' technical accomplishments. Key NTP development activities currently funded under NASA's Advanced Exploration Systems (AES) program are also mentioned. Mission and transportation system ground rules and assumptions used in the analysis are then presented along with trajectory data for a fast conjunction 2033 mission that covers a range of transit times. *Copernicus*' key components and mission capabilities are reviewed next. To reduce 1-way transit times down to 130 days, then to 100 days, modifications are made to the *Copernicus* configuration incrementally—first with the addition of an in-line tank, then with the addition of paired sets of drop tanks—to increase the vehicle's propellant loading. A "split crewed mission" option that does not require orbital assembly and uses *Copernicus*' components is also described that can support a crewed mission with 90-day transit times. Mission scenario descriptions, key features and characteristics for five different vehicle configurations are presented along with the engines' operational requirements. The paper ends with a summary of our findings and some concluding remarks.

2.0 NTR System Description and Performance Characteristics

The NTR uses a compact fission reactor core containing 93 percent "enriched" Uranium (U)-235 fuel to generate 100's of megawatts of thermal power (MW_t) required to heat the LH₂ propellant to high exhaust temperatures for rocket thrust. In an "expander cycle" Rover/NERVA-type engine (Fig. 3), high pressure LH₂ flowing from either a single or twin turbopump assembly (TPA) is split into two paths with the first cooling the engine's nozzle, pressure vessel, neutron reflector, and control drums, and the second path cooling the engine's tie-tube assemblies. The flows are then merged and the heated H₂ gas is used to drive the TPAs. The hydrogen turbine exhaust is then routed back into the reactor pressure vessel and through the internal radiation shield and core support structure before entering the coolant channels in the reactor core's fuel elements. Here it absorbs energy produced from the fission of U-235 atoms, is superheated to high exhaust temperatures ($T_{ex} \sim 2550$ to 2950 K depending on fuel type and uranium loading), then expanded out a high area ratio nozzle (~300:1) for thrust generation.

Controlling the NTR during its various operational phases (startup, full thrust and shutdown) is accomplished by matching the TPA-supplied LH₂ flow to the reactor power level. Multiple control drums, located in the reflector region surrounding the reactor core, regulate the neutron population and reactor power level over the NTR's operational lifetime. The internal neutron and gamma radiation shield, located within the engine's pressure vessel, contains its own interior coolant channels. It is placed between the reactor core and key engine components to prevent excessive radiation heating and material damage.

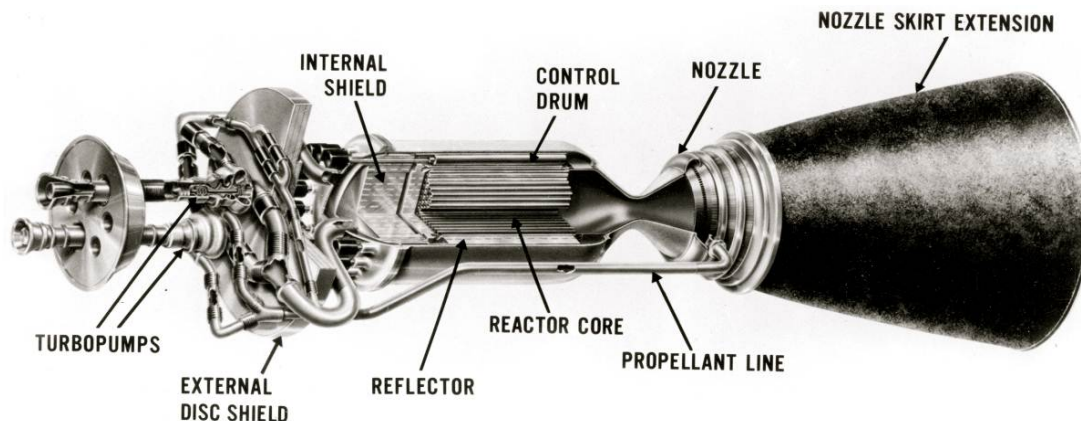

Figure 3.—Schematic of "expander cycle" NTR engine with dual LH₂ turbopumps.

The fuel elements (FE) tested in the Rover/NERVA program (Ref. 8) consisted of a “graphite matrix” material that contained the U-235 fuel in the form of either coated particles of uranium carbide (UC₂) or as a dispersion of uranium and zirconium carbide (UC-ZrC) referred to as “composite” fuel. Each FE (see Fig. 4) had a hexagonal cross section (~0.75 in. across the flats) and 19 axial coolant channels that were coated with niobium carbide (NbC) initially, then with zirconium carbide (ZrC) using a chemical vapor deposition (CVD) process. This protective coating, applied to the exterior FE surfaces as well, helped reduce hydrogen erosion of the graphite. Individual elements were 1.32 m (52 in.) in length and produced ~1 MW_e.

This basic FE shape and length was introduced in the KIWI-B4E reactor and became the standard used in the 75 klb_f Phoebus-1B, 250 klb_f Phoebus-2A, 25 klb_f Pewee and the 55 klb_f NERVA NRX series of engines (Ref. 8). The Rover program’s Pewee engine (Ref. 8) was designed and built to evaluate higher temperature, longer life fuel elements and improved coatings. It set several performance records including the highest average fuel element exit gas temperature of ~2550 K, and the highest peak fuel temperature ~2750 K. Other performance records included average and peak power densities in the reactor core of ~2340 MW_e/m³ and ~5200 MW_e/m³, respectively. A new CVD coating of ZrC was also introduced in Pewee that showed performance superior to the NbC coating used in previous reactor tests.

In addition to FEs, the engine reactor cores also included tie tube (TT) elements of the same hexagonal shape that provided structural support for the FEs. A coaxial coolant tube of Inconel inside each TT supplied a source of heated hydrogen for turbine drive power and a sleeve of zirconium hydride (ZrH) moderator material could also be incorporated in the TTs to help raise neutron reactivity (shown in Fig. 4). In the larger size engines tested during the Rover/NERVA programs, a “sparse” FE—TT arrangement was used with each FE having two adjacent TTs and four adjacent FEs comprising its six surrounding elements (Ref. 11). In this sparse pattern, the FE to TT ratio is ~3 to 1.

In the Small Nuclear Rocket Engine (SNRE) design developed by Los Alamos National Laboratory near the end of Rover/NERVA (Ref. 12), shorter (0.89 m/35 in.) FEs were used so additional TTs were included in the reactor to increase core reactivity. With the “SNRE” FE—TT pattern each FE has three adjacent TTs and three adjacent FEs surrounding it (shown in Fig. 4) and the FE to TT ratio is ~2 to 1. An important feature common to both the sparse and SNRE FE—TT patterns is that each tie tube provides mechanical support for six adjacent fuel elements.

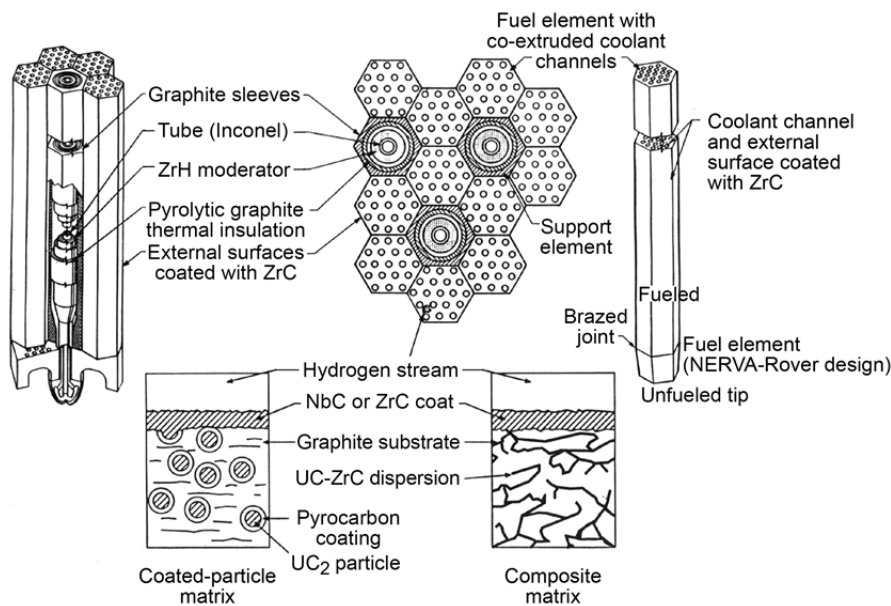



Figure 4.—Coated particle and composite SNRE fuel element and tie tube arrangement.

Recent Monte Carlo N-Particle (MCNP) transport modeling of engine reactor cores by Schnitzler et al., (Refs. 11, 13, and 14) has shown that the SNRE design can be scaled down to even lower thrust levels (~5.3 to 7.4 klb_f) or up to the 25 klb_f Pewee-class engine used in Mars DRA 5.0. For low thrust engines, short length elements (~0.89 m) and a “dense” FE—TT pattern are used consisting of parallel rows of FEs and TTs. Each FE has four adjacent TTs and two adjacent FEs surrounding it and the FE to TT ratio is ~1 to 1. By using the SNRE FE—TT pattern and increasing the FE length from 0.89 to 1.32 m (the same length used in the Rover program’s Pewee engine), the U-235 fuel loading in the core can be lowered from ~0.60 to 0.25 grams/cm³ allowing the FEs to operate at higher peak fuel temperatures (T_{peak}) while still staying safely below the melt temperature for composite fuel of ~3050 K. It also allows higher hydrogen exhaust/higher chamber inlet temperatures thereby increasing the engine’s I_{sp} capability. Higher I_{sp} operation can help stretch the available LH₂ propellant loading to meet mission requirements, or in the case of an emergency to allow a safe return of the crew. Engine and reactor performance characteristics for small and Pewee-class engines using composite fuel are summarized in Table 1.

The reference NTR engine used in DRA 5.0 and this paper is a 25 klb_f Pewee-class engine that is based on an “axial-growth” version of the SNRE. It utilizes an expander cycle and has the following nominal performance parameters: T_{ex} ~2790 K, chamber pressure ~1000 psia, nozzle area ratio (NAR) ~300:1, and I_{sp}~906 s. The LH₂ flow rate is ~12.5 kg/s and the engine thrust-to-weight ratio is ~3.50. The overall engine length is ~7.01 m, which includes an ~2.16 m long, retractable radiation-cooled nozzle skirt extension. The corresponding nozzle exit diameter is ~1.87 m. The higher chamber pressure helps to maintain reasonable nozzle dimensions at the assumed NAR. The engine’s reactor core contains 564 FEs and 241 TTs that are 1.32 m long like those used in Pewee. The core power level and fuel matrix power density are ~560 and ~3.44 MW_t/liter, respectively. The U-235 fuel loading used in the reactor FEs is ~0.25 grams/cm³ and the inventory of 93 percent enriched U-235 in the core is just under 37 kg. At this fuel loading the engine is able to operate at a T_{peak} of ~2860 K providing a temperature margin to fuel melt of ~190 K. During enhanced operation T_{peak} is raised to ~3010 K (a margin-to-melt temperature of ~40 K) and T_{ex} to ~2940 K resulting in an ~35 s increase in I_{sp} to ~940 s if needed. Table 1 also shows a “radial-growth” version of a Pewee-class engine using shorter FEs and a sparse FE—TT pattern for comparison.

TABLE 1.—PERFORMANCE CHARACTERISTICS FOR SMALL AND FULL SIZE “COMPOSITE” FUEL NTR ENGINES

<u>Performance Characteristic</u>	<u>7,420-lbf</u>	<u>SNRE</u>	<u>Axial Growth Option</u>		<u>Radial Growth Option</u>	
	<u>Option</u>	<u>Baseline</u>	<u>Nominal</u>	<u>Enhanced</u>	<u>Nominal</u>	<u>Enhanced</u>
Engine System						
Thrust (klb _f)	7.42	16.4	25.1	25.1	25.1	25.1
Chamber Inlet Temperature (K)	2736	2695	2790	2940	2731	2807
Chamber Pressure (psia)	1000	450	1000	1000	1000	1000
Nozzle Expansion Ratio(NAR)	300:1	100:1	300:1	300:1	300:1	300:1
Specific Impulse (s)	894	875	906	941	894	913
Engine Thrust-to-Weight	1.87	2.92	3.50	3.50	3.60	3.60
Reactor						
Active Fuel Length (cm)	89.0	89.0	132.0	132.0	89.0	89.0
Effective Core Radius (cm)	14.7	29.5	29.5	29.5	35.2	35.2
Engine Radius (cm)	43.9	49.3	49.3	49.3	55.0	55.0
Element Fuel/Tie Tube Pattern Type	Dense	SNRE	SNRE	SNRE	Sparse	Sparse
Number of Fuel Elements	260	564	564	564	864	864
Number of Tie Tube Elements	251	241	241	241	283	283
Fuel Fissile Loading (g U per cm ³)	0.60	0.60	0.25	0.25	0.45	0.45
Maximum Enrichment (wt% U-235)	93	93	93	93	93	93
Maximum Fuel Temperature (K)	2860	2860	2860	3010	2860	2930
Margin to Fuel Melt (K)	40	40	190	40	110	40
U-235 Mass (kg) 	27.5	59.6	36.8	36.8	68.5	68.5

High temperature UC-ZrC in graphite “composite” fuel with ZrC coating was selected as the primary fuel form in this analysis. Composite FEs were first tested in the “Nuclear Furnace” element test reactor (Ref. 8) and withstood peak power densities of ~ 4500 to $5000 \text{ MW}_t/\text{m}^3$. They also demonstrated better corrosion resistance than the standard coated particle graphite matrix fuel element used in the previous Rover/NERVA reactor tests. Composite fuel’s improved corrosion resistance is attributed to its higher coefficient of thermal expansion that more closely matches that of the protective ZrC coating, thereby helping to reduce coating cracking. Electrical-heated composite fuel elements were also tested by Westinghouse in hot hydrogen at 2700 K for ~ 600 min—equivalent to ten 1-hr cycles. At the end of Rover/NERVA program, composite fuel performance projections (Ref. 15) were estimated at ~ 2 to 6 hr at full power for hydrogen exhaust temperatures of ~ 2500 to 2800 K.

In addition to these carbide-based fuels, a ceramic-metallic or “cermet” fuel consisting of uranium dioxide (UO_2) in a tungsten (W) metal matrix was developed in the GE-710 and ANL nuclear rocket programs (Refs. 16 and 17) as a backup to the Rover/NERVA fuel. While no integrated reactor/engine tests were conducted, a large number of fuel specimens were produced and exposed to non-nuclear hot H_2 and irradiation testing with promising results. Both fuel options are under development today in NASA’s Advanced Exploration Systems (AES) program and the Nuclear Cryogenic Propulsion Stage (NCPS) project (Ref. 18) which began in FY’12. This 3-year project is a collaboration between NASA and DOE involving five key task activities that include state-of-the-art engine modeling, mission design and requirements definition, fuel element fabrication and non-nuclear testing, and analysis of affordable options for nuclear ground testing and engine development. If successfully completed by the end of FY’14, a NCPS-Phase II effort would begin that could culminate in ground testing a small NTR engine at the Nevada Test Site (NTS) in the early 2020’s, followed by a flight demonstration mission several years later (Ref. 19).

Finally, the motivation for selecting NTP as the propulsion system of choice for Mars is simple—it is a proven technology with a specific impulse that is twice that of today’s best chemical rockets. During the Rover/NERVA programs (1955 to 1972), a technology readiness level (TRL ~ 5 and 6) was achieved (Ref. 8). Twenty rocket reactors were designed, built and ground tested in integrated reactor/engine tests that demonstrated: (1) a wide range of thrust levels (~ 25 , 50, 75, and 250 klb_f); (2) high temperature carbide-based nuclear fuels that provided hydrogen exhaust temperatures up to 2550 K (*achieved in Pewee*); (3) sustained engine operation (*over 62 min for a single burn achieved in the NRX-A6*); as well as (4) accumulated lifetime at full-power; and (5) restart capability (*>2 hr with 28 startup and shutdown cycles achieved in the NRX-XE experimental engine*)—all the requirements needed for short transit time Mars missions. Just as important, NTP requires no large scale-ups in size or performance that are required with other advanced propulsion options. A cluster of three to four Pewee-class engines are more than adequate.

3.0 ΔV Budgets, Mission and Transportation System Ground Rules and Assumptions

The fast conjunction 2033 opportunity was selected as the baseline mission for this analysis since missions performed in the 2033 to 2035 timeframe have ΔV budgets near their minimum values over the 15-year synodic cycle. As a result, it is expected that the shortest achievable transit times would be found in this opportunity. Table 2 shows the ideal ΔV budgets as a function of decreasing transit time for the outbound Earth to Mars mission leg. It is assumed that the crewed MTV departs from a 407 km circular LEO, then captures into and departs from a 250 by 33,793 km elliptical Mars orbit (EMO) with a 24-hr orbital period. Gravity losses are also added to the ideal ΔV s and depend on the particular mission C_3 , vehicle thrust-to-weight (F/W), and propulsion system specific impulse.

TABLE 2.—TRAJECTORY DATA FOR 2033 FAST CONJUNCTION MISSION—OUTBOUND EARTH-TO-MARS LEG

Case No.	Departure Date	Transit Time (days)	Arrival Date	Departure C3 (km ² /s ²)	ΔV Earth Departure TMI (km/s)	Arrival V_{∞} at Mars (km/s)	ΔV Mars Arrival MOC (km/s)	Total Outbound ΔV (km/s)
1	22-Apr-2033	220	28-Nov-2033	9.88	3.621	3.476	1.338	4.959579
2	18-Apr-2033	210	14-Nov-2033	9.43	3.601	3.351	1.267	4.867747
3	17-Apr-2033	200	3-Nov-2033	9.09	3.586	3.316	1.247	4.833317
4	18-Apr-2033	190	25-Oct-2033	9.19	3.591	3.362	1.273	4.863803
5	21-Apr-2033	180	18-Oct-2033	9.87	3.621	3.470	1.335	4.955930
6	25-Apr-2033	170	12-Oct-2033	11.16	3.678	3.630	1.429	5.107259
7	30-Apr-2033	160	7-Oct-2033	13.08	3.762	3.840	1.558	5.319964
8	4-May-2033	150	1-Oct-2033	15.68	3.875	4.105	1.726	5.600835
9	8-May-2033	140	25-Sep-2033	19.05	4.021	4.430	1.941	5.961198
10	13-May-2033	130	20-Sep-2033	23.36	4.204	4.826	2.214	6.417577
11	17-May-2033	120	14-Sep-2033	28.84	4.432	5.307	2.561	6.993248
12	21-May-2033	110	8-Sep-2033	35.83	4.718	5.892	3.003	7.720966
13	25-May-2033	100	2-Sep-2033	44.90	5.079	6.608	3.569	8.647579
14	28-May-2033	90	26-Aug-2033	56.98	5.544	7.493	4.298	9.841926
15	1-Jun-2033	80	20-Aug-2033	73.65	6.161	8.603	5.248	11.408971
16	5-Jun-2033	70	14-Aug-2033	97.86	7.010	10.023	6.506	13.516432
17	8-Jun-2033	60	7-Aug-2033	135.35	8.236	11.889	8.212	16.448392

TABLE 3.—TRAJECTORY DATA FOR 2033 FAST CONJUNCTION MISSION—MARS-TO-EARTH RETURN LEG

Case No.	Departure Date	Transit Time (days)	Arrival Date	Departure C3 (km ² /s ²)	ΔV Mars Departure TEI (km/s)	Slow Down Earth Arrival ΔV (km/s)	Arrival V_{∞} at Earth (km/s)	Stay Time at Mars (days)
1	17-Apr-2035	220	23-Nov-2035	9.41	1.110	0.000	3.118	505.0
2	28-Apr-2035	210	24-Nov-2035	8.96	1.070	0.000	3.059	529.8
3	6-May-2035	200	22-Nov-2035	8.76	1.054	0.000	3.029	548.8
4	12-May-2035	190	18-Nov-2035	8.84	1.061	0.000	3.090	563.2
5	17-May-2035	180	13-Nov-2035	9.17	1.089	0.000	3.277	575.0
6	22-May-2035	170	8-Nov-2035	9.74	1.139	0.000	3.585	586.1
7	26-May-2035	160	2-Nov-2035	10.57	1.210	0.000	3.995	595.9
8	30-May-2035	150	27-Oct-2035	11.74	1.310	0.000	4.490	605.6
9	4-Jun-2035	140	22-Oct-2035	13.31	1.441	0.000	5.059	616.2
10	9-Jun-2035	130	17-Oct-2035	15.44	1.614	0.000	5.698	627.0
11	14-Jun-2035	120	12-Oct-2035	18.32	1.840	0.000	6.409	637.8
12	19-Jun-2035	110	7-Oct-2035	22.30	2.141	0.387	7.197	649.5
13	25-Jun-2035	100	3-Oct-2035	27.85	2.539	1.266	8.076	661.2
14	1-Jul-2035	90	29-Sep-2035	35.82	3.075	2.257	9.067	673.3
15	7-Jul-2035	80	25-Sep-2035	47.58	3.804	3.396	10.206	685.7
16	13-Jul-2035	70	21-Sep-2035	65.61	4.813	4.743	11.553	698.6
17	20-Jul-2035	60	18-Sep-2035	94.65	6.243	6.408	13.218	711.9

Table 3 shows the ideal ΔV budgets for the same range of transit times for the inbound Mars to Earth mission leg with Mars departure occurring in late 2035. The last column in the table shows the corresponding stay time at Mars assuming equal outbound and inbound transit times. As transit times decrease, it becomes necessary to perform a slowdown burn on the return leg to ensure that arrival V_{inf} at Earth is less than 6.81 km/s at an altitude of ~125 km.

For 180-day transits to and from Mars and a 575-day stay time at Mars, the total round trip time and ΔV budget (minus g-loss) for the mission are 935 days and 6.045 km/s, respectively. Cutting the transit times in half to 90-days increases the Mars stay time to ~673 days, but decreases the round trip time to ~853 days. The mission ΔV budget however, increases by ~250 percent to ~15.175 km/s! While challenging, transit times this short are possible using NTP.

The mission and transportation system ground rules and assumptions used in this paper are summarized in Tables 4 and 5, respectively. Table 4 provides information about the mission profiles and operational scenarios, and the assumed parking orbits at Earth and Mars. In addition to the large ΔV requirements for the primary propulsion maneuvers—trans-Mars injection (TMI), Mars orbit capture (MOC), and trans-Earth injection (TEI)—smaller ΔV maneuvers are needed for rendezvous and docking (R&D) of vehicle components during the LEO assembly phase, for spacecraft attitude control during in-space transit, and for “split crewed mission” orbital operations at Mars.

TABLE 4.—MISSION AND PAYLOAD GROUND RULES AND ASSUMPTIONS

Mission Profiles:	<ul style="list-style-type: none"> • Split mission; cargo pre-deployed to Mars before crew leaves Earth • Cargo missions use “1-way” minimum energy trajectory • Round trip crewed missions use “fast conjunction” trajectories • Direct return uses Orion capsule for crew recovery at mission end • For “split crewed mission option”, a pre-deployed Earth Return Vehicle (ERV) uses minimum energy trajectory out to Mars and a fast conjunction transfer trajectory back to Earth
Missions depart for Mars from low Earth orbit (LEO); capture into and depart from a 24-hr elliptical Mars orbit (EMO)	<ul style="list-style-type: none"> • LEO: 407 km circular • 24-hr EMO: 250 km x 33, 793 km
Mars Mission ΔV Budgets:	<ul style="list-style-type: none"> • Mission dates, trip times and ΔV budgets provided in Tables 1 & 2
Additional ΔV Requirements: Advanced Material Bipropellant Rocket (AMBR) RCS thrusters used to perform non-primary propulsion maneuvers	<ul style="list-style-type: none"> • LEO R&D between orbital elements: $\sim 15 - 100$ m/s • Coast attitude control and mid-course correction: ~ 15 m/s and ~ 50 m/s, respectively • Mars orbit maintenance plus R&D: ~ 100 m/s
Crewed Mission Payload Masses: Varies with crew size and mission duration; consumables based on a crew consumption rate of ~ 2.45 kg/person/day; payload also includes a short saddle truss (SST), a transfer tunnel with second docking module (TDM) and an exterior contingency consumables container that is jettisoned prior to the trans-Earth injection (TEI) maneuver	<ul style="list-style-type: none"> • Transit Habitat: 22.7 t – 27.5 t (minus consumables) • SST/TDM/Container: 5.08 t / 1.76 t / 23% of stored food • Crew (4-6): 0.4 t – 0.6 t • Total Consumables: 3.58 t – 5.37 t (4 – 6 crew for 1-yr); with extra consumables stored in exterior container • Orion / MPCV: ~ 10.0 t • Returned Samples: 0.25 t – 0.5 t (Mars)
Mission Abort Strategy:	<ul style="list-style-type: none"> • Outbound: Abort to Mars Surface • At Mars: Abort to the orbiting crew MTV which carries contingency consumables onboard

TABLE 5.—NTR TRANSPORTATION SYSTEM GROUND RULES AND ASSUMPTIONS

NTR System Characteristics	<ul style="list-style-type: none"> • Engine / Fuel Type: SNRE-derived / UC-ZrC “Composite” • Propellant: LH_2 • Thrust Level: 25 klb_f (“Pewee-class” is baseline) (3 – 4 engine cluster on “Core” NTPS) • Fuel Element Length: 1.32 m • Exhaust Temp: $T_{ex} \sim 2790 - 2940$ K • Chamber Pressure: $P_{ch} \sim 1000$ psi • Nozzle Area Ratio: 300:1 • I_{sp} Range: 906 s (2790 K) – 941 s (2940 K)
Propellant Margins	<ul style="list-style-type: none"> • Cooldown: 3% of usable LH_2 propellant • Performance reserve: 1% on ΔV • Tank trapped residuals: 2% of total tank capacity
Reaction Control System (LEO R&D, Settling, Attitude Coast Control, and Mid-course Correction Burns)	<ul style="list-style-type: none"> • Propulsion Type: AMBR 200 lb_f thrusters • Propellant: NTO / N_2H_2 • Nominal I_{sp}: 335 seconds
LH_2 Cryogenic Tanks and Passive Thermal Protection System (TPS)	<ul style="list-style-type: none"> • Material: Aluminum-Lithium (Al/Li) and Composite; (Al/Li is the baseline) • Tank OD: 10.0 m • Tank L: ~ 19.7 m (for “core” NTPS) ~ 22.7 m (for “in-line” and drop tanks) • Geometry: cylindrical with root 2/2 ellipsoidal domes • Insulation: 1” SOFI (~ 0.78 kg/m^2) + 60 layers of MLI (~ 0.90 kg/m^2)
Active Cryo-Fluid Management / Zero Boil-Off (ZBO) LH_2 Propellant System	<ul style="list-style-type: none"> • Reverse turbo-Brayton ZBO cryocooler system powered by PVAs • ZBO system mass and power requirements driven by core stage size; ~ 930 kg and ~ 8.87 kW_e (10.0 m D)
Photovoltaic Array (PVA) Primary Power System	<ul style="list-style-type: none"> • Circular PVA sized for ~ 7 kW_e at 1 A.U., two arrays provide power for ZBO cryocoolers on core NTPS and in-line tanks when used, PVA mass is ~ 455 kg & array area is ~ 25 m^2; to supply 1 kW_e at Mars requires ~ 10 m^2 of array area • “Keep-alive” power supplied by lithium-ion battery system
Dry Weight Contingency Factors	<ul style="list-style-type: none"> • 30% on NTR system and composite structures (e.g., saddle truss) • 15% on established propulsion, propellant tanks, spacecraft systems
SLS / HLV Launch Requirements: – Lift Capability to LEO – Cylindrical Payload (PL) Envelope	<ul style="list-style-type: none"> • ~ 140 t; NTPS with external crew radiation shields • 11 m D x ~ 33.8 m L (for DRA 5.0 crewed PL element)

For the crewed mission, the outbound payload mass varies with the crew size and mission duration. For long surface stay Mars missions, the crewed MTV carries contingency consumables equivalent to that found on the habitat lander. This allows the crew MTV to function as an orbital “safe haven” in the event of a major failure of a key surface system. For the nominal surface mission, the contingency consumables are jettisoned prior to the TEI maneuver. Fixed mass payload elements include the Orion Multi-Purpose Crew Vehicle (MPCV). For Mars DRA 5.0 and in this analysis it is assumed that ~250 to 500 kg of samples are returned.

Table 5 lists the key transportation system ground rules and assumptions. The NTR engine and fuel type, operating characteristics, and thrust levels examined are summarized first. All engines use composite fuel with a U-235 fuel loading of 0.25 g/cm³. With $T_{ex} \sim 2790$ K and NAR $\sim 300:1$, the I_{sp} is ~ 906 s with higher I_{sp} values achievable by increasing the fuel operating temperature. The total mission LH₂ propellant loading consists of the usable propellant plus performance reserve, post-burn engine cooldown, and tank-trapped residuals. For the smaller auxiliary maneuvers, a storable bipropellant RCS system is used. All transfer vehicle configurations utilize a “split RCS” with 16 of 32 AMBR thrusters and approximately half of the bipropellant mass located on the rear propulsion stage and the forward most saddle truss adaptor ring just behind the TransHab module.

The LH₂ propellant carried by the various vehicles is stored in the same “state-of-the-art” Al/Li LH₂ propellant tank being developed for the SLS/HLV that will support future human exploration missions. For this analysis, tank sizing assumes a 30 psi ullage pressure, 5 g_E axial/2.5 g_E lateral launch loads, and a safety factor of 1.5. A 3 percent ullage factor is also assumed. All tanks use a combination foam/multilayer insulation (MLI) system for passive thermal protection. A zero boil-off (ZBO) “reverse turbo-Brayton” cryocooler system is used on the core NTPS and “in-line” LH₂ tanks (where required) to eliminate boil-off during LEO assembly and the remainder of the mission which can be as long as 950 days in duration. The propellant tank heat load is largest in LEO and sizes the ZBO cryocooler system. Solar photovoltaic arrays are baselined for supplying the primary electrical power needed for all key transfer vehicle subsystems. Because of the decreased solar radiation at Mars (~ 486 W/m²), array areas can become quite large (~ 10 m²/kW_e) necessitating multiple arrays for human Mars missions.

Table 5 also includes the “dry weight contingency” (DWC) factors, along with the lift and payload envelope requirements for the “upgraded” SLS/HLV. A 30 percent DWC is used on the NTR system and advanced composite structures (e.g., stage adaptors, trusses) and 15 percent on heritage systems (e.g., Al/Li tanks, RCS, etc.). The NTPS and crewed payload element (PL) determine the required lift and PL envelope. The optimum tank diameter and mass for a Mars NTPS are 10 m and ~ 140 t (Ref. 9). The crewed PL element includes the “packaged” TransHab module with PVA power system, the short saddle truss, consumables container and transfer tunnel with secondary docking module (DM), and the Orion MPCV (shown Figs. 2 and 6). The PL envelope’s diameter is ~ 11 m (the saddle truss outer dimension) and its length can be up to ~ 33.8 m (the DRA 5.0 PL length including the Orion MPCV).

4.0 Mars DRA 5.0: “7-Launch” NTR Mission Overview

The 7-Launch NTR Mars mission strategy (Ref. 9) for a 2033 human landing mission is illustrated in Figure 5. It assumes a long surface stay, split cargo/piloted mission approach. Two cargo flights pre-deploy a cargo lander to the surface and a habitat lander into Mars orbit where it remains until the arrival of the crew on the next mission opportunity (~ 26 months later). The cargo flights utilize “1-way” minimum energy, long transit time trajectories. Four HLV flights carried out over 90 days (~ 30 days between launches), deliver the required components for the two cargo vehicles. The first two launches deliver the NTR propulsion stages each with three 25 klb_f NTR engines. The next two launches deliver the cargo and habitat lander payload elements which are enclosed within a large triconic-shaped aeroshell that functions as a payload shroud during launch, then as an aerobrake and thermal protection system during Mars aerocapture (AC) and subsequent entry, descent and landing (EDL) on Mars. Vehicle assembly involves Earth orbit rendezvous and docking (R&D) between the propulsion stages and payload elements with the NTR stages functioning as the active element in the R&D maneuver.

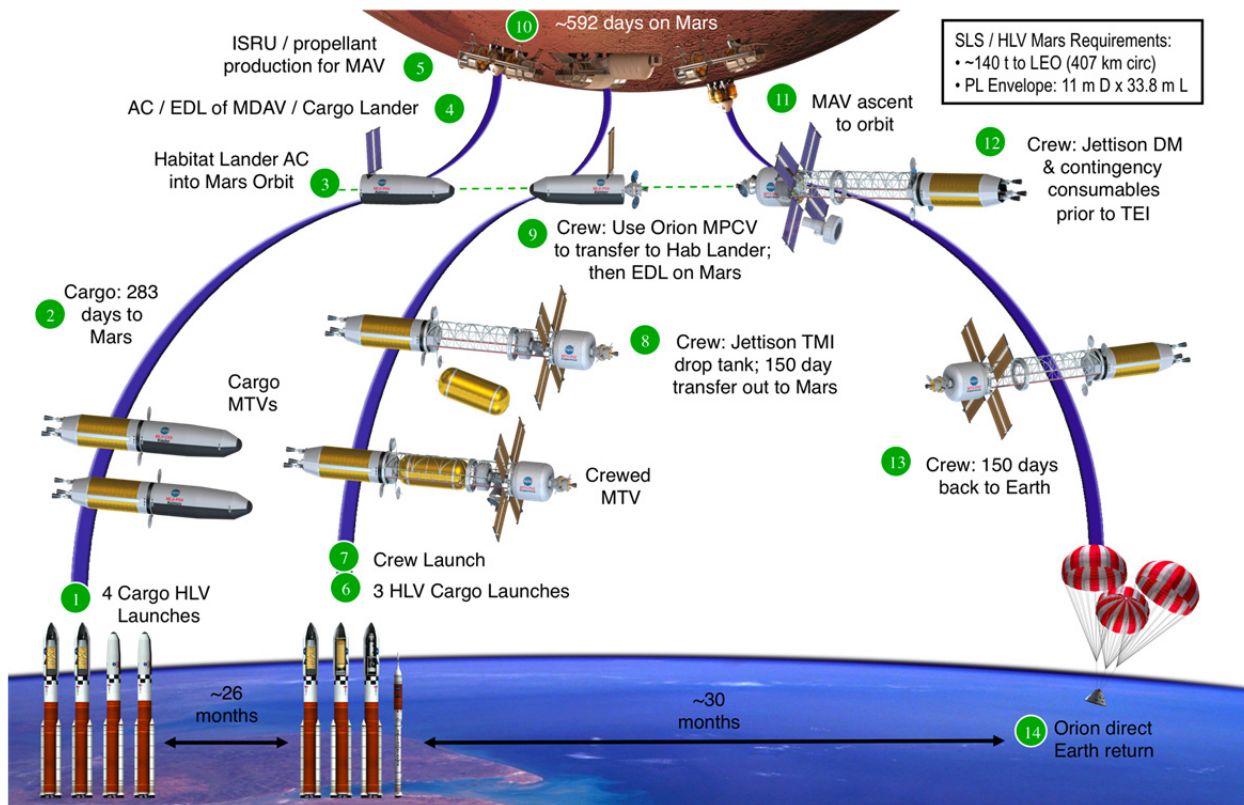

Figure 5.—DRA 5.0 long-stay Mars 2033 mission overview: “7-launch” NTR strategy.

Once the operational functions of the orbiting habitat and surface cargo landers are verified, and the Mars Ascent Vehicle (MAV) is supplied with ISRU-produced ascent propellant, the crewed MTV is readied and departs on the next mission opportunity. The baseline *Copernicus* design is capable of 1-way transit times ranging from ~150 to 220 days depending on the particular opportunity. For the 2033 mission, 150-day transit times are possible. Like the cargo MTVs, *Copernicus* is assembled in LEO using Earth orbit R&D. It uses the same “common” NTPS but includes additional external radiation shielding on each engine for crew protection during engine operation. Three HLV launches over 60 days are used to deliver the vehicle’s key elements which include: (1) the NTPS; (2) the integrated “saddle truss” and LH₂ drop tank assembly; and (3) the crewed payload. The payload element includes the TransHab module with its six crew, the Orion MPCV for vehicle-to-vehicle transfer and “end of mission” re-entry, a secondary T-shaped DM, a contingency consumables container and connecting structure. Four 12.5 kW_e/125 m² rectangular PVAs provide ~50 kW_e of electrical power at Mars for crew life-support (~30 kW_e), a ZBO Brayton cryocooler system (~10 kW_e), and high data- rate communications (~10 kW_e) with Earth. When assembly is completed, the Mars crew is delivered to LEO on either the SLS or a commercial launch vehicle and docks with *Copernicus* on its underside using the secondary DM that connects the TransHab crew module and contingency consumables container (shown in Figs. 6 and 7).

Following the TMI maneuver, the drained LH₂ drop tank, attached to the saddle truss, is jettisoned and the crewed MTV coasts to Mars under 0-g_E conditions with its four PVAs tracking the Sun. Attitude control and mid-course correction maneuvers are provided by *Copernicus*’ split RCS that uses 200 lb_f storable bipropellant Advanced Material Bipropellant Rocket (AMBR) thrusters located on the rear NTPS and the short saddle truss forward adaptor ring just behind the TransHab module. After the MOC burn, *Copernicus* rendezvous with the orbiting Hab lander using engine cool-down thrust and the vehicle’s RCS. The crew then transfers over to the lander using the MPCV. After crew transfer, the MPCV returns and docks to the TransHab autonomously. The crew then initiates EDL near the cargo lander and begins the surface exploration phase of the mission. After ~592 days on the surface, the crew lifts off using the

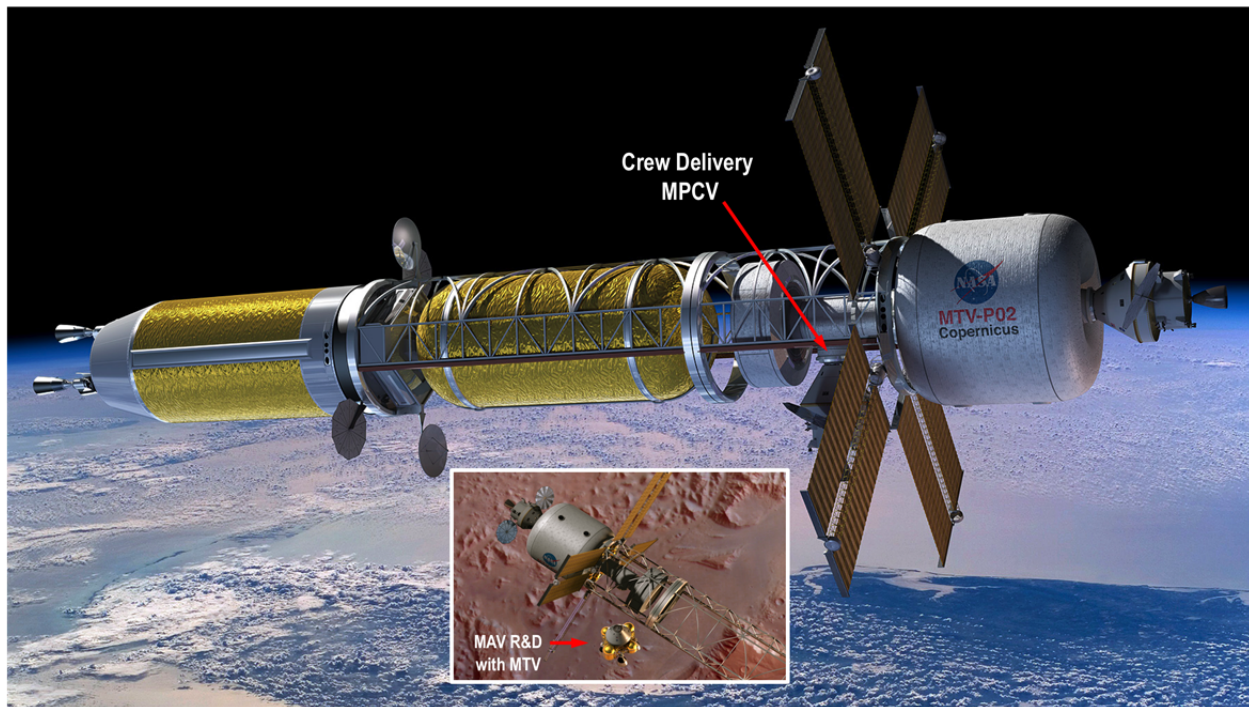

Figure 6.—*Copernicus*' secondary DM provides access to the MPCV and MAV during the mission.

MAV and returns to *Copernicus* using its secondary DM (shown in Fig. 6). Following the transfer of the crew and samples, the MAV is jettisoned. The crew then begins a weeklong checkout and verification of all MTV systems, jettisons the DM and contingency consumables and performs the TEI burn to begin the journey back to Earth. After a 150-day return trip, the crew enters the MPCV, separates from the MTV and re-enters Earth's atmosphere while *Copernicus* flies by Earth at a "sufficiently high altitude" and is disposed of into heliocentric space. Although *Copernicus* was operated in an "expendable mission mode" in DRA 5.0 to reduce total IMLEO and number of HLV launches, it can readily be modified to operate in a "reuse mode" by providing the vehicle with additional propellant capacity as discussed elsewhere (Ref. 10).

The *Copernicus* crewed MTV has an overall length of ~ 93.7 m (Fig. 7) and an IMLEO of ~ 331.7 t for the 150-day transit 2033 mission. Included are (1) the NTPS (~ 138.8 t); (2) the saddle truss and LH₂ drop tank (~ 125.6 t); and (3) the crew payload section (~ 67.3). The NTPS uses a three-engine cluster of 25 klb_f NTR engines and also carries additional external radiation shield mass (~ 6 t) for crew protection. The NTPS uses an Al/Li LH₂ tank size which has a diameter (D) and length (L) of 10 m D by 19.7 m L. The LH₂ tank has a propellant capacity of ~ 87.2 t but is slightly off-loaded for this particular mission and carries ~ 86.8 t. The NTPS also carries avionics, RCS, auxiliary battery and PVA power, docking and Brayton-cycle ZBO refrigeration systems located in the forward cylindrical adaptor section. To remove ~ 78 W of heat penetrating the 60 layer MLI system in LEO (where the highest tank heat flux occurs), the 2-stage cryocooler system requires ~ 8.9 kW_e for its operation. Twin circular PVAs on the NTPS provide the electrical power for the ZBO system in LEO until the four primary PVAs on the crewed PL section are deployed prior to TMI.

Copernicus' second major component is its saddle truss and LH₂ drop tank assembly. The saddle truss is a rigid, spine-like composite structure that wraps around the upper half of the LH₂ drop tank and connects the NTR stage to the forward payload section. It is ~ 27.7 m long and has a mass of ~ 9 t. The saddle truss is open underneath allowing the drained LH₂ drop tank to be jettisoned after the TMI burn is completed. The ~ 22.7 m long LH₂ drop tank has a mass of ~ 21 t and a propellant capacity of ~ 102.4 t but is also off-loaded and only carries ~ 91.9 t of LH₂ propellant.

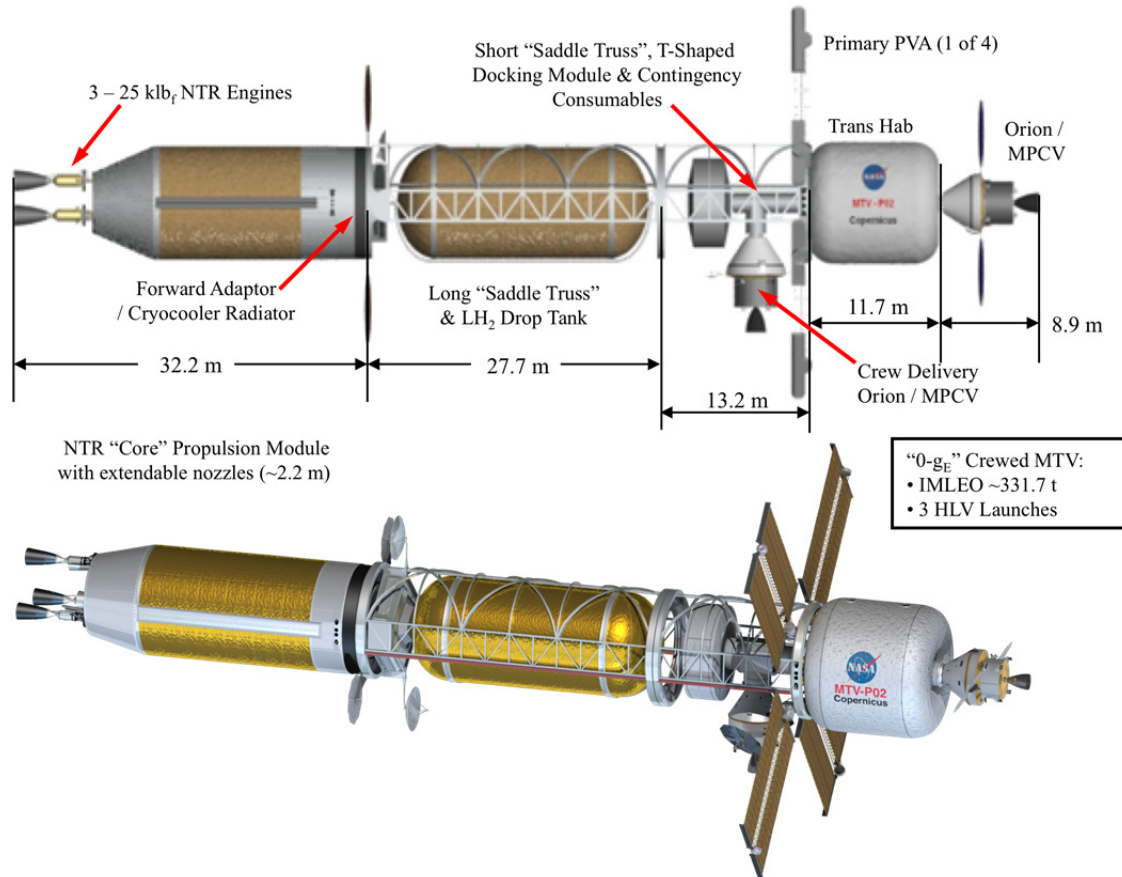

Figure 7.—Key features and component lengths of the Copernicus Mars transfer vehicle.

Copernicus' third and final component is its payload section. In DRA 5.0 it was designed for launch as a single integrated unit and thus determines the overall size of the PL envelope. The integrated payload element is ~33.8 m long and includes the short saddle truss, “T-shaped” DM and transfer tunnel, consumables container, TransHab and crew, and the Orion MPCV. The DM provides “secondary access” to *Copernicus* for the crew delivery MPCV and the MAV (see Figs. 6 and 7). Following the crew's return from Mars and MAV separation, the DM and attached consumables container are both jettisoned to reduce vehicle mass prior to TEI (see Fig. 5).

The total crewed payload mass at TMI is ~67.3 t distributed as follows: (1) short saddle truss (~5.1 t); (2) DM and transfer tunnel (~2.8 t); (3) contingency consumables and jettisonable container (~10.7 t); (4) TransHab with its primary PVAs (~27.5 t); (5) transit consumables (~4.6 t); (6) crew (~0.6 t); (7) MPCV (~10 t); and (8) forward RCS and propellant (~6 t). *Copernicus*' total RCS propellant loading is ~11.9 t with the “post-TMI” RCS propellant load split between the NTPS (~7 t) and the short saddle truss forward cylindrical adaptor ring (~4.9 t).

Lastly, for this particular mission, the performance requirements on operating time and restart for *Copernicus*' three 25.1 klb_f NTR engines are quite reasonable. For the round trip mission, there are four primary burns (three restarts) that use ~168.7 t of LH₂ propellant. With ~75.3 klb_f of total thrust and a I_{sp} of ~906 s, the total engine burn time for the mission is ~74.6 min (~53.2 min for the “2-perigee burn” TMI maneuver, ~13.6 min for MOC, and ~7.8 min for TEI), well under the ~2 hr accumulated engine burn time and 27 restarts demonstrated by the NERVA eXperimental Engine—the NRX-XE (Ref. 8).

5.0 Copernicus “Growth” Options Allowing Faster Transit Time Missions

As discussed in Section 4.0, *Copernicus* was sized so it can perform all fast conjunction missions in the 2033 to 2048 timeframe. For the 2033 mission opportunity, with its propellant tanks near their maximum capacity of ~190 t, *Copernicus* can achieve 150-day transit times. Besides human Mars missions, the “3-element” *Copernicus* spacecraft (Fig. 8) has significant capability that can be exploited for a variety of other mission applications such as a reusable human mission to the large, high energy near Earth asteroid—Apophis in 2028. “Scaled down” versions of *Copernicus* can also be used for reusable lunar cargo delivery and crewed lunar landing missions. Mission details and vehicle characteristics for these applications are provided elsewhere (Ref. 10).

Figure 9 shows the round trip mission ΔV versus transit time for the 2033 opportunity using the trajectory data found in Tables 2 and 3. As is evident, the ΔV requirements rise dramatically as the transit times are shortened. Decreasing the transit times by 60 days—from 180 to 120 days—increases the total mission ΔV by ~46 percent. A further 60-day reduction in transit time—down to 90 days each way—increases the total mission ΔV by ~250 percent.

To achieve transit times less than 150 days, it is necessary to modify the *Copernicus* spacecraft so it can carry additional propellant. This will be done in incremental steps—first with the addition of an in-line tank, then with the addition of paired sets of drop tanks—to show what can be achieved, but also to show what is required in terms of extra hardware, engine operating time and additional HLV launches.

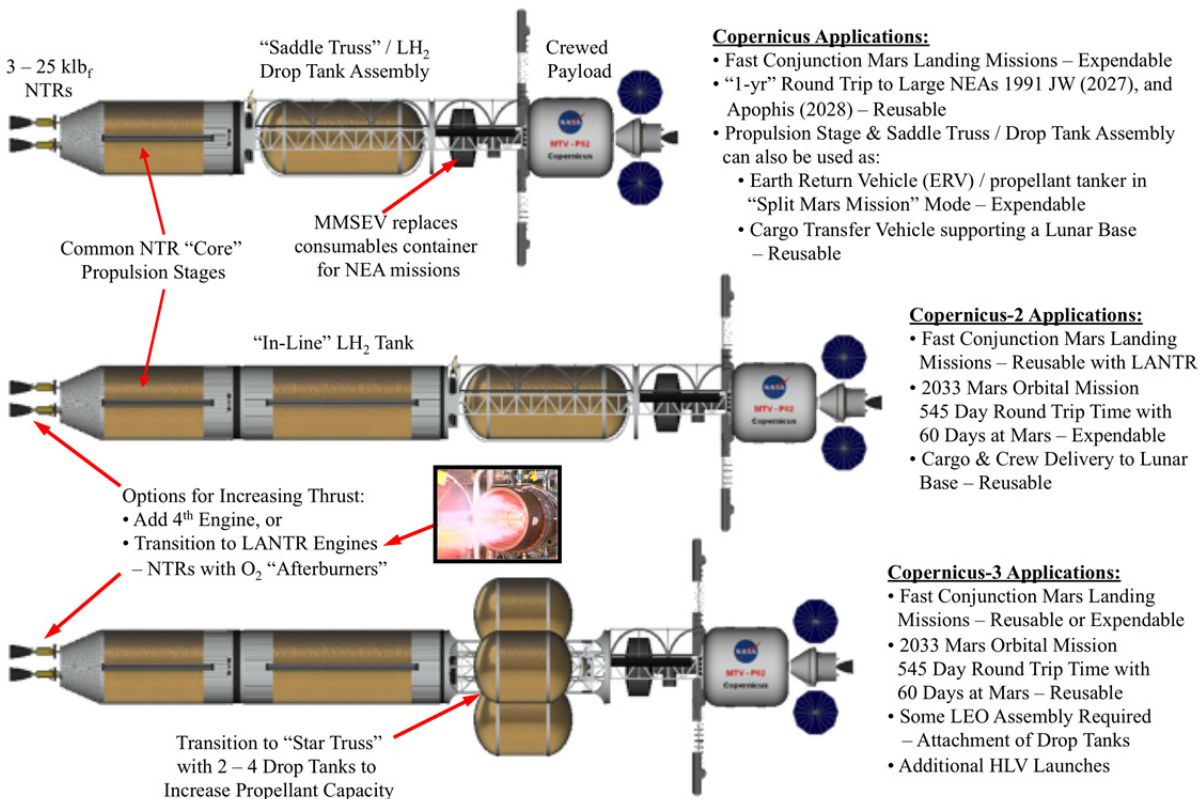

Figure 8.—Growth paths and alternative missions for Copernicus spacecraft using modular components.

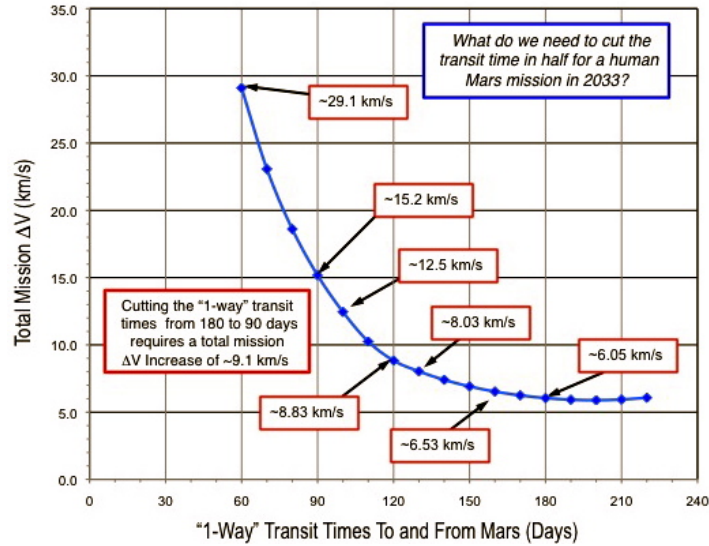

Figure 9.—Total mission ΔV versus transit time.

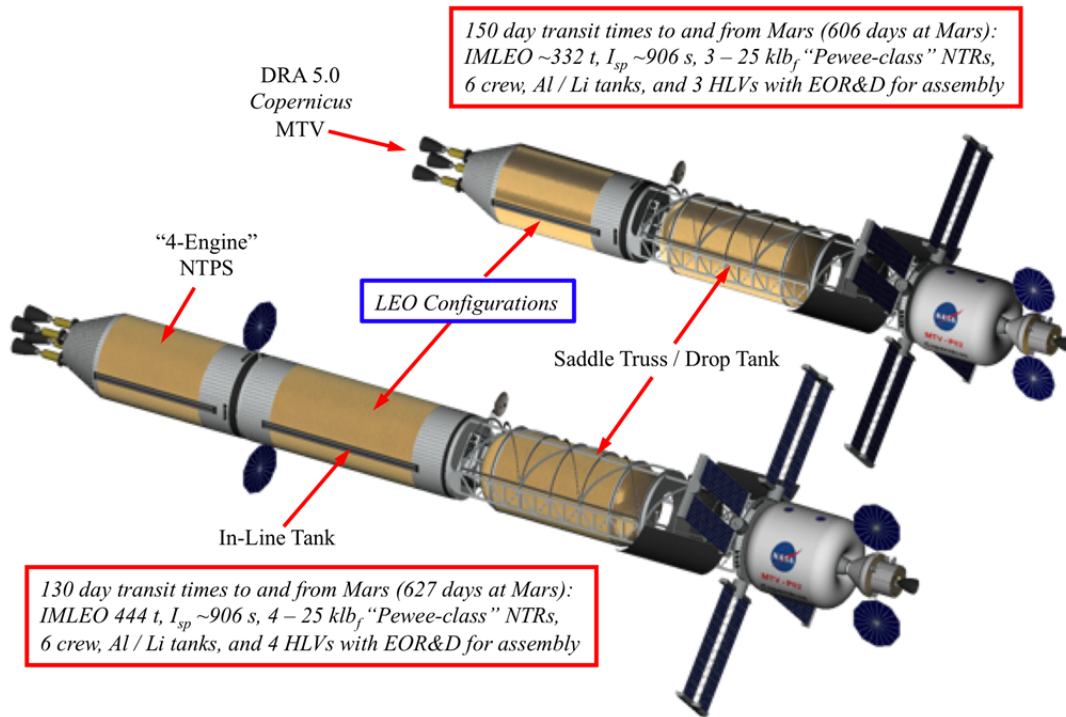

Figure 10.—Copernicus-2 option: Supports 130-day transit times for the 2033 mission.

5.1 Copernicus-2 Option: Addition of an In-Line Tank to Achieve 130-day Transit Times

To reduce transit times by 20 days—from 150 to 130 days, the *Copernicus-2* configuration positions an “in-line” LH₂ tank between the NTPS and integrated saddle truss/drop tank assembly (shown in Figs. 8 and 10). This configuration has an IMLEO of ~443.8 t consisting of the “wet” NTPS (~136.4 t), in-line tank (~118.5 t), saddle truss/drop tank assembly (~119 t) and the crew PL section (~69.9 t). The overall vehicle length is ~117.6 m including the Orion MPCV at ~8.9 m. The LH₂ tank length in the NTPS is ~19.7 m and it carries ~86.1 t of propellant (close to its maximum capacity of ~87.2 t). The in-line and

drop tank lengths are the same at ~20.5 m and each tank carries ~91.5 t of LH₂ propellant. With these equal tank lengths, the masses of in-line tank element and the saddle truss/drop tank assembly are balanced at ~118.8 t.

For this 130-day transit mission, there are four primary burns (with three restarts) and ~253.8 t of LH₂ propellant is used. A fourth engine is added to the NTPS to reduce the total engine operating time and minimize g-losses (~326 m/s) during the TMI maneuver but this increases NTPS inert mass at the expense of LH₂ and RCS propellant loading. With ~100.4 klb_f of total thrust and a I_{sp} of 906 s, the total engine burn time for this mission is ~84.2 min. The first TMI perigee burn is the longest single burn at ~35 min. After this burn, the drop tank is drained and then jettisoned to reduce vehicle mass and propellant consumption during the second perigee burn (~21.8 min). The in-line tank and NTPS supply the propellant for the remaining MOC (~17.5 min) and TEI burns (~9.9 min).

Copernicus-2 also requires one additional HLV launch as well as the development of the in-line tank element with its own ZBO cryocooler system. For the longer in-line tank, the cryocooler system requires ~9.13 kW_e of electrical power supplied by PVAs on the NTPS and in-line tank. Even with a fourth engine added, the total burn time requirement on the engines is increased by 13 percent (from 74.6 to 84.2 min). An alternative to adding a fourth NTR engine would be to add oxygen “afterburner” nozzles to *Copernicus’* three NTR engines. In the “LOX-Augmented” NTR (LANTR) option (Refs. 20 and 21), oxygen is injected into the divergent section of the nozzle downstream of the sonic throat. Here it mixes with reactor-heated H₂ and undergoes supersonic combustion adding both mass and chemical energy to the engine’s exhaust. By operating the LANTR engines with a LOX-to-LH₂ mixture ratio (MR) = 1 during the first TMI perigee burn, the engine’s thrust level can be increased by over 62 percent—from 25 to ~40.6 klb_f. The addition of oxygen lowers the I_{sp} to ~725 s but this is still ~270 s higher than that achieved by LOX/LH₂ engines.

5.2 Copernicus-3 Option: Addition of Twin Drop Tanks to Achieve 120-day Transit Times

In the *Copernicus-3* configuration (shown in Figs. 8 and 11), the saddle truss/drop tank assembly is replaced by a 4-sided “star truss” with twin LH₂ drop tanks that supplement the propellant carried by the NTPS and in-line tank. *Copernicus-3* has an IMLEO of ~551.3 t including the NTPS (~139.9 t), the in-line tank (~133.8 t), the “star truss” with drop tanks (~210.3 t) and the crew PL section (~67.3 t). Two drop tanks (~190 t) carrying ~159.4 t of LH₂ (~79.7 t per tank) are delivered to LEO on two HLV launches, then attached to the ~25.4 m long star truss (~20.3 t) during the LEO assembly phase. Each drop tank is ~18.2 m long. The overall vehicle length is ~118.2 m including the 8.9 m Orion MPCV. The LH₂ loading in the off-loaded NTPS, in-line and twin drop tanks is ~83.1, ~98.6, and ~159.4 t, respectively. The lengths of NTPS and in-line LH₂ tanks are ~19.7 and ~21.9 m. During the four primary mission burns ~321 t of LH₂ propellant is used. With 100.4 klb_f of total thrust and I_{sp} ~906 s, the total engine burn time for this mission is ~106.4 min, close to the ~2 hr demonstrated on the NRX-XE engine. After completing a long first perigee burn (~52 min), both drop tanks are jettisoned. The remaining burn durations are as follows: second perigee burn (~20.7 min), MOC (~22.2 min) and TEI (~11.5 min). Four HLV launches are required to deliver the major transportation systems elements (the NTPS, in-line tank and two drop tanks) to LEO. An upgraded SLS is used to deliver the crewed payload element and the large but lightweight star truss.

5.3 Copernicus-3a Option: Addition of Second Set of Drop Tanks to Achieve 100-day Transit Times

In transitioning from 120 to 100-day transit times the total mission ΔV increases by ~42 percent—from ~8.83 to ~12.5 km/s. To satisfy the high-energy requirements of this mission, *Copernicus-3a* (shown in Figs. 8 and 12) adds a second set of drop tanks to the star truss. Adjustments are made to the PL as well. The crew size is reduced to four and the mass of the TransHab and consumables needed for the

mission are reduced accordingly. Composite LH₂ tanks are also used instead of Al/Li. Lastly, the operating temperature of the engines' (UC-ZrC) graphite composite fuel is increased to achieve a specific impulse of ~940 s (see Table 1). The resulting vehicle has an IMLEO of ~720.7 t, which includes the NTPS (~137.6 t), the in-line tank (~123.7 t), the star truss with four common LH₂ drop tanks (~397.5 t) and the crew PL section (~61.9 t). The PL element includes the Orion MPCV (~15.1 t) which carries additional propellant (~5.1 t) for the final Earth slowdown burn ($\Delta V \sim 1.266$ km/s) before re-entry while the MTV flies past Earth and is disposed of in heliocentric space.

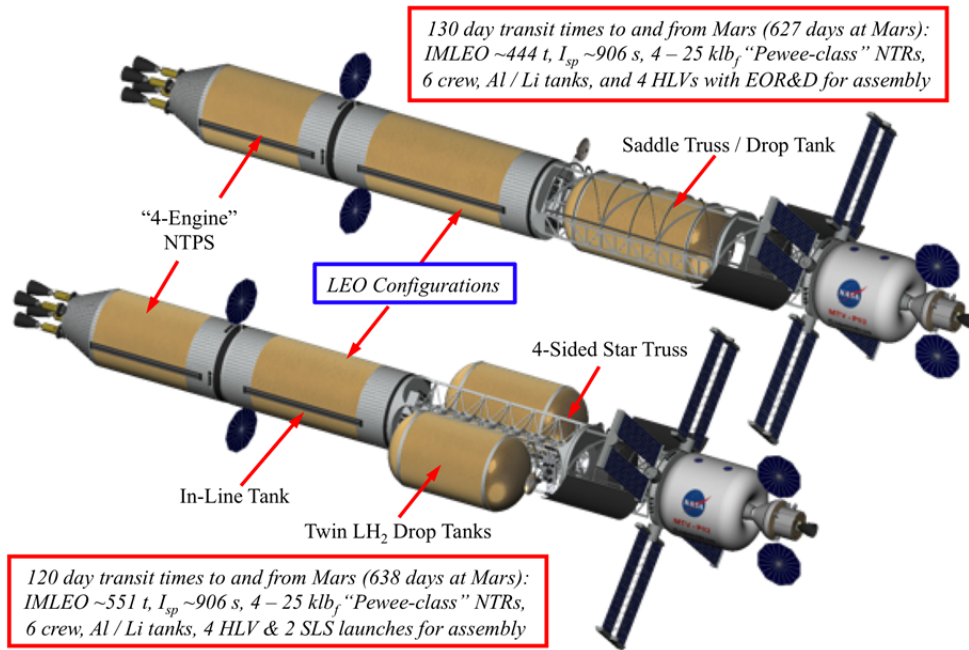

Figure 11.—Copernicus-3 Option: Supports 120-day transit times for the 2033 mission.

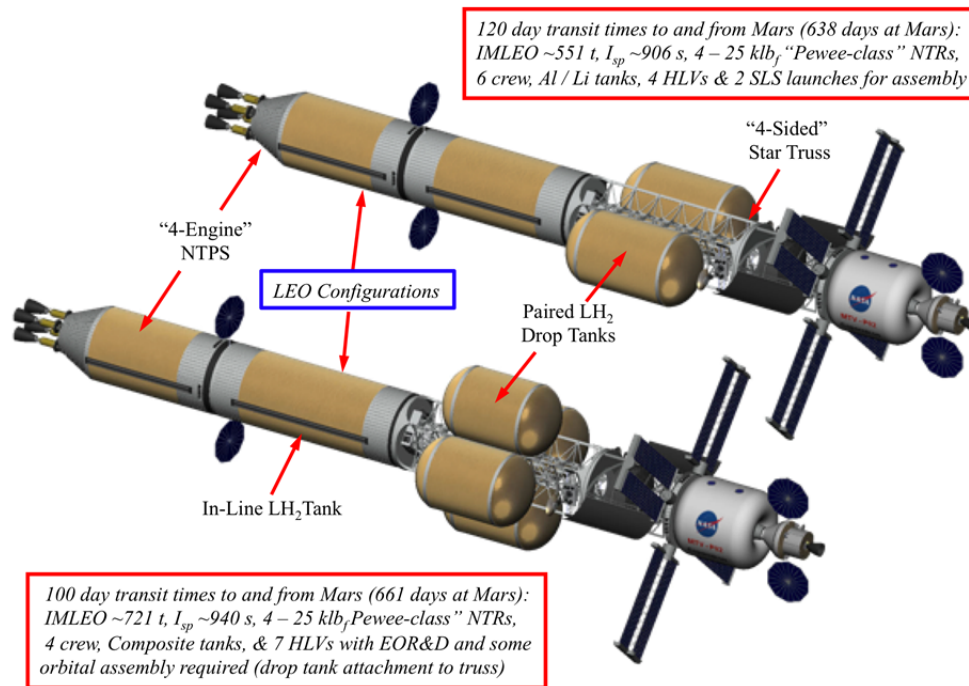

Figure 12.—Copernicus-3a Option: Supports 100-day transit times for the 2033 mission.

The LH₂ tank lengths in the NTPS and in-line element are ~19.7 and ~21.9 m, and they carry ~87.2 and ~95.5 t of propellant, respectively. *Copernicus-3a*'s four drop tanks carry ~327.8 t of propellant (~82 t per tank), and each tank is ~18.6 m long. The drop tanks are jettisoned in pairs after the first and second perigee burns to reduce vehicle mass and propellant consumption during the TMI maneuver. The overall vehicle length is ~117.6 m.

The total usable propellant for the mission is ~480.7 t. With 100.4 klb_f of thrust and I_{sp} ~940 s, the total engine burn time is ~165.4 min. This value exceeds the ~2 hr demonstrated on the NRX-XE engine by ~45 min. The first perigee burn is the longest single burn at ~78.3 min and also exceeds the single burn duration record of ~62 min set by the NRX-A6 engine. The duration of the remaining burns are as follows: second perigee burn (~37.3 min), MOC (~33.3 min), and TEI (~16.5 min). Seven HLV launches are required to deliver the major transportation systems elements (the NTPS, in-line tank, four drop tanks, and PL element) to LEO. A single SLS with sufficient PL volume will be used to launch the large but lightweight star truss.

5.4 Copernicus “Split Crewed Mission” Option for Achieving 100—90-day Transit Times

Copernicus-3a is a large complex vehicle that requires eight launches to deliver the various elements to LEO. From the initial launch of the NTPS until the last drop tank is attached to the star truss (via orbital assembly) could take ~7 months assuming 30 days between SLS/HLV launches. Failure to deliver the elements on time and in the prescribed order could delay vehicle assembly and jeopardize mission departure within the specified launch window.

Using the *Copernicus-2* spacecraft plus its three key components—the NTPS, in-line tank and integrated saddle truss/drop tank assembly—now configured as an Earth Return Vehicle (ERV), a “split crewed mission” architecture can be utilized that can reduce vehicle size and complexity, eliminate the need for orbital assembly and an extra engine, and can achieve transit times as low as 90 days. Use of a pre-deployed ERV is not a new idea. In NASA's DRM 1.0 study in 1993 (Ref. 22), the ERV was one of the key transportation system elements used in the mission architecture.

The split crewed architecture for very fast 1-way transit missions is outlined in Figure 13. Using the *Copernicus-2* spacecraft plus an ERV, a 2033 landing mission would require a round trip time of ~857 days with ~667 days spent in Mars orbit and on the surface. The outbound transit time on *Copernicus-2* is 100 days and the inbound transit time using the ERV is 90 days. In this split mission, the ERV is pre-deployed to Mars orbit in advance of the crew. It departs from LEO in December 2030 (departure C₃ ~10.794 km²/s², ΔV_{TMI} ~3.662 km/s), on a 283-day “minimum-energy” trajectory out to Mars. The ERV then arrives at Mars (arrival V_{inf} ~3.480 km/s) and propulsively captures into a 24-hr elliptical Mars orbit (~250 by 33,793 km, ΔV_{MOC} ~1.34 km/s) in October 2031 where it remains until the crewed *Copernicus-2* MTV arrives during the next opportunity ~26 months later.

Copernicus-2 departs LEO with its four crew on May 25, 2033 and arrives at Mars 100 days later. It then captures into the same parking orbit as the ERV on September 2, 2033. In the process, *Copernicus-2* uses up ~97 percent of its available propellant. To return to Earth, *Copernicus-2* rendezvous with the ERV and the forward crewed PL element is switched over to the ERV (shown in Fig. 13). No propellant transfer is required just a R&D maneuver. The reconfigured ERV then rendezvous with the orbiting Hab lander, followed by crew transfer, then EDL near the cargo lander at which point the surface exploration phase of the missions begins. After ~653 days on the surface, the crew lifts off using the MAV and returns to the ERV. Following the transfer of the crew and samples, the MAV is jettisoned. Before leaving Mars orbit, the crew finally jettisons the exterior consumables container and connecting tunnel from the PL element to reduce vehicle mass and propellant consumption. The ERV then performs the TEI burn on July 1, 2035 and begins the 90-day transfer back to Earth. On the final approach to Earth, the ERV does a final slowdown burn (ΔV ~2.257 km/s) after which the crew separates and re-enters using the Orion MPCV capsule. The ERV flies past Earth at a sufficiently high altitude and is disposed of into heliocentric space.

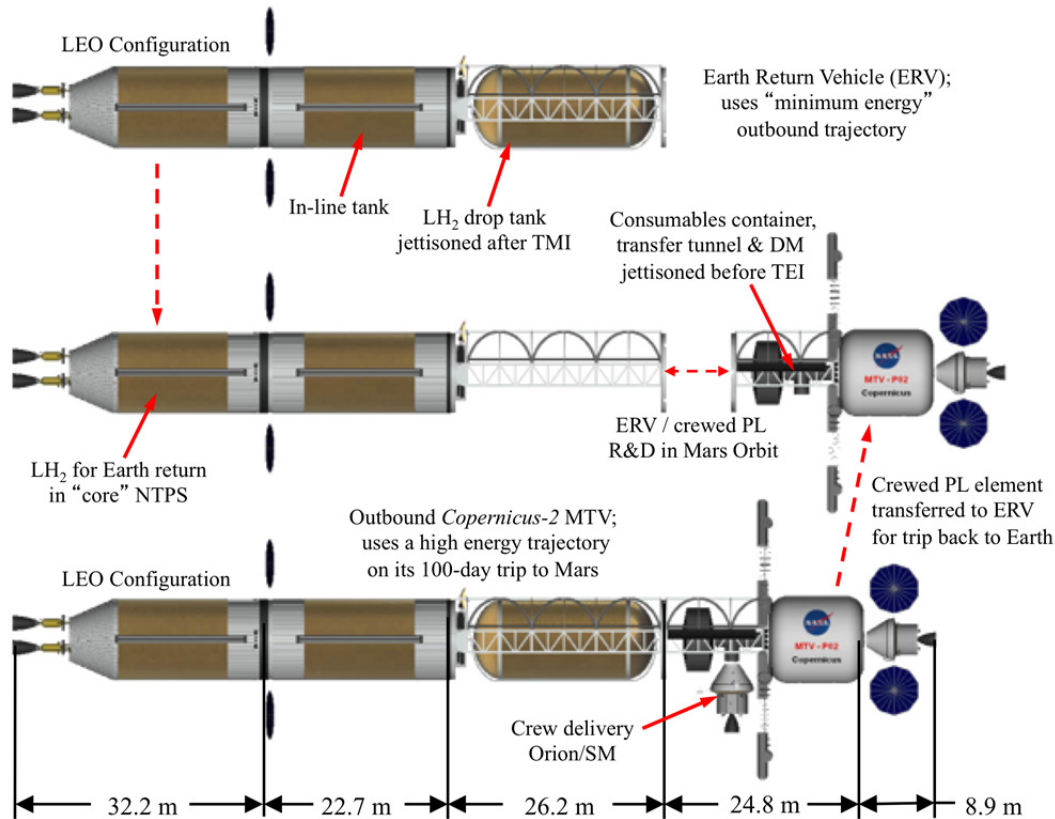

Figure 13.—Copernicus-2 MTV and components configured for a very fast split crewed mission.

For the outbound mission leg, the *Copernicus-2* spacecraft (Fig. 14) has an IMLEO of ~ 402 t consisting of the NTPS (~ 134.5 t), the in-line tank (~ 92.4 t), the integrated saddle truss/LH₂ drop tank assembly (~ 122.8 t), and the crewed PL element (~ 52.3 t). The NTPS, in-line and drop tank elements (again using composite tanks) carry ~ 87.2 , ~ 71.3 , and ~ 95 t respectively, for a total LH₂ propellant loading of ~ 253.5 t. By using two separate vehicles for the crewed mission, three engines are again sufficient for each. With ~ 75.3 klb_f of total thrust, an I_{sp} of 940 s, and ~ 239 t of usable propellant, the total engine burn time for this mission is ~ 109.6 min. The first TMI perigee burn is the longest at ~ 52.6 min. After this burn, the drop tank is drained and jettisoned to reduce vehicle mass and propellant consumption during the second perigee burn (~ 28.8 min). The NTPS supplies all the propellant needed for MOC (~ 28.2 min).

The “round trip” ERV has an IMLEO of ~ 360.3 t consisting of the NTPS (~ 131.3 t), the in-line tank (~ 101.4 t) and the integrated saddle truss/LH₂ drop tank assembly (~ 122.9 t). The composite tanks used in the ERV’s NTPS, in-line and drop tank elements carry ~ 87.2 , ~ 77 , and ~ 95 t respectively, for a total propellant loading of ~ 259.2 t. The ERV’s NTPS performs five primary burns (and four restarts) and its three engines provide ~ 75.3 klb_f of total thrust. With ~ 244.3 t of usable propellant and a I_{sp} of ~ 940 s, the total engine burn time for this mission is ~ 112.1 min. The first TMI perigee burn is the longest at ~ 41.3 min. After this burn, the drop tank is drained and jettisoned. The durations of the remaining burns are as follows: second perigee burn (~ 13.7 min), MOC (~ 13 min), TEI (~ 28.6 min), and final slowdown burn (~ 15.5 min). The long TEI burn is attributed to the addition of *Copernicus-2*’s ~ 40.2 t crewed PL mass plus the high TEI ΔV requirement (~ 3.075 km/s) for the 90-day transit back to Earth. The total and longest single engine burn times required for the ERV mission while substantial, are still below the capabilities demonstrated by the NRX-XE (~ 2 hr) and NRX-A6 engines (~ 62 min).

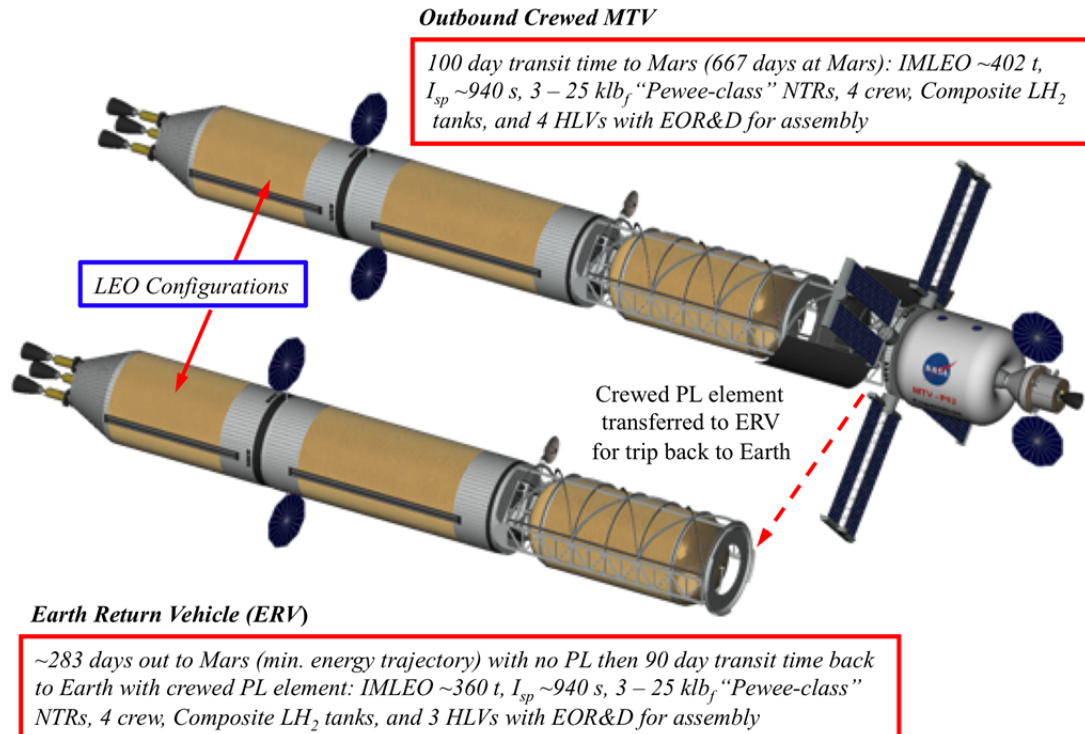

Figure 14.—“Split Crewed Mission” Option: Supports 100 to 90-day transit times.

Lastly, the total mission IMLEO for the two spacecraft is ~762.4 t. Seven HLV launches are required for the split mission option—four for the *Copernicus-2* and three for the ERV—compared to eight total launches required for the “all up” *Copernicus-3a* configuration. No on-orbit assembly (e.g., attachment of multiple drop tanks) is required just autonomous R&D of several vehicle components.

6.0 Summary and Conclusions

In NASA’s recent DRA 5.0 study (NASA/SP—2009-566), the fast conjunction long surface stay mission was identified as the preferred approach for exploring Mars. Plenty of time for scientific investigation and study, coupled with short ~6-month transit times to reduce crew exposure to the 0-g_E and radiation environments of space were key reasons for this selection. Similarly, NTP was identified as the preferred propulsion option because of its high performance (100 percent higher I_{sp} than LOX/LH₂ chemical propulsion), its demonstrated technology record, plus the strong synergy that exists between it and chemical propulsion systems and stages. Recent measurements of the energetic particle radiation environment inside MSL spacecraft during its journey out to Mars indicate that astronauts could receive a radiation dose of ~0.66 Sv (~66 rem)—the limiting value established by NASA—during a 1-year journey out to Mars and back. With the potential for the crew to receive additional dose during the exploration phase of the mission, several questions immediately arise: Can NTP’s performance capability be used to reduce transit times further and by how much? Also, what are the engine operating requirements and vehicle design impacts?

The answer to the first question is yes, and analysis presented here indicates transit time reductions as much as 50 percent are possible. The key requirements are more propellant and reduced U-235 loading in the engine’s reactor fuel elements to allow higher operating temperatures. For the 2033 mission opportunity baselined in this paper, *Copernicus* can achieve 1-way transit times of ~150 days when filled to its maximum propellant capacity of ~190 t. To shorten transit times further, the *Copernicus* spacecraft can be reconfigured in incremental steps that allow it to carry larger quantities of propellant needed for

these more demanding missions. To reduce the 1-way transit times from 150 to 130 days, an in-line tank is inserted between *Copernicus*' NTPS and saddle truss/drop tank assembly that increases the vehicle' propellant capacity by ~42 percent to ~270 t. A fourth engine is also added to the NTPS to reduce the total engine operating time and minimize g-losses.

To achieve transit times in the range of 120 to 100 days, *Copernicus*' saddle truss/drop tank assembly is replaced by a 4-sided star truss to which paired sets of LH₂ drop tanks are attached as needed. For 120-day transits to Mars and back, twin drop tanks—each carrying ~80 t of propellant—are used. Further reductions in transit times from 120 to 100 days requires an ~42 percent increase in total mission ΔV —from ~8.83 to ~12.5 km/s. To compensate, the crew size is reduced to four, composite propellant tanks are utilized and the engines are operated at their maximum temperature capability to achieve a specific impulse of ~940 s. Four drop tanks—each carrying ~82 t of propellant—are also used. The “all up” vehicles for 120- and 100-day cases require 5 and 7 HLVs respectively, as well as on-orbit assembly. The engine operational requirements for the 100-day case also exceed those demonstrated in the NERVA program.

A “split crewed mission architecture” is outlined that uses the *Copernicus-2* spacecraft configuration plus an ERV. It can reduce vehicle size and complexity, eliminate the need for orbital assembly and an extra engine, and can achieve transit times as low as 90 days. Finally, it is important to note that both the total and longest single engine burn times required for the split mission, while substantial, are still below the capabilities demonstrated by the NRX-XE (~2 hr) and NRX-A6 engines (~62 min).

References

1. “Human Exploration of Mars Design Reference Architecture 5.0,” Drake, Bret G., ed., National Aeronautics and Space Administration, NASA-SP-2009-566, Washington, DC, July 2009.
2. “Reference Mission Version 3.0 Addendum to the Human Exploration of Mars: The Reference Mission of the NASA Mars Exploration Study Team,” B.G. Drake, ed., Johnson Space Center, Exploration Office Document EX13-98-036, June 1998.
3. Borowski, Stanley K., Dudzinski, Leonard A., McGuire, Melissa L., “Vehicle and Mission Design Options for the Human Exploration of Mars/Phobos Using Bimodal NTR and LANTR Propulsion,” AIAA-98-3883, July 1998.
4. Borowski, Stanley K., Dudzinski, Leonard A., and McGuire, Melissa L., “Artificial Gravity Vehicle Design Option for NASA’s Human Mars Mission Using Bimodal NTR Propulsion,” AIAA-99-2545, June 1999.
5. Borowski, Stanley K., Dudzinski, Leonard A., and McGuire, Melissa L., “Bimodal” Nuclear Thermal Rocket (NTR) Propulsion for Power-Rich, Artificial Gravity Human Exploration Missions to Mars,” IAA-01-IAA.13.3.05, 52nd International Astronautical Congress, Toulouse, France, October 2001.
6. Zeitlin, C., et al., “Measurements of Energetic Particle Radiation in Transit to Mars on the Mars Science Laboratory,” *Science*, vol. 340, no. 6136, pg. 1080–1084, May 31, 2013.
7. “National Space Policy of the United States,” June 28, 2010, pg. 11.
8. Koeing, D.R., “Experience Gained from the Space Nuclear Rocket Programs (Rover/NERVA),” Los Alamos National Laboratory, Report LA-10062-H, Los Alamos, NM, May 1986.
9. Borowski, S.K., McCurdy, D.R., and Packard, T.W., “7-Launch NTR Space Transportation System for NASA’s Mars Design Reference Architecture (DRA) 5.0,” AIAA-2009-5308, August 2009.
10. Borowski, S.K., McCurdy, D.R., and Packard, T.W., “Modular Growth NTR Space Transportation System for Future NASA Human Lunar, NEA and Mars Exploration Missions,” AIAA-2012-5144, September 2012.
11. Schnitzler, B.G., Borowski, S.K., and Fittje, J.E., “25,000-lbf Thrust Engine Options Based on the Small Nuclear Rocket Engine Design,” AIAA-2009-5239, August 2009.

12. Durham, F.P., "Nuclear Engine Definition Study Preliminary Report, Volume 1 - Engine Description," Los Alamos National Laboratory, Report LA-5044-MS vol. 1, Los Alamos, NM, September 1972.
13. Schnitzler, B.G., Borowski, S.K., and Fittje, J.E., "Lower Thrust Engine Options Based on the Small Nuclear Rocket Engine Design," AIAA-2011-5846, August 2011.
14. Schnitzler, B.G., "Small Reactor Designs Suitable for Direct Nuclear Thermal Propulsion: Annual Report," Idaho National Laboratory, Report INL/EXT-13-28027, Idaho Falls, ID, January 2013.
15. Taub, J.M., "A Review of Fuel Element Development for Nuclear Rocket Engines," Los Alamos National Laboratory, Report LA-5931, Los Alamos, NM, June 1975.
16. Kruger, G.B., "710 High Temperature Gas Reactor Program Summary Report," GEMP-600, General Electric, Cincinnati, OH, September 1973.
17. Marchaterre, J.F., et al., "Nuclear Rocket Program Terminal Report," ANL-7236, Argonne National Laboratory, Argonne, IL, February 1968.
18. Houts, M.G., et al., "Nuclear Cryogenic Propulsion Stage," Nuclear and Emerging Technologies for Space (NETS)—2012 Conference, paper #3093, The Woodlands, TX, March 2012.
19. Borowski, S.K., McCurdy, D.R., and Packard, T.W., "Nuclear Thermal Rocket (NTR) Propulsion: A Proven Game-Changing Technology for Future Human Exploration Missions," GLEX-2012.09.4.6x12341, Global Space Exploration Conference, Washington, DC, May 2012.
20. Borowski, S.K., Dudzinski, L.A., and McGuire, M.L., "Vehicle and Mission Design Options for Exploration of Mars/Phobos Using Bimodal NTR and LANTR Propulsion," AIAA-98-3883, July 1998.
21. Bulman, M.J., Messitt, D.G., Neill, T.M., and Borowski, S.K., "Continued LOX-Augmented Nuclear Thermal Rocket (LANTR) Testing," AIAA-2002-3650, July 2002.
22. Borowski, S.K., Corban, R.R., McGuire, M.L., and Beke, E.G., "Nuclear Thermal Rocket/Vehicle Design Options for Future NASA Missions to the Moon and Mars," AIAA-93-4170, September 1993.

REPORT DOCUMENTATION PAGE			Form Approved OMB No. 0704-0188		
<p>The public reporting burden for this collection of information is estimated to average 1 hour per response, including the time for reviewing instructions, searching existing data sources, gathering and maintaining the data needed, and completing and reviewing the collection of information. Send comments regarding this burden estimate or any other aspect of this collection of information, including suggestions for reducing this burden, to Department of Defense, Washington Headquarters Services, Directorate for Information Operations and Reports (0704-0188), 1215 Jefferson Davis Highway, Suite 1204, Arlington, VA 22202-4302. Respondents should be aware that notwithstanding any other provision of law, no person shall be subject to any penalty for failing to comply with a collection of information if it does not display a currently valid OMB control number. PLEASE DO NOT RETURN YOUR FORM TO THE ABOVE ADDRESS.</p>					
1. REPORT DATE (DD-MM-YYYY) 01-10-2014		2. REPORT TYPE Technical Memorandum		3. DATES COVERED (From - To)	
4. TITLE AND SUBTITLE Nuclear Thermal Propulsion (NTP): A Proven, Growth Technology for "Fast Transit" Human Missions to Mars			5a. CONTRACT NUMBER		
			5b. GRANT NUMBER		
			5c. PROGRAM ELEMENT NUMBER		
6. AUTHOR(S) Borowski, Stanley, K.; McCurdy, David, R.; Packard, Thomas, W.			5d. PROJECT NUMBER		
			5e. TASK NUMBER		
			5f. WORK UNIT NUMBER WBS 279585.04.01.22		
7. PERFORMING ORGANIZATION NAME(S) AND ADDRESS(ES) National Aeronautics and Space Administration John H. Glenn Research Center at Lewis Field Cleveland, Ohio 44135-3191			8. PERFORMING ORGANIZATION REPORT NUMBER E-18821		
9. SPONSORING/MONITORING AGENCY NAME(S) AND ADDRESS(ES) National Aeronautics and Space Administration Washington, DC 20546-0001			10. SPONSORING/MONITOR'S ACRONYM(S) NASA		
			11. SPONSORING/MONITORING REPORT NUMBER NASA/TM-2014-218104		
12. DISTRIBUTION/AVAILABILITY STATEMENT Unclassified-Unlimited Subject Categories: 12, 20, and 91 Available electronically at http://www.sti.nasa.gov This publication is available from the NASA Center for AeroSpace Information, 443-757-5802					
13. SUPPLEMENTARY NOTES					
14. ABSTRACT <p>The "fast conjunction" long surface stay mission option was selected for NASA's recent Mars Design Reference Architecture (DRA) 5.0 study because it provided adequate time at Mars (~540 days) for the crew to explore the planet's geological diversity while also reducing the "1-way" transit times to and from Mars to ~6 months. Short transit times are desirable in order to reduce the debilitating physiological effects on the human body that can result from prolonged exposure to the zero-gravity (0-gE) and radiation environments of space. Recent measurements from the RAD detector attached to the Curiosity rover indicate that astronauts would receive a radiation dose of ~0.66 Sv (~66 rem)-the limiting value established by NASA-during their 1-year journey in deep space. Proven nuclear thermal rocket (NTR) technology, with its high thrust and high specific impulse (I_{sp} ~900 s), can cut 1-way transit times by as much as 50 percent by increasing the propellant capacity of the Mars transfer vehicle (MTV). No large technology scale-ups in engine size are required for these short transit missions either since the smallest engine tested during the Rover program-the 25 klb_f "Pewee" engine is sufficient when used in a clustered arrangement of three to four engines. The "Copernicus" crewed MTV developed for DRA 5.0 is a 0-gE design consisting of three basic components: (1) the NTP stage (NTPS); (2) the crewed payload element; and (3) an integrated "saddle truss" and LH₂ propellant drop tank assembly that connects the two elements. With a propellant capacity of ~190 t, Copernicus can support 1-way transit times ranging from ~150 to 220 days over the 15-year synodic cycle. The paper examines the impact on vehicle design of decreasing transit times for the 2033 mission opportunity. With a fourth "upgraded" SLS/HLV launch, an "in-line" LH₂ tank element can be added to Copernicus allowing 1-way transit times of 130 days. To achieve 100 to 120 day transit times, Copernicus' saddle truss/drop tank assembly is replaced by a "star truss" assembly with paired modular drop tanks to further increase the vehicle's propellant capacity. The HLV launch count increases (from ~5 to 7) and a fourth engine is needed to reduce total mission burn time and gravity losses. Using a "split mission" approach, the NTPS, in-line tank and the saddle truss/LH₂ drop tank elements can be configured as a pre-deployed Earth Return Vehicle/propellant tanker supporting 90-day crewed mission transits. The split mission approach also eliminates the need for on-orbit assembly. Mission scenario descriptions, key features and operational characteristics for five different vehicle configurations are presented.</p>					
15. SUBJECT TERMS Nuclear thermal rocket (NTR); Mars transfer vehicle (MTV); Design reference architecture (DRA); Composite fuel					
16. SECURITY CLASSIFICATION OF:			17. LIMITATION OF ABSTRACT	18. NUMBER OF PAGES	19a. NAME OF RESPONSIBLE PERSON
a. REPORT	b. ABSTRACT	c. THIS PAGE			STI Help Desk (email:help@sti.nasa.gov)
U	U	U	UU	30	19b. TELEPHONE NUMBER (include area code) 443-757-5802

