

NASA/TP-2015-218684



# Small Unmanned Aircraft Systems Integration into the National Airspace System Visual-Line-of-Sight Human-in-the-Loop Experiment

*Anna C. Trujillo and Rania W. Ghatas  
Langley Research Center, Hampton, Virginia*

*Raymon McAdaragh  
Stinger Ghaffarian Technologies, Hampton, Virginia*

*Daniel W. Burdette  
Northrop Grumman, Hampton, Virginia*

*James R. Comstock  
Langley Research Center, Hampton, Virginia*

*Lucas E. Hempley  
Northrop Grumman, Hampton, Virginia*

*Hui Fan  
Analytical Mechanics Associates, Inc., Hampton, Virginia*

## NASA STI Program . . . in Profile

Since its founding, NASA has been dedicated to the advancement of aeronautics and space science. The NASA scientific and technical information (STI) program plays a key part in helping NASA maintain this important role.

The NASA STI program operates under the auspices of the Agency Chief Information Officer. It collects, organizes, provides for archiving, and disseminates NASA's STI. The NASA STI program provides access to the NTRS Registered and its public interface, the NASA Technical Reports Server, thus providing one of the largest collections of aeronautical and space science STI in the world. Results are published in both non-NASA channels and by NASA in the NASA STI Report Series, which includes the following report types:

- **TECHNICAL PUBLICATION.** Reports of completed research or a major significant phase of research that present the results of NASA Programs and include extensive data or theoretical analysis. Includes compilations of significant scientific and technical data and information deemed to be of continuing reference value. NASA counter-part of peer-reviewed formal professional papers but has less stringent limitations on manuscript length and extent of graphic presentations.
- **TECHNICAL MEMORANDUM.** Scientific and technical findings that are preliminary or of specialized interest, e.g., quick release reports, working papers, and bibliographies that contain minimal annotation. Does not contain extensive analysis.
- **CONTRACTOR REPORT.** Scientific and technical findings by NASA-sponsored contractors and grantees.

- **CONFERENCE PUBLICATION.** Collected papers from scientific and technical conferences, symposia, seminars, or other meetings sponsored or co-sponsored by NASA.
- **SPECIAL PUBLICATION.** Scientific, technical, or historical information from NASA programs, projects, and missions, often concerned with subjects having substantial public interest.
- **TECHNICAL TRANSLATION.** English-language translations of foreign scientific and technical material pertinent to NASA's mission.

Specialized services also include organizing and publishing research results, distributing specialized research announcements and feeds, providing information desk and personal search support, and enabling data exchange services.

For more information about the NASA STI program, see the following:

- Access the NASA STI program home page at <http://www.sti.nasa.gov>
- E-mail your question to [help@sti.nasa.gov](mailto:help@sti.nasa.gov)
- Phone the NASA STI Information Desk at 757-864-9658
- Write to:  
NASA STI Information Desk  
Mail Stop 148  
NASA Langley Research Center  
Hampton, VA 23681-2199

NASA/TP–2015-218684



# Small Unmanned Aircraft Systems Integration into the National Airspace System Visual-Line-of-Sight Human-in-the-Loop Experiment

*Anna C. Trujillo and Rania W. Ghatas  
Langley Research Center, Hampton, Virginia*

*Raymon McAdaragh  
Stinger Ghaffarian Technologies, Hampton, Virginia*

*Daniel W. Burdette  
Northrop Grumman, Hampton, Virginia*

*James R. Comstock  
Langley Research Center, Hampton, Virginia*

*Lucas E. Hempley  
Northrop Grumman, Hampton, Virginia*

*Hui Fan  
Analytical Mechanics Associates, Inc., Hampton, Virginia*

National Aeronautics and  
Space Administration

Langley Research Center  
Hampton, Virginia 23681-2199

February 2015

## Acknowledgments

The authors would like to thank Unisys and the Simulation Development and Analysis Branch for their help in programming and running the experiment in the TES. The authors would also like to thank various Langley researchers who are also RC pilots for their help in tuning the sUA simulation dynamics and finalizing the scenarios.

The use of trademarks or names of manufacturers in this report is for accurate reporting and does not constitute an official endorsement, either expressed or implied, of such products or manufacturers by the National Aeronautics and Space Administration.

Available from:

NASA STI Program / Mail Stop 148  
NASA Langley Research Center  
Hampton, VA 23681-2199  
Fax: 757-864-6500

# Table of Contents

List of Figures .....	iii
List of Tables.....	iv
Nomenclature.....	v
Abstract.....	1
1 Introduction .....	1
1.1 Background .....	2
1.2 Organization of Report .....	2
1.3 Purpose .....	3
1.4 Scope and Objectives .....	3
1.4.1 UAS in the NAS Human System Integration Objectives .....	3
1.4.2 Experiment Objectives .....	3
2 Method .....	4
2.1 Subjects.....	4
2.2 Apparatus .....	4
2.2.1 Simulator.....	4
2.2.2 Ground Control Station .....	5
2.3 Scenarios .....	6
2.3.1 Scenarios 1-3: Surry Nuclear Power Plant Radiation Emission and Power Line Inspection .....	6
2.3.2 Scenarios 4-6: Blackstone Army Airfield (BKT) Search and Rescue Mission.....	7
2.4 Air Traffic Control and Mission Control Positions .....	11
2.4.1 Air Traffic Control Position .....	11
2.4.2 Mission Control Position .....	13
2.5 Subject Communication with ATC and MC .....	14
2.5.1 Pilot Requests for Takeoff and Landing.....	14
2.5.2 Notification of Traffic in Sight .....	14
2.6 Experiment Design .....	14
2.6.1 Independent Variables .....	14
2.6.2 Organization of Independent Variables .....	15
2.6.3 Dependent Variables .....	16
2.7 Procedure.....	18
2.7.1 Briefing and Training Session.....	18
2.7.2 Data Collection .....	21
2.7.3 Debriefing Session.....	21
2.8 Hypotheses .....	22

3 Results .....	22
3.1 Mission .....	22
3.1.1 Lateral Errors at Waypoints .....	22
3.1.2 Altitude Errors .....	23
3.1.3 Subjective Mission Ratings .....	26
3.1.4 Collisions .....	27
3.1.5 Mission Tracks .....	31
3.2 Maintaining VLOS .....	31
3.2.1 Lateral Distance .....	34
3.2.2 Altitude .....	35
3.3 Interaction with ATC and Manned Aircraft .....	36
3.3.1 Interaction with Manned Aircraft .....	36
3.3.2 Interaction with ATC and MC .....	37
4 Discussion .....	38
4.1 Hypothesis 1: sUAS Simulator Realism .....	38
4.2 Hypothesis 2: Obstacle Avoidance .....	38
4.3 Hypothesis 3: Manned-Aircraft Avoidance .....	38
4.4 Hypothesis 4: Human System Integration Deficiencies .....	39
4.5 Hypothesis 5: PFD Need .....	39
4.6 Hypothesis 6: Map Display Configuration Preference .....	39
5 Conclusion .....	39
6 Recommendations .....	39
References .....	41
Appendix A: Subject Background Questionnaire .....	43
Appendix B: Surry Nuclear Power Plant Data Run Paper Maps .....	45
Appendix C: Fort Pickett Data Run Paper Maps .....	51
Appendix D: Air Traffic Control Alerts about Other Aircraft .....	57
Appendix E: Surry Nuclear Power Plant Scripts for Air Traffic Control and Mission Control .....	60
Appendix F: Fort Pickett Scripts for Air Traffic Control and Mission Control .....	72
Appendix G: Subject Run Orders .....	87
Appendix H: Ground Control Station Display Questionnaire .....	93
Appendix I: Final/Exit Questionnaire .....	96
Appendix J: Experimenter’s Instructions Sheet .....	99
Appendix K: Informed Consent Form .....	102
Appendix L: Privacy Act Notice .....	106
Appendix M: Mission Tracks .....	107

## List of Figures

Figure 1 – TES Surry Nuclear Plant Scene Rendering .....	5
Figure 2 – Scenario 1 Map of Waypoints .....	8
Figure 3 – Scenario 1 Map of Other Aircraft Paths .....	9
Figure 4 – Scenario 4 Map of Waypoints .....	10
Figure 5 – Scenario 4 Map of Other Aircraft Paths .....	11
Figure 6 – ATC Alerts Pop-Ups and Test and Evaluation Simulator .....	12
Figure 7 – PFD.....	15
Figure 8 – Moving Map .....	16
Figure 9 – Experiment Design Example .....	17
Figure 10 – Electronic Version of the Modified CH Rating.....	19
Figure 11 – Electronic Version of the NASA-TLX .....	20
Figure 12 – Display Layout and GCS Realism by Display Configuration .....	23
Figure 13 – Percentage of Waypoints in Loiter Area Box by Display Configuration .....	24
Figure 14 – Altitude Error by Display Configuration .....	24
Figure 15 – Altitude Error by Waypoint .....	25
Figure 16 – Overall Altitude Error by Run .....	25
Figure 17 – Overall Altitude Error by Subject License Type and Display Configuration .....	26
Figure 18 – Ability to Maintain Altitude and Heading by Run .....	27
Figure 19 – CH Rating by Run Boxplot.....	28
Figure 20 – NASA-TLX Rating by Run .....	29
Figure 21 – Display Ranking by Display Configuration Boxplot.....	29
Figure 22 – Number of Collisions by Scenario.....	30
Figure 23 – Number of Collisions by Scenario and Display Configuration .....	30
Figure 24 – Loiter Area by Subject .....	31
Figure 25 – Altitude Error by Subject .....	32
Figure 26 – Loiter Area by Subject License Type and Display Configuration .....	32
Figure 27 – Subject A Mission Track for Scenario 1, Run 3, Map Display Configuration .....	33
Figure 28 – Subject B Mission Track for Scenario 1, Run 13, Map Display Configuration .....	33
Figure 29 – Maximum Lateral Distance from Eye Point Average by Run .....	34
Figure 30 – Lateral Distance and Points BVR from Eye Point by Display Configuration .....	35
Figure 31 – Maximum Altitude and Points Above 400 ft Averaged by Display Configuration.....	36
Figure 32 – Number of Aircraft Missed and Average Time to Spot Aircraft by Display Configuration .....	37

## List of Tables

Table 1 – Eye Point, sUAS Starting Position, and Other Traffic for Scenario 1 .....	7
Table 2 – Eye Point, sUAS Starting Position, and Other Traffic for Scenario 4 .....	9
Table 3 – Loiter Area by Display Condition.....	23
Table 4 – Ability to Maintain Altitude at Waypoints by Subject License Type.....	26
Table 5 – Ability to Maintain Altitude and Heading by Display Condition.....	27
Table 6 – Performance by Display Condition.....	28
Table 7 – Subject Reported Percentage of Time VLOS is Lost by Display .....	34
Table 8 – Subjects’ Perceived Ability to Avoid Manned Aircraft by Display .....	37



## Nomenclature

AAF	Army Airfield
ADS-B	Automatic Dependent Surveillance – Broadcast
AGL	Ft Above Ground Level
AMA	Analytical Mechanics Associates
ANOVA	Analysis Of Variance
ARC	Aviation Rulemaking Committee
ASTM	American Society for Testing and Materials
ATC	Air Traffic Control
ATP	Airline Transport Pilot
BKT	Blackstone Army Airfield
BVR	Beyond-Visual-Range
CH	Cooper-Harper
COA	Certificate of Authorization
CONOPS	Concept of Operations
FAA	Federal Aviation Administration
FAF	Felker Army Airfield
FOV	Field Of View
ft	feet
GCS	Ground Control Station
GPS	Global Positioning System
hr(s)	hour(s)
HSI	Human Systems Integration
kts	knots
MASPS	Minimum Aviation Safety Performance Standards
MC	Mission Control
min	minute
NAS	National Airspace System
NASA	National Aeronautics and Space Administration
NRC	Nuclear Regulatory Commission
PFD	Primary Flight Display
RMS	Root Mean Square
SAR	Search And Rescue
SC	Sub-Committee
SE	Standard Error Of The Mean
sec	second(s)
sUA	Small Unmanned Aircraft
sUAS	Small Unmanned Aircraft Systems
TES	Test and Evaluation Simulator
TIS-B	Traffic Information Service – Broadcast
TLX	Task Load Index
UAS	Unmanned Aircraft Systems
VFR	Visual Flight Rules
VLOS	Visual Line-of-Sight
yds	yards
yr(s)	year(s)

## Abstract

*As part of the Unmanned Aircraft Systems (UAS) in the National Airspace System (NAS) project, research on integrating small UAS (sUAS) into the NAS was underway by a human-systems integration (HSI) team at the NASA Langley Research Center. Minimal to no research has been conducted on the safe, effective, and efficient manner in which to integrate these aircraft into the NAS. sUAS are defined as aircraft weighing 55 pounds or less. The objective of this human system integration team was to build a UAS Ground Control Station (GCS) and to develop a research test-bed and database that provides data, proof of concept, and human factors guidelines for GCS operations in the NAS.*

*The objectives of this experiment were to evaluate the effectiveness and safety of flying sUAS in Class D and Class G airspace utilizing manual control inputs and voice radio communications between the pilot, mission control, and air traffic control. The design of the experiment included three sets of GCS display configurations, in addition to a hand-held control unit. The three different display configurations were VLOS, VLOS + Primary Flight Display (PFD), and VLOS + PFD + Moving Map (Map).*

*Test subject pilots had better situation awareness of their vehicle position, altitude, airspeed, location over the ground, and mission track using the Map display configuration. This configuration allowed the pilots to complete the mission objectives with less workload, at the expense of having better situation awareness of other aircraft. The subjects were better able to see other aircraft when using the VLOS display configuration. However, their mission performance, as well as their ability to aviate and navigate, was reduced compared to runs that included the PFD and Map displays.*

## 1 Introduction

Due to the President's signing of the Federal Aviation Administration (FAA) Modernization and Reform Act of 2012, Unmanned Aircraft Systems (UAS) are supposed to have published rules for full integration into the National Airspace System (NAS) by September 30, 2015, with small UAS (sUAS), those UAS under 55 pounds (lbs), having published rules by mid-2014 (112th Congress, 2012). Some sUAS operations will be allowed in the Arctic regions of the United States 24-hours a day at an altitude of 2,000 feet (ft) within one year of the date of the law's enactment. To date, in the United States, commercial sUAS operations have not been authorized, primarily because there are no official regulations and procedures to support them; whereas, in several other countries, this is not the case (McAdaragh, Comstock, Ghatas, Burdette, & Trujillo, 2014). The FAA currently generally allows the operation of sUAS in the NAS through the issuance of a Statement of Airworthiness and a Certificate of Authorization (COA) for public agencies, and through the issuance of an Experimental Airworthiness Certificate and a COA for civil operations to conduct research and development, crew training, and market surveys.

## 1.1 Background

The use of sUAS has become widespread throughout military operations over the past couple of decades because of their unique capabilities to accomplish tasks that humans on the ground and manned aircraft cannot achieve with as great an amount of effectiveness and efficiency. This has been noticed by commercial industry (*e.g.*, delivery firms, film and photography businesses), as well as many other potential public and commercial sUAS user organizations, and several civil applications have been envisioned and designed. Some of these applications are designed to be conducted within Visual Line-of-Sight (VLOS), because their missions are local to the placement of the ground control station (GCS) and pilot, while others are designed to be conducted Beyond-Visual-Range (BVR) to more efficiently accomplish many missions currently flown by manned aircraft, or missions that are simply unable to be conducted by manned aircraft.

Outside of the United States, many countries are already allowing the commercial use of UAS. For instance, in Australia, the Civil Aviation Safety Authority evaluates and approves commercial UAS use on a case-by-case basis, and has recently proposed new rules to allow operators of sUAS weighing 2 kilograms or less to apply and gain approval to legally fly commercially by simply filling out an online application (Corcoran, 2013). In Canada, permits to fly UAS for commercial photography are also granted on a case-by-case basis (PRI's The World, 2013). In Mexico, there are no civil aviation authority regulations restricting commercial UAS use (Garcia, 2013). This is also the case in many other South American countries.

In the United States, the FAA has commissioned the RTCA to develop operational and safety requirements, and Minimum Aviation Safety Performance Standards (MASPS) for UAS, but these standards will not address VLOS operations (RTCA, 2010). The Sub-Committee (SC)-203 (UAS committee) has concluded its work, publishing DO-344 concerning operational and safety requirements (RTCA, 2013); a new committee, SC-228, has begun work developing a MASPS document focusing on Detect, Sense and Avoid, and Communications. The American Society for Testing and Materials (ASTM) F-38 committee was also commissioned by the FAA to develop certification requirements for sUAS, but they are not addressing procedural or operational requirements for VLOS operations (Jewell, 2010). In 2012, the FAA published a Concept of Operations (CONOPS) document to address the NAS integration requirements for UAS, but this document also specifically excludes sUAS VLOS operations (Federal Aviation Administration, 2012).

The research presented below begins to address some of the gaps regarding sUAS VLOS operations in the NAS. In particular, this experiment looked at some of the GCS information requirements for VLOS operations using a manual controller to command the sUAS in both controlled and uncontrolled airspace.

## 1.2 Organization of Report

The organization of this report is as follows. The rest of this introduction section (§1) includes the Purpose, and Scope and Objectives of this experiment. Section 2 describes the experimental method including the simulation setup (§2.42-§2.35), experiment design (§2.6), procedure (§2.7), and hypotheses (§2.8). The results section, section 3, presents the subjects' ability to complete the mission (§3.1), to maintain VLOS (§3.2), and to interact with ATC (§3.3). Finally, this report closes with a discussion of the results (§4), conclusions (§5), and recommendations for further research (§6).

### 1.3 Purpose

The FAA has commissioned an Aviation Rulemaking Committee (ARC) to address sUAS VLOS operations, but to date this committee has not issued any proposed rules. This may be partly because there is little research related to these type of operations upon which to base any rules or requirements. However, the FAA has published a UAS CONOPS document, which does apply to UAS as-well-as sUAS BVR operations (Federal Aviation Administration, 2012).

Two rule-making committees addressing UAS (RTCA SC-203 and SC-228) are primarily focusing on operational requirements for larger UAS and sUAS that fly BVR. Meanwhile, a third committee (ASTM F-38) focusing on sUAS is only addressing the certification requirements of sUAS. There are currently no rules addressing integration of sUAS VLOS operations in to the NAS. In order to develop these rules, the FAA has expressed a desire for data regarding the ability of UAS to integrate into the NAS and this includes commercial and ubiquitous public-use sUAS that will fly in airspace other than Class G, which is probable for foreseen missions (e.g., police operations, real-estate filming) in large cities. The purpose of this study is to provide data that will help support the development of rules and regulations that will enable the integration of sUAS VLOS operations in the NAS.

### 1.4 Scope and Objectives

This research addresses future sUAS VLOS operations in Class D and G airspace, using two example scenarios, one a search and rescue (SAR) mission and another a nuclear power plant inspection mission. The research evaluated the effectiveness and safety of the missions, and the communications that take place between the pilot, Air Traffic Control (ATC), and the mission control (MC) specialist. It also addresses pilot situation awareness and workload levels under three different display configurations.

#### 1.4.1 UAS in the NAS Human System Integration Objectives

The objective of the UAS in the NAS Human Systems Integration (HSI) is to provide UAS GCS requirements to the FAA; however, the following address the specific research objectives (NASA, n.d.):

- *Develop a research testbed and database to provide data and proof of concept for GCS operations in the NAS.*
- *Coordinate with standards organizations [e.g., FAA, RTCA, and ASTM] to develop human factors guidelines for GCS operation in the NAS.*

#### 1.4.2 Experiment Objectives

The intention of this human-in-the-loop experiment was to evaluate the human system integration of a sUAS GCS and its pilot to determine its effectiveness to safely accomplish aviation and mission objectives through the use of manual vehicle control inputs, VLOS see-and-avoid procedures, and radio communications, while conducting a mission scenario within uncontrolled and controlled airspace operations.

In general, the experiment objectives address the validity of the sUAS simulator and the NAS operational capability of a sUAS. The specific objectives of this experiment are as follows:

1. Determine the validity of the sUAS simulator hardware and simulation software (the research testbed for the sUAS GCS)
2. Determine the sUAS ability to safely avoid obstacles under VLOS operations
3. Determine the effectiveness of the GCS in meeting normal NAS operational requirements for pilot/ATC communications

4. Identify any potential human system integration deficiencies that could hinder the safe, effective, and efficient integration of sUAS VLOS mission within uncontrolled and controlled airspace

## 2 Method

This experiment utilized a simulator to depict the operational environment in which VLOS sUAS operations would be conducted and to run the sUAS simulation model. The subjects flew various scenarios using a GCS to control the sUAS. Each scenario included seven waypoints the sUAS had to fly to and loiter over for one minute, and the MC directed the subject pilots to fly the sUAS to each of these waypoints. Occasionally, other aircraft traffic would fly in the vicinity of their small unmanned aircraft (sUA). Most of the time ATC notified the subjects of the traffic. However, some of the traffic was not announced by ATC so that a subject's situation awareness of his environment could be ascertained. Subjects had two-way communications with both the MC and ATC. The following sections detail this experimental method and setup.

### 2.1 Subjects

A total of nine male subjects participated in the simulation study on a voluntary basis. Subjects were recruited through the NASA recruiting service provided by Analytical Mechanics Associates (AMA) and were required to have experience as a remote control pilot and also to have experience communicating with ATC. Of the nine subjects, seven held pilots licenses – one was a Private Pilot, one was a Commercial Pilot, and five were Airline Transport Pilots (ATP). Those seven subjects had an average of  $10,700 \pm 10,000$  (average  $\pm$  one standard deviation) manned flight hours (hrs) (a range of 500 hrs to 25,000 hrs with a median of 4,000 hrs) and  $23 \pm 11$  years (yrs) of manned flight (a range of 5 yrs to 35 yrs with a median of 24 yrs). The subjects' experience with remote control flying included an average of 1,900 remote control hrs (a range of 100 hrs to 5000 hrs with a median of 950 hrs) and  $28 \pm 14$  yrs of remote control piloting (a range of 8 yrs to 45 yrs with median of 34 yrs). A background questionnaire (Appendix A) was given to the subject at the end of the data collection process, during the debriefing session, which elicited the above information.

### 2.2 Apparatus

#### 2.2.1 Simulator

The Test and Evaluation Simulator (TES) was selected for use in this study because it featured an approximately 180 degree horizontal VLOS depiction of the operational environment in which the scenario missions took place. The subject operated the vehicle from a centralized location so that the entire mission area was in view from the GCS at all times.

**2.2.1.1 VLOS Display.** The TES field of view (FOV) from the subject's eye point was  $184^\circ$  horizontal at the top of the screen and  $200^\circ$  horizontal at the bottom of the screen, and  $50^\circ$  up and  $60^\circ$  down for a total of  $110^\circ$  vertical FOV. The spherical screen had a radius of 128 inches, non-collimated. Six (3x2) 1400x1050 pixel DLP projectors projected the scene at 1.93 arcmin/pixel horizontal and 1.79 arcmin/pixel vertical. An example of the scene rendering in the TES is below (Figure 1 on page 5).

**2.2.1.2 sUA FASER Simulation Model and Hand-Held Control Unit.** The simulated sUA used in this experiment was a MATLAB model based on an Ultra Stick 120 that was developed by the University of Minnesota (Murch, 2012) and is referred to as the FASER – Free-flying Aircraft for Subscale Experimental Research (Owens, Cox, & Morelli, 2006). The Ultra Stick 120 is a fixed-wing sUA that weighs 11 pounds, and has a wingspan of 76 inches and a fuselage length of 65 inches. The University of Minnesota MATLAB model, subsequently referred to here as FASER,



Figure 1 – TES Surry Nuclear Plant Scene Rendering

was modified in several ways to make it suitable for use in this experiment. An auto throttle was added to set the aircraft speed at 25 knots. This also required some modifications to the FASER to allow the plane model to be stable at these reduced speeds. A USB RC flight controller was integrated into the model to provide the flight control. The inputs from the RC flight controller were used to drive the control surface position in the FASER. This USB RC controller had the same look and feel as a modern RC controller, and is typically used by RC pilots to simulate flying to practice and develop skills without risking actual aircraft models. This control input directly controls the surface deflections of the FASER.

### 2.2.2 Ground Control Station

This section will describe the technical elements of the ground control station used during the simulation. These elements include the hand-held control unit (described above in §2.2.1.2), the desktop computer showing the display screens, and the radio communications.

**2.2.2.1 Display Screens.** The same computer running the flight model in MATLAB also provided the displays for the GCS. This includes the primary flight display (PFD), moving map, and questionnaires display which appeared on a single 19-inch standard definition touch panel monitor located on a table next to the subject pilot. The computer was a PC running Windows 7. All software was written in a combination of C, C++, and C#. During flight, the screen was configured with the moving map on top and the PFD on bottom. If a flight did not have one or both displays available, the subject saw a solid black display as appropriate. The touch panel interface was not used during flight. At the end of the flight, the displays were replaced with the questionnaires display. The format of the questionnaires changed depending on the question or rating scale being presented. Questions were answered by tapping on the screen at the appropriate location. For a complete description of the questionnaires display see §2.6.3.

**2.2.2.2 Radio Communications.** Two-way radio communications for subject pilots in the TES Lab were simulated, using a Clear-Com Model MS-704 Intercom Systems four-channel base station controller directly hard-wired to three individual headsets with boom microphones deployed at the user stations. Functionally, those user stations were operated by ATC, MC, and the test subject pilot. All two-way aircraft radio communications were simulated using a single intercom channel. Subjects were briefed on this particular operational constraint prior to entering the TES Lab. Each user station was properly configured prior to the execution of practice and/or data runs by calibrating a small control box designed to allow selection of the appropriate intercom channel and control of the audio signal volume sent to each headset. During familiarization and practice runs, the subjects were allowed to speak to either ATC or MC, while conducting sound checks. Using this type of open-microphone intercom system presented no difficulties for any of the nine test subjects. Predetermined phraseology used by all parties helped to create an operational “radio” environment similar to a standard two-channel aircraft radio communications system. Using this audio protocol during actual flight simulations, subject pilots consistently appeared to maintain, without difficulties, normal “two-channel” radio operations as required by the experiment scenarios. In addition, research team members providing ATC and MC services found it quite easy to avoid possible radio “interference,” which might have resulted from inadvertent simultaneous transmissions of clearances or other mission messages.

## 2.3 Scenarios

The practice and experimental simulation data runs were derived from the following scenarios. For each scenario, the sUAS was equipped with a Global Positioning System (GPS) receiver and transmitter and this allowed the vehicle’s position to be presented on the subject’s moving map display in the experimental runs that included the this display. During each scenario, subject pilots would pilot their sUA just visually, with a primary flight display available, or with a primary flight display and moving map display available (§2.6.1).

Each scenario also included manned air traffic that may or may not have been called out by ATC. The traffic was typically at low altitudes – 150 ft to 650 ft – in order to possibly elicit responses from subjects regarding manned air traffic in the vicinity at altitudes that could possibly affect them. ATC always requested that the subject “*advise/report traffic in sight*” for the ATC announced traffic. Subjects were not briefed on how to handle unannounced traffic in order to determine how sUA pilots may react to unexpected manned air traffic. See section 2.4.1.2 on page 12 for further details.

### 2.3.1 Scenarios 1-3: Surry Nuclear Power Plant Radiation Emission and Power Line Inspection

These three scenarios described the application of a sUAS to support the Nuclear Regulatory Commission (NRC). The sUAS included a small, less than 55 lbs, electrically powered fixed-wing FASER aircraft and a portable GCS, which consisted of a handheld controller and a laptop display. The sUAS pilot (an NRC inspector) was trained in sUAS launch, recovery, and mission operations, including ATC communications and operating procedures. In this scenario, the NRC inspector used an aircraft equipped with a radiation detection sensor and a surface observing video camera to collect data on radiation emission and power-line health within a 400-yard VLOS circumference of the Surry Nuclear Power Plant, while operating at or below 400 ft above ground level (AGL). Scenario maps with waypoints can be found in Appendix B.

Since the operation was flown in both Felker Army Airfield (FAF) Class D airspace and Class G airspace, it was necessary that the subject pilot stay in contact with FAF Tower for

coordination of the operation and for flight advisories concerning other aircraft around the Surry Nuclear Power Plant operation area. The subject flew the sUA manually within the operations area under continuous VLOS operations; the subject was briefed to fly at an altitude of 250 ft AGL. Since the operation was flown within VLOS, no flight plan was filed.

Table 1 below, and Figure 2 on page 8 and Figure 3 on page 9 are indicative of how each of the three Surry Nuclear Power Plant scenarios were programmed for the simulation data runs. See Appendix B for the details on each of the Surry scenarios.

### 2.3.2 Scenarios 4-6: Blackstone Army Airfield (BKT) Search and Rescue Mission

These scenarios describe the application of a sUAS to support search and rescue first responders in the aftermath of a tornado that hit a manufacturing facility/lumber yard on the east side of an Army/Civil joint-use airport. One first responder, a State Highway Patrol officer, has employed the use of a sUA FASER aircraft, which included a portable GCS, from outside his cruiser. The GCS consisted of a handheld controller and a laptop display. The officer was trained in sUAS launch, recovery, and mission operations, including ATC communications and NAS operating procedures. The sUAS, capable of observing and recording high definition video, was used to attempt to locate one missing victim of the storm in the woods on the east side of the airport. Scenario maps with waypoints can be found in Appendix C.

Since the operations were held in Class D airspace at the Blackstone Army Airfield (AAF) (BKT), it was necessary that the sUAS unit remain in contact with ATC during the course of the operation. Because the FASER was small, ATC coordination was necessary to ensure that other manned aircraft, also responding to the emergency, knew the general location of the sUAS. The subject pilot could fly VLOS operations with the unmanned aircraft at altitudes up to 400 ft AGL; the subject, however, was briefed to manually fly at an altitude of 200 ft AGL. The subject also coordinated with a mission specialist at Mission Control (MC), who monitored the onboard camera and the recording of video data while directing the mission operation. Since the flight operation was conducted within VLOS, no flight plan was filed; however, clearance for takeoff and landing were required since the takeoff and landing was at the towered airport.

Table 1 – Eye Point, sUAS Starting Position, and Other Traffic for Scenario 1

	<b>Eye Point</b>			
	<b>Latitude</b>	<b>Longitude</b>	<b>Altitude</b>	<b>Heading</b>
	37.163357	-76.697753	1.83 meters	22.5
	<b>sUAS Starting Position</b>			
	<b>Latitude</b>	<b>Longitude</b>	<b>Altitude</b>	<b>Heading</b>
	37.163543	-76.697622	12.19 meters	22.5
<i>Other Traffic Timing</i>				
	<b>Start Time (sec)</b>	<b>End Time (sec)</b>	<b>Velocity (knots(kts))</b>	
Other Traffic 1	120	240	150	
Other Traffic 2	310	457.540984	122	
Other Traffic 3	530	680	120	
<i>Other Traffic Flight Paths</i>				
	<b>Latitude</b>	<b>Longitude</b>	<b>Altitude (ft)</b>	<b>Heading</b>
Other Traffic 1	37.221	-76.6732	457.2	156
Other Traffic 2	37.149	-76.6298	152.4	327
Other Traffic 3	37.206	-76.7120	304.8	126





Figure 2 – Scenario 1 Map of Waypoints

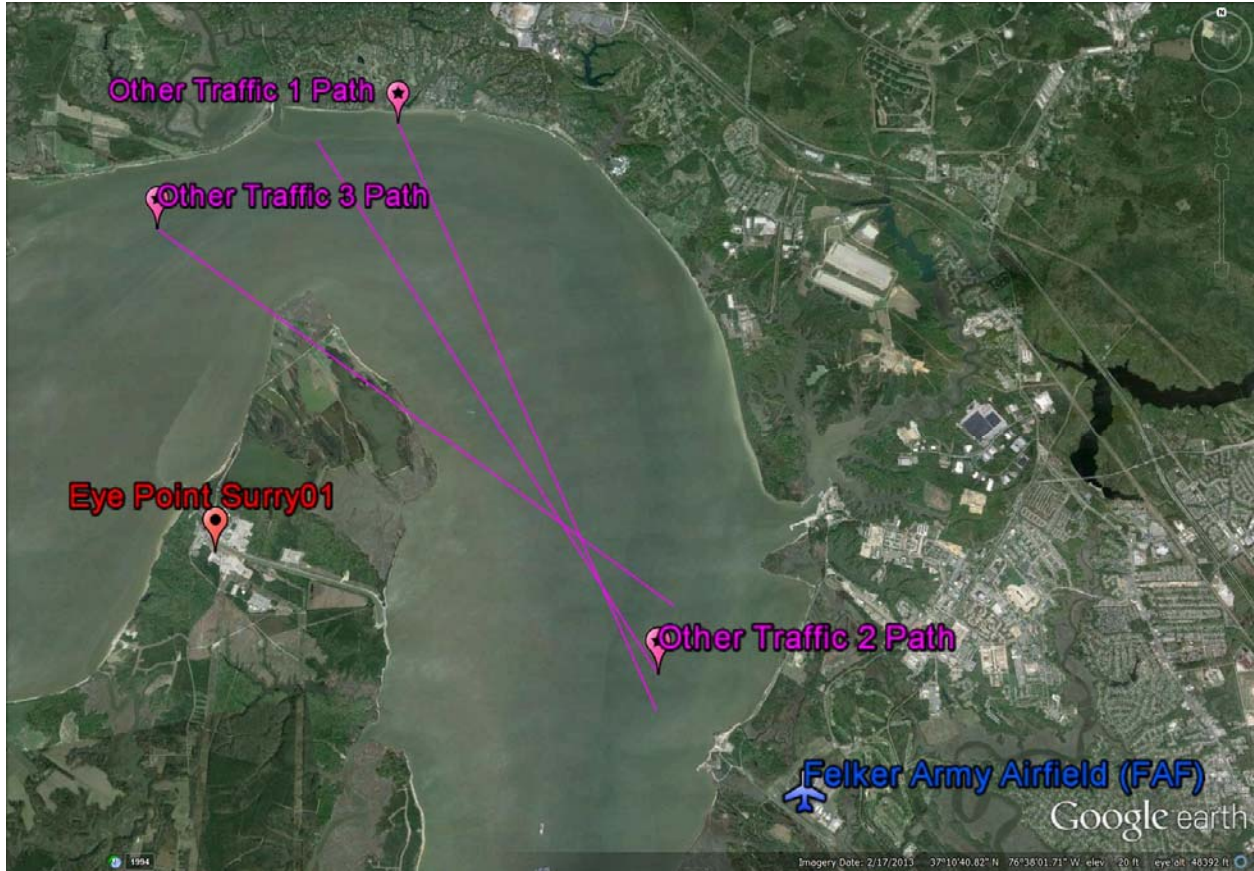

Figure 3 – Scenario 1 Map of Other Aircraft Paths

Table 2 below, and Figure 4 on page 10 and Figure 5 on page 11 are indicative of how each of the three Fort Pickett Blackstone Army Airfield scenarios were programmed for the simulation data runs. See Appendix C for the details on each of the Fort Pickett scenarios.

Table 2 – Eye Point, sUAS Starting Position, and Other Traffic for Scenario 4

	Eye Point			
	Latitude	Longitude	Altitude	Heading
	37.0722148	-77.94992420	1.83 meters	90
	sUAS Starting Position			
	Latitude	Longitude	Altitude	Heading
	37.072475	-77.9497650	12.19 meters	90
<i>Other Traffic Timing</i>				
	Start Time (sec)	End Time (sec)	Velocity (kts)	
Other Traffic 1	180	380	90	
<i>Other Traffic Flight Paths</i>				
	Latitude	Longitude	Altitude (ft)	Heading
Other Traffic 1	37.102	-77.9121	182.88	214



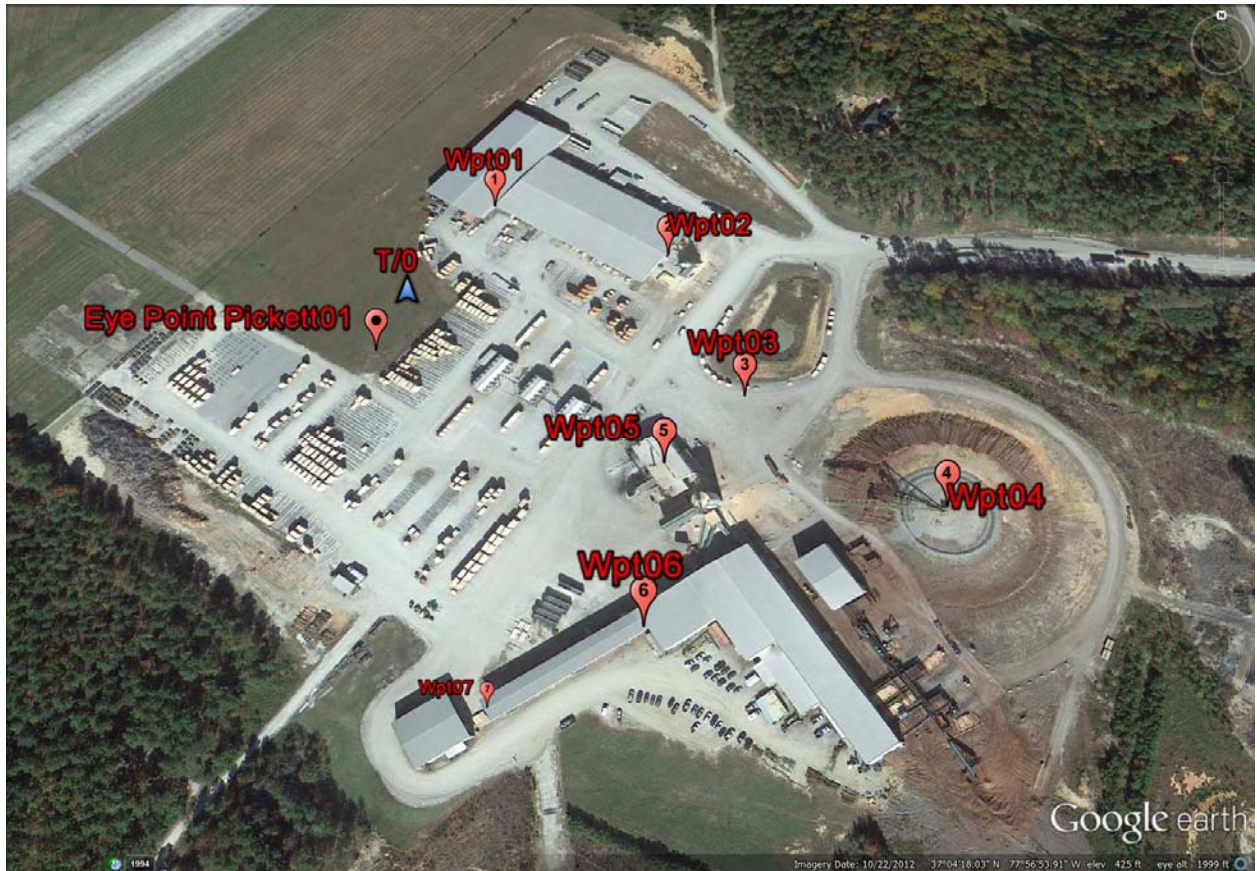

Figure 4 – Scenario 4 Map of Waypoints

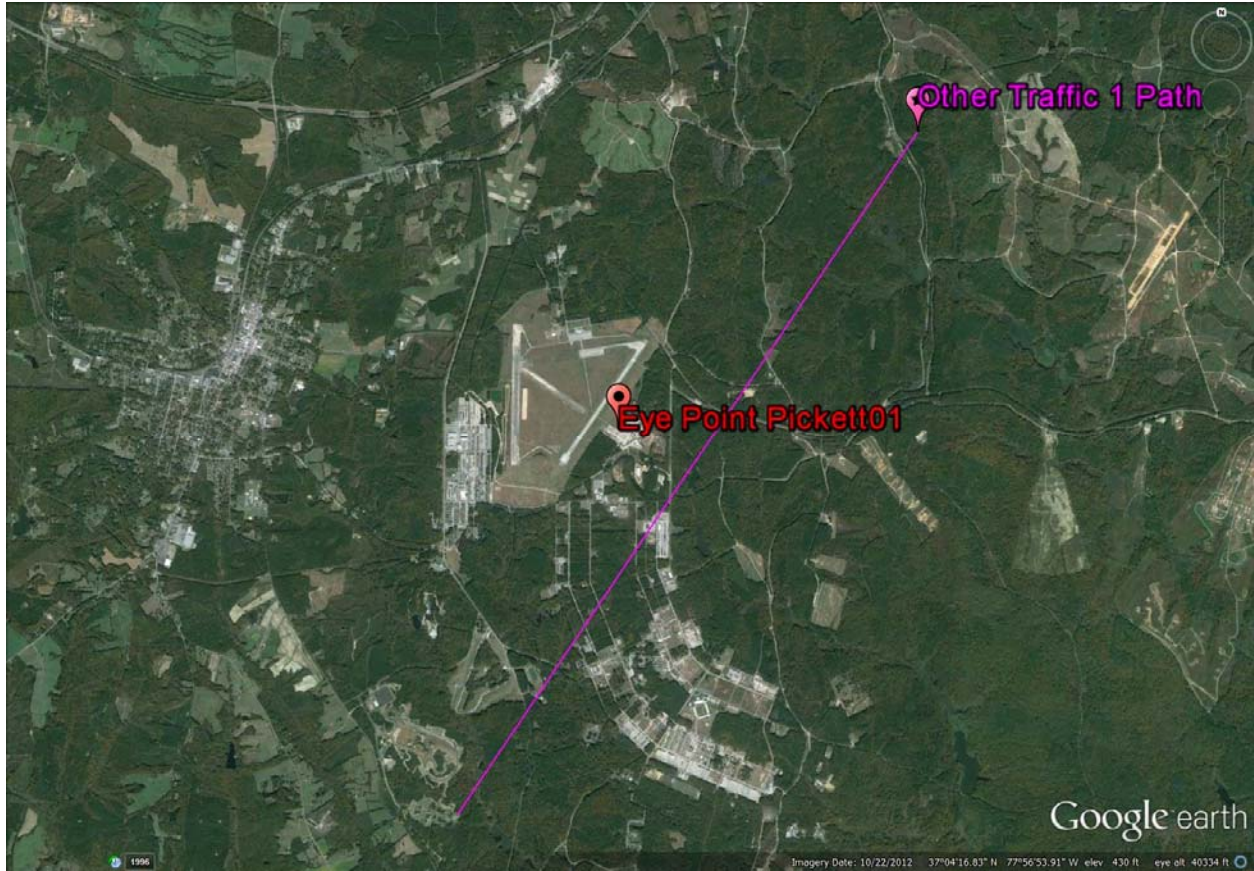

Figure 5 – Scenario 4 Map of Other Aircraft Paths

## 2.4 Air Traffic Control and Mission Control Positions

### 2.4.1 Air Traffic Control Position

The researcher at this experiment station operated the computer simulation and simulated ATC for the scenario by reading the ATC communication scripts and traffic alerts (Appendix D) to the subject pilot. In general, ATC granted all requests from the subject. This included requests for takeoff and resuming missions after possibly deviating due to manned air traffic. ATC traffic alerts were programmed to display at the ATC position in conjunction with traffic events (Figure 6 on page 12). They were timed to occur at appropriate times relative to actual aircraft entries into the simulation mission. Therefore, depending on how quickly each subject piloted his sUA from waypoint to waypoint, these traffic alerts were displayed when the UAS was at slightly different points along the mission route.

All of the communication scripts for ATC for the Surry Nuclear Power Plant Inspection scenarios (description of scenarios in §2.3) are detailed in Appendix E and all of the scripts for the Fort Pickett SAR scenarios are detailed in Appendix F. The manned aircraft for each scenario were listed at the top of the each script so ATC could anticipate them.

**2.4.1.1 Clearance for Takeoff or Landing.** Operations at the Surry Nuclear Power Plant were outside of the controllers' visual range. If the subject requested clearance for takeoff, the controller responded: *"FASER123, roger, altimeter two, niner, niner, two, wind one, eight, zero at five, report airborne,"* after the subject confirmed, the controller responded *"report on the ground when mission is completed."*





Figure 6 – ATC Alerts Pop-Ups and Test and Evaluation Simulator

Clearance for takeoff or landing was required at Blackstone Army Airfield (BKT) for the Fort Pickett SAR scenarios because the operation took place within sight of ATC in the vicinity of the airfield. If a subject requested clearance to takeoff and to land at the airfield, such a clearance was given.

**2.4.1.2 Notification of Other Aircraft.** ATC would notify the subject of some of the other manned aircraft in the area. If the subject diverted to avoid the traffic, ATC would grant permission to resume the mission when the subject requested. The two typical ATC notifications were (1) “FASER123, Felker Tower, Traffic, a Cessna 172, three miles north of your position heading southeast will pass approximately two miles northeast of your position. Report traffic in sight;” and (2) “FASER99, Blackstone Tower, Traffic, UH-60, two point five miles southwest, low altitude, headed your direction, NO RADIO. Circle within visual line of sight at low altitude. Advise traffic in sight” (Appendix D). Note that communication between the

manned aircraft and the towers at Felker and Blackstone were not simulated. This resulted in no party-line communications that the subject could hear regarding other traffic in the area.

If the subject pilot called ATC to advise *“traffic in sight,”* the researcher in the ATC position would click on a button on the ATC control screen to indicate that the subject acknowledged traffic. The mission elapsed time for that event was then recorded into the data file. At that point, if the subject deviated his sUA from the planned mission path, he would call MC to advise of this deviation due to traffic and then subsequently to request directions to resume the mission.

**2.4.1.3 Handling sUAS Crashes.** Procedures were set in place at the ATC control station to remedy sUAS crashes. The following details those procedures:

- Crash prior to reaching waypoint #5 – restart that simulation run
- Crash twice before reaching waypoint #5 – keep data and proceed to the next run
- Data was kept from runs that terminated in a crash with notation of the crash location
- All data for all runs, including ones that were restarted due to sUAS crashes, were saved

## **2.4.2 Mission Control Position**

A second researcher was seated above and behind the subject position. This researcher acted as the MC specialist and read the scripts (Appendix E for Surry Nuclear Power Plant Scripts and Appendix F for Fort Pickett Scripts) which directed the subject during the mission scenario. In each scenario, the subject was instructed to contact MC, once the sUA was airborne and after the initial calls to ATC, to initiate the pre-coordinated mission route and to get directions to proceed from waypoint-to-waypoint. The mission was pre-coordinated between the subject and MC before the mission began. This pre-coordination included identifying the seven waypoint locations to the subject by showing them on a paper map and pointing them out in the visual scene. The subject was expected to loiter his sUA at each waypoint for data collection by MC. The subject was directed by MC to have his sUA proceed to each waypoint and to report established at each successive location. After loitering for 60 seconds (as manually timed by MC using a stopwatch), the MC instructed the subject to proceed to the next waypoint in sequence. After loitering at waypoint number Seven for 60 seconds, the MC specialist informed the subject that the mission was terminated after all the necessary data were collected, and would inform the subject to report *“on the ground”* to ATC. Let it be noted that subjects were instructed, in the training, to return to base and loiter to mimic on the ground.

**2.4.2.1 After the Subject was Notified about Other Aircraft.** If the subject pilot deviated his sUA from the planned mission route due to other aircraft in the vicinity, the subject contacted MC to advise of the deviation and to request further instructions. When this occurred, MC determined if the subject had been at the last reported waypoint long enough to proceed to the next waypoint. If not, MC made the determination for the subject to return to his last waypoint to continue collecting data. To resume the mission, the MC specialist instructed FASER123 or FASER99 to *“proceed to waypoint (#) [i.e., the next waypoint in sequence] and report established.”*

**2.4.2.2 Observing.** The researcher serving as the MC specialist conducted observations and logged the subject’s activities during each scenario. Notes were taken concerning anything that the observer considered relevant to the experiment goals and hypotheses, including observations related to the subject’s situation awareness. Subject reactions to intruder aircraft were also logged, including whether or not the subject notified ATC when traffic was visually acquired, whether the traffic had been announced by ATC or not. The MC made no comments to, nor answered any questions for, the subject concerning his performance in conducting the mission, which is standard experimental protocol. Questions formatted from these notes were

later asked of the subject during debriefings after each run, following the completion of the on-screen questionnaires.

## **2.5 Subject Communication with ATC and MC**

Subjects called ATC to get approval to start the flight and contacted ATC to terminate the mission scenario when the sUA had arrived back on the starting point. The subject only had the take-off script and could choose to read it for the initial call for each mission (§2.7.1.1 and §2.7.1.2) prior to launching. During the remainder of each flight, the subject acknowledged and responded to ATC directions. All other communications by the subject were either responding to commands and directions, or individual subject decisions to initiate radio contact. The subjects were not provided a copy of the script showing the traffic types, paths, and times that traffic would appear.

### **2.5.1 Pilot Requests for Takeoff and Landing**

At the Surry Nuclear Power Plant, subjects requested clearance for takeoff by contacting ATC with a notification of intention and then once airborne they indicated that they were airborne and would *“remain within 400 yards of Surry Nuclear Power Station at or below 400 feet.”* As for the Ft. Picket SAR scenarios, subjects requested clearance for takeoff by contacting ATC at which point Blackstone Tower would grant permission for takeoff. Once the mission was completed, subjects would contact ATC when they were back at the takeoff/landing point for mission termination.

### **2.5.2 Notification of Traffic in Sight**

After being notified by ATC of other aircraft, the subject had the option to call back reporting that the traffic was in sight to ATC. As mentioned above for the Surry Nuclear Power Plant inspection scenarios, the subject pilot had to stay in contact with FAF Tower for flight advisories concerning other aircraft around the Surry Nuclear Power Plant operation area when the sUA was in Class D airspace. However, because the sUA would be flying in and out of Class D airspace at Surry Nuclear Power Plant, the subject pilot was not required during this experiment to notify ATC when the vehicle entered or departed this Class D airspace. For the SAR scenario in BKT Class D airspace, the sUAS unit had to remain in contact with ATC during the course of the operation.

If the subject had deviated from the planned route, the subject should also have contacted MC. Once the subject wanted to resume his planned mission, the subject should have contacted MC again to inquire which waypoint to proceed to (as mentioned in §2.4.2.1).

## **2.6 Experiment Design**

The simulation study employed the use of a within-subjects experimental design. Each subject was exposed to three different display configurations under two different scenarios in random ordering.

### **2.6.1 Independent Variables**

The simulation study had three different GCS display configurations for sUAS as an independent variable. The treatments were blocked according to display type and randomized in order shown for each subject. The following are the display configurations studied:

- Visual Line-of-Sight only (VLOS)
- VLOS + Primary Flight Display (PFD)
- VLOS + PFD + Moving Map (Map)

**2.6.1.1 VLOS.** This was simulated solely on the wide-angle display in the simulator (§2.2.1) without the use of any head-down displays. Under this display configuration, the subject had to fly the FASER, his sUA, manually on its mission using only VLOS operations for navigation and avoidance of obstacles and other aircraft.

**2.6.1.2 VLOS + PFD (PFD).** Under this display configuration, the subject manually flew the sUA using VLOS operations for navigation and avoidance of obstacles and other aircraft, while having access to attitude, altitude, airspeed, and heading information displayed on the GCS laptop computer’s flat-panel screen (Figure 7 below).

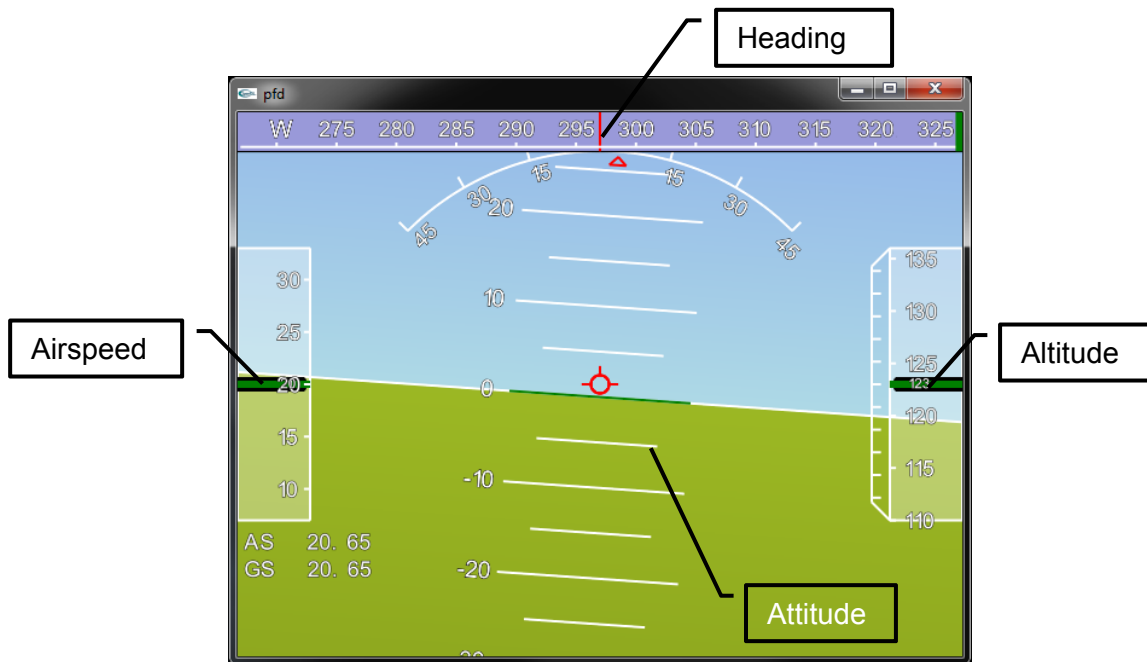

Figure 7 – PFD

**2.6.1.3 VLOS + PFD + Moving Map (Map).** Under this display configuration, the subject manually flew the sUA using VLOS operations for navigation and avoidance of obstacles and other aircraft, while having access to attitude, altitude, airspeed, and heading information that were displayed on the GCS laptop computer’s flat-panel screen. In addition, a moving map display (Figure 8 on page 16) was included in the display configuration that took advantage of the GPS capability on the sUA so that the subject could follow the vehicle ground track on a modified, commercially-available map-type horizontal situation display, also shown on the GCS laptop screen above the PFD. This moving map display allowed the subject to confirm the actual location of the vehicle and its direction of flight over the ground during the mission.

## 2.6.2 Organization of Independent Variables

The order of the display sets, for this experiment, was randomized for each test subject. Tables representing the run order for each test subject can be found in Appendix G. The three display configurations – VLOS, PFD, and Map – were blocked. This means that for all runs across the 9 subjects, each subject saw a particular display configuration for a practice run and three data runs before moving on to the next display configuration (Figure 9 on page 17). Before the first practice run for the first display configuration, each subject was able to fly the sUA around the Fort Pickett area for 10 minutes in order to become comfortable with the manual controller and the sUA flight dynamics.





Figure 8 – Moving Map

### 2.6.3 Dependent Variables

The dependent variables of the simulation study included:

- sUA flight path and attitude
- Obstacle collisions
- ATC and MC communications
- sUAS pilot situation awareness
- System controllability
- Workload

**2.6.3.1 sUA Flight Path and Attitude:** The path the subject took to each waypoint and the sUA attitude and altitude information were recorded as the subject flew and loitered over each waypoint. Subjects were told to position the waypoint at the center of the loiter circle.

**2.6.3.2 Obstacle Collisions.** If the subject got within 50 ft of an obstacle (building, power line, etc.), this was recorded as a collision although the subject was not notified of the collision and the simulation continued. However, subjects were briefed during the training that if they were within 50 ft of an object, it would be considered a collision. Although the FAA has no clearance requirements for sUAS, a 50 ft lateral distance from obstacles was required in this experiment so that subjects had to maintain both lateral and vertical clearances from objects and the ground.

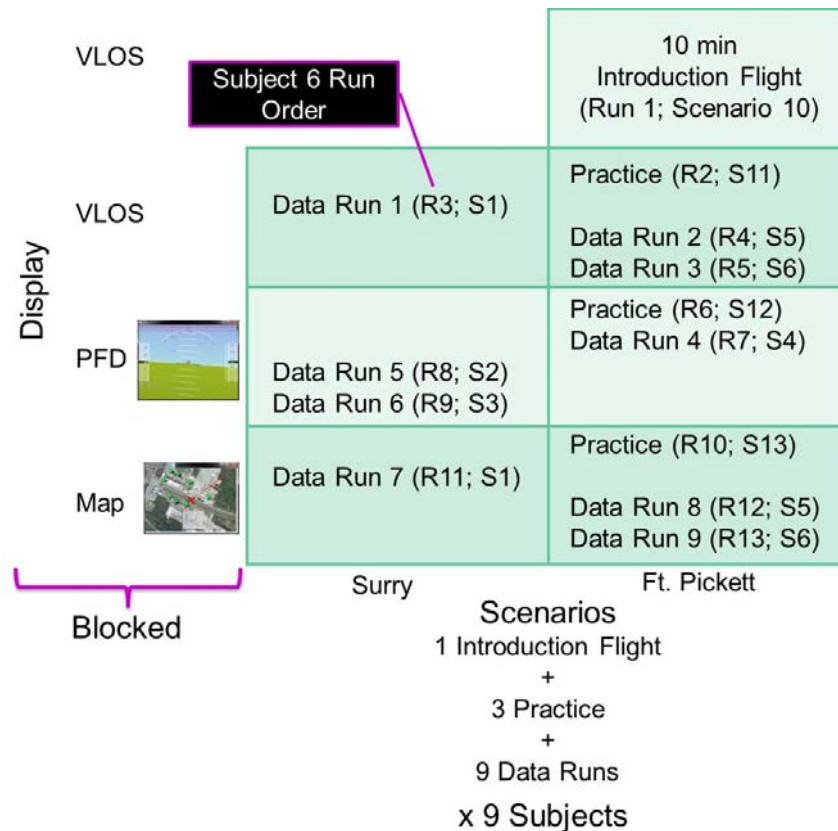

Figure 9 – Experiment Design Example

Note: Each subject had 1 Introduction Flight, 3 Practice Runs, and 9 Data Runs for a total of 13 Runs. R# is sequential count of these runs.

**2.6.3.3 ATC and MC Communications.** The subject's ability to comply with, and respond to, ATC and MC commands in a timely manner was noted by the researchers acting as ATC and MC.

**2.6.3.4 sUAS Pilot Situation Awareness.** At the end of each run, subjects answered six situation awareness questions, four of which were the same for every run and two random questions. The four questions always asked were:

1. What percentage of the time did you lose visual line-of-sight of your aircraft?
2. How well did you maintain the desired altitude and heading of the aircraft?
3. How well did you resume the intended flight path after an obstacle?
4. How many other aircraft did you notice in this scenario run?

The two random questions were selected from the following:

1. How well did you go from one loiter point to the next?
2. What is the furthest distance (in yards) that your aircraft traveled in relation to your standing point?
3. At what level of comfort was it to maneuver your aircraft to avoid obstacles (given the information on your Ground Control Station)?
4. What percentage of the time did you deviate away from the loiter points (not including obstacles)?

5. Within what time frame (in seconds) did it take you to reply back to Air Traffic Control (ATC) commands?
6. What is the closest distance (in yards) that your aircraft came to within another aircraft?
7. On average, how many times did ATC have to repeat a certain command?
8. What was your starting altitude?
9. What was your heading at the start of this scenario run?

**2.6.3.5 System Acceptability and Controllability.** Questionnaires were given to the subject, both in an electronic-version and in a paper-version, in order to evaluate the acceptability and controllability of the system as a whole; the system was defined as the TES simulator, the hand-held control unit, the displays, and the sUA. The questionnaires included a modified Cooper-Harper (CH) Rating, a GCS display questionnaire, and a final questionnaire. The following explain the three different questionnaires and when they were administered to the subject.

sUAS Pilot Modified CH Rating: At the end of each run, subjects completed an electronic version of the modified CH rating (Figure 10 on page 19) (Cooper & Harper, 1969; Harper & Cooper, 1986; Trujillo, 2009b).

sUAS Pilot GCS Display Questionnaire: Once the subjects completed the three data runs for a particular display configuration, they completed a GCS Display Questionnaire (Appendix H). This set of questions subjectively evaluated the subject's thoughts in regards to the layout of the GCS display, in addition to asking how well the information presented on the GCS warned the subject of any upcoming obstacles. The questions also aimed at exploring the subject's thoughts on any information that was needed or missing on the GCS display.

sUAS Pilot Final Questionnaire: At the end of all the data runs, subjects completed the Final Questionnaire (Appendix I), which was administered during the debrief at the end of the experiment. This set of questions sought the subject's evaluation of all the runs from the beginning of the experiment day to the end. Questions that were asked involved ranking the display treatments in order of preference and how well the subject felt he performed throughout the day and whether or not strobe lights help in maintaining VLOS during daylight operations. In addition to these questions, additional space on the paper was provided for any additional comments the subject wished to share.

**2.6.3.6 Workload.** Subjects completed an electronic version of the NASA-Task Load Index (TLX) (Figure 11 on page 20) (Byers, Bittner, & Hill, 1989; Hart & Staveland, 1988; Trujillo, 2009a) at the end of each run. The NASA-TLX is a subjective evaluation of the subject's workload. The evaluation bases its scores on six criteria, which include mental demand, physical demand, temporal demand, performance, effort, and frustration level.

## 2.7 Procedure

Upon arriving at the testing location within the National Aeronautics and Space Administration (NASA) Langley Research Center, each subject went through three phases, which included: (1) the training and briefing session, (2) the data collection runs in the TES lab, and (3) the debriefing session. The following sub-sections explain these three phases in further detail. Pilot subjects were run individually across a one-day period for 8 hours.

### 2.7.1 Briefing and Training Session

The first phase of the day consisted of a briefing and training session. Upon arrival at the testing facility, the subject was escorted to a conference room where his briefing took place. During the briefing session, the researcher used the experimenter's instructions sheet/checklist (Appendix J) as a guide and provided each subject with an overview and an explanation of the

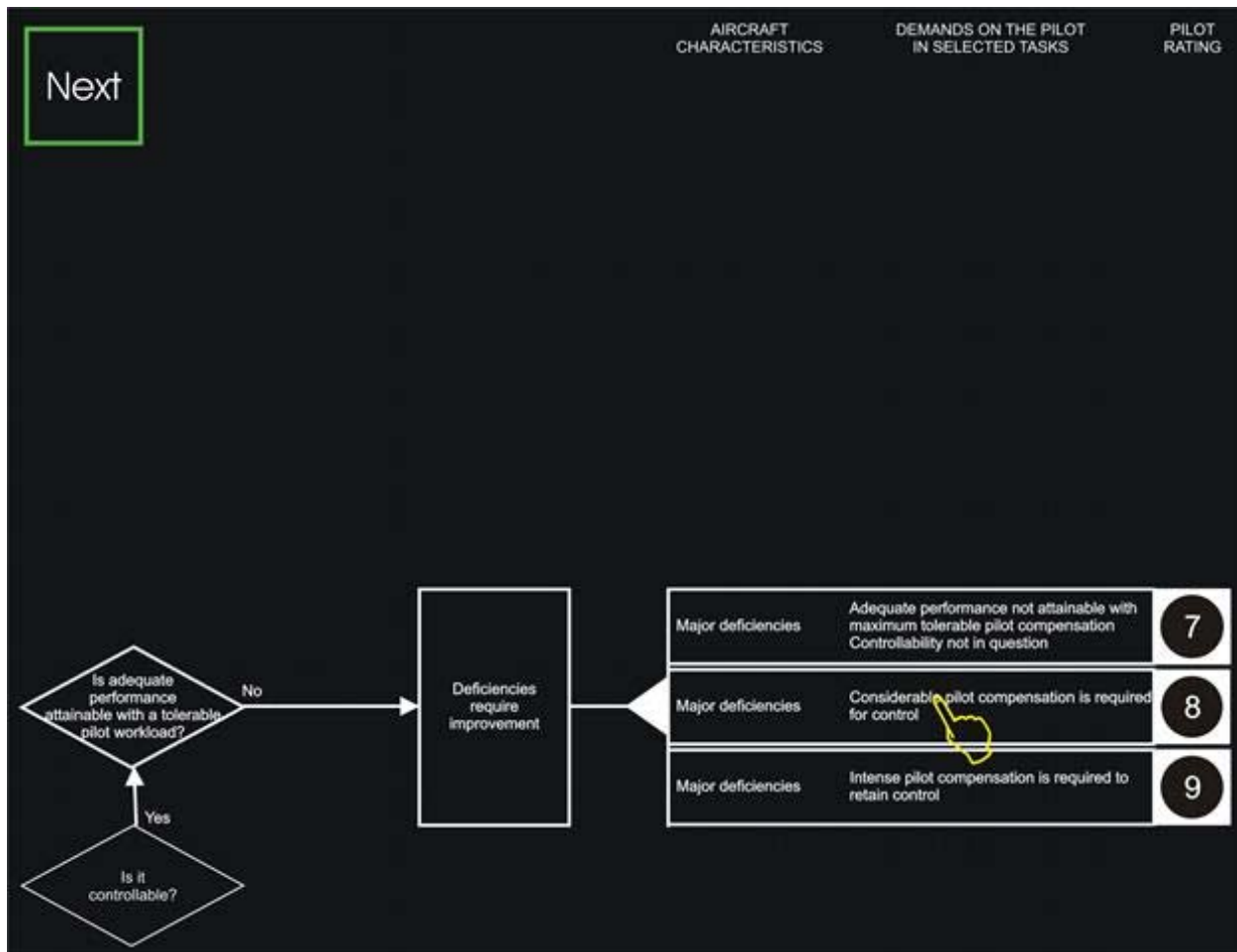

Figure 10 – Electronic Version of the Modified CH Rating with Ratings Available from “Is adequate performance attainable with a tolerable pilot workload?” Answered “No”

experiment. First, the subject was introduced to the informed consent form (Appendix K) and the privacy act notice (Appendix L). Both forms were explained to the subject in detail by the researcher and the subject was asked if he had any questions or concerns. After those two forms were signed, the researcher continued with the briefing session and provided an overview of the experiment, which covered the background, the purpose, the general procedure, the simulation environment, the communications standards along with a briefing describing the role of ATC and MC, the various experiment runs along with the tasks involved and the descriptions of the scenarios and locations of those scenarios, and the questionnaires.

Once the overview of the experiment was covered and any questions, comments, or concerns were resolved, the subject was taken to the TES facility to continue with the training process and to begin data collection. Upon arriving at the TES, each subject was introduced to the simulation set up along with a briefing regarding the hand-held control unit. This was followed by a familiarization practice run to give the subject the opportunity to become familiar with the intricate behavior of the simulation (e.g., how the aircraft responds to the control inputs) and the hand-held control unit; the subject was given as much time as he needed to become comfortable with the environment. In addition, the subject answered the on-screen questionnaires (i.e., the CH rating, the NASA TLX, and the situation awareness questions) to become familiar with the touch screen process.



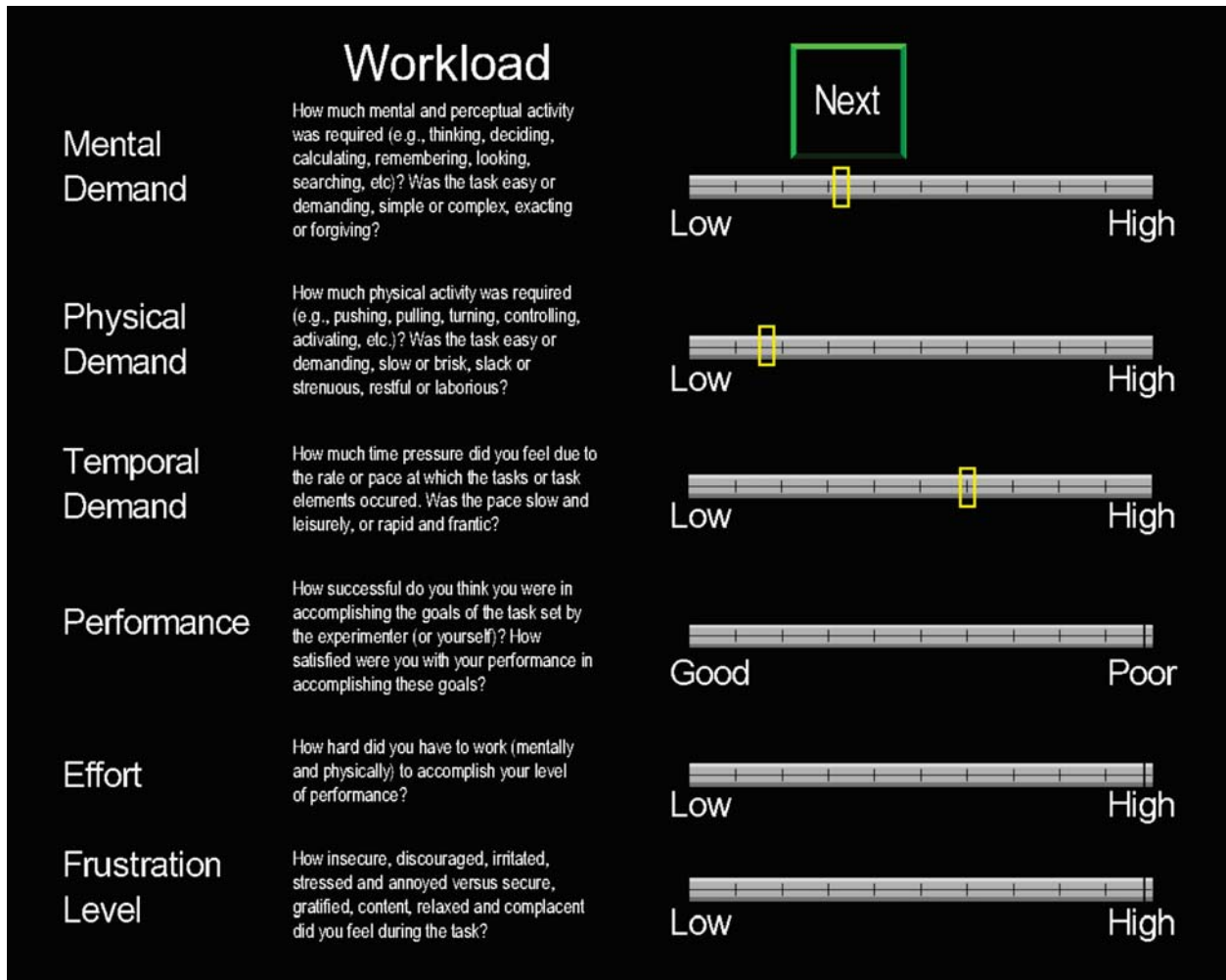

Figure 11 – Electronic Version of the NASA-TLX

When the subject was comfortable flying the simulation and comfortable with the controls, he had the chance to ask any questions before proceeding with the data collection. Each display treatment consisted of three runs, which were blocked and randomized for each subject (§2.6.2), in addition to a practice run given prior to the data collection runs; each subject was encouraged to ask questions during the practice run. Beginning with the second run, each subject was given a paper map, either of the Surry Nuclear Power Plant (Appendix B) or of Fort Pickett (Appendix C), with the waypoints established along a track to be flown in addition to a script with the initial radio calls that were to be made to ATC before the run. The waypoints on the paper map were described by the researcher and compared to the view on the TES screen to the subject. Each subject was instructed to contact ATC when ready to launch and to read the initial radio call. There were separate initial radio calls for each of the two scenario locations; one was for the Blackstone AAF in which the flight was located on the airfield, and the other one was for the Surry Nuclear Power Plant in which the flight was located off of the airfield. Visual Flight Rules (VFR) operations on the airfield require direct ATC clearance and instructions, which require a slightly different interaction with ATC in terms of communications. In addition, each subject was also instructed to contact MC once airborne. The following scripts dictate the initial radio calls that each subject was to read.

### 2.7.1.1 Surry Nuclear Power Plant Initial Radio Call.

**Pilot:** *“Felker Tower, FASER123”*

(ATC reply to go ahead)

**Pilot:** *“FASER123 is a small UAS at the Surry Nuclear Power Station by Hog Island. We will be conducting an inspection of the power plant, remaining within 400 yards of the facility, at or below 400 feet for approximately one hour, becoming airborne in about five minutes.”*

#### **2.7.1.2 Fort Pickett (Blackstone AAF) Initial Radio Call.**

**Pilot:** *“Blackstone Tower, FASER99”*

(ATC reply to go ahead)

**Pilot:** *“Blackstone Tower, FASER99 is a state police small unmanned aircraft unit responding to the tornado emergency at the lumber yard on the airfield. We have a missing person from this site and would like to reposition to a point on the airfield to launch a search and rescue effort. We would like to fly at or below 400 feet over the wooded areas around the airfield. We will operate visual line-of-sight within 400 yards of the launch point at all times.”*

#### **2.7.2 Data Collection**

Once each subject was comfortable with the simulation and ready to proceed, the researcher followed the same procedure as was done in the practice run for that display set. The paper map at the GCS location was reviewed with the subject and the mission was explained. The subject was also told which location the scenario was based at so as to determine which initial radio call and what call sign was necessary to use, and the mission altitude – 250 ft for the Surry scenarios and 200 ft for the Blackstone scenarios. At the completion of each run, each subject had a set of questions to answer on the touch screen. The questions included a modified Cooper-Harper rating, the NASA-TLX workload question, and six situation awareness questions, four of which were the same for every run and two random questions. In addition, after each subject completed the three runs that made up the display set, the subject was given a paper GCS display questionnaire (**Error! Reference source not found.**) that elicited his thoughts about the display set configuration he just experienced. Afterwards, the subject was given a break if desired; this was also the case for anytime during the experiment, not just after completing a display set. Next, the subject was given the second set of displays, which were randomized for each subject, and a practice run for that new display set would begin the process. Once the subject was comfortable to proceed, the researcher followed the same procedure as the practice run for that display as previously used. Following the completion of the second set of displays and all questionnaires were answered, the subject was given an hour lunch break. Upon returning from lunch, the subject was introduced to the final display set configuration beginning with a practice run of that display configuration. The researcher followed the same procedure as the first and second display set configurations. At the end of the day, once all three display sets were completed and all questionnaires were answered, the subject was debriefed.

#### **2.7.3 Debriefing Session**

The final phase of the day consisted of a debriefing session in which each subject was taken to a conference room outside of the simulation environment and given two additional questionnaires: (1) the final/exit questionnaire (**Error! Reference source not found.**), which elicited their thoughts regarding the simulation and the GCS user-interface displays for the entire day, and (2) a background questionnaire (Appendix A) that followed the final/exit questionnaire. Upon completion of those two questionnaires, subjects had the opportunity to discuss their thoughts about the simulation, the GCS displays, and anything else the subject had in mind.

## 2.8 Hypotheses

The following hypotheses were tested:

- Hypothesis 1: The sUAS simulator will provide a valid representation of flying a sUAS in VLOS operations.
- Hypothesis 2: The sUAS pilot will effectively operate the unmanned aircraft from its GCS while avoiding simulated ground-based obstacles that present the potential for conflict.
- Hypothesis 3: GCS voice communications with ATC in a simulated Class D airspace operational environment will be sufficient to avoid manned aircraft.
- Hypothesis 4: No human system integration deficiencies that could hinder initial integration of sUAS VLOS mission, within Class D airspace, will be identified.
- Hypothesis 5: The PFD display will be required for the pilot to be able to adhere to ATC and MC commands.
- Hypothesis 6: The Map display will be preferred.

## 3 Results

The below data analyses were done with IBM SPSS Statistics version 22 (IBM, 2013). A Kruskal-Wallis H one-way analysis of variance (ANOVA) was used for CH handling qualities ratings and display rankings. The rest of the analyses consisted of ANOVAs. Significance for all tests was set at  $p \leq 0.05$ . Lastly, any error bars present in a graph indicate one standard error of the mean (SE).

### 3.1 Mission

In general, subjects had no significant issues flying the simulated sUA. Their overall time for each run was fairly consistent, with the run time using just VLOS (690 seconds (sec)) being slightly less than with either the PFD (741 sec) or Map (745 sec) display conditions ( $F_{(2,532)}=32.17$ ;  $p \leq 0.001$ ). The layout of the displays was adequate, with subjects preferring more information being available ( $F_{(2,23)}=13.05$ ;  $p \leq 0.001$ ) (Figure 12 on page 23). However, most subjects did indicate that the TES resolution and the controllability of the simulated sUA resulted in some decrease in situation awareness and increase in workload.

#### 3.1.1 Lateral Errors at Waypoints

Once the subjects arrived at a waypoint to loiter for 1 minute (min), the area of the box they circled in was calculated by taking the closest and farthest latitude and longitude points from the subject location. The number of loiter points at the waypoints only varied slightly by subject indicating that the loiter times at each waypoint were consistently in the 1 min range for all subjects. The loiter area was the smallest for the VLOS condition and the largest for the Map display ( $F_{(2,527)}=72.23$ ;  $p \leq 0.001$ ) (Table 3 on page 23). The lateral root mean square (RMS) error from the center of the box to the waypoint varied slightly, although not statistically significant, by waypoint number where the error essentially decreased with increasing time in the run except for the last waypoint. This may indicate that being able to judge distance in the TES simulator was harder to do accurately closer to the eye point. For display condition, the Map and the PFD displays had more waypoints in the box than the VLOS display condition ( $F_{(2,527)}=4.44$ ;  $p=0.012$ ) although subjects were not that accurate in loitering over the waypoint, even with the Map display available (Figure 13 on page 24).

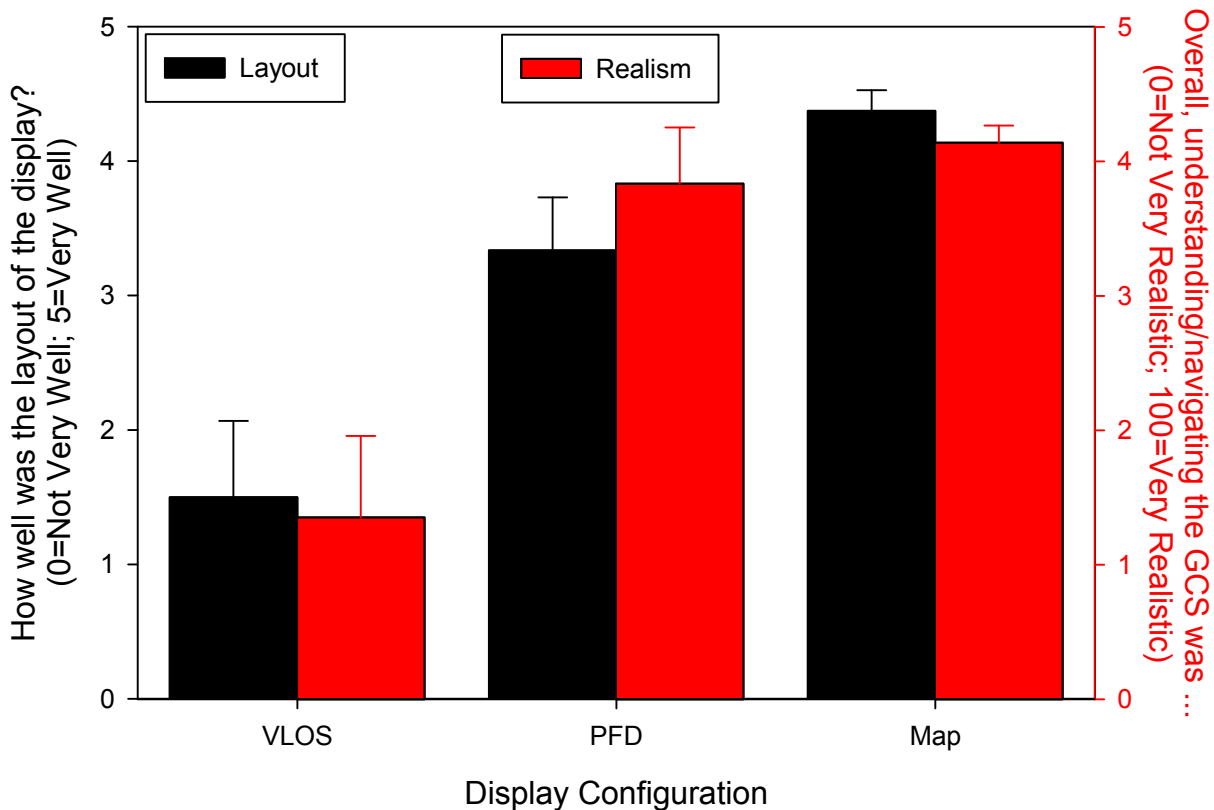

Figure 12 – Display Layout and GCS Realism by Display Configuration

Table 3 – Loiter Area by Display Condition

Display Configuration	Loiter Area (ft <sup>2</sup> ) ± 1 SE
VLOS	497.10 ± 11.7
PFD	641.37 ± 16.5
Map	735.61 ± 14.5

### 3.1.2 Altitude Errors

With regards to maintaining the prescribed altitude – 250 ft for scenarios 1-3 and 200 ft for scenarios 4-6 – a similar pattern emerged. In general, the average altitude was slightly below the prescribed altitude with the VLOS altitude being the lowest and the Map display condition being slightly less negative ( $F_{(2,544)}=31.62$ ;  $p \leq 0.001$ ) (Figure 14 on page 24) indicating that the altitude information on the PFD was useful for maintaining the prescribed altitude. This pattern also held at each individual waypoint ( $F_{(2,488)}=18.36$ ;  $p \leq 0.001$ ) (Figure 14 on page 24) although the waypoint altitude error becomes more negative at the later waypoints (Figure 15 on page 25). The overall altitude error also decreased with more runs ( $F_{(8,531)}=2.20$ ;  $p=0.026$ ) (Figure 16 on page 25) indicating a learning effect.

Interestingly, for the altitude errors but not for the lateral errors, the pilot license of the subject was significant for maintaining the prescribed altitude; although with so few subjects, especially in the categories of private pilot and no pilot license (RC pilot only) (see §2.1), the following results should be taken with a degree of caution. ATP and those that were just RC pilots were able to better maintain the prescribed altitude during the data runs depending on display configuration ( $F_{(4,544)}=2.92$ ;  $p=0.021$ ) (Figure 17 on page 26) and at the individual waypoints ( $F_{(2,542)}=10.37$ ;  $p=0.37$ ) (Table 4 on page 26). ATP license holders are accustomed to



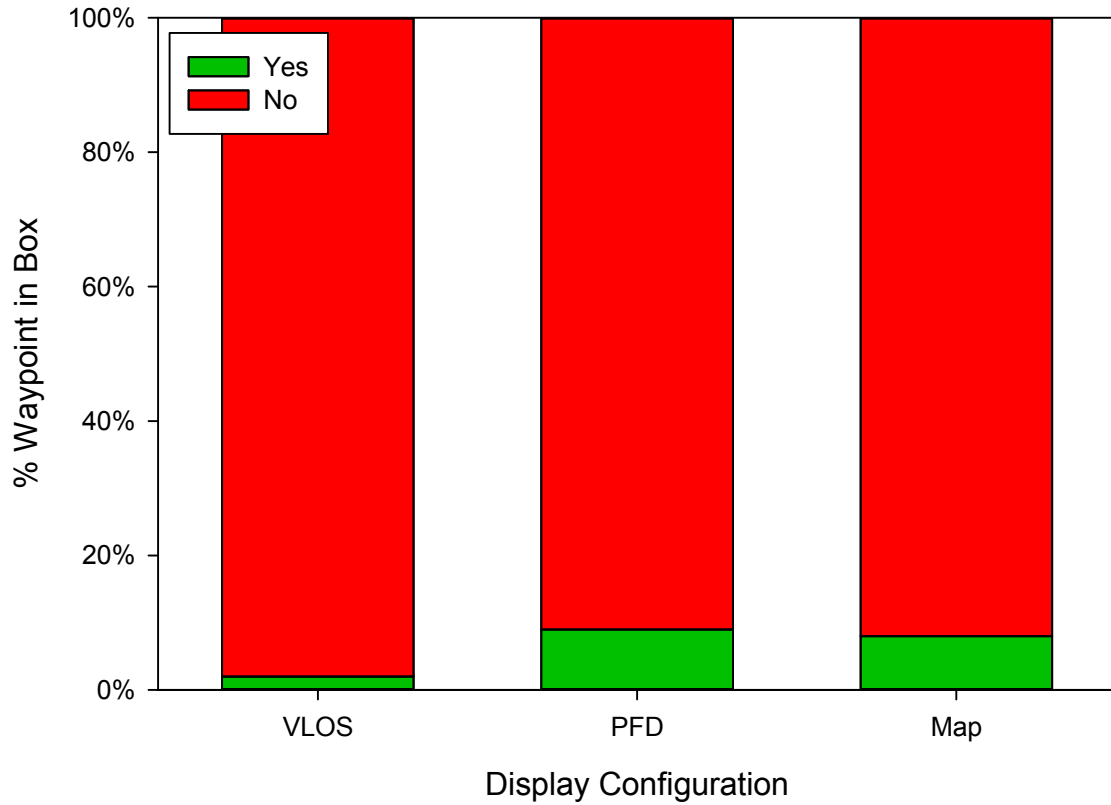

Figure 13 – Percentage of Waypoints in Loiter Area Box by Display Configuration

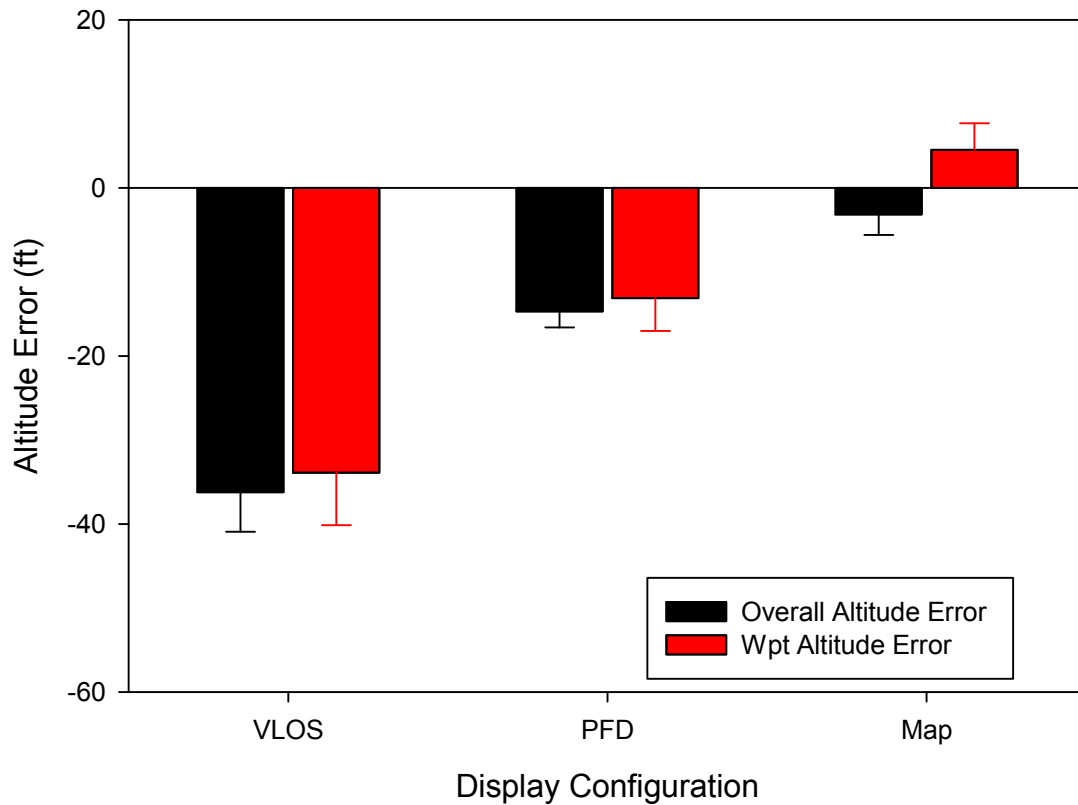

Figure 14 – Altitude Error by Display Configuration

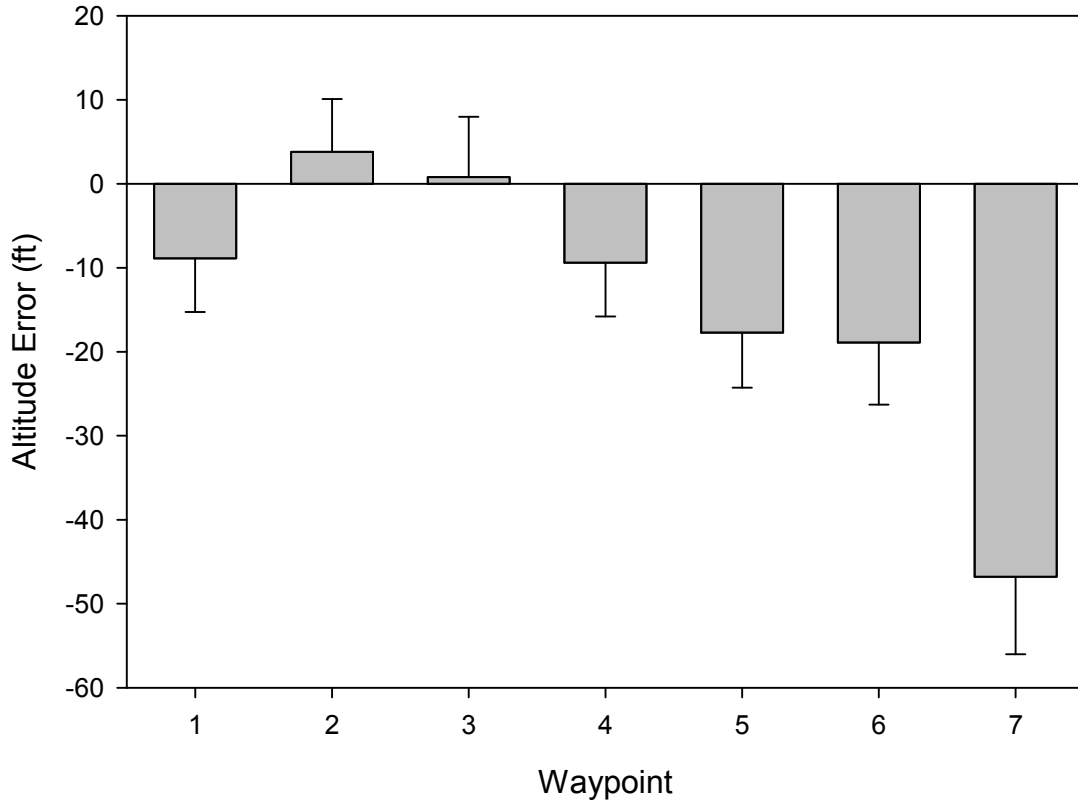

Figure 15 – Altitude Error by Waypoint

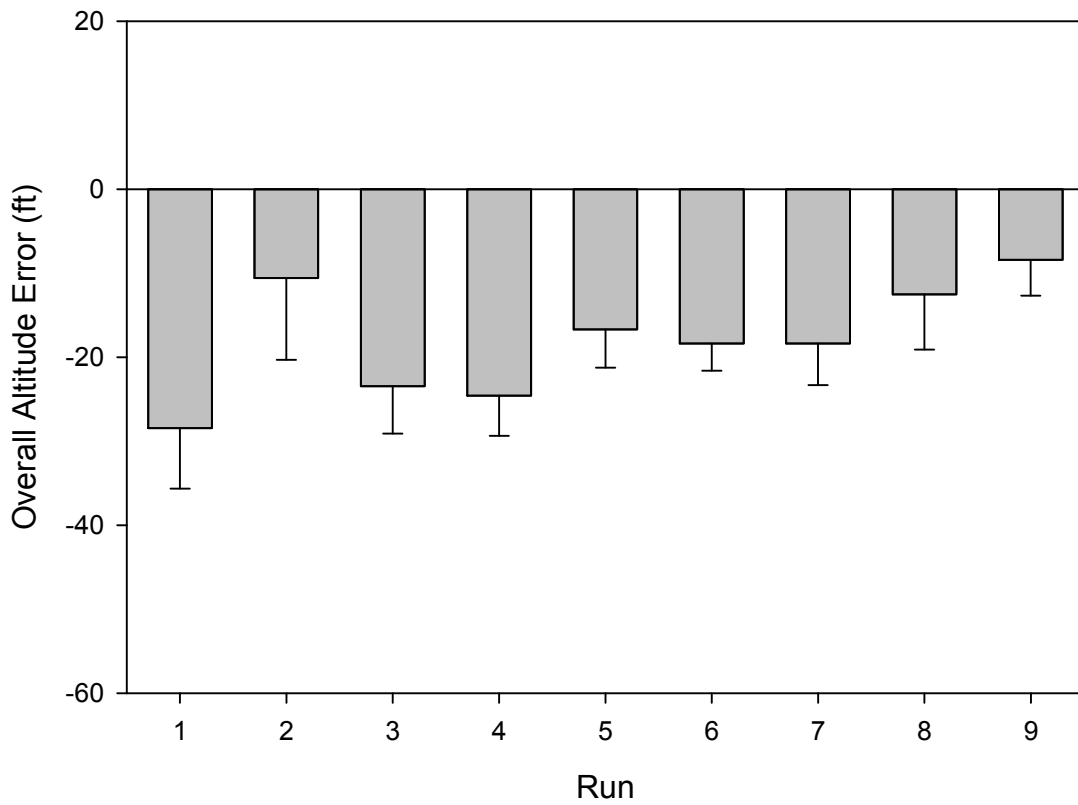

Figure 16 – Overall Altitude Error by Run

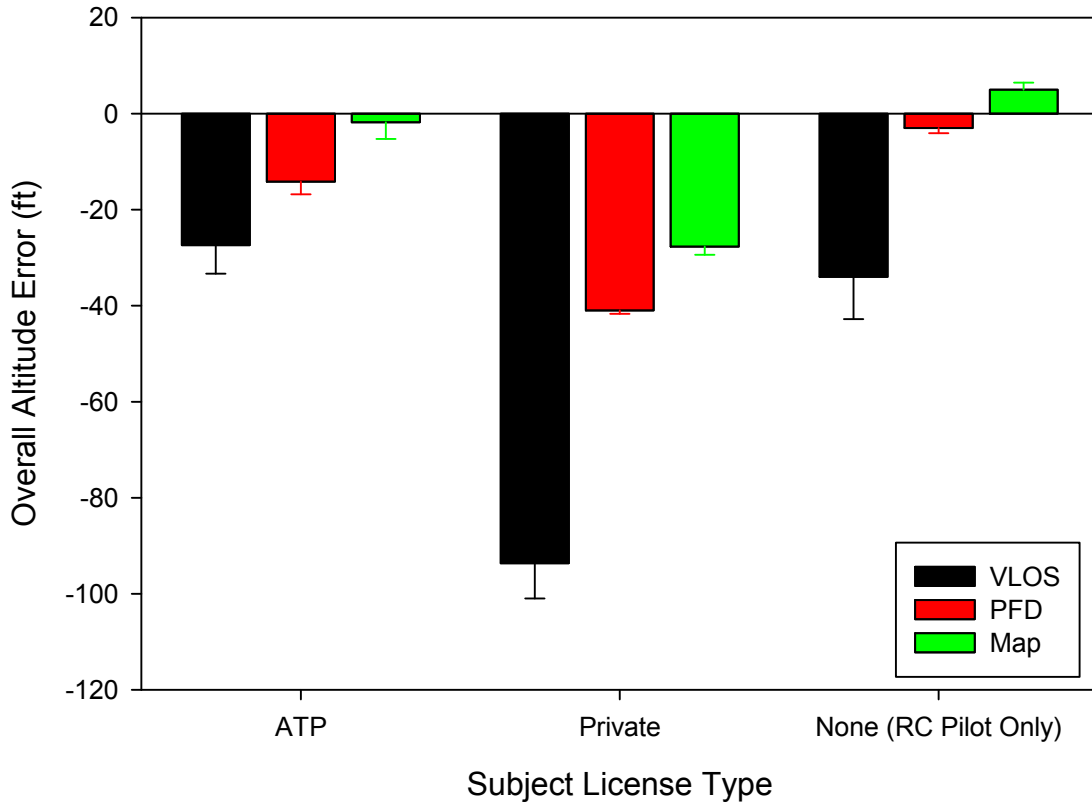

Figure 17 – Overall Altitude Error by Subject License Type and Display Configuration

Table 4 – Ability to Maintain Altitude at Waypoints by Subject License Type

Subject License Type	Waypoint Altitude Error $\pm$ SE (ft)
ATP	-11.98 $\pm$ 3.71
Private	-45.86 $\pm$ 5.82
None (RC Pilot Only)	-13.88 $\pm$ 2.76

maintaining tighter ranges on altitude than those with private pilot licenses, especially with altitude information provided on the PFD and Map display configurations. The RC pilot only subjects are also experienced in judging altitude of their sUA, especially using only visual cues.

### 3.1.3 Subjective Mission Ratings

Overall, subjects felt that they were able to “maintain the desired altitude and heading of the aircraft” the best with more information ( $F_{(6,75)}=4.00$ ;  $p=0.022$ ) (Table 5 on page 27) with a slight increase in their ratings as more runs were accomplished ( $F_{(8,56)}=2.18$ ;  $p=0.042$ ) (Figure 18 on page 27). This was also reflected in the CH ratings where the CH ratings decreased slightly as more runs were accomplished ( $F_{(8,57)}=2.11$ ;  $p=0.049$ ) (Figure 19 on page 28). As for workload, the additional displays did not appreciably increase workload although with the displays, performance was better ( $F_{(2,76)}=3.88$ ;  $p=0.025$ ) (Table 6 on page 28). For the overall workload rating, the workload did slightly decrease with more runs ( $F_{(8,57)}=3.84$ ;  $p=0.001$ ) (Figure 20 on page 29) again indicating a small learning effect. Lastly, subjects preferred having the Map display condition over the PFD and VLOS display conditions ( $F_{(8,24)}=13.58$ ;  $p\leq 0.001$ ) (Figure 21 on page 29).

Table 5 – Ability to Maintain Altitude and Heading by Display Condition

Display Configuration	How well did you maintain the desired aircraft altitude and heading? (0=Not Very Well; 100=Very Well) ± 1 SE
VLOS	41 ± 3.8
PFD	51 ± 3.8
Map	56 ± 4.5

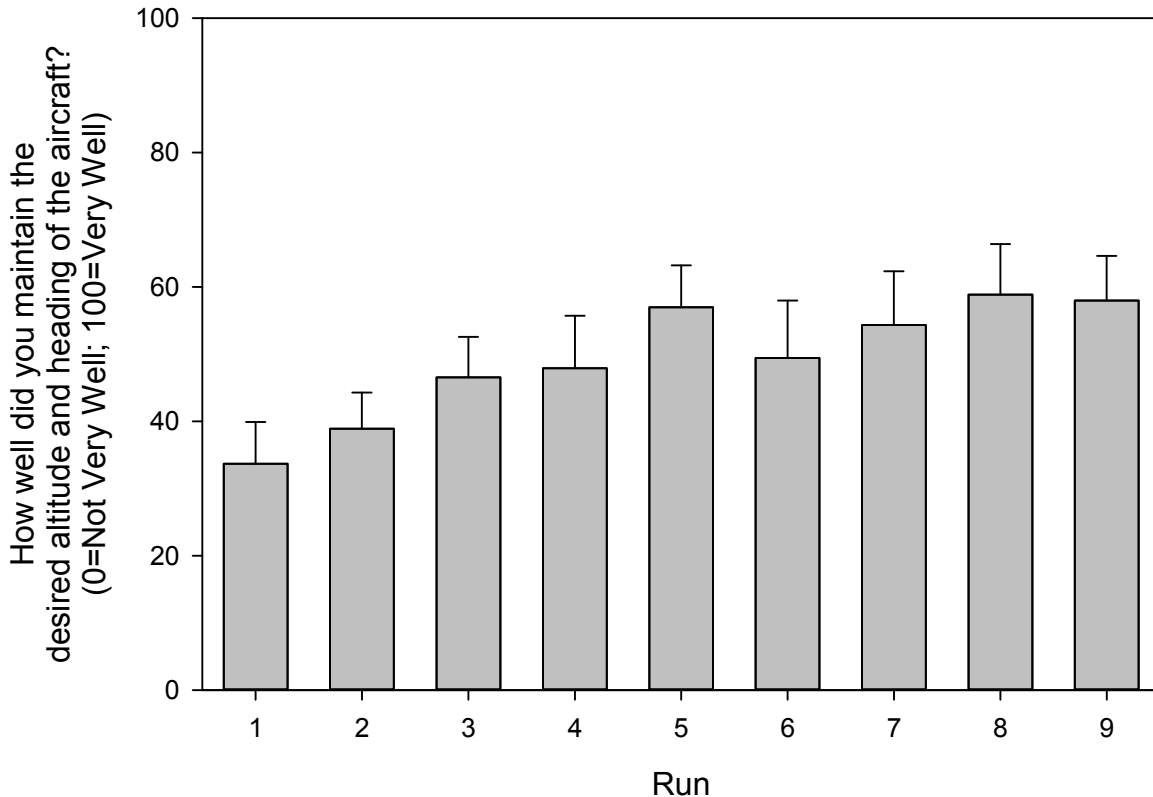

Figure 18 – Ability to Maintain Altitude and Heading by Run

### 3.1.4 Collisions

The number of collisions was significantly different across scenarios ( $F_{(5,63)}=17.11$ ;  $p \leq 0.001$ ) with all of the collisions occurring in the scenarios at the Surry Nuclear Power Plant (Figure 22 on page 30). This is most likely because subjects typically flew below the prescribed altitude (250 ft for these scenarios) and these scenarios did have some tall structures in the flight path. Not surprisingly, the number of collisions did decrease significantly with the altitude information available on the PFD and Map display conditions ( $F_{(8,63)}=6.05$ ;  $p \leq 0.001$ ) (Figure 23 on page 30). The high number of collisions in scenario 1 most likely was due to the first waypoint. This waypoint was a tall tower not very far away from the takeoff point. Therefore, subjects may not have taken a vehicle path to this waypoint that allowed for a sufficient amount of altitude to be gained before the vehicle approached the tower and thus, the experiment may have recorded a vehicle collision with the tower several times as it was loitering over it. Recall that a collision was recorded if the sUA passed within 50 feet of an obstacle. In any case, subjects were not always able to avoid this tower and some of the other obstacles farther away from the takeoff point in the more diverse terrain scenarios.

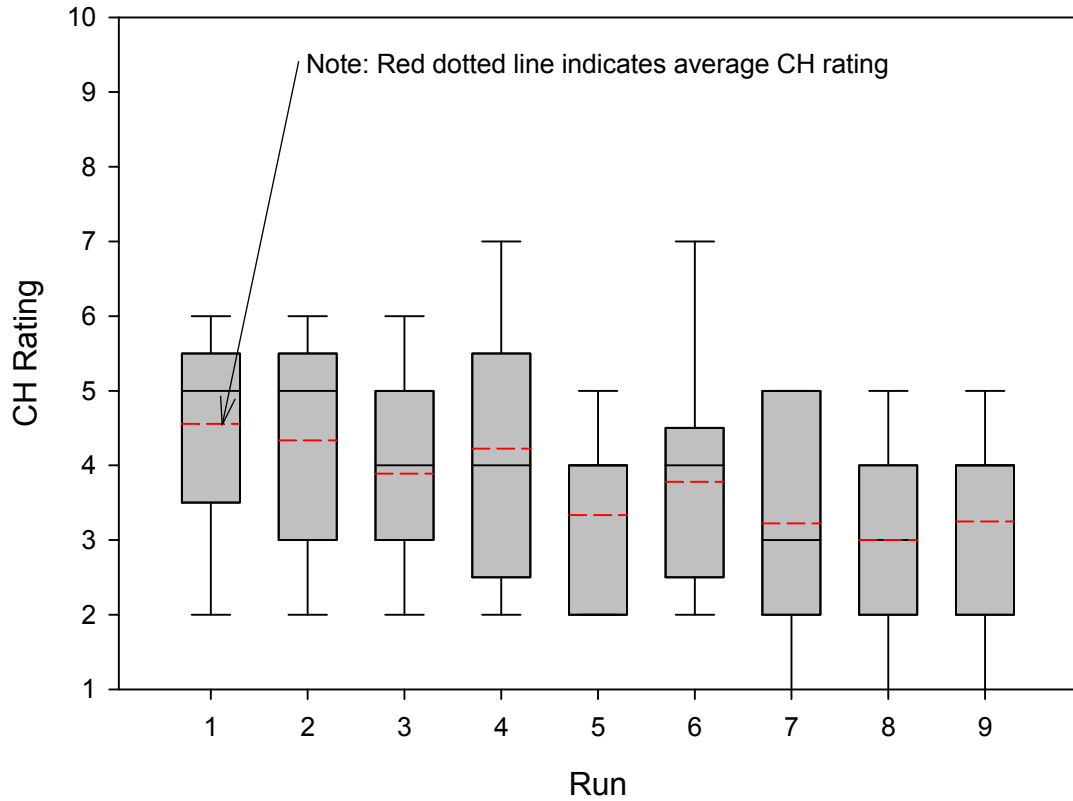

Figure 19 – CH Rating by Run Boxplot

Table 6 – Performance by Display Condition

Display Configuration	Performance (0=Poor; 100=Good) ± 1 SE
VLOS	51 ± 3.7
PFD	61 ± 4.2
Map	66 ± 3.4

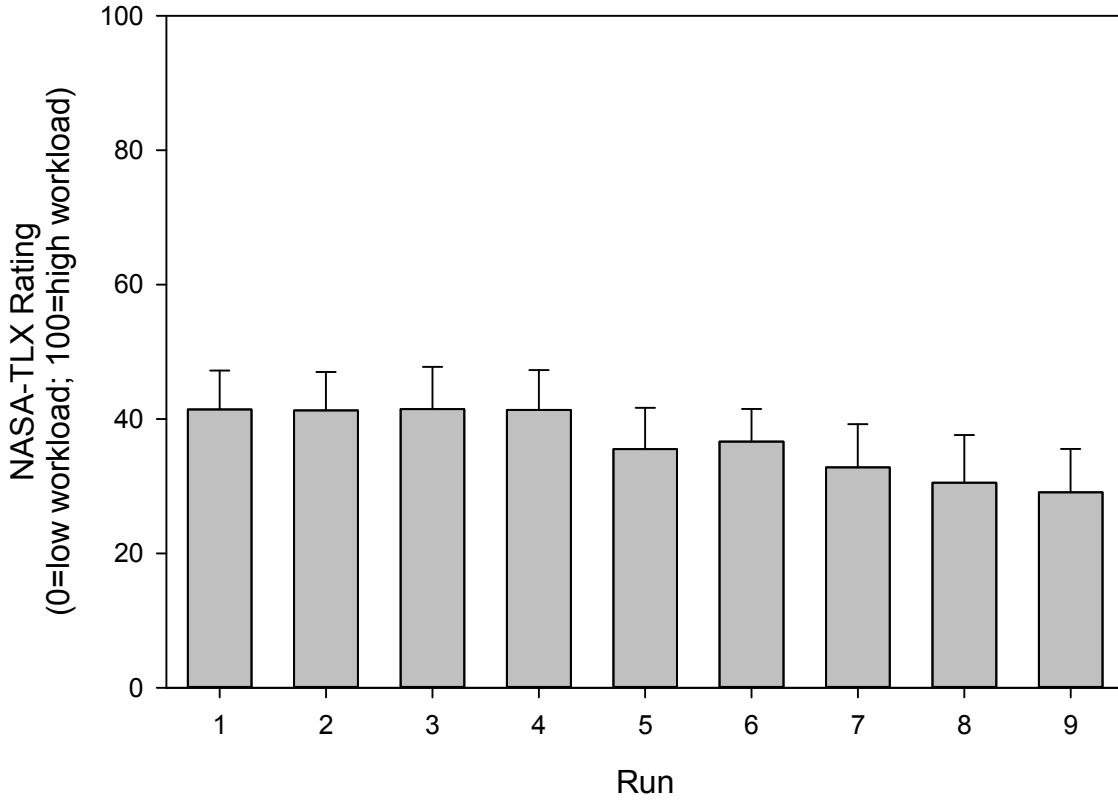

Figure 20 – NASA-TLX Rating by Run

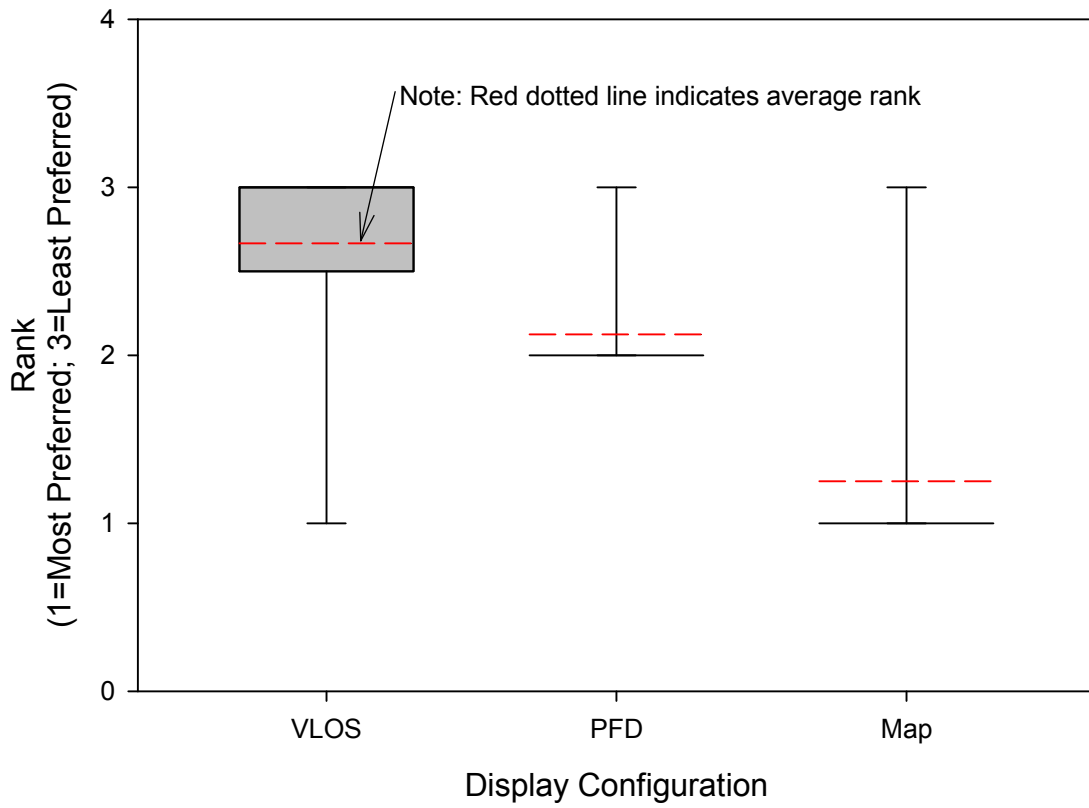

Figure 21 – Display Ranking by Display Configuration Boxplot

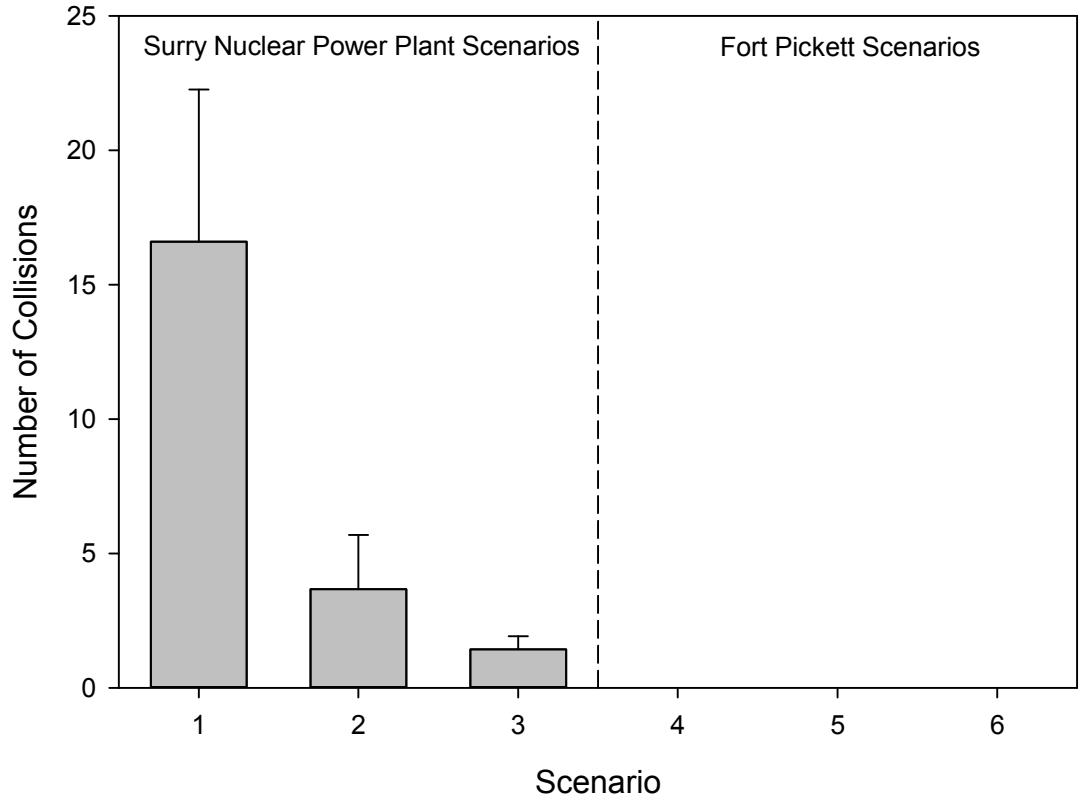

Figure 22 – Number of Collisions by Scenario

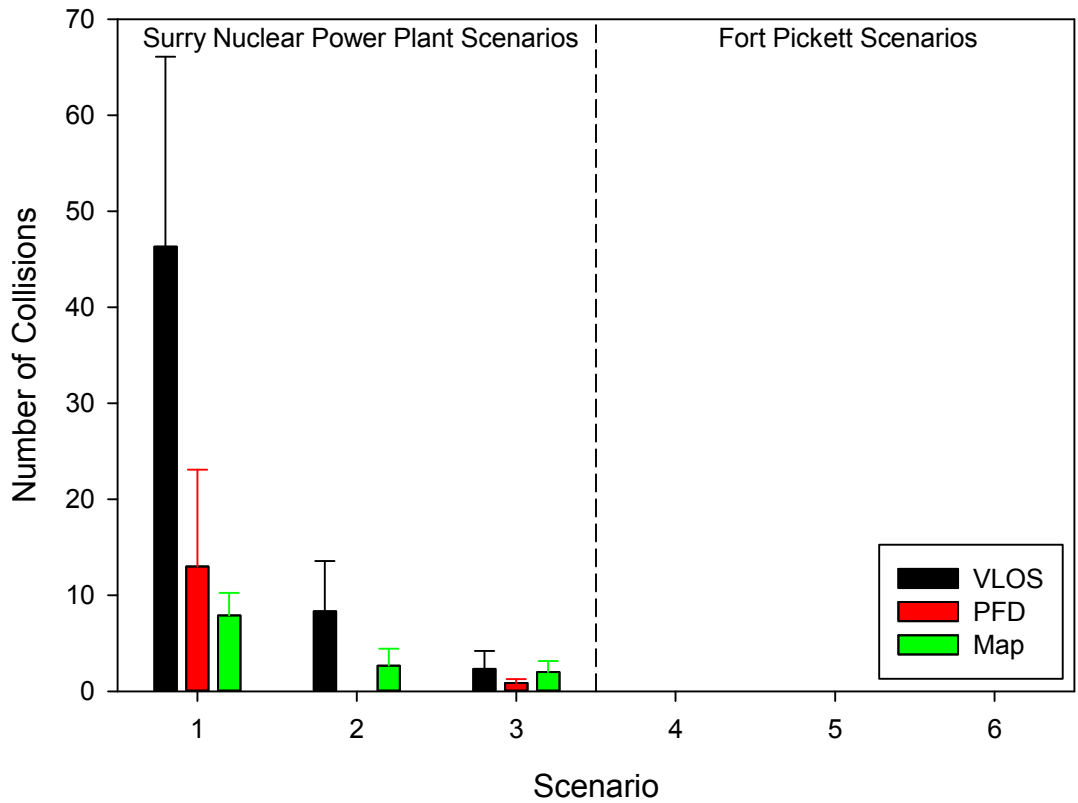

Figure 23 – Number of Collisions by Scenario and Display Configuration

### 3.1.5 Mission Tracks

There were wide discrepancies in how close to a waypoint each subject loitered ( $F_{(8,526)}=16.59$ ;  $p\leq 0.01$ ) (Figure 24 below) and how closely each maintained the given altitude ( $F_{(8,529)}=13.88$ ;  $p\leq 0.01$ ) (Figure 25 on page 32). Also, the type of pilot's license held by the subject (ATP, Private, none (RC pilot only)) influenced both the loiter area ( $F_{(4,485)}=4.211$ ;  $p\leq 0.01$ ) (Figure 26 on page 32) and the loiter altitude held (§3.1.2 and Table 4); although a degree of caution must again be considered because of the low number of subjects. It is interesting to note that the loiter area for all license types the subjects held increased with additional displays. Furthermore, if the subject held an ATP license, the loiter area increased as more information was provided to them.

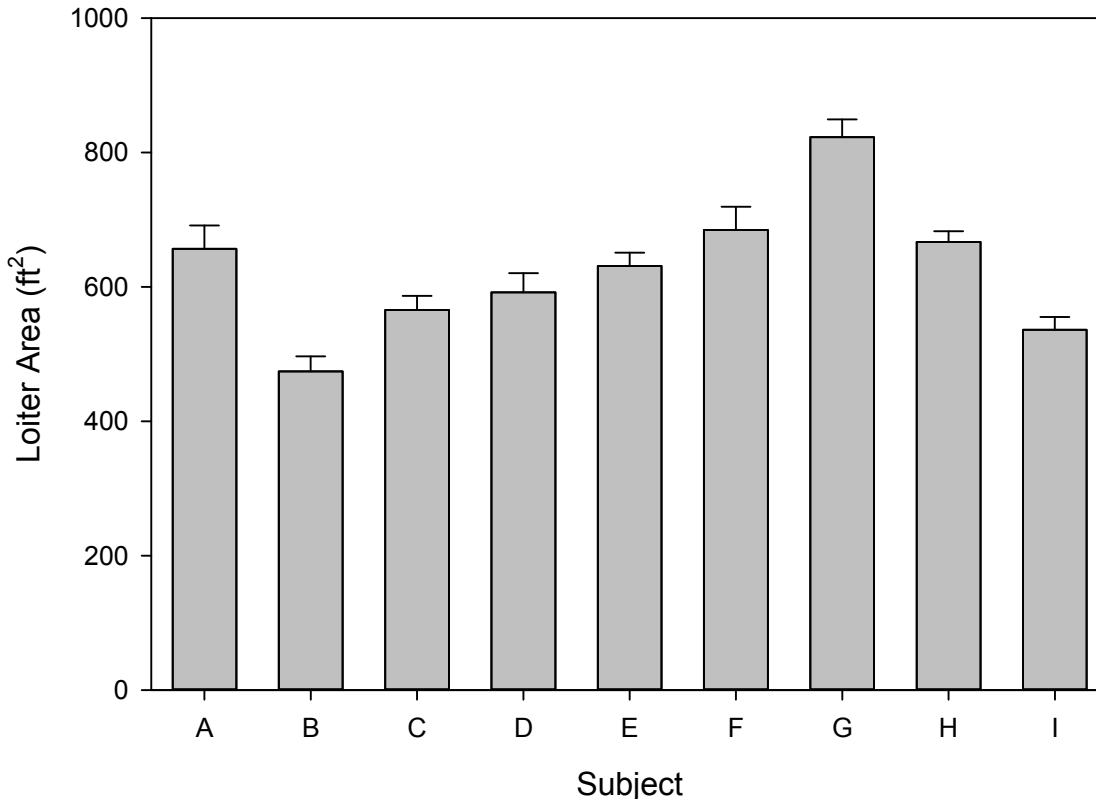

Figure 24 – Loiter Area by Subject

These differences in how the subjects flew the mission can also be seen in a subject's mission tracks for each scenario. An example of these differences can be seen in Figure 27 on page 33 and Figure 28 on page 33, which shows representative examples of the mission tracks of two different subject both flying scenario 1 with the Map display configuration. Appendix M contains the mission tracks for all subjects. While additional display information did help subjects to more accurately fly the mission, the wide variance in subject capability should be considered for the possible capabilities of potential sUAS operators.

### 3.2 Maintaining VLOS

At the end of the runs, subjects were asked the percentage of the time they lost VLOS for that particular run. VLOS for this experiment was defined to the subjects as 400 yards lateral distance and 400 feet in altitude;



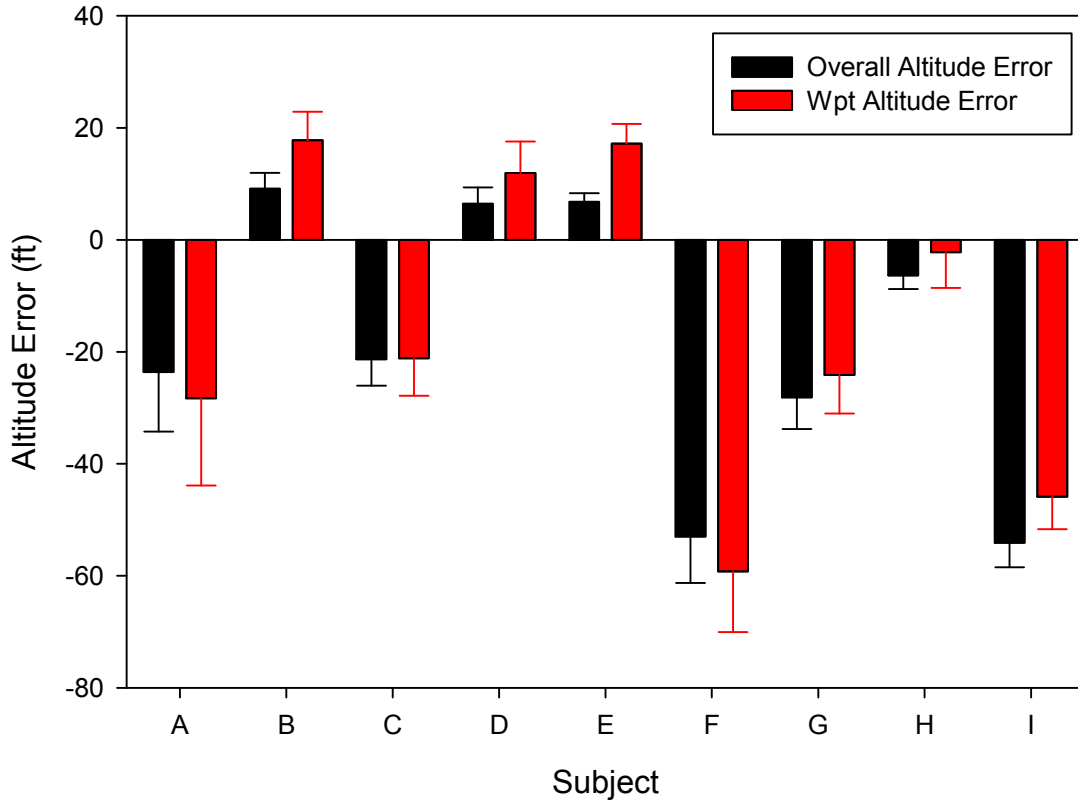

Figure 25 – Altitude Error by Subject

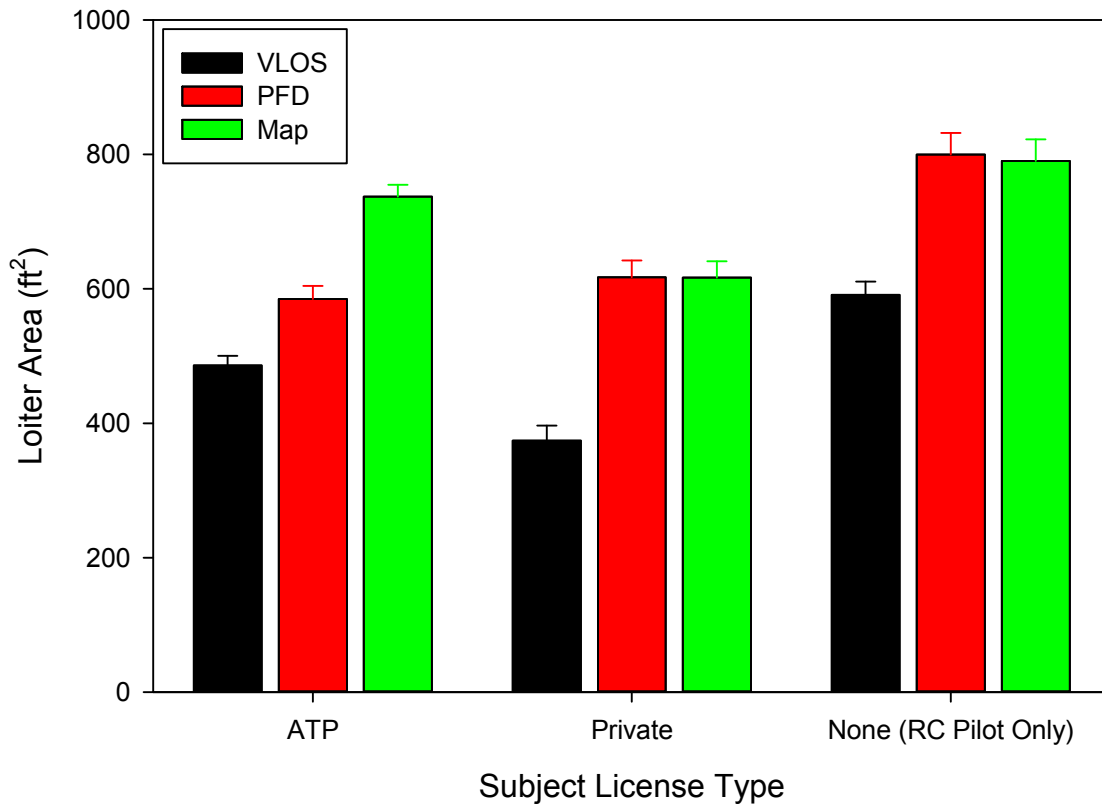

Figure 26 – Loiter Area by Subject License Type and Display Configuration

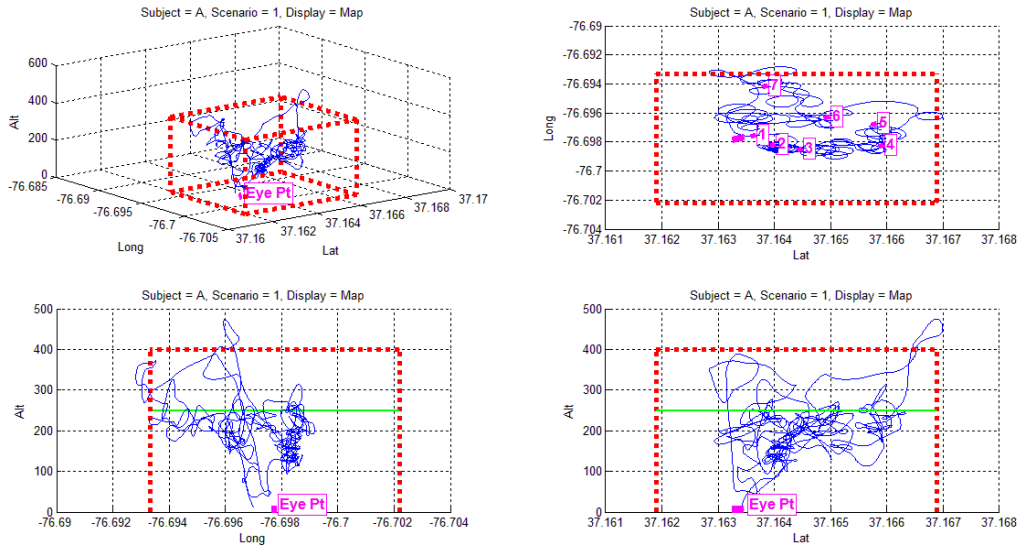

Figure 27 – Subject A Mission Track for Scenario 1, Run 3, Map Display Configuration  
 Note: Red dotted box indicates visual-line-of-sight area from the eye point and the green horizontal line indicates the prescribed altitude.

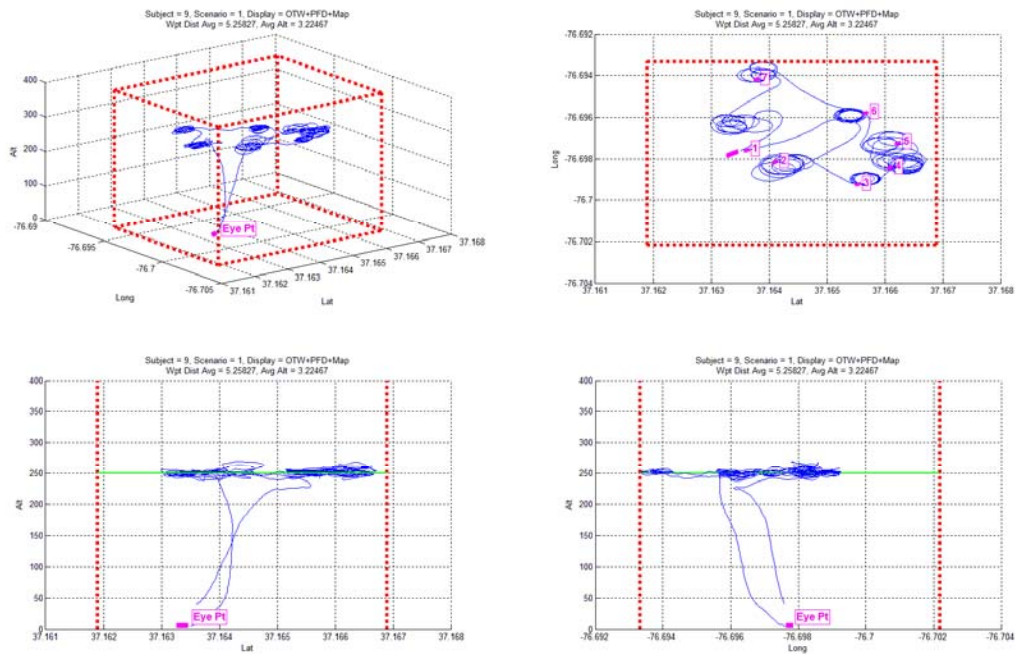

Figure 28 – Subject B Mission Track for Scenario 1, Run 13, Map Display Configuration  
 Note: Red dotted box indicates visual-line-of-sight area from the eye point and the green horizontal line indicates the prescribed altitude.

however, it is unclear from the subject responses whether they took this definition into consideration or whether they used a more literal definition of losing visual contact with their sUA at whatever distance that occurred.

Subjects reported that they lost VLOS the least with the VLOS display condition ( $F_{(2,75)}=11.35$ ;  $p \leq 0.001$ ) (Table 7 below) although the subject mission tracks indicate that they flew outside of 400 yards (yds) and 400 ft the most often with the VLOS display condition (Appendix M). This suggests that subjects were using a literal interpretation of VLOS (*i.e.*, losing actual visual contact with their sUA) in answering this question. With additional display information, the subjects were comfortable occasionally losing VLOS of the sUA. This pattern held when looking at the lateral distance and altitude at which the subjects flew the sUA (§3.2.1 and §3.2.2).

Table 7 – Subject Reported Percentage of Time VLOS is Lost by Display

Display	Subject Reported Percentage of Time VLOS is Lost $\pm$ 1 SE
VLOS	5 $\pm$ 1
PFD	25 $\pm$ 5
Map	37 $\pm$ 7

### 3.2.1 Lateral Distance

Lateral BVR distance was prescribed to be 400 yds (1200 ft) and greater from the eye point. All waypoints were located within 400 yds. The maximum distance from the eye point did increase with more runs ( $F_{(8,531)}=4.12$ ;  $p \leq 0.001$ ) (Figure 29 below), again indicating a learning effect for flying the sUAS. The distance also increased with additional display information ( $F_{(2,532)}=219.76$ ;  $p \leq 0.001$ ) (Figure 30 on page 35) indicating that with the additional

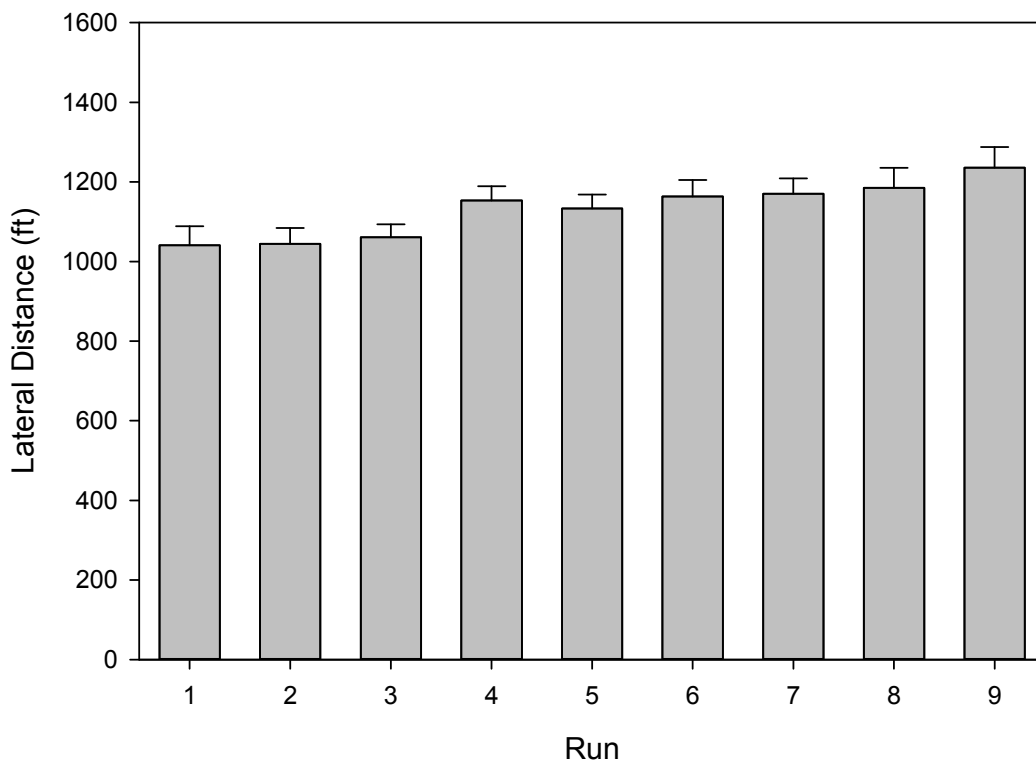

Figure 29 – Maximum Lateral Distance from Eye Point Average by Run

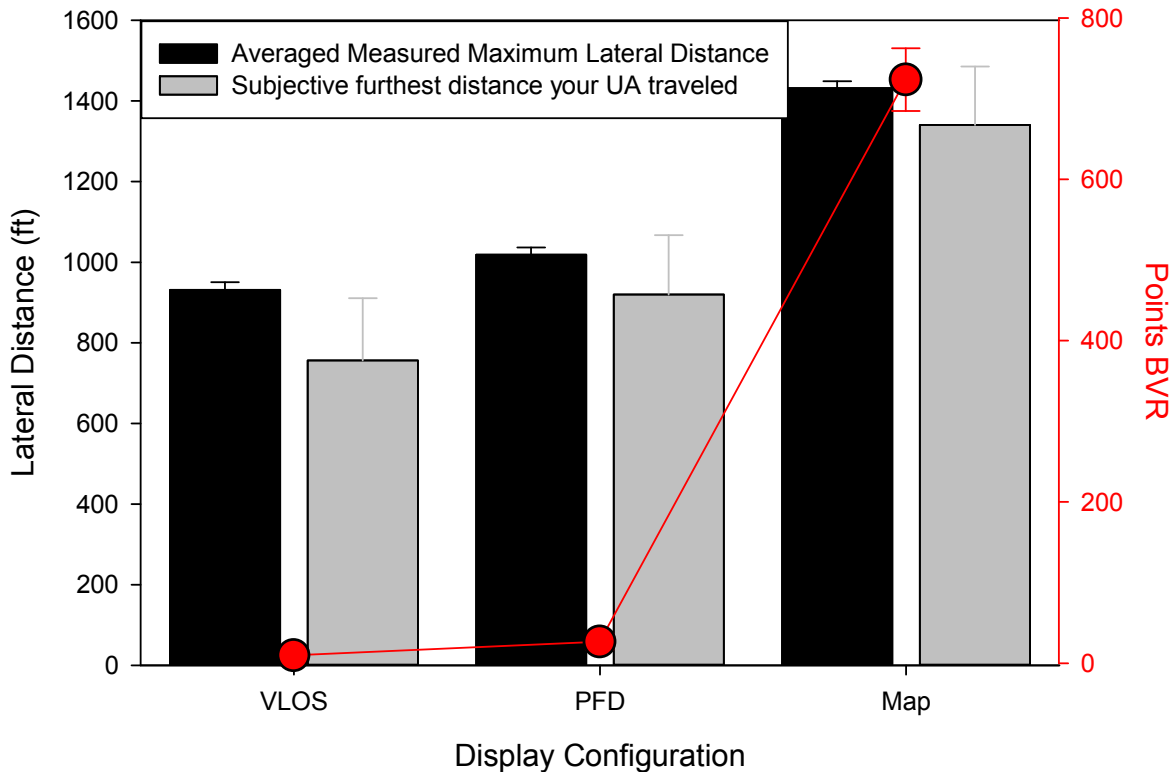

Figure 30 – Lateral Distance and Points BVR from Eye Point by Display Configuration

information, subjects were more confident in knowing the location and attitude of the sUA. There was also a big jump in distance with the inclusion of the Map display, which might also indicate that the waypoints may have been out farther than subjects originally thought. Not surprisingly, less time was spent BVR with the VLOS and PFD displays than with the Map display ( $F_{(2,532)}=288.63$ ;  $p \leq 0.001$ ) (Figure 30 above) because without the Map display, subjects were more apt to fly closer to their eye point where they could better determine the relative heading of their sUA to the loiter point. This pattern also held when the subjects responded to the question regarding the “furthest distance (in yards) that your aircraft traveled in relation to your standing point?” ( $F_{(2,12)}=4.11$ ;  $p=0.044$ ) (Figure 30 above). With the additional display information, the subjects thought they went farther from the eye point.

### 3.2.2 Altitude

Altitude BVR was defined as being higher than 400 ft. As with the lateral distance, the amount of time spent above 400 ft was greatest with the Map display (Figure 31 on page 36) than with the PFD or VLOS display conditions ( $F_{2,532}=5.95$ ;  $p=0.003$ ). This pattern also held when looking at the maximum altitude (Figure 31 on page 36), where the maximum altitude reached was higher for the PFD and Map displays than for the VLOS display condition ( $F_{(2,532)}=5.62$ ;  $p=0.004$ ). The VLOS display condition does not provide altitude information and overall provides the least amount of information about the attitude and position of the aircraft so the altitudes were the lowest, whereas the Map display condition provides more sUA positional information that is useful if the vehicle goes BVR. Some subjects also suggested the use of an audible tone (or alert) that may be useful in advising the pilot that the sUA is not maintaining the desired altitude (high pitch for climbing above; low pitch for descending below).

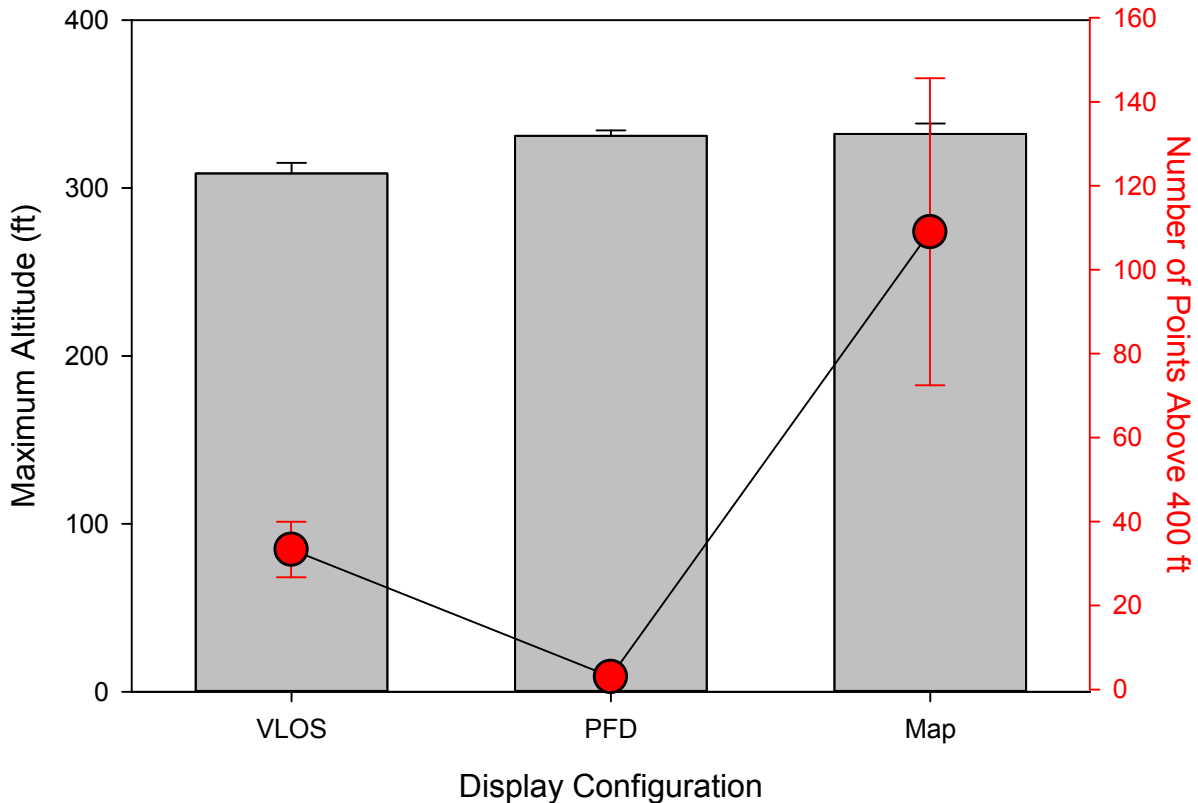

Figure 31 – Maximum Altitude and Points Above 400 ft Averaged by Display Configuration

### 3.3 Interaction with ATC and Manned Aircraft

#### 3.3.1 Interaction with Manned Aircraft

Manned aircraft flew within visual range of the sUAS operator for each of the runs. In all cases, the manned aircraft flew in a straight line no closer than 0.25 nm. Also, the sound of the manned aircraft could be heard before it was visible. Some of the manned aircraft were announced by ATC while others were not. For those announced by ATC, subjects were asked to report back to ATC when the aircraft was within sight.

At the end of the run, subjects were asked how many manned aircraft they noticed. This included the ones announced by ATC and those that were not. In general, subjects did not notice all the aircraft that flew within their line of sight and they missed more with the Map display condition ( $\chi^2(2)=9.59$ ;  $p=0.009$ ) (Figure 32 on page 37). However, the number of manned aircraft that subjects noticed may be tempered by subjects assuming that the vast majority of these aircraft were far enough away such that they could essentially ignore these manned aircraft and thus did not bother to look for these aircraft. The time it took a subject to notice an aircraft did not rise appreciably with the additional display information even though more aircraft were missed.

Lastly, subjects felt that they were able to better avoid manned aircraft with more display information available to them ( $F_{(2,13)}=4.98$ ;  $p=0.025$ ) (Table 8 on page 37).

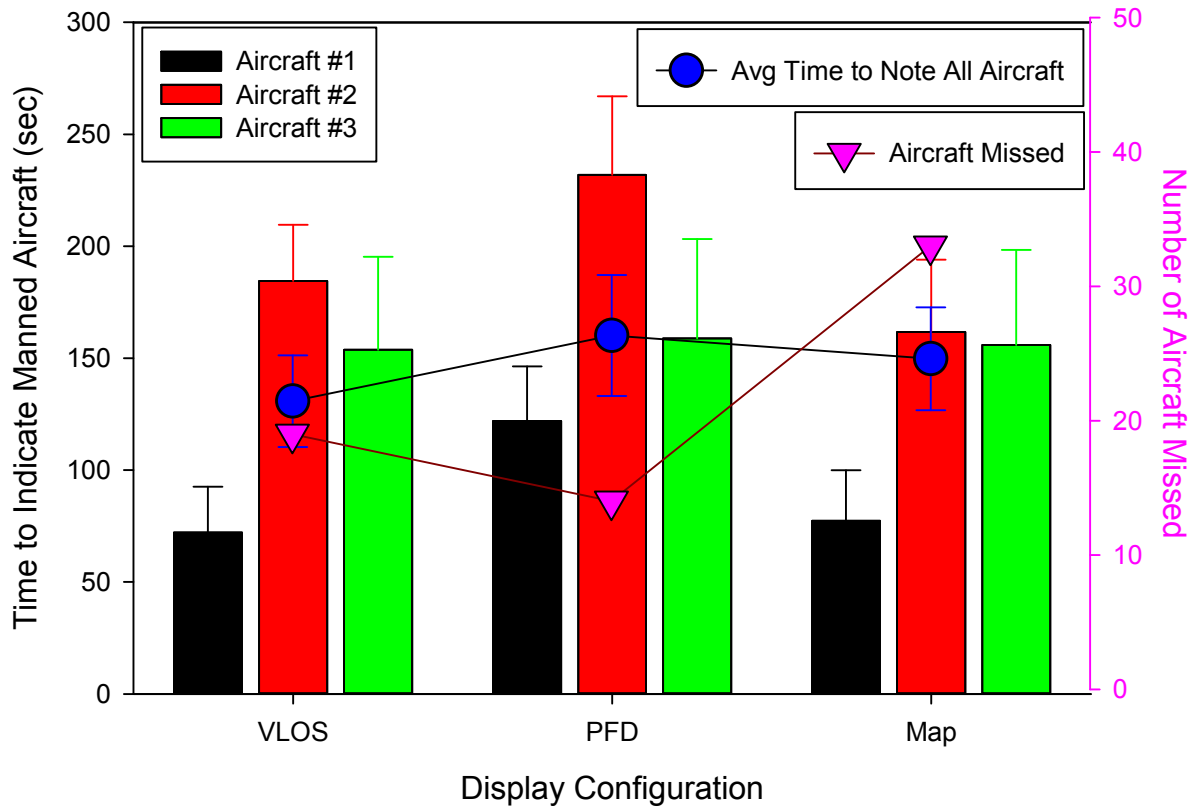

Figure 32 – Number of Aircraft Missed and Average Time to Spot Aircraft by Display Configuration

Table 8 – Subjects’ Perceived Ability to Avoid Manned Aircraft by Display

Display Configuration	Avoid Manned AC % (0=low; 100=high) ± 1 SE
VLOS	41 ± 9
PFD	61 ± 16
Map	79 ± 5

With regards to spotting other traffic in the area, many subjects indicated that ADS-B (Automatic Dependent Surveillance – Broadcast) In (and/or other forms of traffic information such as TIS-B) may be helpful in providing the sUA pilot situation awareness of traffic in the area especially when using the PFD or Map displays. This is most likely due to the sUA pilot’s head down time when using these display configurations.

### 3.3.2 Interaction with ATC and MC

In general, subjects thought that they replied back to ATC fairly quickly (in a little over 4 sec) and they thought that ATC did not have to repeat their commands (only once was ATC asked to repeat itself). However, subjects did not always contact ATC or MC when asked to by the experiment protocol. Subjects did not always report that they were established at a waypoint to MC. Also, the initial contact with ATC or MC for granting takeoff or once airborne did not always occur. Furthermore, a great deal of the interactions with ATC contained non-standard verbiage,

especially if the sUAS pilot had limited time as pilot-in-command of a manned aircraft although this may be tempered by some of the non-standard verbiage ATC employed.

## **4 Discussion**

This research aimed at evaluating the human system integration of a sUAS GCS and its pilot. The main objectives of this experiment were to validate the sUAS simulator/simulation, determine the ability of the sUAS to avoid obstacles while operating under VLOS conditions, determine whether the GCS met normal NAS operational requirements for pilot/ATC communications, and to identify any potential human system integration deficiencies that could hinder the integration of sUAS VLOS missions within uncontrolled and controlled airspace. To meet the objectives of this research experiment, nine male pilot subjects flew a FASER sUA model with a hand-held control unit in the TES lab using three different sets of display configurations, which consisted of the VLOS only display set, the PFD display set (VLOS + PFD), and the Map display set (VLOS + PFD + Moving Map). The subject's mission was to successfully go from one waypoint to another to collect data at the Surry Nuclear Power Plant and at Fort Pickett Blackstone Army Airfield while safely avoiding other aircraft and obstacles under VLOS operations. There were 3 sets of runs for each display configuration set, which were blocked; however, the order of these display sets was randomized.

### **4.1 Hypothesis 1: sUAS Simulator Realism**

The first hypothesis – the sUAS simulator will provide a valid representation of flying a sUAS in VLOS operations – is true. In general, the subjects were able to fly the sUA simulation in the TES although they reported some decrease in situation awareness and increase in workload compared to real-world sUAS flying.

### **4.2 Hypothesis 2: Obstacle Avoidance**

The second hypothesis – the sUAS pilot will effectively operate the unmanned aircraft from its GCS while avoiding simulated ground-based obstacles that present the potential for conflict – is not true; however, the failure to confirm this hypothesis may have more to do with scenario development and visual scene realism. During this experiment, collisions only occurred for the Surry Nuclear Power Plant scenarios, especially for a particular scenario that required subjects to avoid a nearby tower while climbing to altitude. Accurately judging the vehicle position and the object heights in a two-dimensional display may have been the primary contributing factor to these collisions.

### **4.3 Hypothesis 3: Manned-Aircraft Avoidance**

The third hypothesis – GCS voice communications with ATC in a simulated Class D airspace operational environment will be sufficient to avoid manned aircraft – is indeterminate for avoiding manned aircraft and for appropriate communication with ATC. Subjects avoided all manned aircraft but the paths of these aircraft did not bring them in much danger of colliding with the sUA. However, subjects were better able to see other aircraft when using the VLOS display configuration. Subjects did not report spotting several manned aircraft announced by ATC, although the subjects may not have been actively looking for the announced manned aircraft because none of them came within close proximity of their sUA, and the average time to indicate those manned-aircraft spotted was well over a minute. With regards to communicating with ATC, subjects did not always contact ATC when appropriate as directed to in the experiment protocol for the mission start.



#### **4.4 Hypothesis 4: Human System Integration Deficiencies**

The fourth hypothesis – no human system integration deficiencies that could hinder initial integration of sUAS VLOS mission, within Class D airspace, will be identified – is indeterminate. For the most part, subjects were able to complete the missions safely. However, some collisions did occur with ground structures as defined by the experiment protocol, and they did not always spot the manned aircraft in the vicinity nor did they always communicate with ATC as requested in the experiment protocol. Subjects also flew outside of visual-line-of-sight, as defined by the experiment protocol, on occasion although they may have maintained visual sight of the sUA past the distance defined by the experiment protocol. Subjects were also not able to always maintain the prescribed altitude. Their average altitude error was smaller with the Map display configuration; however, the subjects' were more likely to go beyond visual range with the Map display configuration because of the positional information it afforded.

#### **4.5 Hypothesis 5: PFD Need**

The fifth hypothesis – the PFD display will be required to adhere to ATC and MC commands – is indeterminate for the ATC commands and for the MC commands. This experiment did not require many communications with ATC and MC where the presence of a PFD may affect command adherence. However, subjects did not always contact ATC for takeoff or once airborne as directed by the experiment protocol, nor did they always contact MC once established over a waypoint as directed by the experiment protocol. These communication deficiencies do not directly impact the need of a PFD for adherence to ATC and MC commands but these communication deficiencies may indicate that some training or clear expectations in this area would be beneficial. In any case, subjects were better able to fly the missions with the PFD and Map display conditions. With the PFD, they were more likely to loiter around the waypoint at the appropriate altitude. This suggests that the PFD may be beneficial for adhering to ATC altitude commands.

#### **4.6 Hypothesis 6: Map Display Configuration Preference**

The sixth hypothesis – the Map display will be preferred – is true. Subjects preferred having the Map display configuration. Furthermore, the map display configuration allowed the pilots to complete the mission objectives with less workload, at the expense of having better situation awareness of other aircraft, due to more head-down time observing the GCS displays. In any case, the subjects had far better situation awareness of the sUA position, altitude, airspeed and location over the ground and mission track using the Map display configuration.

### **5 Conclusion**

sUA pilots for sUAS VLOS operations are able to better loiter over defined waypoints at a prescribed altitude with both a PFD and moving map display available to them. They have improved situation awareness of their vehicle in space, although their awareness of other aircraft in the area is diminished. ADS-B In (and/or other forms of traffic information such as TIS-B (Traffic Information Service – Broadcast)) may be helpful in remedying this. In order to alleviate the possibility of visually losing sight of their sUA while briefly heads down, strobe lights on the sUA may be helpful although some subjects indicated that they may not be very useful in bright daylight.

### **6 Recommendations**

It appears from the conclusions above that the best way to integrate the type of scenarios used in this simulation into the NAS would be to provide the pilot with both a PFD and moving

map display to fly the mission and to remain within the VLOS airspace (within 400 yds, at or below 400 ft. AGL) while an observer stands watch for other aircraft in the area and advises the pilot of the other aircraft's location, altitude and direction of flight (Dolgov, Marshall, Davis, Wierzbanski, & Hudon, 2012). This would require a two-person team. Additionally, an audio altitude alerting system and a depiction of traffic information on the moving map display could enhance the pilot's situation awareness while flying the mission.

Before the recommendation of including an observer becomes a requirement for sUAS VLOS operations, additional research into whether this would actually increase the safety of flight needs to be conducted. Furthermore, optimizing the presentation formats of the information on the PFD and moving map display needs to be investigated. The above experiment used standard manned aircraft displays. The unique flying environment of VLOS operations of sUAS may require a different presentation of the information in order to maximize its effectiveness.

Lastly, many sUAS can fly both VLOS and BVR operations, sometimes within the same flight. Therefore, additional research should be conducted on sUAS BVR GCS operations in order to define the GCS requirements for sUAS.

## References

- Public Law 112-95 H.R. 658 (112th): FAA Modernation and Reform Act 2012, 112th Congress pp. 72-78 § 331-336 (2012).
- Byers, J. C., Bittner, A. C., & Hill, S. G. (1989). Traditional and Raw Task Load Index (TLX) Correlations: Are Paired Comparisons Necessary? *Advances in Industrial Ergonomics and Safety*, 481-485.
- Cooper, G. E., & Harper, R. P. (1969). The Use of Pilot Rating in the Evaluation of Aircraft Handling Qualities (pp. 52): AGARD.
- Corcoran, M. (2013, 24 May 2013 at 8:09am AEST). Drones Set for Commercial Take-Off. Retrieved December 27, 2013, from <http://www.abc.net.au/news/2013-03-01/drones-set-for-large-scale-commercial-take-off/4546556>
- Dolgov, I., Marshall, D., Davis, D., Wierzbanski, T., & Hudon, B. (2012). Final Report of the Evaluation of the Safety of Small Unmanned Aircraft System (sUAS) Operations in the National Airspace System (NAS) at Night (pp. 61). New Mexico State University: New Mexico State University.
- Federal Aviation Administration. (2012). *Integration of Unmanned Aircraft Systems into the National Airspace System: Concept of Operations, v2.0*. Washington, DC: U.S. Government Printing Office.
- Garcia, Z. (2013). What Flies When it Comes to Drone Laws Across the Globe. *The Missouri Drone Journalism Program*. Retrieved from The Missouri Drone Journalism Program website: <http://www.missouridronejournalism.com/2013/04/what-flies-when-it-comes-to-drone-laws-across-the-globe/>
- Harper, R. P., & Cooper, G. E. (1986). Handling Qualities and Pilot Evaluation (Wright Brothers Lecture in Aeronautics). *Journal of Guidance, Control, and Dynamics*, 9(6), 515-529.
- Hart, S. G., & Staveland, L. E. (1988). Development of a NASA-TLX (Task Load Index): Results of Empirical and Theoretical Research. In P. S. Hancock & N. Meshkati (Eds.), *Human Mental Workload* (pp. 139-183). Amsterdam: Elsevier Science Publishers B. V.
- IBM. (2013). IBM SPSS Statistics Version 22 (Version 22.0.0.0): IBM.
- Jewell, J. (2010). *2010-2011 UAS Yearbook-UAS: The Global Perspective* (8th ed.): Blyenburgh & Co.
- McAdaragh, R., Comstock, J. R., Ghatas, R., Burdette, D., & Trujillo, A. (2014). *The Need for Research to Support the Expedient Development of Standards, Guidelines and Procedures for the Integration of Small Unmanned Aircraft Systems into the National Airspace System*. (NASA/TM-2014-218253). NASA Langley Research Center: NASA.
- Murch, A. (2012, 26 August 2010). UAV Research Group. Retrieved December 2013, 2013, from <http://www.uav.aem.umn.edu/>
- NASA. (n.d., February 22, 2013). UAS Inetgration in the NAS. Retrieved December 27, 2013, from [http://www.aeronautics.nasa.gov/isrp/uas/research\\_activities.htm](http://www.aeronautics.nasa.gov/isrp/uas/research_activities.htm)
- Owens, D. B., Cox, D. E., & Morelli, E. A. (2006). *Development of a Low-Cost Sub-Scale Aircraft for Flight Research: The FASER Project*. AIAA Paper 2006-3306. Paper presented at the 25th AIAA Aerodynamic Measurement Technology and Ground Testing Conference, San Francisco, CA.
- PRI's The World. (2013). Civilian Companies Eye Big Potential for Domestic Drone Use. *PRI's The World*. Retrieved from PRI's The World website: <http://www.pri.org/stories/2013-01-24/civilian-companies-eye-big-potential-domestic-drone-use>
- RTCA. (2010). *Terms of Reference: Special Committe (SC) 203 - Minimum Performance Standards for Unmanned Aircraft Systems, Revision 2*. (RTCA Paper No. 065-10/PMC-790). Retrieved from <http://www.rtca.org/Files/Terms%20of%20Reference/SC-203%20Terms%20of%20Reference%20-%20Rev.%202%20Apr%202010.pdf>.
- RTCA. (2013). *Operational and Functional Requirements and Safety Objectives*. (DO-344).

- Trujillo, A. C. (2009a). *How Electronic Questionnaire Formats Affect Scaled Responses*. Paper presented at the 2009 (15th) International Symposium on Aviation Psychology, Dayton, OH.
- Trujillo, A. C. (2009b). *Paper to Electronic Questionnaires: Effects on Structured Questionnaire Forms*. Paper presented at the HCI International 2009, San Diego, CA.

# Appendix A: Subject Background Questionnaire

## Pilot Background Questionnaire

Subject #: \_\_\_\_\_

Date:

**Please fill in the blanks or circle the appropriate response**

1. What pilot certifications do you have?

- A) Private
- B) Commercial
- C) Airline Transport Pilot (ATP)
- D) None

2. What pilot ratings do you have?

- A) SEL
- B) MEL
- C) Instrument
- D) CFII
- E) Helicopter
- F) None

3. Top four aircraft you have flown (by hours)

- 1. \_\_\_\_\_, \_\_\_\_\_ Hours
- 2. \_\_\_\_\_, \_\_\_\_\_ Hours
- 3. \_\_\_\_\_, \_\_\_\_\_ Hours
- 4. \_\_\_\_\_, \_\_\_\_\_ Hours

4. How many flight hours and years of experience do you have?

\_\_\_\_\_ Flight Hours  
\_\_\_\_\_ Years

5. Do you have experience flying in a mixed operations environment (unmanned aircraft and general/commercial aircraft in same airspace)?

- A) Yes
- B) No

6. Have you had any experience operating an unmanned aircraft (or remotely controlled aircraft) before today?

- A) Yes
- B) No

If **yes**, was your experience in a simulation environment (comparable to this experiment) or in real life? And how many hours/years?

A) Simulation Environment:  
\_\_\_\_\_ Hours  
\_\_\_\_\_ Years

B) Real Life:  
\_\_\_\_\_ Hours  
\_\_\_\_\_ Years

7. What types of UAS have you flown?

---

---

---

---

8. What type of training, specific to UAS, did you receive prior to today?

---

---

---

---

9. Do you think that the training you received was sufficient to fly the UAS in today's simulation?

- A) Yes
- B) No

## Appendix B: Surry Nuclear Power Plant Data Run Paper Maps

Table B-1 – Eye Point, sUAS Starting Position, and Other Traffic for Scenario 1  
(Surry Nuclear Power Plant Scenario 1)

	Eye Point			
	Latitude	Longitude	Altitude	Heading
	37.163357	-76.697753	1.83 meters	22.5
	sUAS Starting Position			
	Latitude	Longitude	Altitude	Heading
	37.163543	-76.697622	12.19 meters	22.5
Other Traffic Timing				
	Start Time (sec)	End Time (sec)	Velocity (kts)	
Other Traffic 1	120	240	150	
Other Traffic 2	310	457.540984	122	
Other Traffic 3	530	680	120	
Other Traffic Flight Paths				
	Latitude	Longitude	Altitude (ft)	Heading
Other Traffic 1	37.221	-76.6732	457.2	156
Other Traffic 2	37.149	-76.6298	152.4	327
Other Traffic 3	37.206	-76.7120	304.8	126





Figure B-1: Map of Waypoints for Scenario 1  
(Surry Nuclear Power Plant Scenario 1)

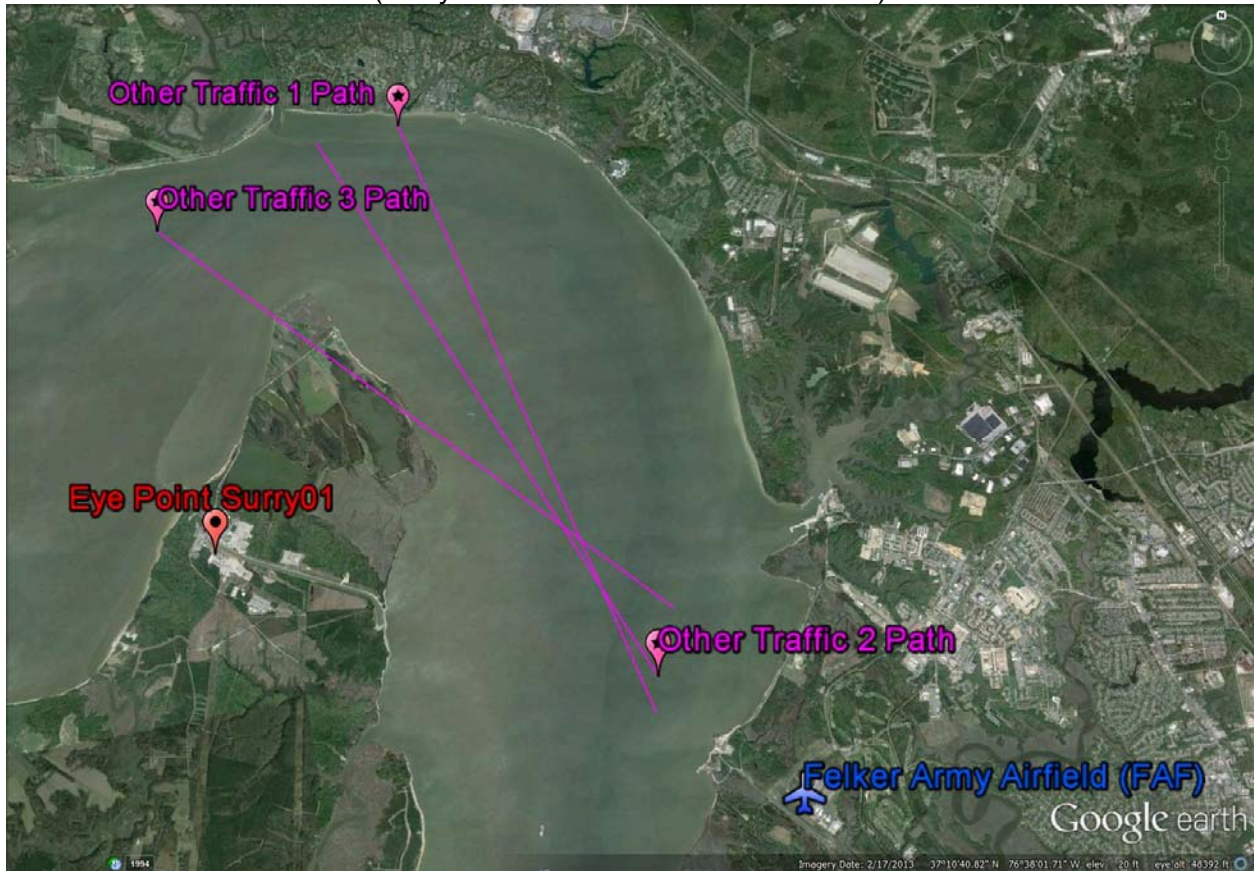

Figure B-2: Map of Other Aircraft Paths for Scenario 1  
(Surry Nuclear Power Plant Scenario 1)



Table B-2 – Eye Point, sUAS Starting Position, and Other Traffic for Scenario 2  
(Surry Nuclear Power Plant Scenario 2)

	Eye Point			
	Latitude	Longitude	Altitude	Heading
	37.165294	-76.694769	12.19 meters	270
	sUAS Starting Position			
	Latitude	Longitude	Altitude	Heading
	37.165294	-76.694769	12.19 meters	270
Other Traffic Timing				
	Start Time (sec)	End Time (sec)	Velocity (kts)	
Other Traffic 1	240	440	90	
Other Traffic Flight Paths				
	Latitude	Longitude	Altitude (ft)	Heading
Other Traffic 1	37.207	-76.6774	365.76	215



Figure B-3: Map of Waypoints for Scenario 2  
(Surry Nuclear Power Plant Scenario 2)



Figure B-4: Map of Other Aircraft Paths or Scenario 2  
(Surry Nuclear Power Plant Scenario 2)



Table B-3 – Eye Point, sUAS Starting Position, and Other Traffic for Scenario 3  
(Surry Nuclear Power Plant Scenario 3)

	Eye Point			
	Latitude	Longitude	Altitude	Heading
	37.165594	-76.700203	1.83 meters	70
	sUAS Starting Position			
	Latitude	Longitude	Altitude	Heading
	37.165560	-76.699866	12.19 meters	70
Other Traffic Timing				
	Start Time (sec)	End Time (sec)	Velocity (kts)	
Other Traffic 1	45	145	180	
Other Traffic 2	230	430	90	
Other Traffic 3	530	677.540984	122	
Other Traffic Flight Paths				
	Latitude	Longitude	Altitude (ft)	Heading
Other Traffic 1	37.146	-76.6519	609.60	310
Other Traffic 2	37.161	-76.6454	213.36	294
Other Traffic 3	37.146	-76.6519	304.80	310

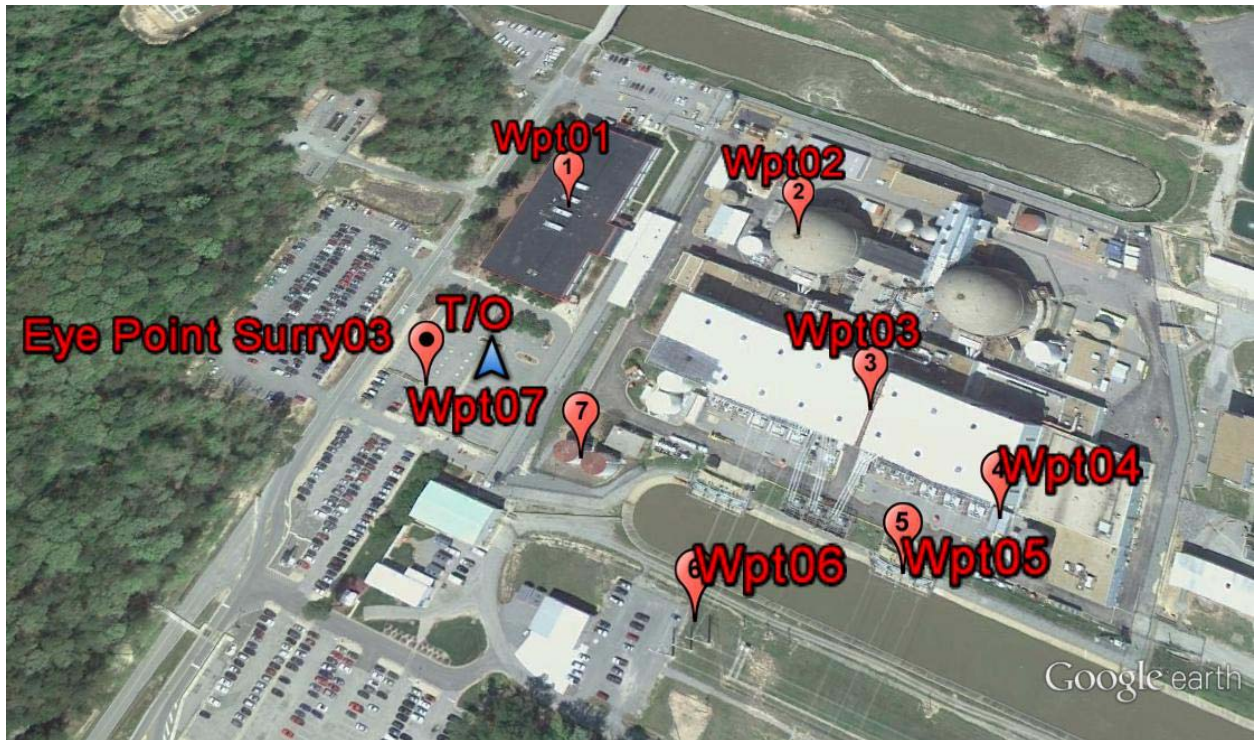

Figure B-5: Map of Waypoints for Scenario 3  
(Surry Nuclear Power Plant Scenario 3)

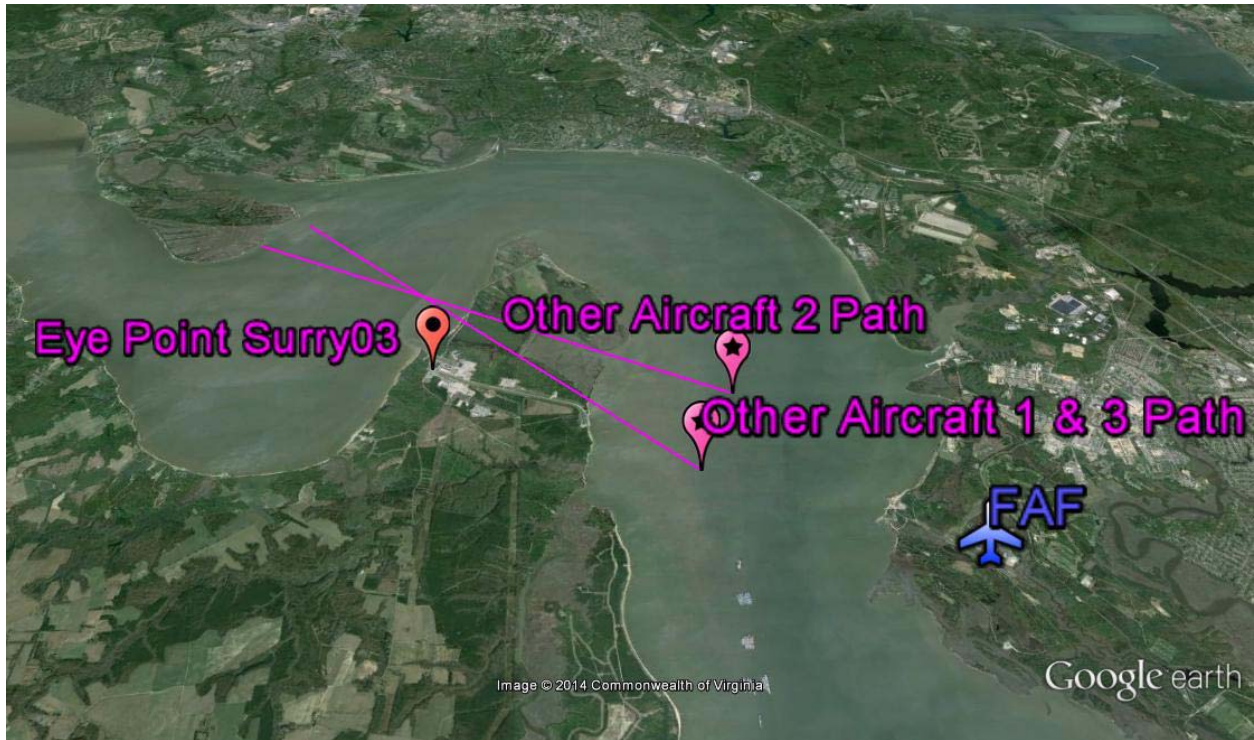

Figure B-6: Map of Other Aircraft Paths for Scenario 3  
(Surry Nuclear Power Plant Scenario 3)



## Appendix C: Fort Pickett Data Run Paper Maps

Table C-1 – Eye Point, sUAS Starting Position, and Other Traffic for Scenario 4  
(Fort Pickett Blackstone Army Airfield Scenario 1)

	Eye Point			
	Latitude	Longitude	Altitude	Heading
	37.0722148	-77.94992420	1.83 meters	90
	sUAS Starting Position			
	Latitude	Longitude	Altitude	Heading
	37.072475	-77.9497650	12.19 meters	90
Other Traffic Timing				
	Start Time (sec)	End Time (sec)	Velocity (kts)	
Other Traffic 1	180	380	90	
Other Traffic Flight Paths				
	Latitude	Longitude	Altitude (ft)	Heading
Other Traffic 1	37.102	-77.9121	182.88	214

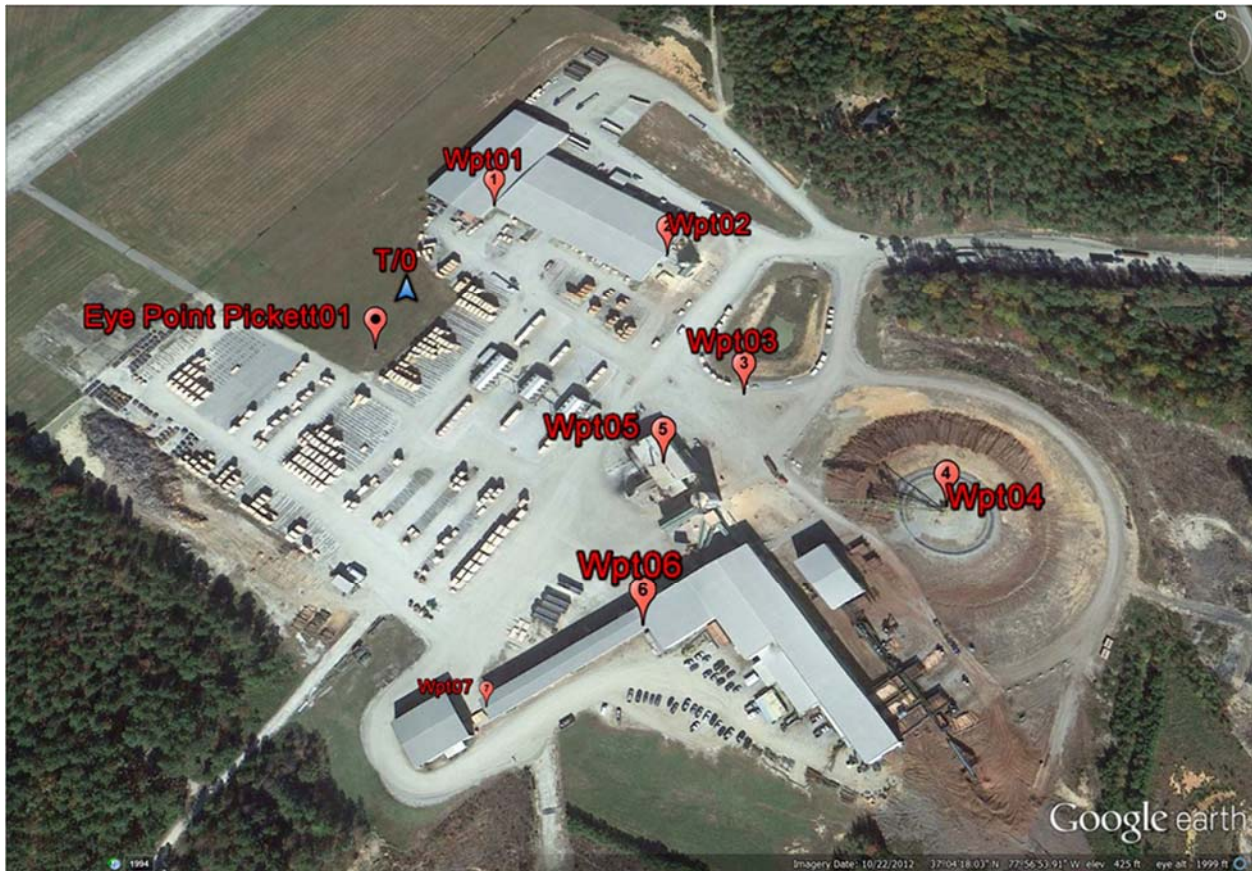

Figure C-1: Map of Waypoints for Scenario 4  
(Fort Pickett Blackstone Army Airfield Scenario 1)

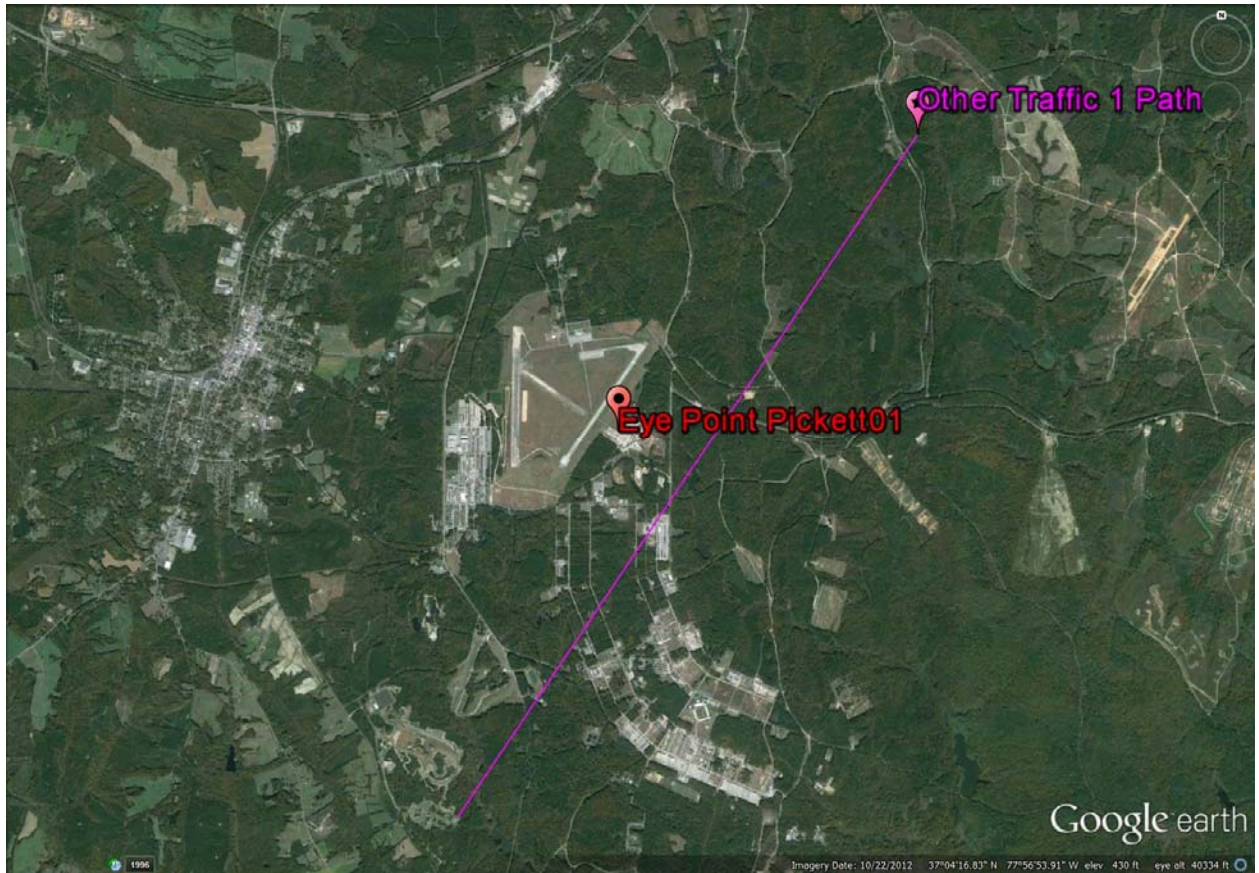

Figure C-2: Map of Other Aircraft Paths for Scenario 4  
(Fort Pickett Blackstone Army Airfield Scenario 1)



Table C-2 – Eye Point, sUAS Starting Position, and Other Traffic for Scenario 5  
(Fort Pickett Blackstone Army Airfield Scenario 2)

	Eye Point			
	Latitude	Longitude	Altitude	Heading
	37.0734197	-77.96291721	4.1 meters	280
	sUAS Starting Position			
	Latitude	Longitude	Altitude	Heading
	37.073314	-77.9632051	12.19 meters	280
Other Traffic Timing				
	Start Time (sec)	End Time (sec)	Velocity (kts)	
Other Traffic 1	20	167.540984	122	
Other Traffic 2	220	320	180	
Other Traffic 3	420	567.540984	122	
Other Traffic 4	620	820	90	
Other Traffic Flight Paths				
	Latitude	Longitude	Altitude (ft)	Heading
Other Traffic 1	37.107	-78.0004	213.36	160
Other Traffic 2	37.075	-77.9107	609.60	270
Other Traffic 3	37.107	-78.0004	213.36	160
Other Traffic 4	37.049	-78.0062	243.84	43



Figure C-3: Map of Waypoints for Scenario 5  
(Fort Pickett Blackstone Army Airfield Scenario 2)



Figure C-4: Map of Other Aircraft Paths for Scenario 5  
(Fort Pickett Blackstone Army Airfield Scenario 2)



Table C-3 – Eye Point, sUAS Starting Position, and Other Traffic for Scenario 6  
(Fort Pickett Blackstone Army Airfield Scenario 3)

	Eye Point			
	Latitude	Longitude	Altitude	Heading
	37.0663518	-77.95896875	3 meters	85
	sUAS Starting Position			
	Latitude	Longitude	Altitude	Heading
	37.066341	-77.9586939	12.19 meters	85
Other Traffic Timing				
	Start Time (sec)	End Time (sec)	Velocity (kts)	
Other Traffic 1	60	160	180	
Other Traffic 2	250	397.540984	122	
Other Traffic 3	500	700	90	
Other Traffic Flight Paths				
	Latitude	Longitude	Altitude (ft)	Heading
Other Traffic 1	37.089	-77.9076	152.4	215
Other Traffic 2	37.093	-77.9994	152.4	125
Other Traffic 3	37.070	-77.9562	152.4	35

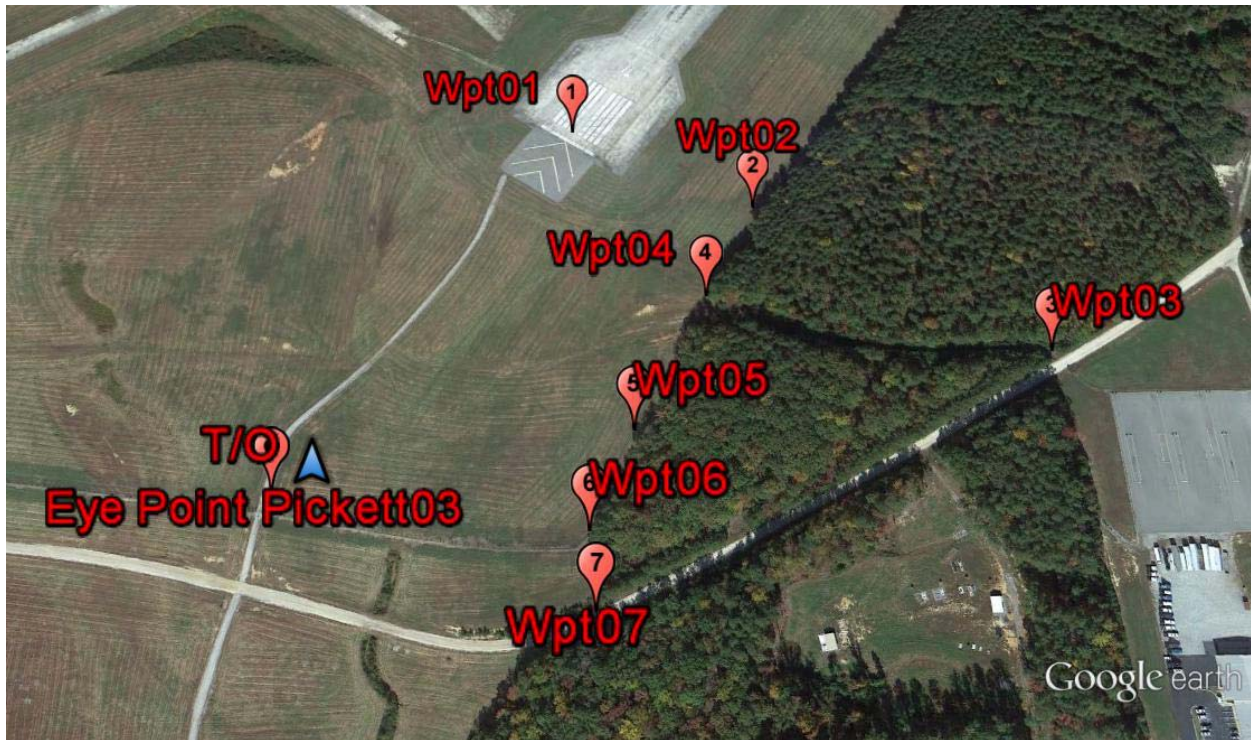

Figure C-5: Map of Waypoints for Scenario 6  
(Fort Pickett Blackstone Army Airfield Scenario 3)



Figure C-6: Map of Other Aircraft Paths for Scenario 6  
(Fort Pickett Blackstone Army Airfield Scenario 3)

## Appendix D: Air Traffic Control Alerts about Other Aircraft

### ATC ALERTS ABOUT OTHER AIRCRAFT

#### **Scenario 1 (Surry Nuclear Power Plant Scenario 1): South of Cooling Towers facing NE**

Alert Time: 120 seconds from start (Point-Out) UH-60 Sighted: 137 seconds

“FASER123, Felker Tower, Traffic, a UH Sixty, four miles northeast of your position will be passing to your east over the river inbound to Felker Army Airfield. Report traffic in sight.”

Alert Time: 340 seconds from start (Point-Out) Cessna 172 Sighted: 350 seconds

“FASER123, Felker Tower, Traffic, a Cessna 172, four miles southeast of your position will be passing from your east to north along the river. Report traffic in sight.”

Alert Time: 545 seconds from start (Point-Out) Cessna 172 Sighted: 581 seconds

“FASER123, Felker Tower, Traffic, a Cessna 172, three miles north of your position heading southeast will pass approximately two miles northeast of your position. Report traffic in sight.”

#### **Scenario 2 (Surry Nuclear Power Plant Scenario 2): East of Cooling Towers facing W**

Alert Time: 270 seconds from start (Evasive Action) Cessna 172 Sighted: 318 seconds

*Note: This intruder starts out 6 miles north of tower and may not be seen by ATC. It could be a NO ATC ALERT to see if the FASER pilot notices it.*

“FASER123, Felker Tower, Traffic, unidentified small aircraft, over the river approximately three miles to your north, low altitude, headed your direction, NO RADIO. Circle within visual line of sight at low altitude. Advise traffic in sight.”

#### **Scenario 3 (Surry Nuclear Power Plant Scenario 3): West of Cooling Towers facing E**

Sighting Time: 52 seconds from start (Jet Sighted-NO ALERT)

Alert Time: 260 seconds from start (Point-Out) UH-60 Sighted: 307 seconds

“FASER123, Felker Tower, Traffic, a UH-60, three miles east of your position will be passing about one mile east of your position heading northwest. Report traffic in sight.”

Alert Time: 520 seconds from start (Evasive Action) Sighted: 550 seconds

“FASER123, Felker Tower, Traffic, unidentified small aircraft, over the river approximately three point five miles southeast of your position, low altitude, headed your direction, NO RADIO. Circle within visual line of sight at low altitude. Advise traffic in sight.”

#### **Scenario 4 (Fort Pickett Blackstone Army Airfield Scenario 1): Lumber Yard Area facing E**

Alert Time: 170 seconds from start (Evasive Action) UH-60 Sighted: 205 seconds

“FASER99, Blackstone Tower, Traffic, UH-60, two point five miles northeast, low altitude, headed your direction, NO RADIO. Circle within visual line of sight at low altitude. Advise traffic in sight.”

#### **Scenario 5 (Fort Pickett Blackstone Army Airfield Scenario 2): Water Plant/Motor Pool Area facing W**

Alert Time: 15 seconds from start (Point-Out) Cessna 172 Sighted: 43 seconds

“FASER99, Blackstone Tower, Traffic, a Cessna 172, three miles northwest of your position will be passing about one mile to your west heading south. Report traffic in sight.”

Sighting Time: 277 seconds from start (Jet Sighted-NO ALERT)

Alert Time: 415 seconds from start (Point-Out) Cessna 172      Sighted 434 seconds  
“FASER99, Blackstone Tower, Traffic, a Cessna 172, three miles northwest of your position will be passing about one mile to your west heading south. Report traffic in sight.”

Alert Time: 625 seconds from start (Evasive Action) UH-60 Sighted 625 seconds  
“FASER99, Blackstone Tower, Traffic, UH-60, two point five miles southwest, low altitude, headed your direction, NO RADIO. Circle within visual line of sight at low altitude. Advise traffic in sight.”

**Scenario 6 (Fort Pickett Blackstone Army Airfield Scenario 3): ATC Tower Area North Side of ARPT facing NE**

Alert Time: 70 seconds from start (Point-Out) UH-60 Medevac      Sighted: 132 seconds  
“FASER99, Blackstone Tower, Traffic, a UH-60 Medevac, three miles northeast of your position will be passing about one mile to your east, heading to the south side of the airport to pick up patients. Report traffic in sight.”

**Scenario 10 (Practice Scenario – Fort Pickett 4): North of Active RWY facing SE**

Alert Time: 40 seconds from start (Evasive Action) UH-60      Sighted: 80 seconds  
“FASER99, Blackstone Tower, Traffic, UH-60, two point five miles southeast, low altitude, headed your direction, NO RADIO. Circle within visual line of sight at low altitude. Advise traffic in sight”

Alert Time: 340 seconds from start (Point-Out) Cessna 172      Sighted: 368 seconds  
“FASER99, Blackstone Tower, Traffic, a Cessna 172, three miles east of your position will be passing about one mile to your northeast heading northwest. Report traffic in sight.”

**Scenario 11 & 13 (Practice Scenario – Fort Pickett 5): South of Active RWY looking E**  
Sighting Time: 90 seconds from start (Jet Sighted-NO ALERT)

Alert Time: 288 seconds from start (Evasive Action) Cessna 172      Sighted: 320 seconds  
“FASER99, Blackstone Tower, Traffic, Cessna 172, two point five miles northwest, low altitude, headed your direction, NO RADIO. Circle within visual line of sight at low altitude. Advise traffic in sight”

Alert Time: 440 seconds from start (Point-Out) UH-60 Depart N      Sighted: 505 seconds  
“FASER99, Blackstone Tower, Traffic, a UH-60, taxiing on to NE end of active runway; will be departing northeast. Report traffic in sight.”

**Scenario 12 (Practice Scenario – Fort Pickett 6): East of Active RWY, North of Lumber Yard facing E**

Alert Time: 60 seconds from start (Evasive Action) Cessna 172      Sighted: 108 seconds  
“FASER99, Blackstone Tower, Traffic, Cessna 172, two point five miles west, low altitude, headed your direction, NO RADIO. Circle within visual line of sight at low altitude. Advise traffic in sight”

Sighting Time: 195 seconds from start (Jet Sighted-NO ALERT)

Alert Time: 330 seconds from start (Evasive Action) UH-60 Sighted: 406 seconds  
“FASER99, Blackstone Tower, Traffic, UH-60, two point five miles south, low altitude, headed your direction, NO RADIO. Circle within visual line of sight at low altitude. Advise traffic in sight”

Alert Time: 550 seconds from start (Evasive Action) Cessna 172 Sighted: 602 seconds  
“FASER99, Blackstone Tower, Traffic, Cessna 172, three miles northeast, low altitude, headed your direction, NO RADIO. Circle within visual line of sight at low altitude. Advise traffic in sight”

## Appendix E: Surry Nuclear Power Plant Scripts for Air Traffic Control and Mission Control

### Scenario 1 (Surry Nuclear Power Plant Scenario 1)

ATC Alert 1: 120 seconds from start (Helicopter)	TYPE: Point-Out
ATC Alert 2: 340 seconds from start (GA Airplane)	TYPE: Point-Out
ATC Alert 3: 545 seconds from start (GA Airplane)	TYPE: Point-Out

The pilot contacts FAF Tower to inform ATC of the proposed flight operation and mission.

**“Felker Tower, FASER123”**

Tower reply:

**“FASER123, Felker Tower, go ahead.”**

FASER reply should be something like this:

**“FASER123 is a small UAS at the Surry Nuclear Power Station by Hog Island. We will be conducting an inspection of the power station remaining within 400 yards of the facility, at or below 400 feet for approximately one hour, becoming airborne in about five minutes.”**

Tower reply:

**“FASER123, roger, altimeter two, niner, niner, two, wind one, eight, zero at five, report airborne.”**

The pilot advises FAF Tower that the FASER has been launched and he continues monitoring the tower frequency (126.3 MHz) during the flight, while watching for other aircraft.

**“Felker Tower, FASER123 airborne at (time), will remain within 400 yards of Surry Nuclear Power Station at or below 400 feet.”**

Felker Tower reply:

**“FASER123, roger, report on the ground when mission is completed.”**

FASER reply:

**“FASER123, roger, wilco.”**

The pilot advises Mission Control that the FASER is airborne and enroute to waypoint one:

**“Mission Control, FASER123 airborne, enroute to waypoint one”**

Mission Control reply:

**“FASER123, roger, loiter at waypoint one until advised to proceed. Report established waypoint one”**

FASER reply:

**“FASER123 wilco”**

**“FASER123 established waypoint one”**

Mission Control reply:

**“Roger”**

Mission Control advises FASER123 to proceed:

**“FASER123 proceed waypoint two, report established ”**

FASER reply:

**“FASER123 proceeding waypoint two”**

**“FASER123 established waypoint two”**

Mission Control reply:

**“Roger”**

Mission Control advises FASER123 to proceed:

**“FASER123 proceed waypoint three, report established ”**

FASER reply:

**“FASER123 proceeding waypoint three”**

**“FASER123 established waypoint three”**

Mission Control reply:

**“Roger”**

Mission Control advises FASER123 to proceed:

**“FASER123 proceed waypoint four, report established ”**

FASER reply:

**“FASER123 proceeding waypoint four”**

**“FASER123 established waypoint four”**

Mission Control reply:

**“Roger”**

Mission Control advises FASER123 to proceed:

**“FASER123 proceed waypoint five, report established ”**

FASER reply:

**“FASER123 proceeding waypoint five”**

**“FASER123 established waypoint five”**

Mission Control reply:

**“Roger”**

Mission Control advises FASER123 to proceed:

**“FASER123 proceed waypoint six, report established”**

FASER reply:

**“FASER123 proceeding waypoint six”**



**“FASER123 established waypoint six”**

Mission Control reply:

**“Roger”**

Mission Control advises FASER123 to proceed:

**“FASER123 proceed waypoint seven, report established”**

FASER reply:

**“FASER123 proceeding waypoint seven”**

**“FASER123 established waypoint seven”**

Mission Control reply:

**“Roger”**

Mission Control terminates mission:

**“FASER123, data collection completed, mission terminated. Report on ground to ATC”**

FASER reply:

**“FASER123, roger, mission terminated”**

The pilot returns the FASER to the launch point for recovery:

**“Felker Tower, FASER123 on the ground, mission terminated”**

Tower reply:

**“FASER123, roger, have a good day”**

## **Scenario 2 (Surry Nuclear Power Plant Scenario 2)**

**ATC Alert: 270 seconds from start (GA Airplane) TYPE: Evasive Action or No Alert**

The pilot contacts FAF Tower to inform ATC of the proposed flight operation and mission.

**“Felker Tower, FASER123”**

Tower reply:

**“FASER123, Felker Tower, go ahead.”**

FASER reply should be something like this:

**“FASER123 is a small UAS at the Surry Nuclear Power Station by Hog Island. We will be conducting an inspection of the power station remaining within 400 yards of the facility, at or below 400 feet for approximately one hour, becoming airborne in about five minutes.”**

Tower reply:

**“FASER123, roger, altimeter two, niner, niner, two, wind one, eight, zero at five, report airborne.”**

The pilot advises FAF Tower that the FASER has been launched and he continues monitoring the tower frequency (126.3 MHz) during the flight, while watching for other aircraft.

**“Felker Tower, FASER123 airborne at (time), will remain within 400 yards of Surry Nuclear Power Station at or below 400 feet.”**

Felker Tower reply:

**“FASER123, roger, report on the ground when mission is completed.”**

FASER reply:

**“FASER123, roger, wilco.”**

The pilot advises Mission Control that the FASER is airborne and enroute to waypoint one:

**“Mission Control, FASER123 airborne, enroute to waypoint one”**

Mission Control reply:

**“FASER123, roger, loiter at waypoint one until advised to proceed. Report established waypoint one”**

FASER reply:

**“FASER123 wilco”**

**“FASER123 established waypoint one”**

Mission Control reply:

**“Roger”**

Mission Control advises FASER123 to proceed:

**“FASER123 proceed waypoint two, report established ”**

FASER reply:

**“FASER123 proceeding waypoint two”**

**“FASER123 established waypoint two”**

Mission Control reply:

**“Roger”**

Mission Control advises FASER123 to proceed:

**“FASER123 proceed waypoint three, report established ”**

FASER reply:

**“FASER123 proceeding waypoint three”**

**“FASER123 established waypoint three”**

Mission Control reply:

**“Roger”**

Mission Control advises FASER123 to proceed:

**“FASER123 proceed waypoint four, report established ”**

FASER reply:

**“FASER123 proceeding waypoint four”**

**“FASER123 established waypoint four”**

Mission Control reply:

**“Roger”**

Mission Control advises FASER123 to proceed:

**“FASER123 proceed waypoint five, report established ”**

FASER reply:

**“FASER123 proceeding waypoint five”**

**“FASER123 established waypoint five”**

Mission Control reply:

**“Roger”**

Mission Control advises FASER123 to proceed:

**“FASER123 proceed waypoint six, report established”**

FASER reply:

**“FASER123 proceeding waypoint six”**

**“FASER123 established waypoint six”**

Mission Control reply:

**“Roger”**

Mission Control advises FASER123 to proceed:

**“FASER123 proceed waypoint seven, report established”**

FASER reply:

**“FASER123 proceeding waypoint seven”**

**“FASER123 established waypoint seven”**

Mission Control reply:

**“Roger”**

Mission Control terminates mission:

**“FASER123, data collection completed, mission terminated. Report on ground to ATC”**

FASER reply:

**“FASER123, roger, mission terminated”**

The pilot returns the FASER to the launch point for recovery:

**“Felker Tower, FASER123 on the ground, mission terminated”**

Tower reply:

**“FASER123, roger, have a good day”**

**Scenario 3 (Surry Nuclear Power Plant Scenario 4)**

<b>Jet Sighted: 52 seconds from start</b>	<b>NO ALERT</b>
<b>ATC Alert 1: 260 seconds from start (Helicopter)</b>	<b>TYPE: Point-Out</b>
<b>ATC Alert 2: 520 seconds from start (GA Airplane)</b>	<b>TYPE: Evasive Action</b>

The pilot contacts FAF Tower to inform ATC of the proposed flight operation and mission.

**“Felker Tower, FASER123”**

Tower reply:

**“FASER123, Felker Tower, go ahead.”**

FASER reply should be something like this:

**“FASER123 is a small UAS at the Surry Nuclear Power Station by Hog Island. We will be conducting an inspection of the power station remaining within 400 yards of the facility, at or below 400 feet for approximately one hour, becoming airborne in about five minutes.”**

Tower reply:

**“FASER123, roger, altimeter two, niner, niner, two, wind one, eight, zero at five, report airborne.”**

The pilot advises FAF Tower that the FASER has been launched and he continues monitoring the tower frequency (126.3 MHz) during the flight, while watching for other aircraft.

**“Felker Tower, FASER123 airborne at (time), will remain within 400 yards of Surry Nuclear Power Station at or below 400 feet.”**

Felker Tower reply:

**“FASER123, roger, report on the ground when mission is completed.”**

FASER reply:

**“FASER123, roger, wilco.”**



The pilot advises Mission Control that the FASER is airborne and enroute to waypoint one:

**“Mission Control, FASER123 airborne, enroute to waypoint one”**

Mission Control reply:

**“FASER123, roger, loiter at waypoint one until advised to proceed. Report established waypoint one”**

FASER reply:

**“FASER123 wilco”**

**“FASER123 established waypoint one”**

Mission Control reply:

**“Roger”**

Mission Control advises FASER123 to proceed:

**“FASER123 proceed waypoint two, report established ”**

FASER reply:

**“FASER123 proceeding waypoint two”**

**“FASER123 established waypoint two”**

Mission Control reply:

**“Roger”**

Mission Control advises FASER123 to proceed:

**“FASER123 proceed waypoint three, report established ”**

FASER reply:

**“FASER123 proceeding waypoint three”**

**“FASER123 established waypoint three”**

Mission Control reply:

**“Roger”**

Mission Control advises FASER123 to proceed:

**“FASER123 proceed waypoint four, report established ”**

FASER reply:

**“FASER123 proceeding waypoint four”**

**“FASER123 established waypoint four”**

Mission Control reply:

**“Roger”**

Mission Control advises FASER123 to proceed:

**“FASER123 proceed waypoint five, report established ”**

FASER reply:

**“FASER123 proceeding waypoint five”**

**“FASER123 established waypoint five”**

Mission Control reply:

**“Roger”**

Mission Control advises FASER123 to proceed:

**“FASER123 proceed waypoint six, report established”**

FASER reply:

**“FASER123 proceeding waypoint six”**

**“FASER123 established waypoint six”**

Mission Control reply:

**“Roger”**

Mission Control advises FASER123 to proceed:

**“FASER123 proceed waypoint seven, report established”**

FASER reply:

**“FASER123 proceeding waypoint seven”**

**“FASER123 established waypoint seven”**

Mission Control reply:

**“Roger”**

Mission Control terminates mission:

**“FASER123, data collection completed, mission terminated. Report on ground to ATC”**

FASER reply:

**“FASER123, roger, mission terminated”**

The pilot returns the FASER to the launch point for recovery:

**“Felker Tower, FASER123 on the ground, mission terminated”**

Tower reply:

**“FASER123, roger, have a good day”**

## Appendix F: Fort Pickett Scripts for Air Traffic Control and Mission Control

### Scenario 4 (Fort Pickett Blackstone Army Airfield Scenario 1)

ATC Alert 1: 170 seconds from start (Helicopter)

TYPE: Evasive Action

The state trooper contacts ATC at Blackstone Tower:

**“Blackstone Tower, FASER99”**

ATC

**“FASER99, Blackstone Tower, go ahead”**

The state trooper/FASER pilot informs ATC of the impending search and rescue mission:

FASER 99:

**“Blackstone Tower, FASER 99 is a State Police small unmanned aircraft unit responding to the tornado emergency at the lumber yard on the airfield. We have a missing person from this site and would like to reposition to a point on the airfield to launch a search and rescue effort. We would like to fly at or below 400 ft. over the wooded areas around the airfield. We will operate Visual Line-Of-Sight within 400 yards of launch point at all times.”**

ATC:

**“FASER 99 roger, repositioning approved, remain at least 25 feet clear of runway. Advise when ready to launch.”**

FASER 99:

**“FASER 99, roger. Will reposition and remain clear of runway.”**

The FASER pilot coordinates with Mission Control to develop a SAR flight pattern, repositions to a launch area on the airfield and then informs ATC that he is ready to launch:

**“Blackstone Tower, FASER 99 ready to launch”**

ATC:

**“FASER 99, Blackstone Tower, roger, remain within 400 yards of launch point at or below 400 feet and report back on ground at mission termination, Wind 1-8-0 at 5, altimeter 2-9-9-2. Cleared to launch”**

FASER 99:

**“FASER 99 roger, altimeter 2-9-9-2. Will report back on ground, Cleared to launch”**

The pilot advises Mission Control that the FASER is airborne and enroute to waypoint one:

**“Mission Control, FASER99 airborne, enroute to waypoint one”**

Mission Control reply:

**“FASER99, roger, loiter at waypoint one until advised to proceed. Report established waypoint one”**

FASER reply:

**“FASER99 wilco”**

**“FASER99 established waypoint one”**

Mission Control reply:

**“Roger, established waypoint one”**

Mission Control advises FASER99 to proceed:

**“FASER99 proceed waypoint two and loiter until advised to proceed. Report established waypoint two.”**

FASER reply:

**“FASER99 proceeding waypoint two”**

**“FASER99 established waypoint two”**

Mission Control reply:

**“Roger, established waypoint two”**

Mission Control advises FASER99 to proceed:

**“FASER99 proceed waypoint three and loiter until advised to proceed. Report established waypoint three.”**

FASER reply:

**“FASER99 proceeding waypoint three”**

**“FASER99 established waypoint three”**

Mission Control reply:

**“Roger, established waypoint three”**

Mission Control advises FASER99 to proceed:

**“FASER99 proceed waypoint four and loiter until advised to proceed. Report established waypoint four.”**

FASER reply:

**“FASER99 proceeding waypoint four”**

**“FASER99 established waypoint four”**

Mission Control reply:

**“Roger, established waypoint four”**

Mission Control advises FASER99 to proceed:

**“FASER99 proceed waypoint five and loiter until advised to proceed. Report established waypoint five.”**

FASER reply:

**“FASER99 proceeding waypoint five”**

**“FASER99 established waypoint five”**

Mission Control reply:

**“Roger, established waypoint five”**

Mission Control advises FASER99 to proceed:

**“FASER99 proceed waypoint six and loiter until advised to proceed. Report established waypoint six.”**

FASER reply:

**“FASER99 proceeding waypoint six”**

**“FASER99 established waypoint six”**

Mission Control reply:

**“Roger, established waypoint six”**

Mission Control advises FASER99 to proceed:

**“FASER99 proceed waypoint seven and loiter until advised to proceed. Report established waypoint seven.”**

FASER reply:

**“FASER99 proceeding waypoint seven”**

**“FASER99 established waypoint seven”**

Mission Control reply:

**“Roger, established waypoint seven”**

Mission Control terminates mission:

**“FASER99, data collection completed, mission terminated, report on ground to ATC”**



FASER reply:

**“FASER99, roger, mission terminated”**

The pilot returns the FASER to the launch point for recovery:

**“Blackstone Tower, FASER99 on the ground, mission terminated”**

Tower reply:

**“FASER99, roger, have a good day”**

**Scenario 5 (Fort Pickett Blackstone Army Airfield Scenario 2)**

<b>ATC Alert 1: 15 seconds from start (GA Airplane)</b>	<b>TYPE: Point-Out</b>
<b>Jet Sighted: 277 seconds from start</b>	<b>NO ALERT</b>
<b>ATC Alert 2: 415 seconds from start (GA Airplane)</b>	<b>TYPE: Point-Out</b>
<b>ATC Alert 3: 625 seconds from start (Helicopter)</b>	<b>TYPE: Evasive Action</b>

The state trooper contacts ATC at Blackstone Tower:

**“Blackstone Tower, FASER99”**

ATC

**“FASER99, Blackstone Tower, go ahead”**

The state trooper/FASER pilot informs ATC of the impending search and rescue mission:

FASER 99:

**“Blackstone Tower, FASER 99 is a State Police small unmanned aircraft unit responding to the tornado emergency at the lumber yard on the airfield. We have a missing person from this site and would like to reposition to a point on the airfield to launch a search and rescue effort. We would like to fly at or below 400 ft. over the wooded areas around the airfield. We will operate Visual Line-Of-Sight within 400 yards of launch point at all times.”**

ATC:

**“FASER 99 roger, repositioning approved, remain at least 25 feet clear of runway. Advise when ready to launch.”**

FASER 99:

**“FASER 99, roger. Will reposition and remain clear of runway.”**

The FASER pilot coordinates with Mission Control to develop a SAR flight pattern, repositions to a launch area on the airfield and then informs ATC that he is ready to launch:

**“Blackstone Tower, FASER 99 ready to launch”**

ATC:

**“FASER 99, Blackstone Tower, roger, remain within 400 yards of launch point at or below 400 feet and report back on ground at mission termination, Wind 1-8-0 at 5, altimeter 2-9-9-2. Cleared to launch”**

FASER 99:

**“FASER 99 roger, altimeter 2-9-9-2. Will report back on ground, Cleared to launch”**

The pilot advises Mission Control that the FASER is airborne and enroute to waypoint one:

**“Mission Control, FASER99 airborne, enroute to waypoint one”**

Mission Control reply:

**“FASER99, roger, loiter at waypoint one until advised to proceed. Report established waypoint one”**

FASER reply:

**“FASER99 wilco”**

**“FASER99 established waypoint one”**

Mission Control reply:

**“Roger, established waypoint one”**

Mission Control advises FASER99 to proceed:

**“FASER99 proceed waypoint two and loiter until advised to proceed. Report established waypoint two.”**

FASER reply:

**“FASER99 proceeding waypoint two”**

**“FASER99 established waypoint two”**

Mission Control reply:

**“Roger, established waypoint two”**

Mission Control advises FASER99 to proceed:

**“FASER99 proceed waypoint three and loiter until advised to proceed. Report established waypoint three.”**

FASER reply:

**“FASER99 proceeding waypoint three”**

**“FASER99 established waypoint three”**

Mission Control reply:

**“Roger, established waypoint three”**

Mission Control advises FASER99 to proceed:

**“FASER99 proceed waypoint four and loiter until advised to proceed. Report established waypoint four.”**

FASER reply:

**“FASER99 proceeding waypoint four”**

**“FASER99 established waypoint four”**

Mission Control reply:

**“Roger, established waypoint four”**

Mission Control advises FASER99 to proceed:

**“FASER99 proceed waypoint five and loiter until advised to proceed. Report established waypoint five.”**

FASER reply:

**“FASER99 proceeding waypoint five”**

**“FASER99 established waypoint five”**

Mission Control reply:

**“Roger, established waypoint five”**

Mission Control advises FASER99 to proceed:

**“FASER99 proceed waypoint six and loiter until advised to proceed. Report established waypoint six.”**

FASER reply:

**“FASER99 proceeding waypoint six”**

**“FASER99 established waypoint six”**

Mission Control reply:

**“Roger, established waypoint six”**

Mission Control advises FASER99 to proceed:

**“FASER99 proceed waypoint seven and loiter until advised to proceed. Report established waypoint seven.”**

FASER reply:

**“FASER99 proceeding waypoint seven”**

**“FASER99 established waypoint seven”**

Mission Control reply:

**“Roger, established waypoint seven”**

Mission Control terminates mission:

**“FASER99, data collection completed, mission terminated, report on ground to ATC”**

FASER reply:

**“FASER99, roger, mission terminated”**

The pilot returns the FASER to the launch point for recovery:

**“Blackstone Tower, FASER99 on the ground, mission terminated”**

Tower reply:

**“FASER99, roger, have a good day”**

**Scenario 6 (Fort Pickett Blackstone Army Airfield Scenario 3)**

**Jet Sighted: 90 seconds from start**

**NO ALERT**

**ATC Alert 1: 288 seconds from start (GA Airplane)**

**TYPE: Evasive Action**

**ATC Alert 2: 440 seconds from start (Helicopter)**

**TYPE: Point-Out (Deptr N)**

The state trooper contacts ATC at Blackstone Tower:

**“Blackstone Tower, FASER99”**

ATC

**“FASER99, Blackstone Tower, go ahead”**

The state trooper/FASER pilot informs ATC of the impending search and rescue mission:

FASER 99:

**“Blackstone Tower, FASER 99 is a State Police small unmanned aircraft unit responding to the tornado emergency at the lumber yard on the airfield. We have a missing person from this site and would like to reposition to a point on the airfield to launch a search and rescue effort. We would like to fly at or below 400 ft. over the wooded areas around the airfield. We will operate Visual Line-Of-Sight within 400 yards of launch point at all times.”**

ATC:

**“FASER 99 roger, repositioning approved, remain at least 25 feet clear of runway. Advise when ready to launch.”**

FASER 99:

**“FASER 99, roger. Will reposition and remain clear of runway.”**

The FASER pilot coordinates with Mission Control to develop a SAR flight pattern, repositions to a launch area on the airfield and then informs ATC that he is ready to launch:

**“Blackstone Tower, FASER 99 ready to launch”**

ATC:



**“FASER 99, Blackstone Tower, roger, remain within 400 yards of launch point at or below 400 feet and report back on ground at mission termination, Wind 1-8-0 at 5, altimeter 2-9-9-2. Cleared to launch”**

FASER 99:

**“FASER 99 roger, altimeter 2-9-9-2. Will report back on ground, Cleared to launch”**

The pilot advises Mission Control that the FASER is airborne and enroute to waypoint one:

**“Mission Control, FASER99 airborne, enroute to waypoint one”**

Mission Control reply:

**“FASER99, roger, loiter at waypoint one until advised to proceed. Report established waypoint one”**

FASER reply:

**“FASER99 wilco”**

**“FASER99 established waypoint one”**

Mission Control reply:

**“Roger, established waypoint one”**

Mission Control advises FASER99 to proceed:

**“FASER99 proceed waypoint two and loiter until advised to proceed. Report established waypoint two.”**

FASER reply:

**“FASER99 proceeding waypoint two”**

**“FASER99 established waypoint two”**

Mission Control reply:

**“Roger, established waypoint two”**

Mission Control advises FASER99 to proceed:

**“FASER99 proceed waypoint three and loiter until advised to proceed. Report established waypoint three.”**

FASER reply:

**“FASER99 proceeding waypoint three”**

**“FASER99 established waypoint three”**

Mission Control reply:

**“Roger, established waypoint three”**

Mission Control advises FASER99 to proceed:

**“FASER99 proceed waypoint four and loiter until advised to proceed. Report established waypoint four.”**

FASER reply:

**“FASER99 proceeding waypoint four”**

**“FASER99 established waypoint four”**

Mission Control reply:

**“Roger, established waypoint four”**

Mission Control advises FASER99 to proceed:

**“FASER99 proceed waypoint five and loiter until advised to proceed. Report established waypoint five.”**

FASER reply:

**“FASER99 proceeding waypoint five”**

**“FASER99 established waypoint five”**

Mission Control reply:

**“Roger, established waypoint five”**

Mission Control advises FASER99 to proceed:

**“FASER99 proceed waypoint six and loiter until advised to proceed. Report established waypoint six.”**

FASER reply:

**“FASER99 proceeding waypoint six”**

**“FASER99 established waypoint six”**

Mission Control reply:

**“Roger, established waypoint six”**

Mission Control advises FASER99 to proceed:

**“FASER99 proceed waypoint seven and loiter until advised to proceed. Report established waypoint seven.”**

FASER reply:

**“FASER99 proceeding waypoint seven”**

**“FASER99 established waypoint seven”**

Mission Control reply:

**“Roger, established waypoint seven”**

Mission Control terminates mission:

**“FASER99, data collection completed, mission terminated, report on ground to ATC”**

FASER reply:

**“FASER99, roger, mission terminated”**

The pilot returns the FASER to the launch point for recovery:

**“Blackstone Tower, FASER99 on the ground, mission terminated”**

Tower reply:

**“FASER99, roger, have a good day”**

## Appendix G: Subject Run Orders

The tables in this Appendix represent the run orders for each of the nine test subjects. In addition, the following headings describe the meaning of the Scenario heading, the Display heading, and the Data heading that are in the run order tables.

### Scenario Heading Key:

Scenario 1	Surry Nuclear Power Plant Scenario 1
Scenario 2	Surry Nuclear Power Plant Scenario 2
Scenario 3	Surry Nuclear Power Plant Scenario 3
Scenario 4	Fort Pickett Blackstone Army Airfield Scenario 1
Scenario 5	Fort Pickett Blackstone Army Airfield Scenario 2
Scenario 6	Fort Pickett Blackstone Army Airfield Scenario 3
Scenario 10	Practice Scenario – Fort Pickett Scenario 4
Scenario 11	Practice Scenario – Fort Pickett Scenario 5
Scenario 12	Practice Scenario – Fort Pickett Scenario 6
Scenario 13	Practice Scenario – Fort Pickett Scenario 5

### Display Heading Key:

Display Set 1	VLOS
Display Set 2	VLOS + PFD (PFD)
Display Set 3	VLOS + PFD + Moving Map (Map)

### Data Heading Key:

0 represented data that was recorded *but not* included in the data analysis  
1 represented data that was recorded *and* included in the data analysis

Table G-1: Subject A Run Order

<b>Subject</b>	<b>Data Run</b>	<b>Scenario</b>	<b>Display</b>	<b>Data</b>
<b>A</b>		10	1	0
<b>A</b>		11	3	0
<b>A</b>	1	1	3	1
<b>A</b>	2	5	3	1
<b>A</b>	3	3	3	1
<b>A</b>		12	1	0
<b>A</b>	4	4	1	1
<b>A</b>	5	2	1	1
<b>A</b>	6	6	1	1
<b>A</b>		13	2	0
<b>A</b>	7	1	2	1
<b>A</b>	8	5	2	1
<b>A</b>	9	3	2	1

Table G-2: Subject B Run Order

<b>Subject</b>	<b>Data Run</b>	<b>Scenario</b>	<b>Display</b>	<b>Data</b>
<b>B</b>		10	1	0
<b>B</b>		11	2	0
<b>B</b>	1	5	2	1
<b>B</b>	2	3	2	1
<b>B</b>	3	4	2	1
<b>B</b>		12	3	0
<b>B</b>	4	2	3	1
<b>B</b>	5	6	3	1
<b>B</b>	6	1	3	1
<b>B</b>		13	1	0
<b>B</b>	7	5	1	1
<b>B</b>	8	3	1	1
<b>B</b>	9	4	1	1

Table G-3: Subject C Run Order

Subject	Data Run	Scenario	Display	Data
C		10	1	0
C		11	1	0
C	1	6	1	1
C	2	1	1	1
C	3	5	1	1
C		12	2	0
C	4	2	2	1
C	5	3	2	1
C	6	4	2	1
C		13	3	0
C	7	6	3	1
C	8	1	3	1
C	9	5	3	1

Table G-4: Subject D Run Order

Subject	Data Run	Scenario	Display	Data
D		10	1	0
D		11	3	0
D	1	3	3	1
D	2	1	3	1
D	3	5	3	1
D		12	1	0
D	4	6	1	1
D	5	4	1	1
D	6	2	1	1
D		13	2	0
D	7	3	2	1
D	8	1	2	1
D	9	5	2	1

Table G-5: Subject E Run Order

<b>Subject</b>	<b>Data Run</b>	<b>Scenario</b>	<b>Display</b>	<b>Data</b>
<b>E</b>		10	1	0
<b>E</b>		11	2	0
<b>E</b>	1	3	2	1
<b>E</b>	2	4	2	1
<b>E</b>	3	5	2	1
<b>E</b>		12	3	0
<b>E</b>	4	6	3	1
<b>E</b>	5	1	3	1
<b>E</b>	6	2	3	1
<b>E</b>		13	1	0
<b>E</b>	7	3	1	1
<b>E</b>	8	4	1	1
<b>E</b>	9	5	1	1

Table G-6: Subject F Run Order

<b>Subject</b>	<b>Data Run</b>	<b>Scenario</b>	<b>Display</b>	<b>Data</b>
<b>F</b>		10	1	0
<b>F</b>		11	1	0
<b>F</b>	1	1	1	1
<b>F</b>	2	5	1	1
<b>F</b>	3	6	1	1
<b>F</b>		12	2	0
<b>F</b>	4	4	2	1
<b>F</b>	5	2	2	1
<b>F</b>	6	3	2	1
<b>F</b>		13	3	0
<b>F</b>	7	1	3	1
<b>F</b>	8	5	3	1
<b>F</b>	9	6	3	1



Table G-7: Subject G Run Order

<b>Subject</b>	<b>Data Run</b>	<b>Scenario</b>	<b>Display</b>	<b>Data</b>
<b>G</b>		10	1	0
<b>G</b>		11	3	0
<b>G</b>	1	5	3	1
<b>G</b>	2	3	3	1
<b>G</b>	3	1	3	1
<b>G</b>		12	1	0
<b>G</b>	4	2	1	1
<b>G</b>	5	6	1	1
<b>G</b>	6	4	1	1
<b>G</b>		13	2	0
<b>G</b>	7	5	2	1
<b>G</b>	8	3	2	1
<b>G</b>	9	1	2	1

Table G-8: Subject H Run Order

<b>Subject</b>	<b>Data Run</b>	<b>Scenario</b>	<b>Display</b>	<b>Data</b>
<b>H</b>		10	1	0
<b>H</b>		11	2	0
<b>H</b>	1	4	2	1
<b>H</b>	2	5	2	1
<b>H</b>	3	3	2	1
<b>H</b>		12	3	0
<b>H</b>	4	1	3	1
<b>H</b>	5	2	3	1
<b>H</b>	6	6	3	1
<b>H</b>		13	1	0
<b>H</b>	7	4	1	1
<b>H</b>	8	5	1	1
<b>H</b>	9	3	1	1

Table G-9: Subject I Run Order

<b>Subject</b>	<b>Data Run</b>	<b>Scenario</b>	<b>Display</b>	<b>Data</b>
I		10	1	0
I		11	1	0
I	1	5	1	1
I	2	6	1	1
I	3	1	1	1
I		12	2	0
I	4	4	2	1
I	5	2	2	1
I	6	3	2	1
I		13	3	0
I	7	5	3	1
I	8	6	3	1
I	9	1	3	1

# Appendix H: Ground Control Station Display Questionnaire

## PILOT GCS QUESTIONNAIRE

The following questions refer to the head-down flat panel display

1. How well did the Ground Control Station (GCS) warn you of upcoming obstacles?

Not Very Well			Neutral				Very Well			

**Comments:** \_\_\_\_\_  
\_\_\_\_\_  
\_\_\_\_\_

2. Overall, understanding/navigating the GCS was

Not Very Realistic			Neutral				Very Realistic			

**Comments:** \_\_\_\_\_  
\_\_\_\_\_  
\_\_\_\_\_

3. How well was the layout of the display?

Not Very Well			Neutral				Very Well			

**Comments:** \_\_\_\_\_  
\_\_\_\_\_  
\_\_\_\_\_

4. Did the display provide the information you needed to know the current status of your aircraft (location, altitude, speed, attitude, etc...) and to carry out the intended mission?

- A) No
- B) Yes

**If no, what information was missing?** \_\_\_\_\_  
\_\_\_\_\_  
\_\_\_\_\_

5. Was there any information you needed that was not provided on the display?

- A) No
- B) Yes

**If yes, what information was missing?** \_\_\_\_\_  
\_\_\_\_\_  
\_\_\_\_\_

6. Do you believe that ADS-B is necessary in visual line-of-sight operations?

- A) No
- B) Yes

**If no, why not? If yes, go to number 4.** \_\_\_\_\_  
\_\_\_\_\_  
\_\_\_\_\_

7. What information in the ADS-B do you believe is necessary to have?

\_\_\_\_\_  
\_\_\_\_\_  
\_\_\_\_\_  
\_\_\_\_\_  
\_\_\_\_\_

8. Do you have any additional comments or suggestions that could improve our Ground Control Station?

---

---

---

---

---

# Appendix I: Final/Exit Questionnaire

## PILOT FINAL QUESTIONNAIRE

1. Place the following Ground Control Station Displays in order of preference, with number 1 being the best and number 3 being the worst

\_\_\_\_\_ None  
\_\_\_\_\_ PFD  
\_\_\_\_\_ PFD + Map

**Please say why you chose the order you did:** \_\_\_\_\_

---

---

---

---

---

2. Overall, the data runs were:

\_\_\_\_\_

Very Hard	Somewhat Hard	Neutral	Somewhat Easy	Very Easy
--------------	------------------	---------	------------------	--------------

**Comments:** \_\_\_\_\_

---

---

3. Today, from the first data run to the last data run, my ability to avoid obstacles was:

\_\_\_\_\_

Very Hard	Somewhat Hard	Neutral	Somewhat Easy	Very Easy
--------------	------------------	---------	------------------	--------------

**Comments:** \_\_\_\_\_

---

---

4. Today, from the first data run to the last data run, my ability to fly the intended loiter points was:

Very Hard	Somewhat Hard		Neutral		Somewhat Easy			Very Easy	

**Comments:** \_\_\_\_\_  
\_\_\_\_\_  
\_\_\_\_\_

5. How well were you able to maintain visual line-of-sight with the strobe lights?

Very Hard	Somewhat Hard		Neutral		Somewhat Easy			Very Easy	

**Comments:** \_\_\_\_\_  
\_\_\_\_\_  
\_\_\_\_\_

6. Do you believe strobe lights are necessary in visual line-of-sight operations during the day time?

- A) No
- B) Yes

**Comments:** \_\_\_\_\_  
\_\_\_\_\_  
\_\_\_\_\_

7. Overall, maintaining visual line-of-sight was:

Very Hard	Somewhat Hard		Neutral		Somewhat Easy			Very Easy	

**Comments:** \_\_\_\_\_  
\_\_\_\_\_  
\_\_\_\_\_

8. Do you have any additional comments or suggestions that could improve our Ground Control Station?

---

---

---

---

---

---

---

---

---

---



# Appendix J: Experimenter's Instructions Sheet

## HITL 01: Experimenter's Instructions Sheet

### Background

- My background
- Essentially, this line of research will investigate pilots' abilities to safely fly a sUAS with a manual controller in visual line-of-sight operations

### Purpose

- The objectives are to determine:
  1. Determine the sUAS ability to safely avoid obstacles under VLOS operations.
  2. Determine the effectiveness of the GCS in meeting normal NAS operational requirements for pilot/ATC communication.
  3. Identify any potential human system integration deficiencies that could hinder the safe, effective, and efficient integration of sUAS VLOS mission within controlled airspace (class C, D, and E airspace).

### General Procedure

- This is no more than a 8 hr. experiment conducted in a low-to-medium fidelity simulator
- During each 20 min run, you will need to safely navigate to various loiter points
- After the data runs, you will complete questionnaires about your preferences for the information present in the GCS

### Informed Consent Form

- All data will be kept confidential
- You will be referred to only by a number
- All reporting of data will be by group statistics. If a particular quote is used in a report, no identifying characteristics will be used in association with the quote.
- Briefly go over sections
- Have subject sign Informed Consent Form

### Simulator

- You will be flying a simulation similar to that of a sUAS
- For all runs, you will be controlling the sUAS with a manual controller (Figure 1). The right stick controls bank angle and pitch while the left stick controls yaw and throttle.
- For some of the runs you will have a PFD available (Figure 2). The portions of the display consist of the airspeed, compass rose heading, ADI, vertical speed and altitude display. This display is on the left screen.
- For other runs you will have a map display available (Figure 3) in addition to the PFD. This display is on the middle right screen.
- You will not be flying using the autopilot or auto-throttles

### Task

- Each run last approximately 20 min
- During that time, you will safely navigate the sUAS to the various waypoints while avoiding any and all obstacles by at least 50 feet
- Starting point is approximately 40 ft. AGL.**
- Two types of scenarios (NRC Surry nuclear power plant inspection & police SAR mission after tornado at Fort Pickett).
- Proper mission altitude:**
  - o **Surry NRC missions 250 ft. AGL**
  - o **Blackstone AAF SAR mission 200 ft. AGL.**

- ❑ Communication protocol (ATC & MC).
  - **Initial Radio Calls**
    - Always call ATC prior to launching to receive permission for the mission and to receive instructions
    - Always call Mission Control to report airborne to initiate the mission and receive mission instructions
    - **For the Surry NRC, always contact Felker Tower about take-off and landing**
    - **For Ft. Pickett, you must have ATC clearance before take-off and landing**
- ❑ It will be assumed that the mission has been pre-coordinated between the pilot and Mission Control before the mission. The pilot will know the seven waypoint locations and that he will be expected to loiter at each one for data collection by Mission Control. The pilot will be directed by Mission Control to proceed to each waypoint and to report established there. After loitering for 60 seconds, the pilot will be instructed to proceed to the next successive waypoint. After loitering at waypoint seven for 60 seconds, the Mission Control specialist will inform the pilot that the mission is terminated, and to report “on the ground” to ATC.
- ❑ ATC Alerts: Intruder aircraft (evasive action) and point-outs (local traffic).
- ❑ If ATC instructs to **“Circle within visual line of sight at low altitude, advise traffic in sight”** the pilot should return to a point front and center of the launch point and hold there at low altitude until traffic is no longer a factor. **When it appears traffic is no longer a factor, advise ATC and request to resume mission. When cleared, inform Mission Control that you took evasive action to comply with ATC instructions, and request further mission instructions.** Mission Control will have you proceed to the same or next successive waypoint, depending on how long you were at the last waypoint.
- ❑ **Mission Completion: When the Mission Control specialist terminates the mission, return to the launch point and circle, and report on ground to ATC.**
- ❑ Crash criteria:
  - Crash prior to reaching waypoint 5 (start again-data eliminated)
  - Crash twice before reaching waypoint 5 (proceed to the next scenario)
  - Data will be kept from runs that terminate in a crash with notation as to where the crash occurred.
- ❑ **50 ft. obstacle-avoidance radius around ground-based obstacles:** Violations of the obstacle areas are considered a failure to avoid obstacles, rather than crashes.
- ❑ At the end of each run, you will answer 6 situation awareness questions using the touchscreens. These questions will come up on the left display.
  - Go over questions
- ❑ To move on to the next question, please hit the **“NEXT”** button
- ❑ The next question you may have to answer has to do with how easy it was to fly the sUAS using the CH rating scale. This is done using an interactive flow chart (Figures 4 and 5).
  - The first question is “Is it controllable?” Answer “NO” if you lost control during the run. In this case, you must give it a rating of 10. Just touch anywhere in the box to record your answer.
  - If it is controllable, then the next question is “Is adequate performance attainable with a tolerable pilot workload?” If workload was too high, answer “NO” and you will be able to give a rating of 7, 8, or 9.

- If workload was tolerable, then the next question is “Is it satisfactory without improvement?” If some improvement needs to be made, answer “NO” and you will be able to give a rating of 4, 5, or 6. For pitch, adequate performance is defined as being within 1 width of the airplane symbol on the PFD (Figure 6) and for bank, adequate performance is defined as being within 2 widths of the airplane symbol on the PFD (Figure 7).
- If no improvement is warranted, then you can give a rating of 1, 2, or 3. For pitch, desired performance is defined as being within ½ width of the airplane symbol on the PFD (Figure 8) and for bank angle, desired performance is defined as being within 1 width of the airplane symbol (Figure 9).
- Go over meaning of text for numbered ratings
- If you want to change your answer after you hit the “NEXT” button, just let me know and I’ll make a note of it
- The next set of questions you may have to answer have to do with workload (Figure 10).
  - Go over each of the scales
  - To make a rating, just touch anywhere on the scale
  - To change your rating, you can either just touch where you want to bar to jump to or you can drag the bar to the new rating
  - Once you have made all 6 ratings, the “NEXT” button becomes active
- After you answer the questions above, you will then be briefed for the next data run
- I can answer questions on how the simulator works but not what is going on during the runs. If there is a simulation error, we will advise you.

### **Final Questionnaire**

- At the end of the data runs, you will complete a final questionnaire asking for your opinions on the displays you just saw and your ability to fly the sUAS
- You will also have a quick debriefing session where you can add any other input

### **Runs**

- You will have multiple data runs, using first the \_\_\_\_\_ display, then the \_\_\_\_\_ display, and finally the \_\_\_\_\_ display
- Before the data runs after a display change, you will have at least 1 practice run which shall behave just like the data runs
- At any time, please feel free to take/ask for a break
- Any questions?

# Appendix K: Informed Consent Form

## Human Subject Research Volunteer Informed Consent Statement

**Title of Research:** Small Unmanned Aircraft Systems Human-Systems Integration Human-in-the-Loop 01

**Principal Investigator/Phone:** Anna C. Trujillo, Principle Investigator and Senior Research Engineer, NASA LaRC Crew Systems and Aviation Operations Branch, (757) 864-8047, anna.c.trujillo@nasa.gov

**Co-Investigators/Phone:**

Raymon Mcadaragh, Aerospace Psychologist, SGT Inc., NASA LaRC Crew Systems and Aviation Operations Branch, 757-864-6055, raymon.mcadaragh@nasa.gov

Daniel Burdette, Research Engineer, Northrop Grumman, NASA LaRC Crew Systems and Aviation Operations Branch, 757-864-6644, daniel.w.burdette@nasa.gov

James R. Comstock, Jr., Ph.D., Research Engineer, NASA LaRC Crew Systems and Aviation Operations Branch, 757-864-6643, james.r.comstock@nasa.gov

Rania Ghatas, Research Engineer, NASA LaRC Crew Systems and Aviation Operations Branch, 757-864-5411, rania.w.ghatas@nasa.gov

Federal regulations require researchers to obtain signed consent for participation in research involving human subjects. After reading the information and the Statement of Consent below, if you wish to consent, please indicate so by signing this Informed Consent.

### I. Statement of Procedure:

Thank you for your interest in this research. By this time, you should have had the experimental rationale and procedures discussed with you in detail. You will find a summary of the major aspects of this research below, including the risks and benefits of participating. Please feel free to ask any questions about the procedures at any time. Carefully read the information provided below. IF YOU WISH TO PARTICIPATE in this study, please sign your name and date the form in the space provided on the last page. Any information you provide will be maintained in strict confidence to protect your privacy.

### II. I understand that:

- This is a research experiment. There will be approximately 9 individuals participating in this study.
- I will be participating in a research activity whose objective is to build a small Unmanned Aircraft System Ground Control Station and to test if the sUAS information elements are sufficient for a pilot to safely fly in the National Airspace System (NAS).
- This study will be performed at NASA Langley Research Center in Hampton, Virginia, in the Test and Evaluation Simulator (TES). The TES is a fixed-based (no motion) 180 degree view simulator.

- I will receive training on the operation of the equipment that I will operate and a briefing on the tasks in which I will participate. I will be allowed time to familiarize myself with the equipment prior to starting my participation in the research.
- If I consent to participate in the research, I will be asked to fly approximately 9 unmanned aircraft simulated runs while evaluating the Ground Control Station. Each run lasts approximately 30 minutes. After each run, I will be asked to fill out three separate questionnaires.
- During the course of the research, I will provide my impressions and assessments by providing my input and completing multiple questionnaires, which will include a situation awareness questionnaire, a ground control station display questionnaire, a NASA-TLX workload questionnaire, a Cooper-Harper rating scale, and a final questionnaire. I will also receive a privacy act notice and complete a background questionnaire. I will also participate in a post-experiment debriefing.
- The duration of my participation will require approximately 8 hours of my time over 1 day. I may take a break at any time, though I am encouraged to complete each scenario before taking a break.
- I may contact list PI names and telephone number and email addresses if I have any questions regarding this experiment before, during, or after the participation.

### **III. Compensation**

Non-government volunteers will be compensated for their participation.

Civil servant volunteers who participate in the research do so in their official capacity. A civil servant injured during the course of this research may file for compensation through the Federal Workers Compensation System. For additional information, I may contact the LaRC Office of Human Resources at 757-864-2554.

Non-civil servant volunteers injured as a result of participating in the research may file a claim under the Federal Tort Claims Act by filing Standard Form 95. For additional information, I may contact the LaRC Office of the Chief Counsel at 757-864-3221. Additionally, in the event of injury insurance coverage is provided to me as a research subject volunteer under the NASA Langley Teams II contract. For additional information, I may contact Regina Johns at 757-864-9168.

### **IV. Potential Risks**

- There are no apparent risks associated with participation in this study other than those experienced during normal participation in flight simulation activity. In the event that something does occur, I may request to stop the experiment at any time.
- In the unlikely event that I am injured or otherwise experience discomfort while at NASA Langley, I may visit the on-site Occupational Health Clinic. The Clinic has hours of operation from 7:00 a.m. to 3:30 p.m. The clinic number is 864-3193. Emergency medical personnel and ambulance service is also available to transport me to nearby health care providers.
- If I have questions about the research and my rights should I experience any injury, I may contact the principal investigators listed at the beginning of this document.

## **V. Potential Benefits**

I will derive no personal benefit apart from the compensation noted above, except the knowledge that my participation has contributed to the literature and data available within a particular research discipline. Overall, the research will contribute to a better understanding of crew systems research and the chance to directly affect the information elements of a sUAS Ground Control Station (GCS). Hence, all members of the aviation and research community and the flying public are potential beneficiaries of the research.

## **VI. Confidentiality (Address how information is recorded, shared, and protected. Add other information unique to the research in question)**

- I understand that any public release of any data will be done in a manner that does not associate me with the data.
- I understand that the data files recorded during my participation in this research activity may be shared with other researchers within NASA (and outside NASA, if applicable) and that these files will be identified only by the subject number assigned by the experimenter.
- I do voluntarily consent to sharing the data files recorded during my data collection session, as long as my identity is not disclosed.

## **VII. Voluntary Participation**

Taking part in this study is voluntary. I may withdraw from participating or be asked to withdraw from participating at any time. Such a decision will not result in any penalty or loss of benefits to which I may otherwise be entitled.

## **VIII. Safety**

As a voluntary test subject participating in this research, I understand that:

- NASA is committed to ensuring my safety, health, and welfare plus the safety and health of all others involved with this research.
- I should report any accident, injury, illness, and changes in my health condition, hazards, safety concerns, or health concerns to Anna Trujillo at (757) 864-8047 or at [anna.c.trujillo@nasa.gov](mailto:anna.c.trujillo@nasa.gov). If I am unable to reach the above named individuals or am not satisfied with the response I receive, I should contact the LaRC Safety Office at (757) 864-7233 or the Chairperson of the LaRC Institutional Review Board, Mr. Jeffrey S. Hill, at (757) 864-5107.
- If I detect any unsafe condition that presents an imminent danger to me, or others, I have the right and authority to stop the activity or test. In such cases the Principal Investigator and associated research personnel will comply with my direction, stop the activity, and take action to address the imminent danger.

**XI. Statement of Consent:**

- I certify that I have read and fully understand the explanation of procedures, benefits, and risks associated with the research herein, and I agree to participate in the research described herein. My participation is given voluntarily and without coercion or undue influence, and I also voluntarily consent to sharing the data files recorded during my data collection session, as long as my identity is not disclosed. I understand that I may discontinue participation at any time. I have been provided a copy of this consent statement. If I have any questions or modifications to this consent statement, they are written below.

Signature of Subject: \_\_\_\_\_

Name (Print legal name): \_\_\_\_\_ Date: \_\_\_\_\_

\_\_ Participant has been provided with a Privacy Act Statement meeting the requirements outlined in 14 CFR 1212.602

**Principal Investigator (or Designee):**

I have given this subject information about this study. I believe this to be accurate and complete. The subject has indicated that he or she understands the nature of the risks and benefits of participating in this study.

Name: \_\_\_\_\_ Title: \_\_\_\_\_

Signature: \_\_\_\_\_ Date: \_\_\_\_\_

# Appendix L: Privacy Act Notice

## PRIVACY ACT NOTICE COLLECTION OF INFORMATION TO DETERMINE ELIGIBILITY TO PARTICIPATE IN RESEARCH AS A SUBJECT VOLUNTEER

### GENERAL

This information is provided pursuant to Public Law 93-579 (Privacy Act of 1974), December 31, 1974, for individuals supplying information for inclusion in a system of records.

### AUTHORITY

The authority to collect the information requested from you in the informed consent associated with **sUAS HSI HITL01** in which you may participate is derived from one or more of the following: Title 14, Code of Federal Regulations, Sections 1212 and 1230; Title 42, United States Code, Section 2451, as amended.

### PURPOSES AND USES

The information you supply will be used to determine your eligibility to participate as a volunteer subject in the **sUAS HSI HITL01**. The information you provide will be evaluated by NASA employees and contractors overseeing and conducting the research. Your personal identifying information will not be shared outside of NASA and contractor and intern researchers working with NASA who are associated with this particular research. Your personal identifying information will be maintained under secure conditions (locked file), and only the Principal Investigator(s) (PI) overseeing your research will have access to your personal identifying information contained within the file.

The information will be maintained in a NASA System of Records: Human Experimental Research Data Records (NASA 10HERD). The information supplied is confidential and will be maintained under secure conditions as described above but is subject to routine uses for such information that are identified in System of Record Notice for Human Experimental Research Data Records published at 72 Federal Register 55812 on October 1, 2007. Release of such information is not permissible where your consent is required.

### EFFECTS OF NONDISCLOSURE

Disclosure of the personal identifying information sought is voluntary; however, failure to furnish the information could exclude you from being able to participate as a volunteer in the research.

\_\_\_\_\_  
Signature of Interviewer

\_\_\_\_\_  
Signature of Volunteer

Date: \_\_\_\_\_



# Appendix M: Mission Tracks

The following figures show the mission tracks for the last data run for each display condition for each subject. They are order by display condition (VLOS, PFD, Map) then subject. The red dotted box indicates visual-line-of-sight area from the eye point and the green horizontal line indicates the prescribed altitude.

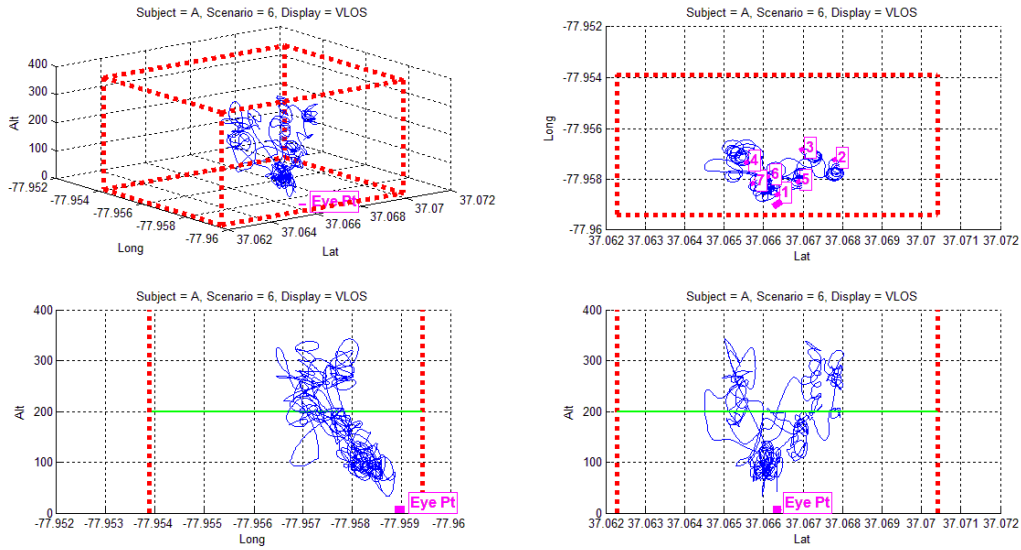

Figure M-1: Subject A Mission Track for Scenario 6, Data Run 6, VLOS

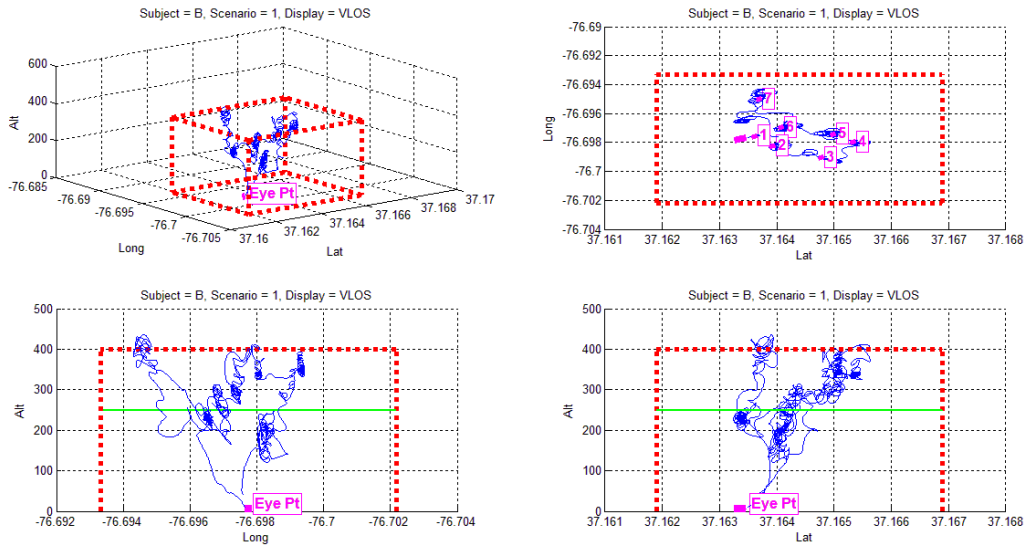

Figure M-2: Subject B Mission Track for Scenario 1, Data Run 3, VLOS

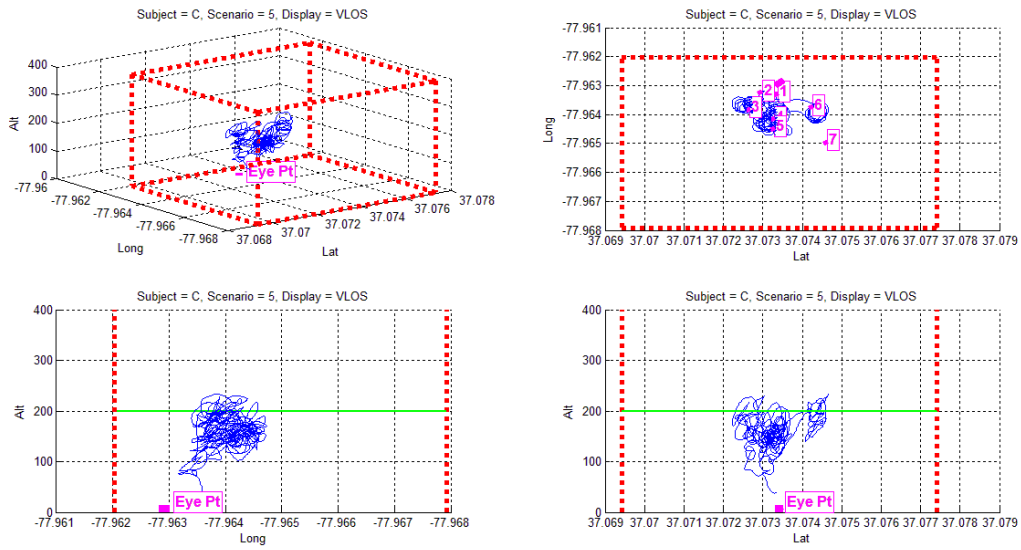

Figure M-3: Subject C Mission Track for Scenario 5, Data Run 3, VLOS

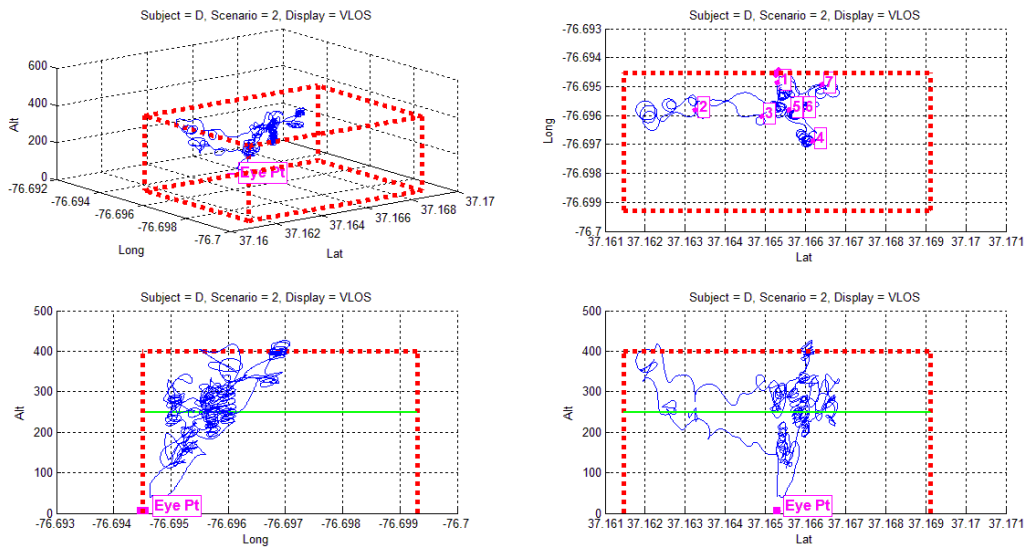

Figure M-4: Subject D Mission Track for Scenario 2, Data Run 6, VLOS

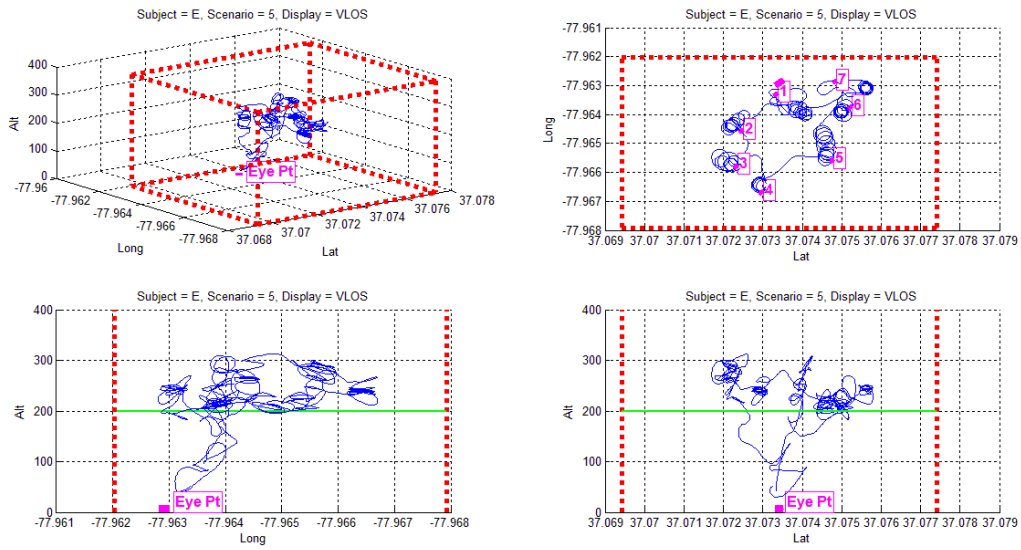

Figure M-5: Subject E Mission Track for Scenario 5, Data Run 9, VLOS

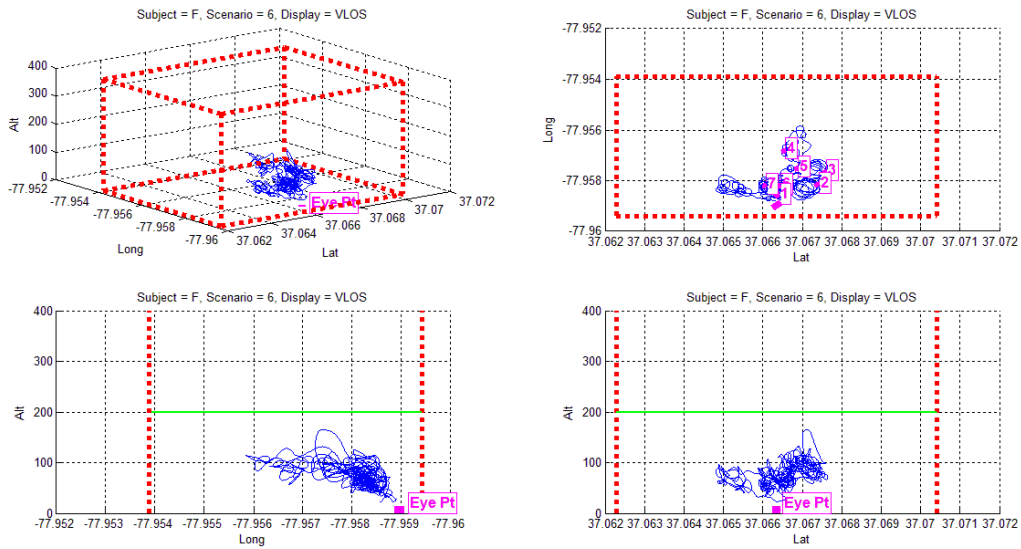

Figure M-6: Subject F Mission Track for Scenario 6, Data Run 3, VLOS

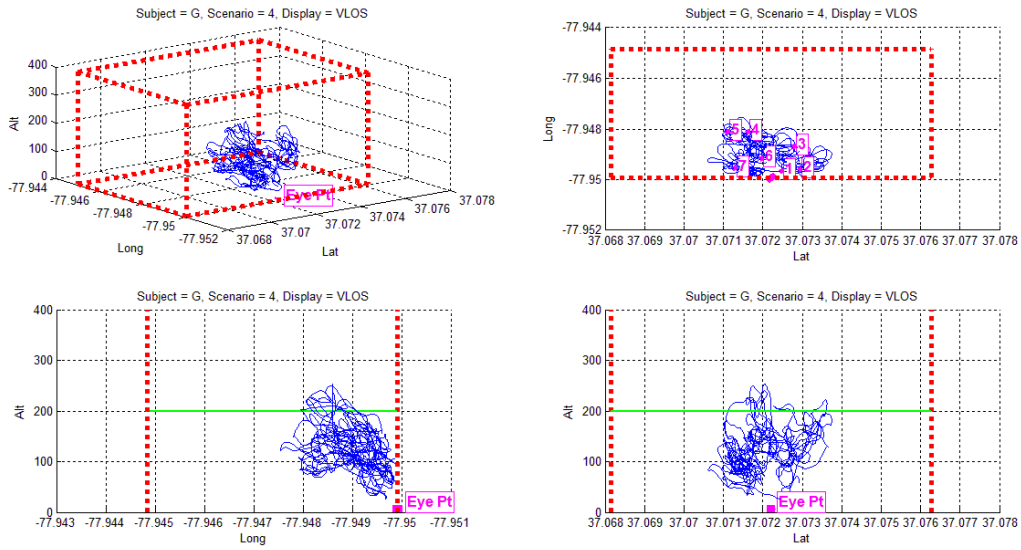

Figure M-7: Subject G Mission Track for Scenario 4, Data Run 6, VLOS

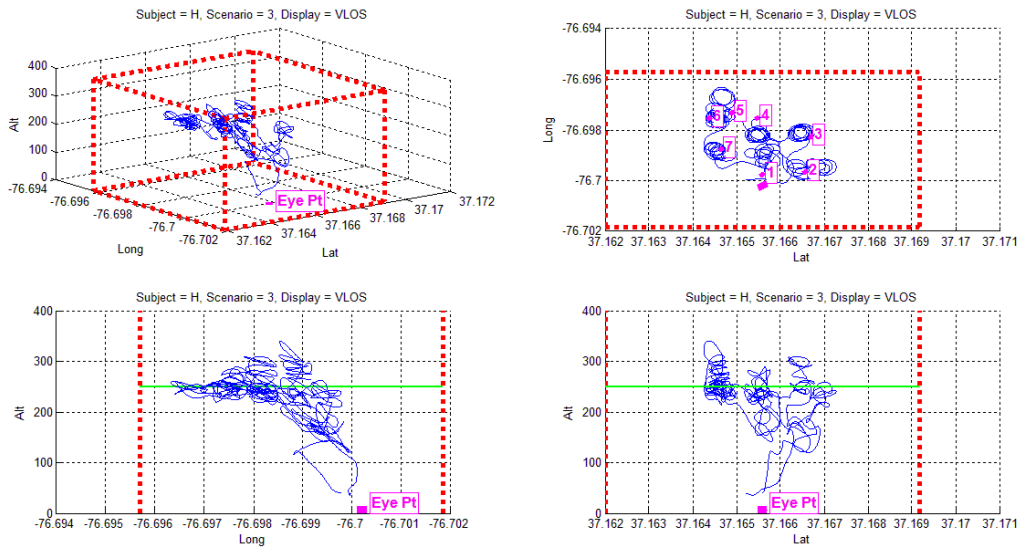

Figure M-8: Subject H Mission Track for Scenario 3, Data Run 9, VLOS

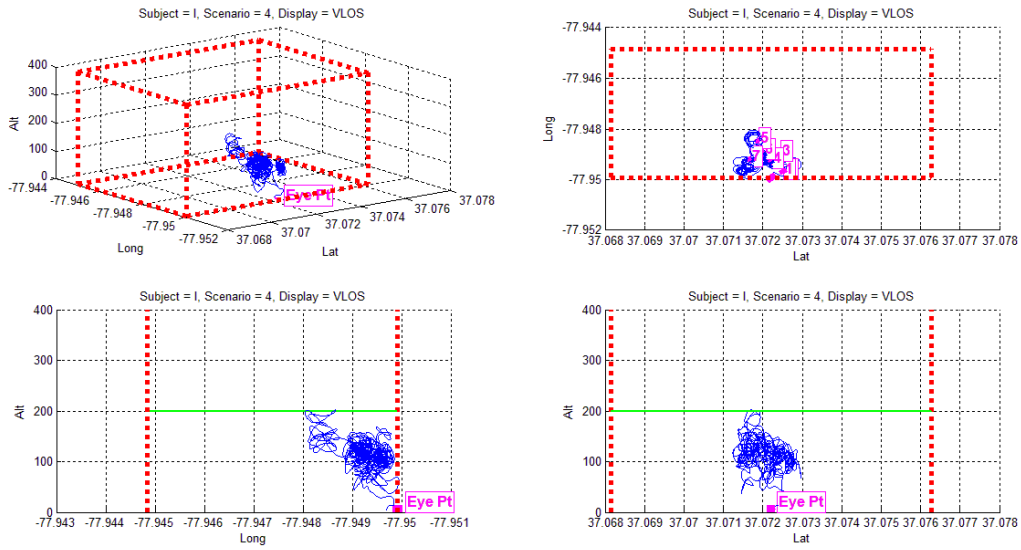

Figure M-9: Subject I Mission Track for Scenario 4, Data Run 9, VLOS

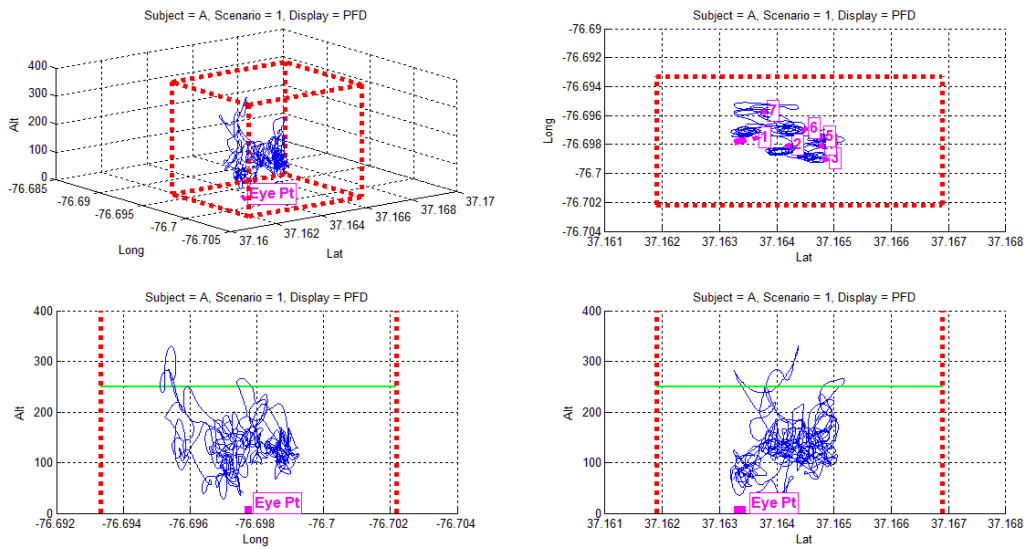

Figure M-10: Subject A Mission Track for Scenario 1, Data Run 7, PFD

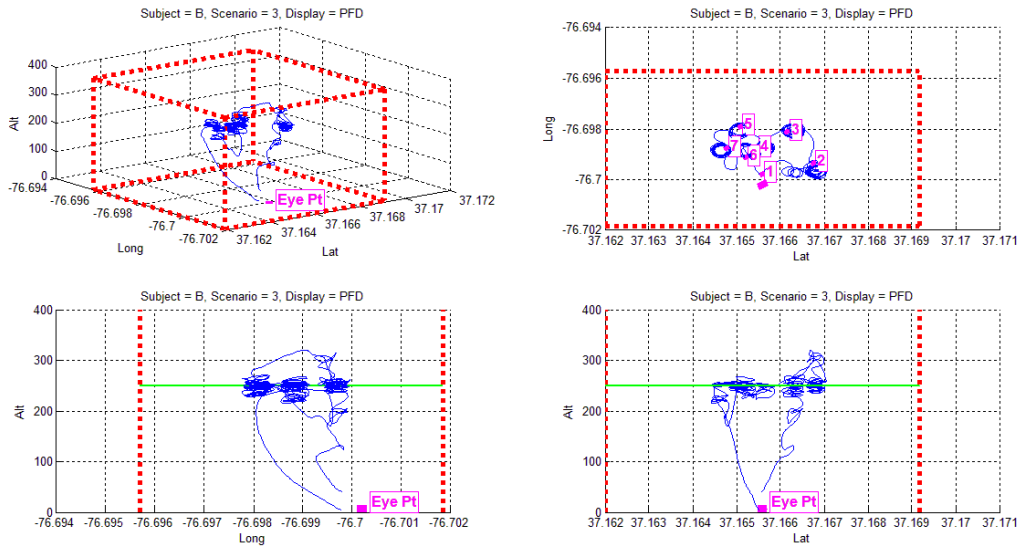

Figure M-11: Subject B Mission Track for Scenario 3, Data Run 6, PFD

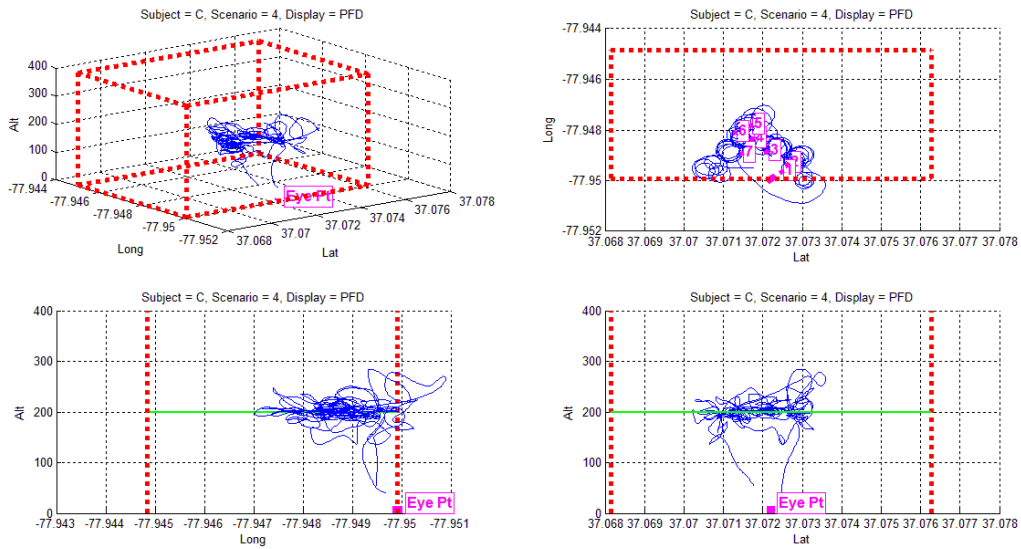

Figure M-12: Subject C Mission Track for Scenario 4, Data Run 6, PFD

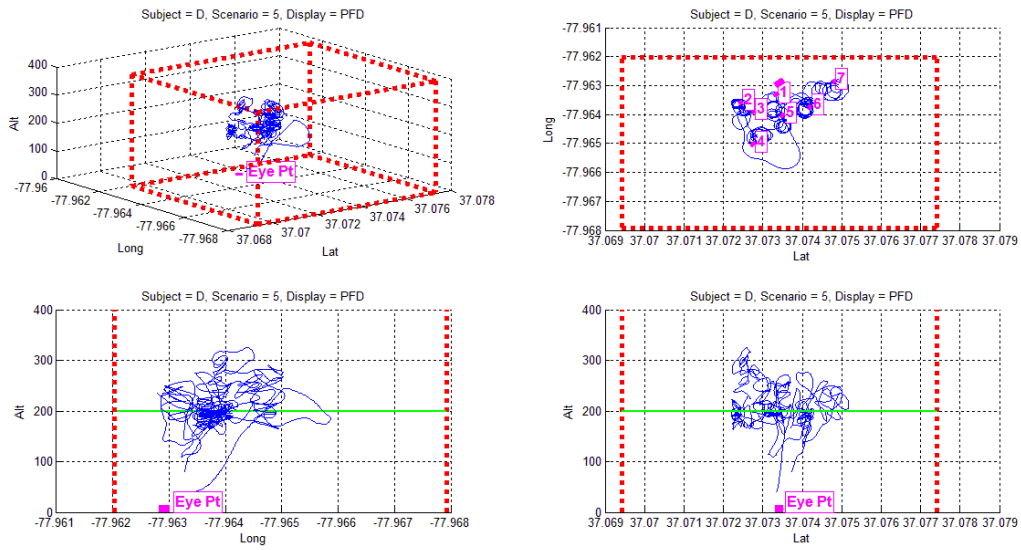

Figure M-13: Subject D Mission Track for Scenario 5, Data Run 9, PFD

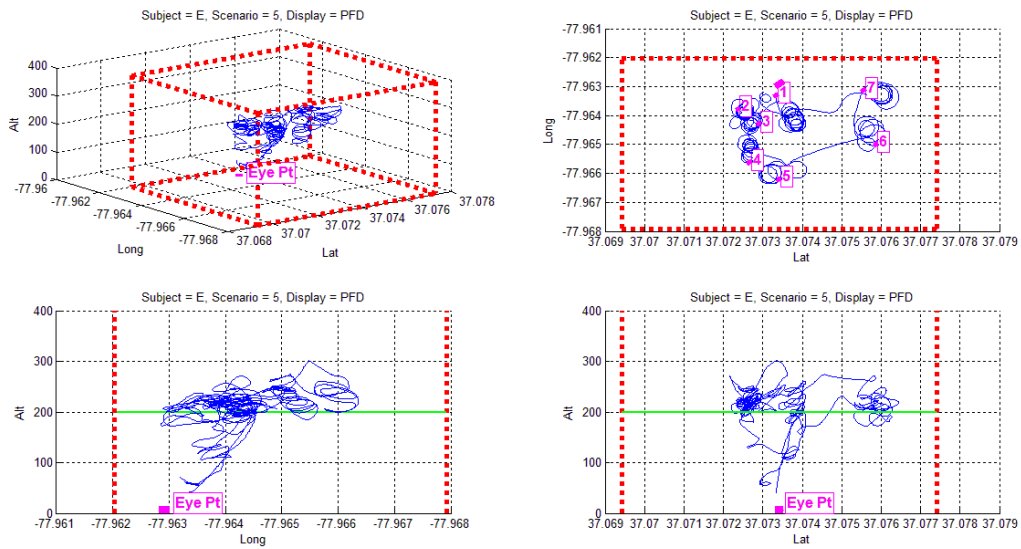

Figure M-14: Subject E Mission Track for Scenario 5, Data Run 3, PFD

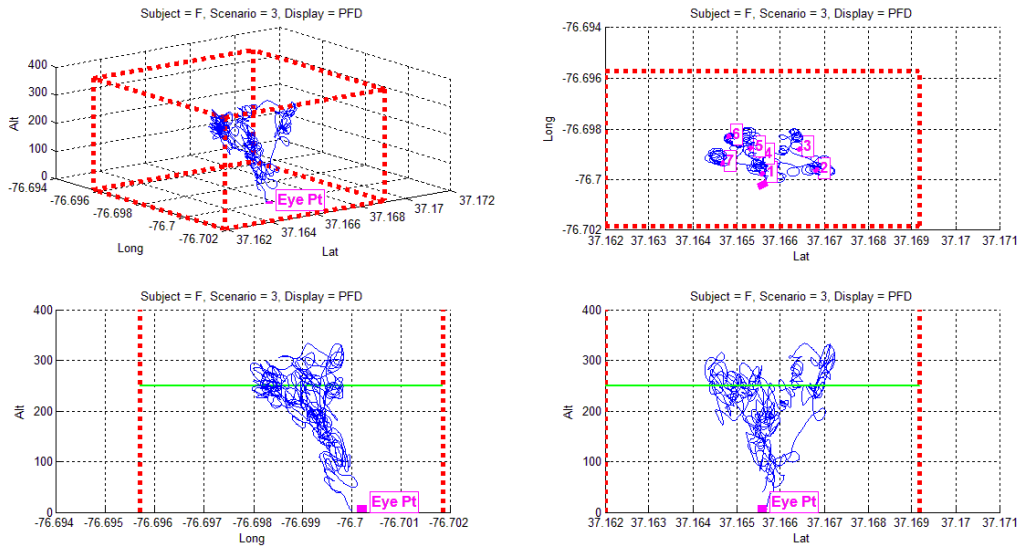

Figure M-15: Subject F Mission Track for Scenario 3, Data Run 6, PFD

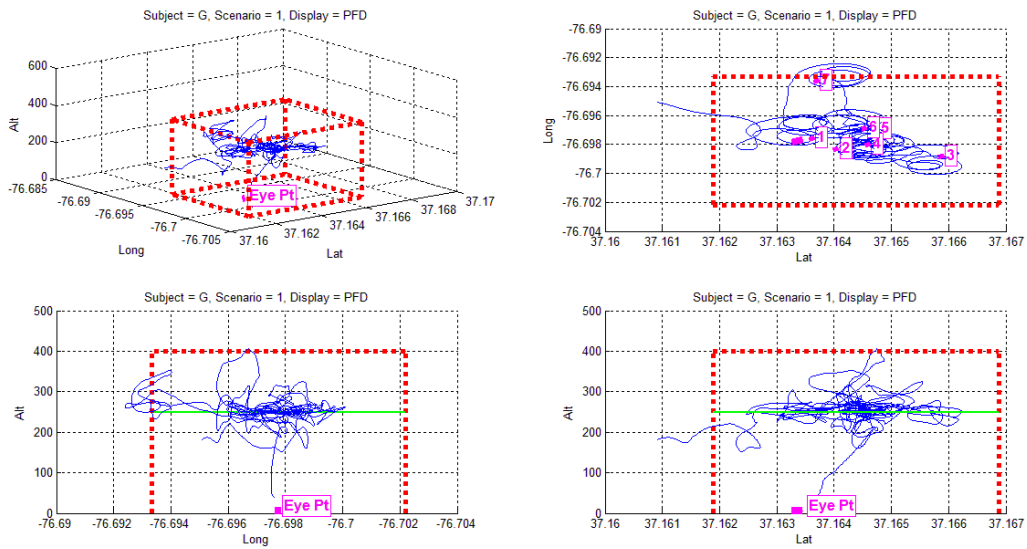

Figure M-16: Subject G Mission Track for Scenario 1, Data Run 9, PFD



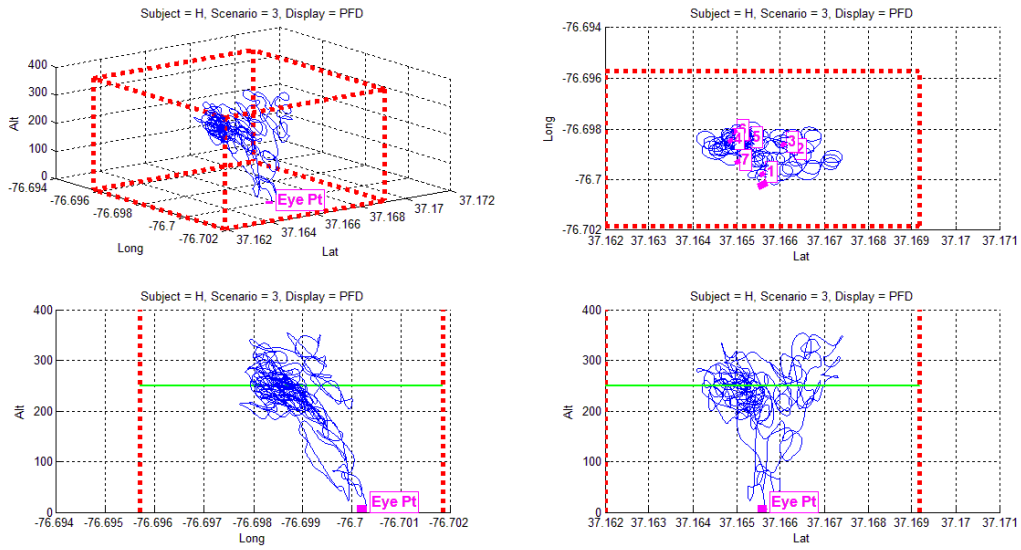

Figure M-17: Subject H Mission Track for Scenario 3, Data Run 3, PFD

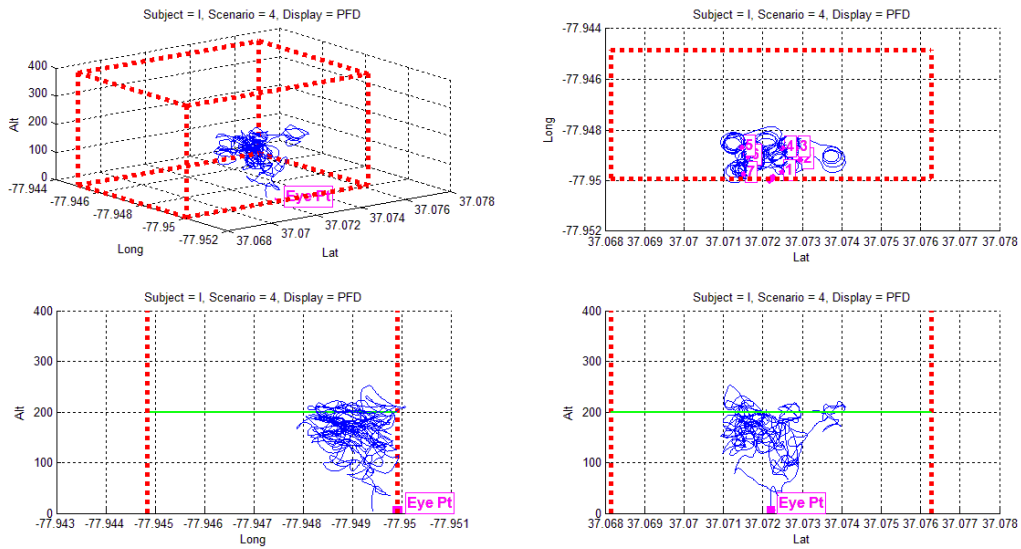

Figure M-18: Subject I Mission Track for Scenario 4, Data Run 3, PFD

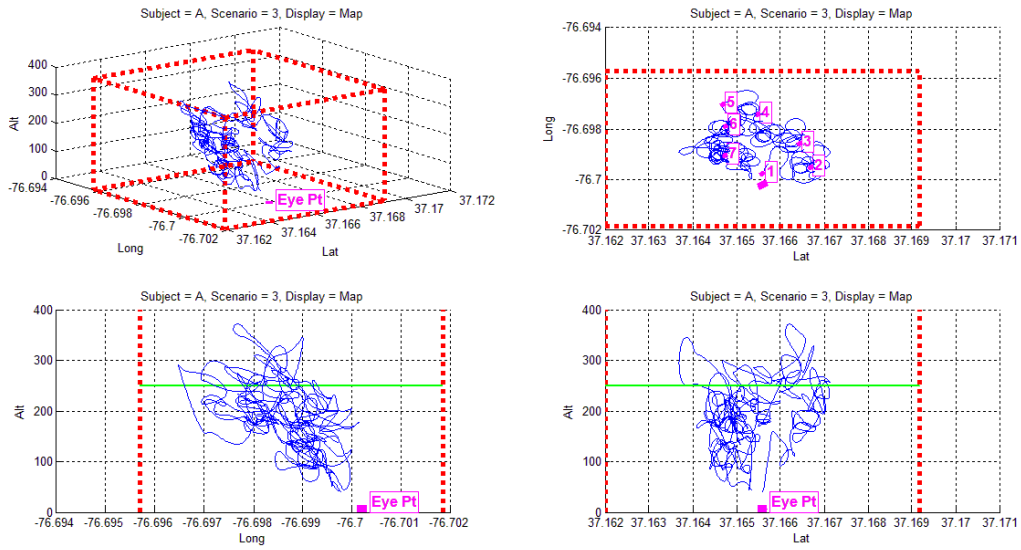

Figure M-19: Subject A Mission Track for Scenario 3, Data Run 3, Map

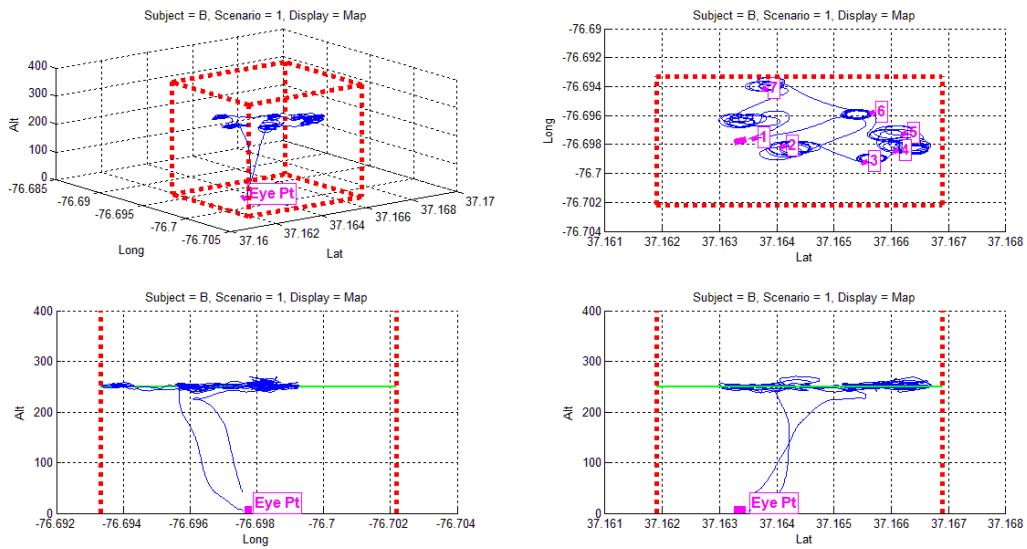

Figure M-20: Subject B Mission Track for Scenario 1, Data Run 9, Map

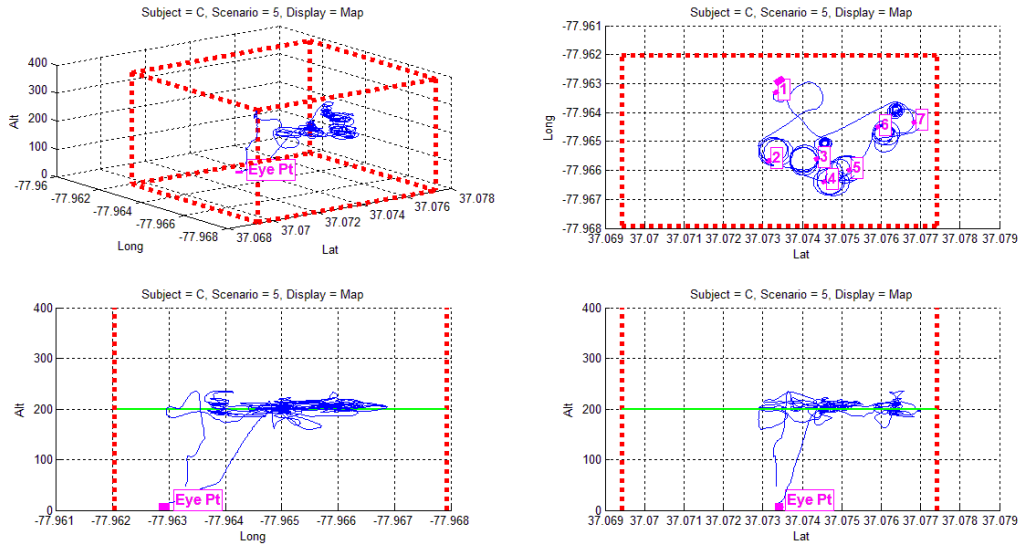

Figure M-21: Subject C Mission Track for Scenario 5, Data Run 9, Map

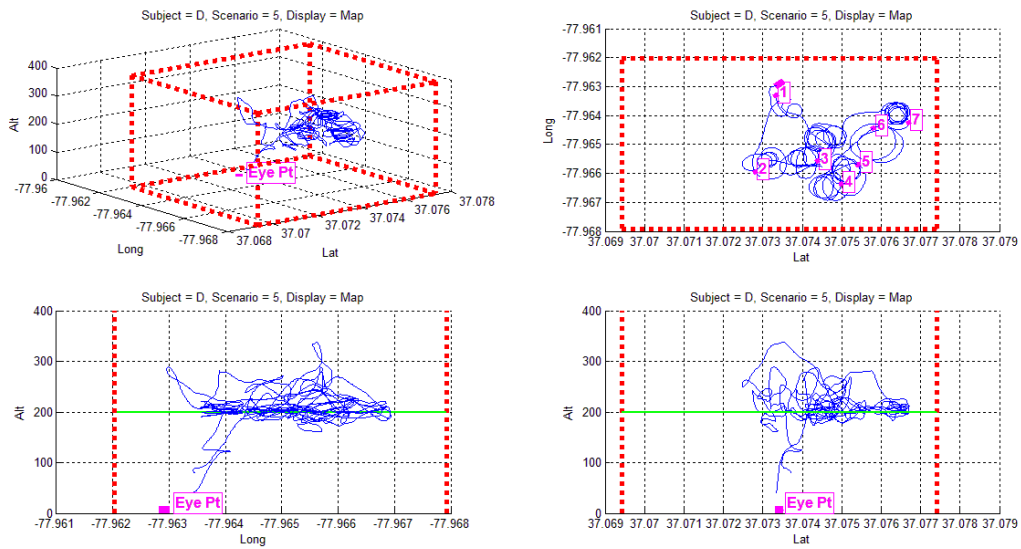

Figure M-22: Subject D Mission Track for Scenario 5, Data Run 3, Map

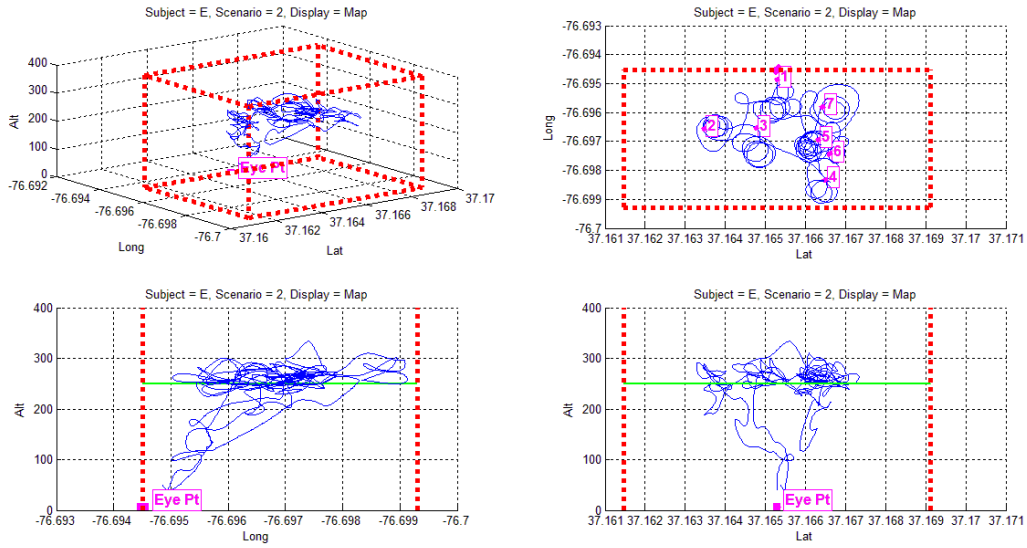

Figure M-23: Subject E Mission Track for Scenario 2, Data Run 6, Map

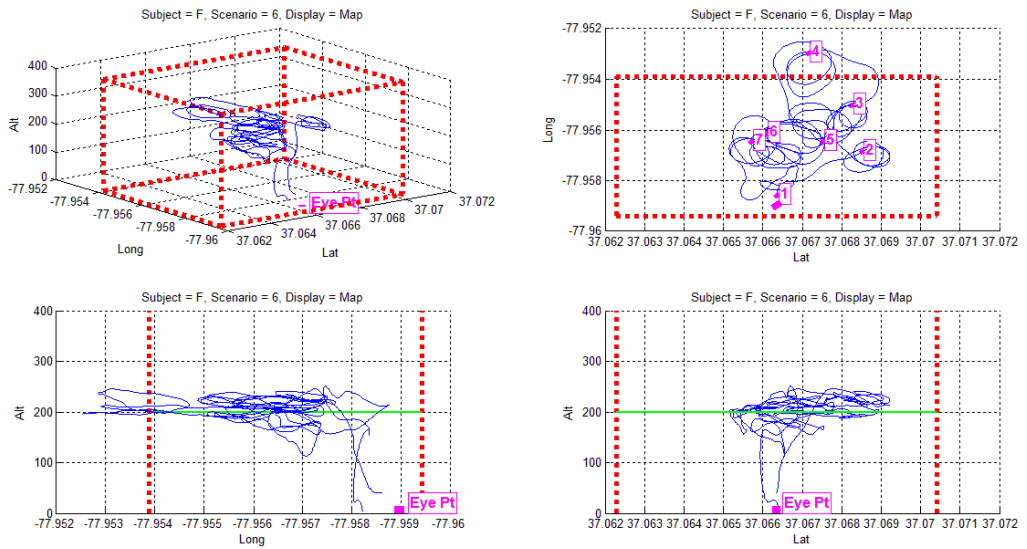

Figure M-24: Subject F Mission Track for Scenario 6, Data Run 9, Map

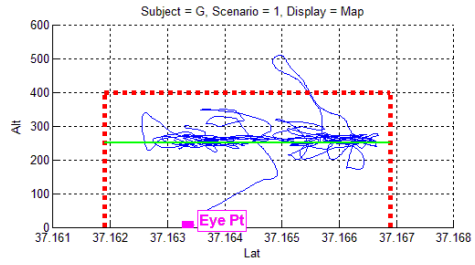
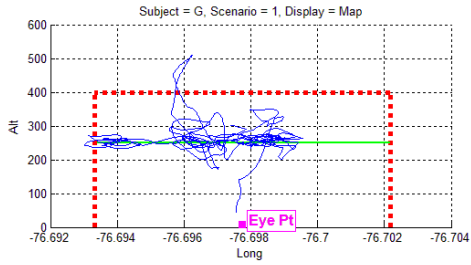
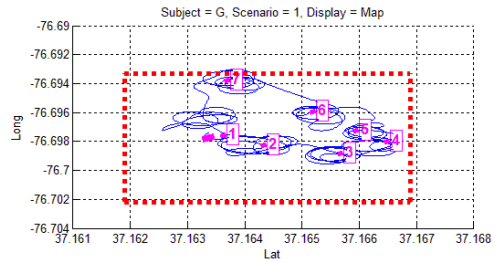
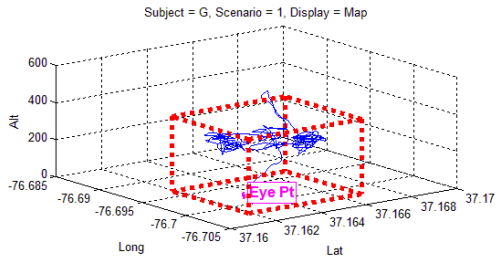

Figure M-25: Subject G Mission Track for Scenario 1, Data Run 3, Map

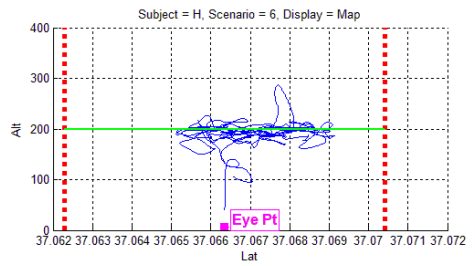
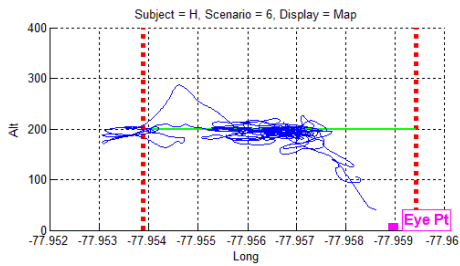
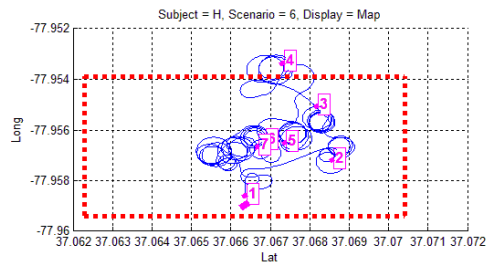
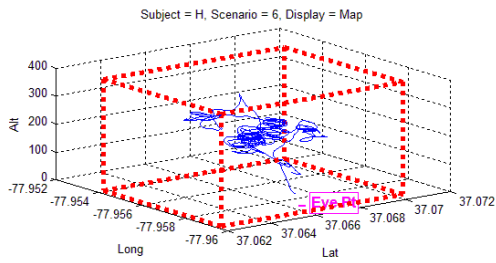

Figure M-26: Subject H Mission Track for Scenario 6, Data Run 6, Map

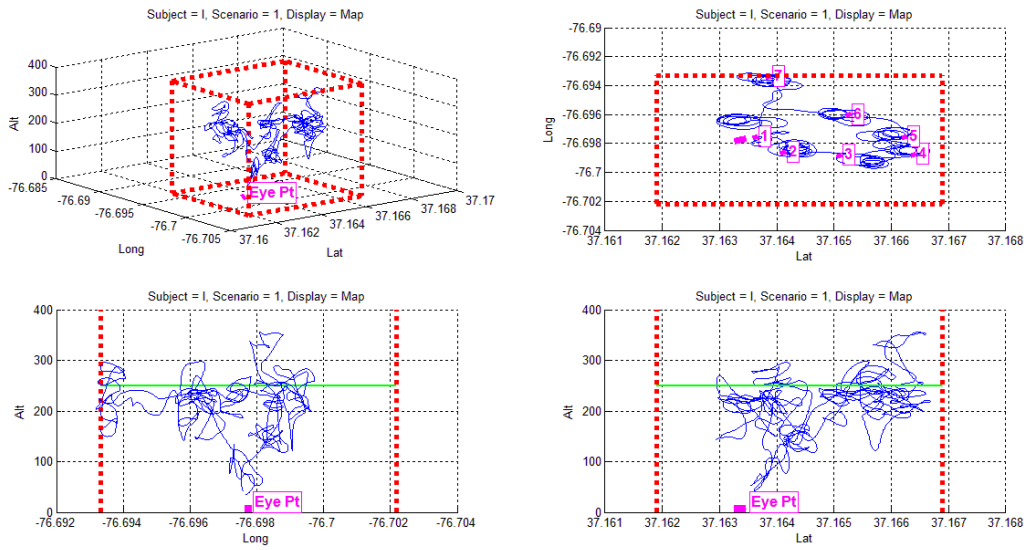

Figure M-27: Subject I Mission Track for Scenario 1, Data Run 6, Map

**REPORT DOCUMENTATION PAGE**

*Form Approved  
OMB No. 0704-0188*

The public reporting burden for this collection of information is estimated to average 1 hour per response, including the time for reviewing instructions, searching existing data sources, gathering and maintaining the data needed, and completing and reviewing the collection of information. Send comments regarding this burden estimate or any other aspect of this collection of information, including suggestions for reducing this burden, to Department of Defense, Washington Headquarters Services, Directorate for Information Operations and Reports (0704-0188), 1215 Jefferson Davis Highway, Suite 1204, Arlington, VA 22202-4302. Respondents should be aware that notwithstanding any other provision of law, no person shall be subject to any penalty for failing to comply with a collection of information if it does not display a currently valid OMB control number.  
**PLEASE DO NOT RETURN YOUR FORM TO THE ABOVE ADDRESS.**

<b>1. REPORT DATE (DD-MM-YYYY)</b> 01-02-2015		<b>2. REPORT TYPE</b> Technical Memorandum		<b>3. DATES COVERED (From - To)</b>	
<b>4. TITLE AND SUBTITLE</b>  Small Unmanned Aircraft Systems Integration into the National Airspace System Visual-Line-of-Sight Human-in-the-Loop Experiment				<b>5a. CONTRACT NUMBER</b>	
				<b>5b. GRANT NUMBER</b>	
				<b>5c. PROGRAM ELEMENT NUMBER</b>	
<b>6. AUTHOR(S)</b>  Trujillo, Anna C.; Ghatas, Rania W.; McAdaragh, Raymon; Burdette, Daniel W.; Comstock, James R.; Hempley, Lucas E.; Fan Hui				<b>5d. PROJECT NUMBER</b>	
				<b>5e. TASK NUMBER</b>	
				<b>5f. WORK UNIT NUMBER</b>  425425.01.01.07.01	
<b>7. PERFORMING ORGANIZATION NAME(S) AND ADDRESS(ES)</b> NASA Langley Research Center Hampton, VA 23681-2199				<b>8. PERFORMING ORGANIZATION REPORT NUMBER</b>  L-20366	
<b>9. SPONSORING/MONITORING AGENCY NAME(S) AND ADDRESS(ES)</b> National Aeronautics and Space Administration Washington, DC 20546-0001				<b>10. SPONSOR/MONITOR'S ACRONYM(S)</b>  NASA	
				<b>11. SPONSOR/MONITOR'S REPORT NUMBER(S)</b>  NASA-TP-2015-218684	
<b>12. DISTRIBUTION/AVAILABILITY STATEMENT</b> Unclassified - Unlimited Subject Category 01 Availability: NASA STI Program (757) 864-9658					
<b>13. SUPPLEMENTARY NOTES</b>					
<b>14. ABSTRACT</b>  As part of the Unmanned Aircraft Systems (UAS) in the National Airspace System (NAS) project, research on integrating small UAS (sUAS) into the NAS was underway by a human-systems integration (HSI) team at the NASA Langley Research Center. Minimal to no research has been conducted on the safe, effective, and efficient manner in which to integrate these aircraft into the NAS. sUAS are defined as aircraft weighing 55 pounds or less. The objective of this human system integration team was to build a UAS Ground Control Station (GCS) and to develop a research test-bed and database that provides data, proof of concept, and human factors guidelines for GCS operations in the NAS. The objectives of this experiment were to evaluate the effectiveness and safety of flying sUAS in Class D and Class G airspace utilizing manual control inputs and voice radio communications between the pilot, mission control, and air traffic control. The design of the experiment included three sets of GCS display configurations, in addition to a hand-held control unit. The three different display configurations were VLOS, VLOS + Primary Flight Display (PFD), and VLOS + PFD + Moving Map (Map).					
<b>15. SUBJECT TERMS</b>  Airspace; Experiment design; Ground based control; Man machine system; System integration; Unmanned aircraft systems					
<b>16. SECURITY CLASSIFICATION OF:</b>			<b>17. LIMITATION OF ABSTRACT</b>	<b>18. NUMBER OF PAGES</b>	<b>19a. NAME OF RESPONSIBLE PERSON</b>
<b>a. REPORT</b>	<b>b. ABSTRACT</b>	<b>c. THIS PAGE</b>			STI Help Desk (email: help@sti.nasa.gov)
U	U	U	UU	130	<b>19b. TELEPHONE NUMBER (Include area code)</b>  (757) 864-9658