



Thermal Runaway Severity Reduction Assessment & Implementation: On Li-ion Batteries

**By
Eric Darcy/NASA-JSC**

**For
2015 Electric & Hybrid Vehicle Technology Conference
Novi, MI
17 Sept 2015**

Agenda

- Background on EVA batteries
- Show you how subscale testing can be misleading
- Full scale 45-cell pack test leads to catastrophic hazard
- Full scale improved 45-cell pack protects adjacent cells
- 45-cell pack with flame arresting measures in a soft goods enclosure
- Full scale 10-cell pack design leads to catastrophic hazard
- Full scale 10-cell improved pack with severity reduction measures works
- 1 kWh battery safety demo with 660 Wh/L cell design
 - How to handle the risk of cell can wall breaching
- **Summary conclusions – Preventing cell-cell TR propagation and flames/sparks from exiting battery enclosure is possible with proper thermal & electrical design and cell TR ejecta/effluent management and can be had with minimal mass/volume penalty**

Big Team Effort

- TR Severity Reduction Team
 - Chris Iannello, NESC Technical Fellow for Electrical Power, and Deputy, Rob Button
 - Paul Shack, Assessment Lead
 - Steve Rickman, NESC Technical Fellow for Passive Thermal
 - Eric Darcy, Test Lead for EVA Batteries, NASA-JSC
 - Sam Russell, Mike Fowler, Craig Clark, John Weintritt, Christina Deoja, Thomas Viviano, Dereck Lenoir, and Stacie Cox/NASA-JSC
 - Bob Christie, Tom Miller, Penni Dalton/NASA-GRC
 - Dan Doughty, Bruce Drolen, Ralph White, Gary Bayles, and Jim Womack/NESC Consultants
 - Brad Strangways/SRI

Background - Li-ion Rechargeable EVA Battery Assembly (LREBA)

Current Design Baseline – April 2014

- 9P cell banks with cell glued in picket fence array
- ¼" Ni-201 tabs interconnecting cells
- Cell vents oriented towards edge of housing tray
- Cell banks wrapped in 1/8" thick Nomex felt
- Only vents on enclosure are for pressure equalization

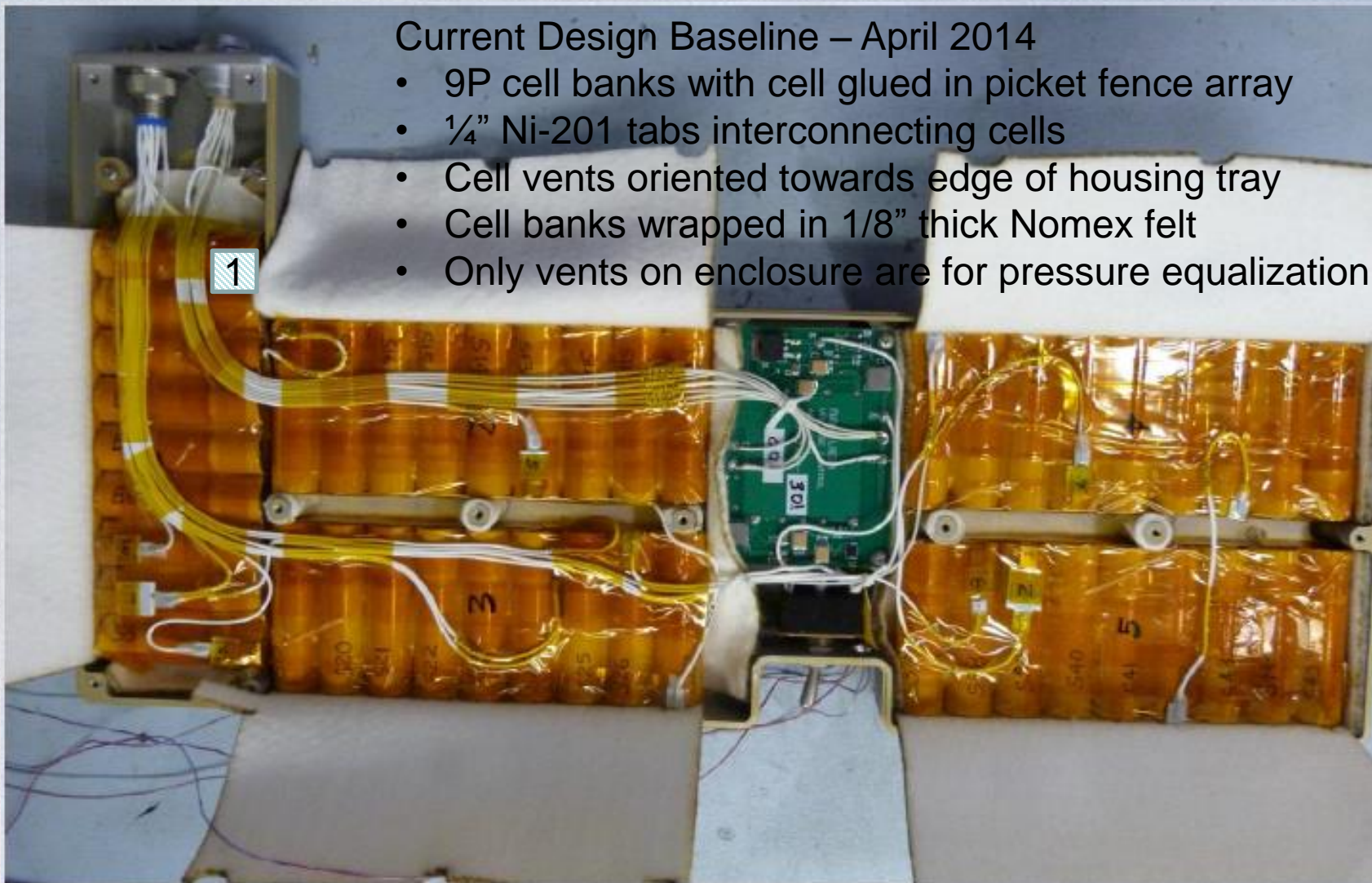

9P-5S Array of Samsung 2.6Ah 18650 cells to power the spacesuit helmet lights and camera and glove heaters

Selected Bottom Patch Heaters For Triggering TR

- Two small (3/4" x 3/4") patch heaters located on the bottom of cylindrical can
 - Nichrome wire glued to Mica paper
 - Adhered to bare can by cement based adhesive
- Each has 6" of Nichrome wire for a total of 12" per pair
 - Pair can be powered by up to 90W
- Main benefit of design – more relevant cell internal short
 - Deliver high heat flux away from seals, PTC, and CID located in cell header
 - leaves an axial bond line undisturbed for gluing cell together in one plane
 - More likely to result in coincident cell venting and TR runaway

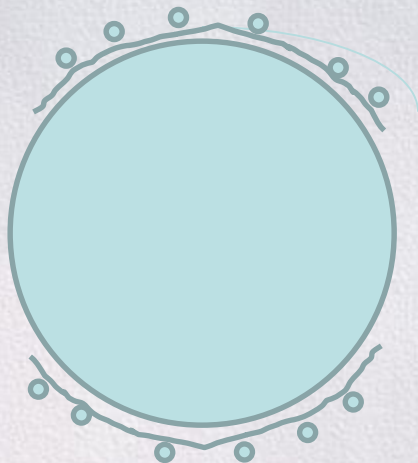

Cell TR Response vs Heat Power

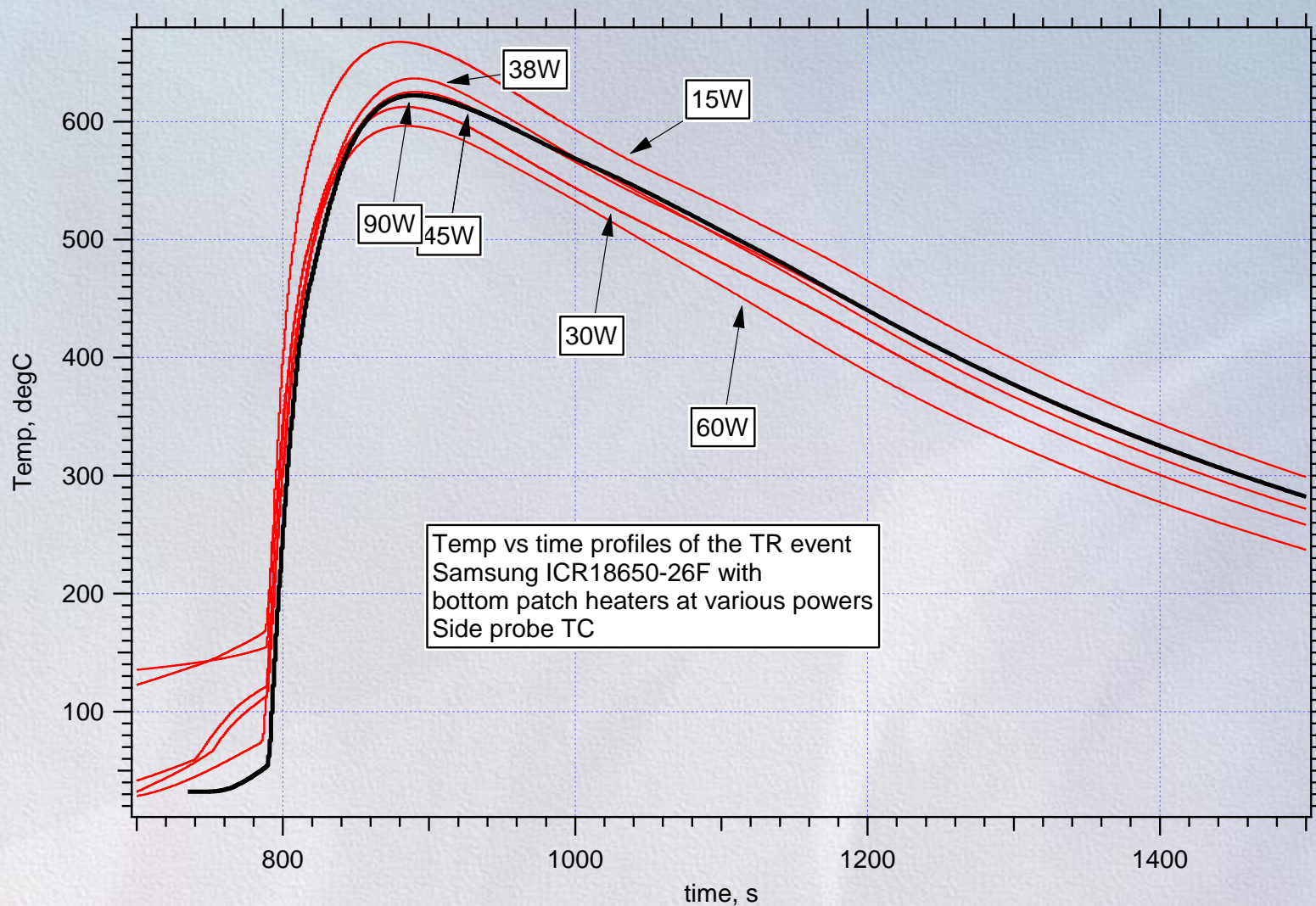

- TR output heat fairly independent of heater input power
- High power preferred to reduce risk of biasing hot adjacent cells

Higher W triggers with Lower Wh Input

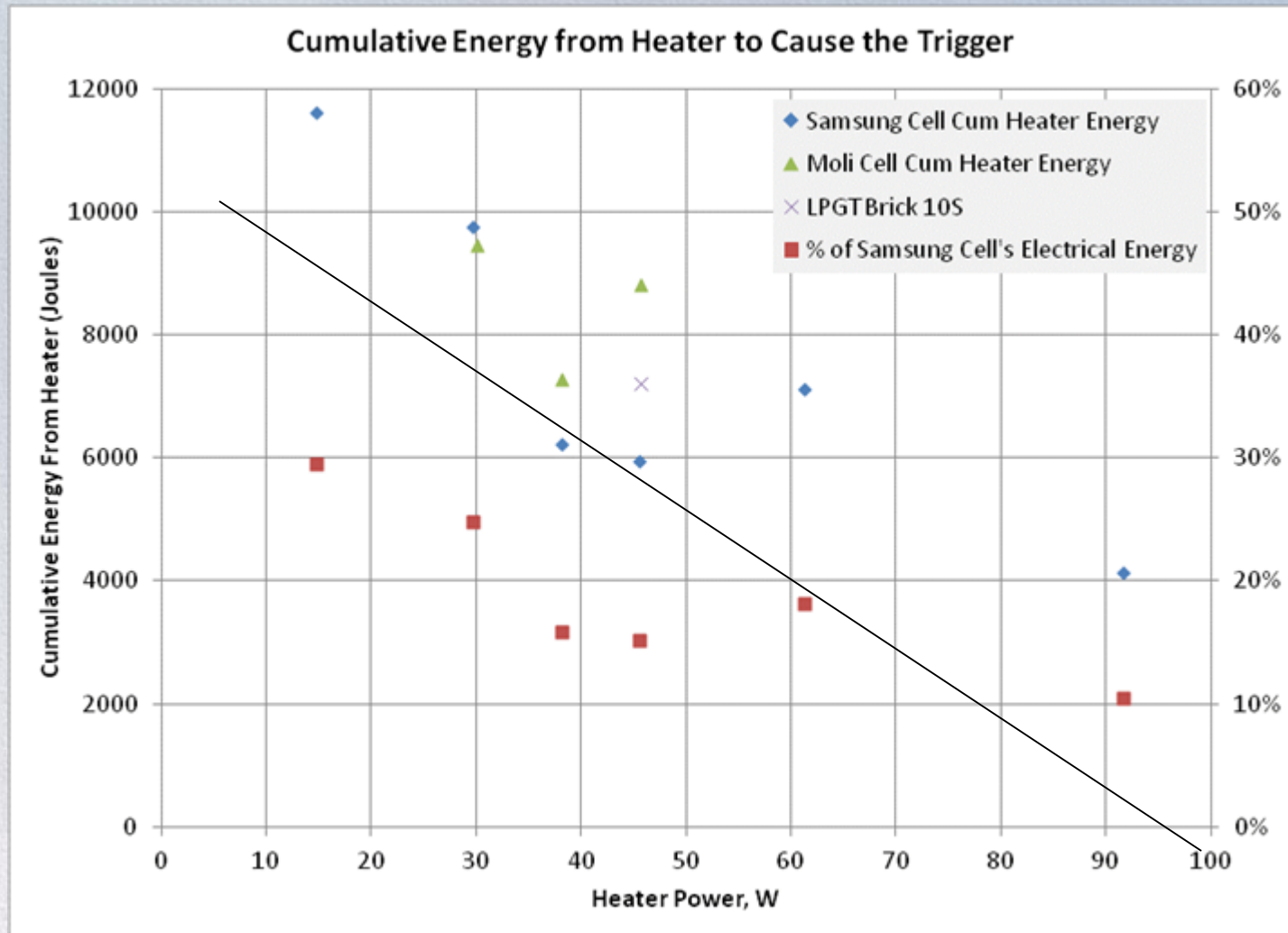

Plot courtesy of Bruce Drolen/Boeing

Lower Energy, Wh, input into the heater presents lower risk of biasing adjacent cells

LREBA 9P Bank Test – Baseline Design



- Picket fence 9P bank with cells in axial contact and with epoxy bond line between cells
 - End cell trigger with 45W
 - Open air environment
- Full cascade of cell TR propagation in about 10 minutes



First Round of Mitigation Measures

- Ensure cell-cell spacing 1-2mm with FR4/G10 capture plates
 - Reduce thermal conduction from cell to cell
- Integrate fusible links into Ni-201 bus plates on positive only
 - Isolate cell with internal shorts from parallel cells
 - 15A open current
 - Reduce thermal conduction via electrical connection
- Include radiation barrier between cells in 2mm spacing design
- Test under inert gas
 - Reduce chaos associated with burning cell ejecta (electrolyte & solids)
- Results
 - **No TR propagation in all 4 tests conducted in inert gas**
 - Radiation barriers helped slightly
 - But spacing between cells found most significant
 - Picket fence design propagated in inert gas
 - In open air, propagation was likely due to flammable ejecta impinging on adjacent cells

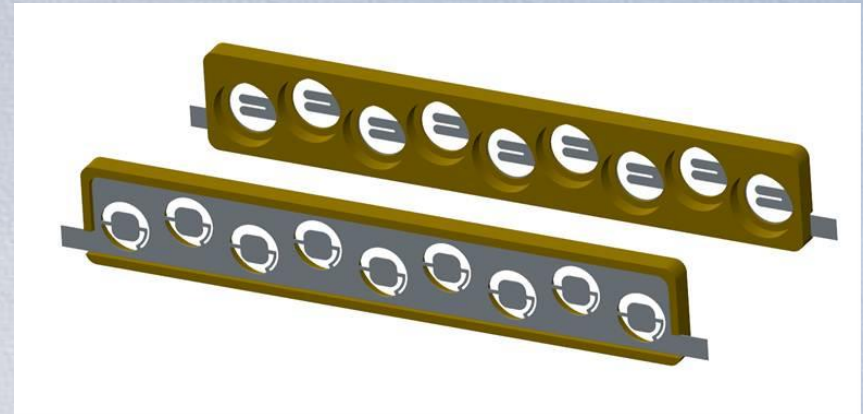

1st Full Scale Battery Test – Total Propagation

- End cell in corner of dogleg was triggered.
- All 45 cells went into TR over 29 minutes.
- *4.5 minutes from trigger cell TR to adjacent cell TR*
- Flames exited housing after 5th cell driven into TR 11 minutes into the test
- Vented ejecta bypassed fusible links and created short paths

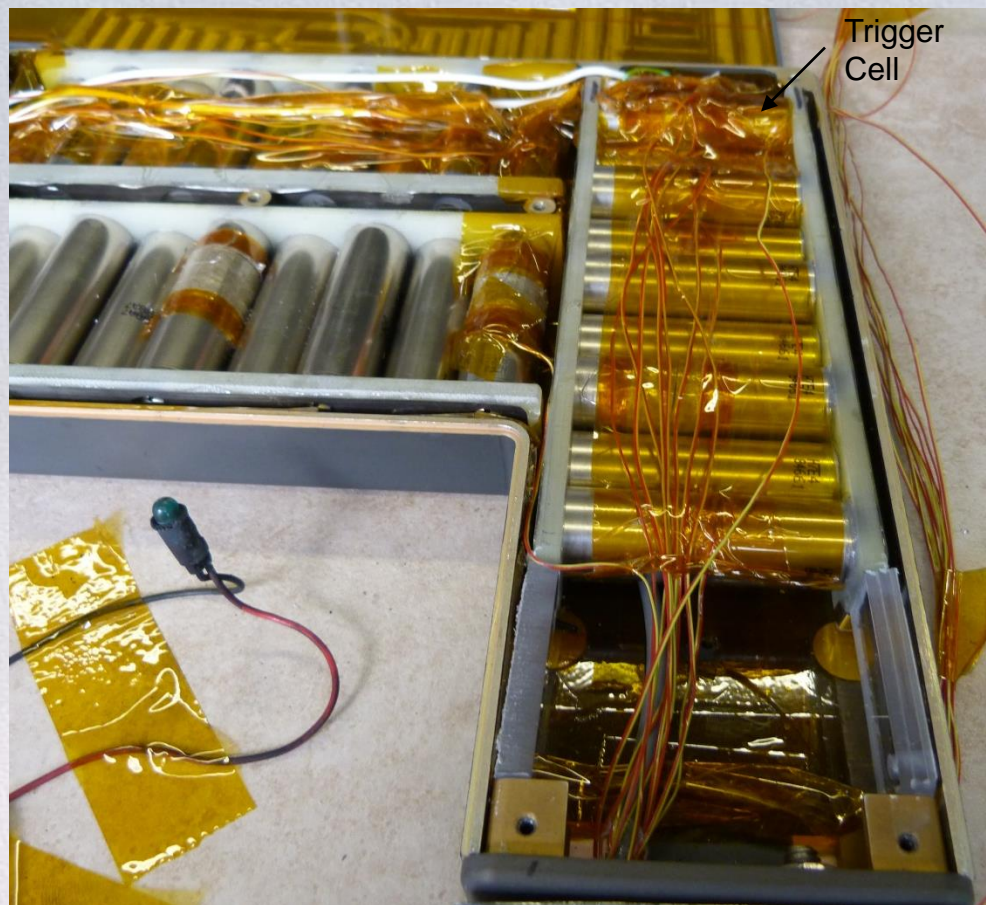

LREBA TR Video

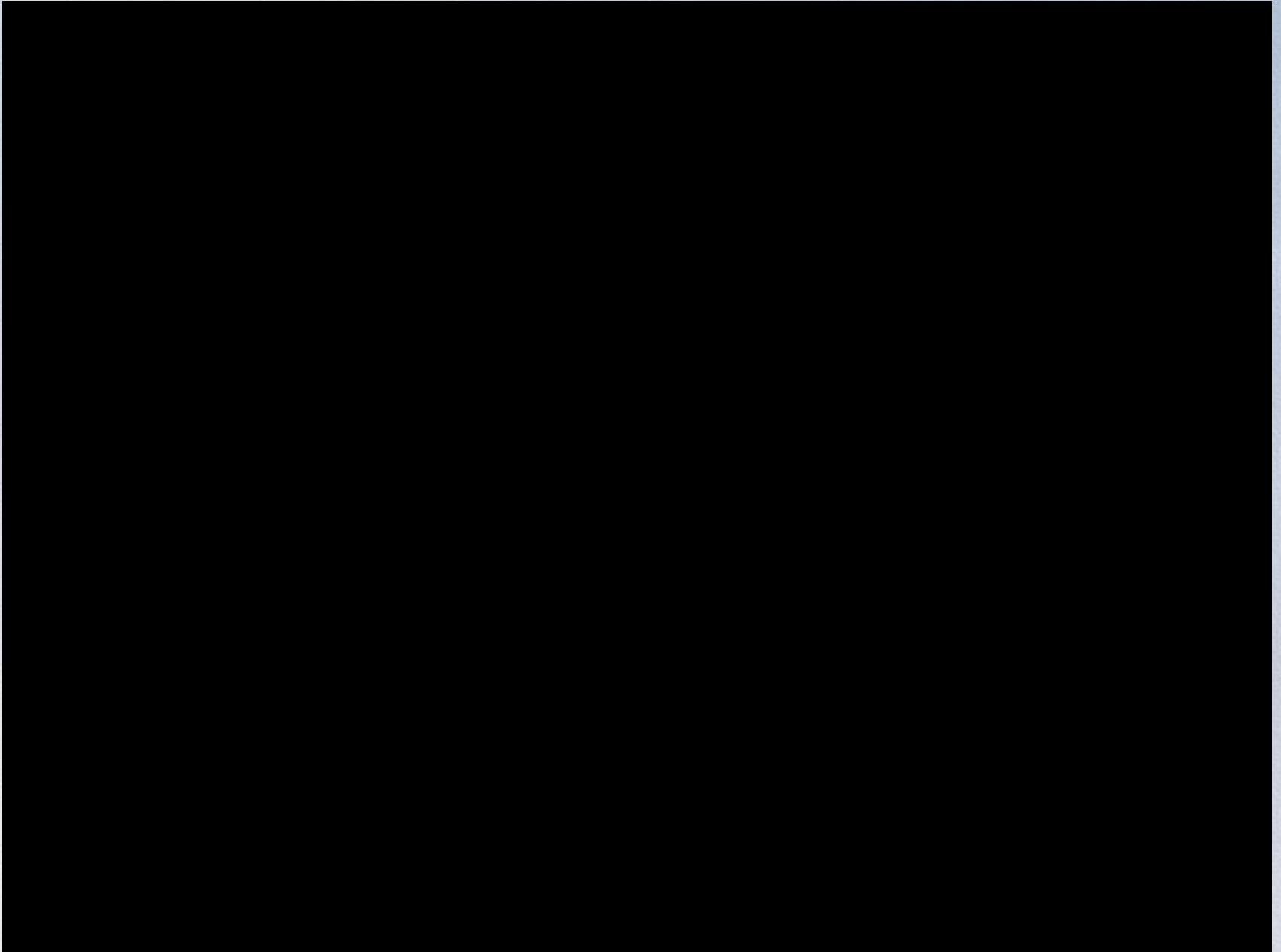

1st Full Scale LREBA Test

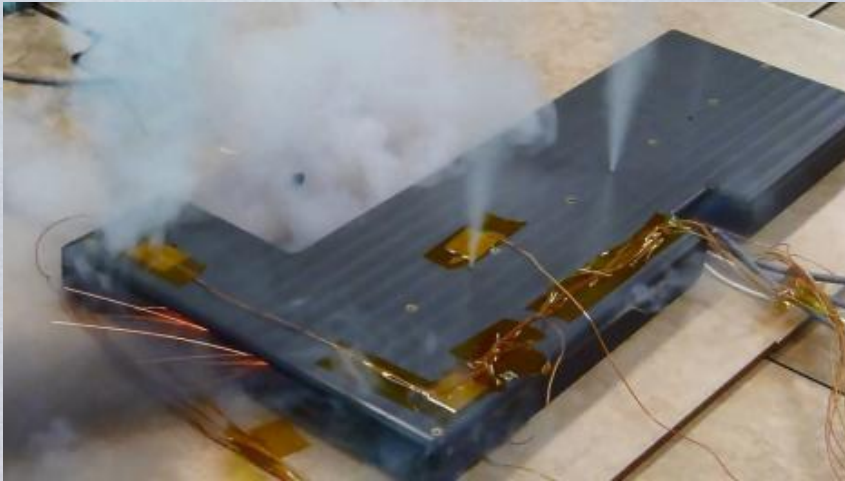

- T=5:07 min - First Cell TR
- T= 16:36 min - First flames outside housing

- T=30:28 min – During full TR Propagation
- T=34:00 min – Final TR



Major Contributors to Propagation

- Tests, our analysis, and other research identified three key contributors
 - Cell-to-cell heat transfer
 - Cell-to-cell conduction via contact, through structure, bonding, and electrical interconnects
 - Cell-to-cell thermal radiation found to be a contributor, but not leading
 - Electrical shorts causing adjacent parallel cell heating
 - Violent release of high temperature gas/liquids/solids (TR ejecta) with exothermic reactions
 - Bottled up in an enclosure with no place to go
- Test indicates that we must prevent the first propagation of TR, otherwise there is little hope stopping the runaway train

New Design Strategy for LREBA

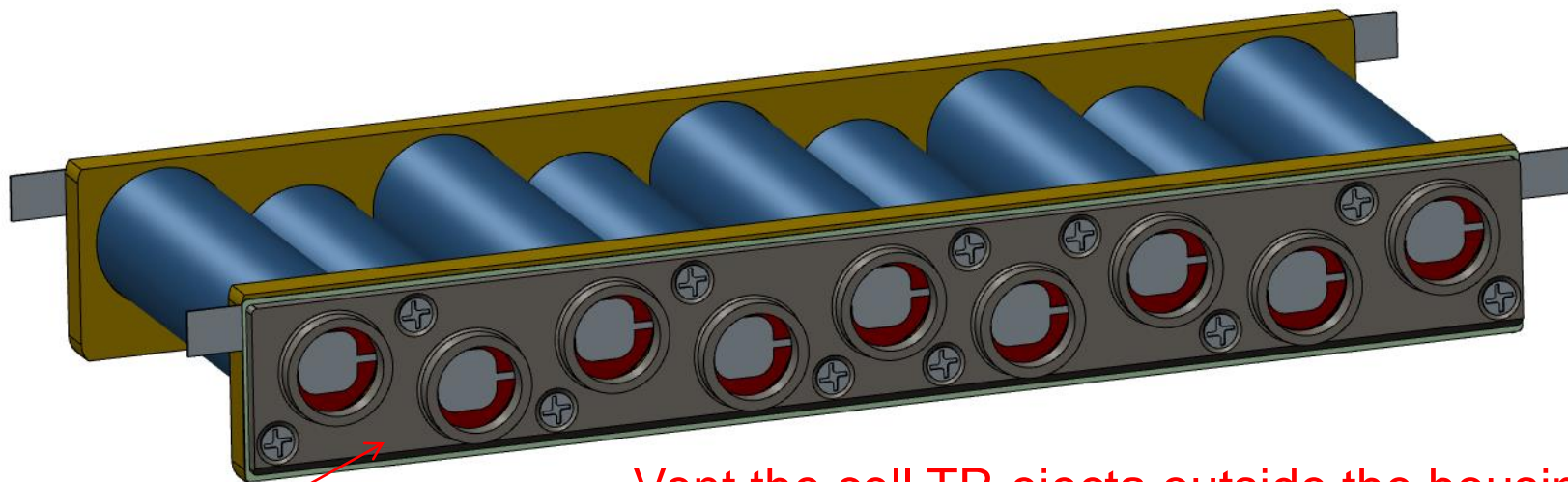

Vent the cell TR ejecta outside the housing

Cell Ejecta Exhaust Piped Top

- Macor® (machinable glass ceramic)
- Matching exhaust ports in housing for pipes
- Mica paper wrapped on cell cans
- Fusible bus bars on both positives and negatives
 - Same 15A trip

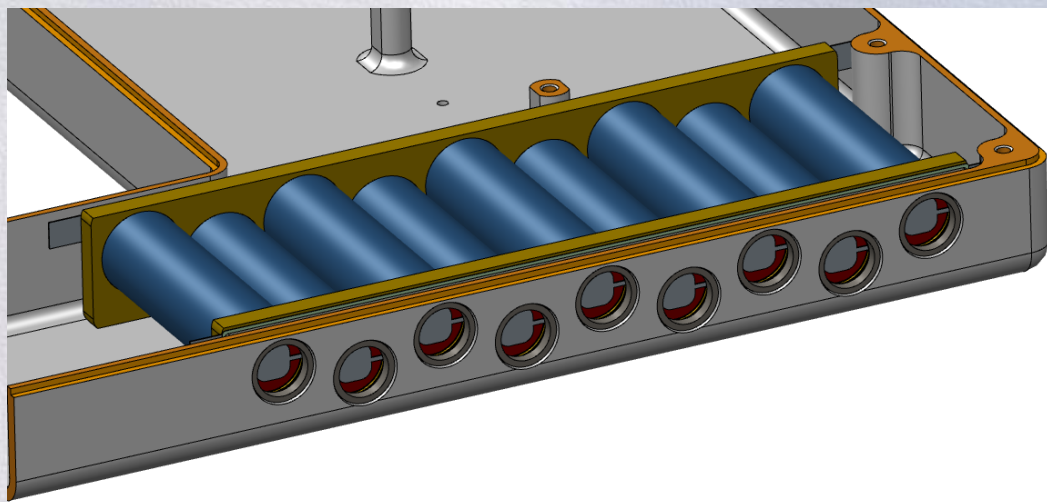

9P bank inside LREBA housing with exhaust holes

More Photos of Mitigation Features

Machinable glass ceramic (Macor®)

Fusible (15A) bus plates connected on both terminals

Mica paper as radiation barriers and to electrically isolate cell cans 2-8
Heater placed on end cells 1 & 9

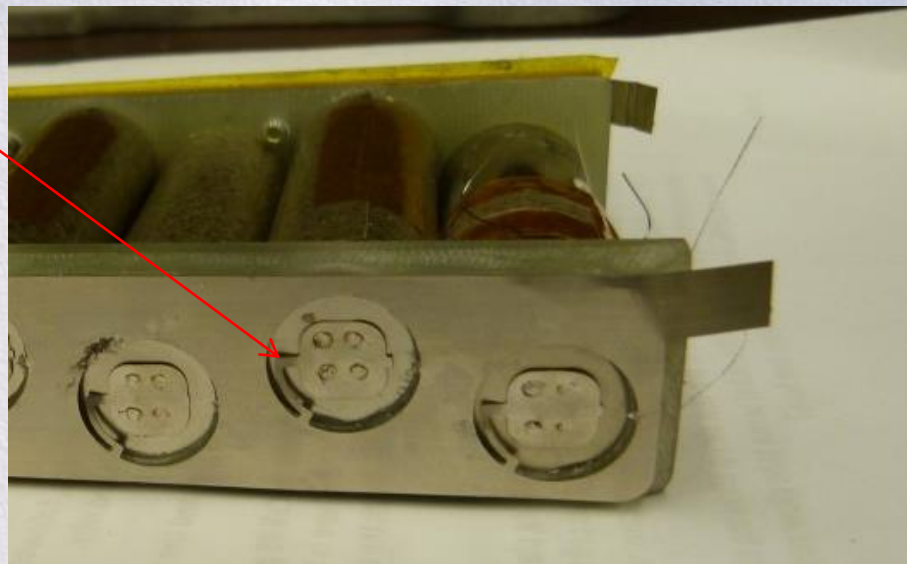

Next Full Scale Test - Pre Test Photos

One active 9P bank in dogleg with end cell trigger heaters powered at 90W
4 dummy banks uncharged to take up volume inside enclosure

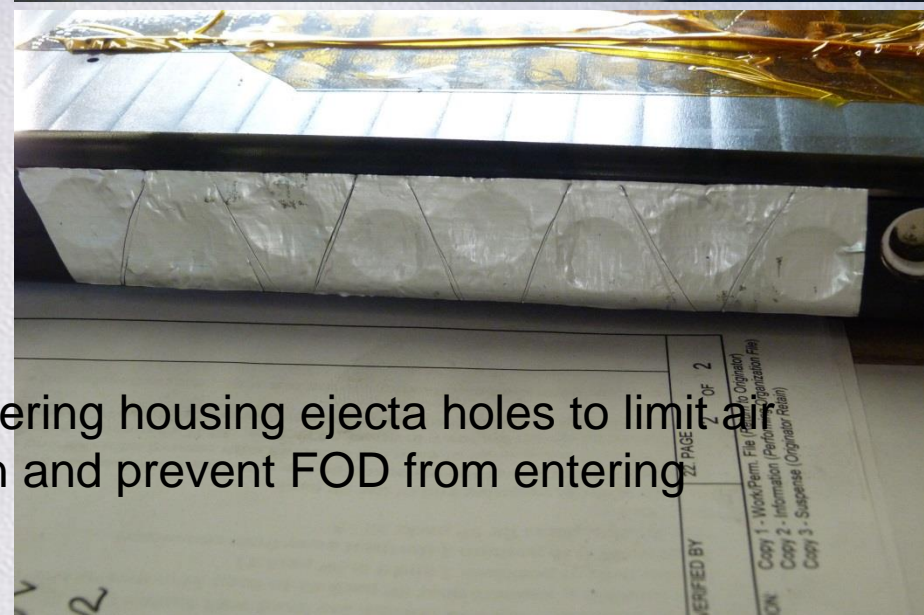
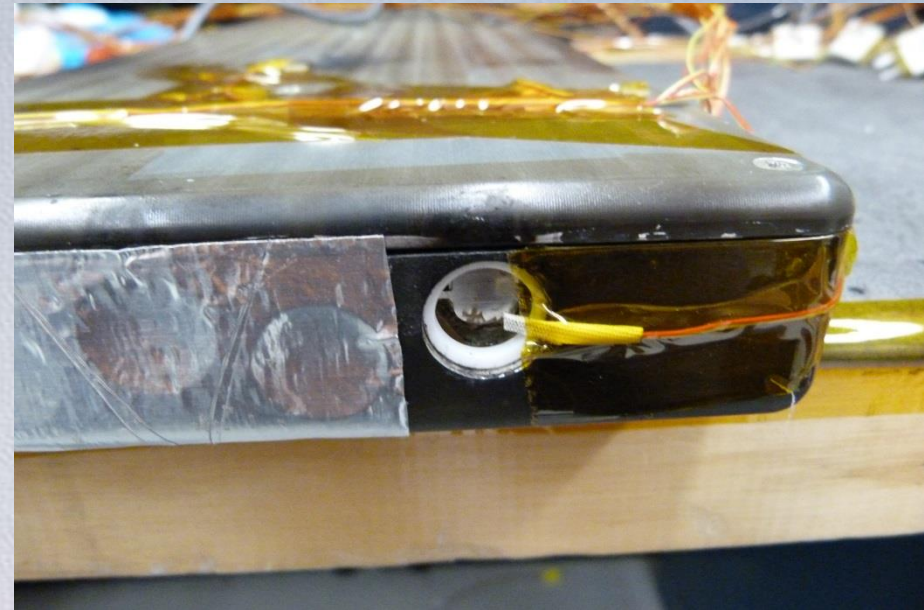

Al foil covering housing ejecta holes to limit air circulation and prevent FOD from entering

No TR Propagation

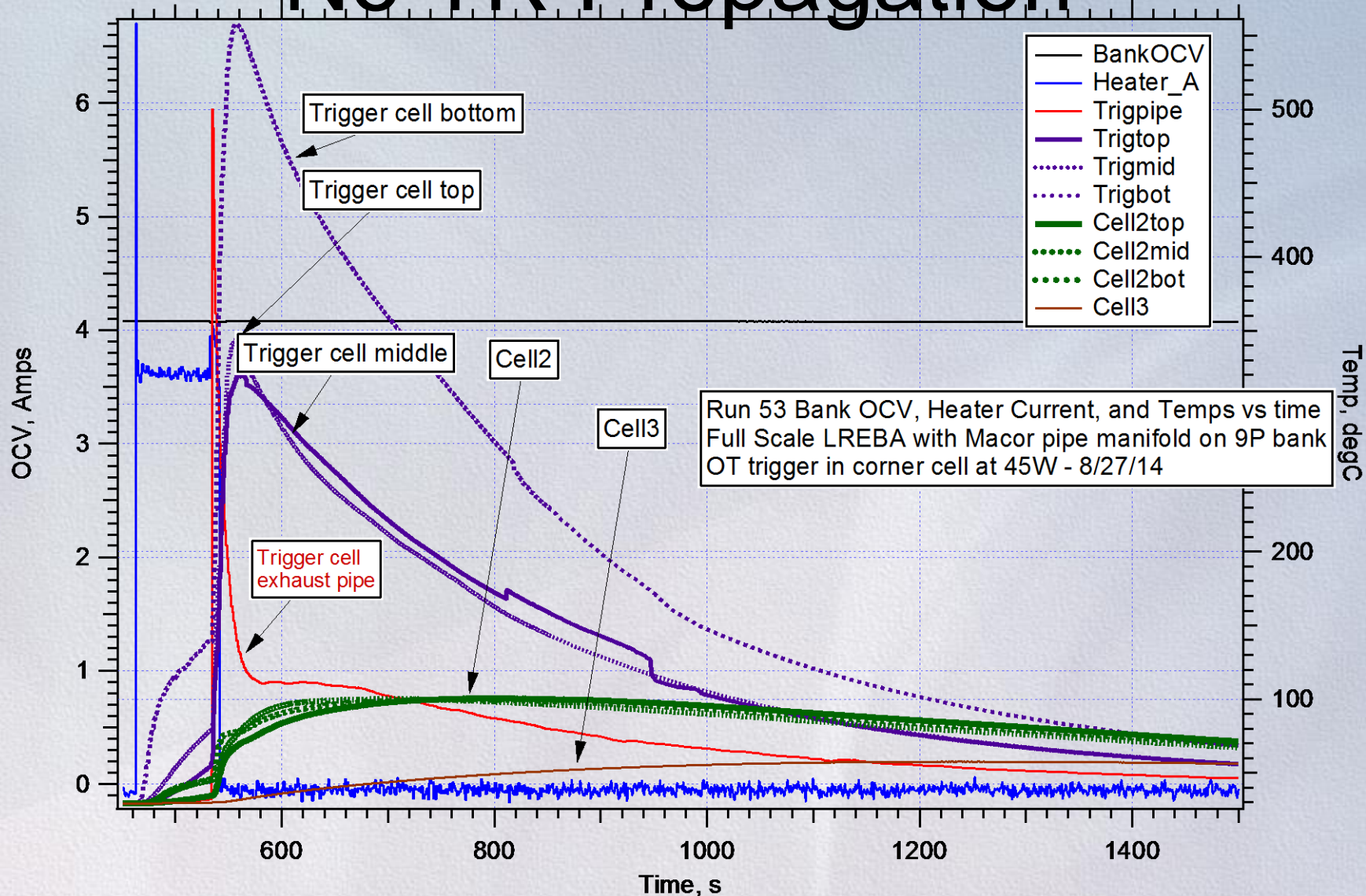

Half of heater fails open in first second, heater runs at 45W, nevertheless, TR reached in 72s. Bottom of trigger cell reaches 543°C, while mid and top get to 319-344°C. Cell 2 maxes out on all 3 TCs at 100°C.

Trigger Cell Positive Fusible Link Opens

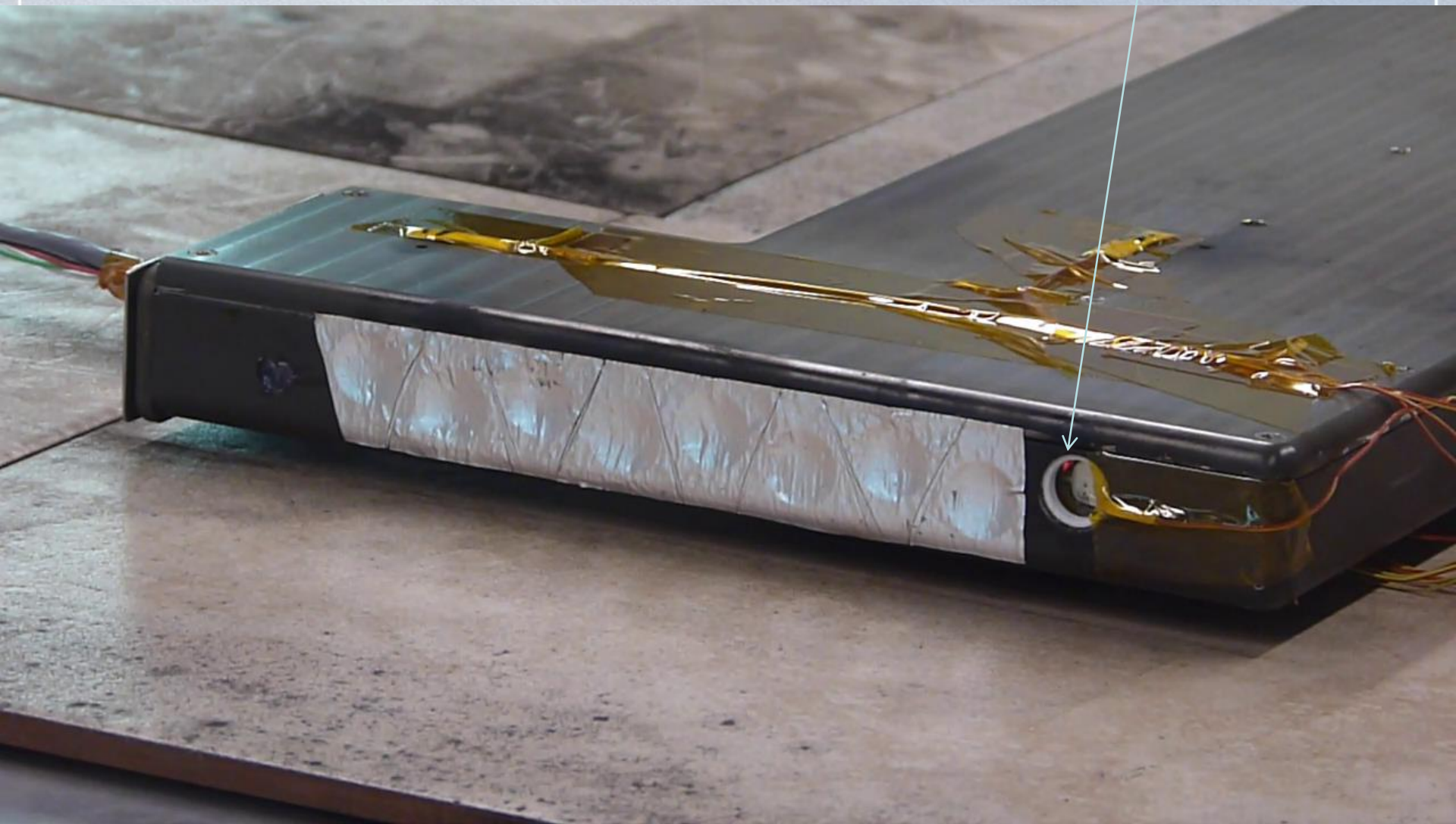

At video time 13m:18s

Trigger Cell Venting



At video time 13m:19s

Trigger Cell TR



At video time 13m:20s

ESLI Carbon Fibercore Torch Test

- Lightweight tiny carbon fibers glued to Al foils
 - High surface area fibers with very high thermal conductivity
 - Sample tested was ¼" thick
- Blow torch flame did not penetrate through sample
 - Even after 10 second application

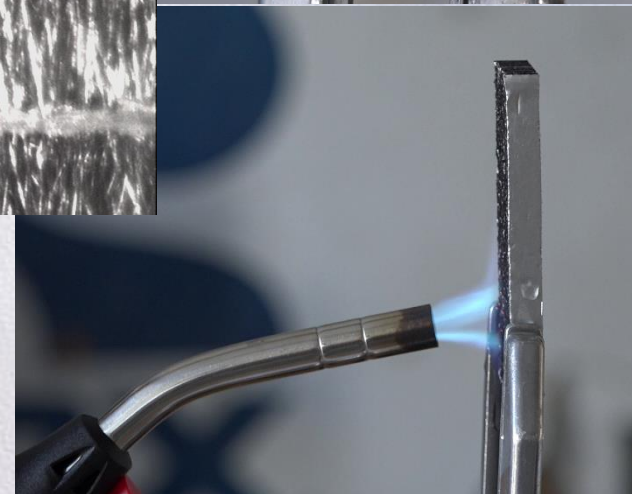
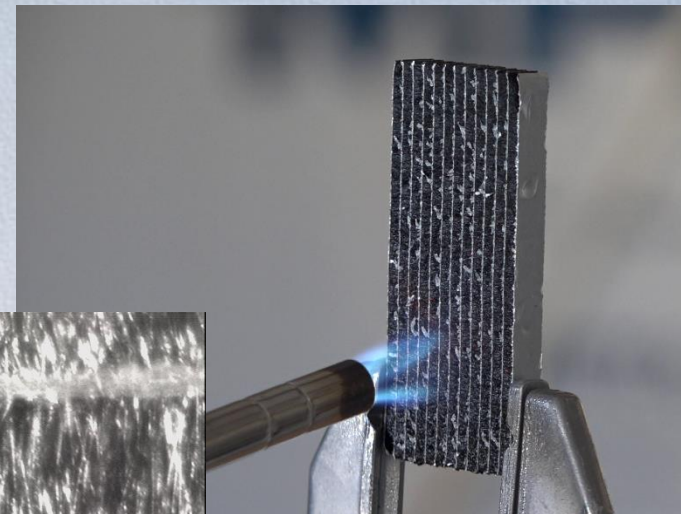
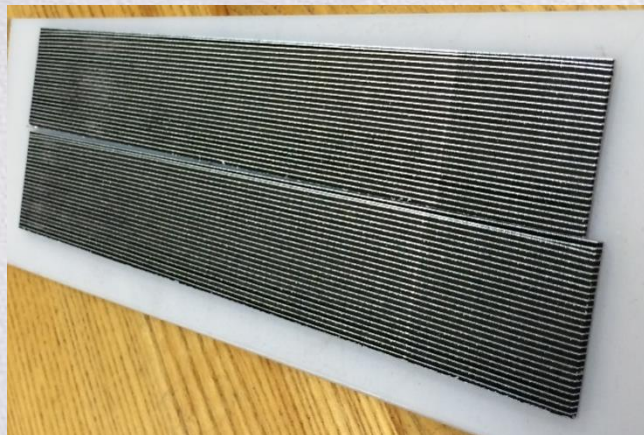
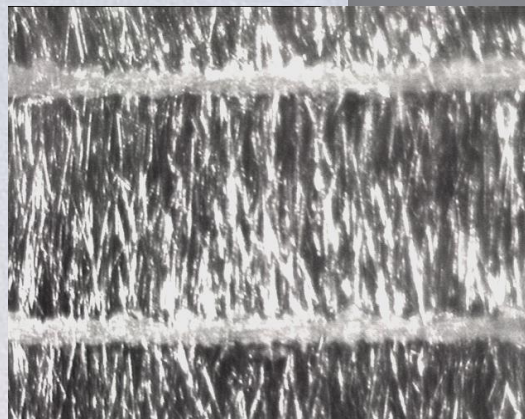
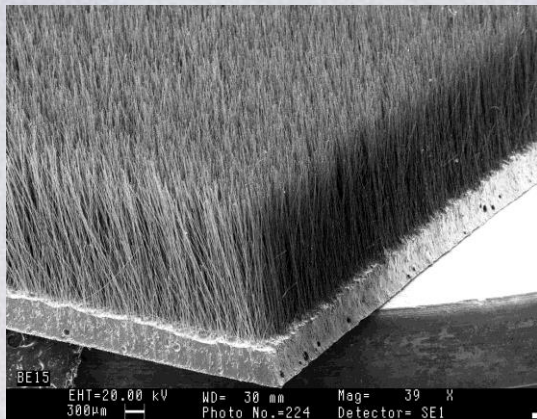

Run 58 Pre Test w/ Soft Goods Bag

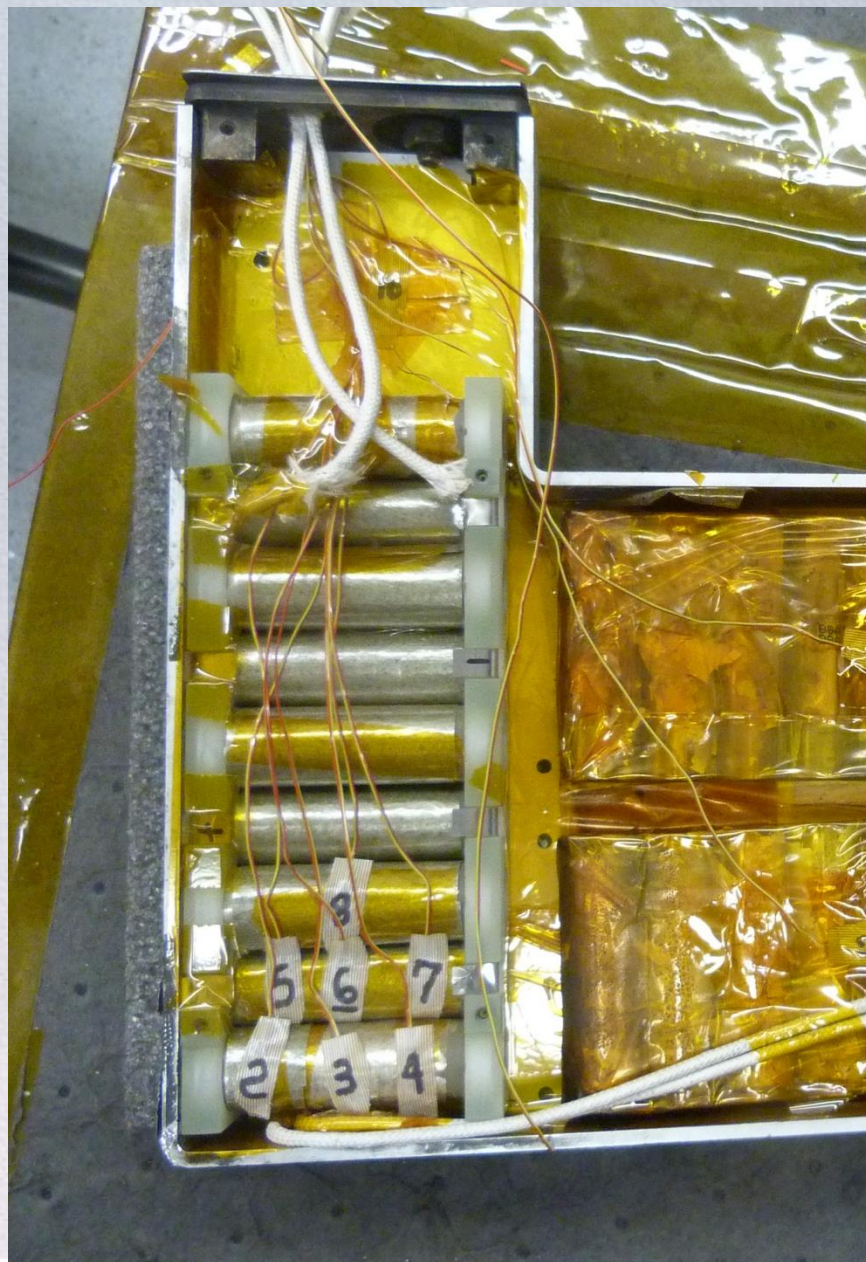

With Carbon Fibercore (CFC)

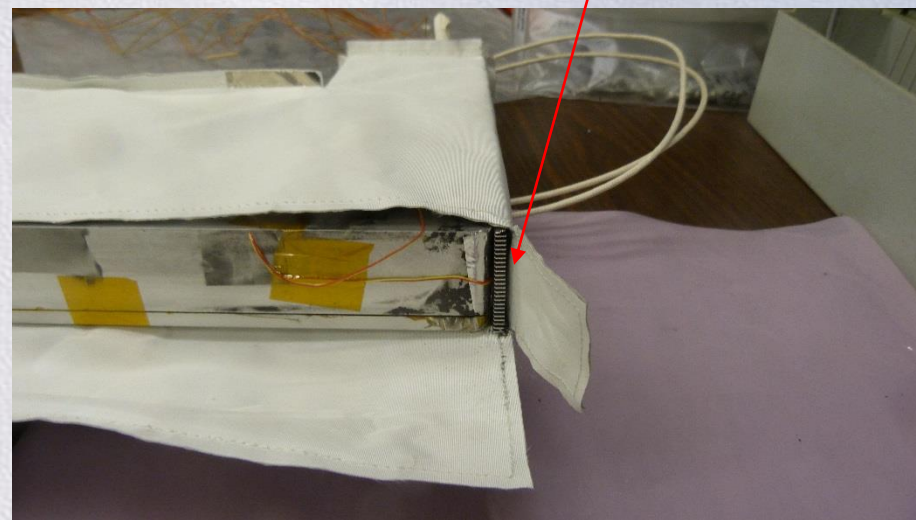
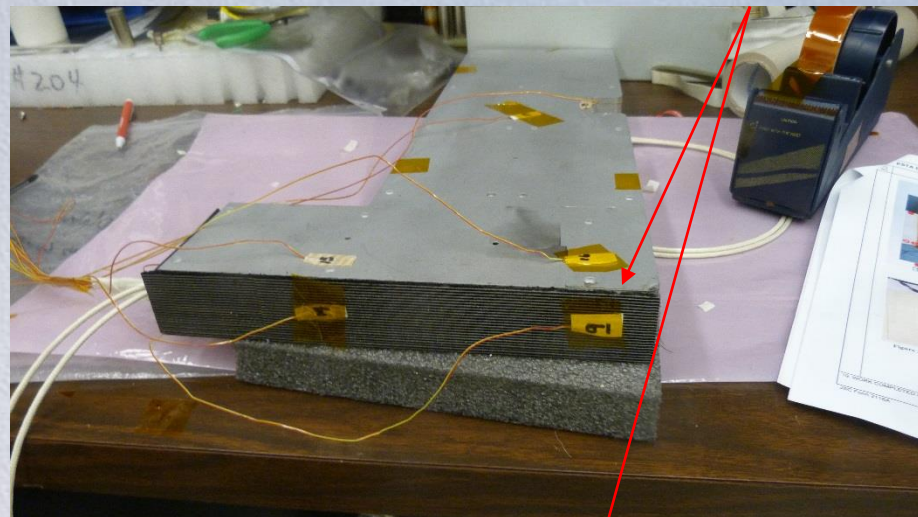

Post Test Pictures

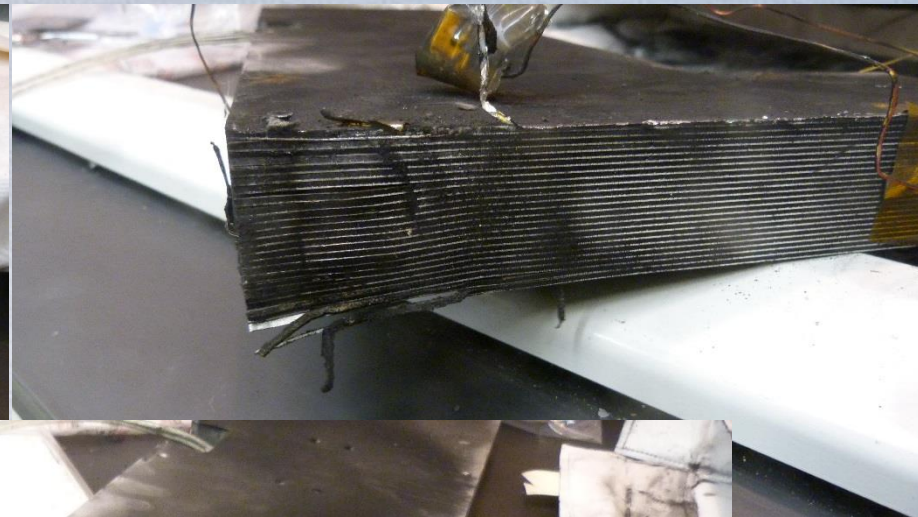

Flame arresting and
heat spreading
Carbon Fibercore
(CFC)

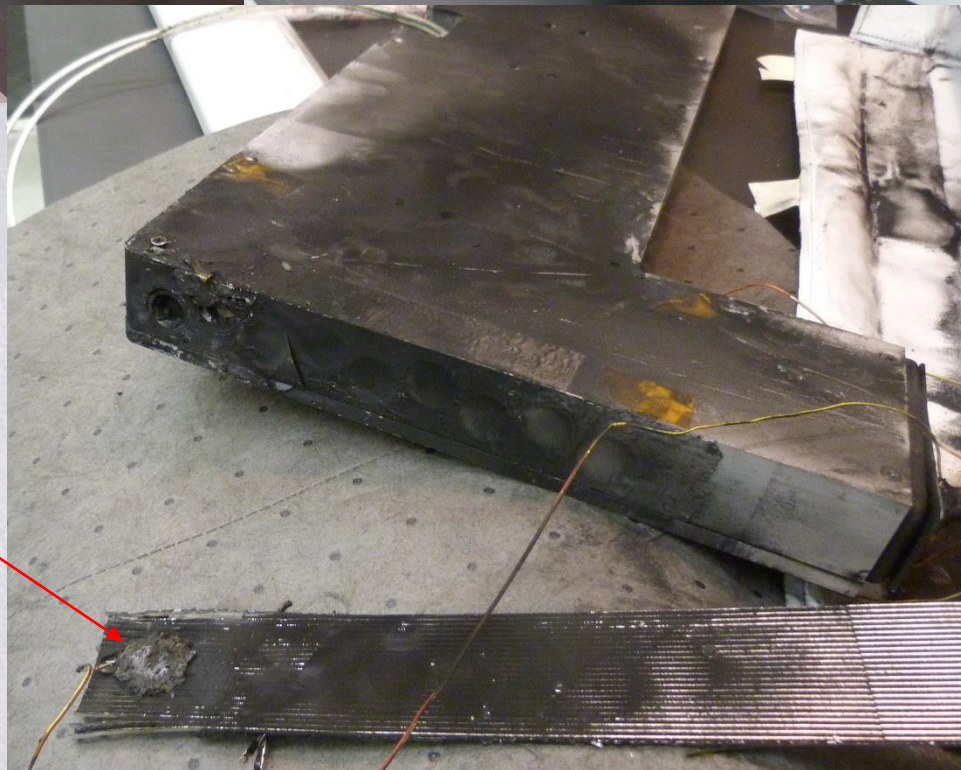

Run 59 – Without the CFC



Cell TR ejecta burns right through 2 layers of Ni foil (0.001")

Al Heat Spreader (run 60-61)

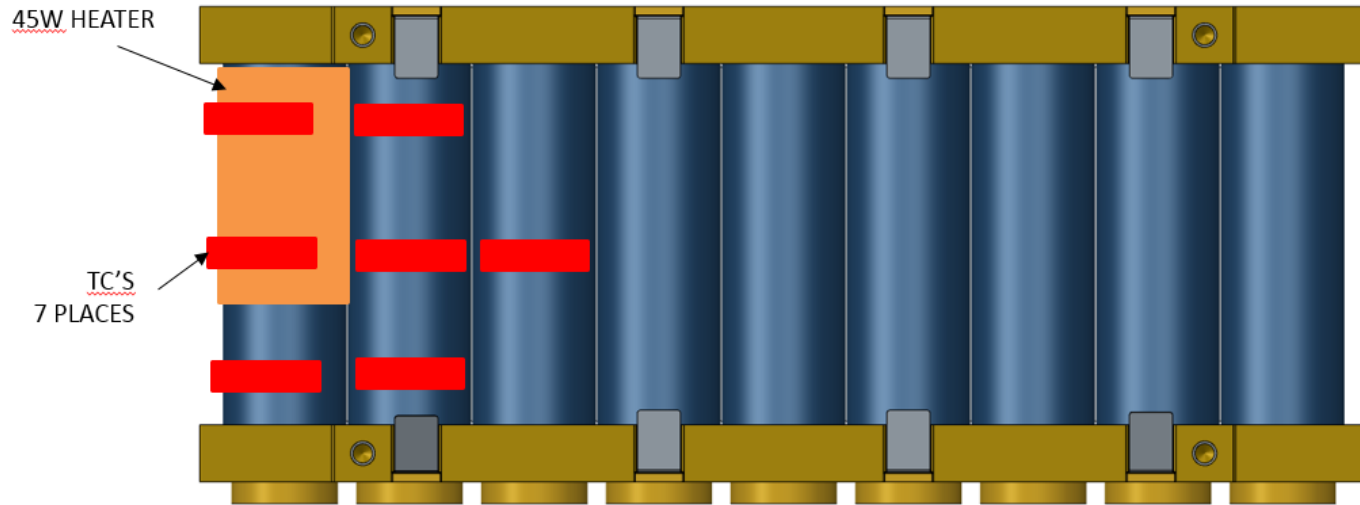

TOP VIEW OF 9P CELL BUNDLE WITH HEAT SPREADER REMOVED FOR CLARITY

Top and bottom heat spreaders connects every other cell thermally

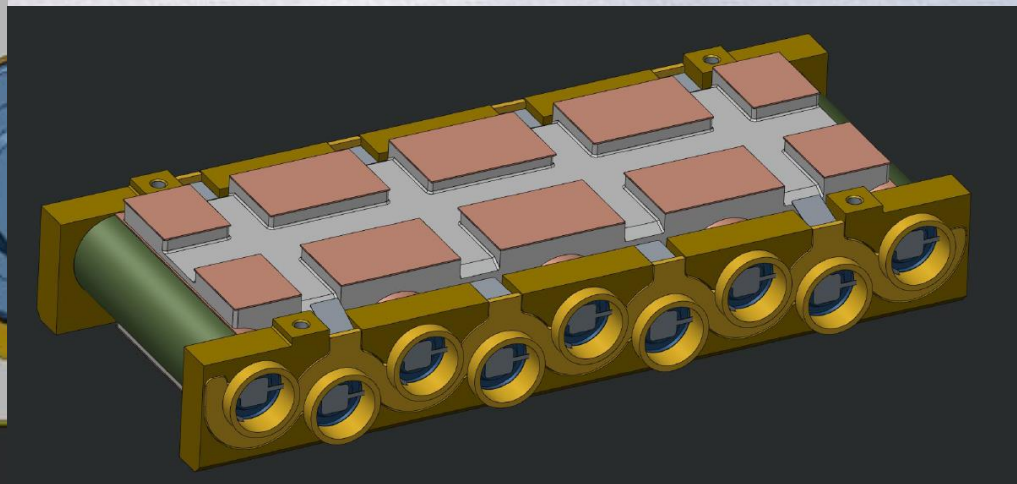
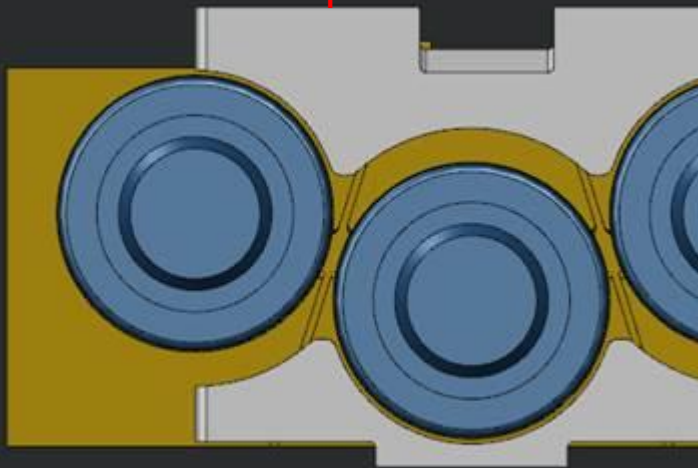

Runs 60 – 61 – No sparks, no fire exit bag

- Bag internal layering reinforced with 4 layers of Ni foil opposing cell exhaust ports
- Bag overlap layering added at corners to prevent exiting sparks
- Heat spreader conducts heat to enclosure and reduces max temperature and duration of trigger cell

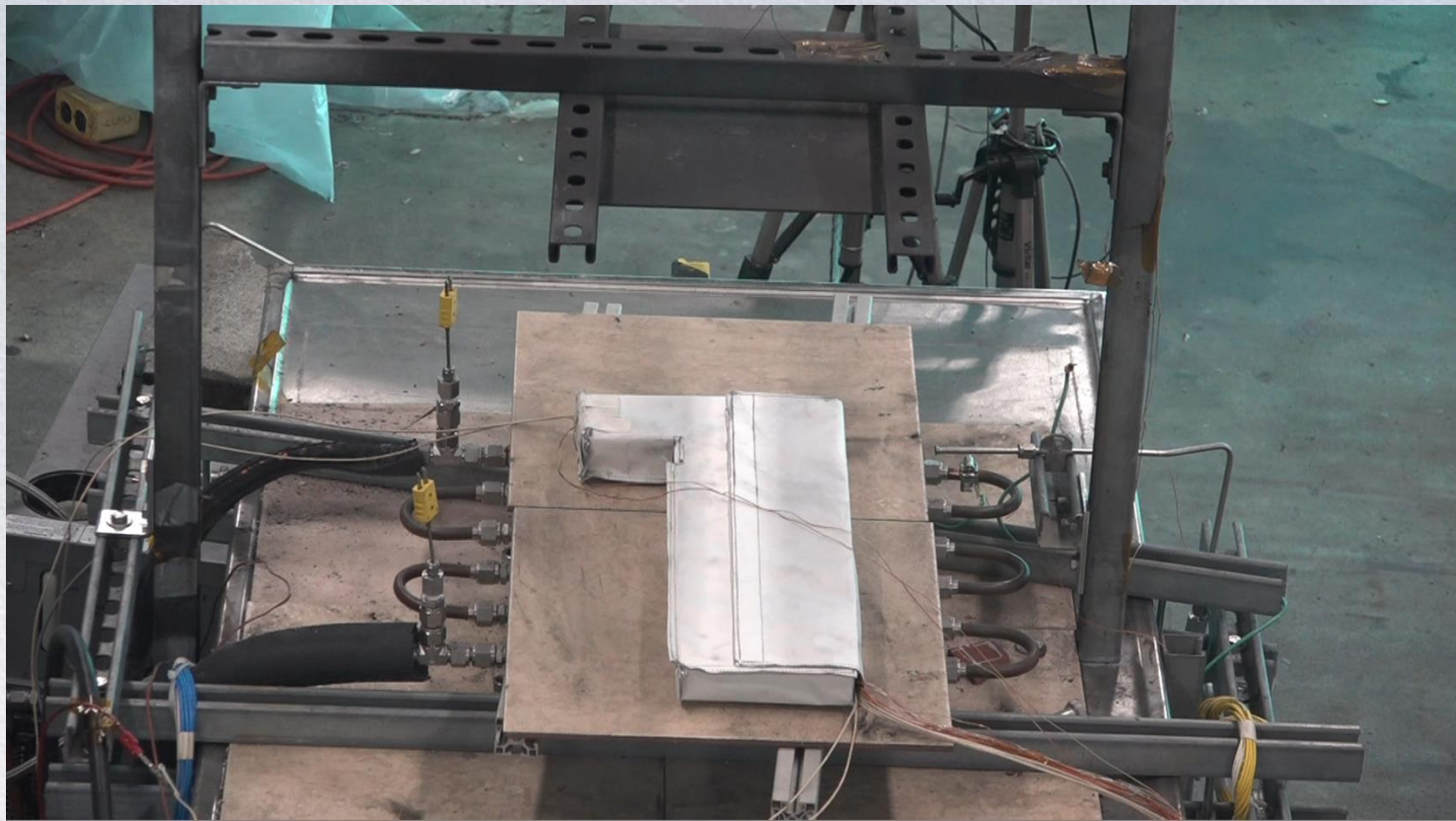

Plot of run 60 – Heat Spreader & CFC

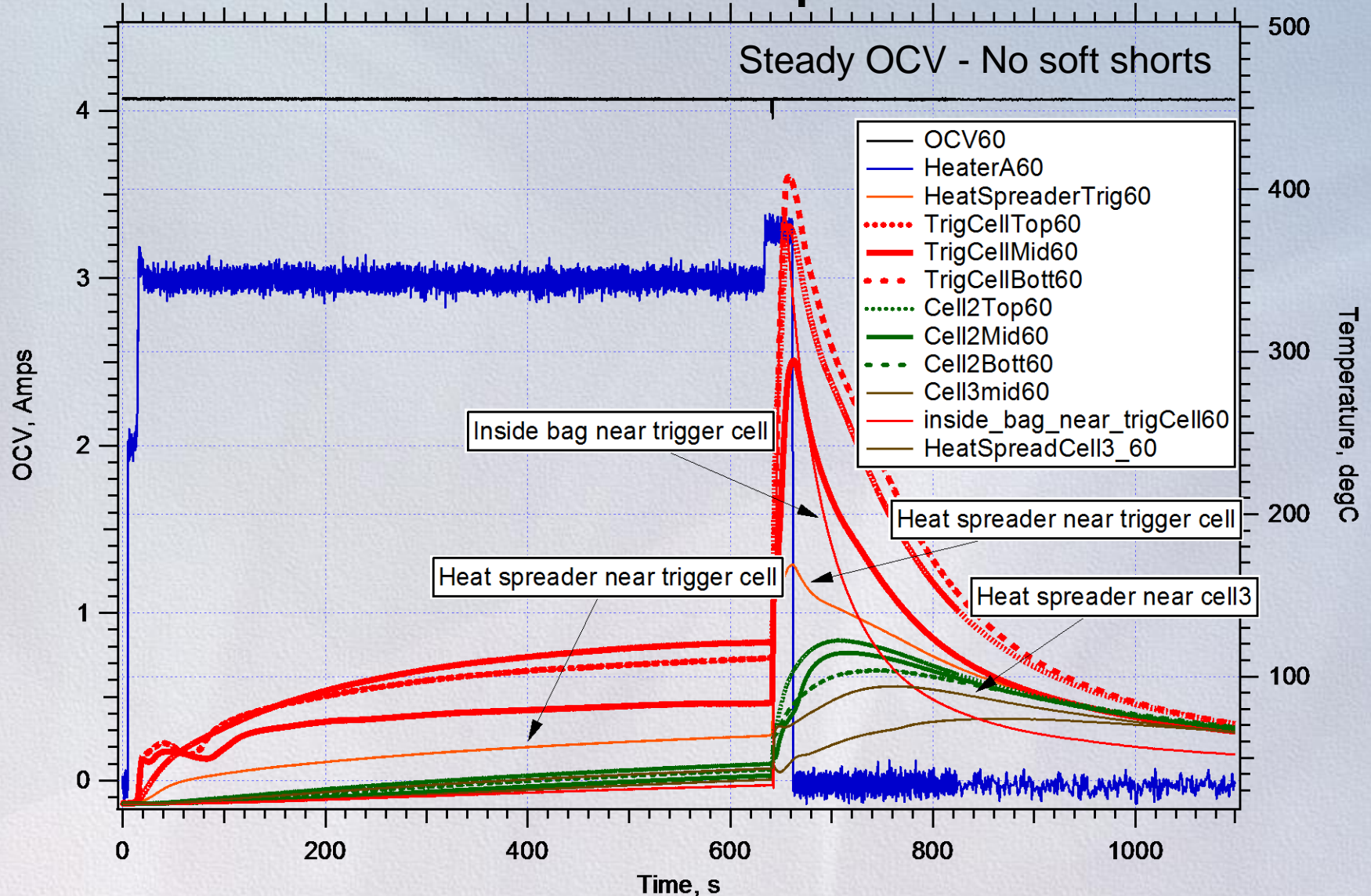

Heater power bumped up from 45 to 55W just prior to TR, which occurs 10.6 minutes after heater turn on. Much longer to drive TR. Trigger cell max temp range is 294-408°C, Cell 2 is 104-122°C, and cell 3 reaches 74°C. Cooler Ts with heat spreader except for cell 3. The heat spreader reaches 173 and 94°C near the trigger and cell 3, respectively.

Run 61 – Heat Spreader, no CFC

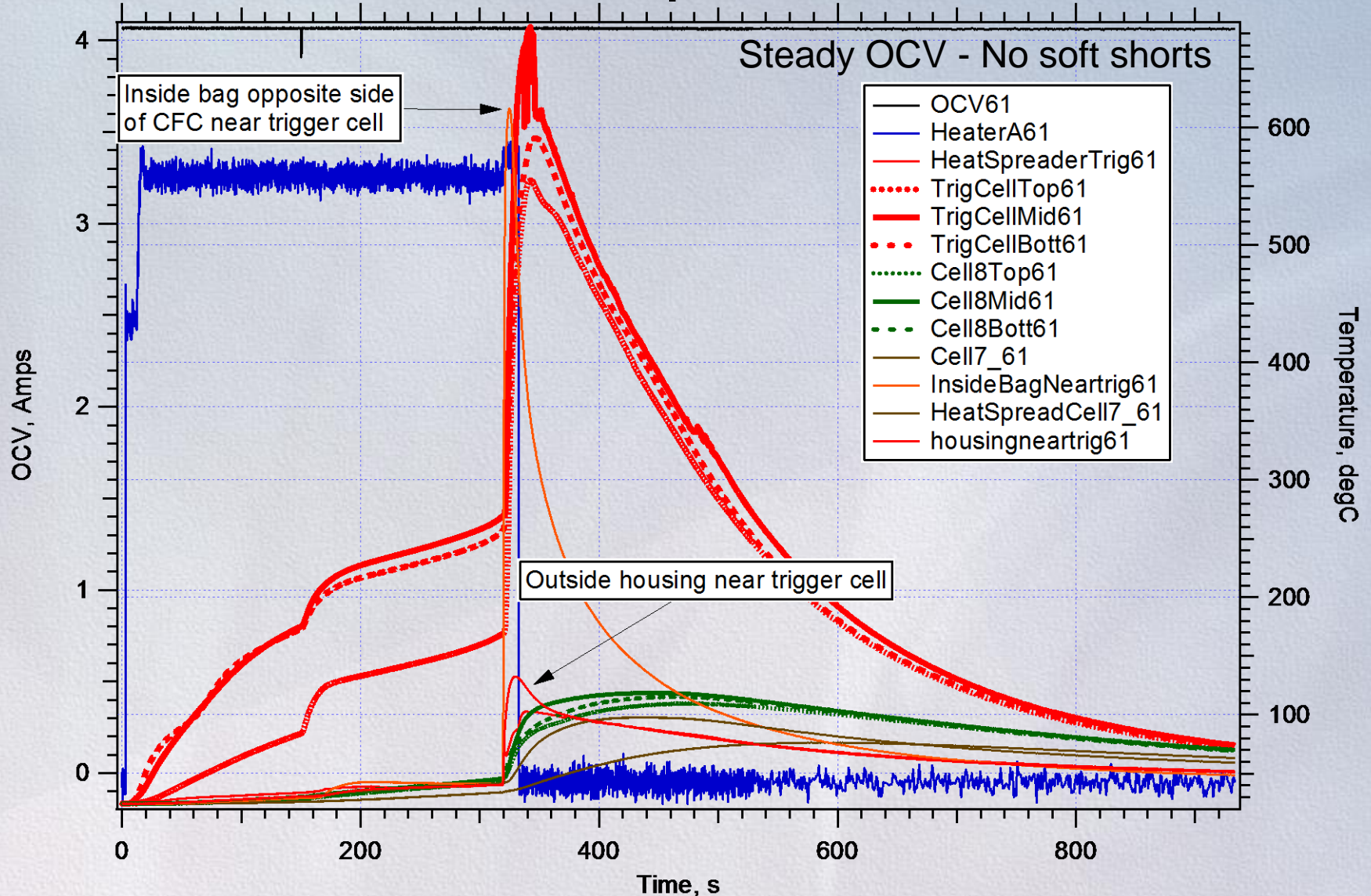

Heater set at 50W and on for 329s. TR occurs in 320s. Internal short circuit occurs 147s after heater on, possibly venting. Then TR occurs 57s later. Max Ts on trigger cell range is 555-686C, cell 8 is 110-115C, and cell 7 reaches 76C. Note that it takes 449s for max temps to cool from peak to 100C. Heat spreader does not keep trigger cell as cool, but does protect adjacent cell.

Run 61 – No CFC

- TR ejecta burns through first Ni layer and damages second layer
- 3rd and 4th Ni layers are undamaged
- Ni melts at 1455°C
- Adjacent cells retained OCV > 4V
- DPA of adjacent cells from runs 60 & 61 indicated no heat effected zones on jellyroll plastic wrap

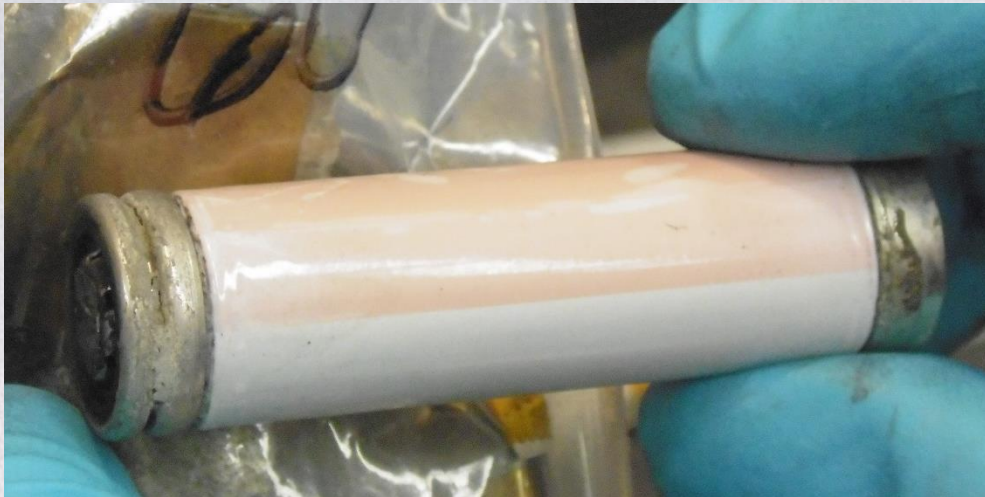

Recap of Mitigation Measures for LREBA

- Control the conduction paths
 - Ensure cells are spaced out $\geq 1\text{mm}$
 - G10 capture plates
 - Decrease conduction of cell interconnects
 - Fusible links
 - Increase conduction to the enclosure
 - Heat spreaders and gap pads
- Limit shorting paths
 - Fusible links in the negative cell interconnects
 - Mica paper sleeves on cell cans
- Control the TR ejecta path to protect adjacent cells
 - Seal cell positives to capture plates with high temperature adhesive to prevent bypass of hot gases
 - Protect materials in ejecta path with ceramic pipes and exhaust ports
- Limit the flare/fire/sparks exiting the battery enclosure
 - Flame arresting screen and tortuous path to cool the hot gases leaving the battery exhaust ports
- Protect all of the cabling and wiring to ensure it does not become an external short path.
- Baffles and barriers like nickel foil need to be carefully considered.
 - Even though the melting points of these metals are well above the ejecta temperature, the softening points of these metals are not. When you combine a softened metal with the force and abrasiveness of the ejecta, the softened metal cannot stand up to it.

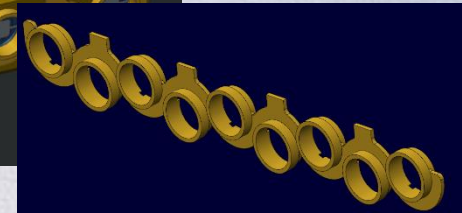
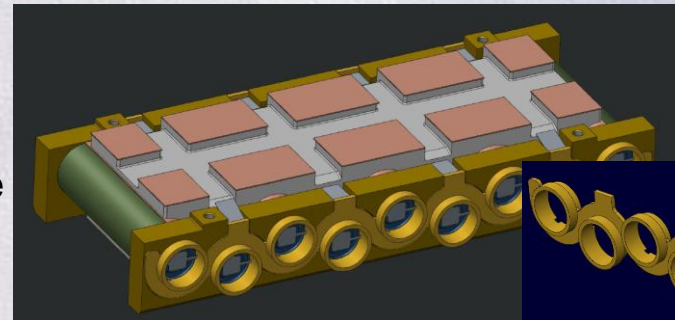
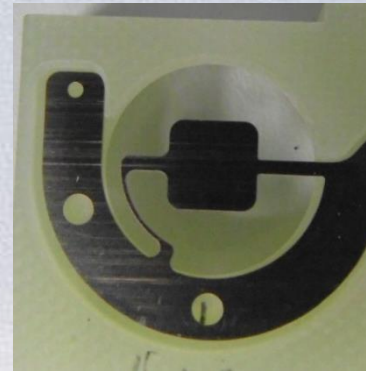
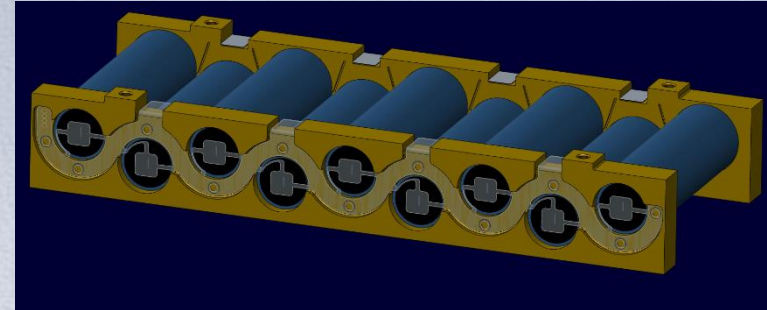

Li-ion Pistol Grip Tool (LPGT) “CDR” Baseline Design

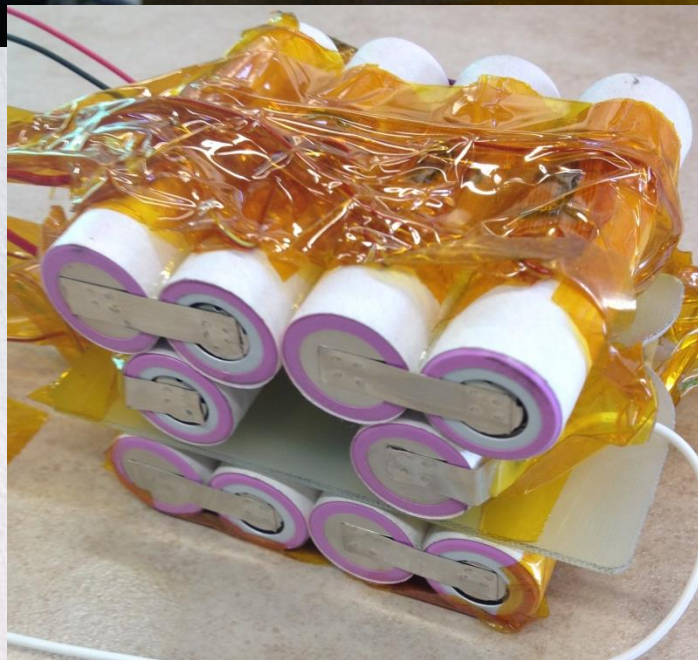
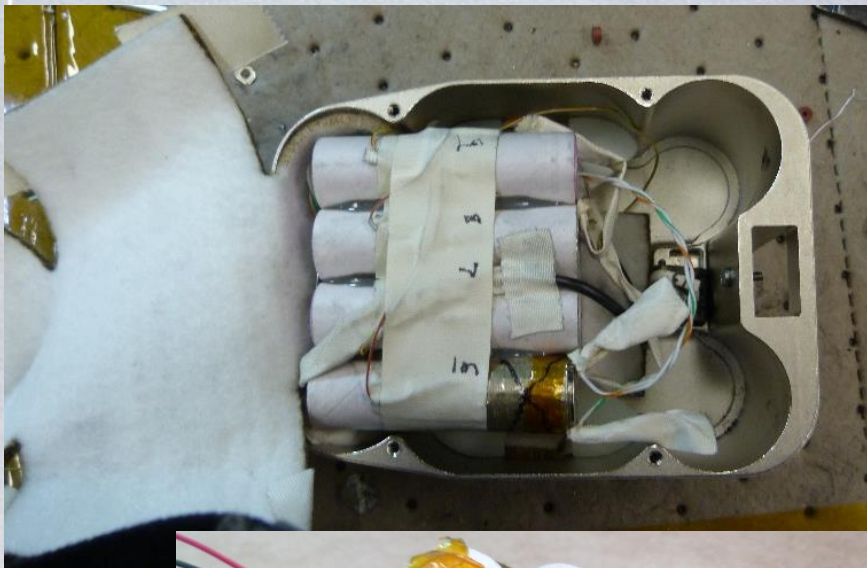

Baseline Design Features (April 2014)

- 10S array for discharge into Tool
- 2P-5S array for charging
- Cells wrapped in PVC shrink wrapped and Nomex® paper tube sleeve
- Cell glued together in contact with epoxy
- ¼" wide Ni-201 tabs (0.005" thk) for cell interconnects
- No battery vent

LPGT "CDR" Baseline Test

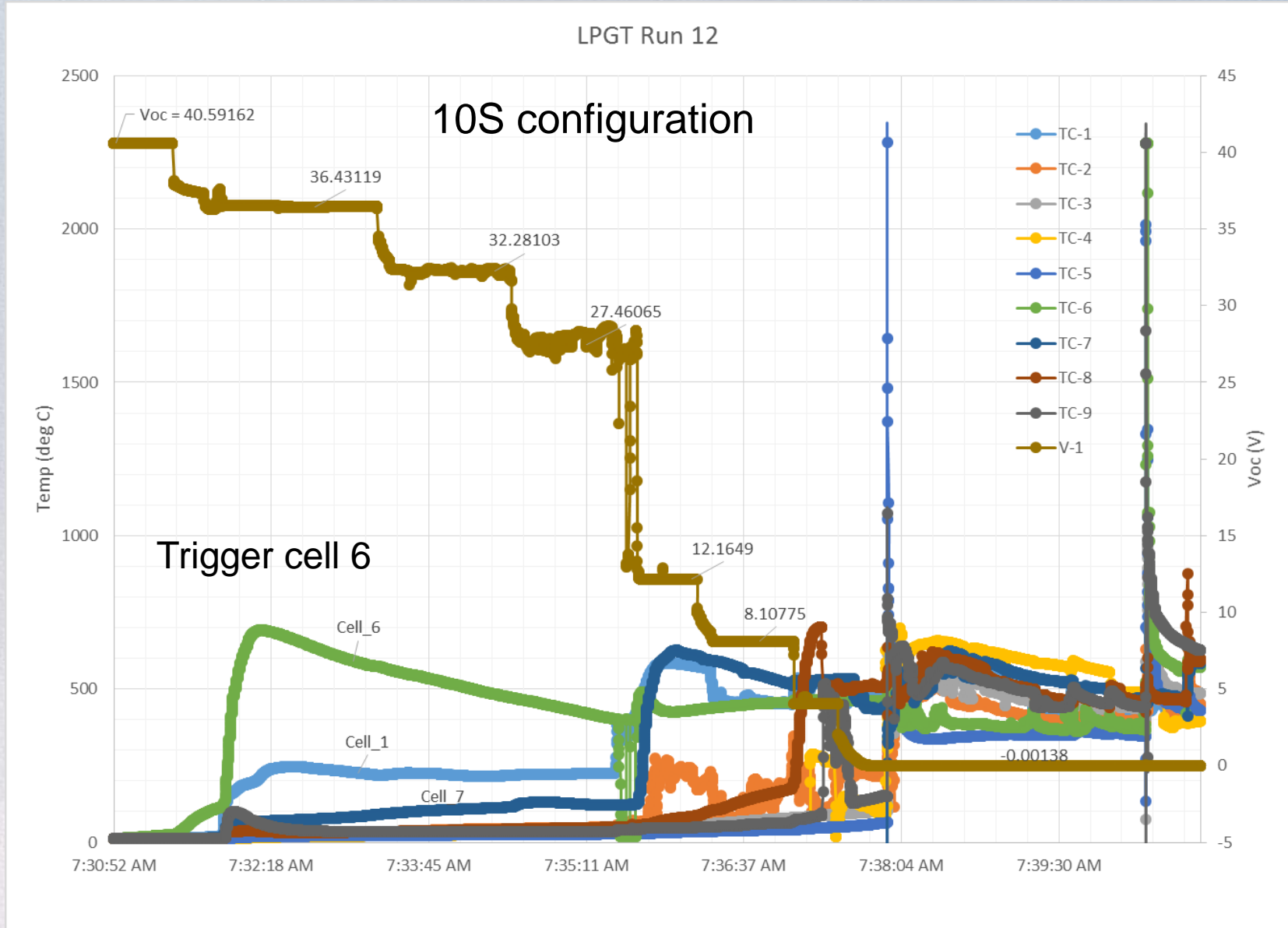

Full thermal runaway propagation to all 9 other cells over about 10 minutes with release of sparks

Snapshot of release of sparks



Several sparks events occur and the supporting tile cracks, and smoldering smoke is intense for ~ 10 minutes

LPGT with Severity Reduction Features

- 3mm cell spacing held with G10 capture plates
- Individual 10A fast blow cell fuses (2P-5S)
- Macor® liner in cell vent hole in positive G10 plate
- Mica paper tube sleeving cell cans
- Tortuous cell TR ejecta path with cells pointing away from housing vent port with flame arresting screen

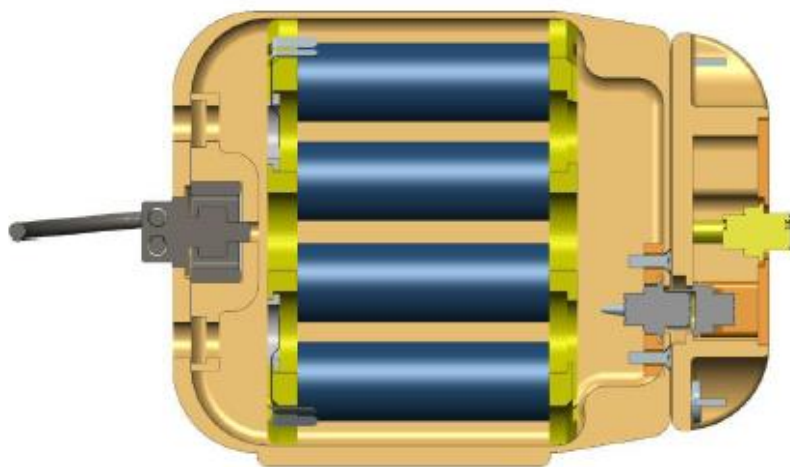

Optional Al heat spreader

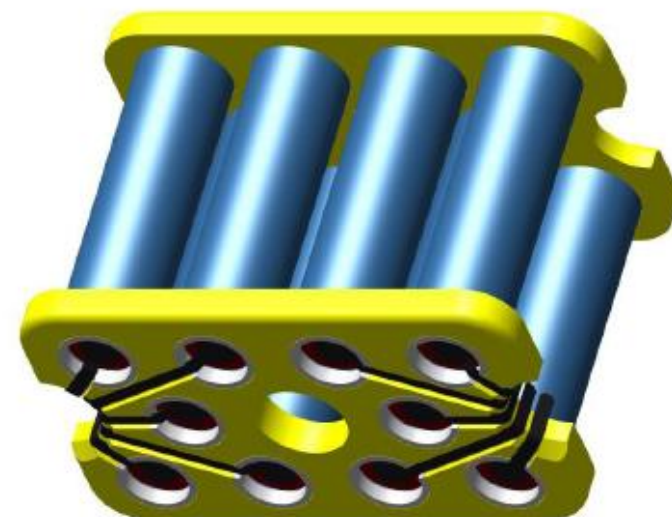
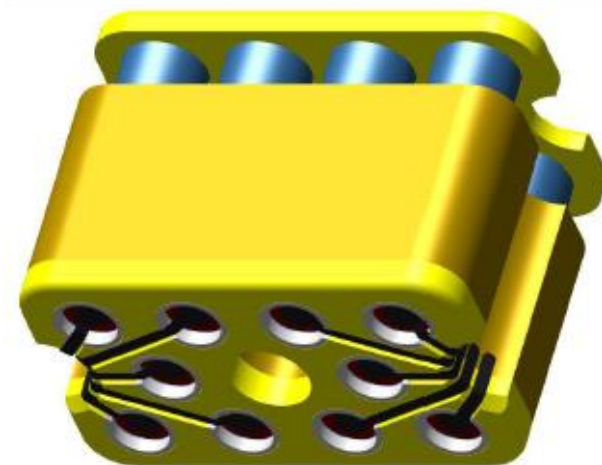

Circumferential Heaters

Low Profile, less likely to detach

- Same 30 AWG NiChrome Wire
- Wrap bare cell can in mica paper (0.004")
- 4-6 wire wraps around cell near bottom
- Coated in ceramic putty, Cotronics Resbond 907GF® or equivalent
- Tig weld NiCr wire transition to solid 26 AWG power wire and completely insulated it in the putty
- 15W max per wire wrap

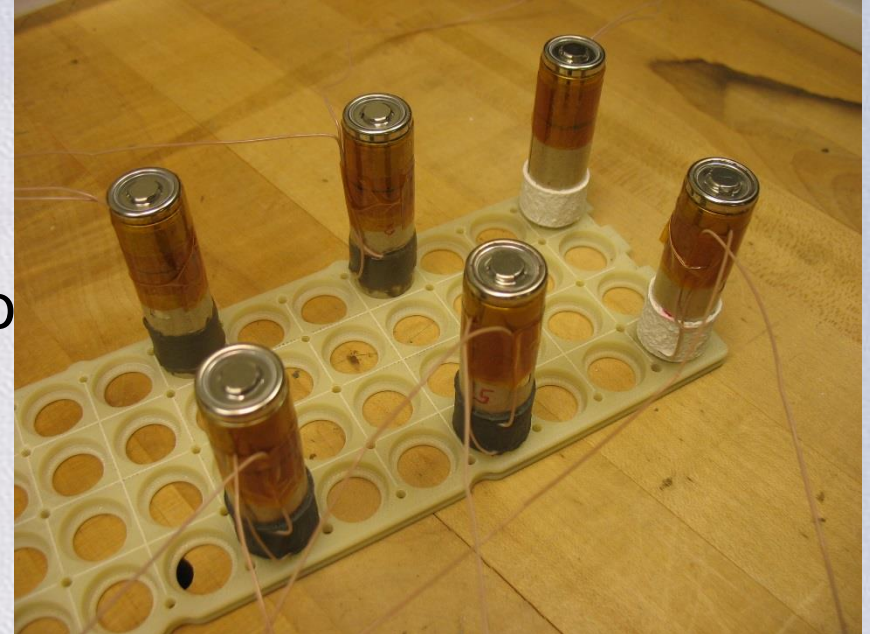

Run 17 – Pre Test

Vent Port Bracket with CFC and SS screens

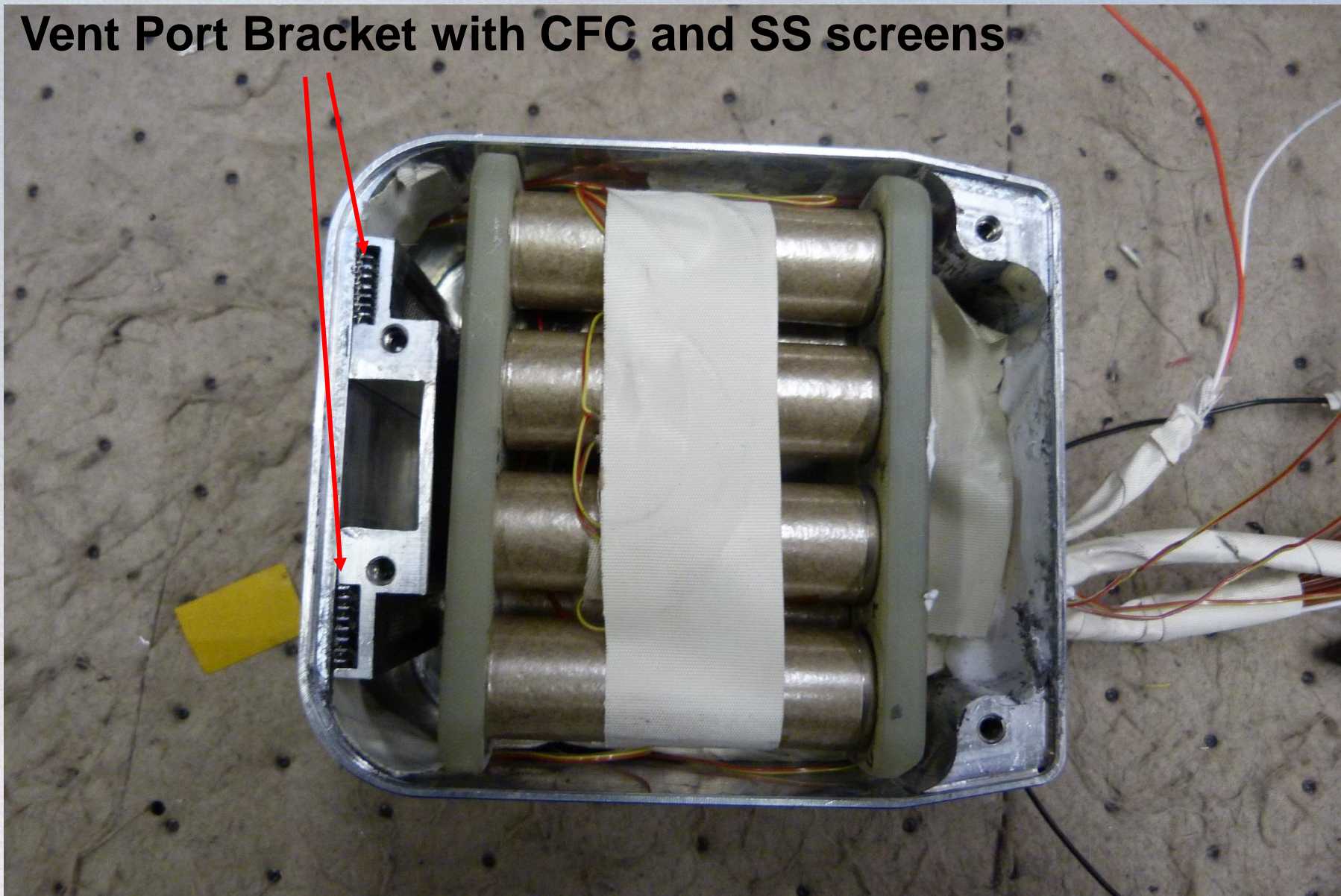

Run 17 pre test pics

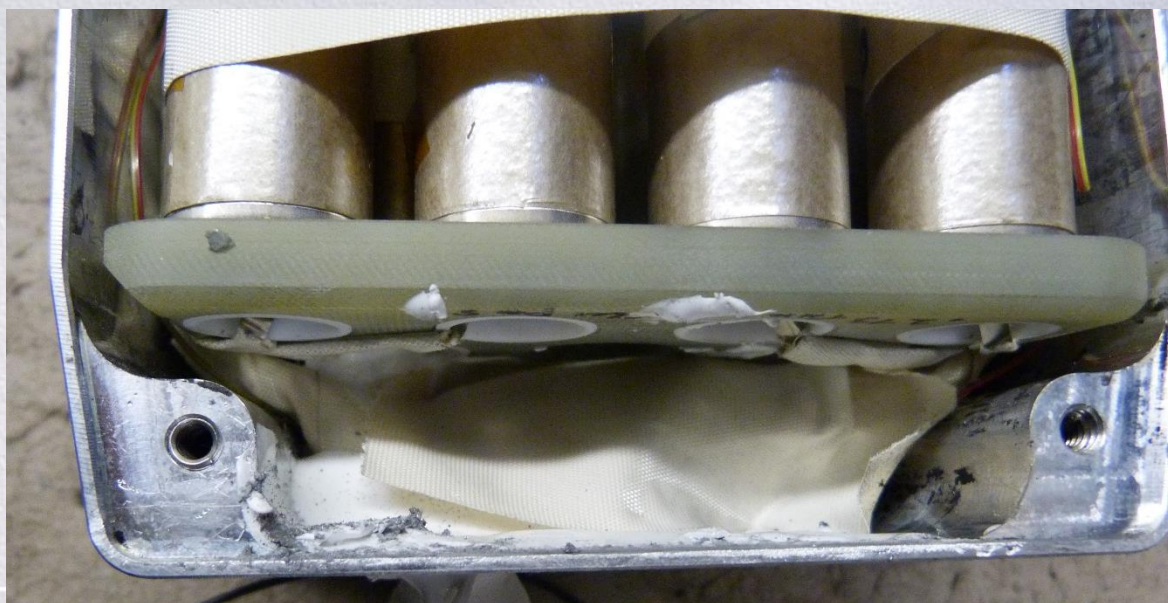
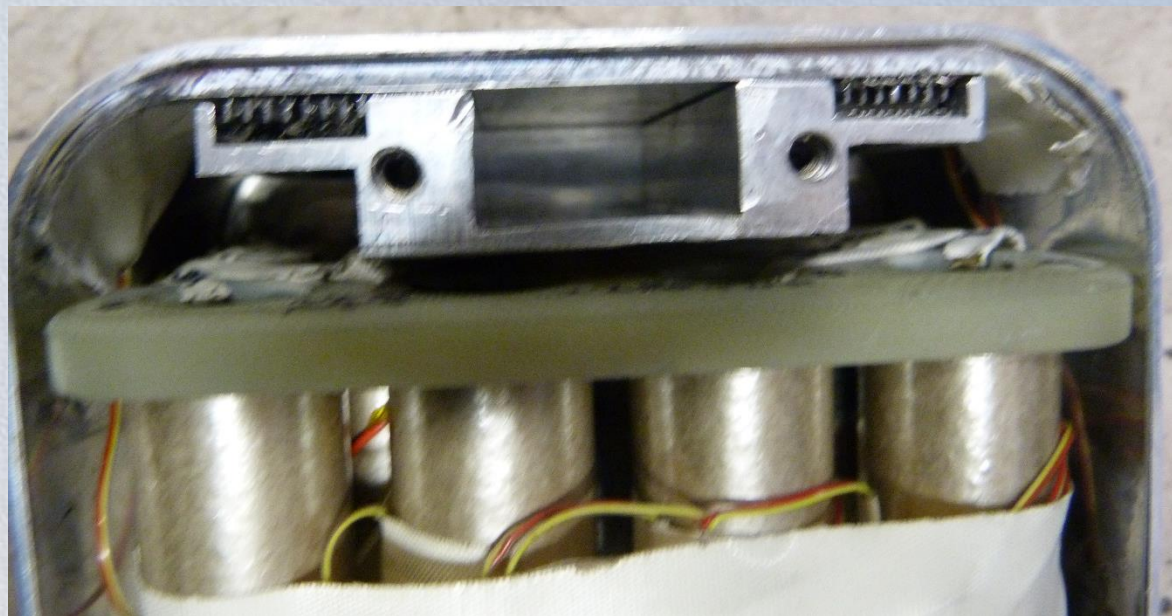

Run 17 Results

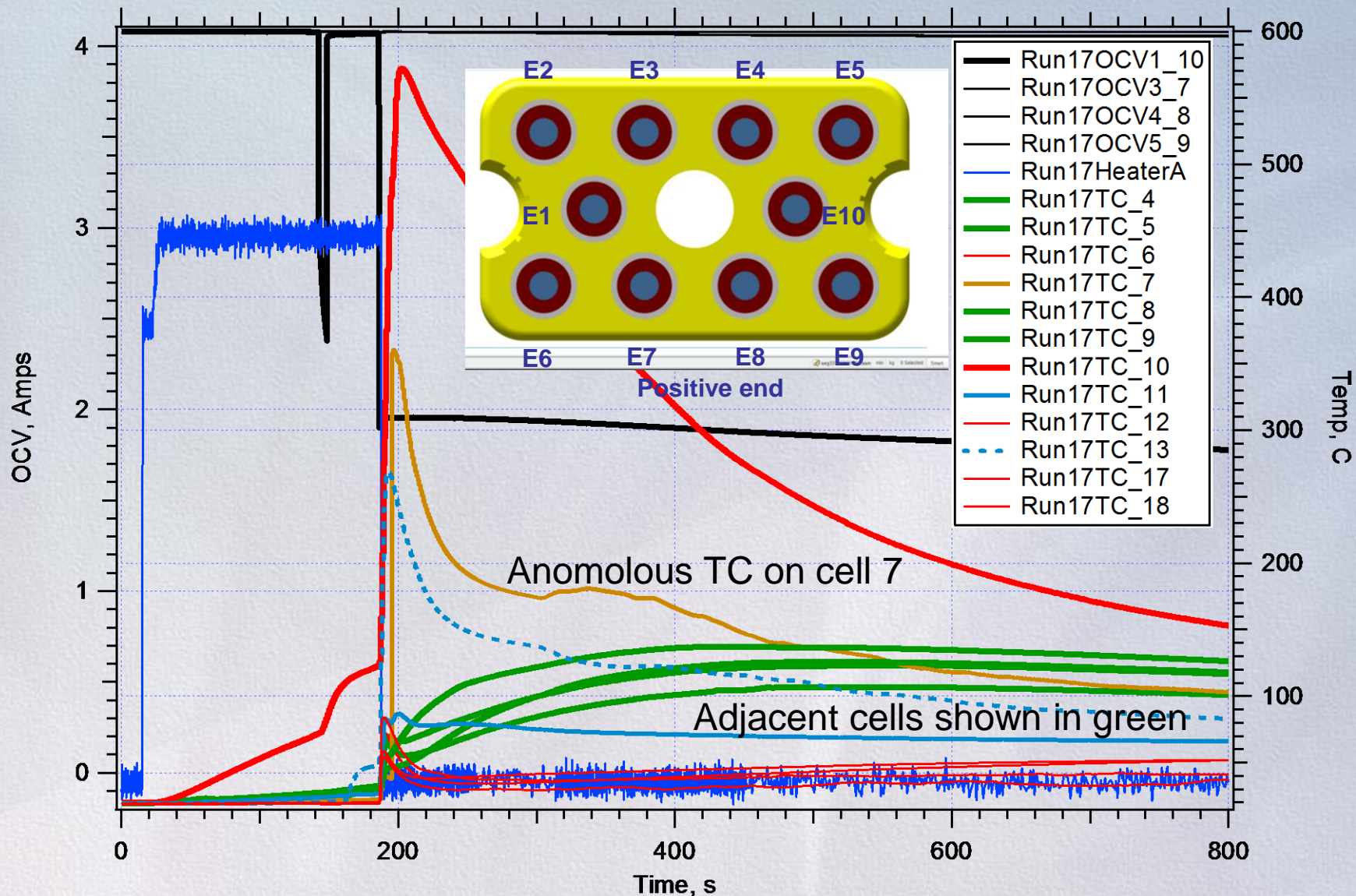

Heater powered at 46W, on for 173s, OCV dip at 130s lasting 6s, onset of trigger cell TR in 171s
 Trigger cell max temp = C, adjacent cells 4, 5, 8, & 9 max at 107, 123, 126, & 137C, respectively

Run 17 Close Up

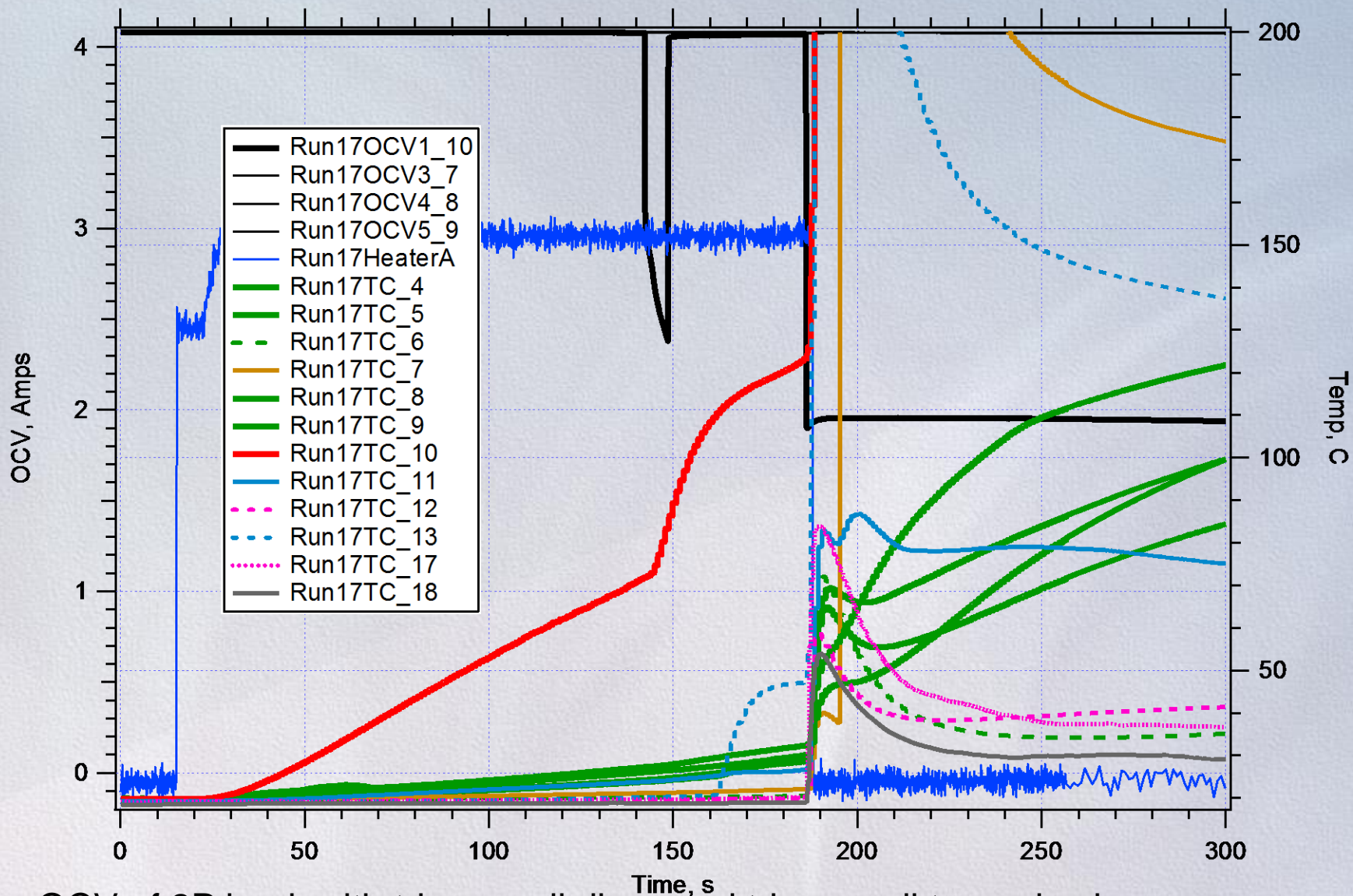

OCV of 2P bank with trigger cell dives and trigger cell temp rise increases, indicating a cell internal short occurring about 40s prior to TR

Video Snapshot – No sparks

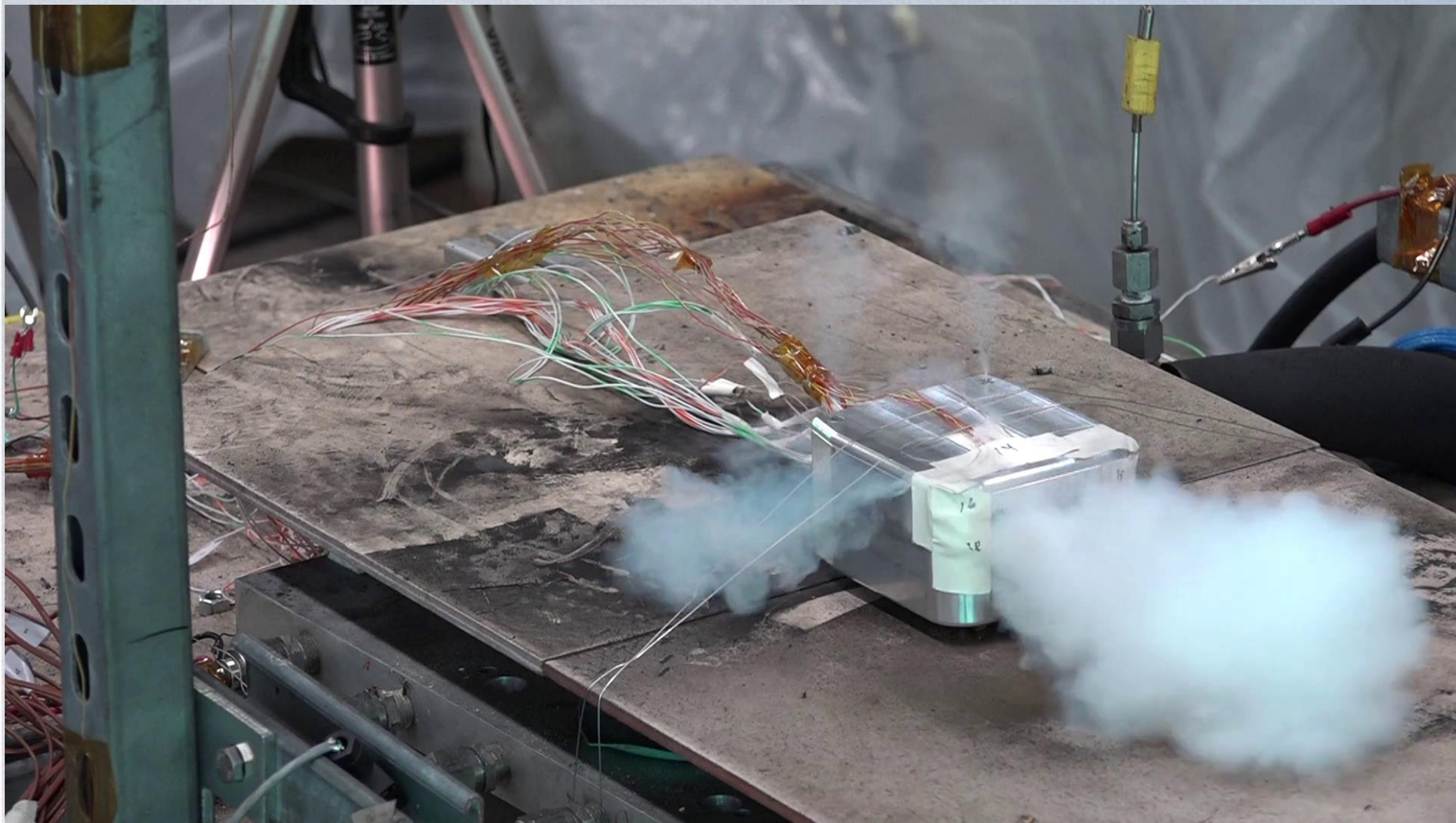

A split second after trigger cell TR, most of the vent cloud exits the vent ports, the rest exits the housing to lid joint – **All adjacent cell OCVs unaffected by test**

Video of LPGT Run 17

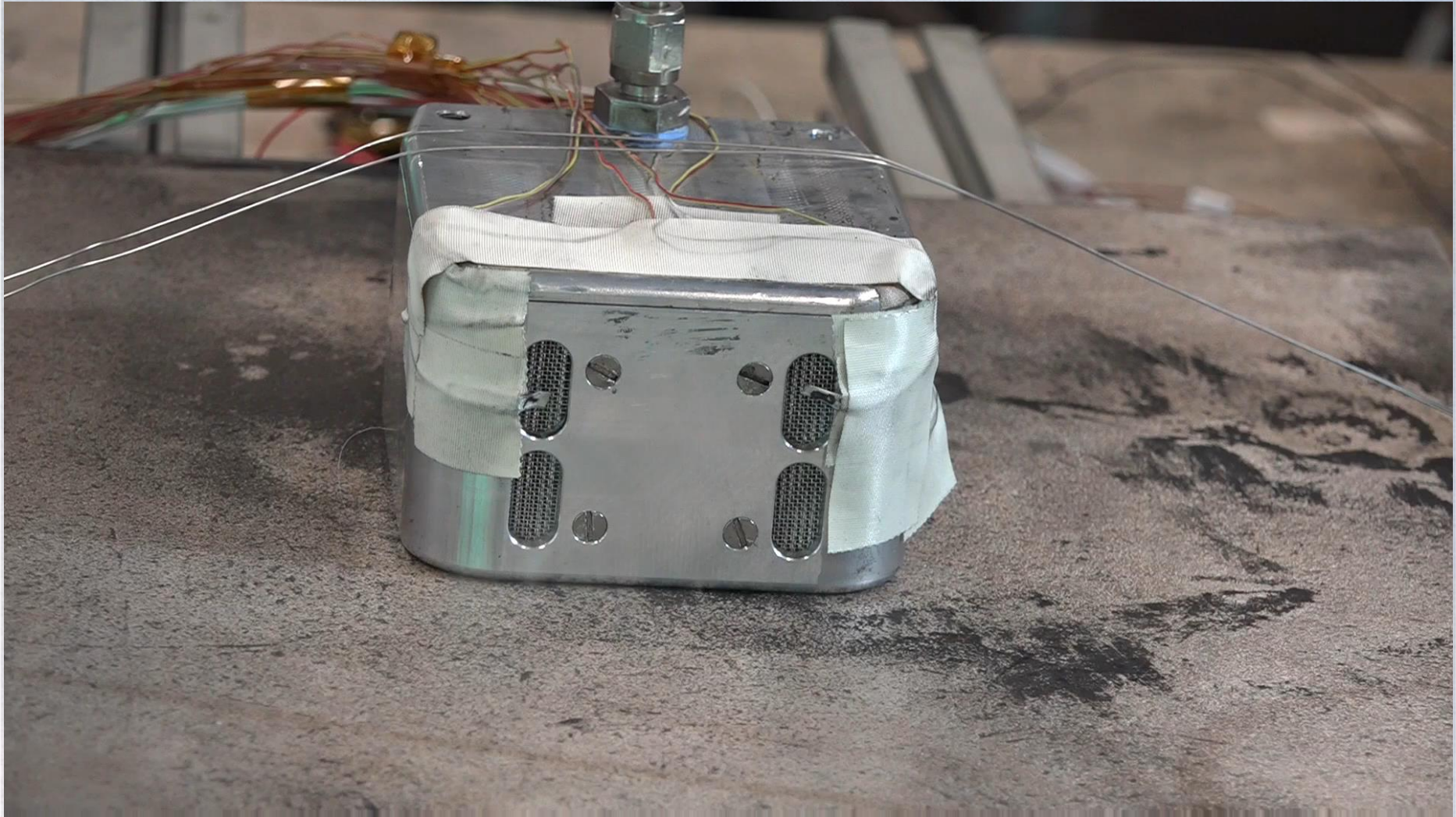

Lessons Learned So Far

- Design must prevent first TR propagation from initial failed cell:
 - Entire battery gets hotter with each subsequent cell TR event
- Limiting cell-to-cell thermal conduction appears to work:
 - Spacing out the cells $\geq 1\text{mm}$ is very beneficial
- Parallel cell bussing can provide significant in-rush currents into failed cell, which gets them hot:
 - Individually fusing parallel cells is effective
- LREBA picket fence design present a challenge that each cell only one or two next nearest neighbors to sink heat into, but benefits from each cell being closer to a potential heat sink (housing/lid).
- Conversely, packs with closely packed or nested cells, with no direct path to a heat sink or heat spreader, present different challenges and require different approaches.
- 18 LREBA and 9 LPGT full scale tests with no propagation
 - Last 8 LREBA runs with interstitial materials reduced adjacent cell max temp, resulted no OCV decline even with 20% higher energy density cell design

Lessons Learned (cont.)

- Soft goods bag needs reinforcements
 - Additional Ni foil layers help, but flame arresting carbon fibercore found to be more effective
- Managing the vent/ejecta path is critical:
 - Combustion of expelled electrolyte must be directed away from adjacent cells with path sealed good high temperature materials & joints
 - Cell TR ejecta can bridge to adjacent cells and cause cascading shorts (suggests need for interstitial material between cells to protect cell cans)
 - Cell TR flame/flare attenuation with SS screens and carbon fibercore protected by baffle and tortuous vent path works
- Subscale test results can be misleading and no replacement for full scale test verifications
- Multiple cell triggers within same battery without screen maintenance in between test runs is risky

18650 Specific Energy (Wh/kg) Trends

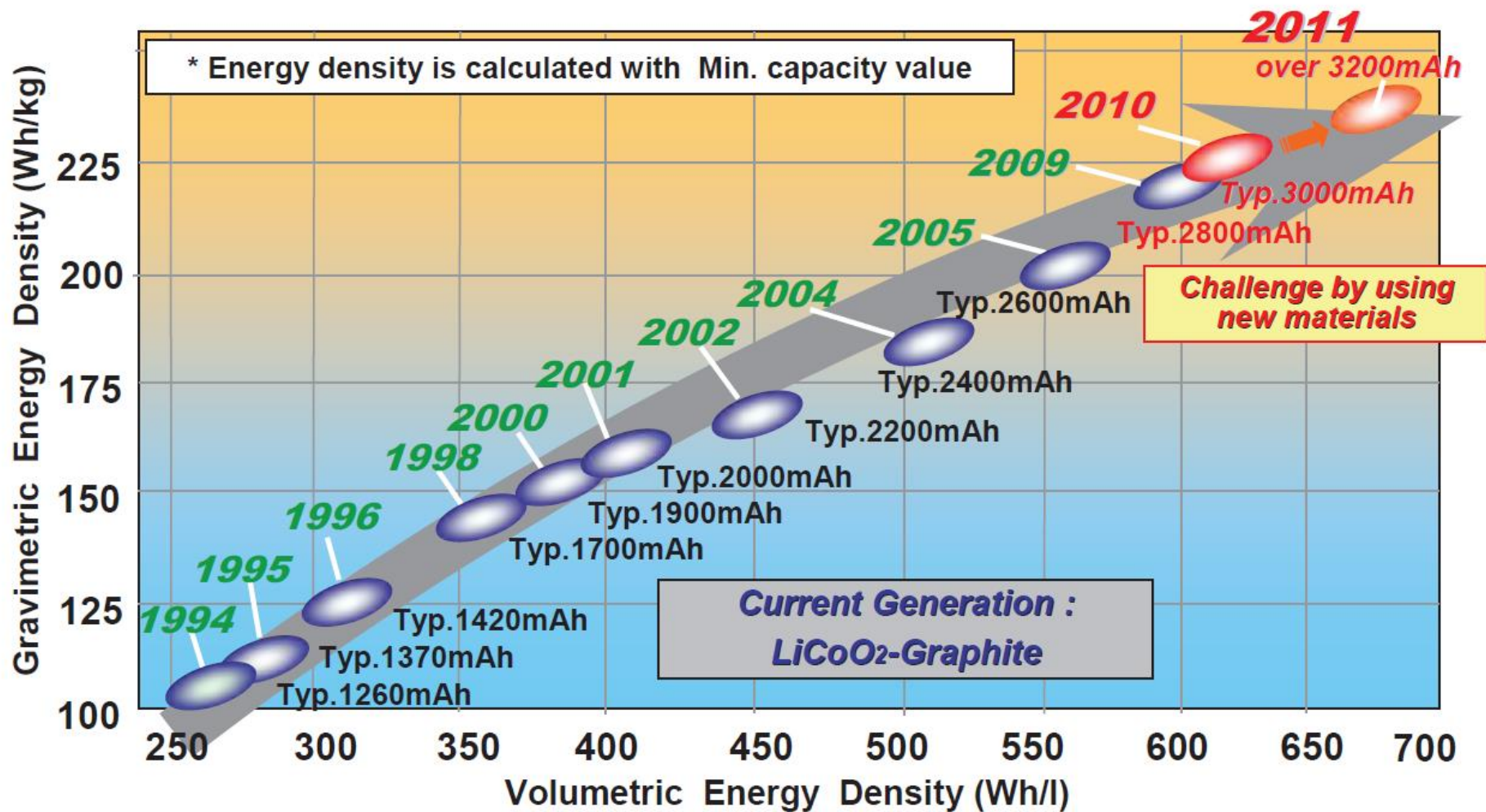

Source: Sanyo/Panasonic 2010

A high production rate design that achieves > 240 Wh/kg and > 660 Wh/L exists since 2012

Specific energy improvements are trending at 7-10% per year....should get to 300 Wh/kg by 2017

Small Cell Battery Approach

48-Cell Brick Module

Safety Features

- COTS cell design made in highly automated production line
- Individual cell fuses integrated in Ni bus plates
- 2mm cell spacing ensured with G10/FR4 capture plates

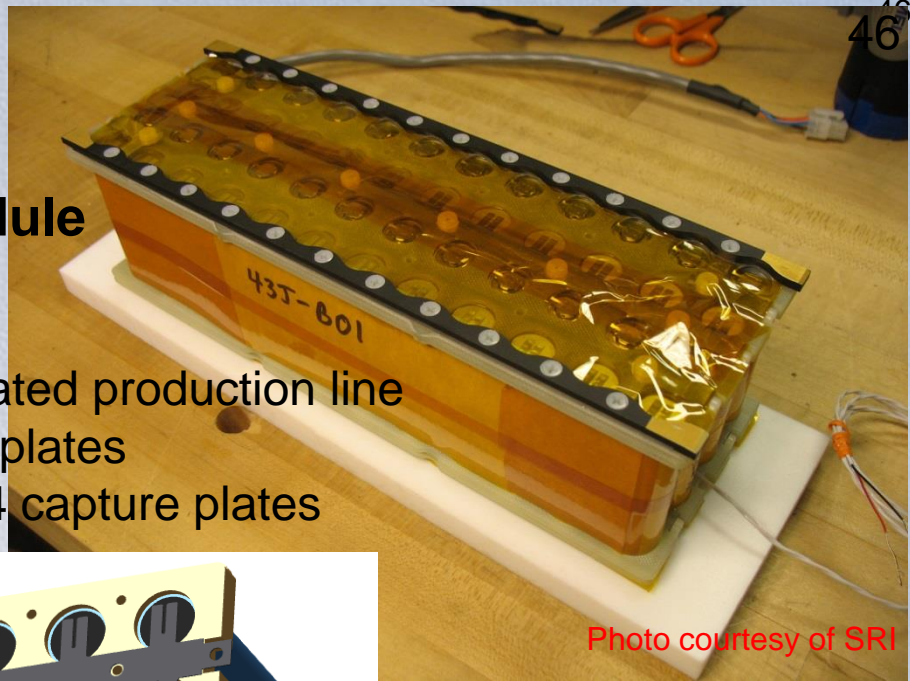
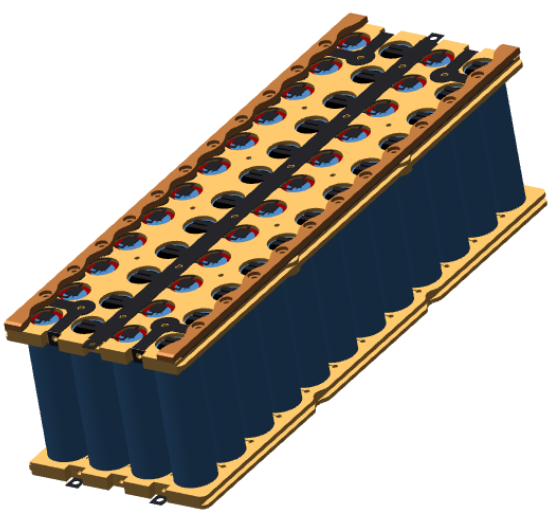
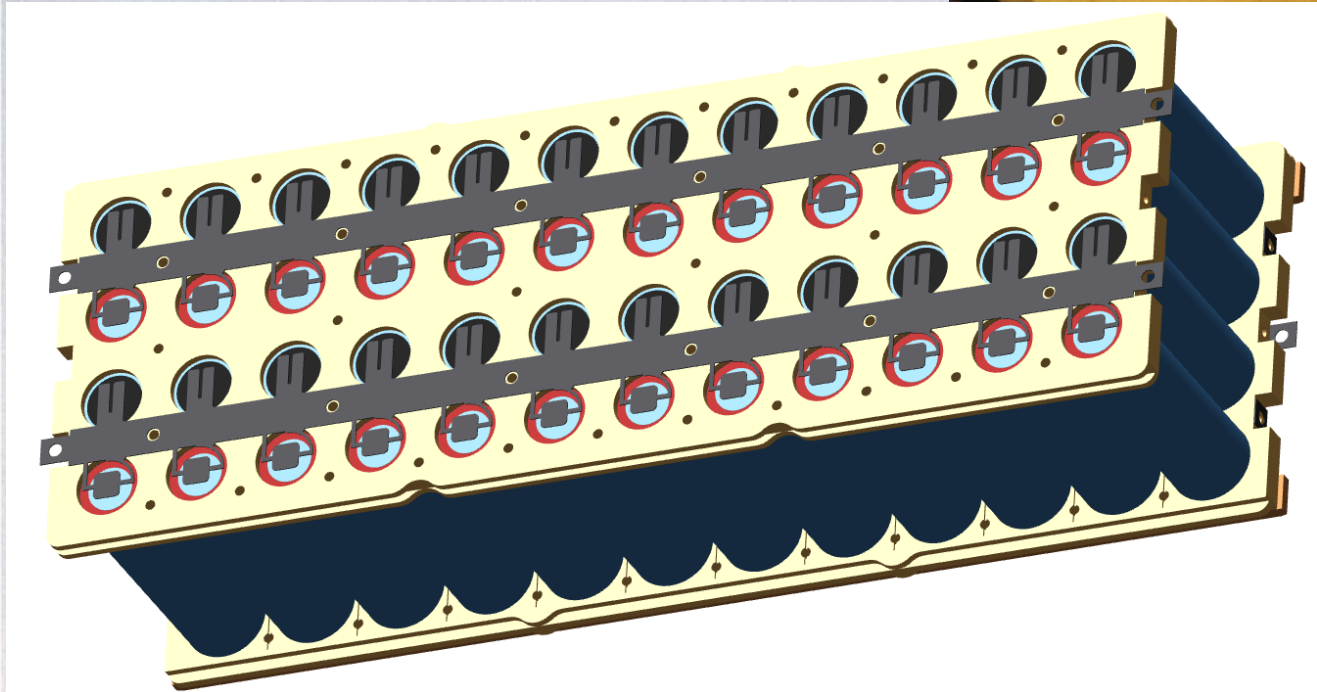

Photo courtesy of SRI



Using a COTS 18650 cell design (~240 Wh/kg), brick weighs 2.509 kg
Brick achieves 225 Wh/kg with 6A discharge to 12V after charging to 16.8V (4.2V/cell)

Small Cell Battery Demo

12p4s Battery Brick

Safety Features

- COTS cell wrapped in mica paper tubes
- Individual 10A cell fuses integrated in Ni bus plates
- 2mm cell spacing ensured with G10 capture plates

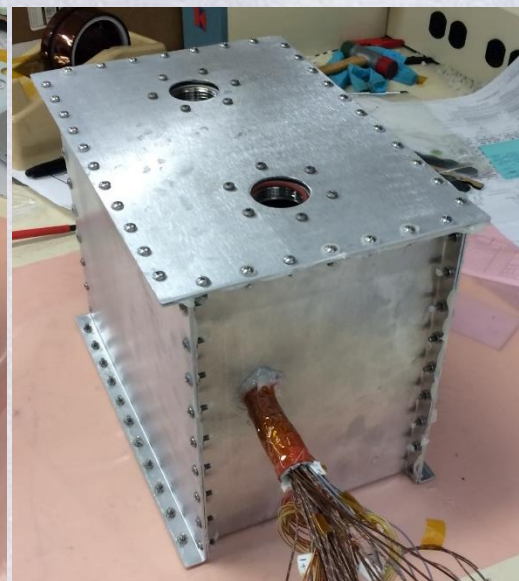
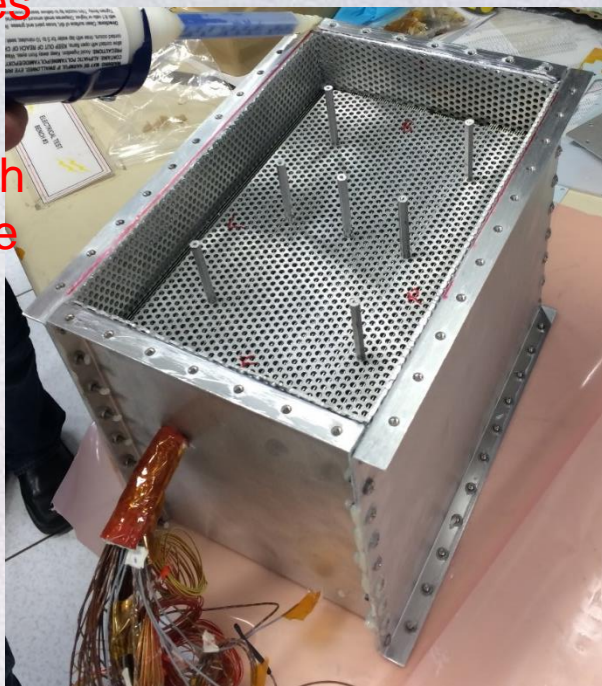
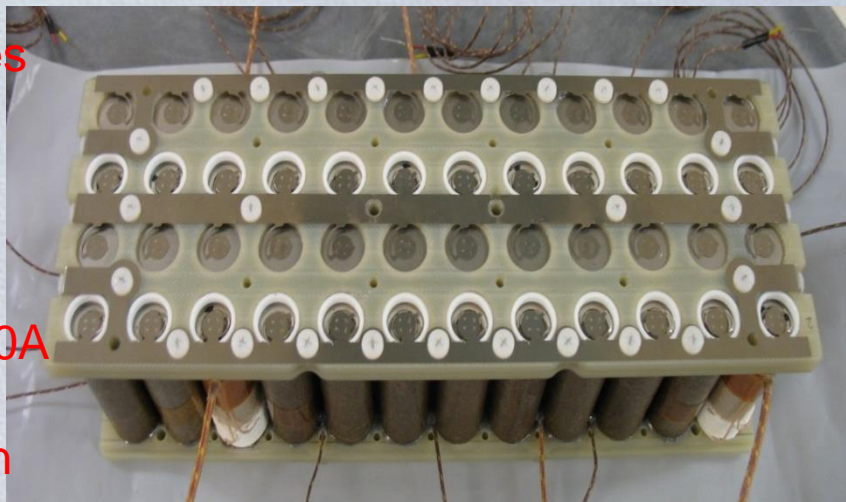

>1 kWh (96-cells)
Battery for Safety
Demo

Assembly Photos



Routing all those instrumentation wires

49

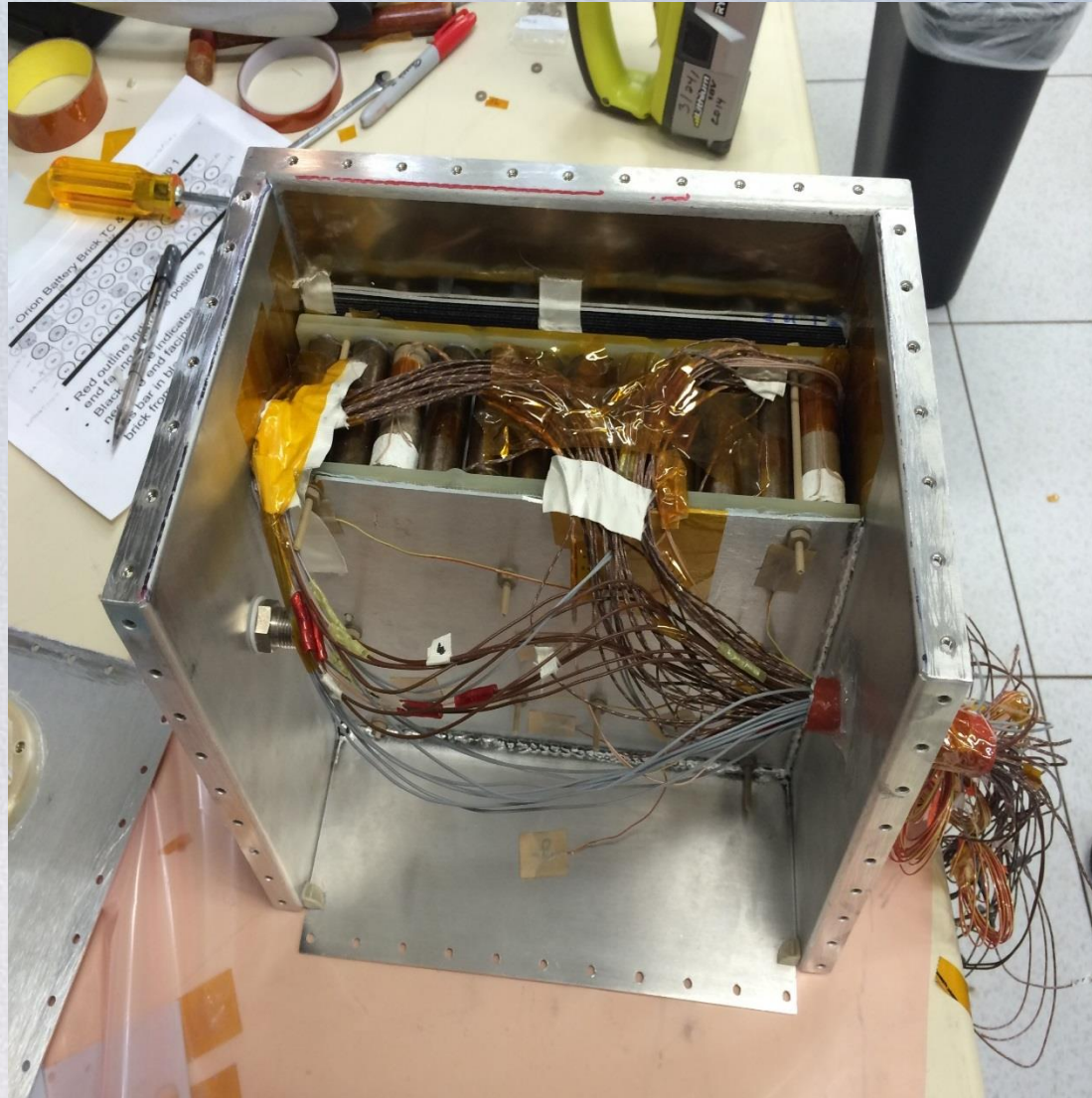

CFC on tray above bricks

50

Flame/Spark Arresting Feature

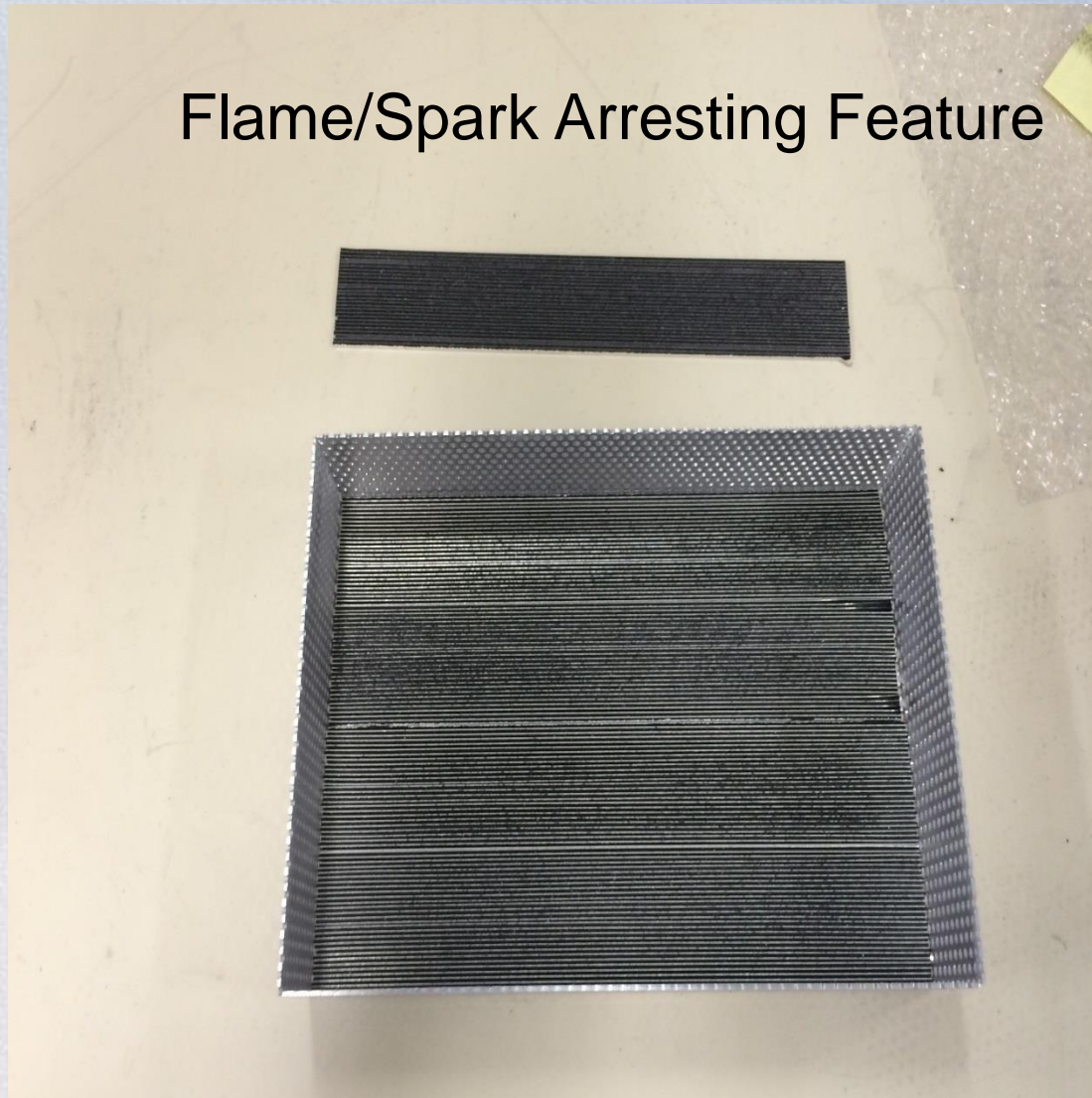

Top Tray with CFC under screen

591

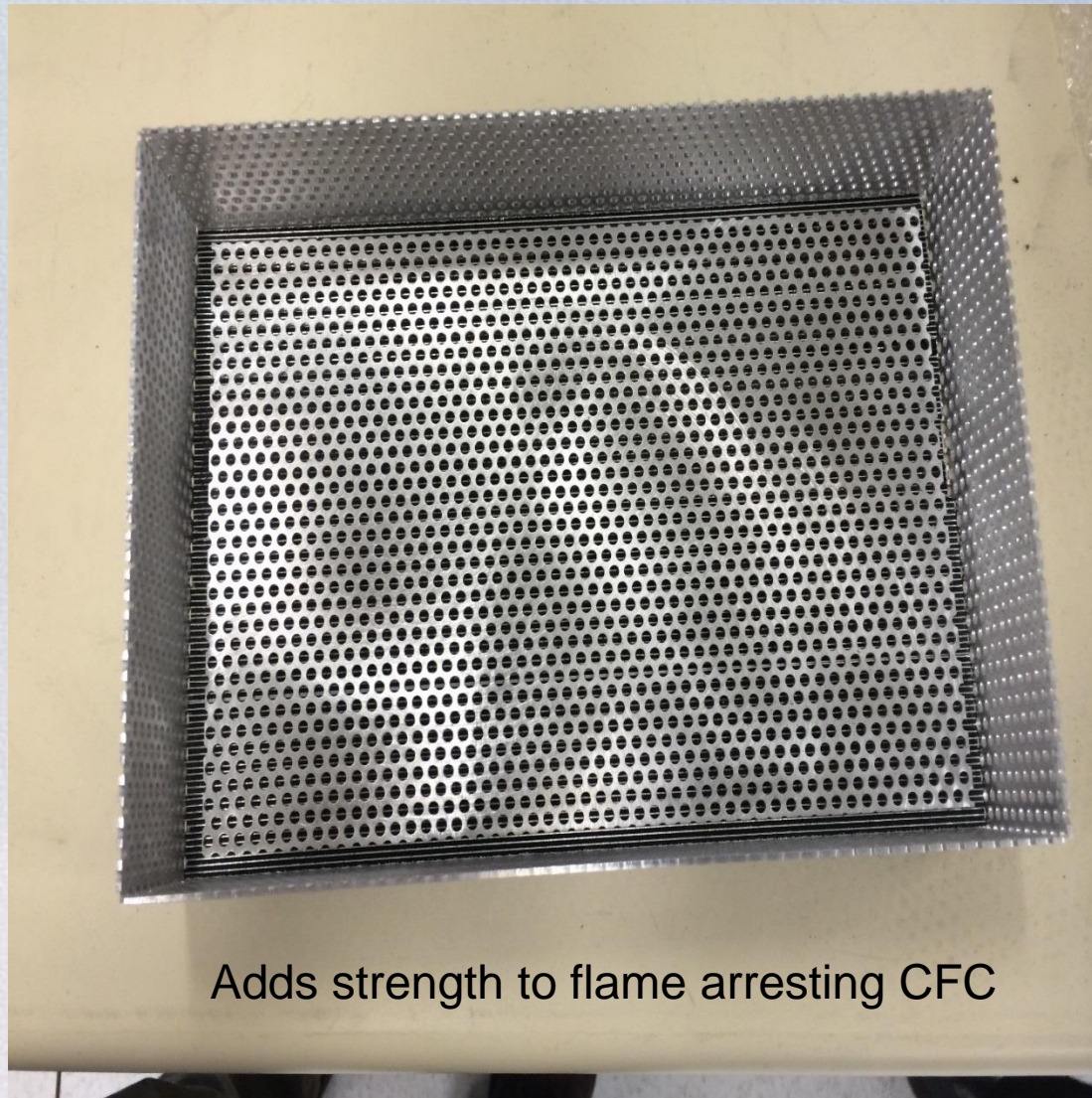

Adds strength to flame arresting CFC

Partial Battery Test 1

Orion Prototype Battery Brick Trigger Cell and TC Map

Brick 1: Top - 53CB01 ????

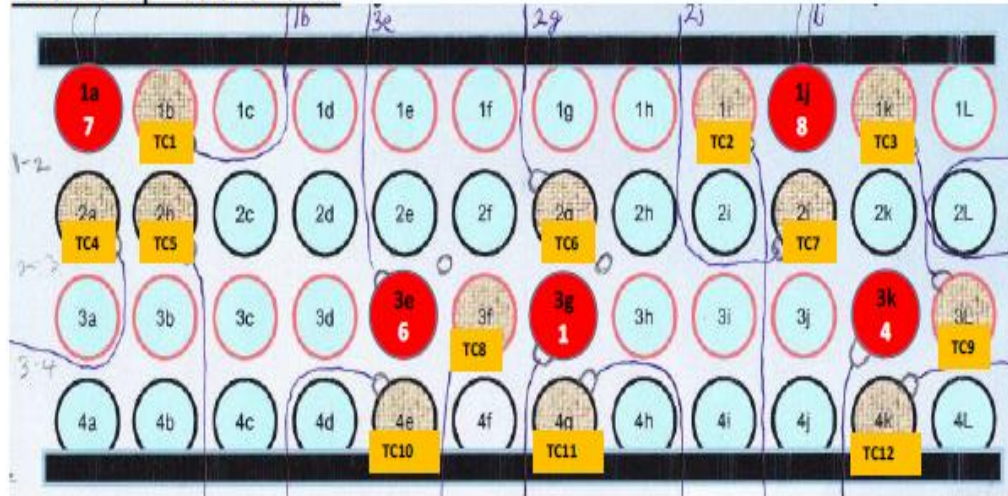

Brick 2: Bottom - 53CB02 ????

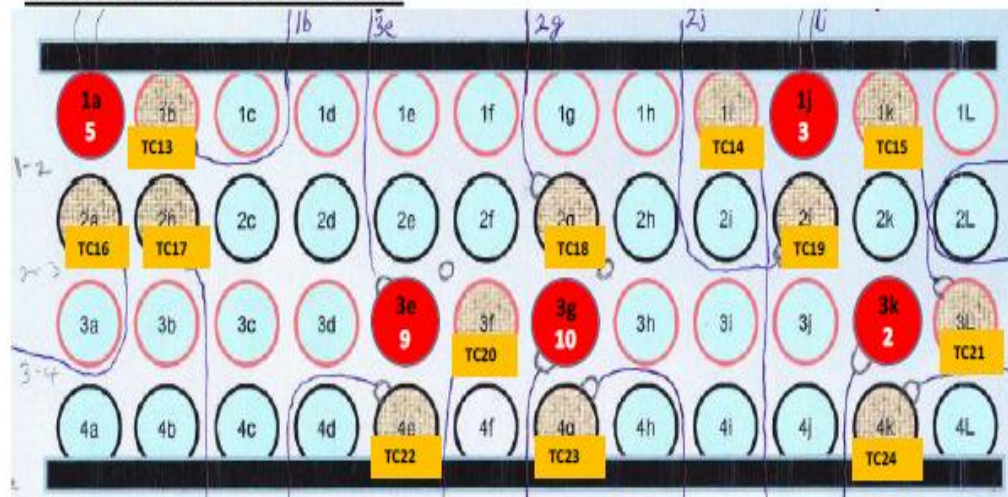

Ten trigger cell locations (in red) possible

- Corner
- Edge
- Interior

First 6 cells triggered with benign response

Battery wrapped in thermal blanket and sitting on cold plate at 40°C to start test



No propagation and no sparks/flames

96-cell Battery

- Run4- Trigger Cell 3k-top - heater

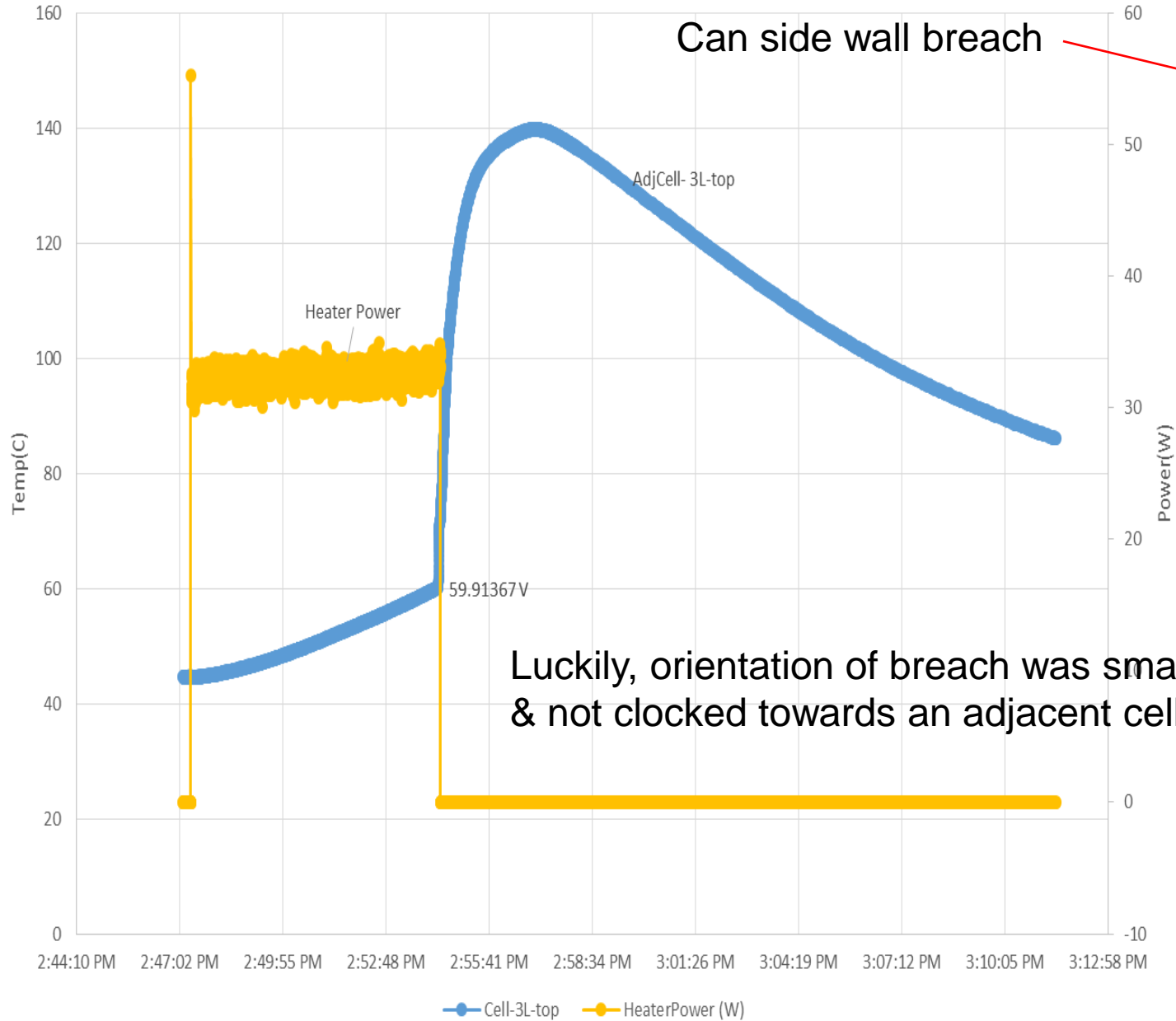

Can side wall breach

Luckily, orientation of breach was small & not clocked towards an adjacent cell



96-cell Battery

- Run4- Trigger Cell 3k-top

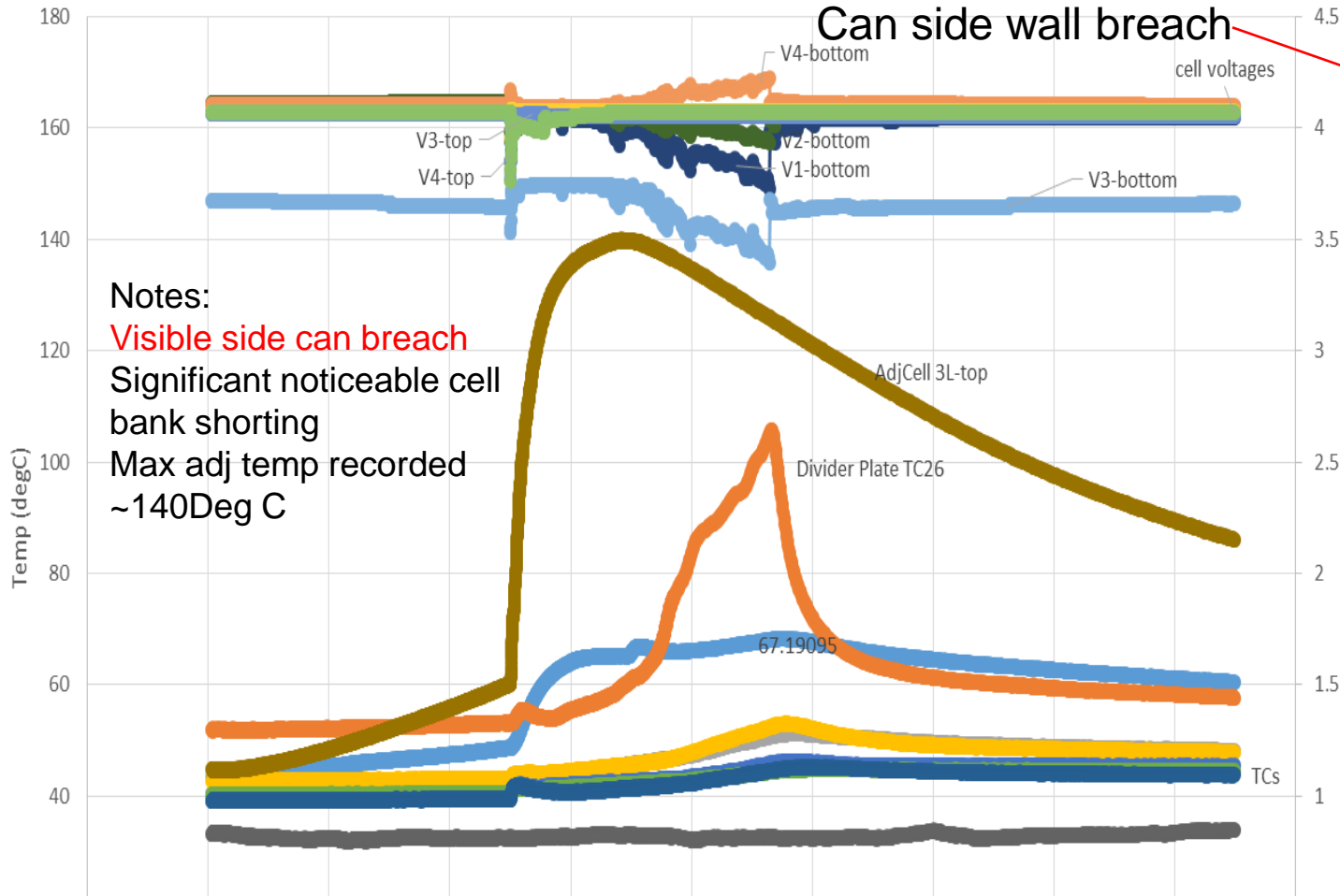

Sidewall failures were not an issue with LREBA or LPGT. It's lower energy cell design (2.6Ah) has been proven to fail in a reliable/predictable fashion. Cell designs > 2.8Ah are less predictable. Therefore, we need to consider some interstitial material to protect adjacent cells from sidewall failure.

Cell Can Wall Cross Sections

240 Wh/kg, 660 Wh/L 18650 cell design

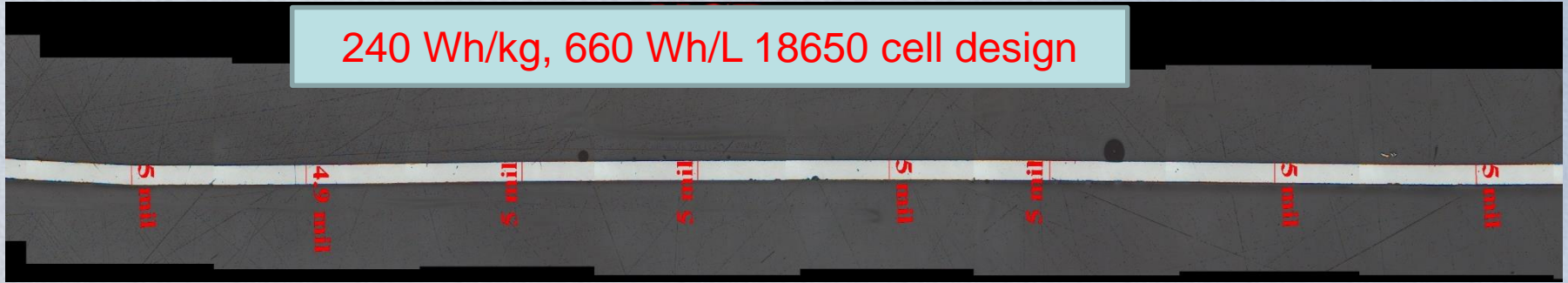

Samsung

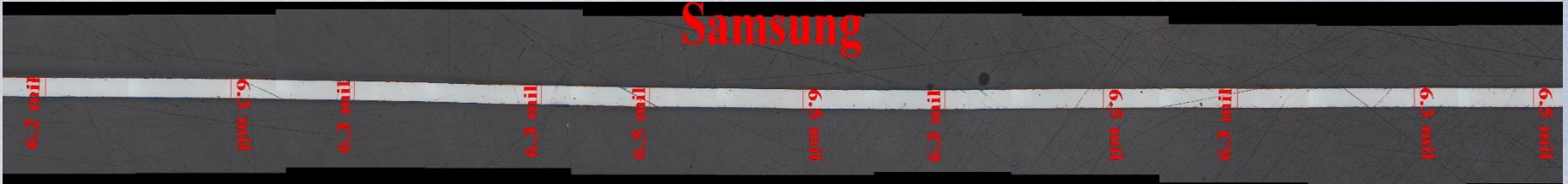

Moli

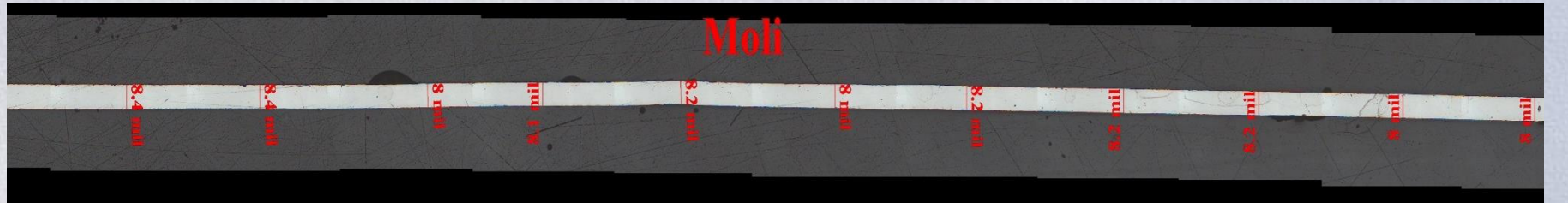

240 Wh/kg COTS design averages 127 μm
 ICR18650-26F (Samsung) averages 160 μm
 ICR18650J (Moli) averages 208 μm

Thin can wall for >660 Wh/L design → high likelihood (~15%) to side wall ruptures/breaching
 Presents a high risk for cell to cell thermal runaway propagation to neighboring cell
 Need a method to induced can wall ruptures (breaching) to verify design improvements

Sanding spot on can, leaving only 40% thickness

60W achieved onset of TR in 116s



Thinned area of can

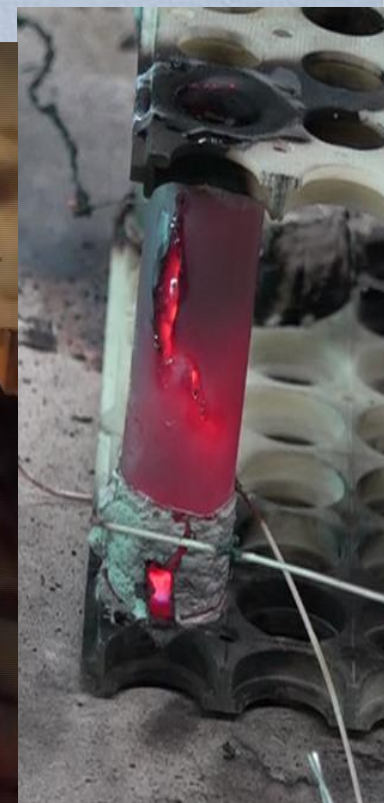
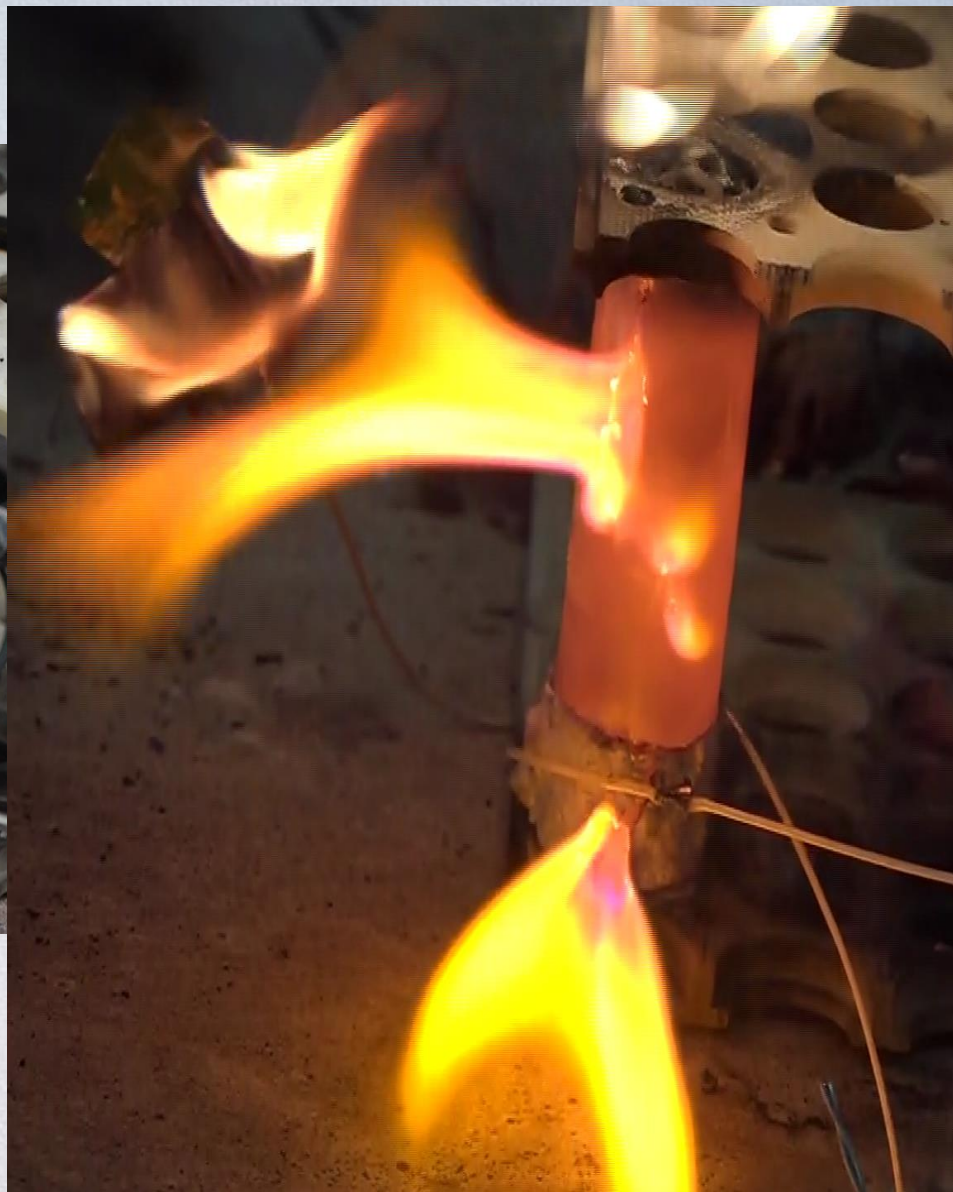

Side wall breach achieved in weakened area and another breach in heater area

Sanding spot on can - leaving only 60% thickness

60W achieved onset of TR in 98s



Side wall breach achieved in weakened area and another breach above heater area

Pre-Test Photos

AZ-34 Syntactic Foam (Epoxy Binder)

Trigger cells in positions 3, 5, & 7

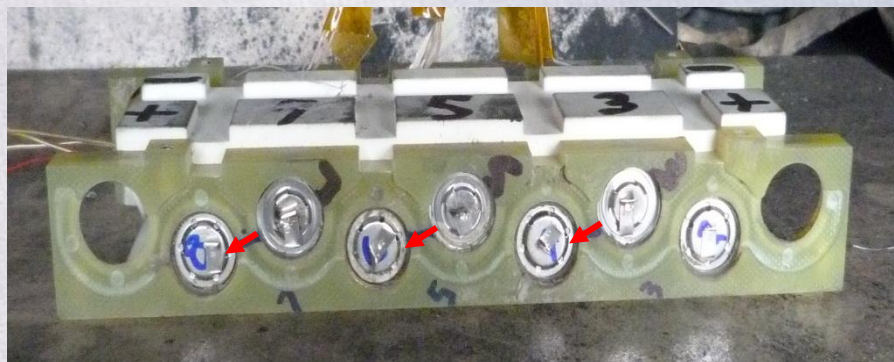
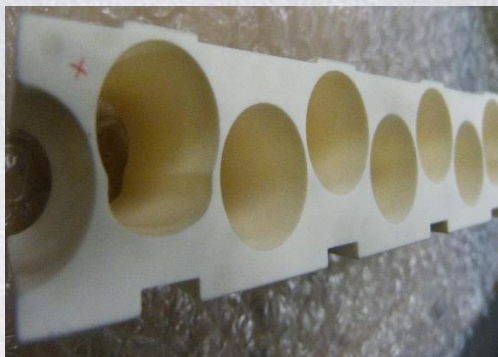
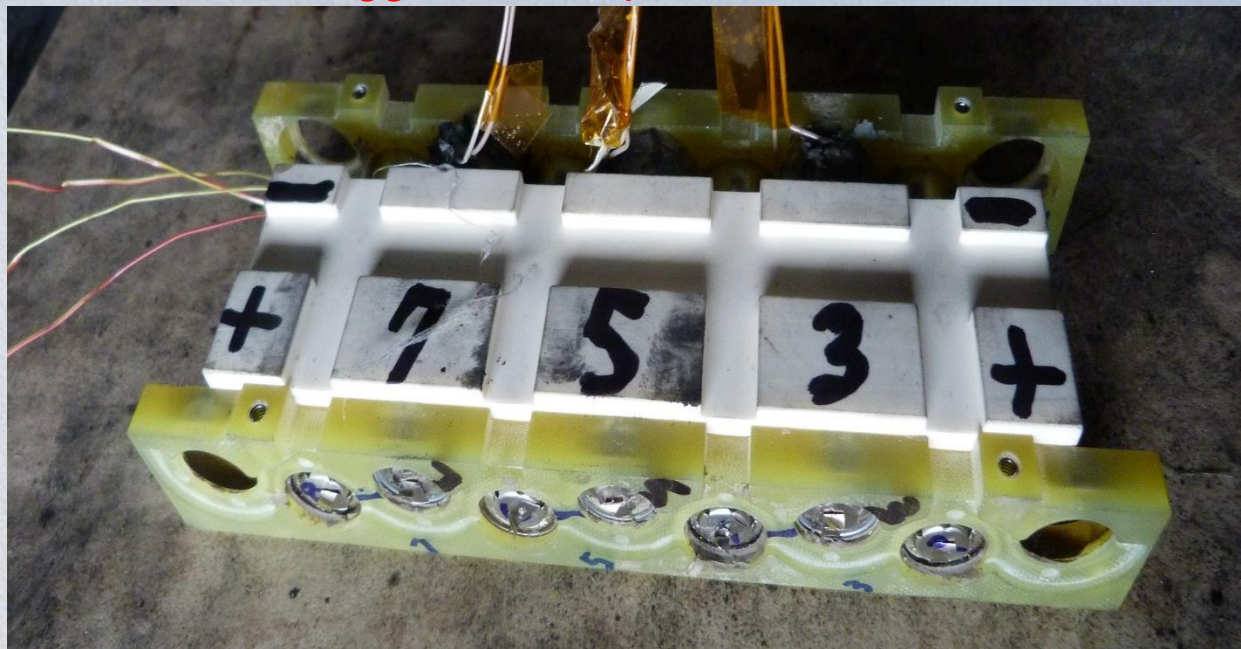

Weakened can walls on trigger cells orientated towards adjacent cells

Post Test Photos

Since heater of trigger cell 3 was in contact with adjacent cell, TR propagation occurred



Test was performed in inert gas, N₂, environment to limit foam combustion risk

Sanded down cells – Post Test

* No side wall breaching!



Weakened can area of trigger cells did not breach



Does the snug fit of the foam prevent can wall breaching?



More Lessons Learned

- Thin can wall and high energy content makes it likely that ~ 240 Wh/kg, 660 Wh/L cell design will experience side wall rupture during TR
- Structural interstitial foam supports can and prevents side wall can breaching
 - No breaching in areas where can wall was intentionally weakened when supported by snug fitting syntactic foam
 - Foam adds a 10% mass penalty to the battery brick
 - >200 Wh/kg achieved at brick level with foam block



12p-4s battery brick with epoxy syntactic foam interstitial material

Take Home Message

- Preventing cell-cell TR propagation and flames/sparks from exiting battery enclosure is possible with proper thermal & electrical design and cell TR ejecta/effluent management and can be had with minimal mass/volume penalty
- First redesign took 5 months
- Subsequent ones take less than 3 months

