

Multi-Axis Independent Electromechanical Load Control for Docking System Actuation Development and Verification using dSPACE

dSPACE Technology Conference

Christopher Oesch – Moog

Brandon Dick – Boeing

Timothy Rupp – NASA

October 13-14, 2015

MOOG
SPACE AND DEFENSE GROUP

Abstract

The development of highly complex and advanced actuation systems to meet customer demands has accelerated as the use of real-time testing technology expands into multiple markets at Moog. Systems developed for the autonomous docking of human rated spacecraft to the International Space Station (ISS), envelope multi-operational characteristics which place unique constraints on an actuation system. Real-time testing hardware has been used as a platform for incremental testing and development for the linear actuation system which controls initial capture and docking for vehicles visiting the ISS.

This presentation will outline the role of dSPACE hardware as a platform for rapid control-algorithm prototyping as well as an EMA system dynamic loading simulator, both conducted at Moog to develop the safety critical Linear Actuator System (LAS) of the NASA Docking System (NDS).

Presentation Overview

- Company Information
- Introduction of Docking System Concept of Operations
- Hardware Configurations
- Expansion to Multi Axis
- System Testing with Independent Multi-axis EMA Control

Company Overview

Company Overview Slides

Docking System Introduction

Docking System Operations

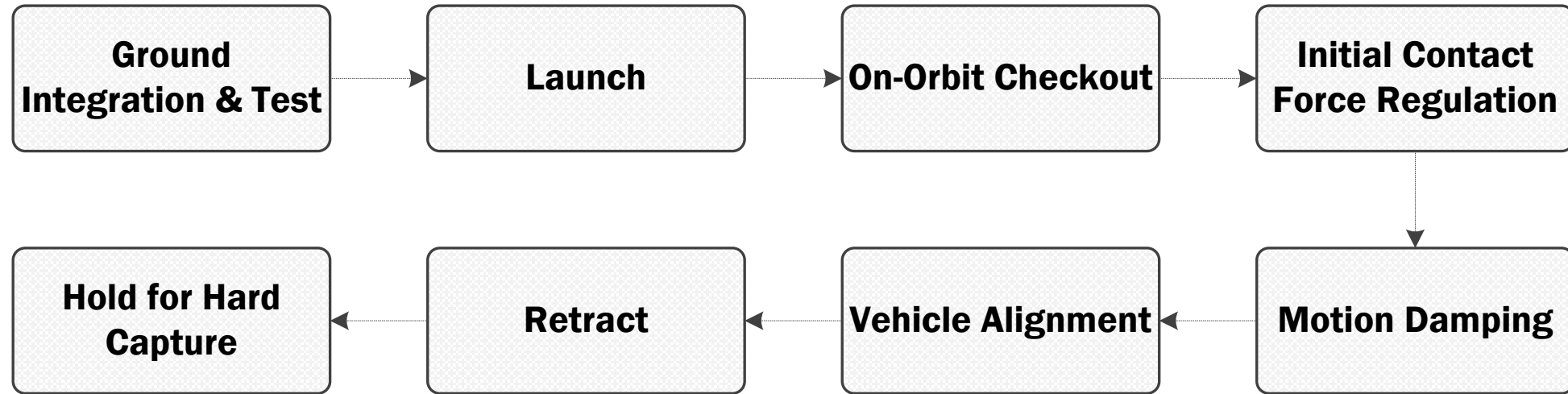

- Concept of operations for initial docking and control to hard capture requires three major control modes from the actuation system controlling the 6 degree of freedom interface docking ring mechanism:
 1. Position control (unloaded and mass loaded)
 2. Motion damping
 3. Slip force regulation

Mechanism Concept

Visiting Spacecraft



Image Credit: www.nasa.gov

Interface Adapter



Image Credit: www.nasa.gov

Need for Advanced Testing Techniques

- Autonomous docking sequence testing was required
 - All control modes are exercised during the test sequence
 - Multiple configurations of initial conditions were required
- Actuation system had to be tested independent of the docking mechanism interfaces
 - Required independent test load control, simulating docking loading scenarios
- The selected development process required flexible testing solutions
 - Build, test, update models, update requirements...repeat
 - Rapid system development – development timeline ranked highest on program importance

Testing Hardware

Flexible HIL Control Platform

- dSPACE chassis
 - DS1006 processor card
 - DS5203 FPGA card w/ expansion I/O
 - 3x for multiple EMA control
 - DS2004 A/D card
 - DS2102 D/A card
- Sensor interface modules
 - Voltage buffers
 - Current drivers
- Oscilloscope
- BNC I/O Interface
- ControlDesk Next Generation

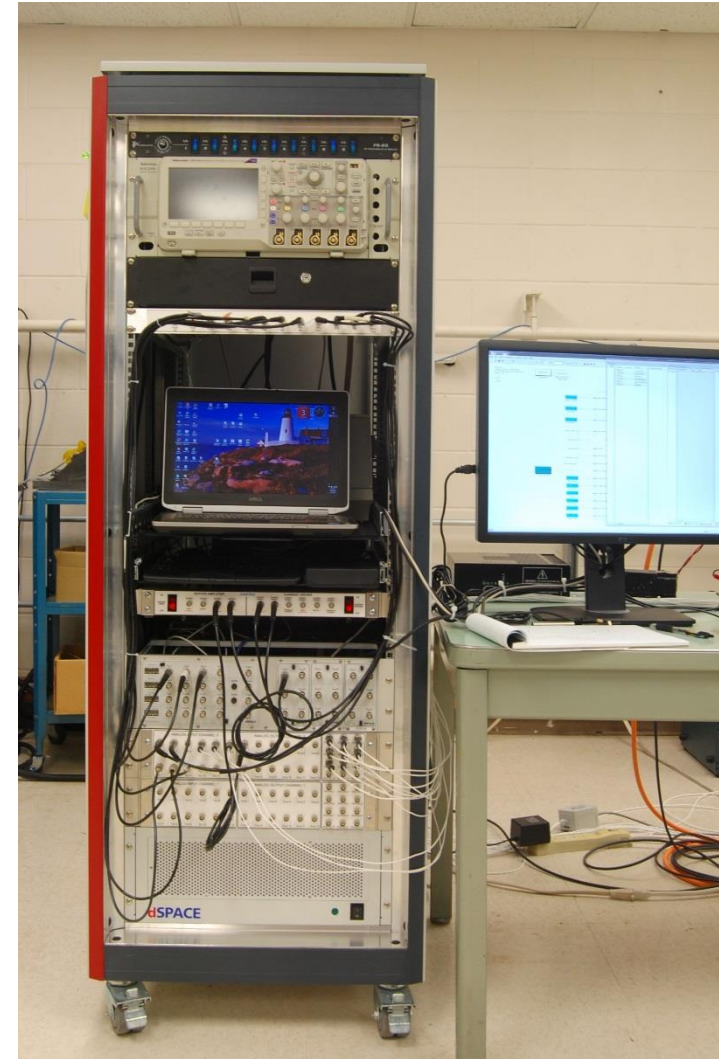

Initial Proof of Concept Setup

- Initial proof of concept was utilized to demonstrate initial concept of operation for strut control
- Platform for rapid control prototyping
- System identification techniques were developed
- Built user knowledge of dSPACE software
- Configuration:
 - Single brushless DC motor EMA
 - Hydraulic load actuator
 - Load controlled by position only

Proof of Concept Phase

- Moog developed a rapid prototyping proof of concept test stand platform to test electromechanical options for initial control demonstration
- dSPACE was used to control both the unit under test and the load cylinder
- Rapid prototyping served as a useful mode of operation to develop requirements and iterate on design solutions
- System identification techniques were developed for model correlation

Single Channel EMA and Hydraulic Test Stand

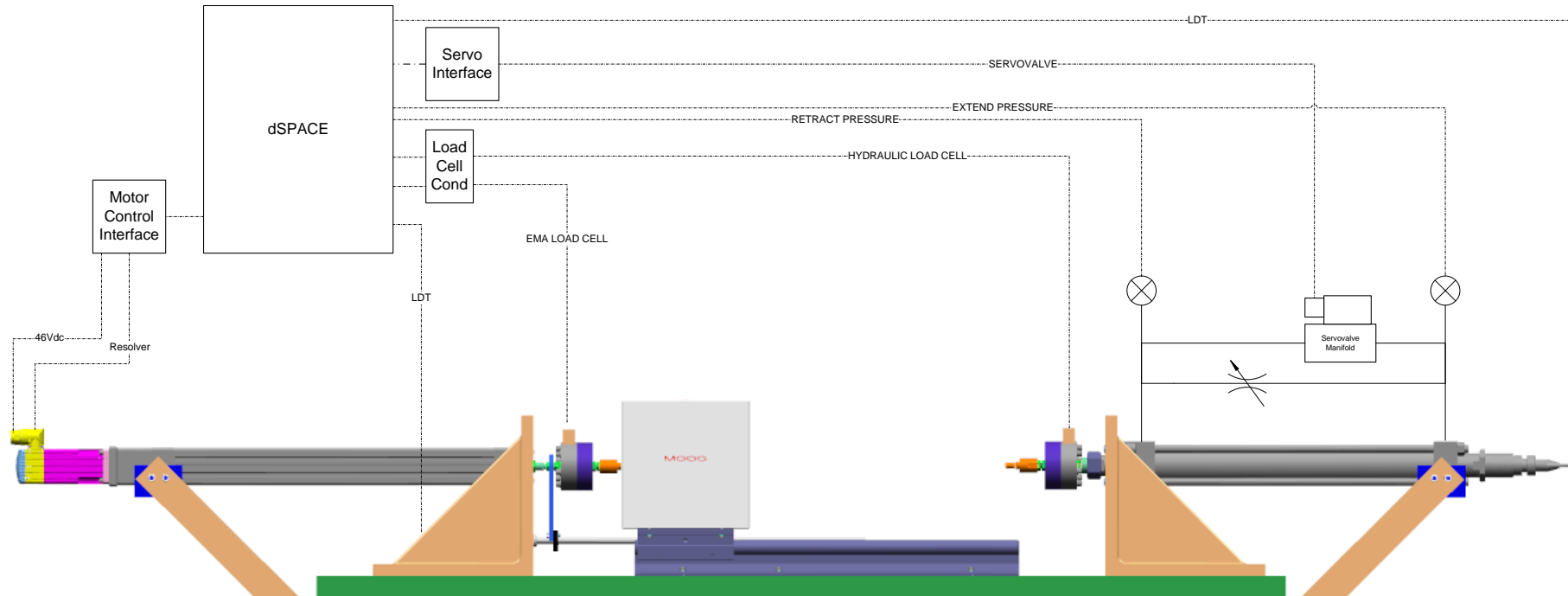

Single Channel EMA and Hydraulic Test Stand



Multiple Axis Expansion

Test Stand Configuration Change

- Desire to create a simulated variable inertial load reflected to the unit under test
- Challenges with hydraulic load cylinder
 - Complicated non-linear dynamics between servovalve and output were a challenge to compensate against
 - Control of force was completed by an unbalanced cylinder
 - Pressure systems were at the mercy of facility pump supplies
- An EMA load cylinder
 - Mechanical characteristics between servo input (motor) and output (force) are easier to system ID
 - Ability to create a very large reflected inertia

Dual EMA Configuration

- EMA #1 – Unit Under Test
 - Rapid control prototyping and system ID of latest flight actuator design
 - Multiple control modes
- EMA #2 – Load Cylinder
 - Position loop control
 - Dominating capability with very large reflected inertia
 - Inertia simulation control
- dSPACE configuration update
 - Two DS5203 FPGA cards with expansion I/O used to control two EMAs

Dual Channel EMA Test Stand

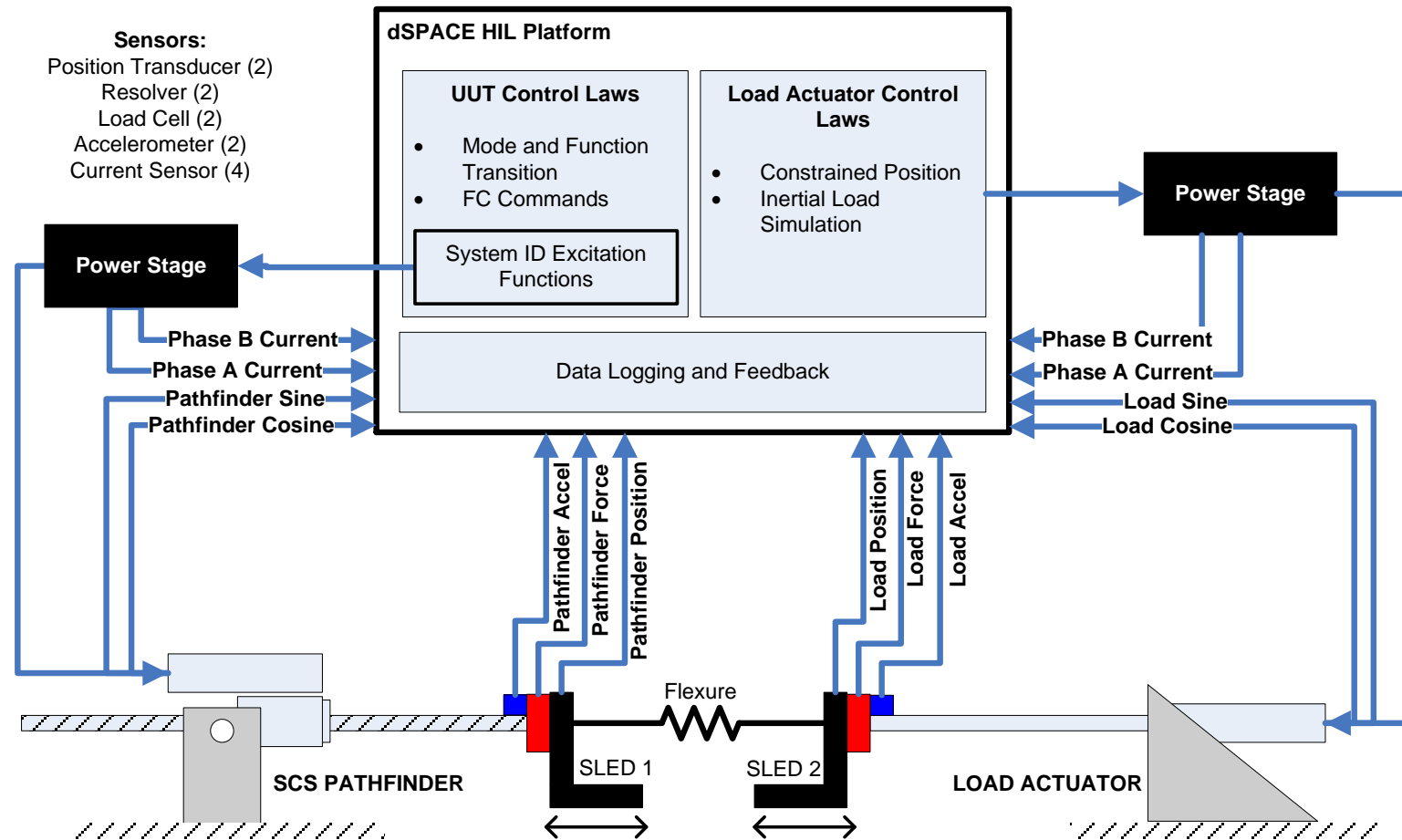

Dual Channel EMA Test Stand

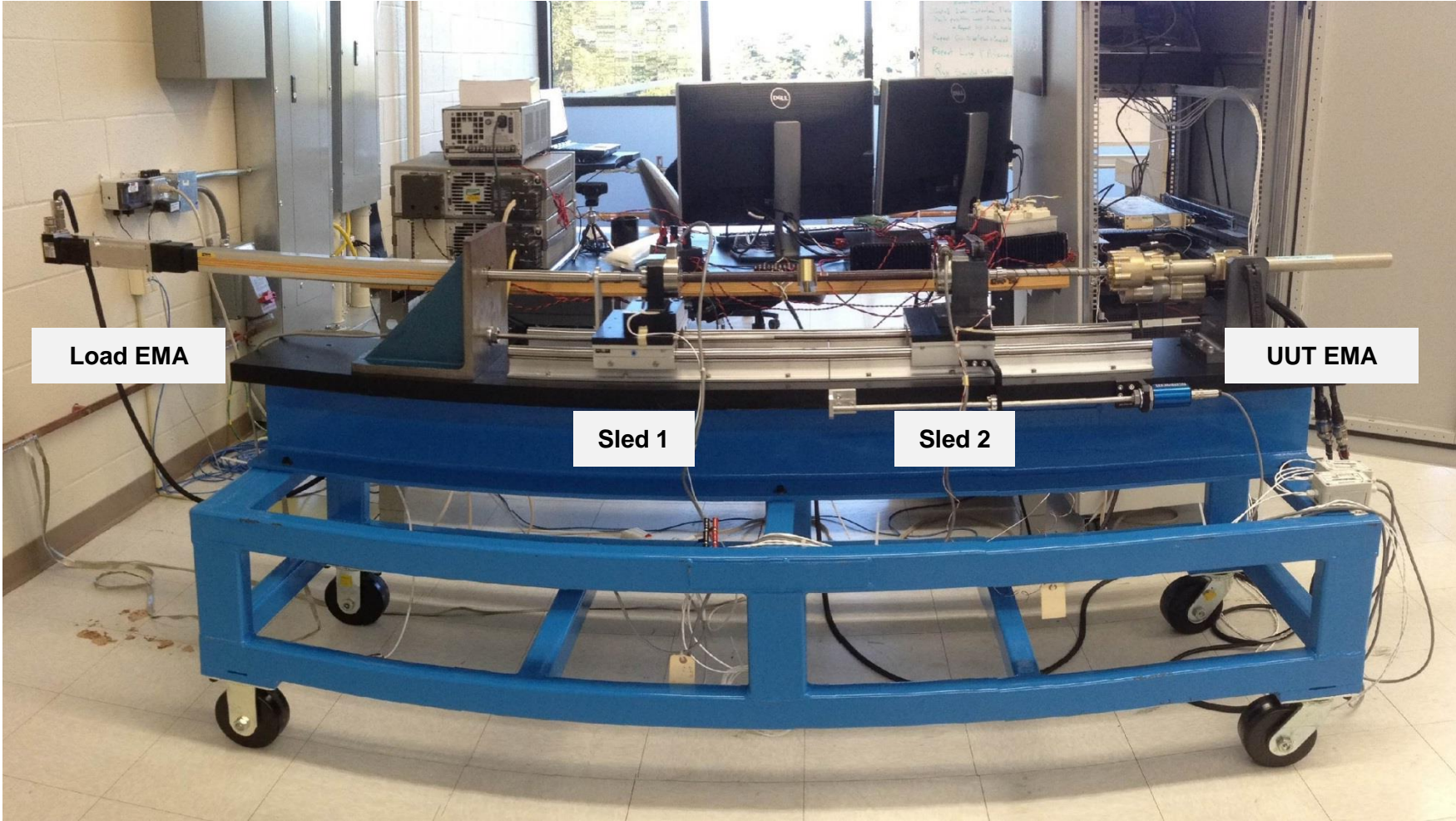

Six Axis Load Control

- Full up UUT system testing needs:
 - Six axis independent control
 - Flexible inertia simulation
 - Synchronized initial test conditions
- dSPACE configuration:
 - Two EMA controllers in a single DS5203 FPGA card with expansion I/O
 - Three DS5203 cards
 - DS1006 processor board

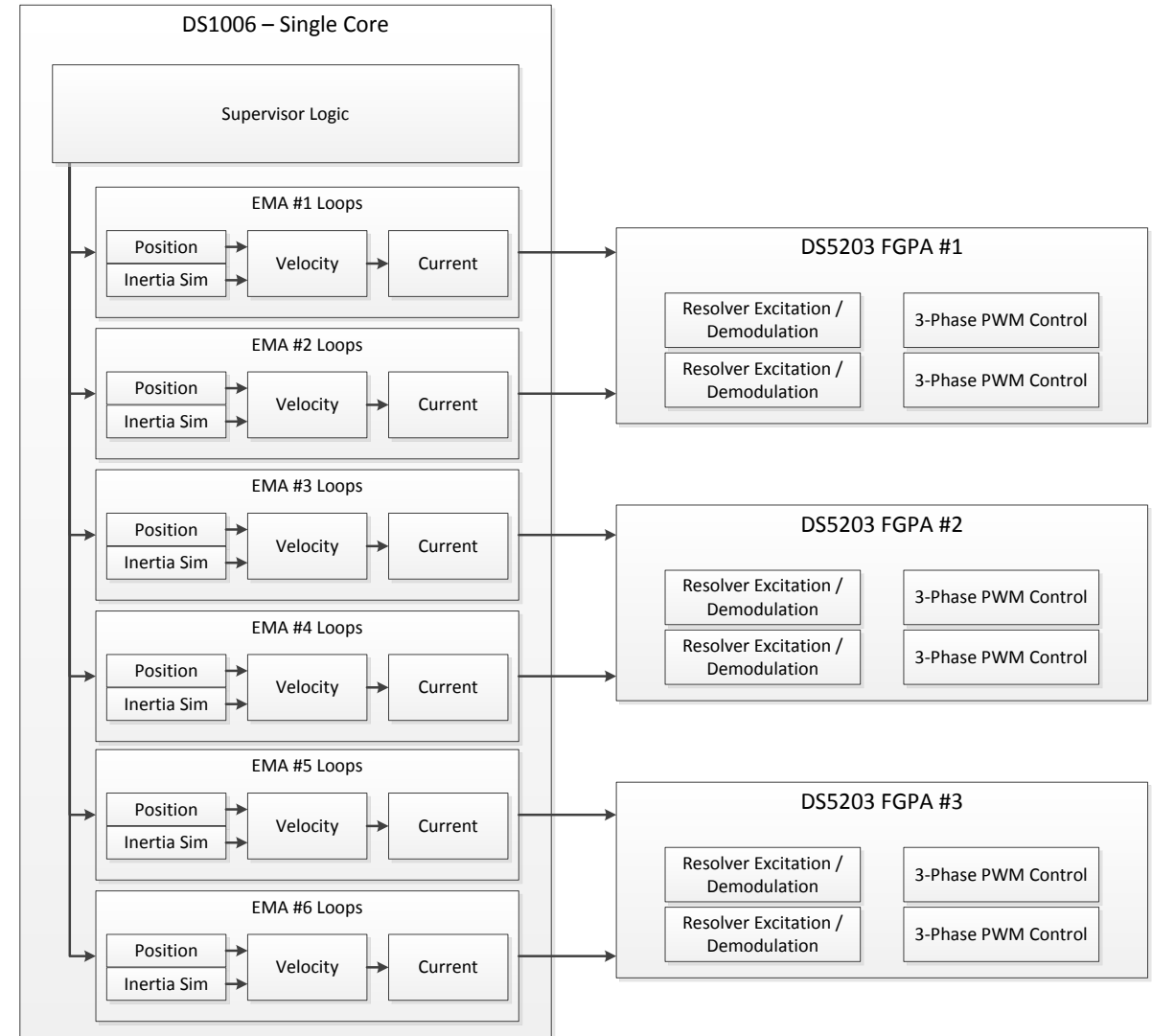

Multi-axis EMA Test Stand

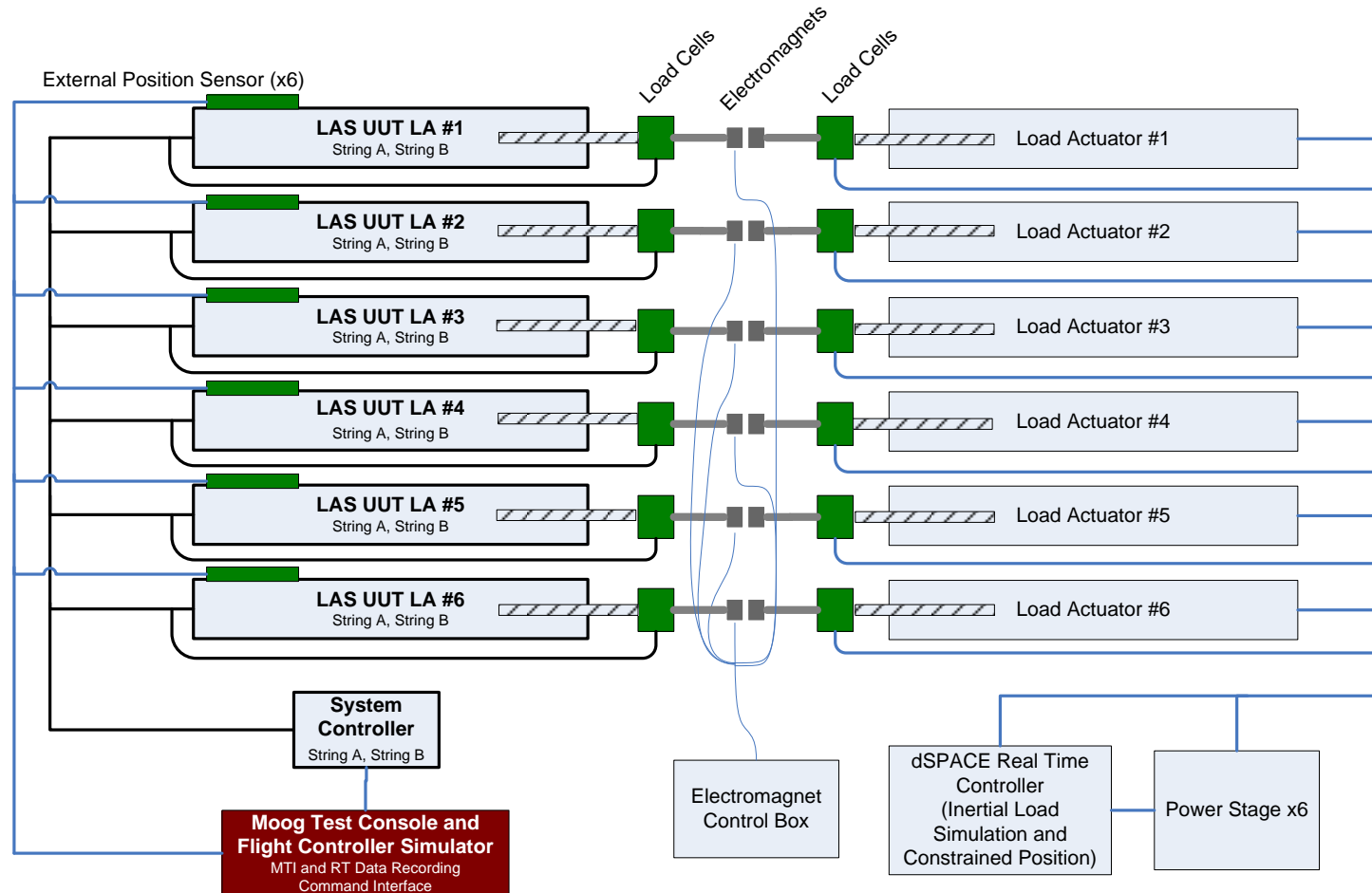

Six Axis Test Rig



Six Axis Test Rig



Docking System Testing



Summary & Future Work

- Flexible dSPACE testing hardware enabled rapid control development of docking actuation systems
- The testing platform enabled a development approach of build, test, update requirements, repeat
- The platform was expanded to multi axis control enabled system level verification
- Technology developed: EMA test equipment platform, system ID techniques, inertia simulator
- Future work
 - Utilize six-axis simulator to provide load control for flight system qualification testing
 - Expand inertia simulator technology to high power actuation system control
 - Develop high power EMA dSPACE power stage
 - Utilize FPGA platforms for VHDL V&V

Thank you!

Questions?