

Note for LaRC Reviewers

**This presentation is based on the tools
and models developed and
documented in NASA-TM-2014-218507.**

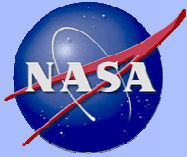

Earth Entry Vehicle Design for Sample Return Missions Using M-SAPE

Jamshid Samareh

NASA

IPPW-12 Jun 15-19, 2015

(See NASA-TM-2014-218507 for Details)

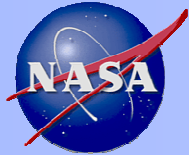

Multi-Mission System Analysis for Planetary EDL (M-SAPE)

M-SAPE Contributors

Abston, Howard (LaRC)	Gershman, Bob (JPL)	Prabhu, Dinesh (ARC)
Agrawal, Parul (ARC)	Glaab, Louis (LaRC)	Samareh, Jamshid (LaRC)
Aliaga, Jose (ARC)	Gumbert, Clyde (LaRC)	Sepka, Steve (ARC)
Allen, Gary (ARC)	Halom, Kimberly (LaRC)	Shidner, Jeremy (LaRC)
Armand, Sasan (LaRC)	Hardy, Robin (LaRC)	Siddens, Aaron (VT)
Arnold, Jim (ARC)	Hrinda, Glenn (LaRC)	Smith, Brandon (GT)
Bauer, Nikki (GT)	Johnston, Chris (LaRC)	Squire, Tom (ARC)
Bayandor, Javid (VT)	Liles, Charles (ODU)	Sturm, Erick (JPL)
Braun, Bobby (GT)	Lyons, Daniel (JPL)	Sutton, Ken (LaRC)
Cruz-Ayoroa, Juan (GT)	Maddock, Rob (LaRC)	Tanner, Chris (GT)
Driver, Dave (ARC)	Mangini, Nancy (ARC)	Theisinger, John (LaRC)
Dyakonov, Artem (LaRC)	Mattingly, Richard (JPL)	Venkatapathy, Raj (ARC)
Emmett, Anjie (LaRC)	Munk, Michelle (LaRC)	Winski, Rick (LaRC)
Empey, Dan (ARC)	Nilsen, Erik (JPL)	Zarchi, Kerry (ARC)
Fremaux, Mike (LaRC)	Perino, Scott (VT)	

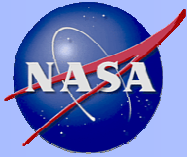

M-SAPE

(Summary)

- **What:** It is an integrated system analysis tool for analyzing and sizing of Earth entry vehicles for sample return mission applications.
- **Acronym:** Multi-Mission Earth Entry Vehicle System Analysis for Planetary EDL
- **Who:** LaRC, ARC, Virginia Tech, & Old Dominion University.
- **Disciplines:** Aero, aerothermal, flight mechanics, impact analysis, structure, thermal soak, TPS, ...
- **Funding:** The In-Space Propulsion Technology Program (ISPT) & ESM.
- **Status?** Version 1 is complete.
- **Future Plan:** Currently developing a similar system for human Mars mission.

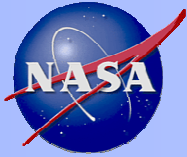

M-SAPE (Earth Entry Vehicle EDL Environment)

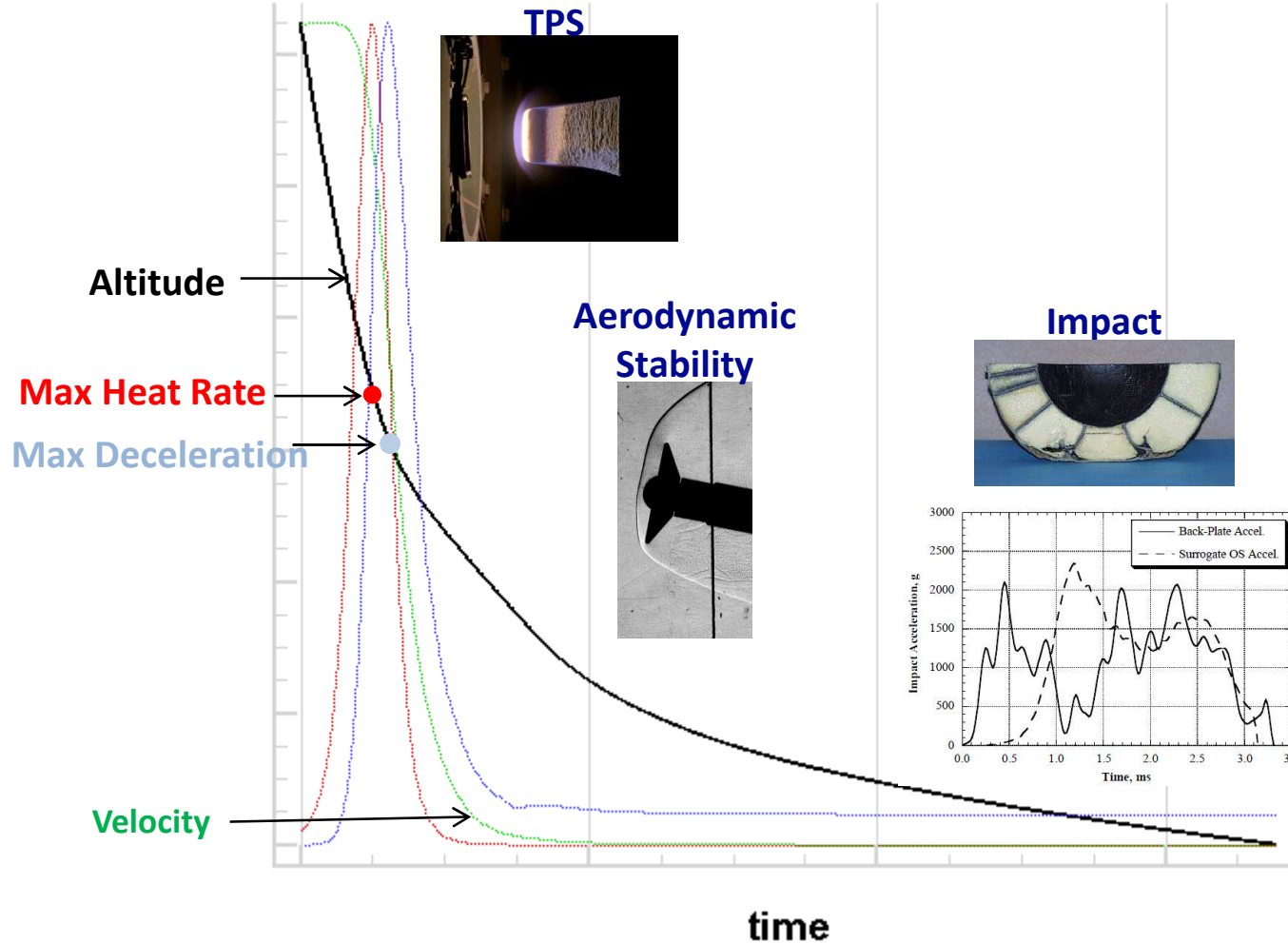
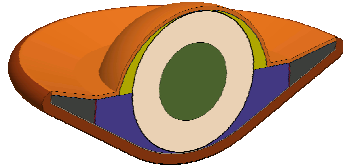

3 σ Landing Ellipse

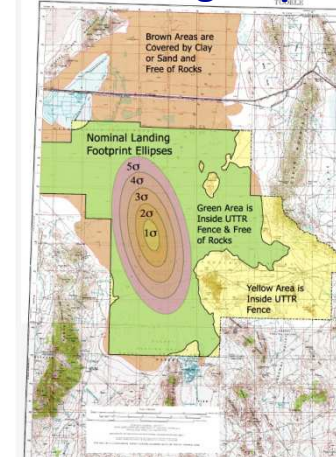

Thermal Soak

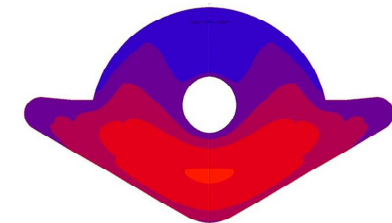

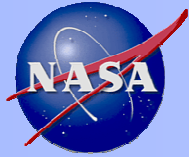

M-SAPE (Disciplines)

“The whole is greater than the sum of its parts.”

Design or Dependency Structure Matrix for MMEEV

	Database	Geometry Module	Mass Sizing & Packing	Flight Mechanics	Aerodynamics	Aerothermodynamics	TPS Sizing	Structural Analysis	Impact Analysis	Thermal Soak
Database	Database	Geometry Variables	Packing Arrangements	Entry Conditions						
Geometry Module	Geometry Parameters	Geometry	OML	OML	OML	OML	OML	OML	OML	OML
Mass Sizing	Overall Mass & Size	Overall Mass & Size	Mass Sizing & Packing	Mass				Mass	Mass	
Flight Mechanics	Flight Conditions			Flight Mechanics	Flight Conditions	Flight Conditions		Entry Loads	Terminal Velocity	
Aerodynamics	Aerodynamic Coefficients			Aerodynamic Coefficients	Aerodynamics			Aerodynamic Loads		
Aerothermodynamics	Thermal Constraints			Thermal Constraints		Aerothermodynamics	Thermal Environment		Thermal Environment	Thermal Environment
TPS Sizing	TPS Mass		TPS Mass				TPS Sizing	Bondline Conditions	Bondline Conditions	TPS Interface Condition
Structural Analysis	Structural Mass		Structural Mass		Aeroelastic Displacements			Structural Analysis		
Impact Analysis	Energy Absorber Stroke	Energy Absorber Stroke	Energy Absorber Mass						Impact Analysis	Impact Displacements
Thermal Soak	Thermal Soak Constraints							Temperature Field	Temperature Field	Thermal Soak
Approach	Flat Files & SQL	Scripts & CAD	Scripts & CAD	3DOF	Experimental Data & CFD	SG, TS, & DPLR/LAURA	FIAT	Eng. Approx. & NASTRAN	Eng. Approx. & LS-DYNA	Marc 2D-Axisymmetric

Columns are inputs, and Rows are outputs

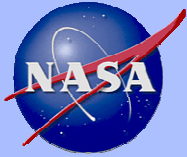

M-SAPE

(Integration, UML Sequence Diagram)

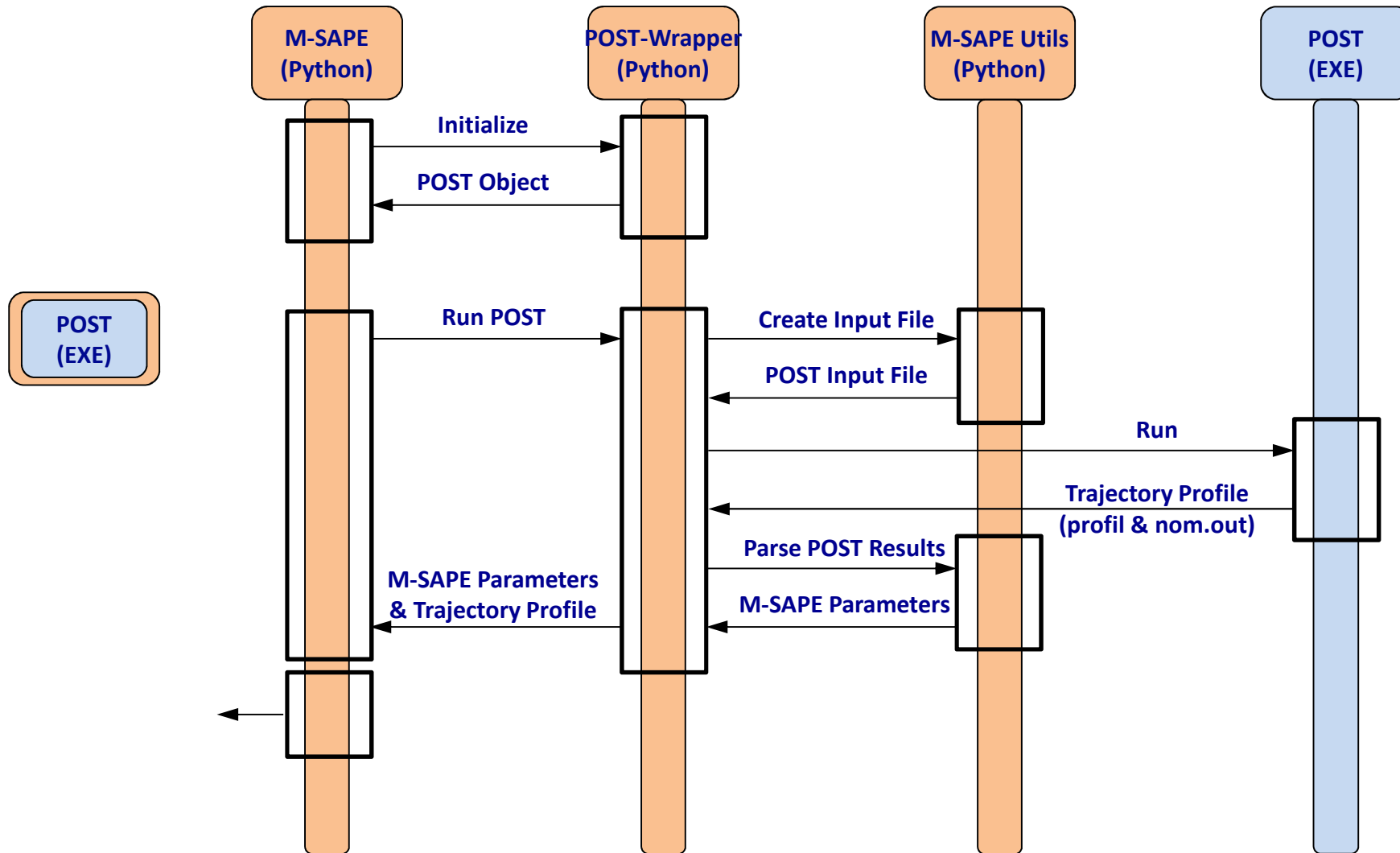

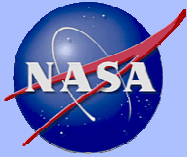

M-SAPE

(Integration, Mission Dependent)

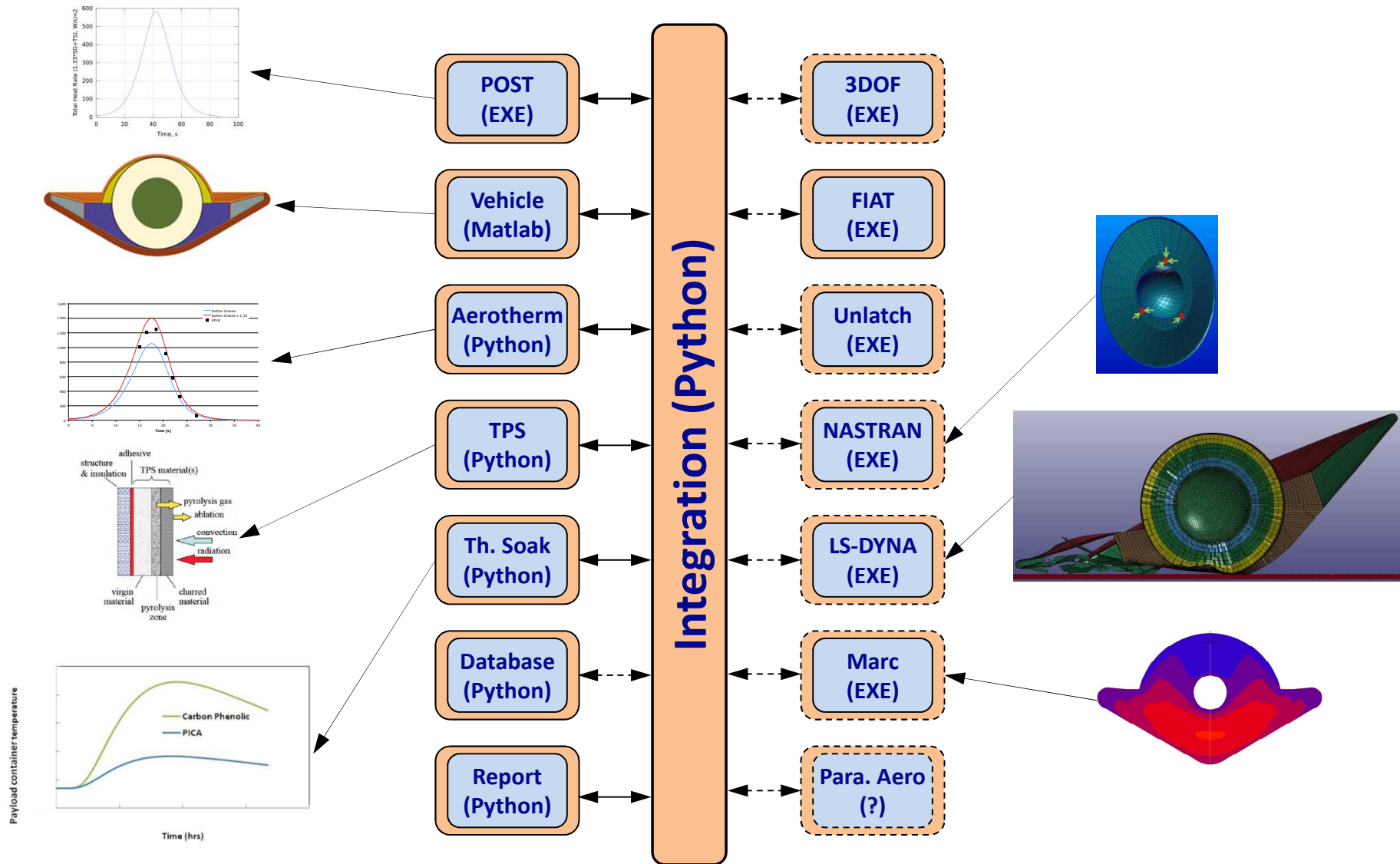

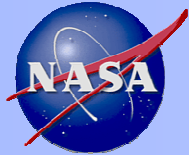

M-SAPE

(Sample Result Baseball Card)

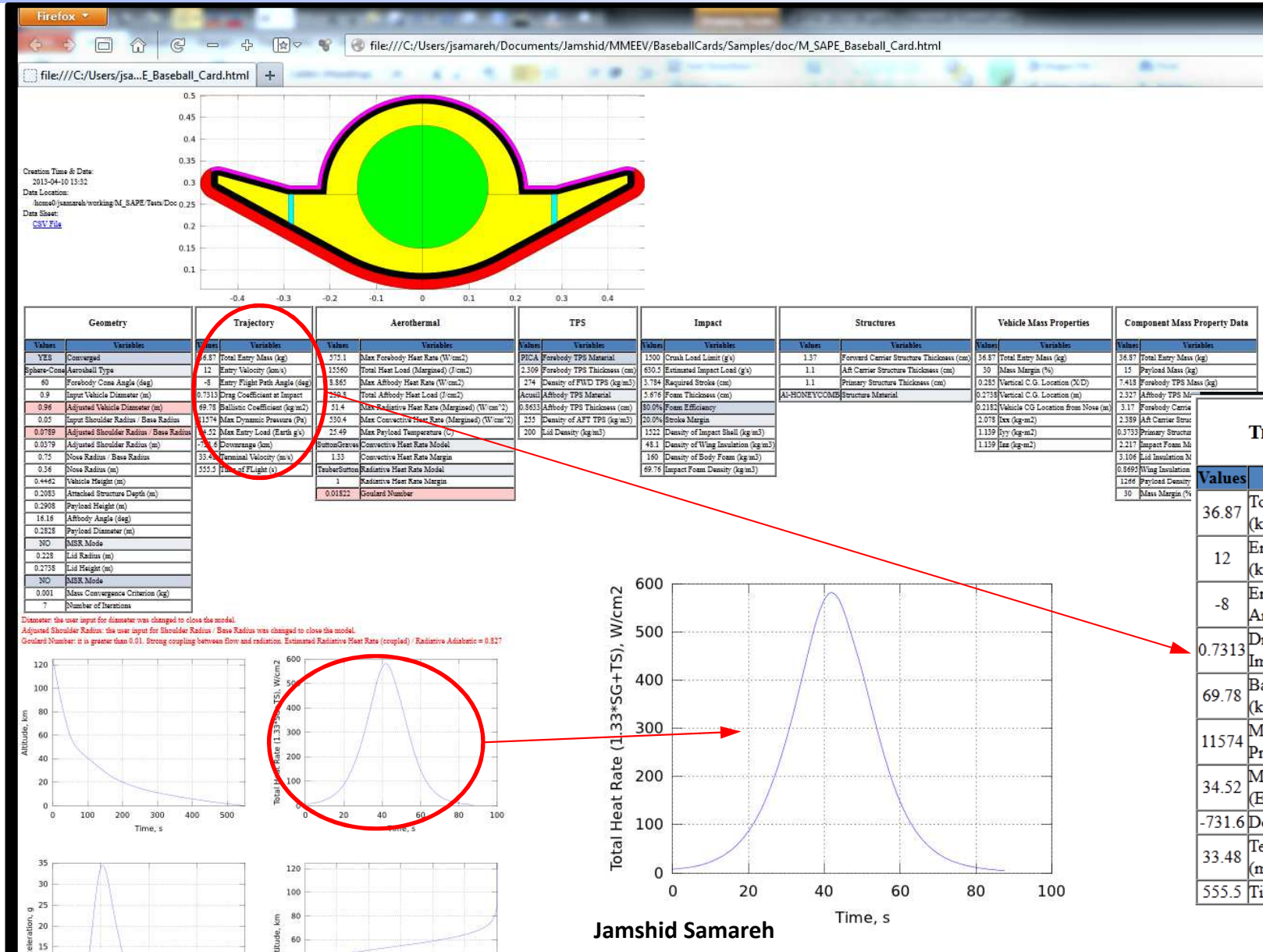

Jamshid Samareh

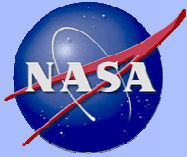

M-SAPE (Web Portal)

Langley Firewall

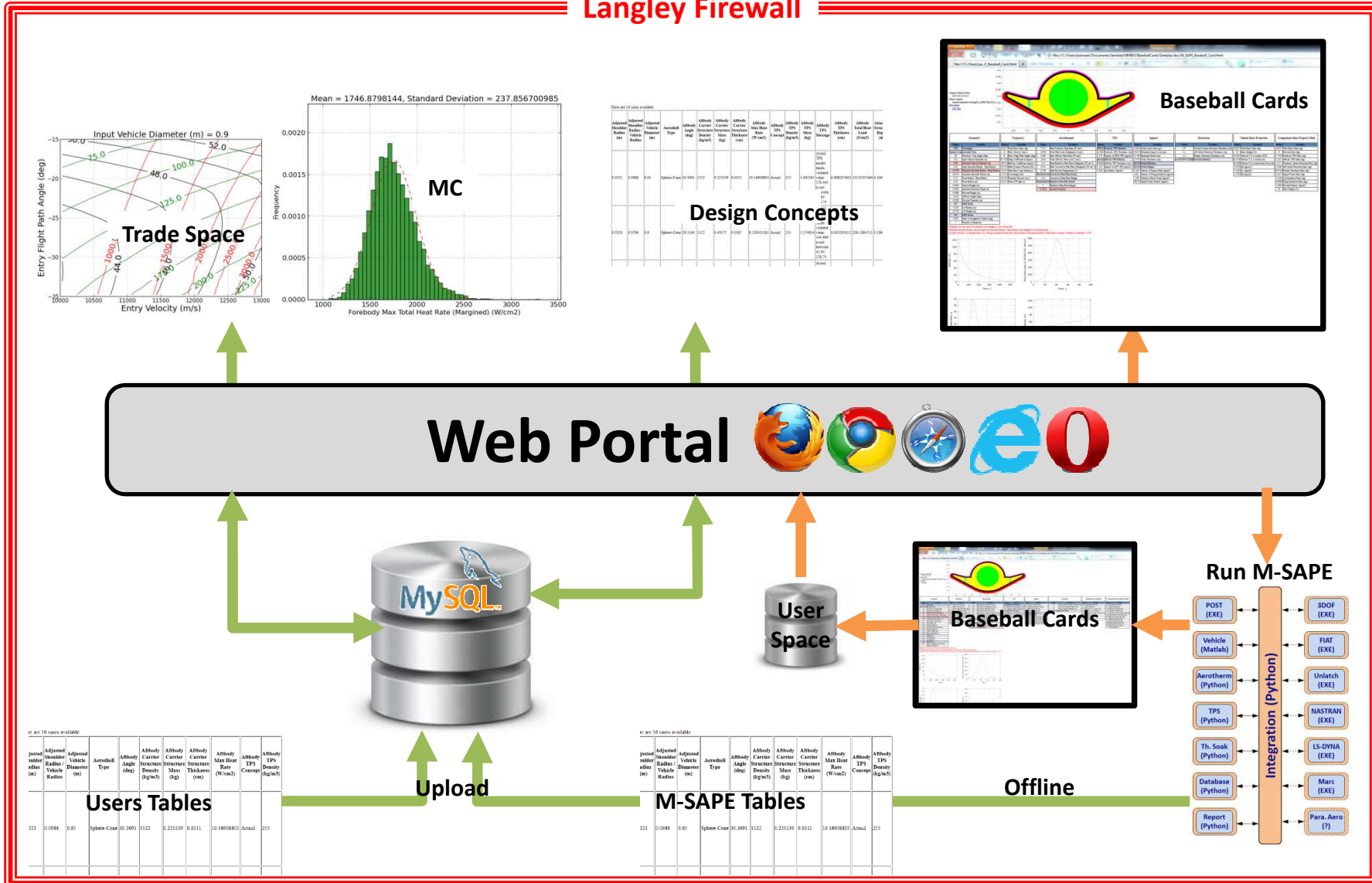

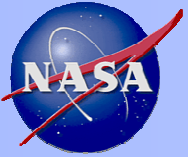

Vehicle Geometry

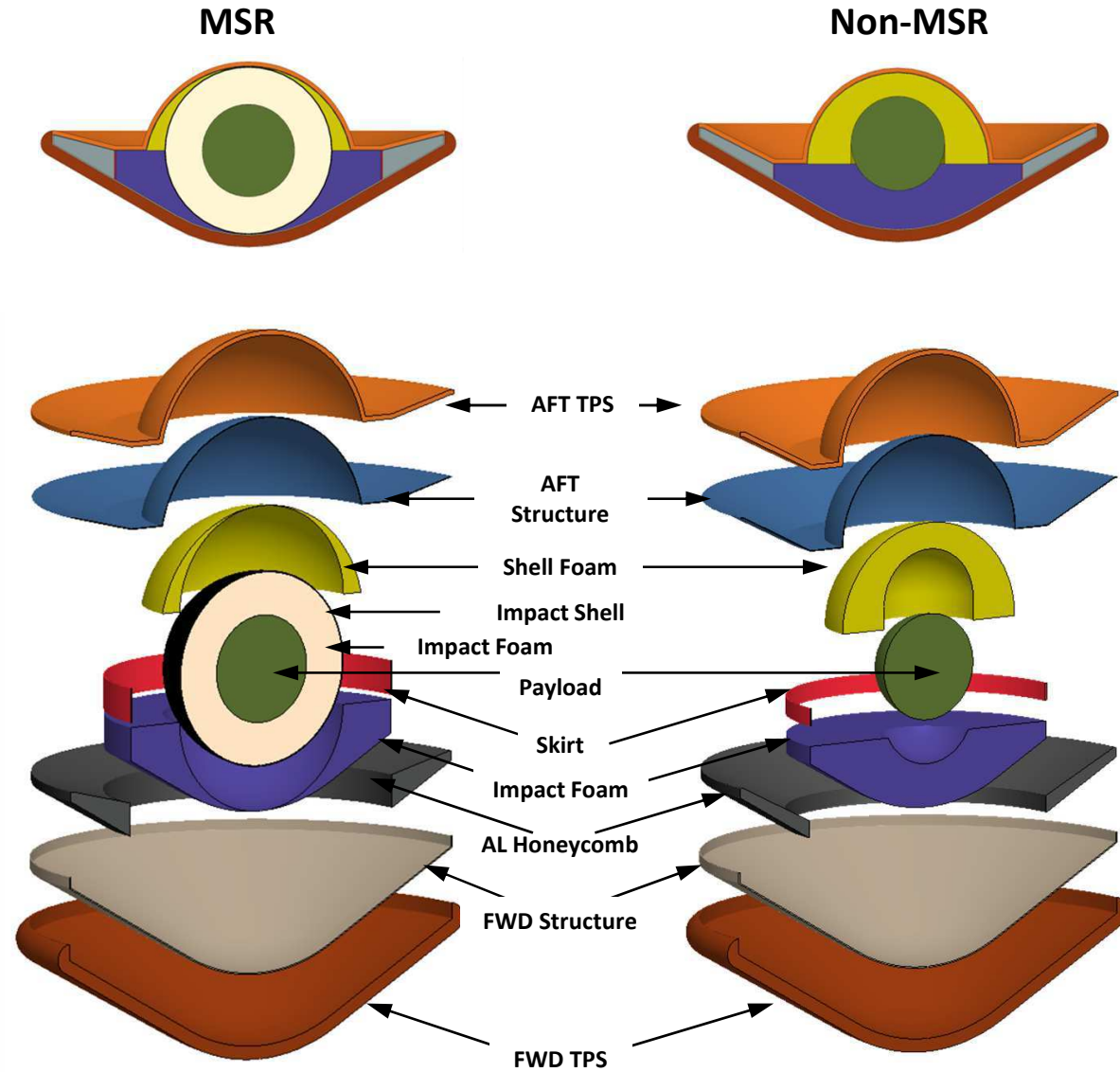

Jamshid Samareh

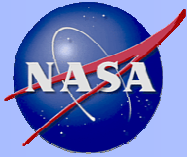

Vehicle Sensitivities (Sample Baseline Model)

Parameters	Values
Crush Load Limit (Earth g's)	3000
Entry Flight Path Angle (deg)	-25
Entry Velocity (m/s)	11000
Payload Diameter (m)	0.3
Payload Mass (kg)	6
Forebody TPS Concept	PICA
Input Vehicle Diameter (m)	1

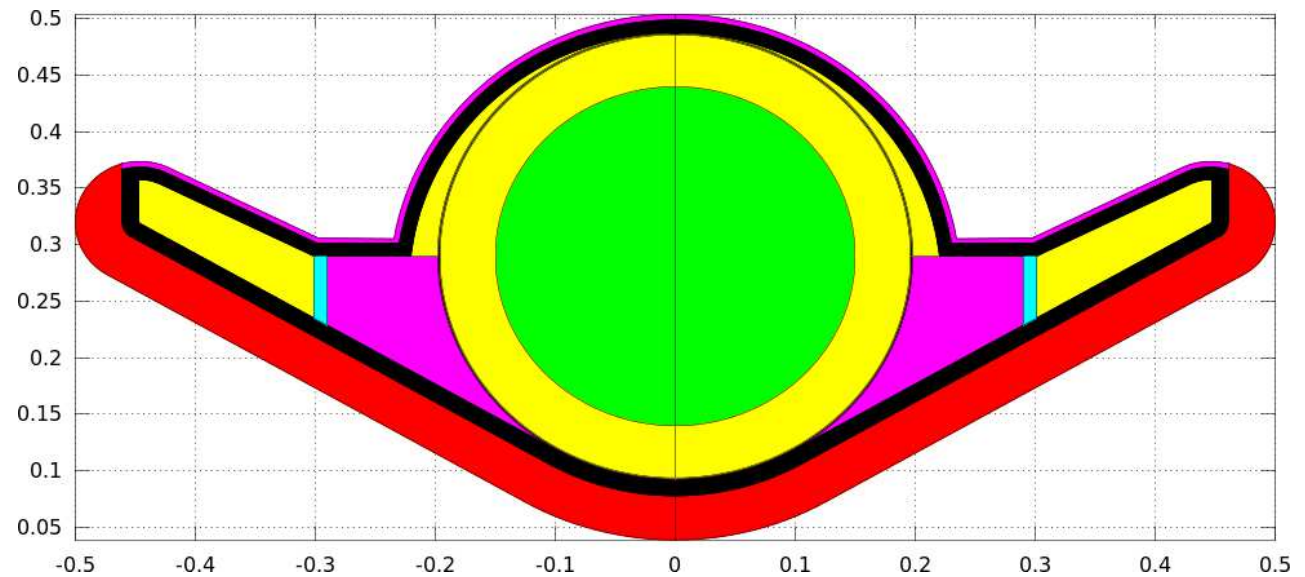

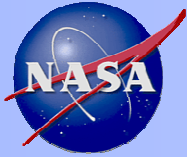

Vehicle Sensitivities (Sample Baseline Model)

Velocity-Altitude-Mach Number

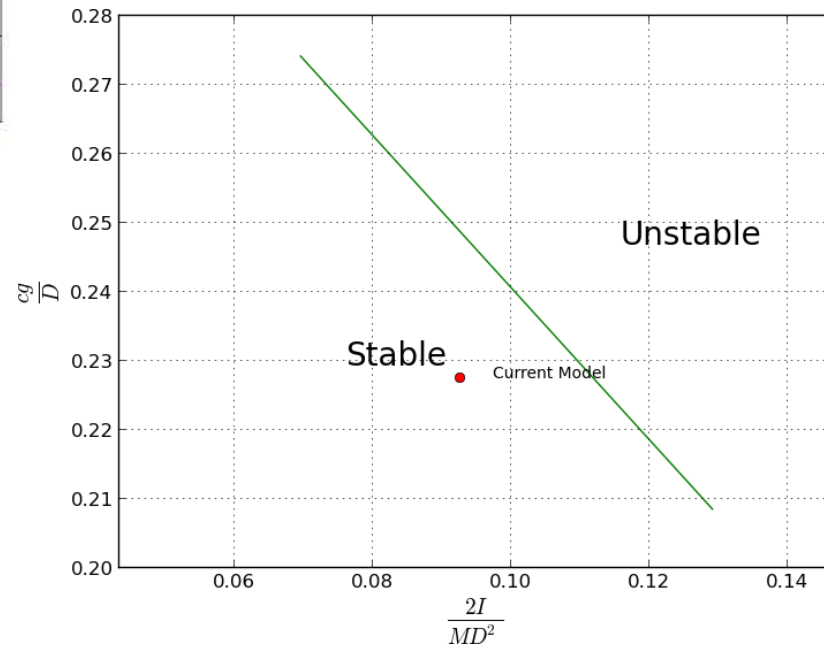
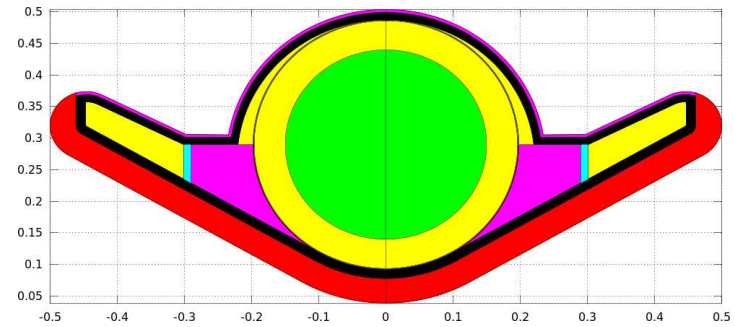
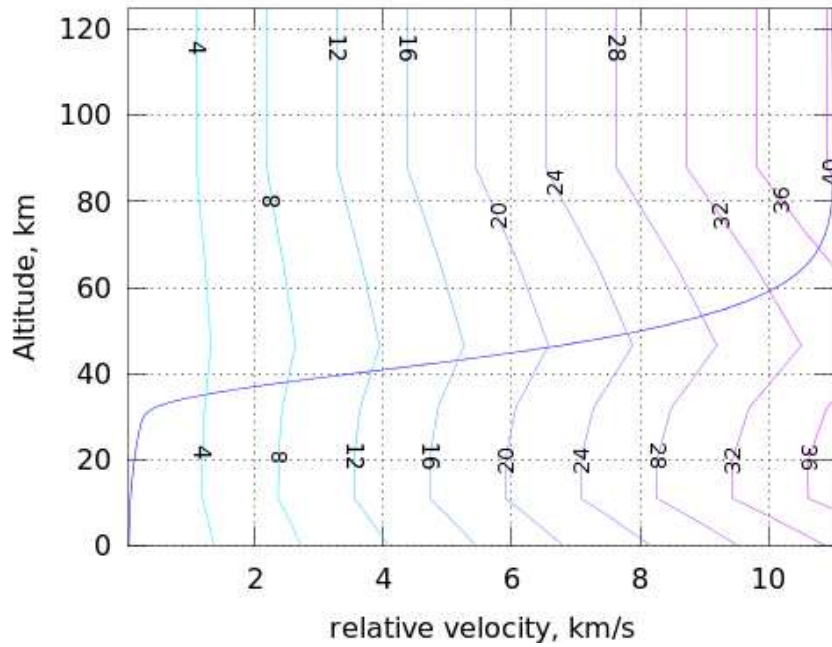

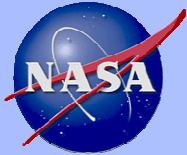

Vehicle Sensitivities (Cont.)

Case Name	D-1.0-B	CP	ΔDiameter		ΔCrush Load		ΔFlight Path Angle		ΔPayload Diameter		ΔPayload Mass		ΔEntry Velocity	
Vehicle Diameter (m)	1	1.08	0.9	1.1	1	1	1	1	1	1	1	1	1	1
Crush Load Limit (Earth k g's)	3	3	3	3	2.5	3.5	3	3	3	3	3	3	3	3
Entry FPA (deg)	-25	-25	-25	-25	-25	-25	-20	-30	-25	-25	-25	-25	-25	-25
Payload Diameter (m)	0.3	0.3	0.3	0.3	0.3	0.3	0.3	0.3	0.25	0.35	0.3	0.3	0.3	0.3
Payload Mass (kg)	6	6	6	6	6	6	6	6	6	6	5	7	6	6
Entry Velocity (km/s)	11	11	11	11	11	11	11	11	11	11	11	11	10.5	11.5
Aerodynamic Stability	Yes	Yes	No	Yes	Yes	Yes	Yes	Yes	Yes	No	Yes	Yes	Yes	Yes
Max Heat Rate (W/cm ²)	918	1452	1027	840	944	903	826	995	879	972	901	934	776	1107
Forebody TPS Mass (kg)	13.9	64.0	11.5	16.5	14.0	13.8	14.3	13.6	13.8	14.1	13.8	13.9	13.8	14.0
Total Heat Load (kJ/cm ²)	7.6	12.5	8.5	6.9	7.8	7.5	8.4	7.0	7.2	8.1	7.4	7.7	6.8	8.5
Max Payload Temp. (C)	18	45	17	18	18	18	18	17	18	18	18	18	18	18
Total Entry Mass (kg)	36.5	108.6	33.6	40.6	38.6	35.4	37.0	36.2	33.6	40.9	35.2	37.8	36.4	36.6
ΔMass% / ΔP%		3		0.95		-0.27		-0.06		0.60		0.21		0.05

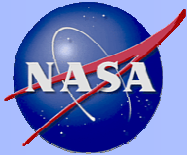

Vehicle Sensitivities (Cont.)

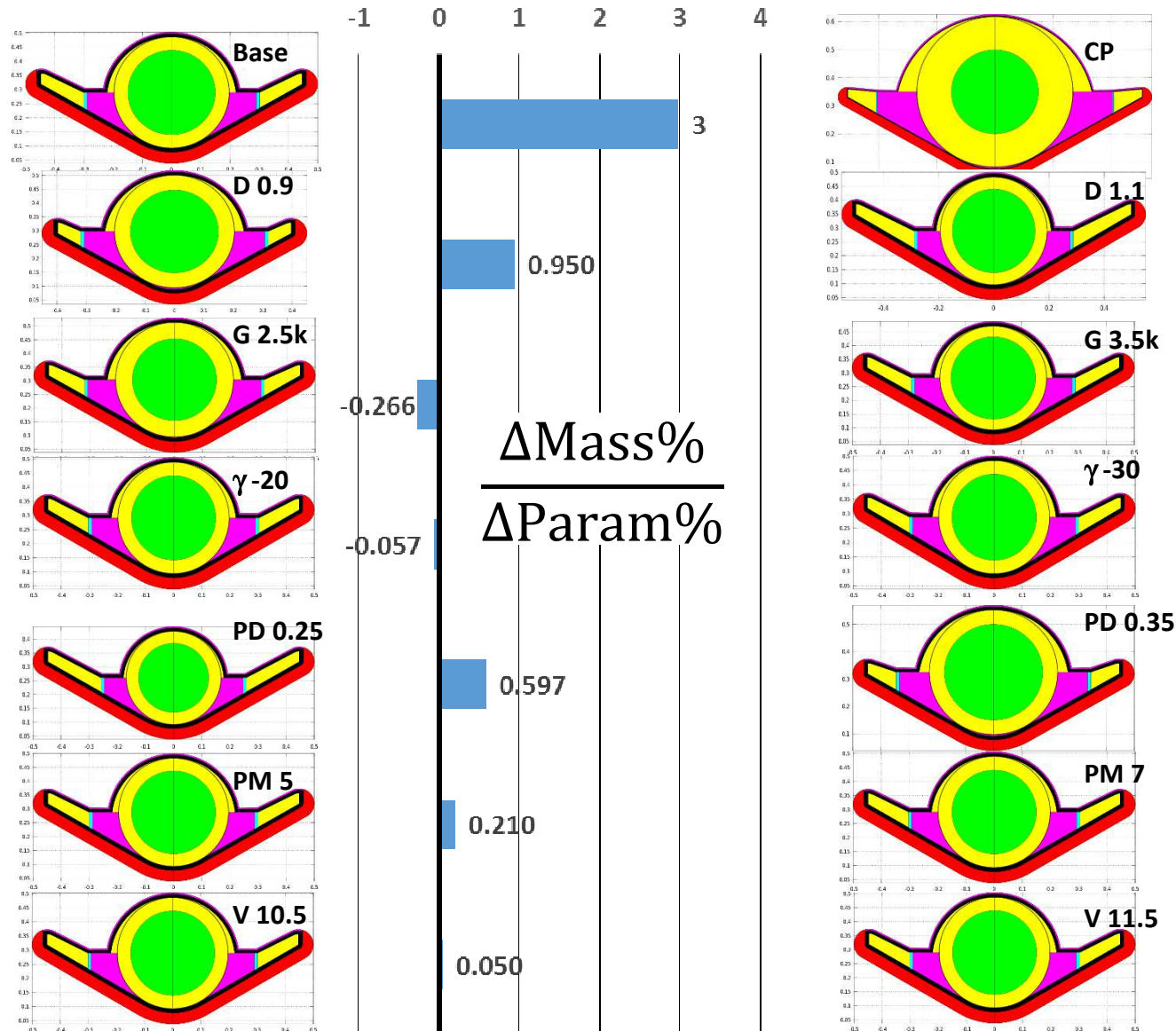

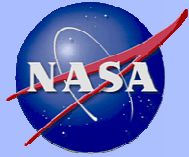

Concluding Remarks

- **The current version of M-SAPE was used to perform system analysis and sensitivity analysis of an Earth entry vehicle for sample return missions.**
- **For the sample baseline design:**
 - Selection of TPS concept has the most impact on the design.
 - Vehicle size may be dictated by the required aerodynamic stability.
 - Higher payload diameter and mass result in heavier vehicles.
 - Lower impact g-load would result in heavier vehicles.
 - Entry flight path angle and velocity have less impact on mass compared to other parameters.