



Preliminary Results from a Heavily Instrumented Engine Ice Crystal Icing Test in a Ground Based Altitude Test Facility

Ashlie B. Flegel
Michael J. Oliver
NASA Glenn Research Center

AIAA Aviation
Atmospheric and Space Environments Conference
June 13-17, 2016

Motivation

Engine Ice Crystal Icing events have led to increased need of understanding the mechanisms of engine icing.

NASA Advanced Air Transport Technology (AATT) Project key technology area is to develop engineering model and icing risk assessment tools and improve understanding of the physics of ice crystal icing through fundamental and engine testing.

- Enable analysis of ice crystal icing effects on turbofan engines.
- Provide guidance for safe operation of current and future N+2/N+3 propulsion systems.

Propulsion Systems Laboratory is developing its engine icing capability to ensure PSL can simulate high ice water content cloud conditions experienced in nature to the degree required to simulate engine failure modes by FY20.

- Understand the differences between PSL Cloud and natural environment ingested in the engine.
- Instrumentation to measure IC Cloud upstream and inside test hardware flow path.
- Characterize PSL Cloud
- Standardize PSL Icing Test Methodology

LF11 Test Approach and Objectives

- Document ice accretion in a full scale engine at altitude conditions.
- Develop advanced instrumentation to characterize the cloud entering the core flowpath and measure accretion characteristics.
- Replicate full rollback from LF01 Honeywell flight test and PSL tests.
- Duplicate key test points from the LF01 test plan in order to document and characterize the flow path, engine performance, and ice that builds up leading to the loss of thrust events.
- Further develop test methodologies and capability of PSL-3 facility.
- Simulate high and low altitude ice crystal cloud environments as well as specific aircraft/engine operating profiles.
- Investigate sensitivities of ice build up to various engine and facility parameters.

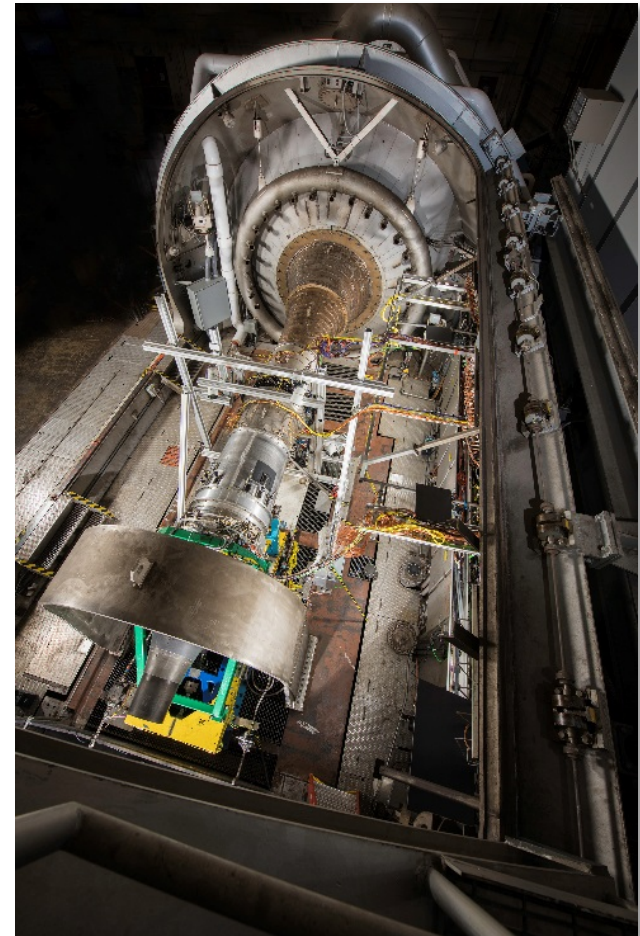

Propulsion Systems Laboratory (PSL)

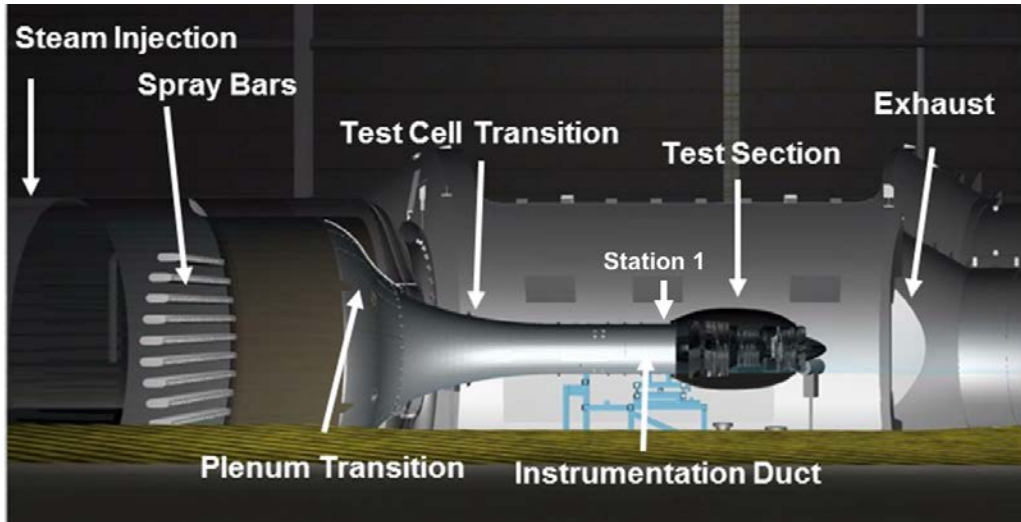

Specification	Min	Max
Engine / Rig Dia. (in cm)	24 60	72 180
Air Flow Rate (lbm/s kg/s)	10 5	330 150
Altitude, pressure (kft km)	4 1.2	50 15
Total Temp (°F °C)	-60 -50	50 10
Mach Number	0.15	0.80
TWC (g/m ³)	0.5	8.0 *
MVD (um)	15	>100 #

* Evidence that probe under-measured

Particles larger than ~ 90 microns are NOT fully glaciated

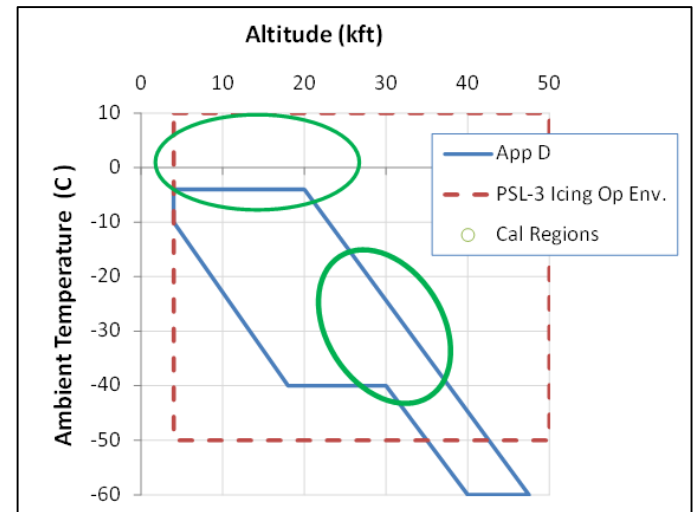

PSL-3 Icing Operating Envelope

Test Article: ALF502-R5 Engine

From 1988 through 1997 the Lycoming ALF502-R5 experienced 12 rollback field events.

Root Cause Investigation Conducted

- Computer models, alt. chamber rig tests, and flight test.
- Rollback event duplicated in flight test
- Investigation found ice accretion on the EGVs the cause of the rollback incidents



Engine Details

Parameter	Value
Bypass Ratio	5.7:1
Fan Diameter	40.25 in
Engine Length	64 in
Maximum Thrust	6970 lbf
Fan (# of stages)	1
Booster (# of stages)	1
Axial Compressor (# of stages)	7
Centrifugal HPC (# of stages)	2
High Pressure Turbine (# of stages)	2
Low Pressure Turbine (# of stages)	2

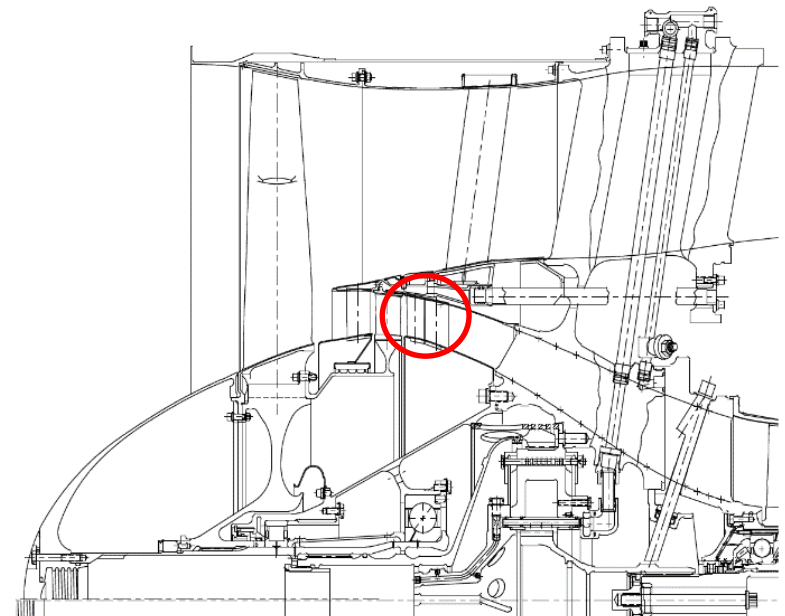

Source: Goodwin, R.V., Dischinger, D. G.,
AIAA Atmospheric and Space Environments
Conference, AIAA-2014-2895

Instrumentation

- Engine Instrumentation (total and static pressures and thermocouples):
 - Bypass Stator and Strut
 - IGV and EGV
 - Core Strut
- Capture HPC Response to ice shedding:
 - Kulites
- Facility Instrumentation:
 - Inlet total pressure
 - Inlet total temperature
 - Humidity sensors
 - Eight external cameras observing the plenum and inlet of the test section

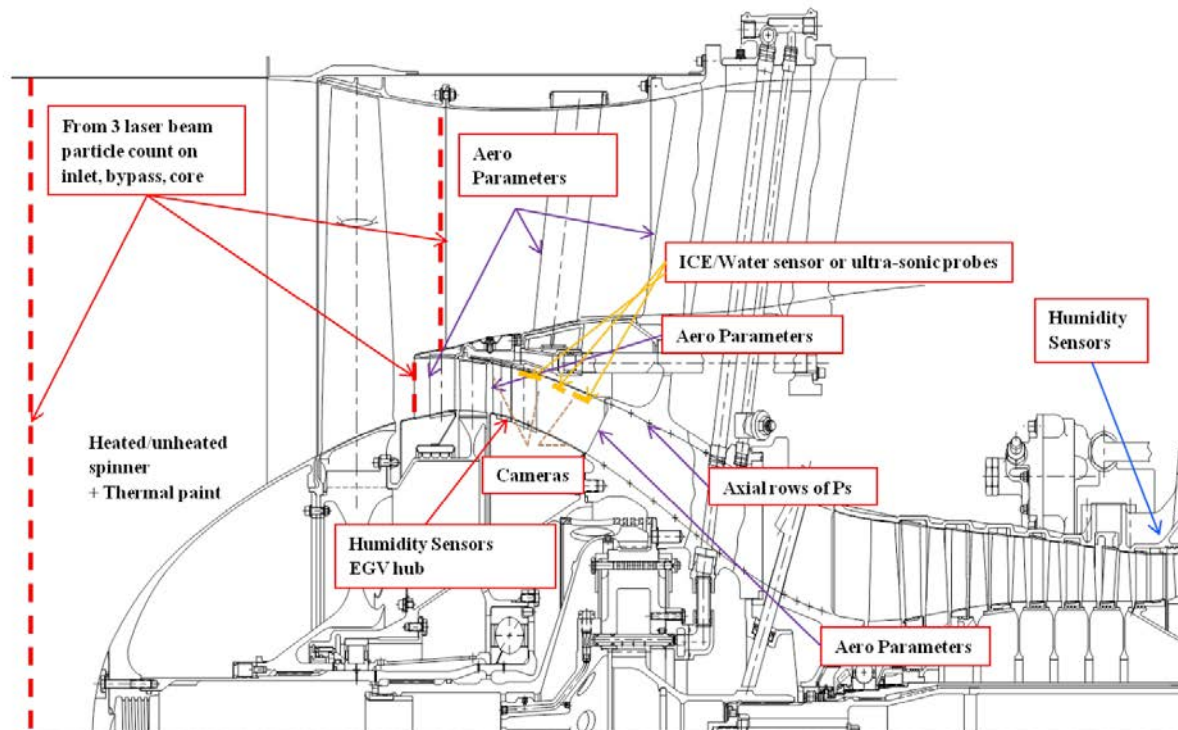

Instrumentation

- Detect and Characterize Ice:
 - Four internal engine cameras
 - NASA Ice/water sensor
 - NRC Ultrasound Ice Accretion sensor
 - Surface temperature thermocouples
 - Humidity sensors
 - Tomography (inlet)
 - Light Extinction Probes

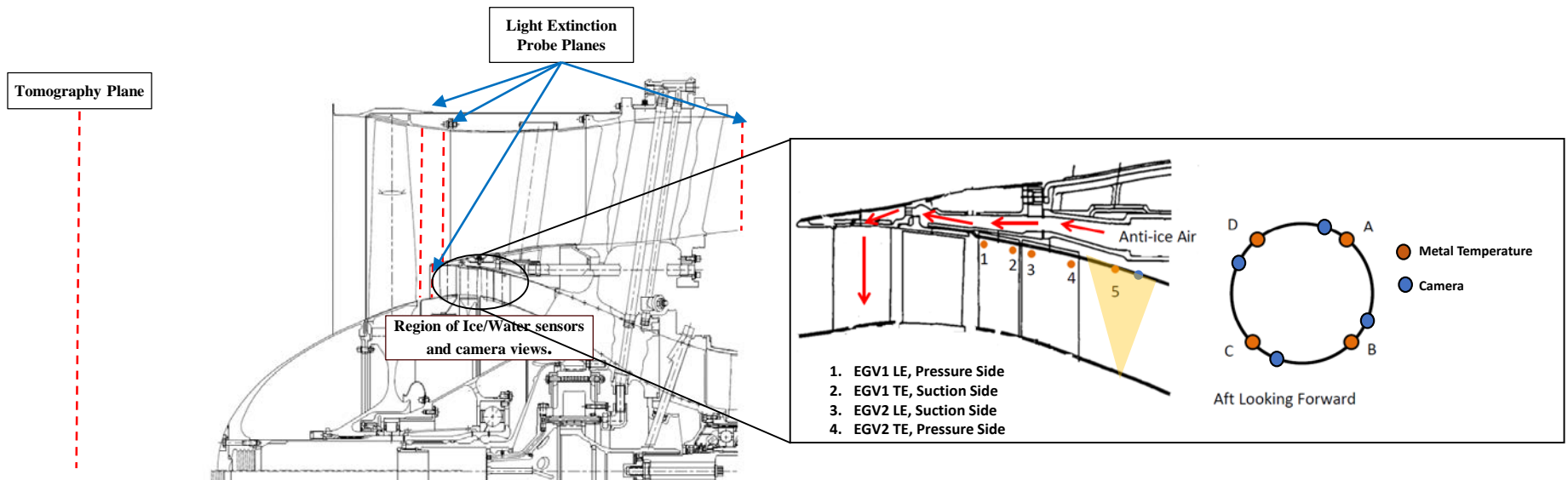

Sample Test Conditions

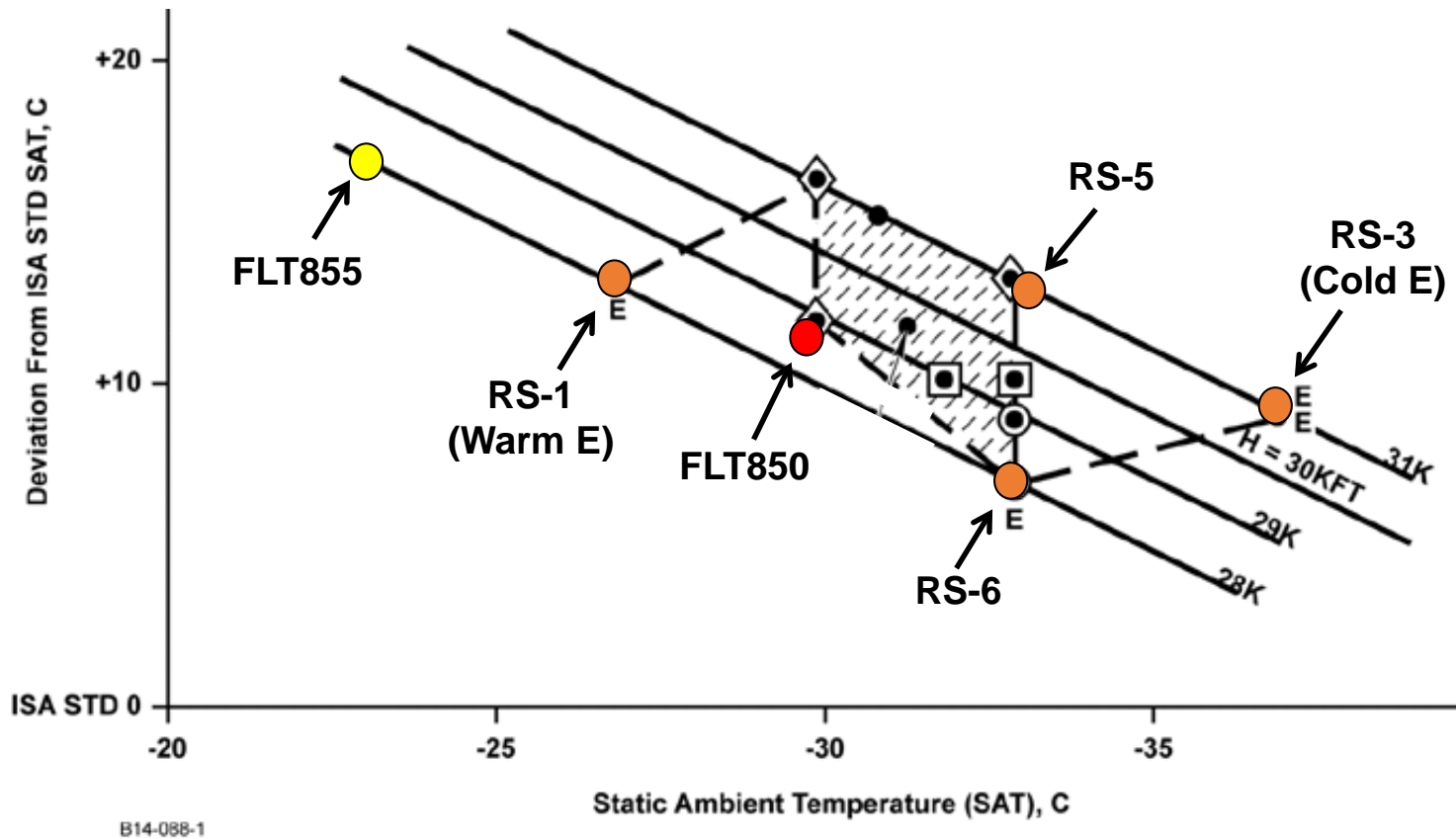

- Research Altitude Points not shown
- Sweeps of TWC, MVD, N1, and ambient temperature were conducted for each condition tested.

Results

Repeatability of Similar Engines

- FLT850 Full Rollback Condition

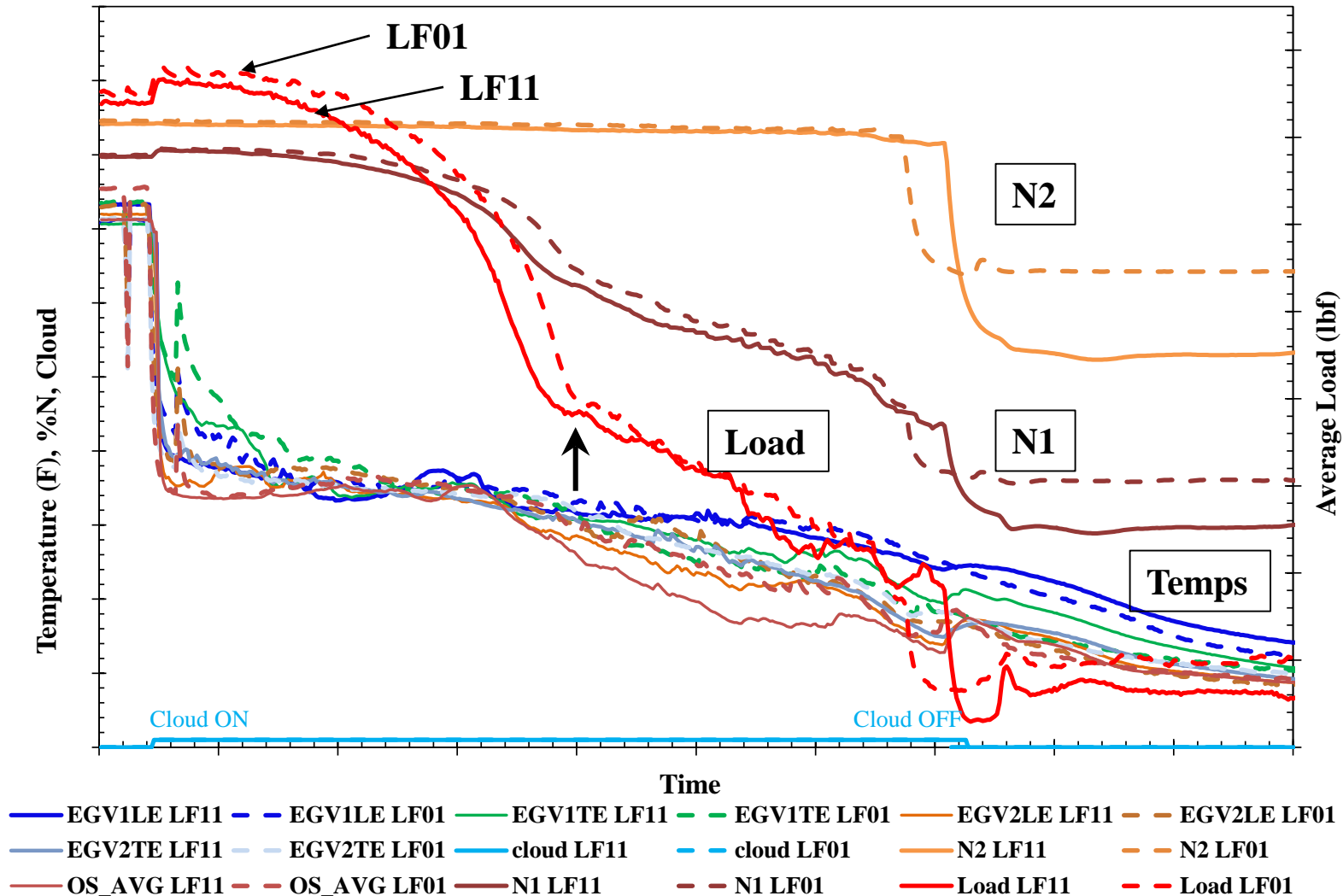

Daily Engine Repeatability

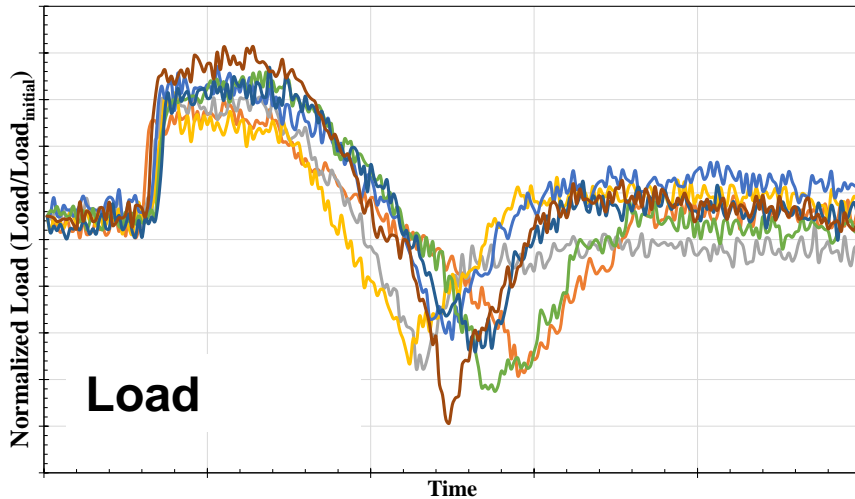
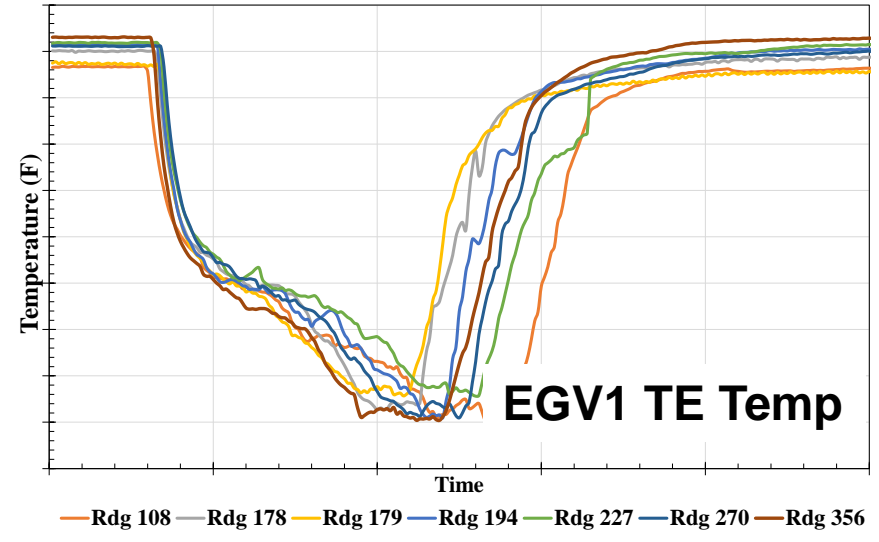
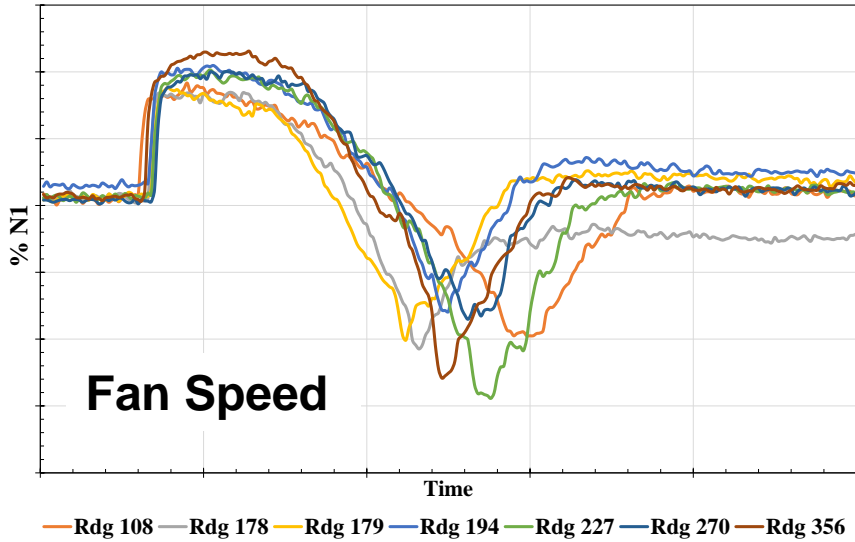

- FLT850 Anchor Point
- Run nearly every test day
- Performance degradation observed throughout the test

Effects of Icing

Effects of Icing: Metal Temperatures

- Average Metal temperatures in five axial locations
- FLT850 called rollback condition
- Water Run back observed, leads to strong evaporative cooling in outer shroud metal temperatures
- Leading edges of the EGVs are cooled due to ice/water impingement

FLT850 Called Rollback Condition

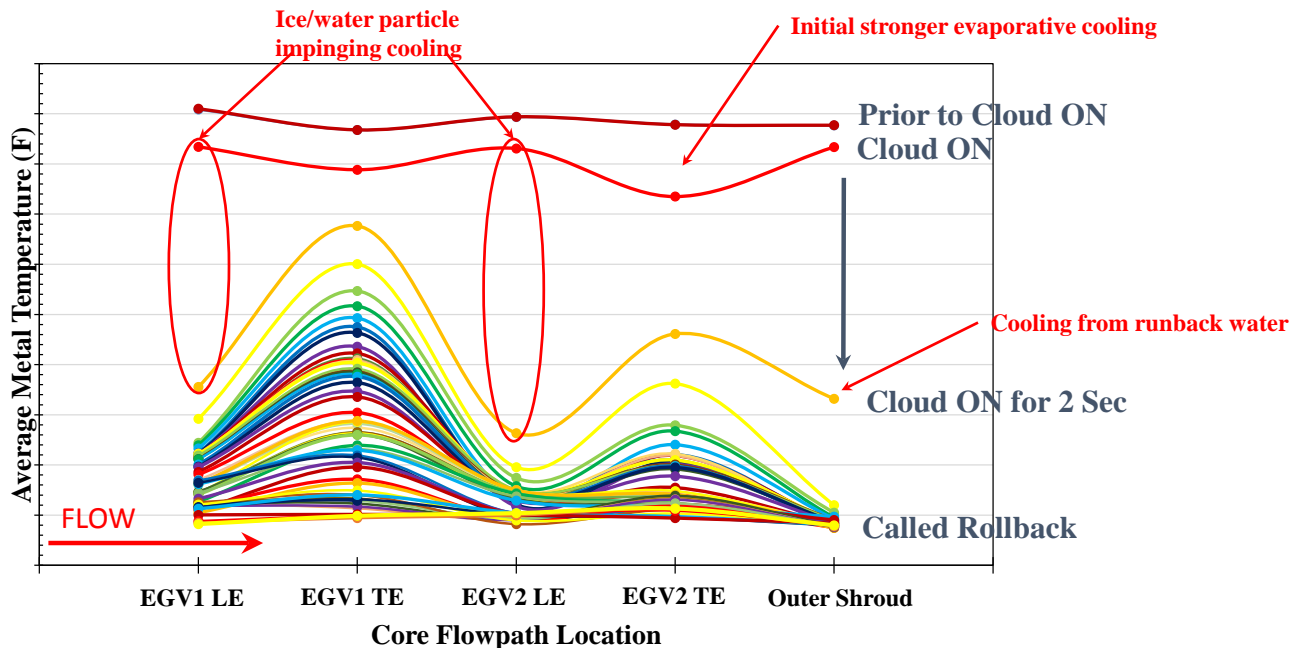

Water Runback



Effects of Icing: Metal Temperatures

- Average Metal temperatures in five axial locations
- FLT850 non-rollback conditions
- Similar axial temperature behavior is observed from the CRB condition
- Temperatures do not decrease as much and reach similar temperatures
- Ice and water observed for the non-rollback condition

FLT850 Non-Rollback Condition (+5% N1)

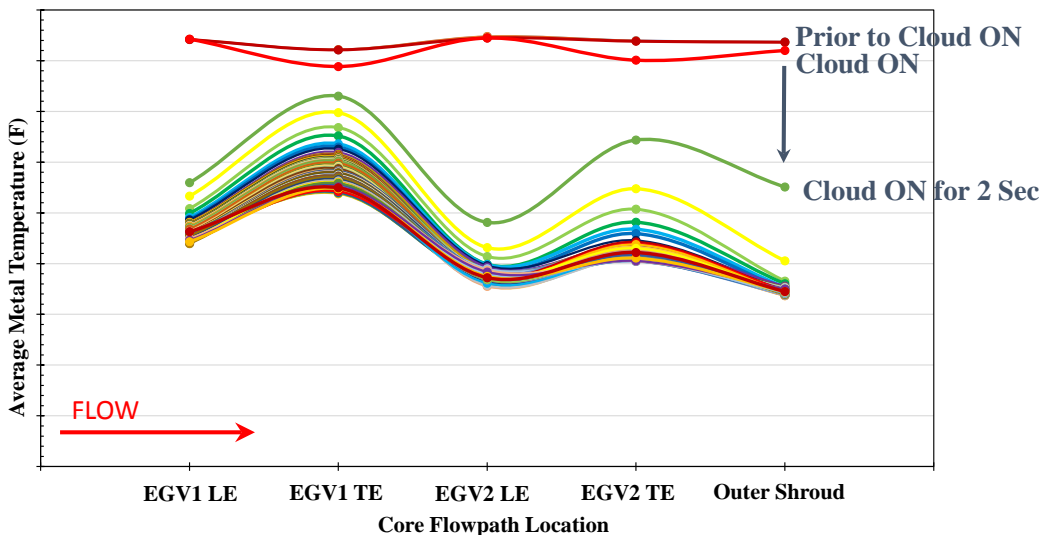

Facility Response Due to Rollback

- FLT850 “Fast” Rollback Condition

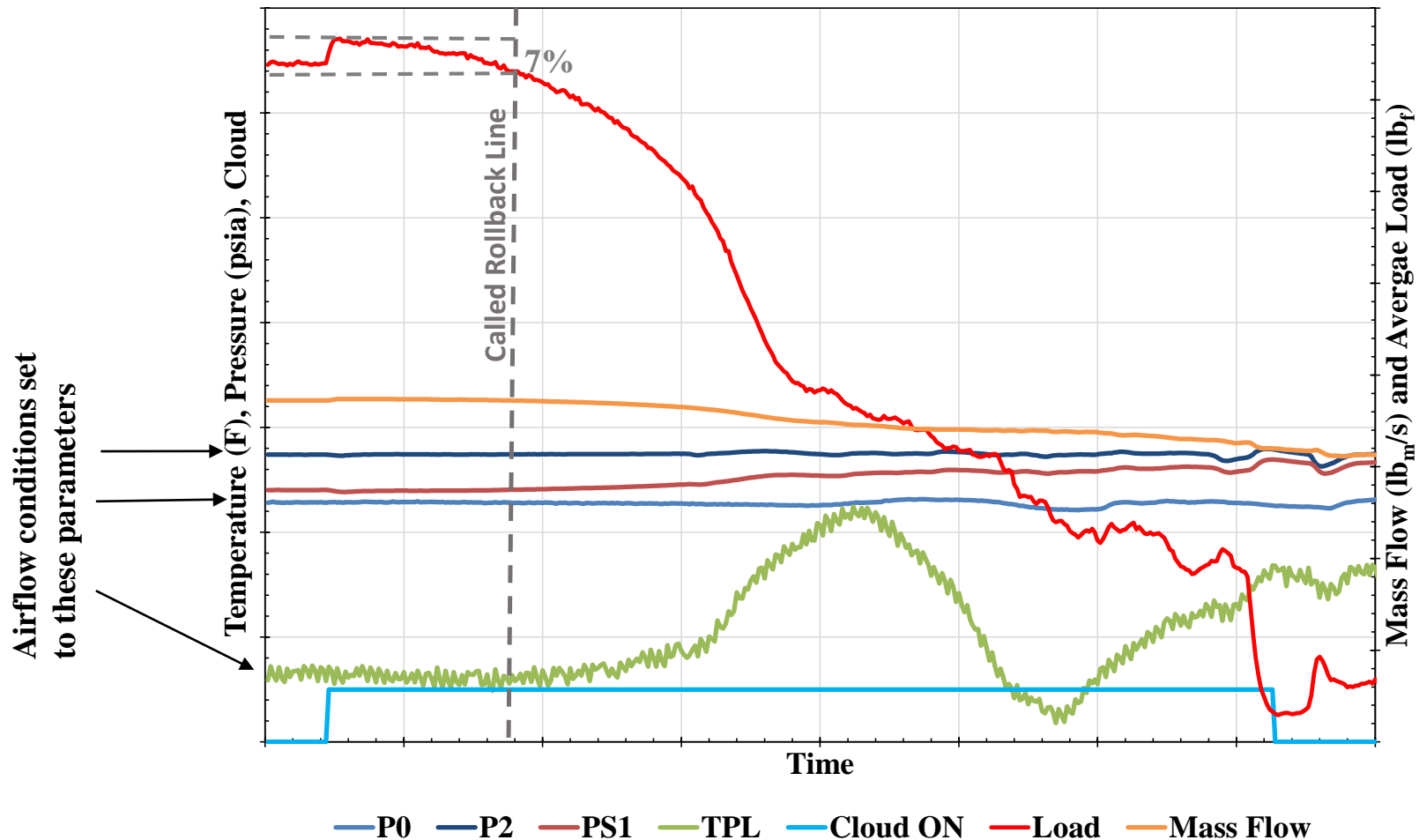

Influences on Rollback

Influences on Rollback: TWC Effects

- 60 second sweeps at six TWC conditions.
- TWC based on bulk calculations

FLT850 Run TWC Comparisions

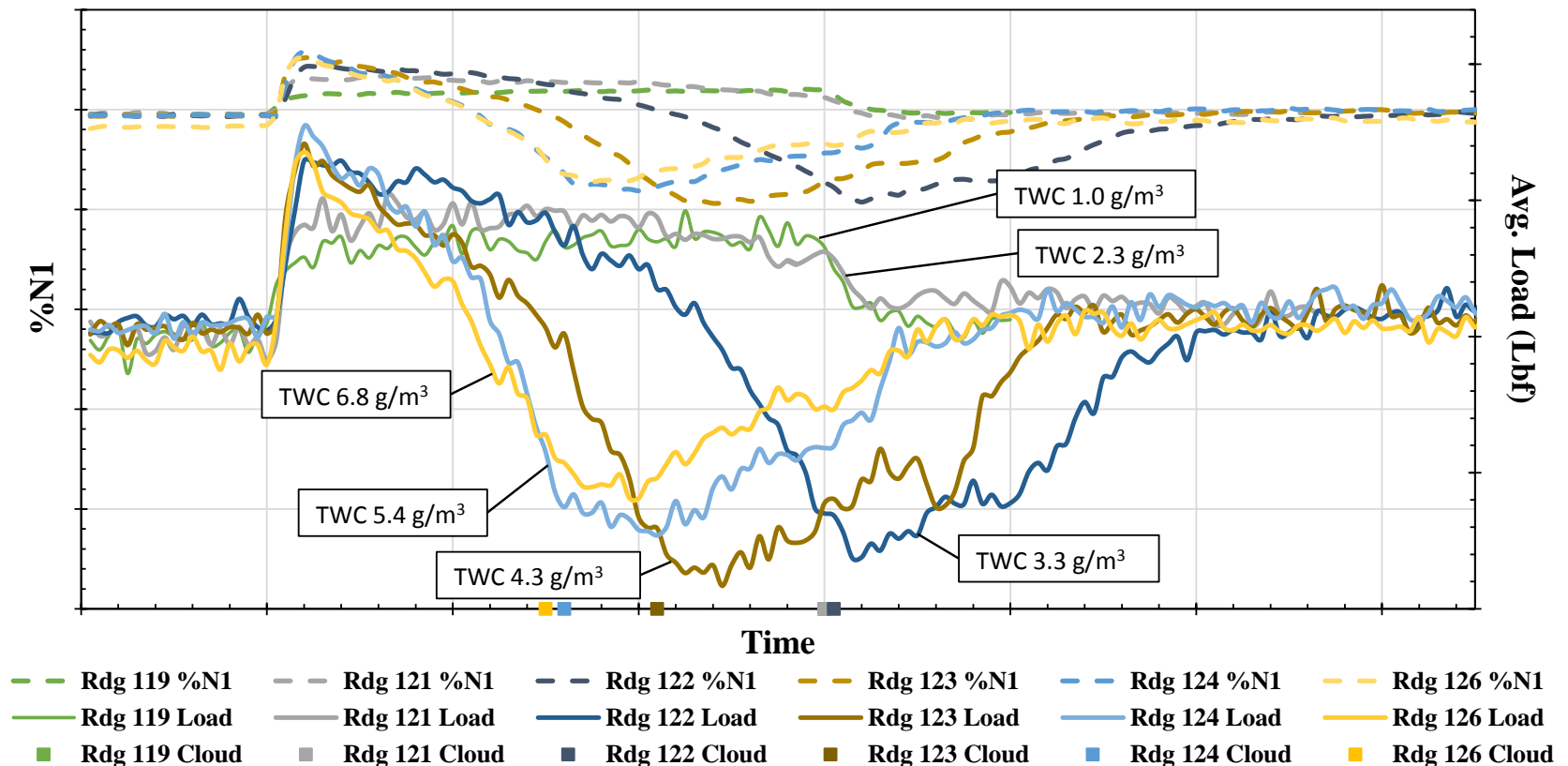

Influences on Rollback: MVD Effects

- FLT850
- Strong Accretion condition

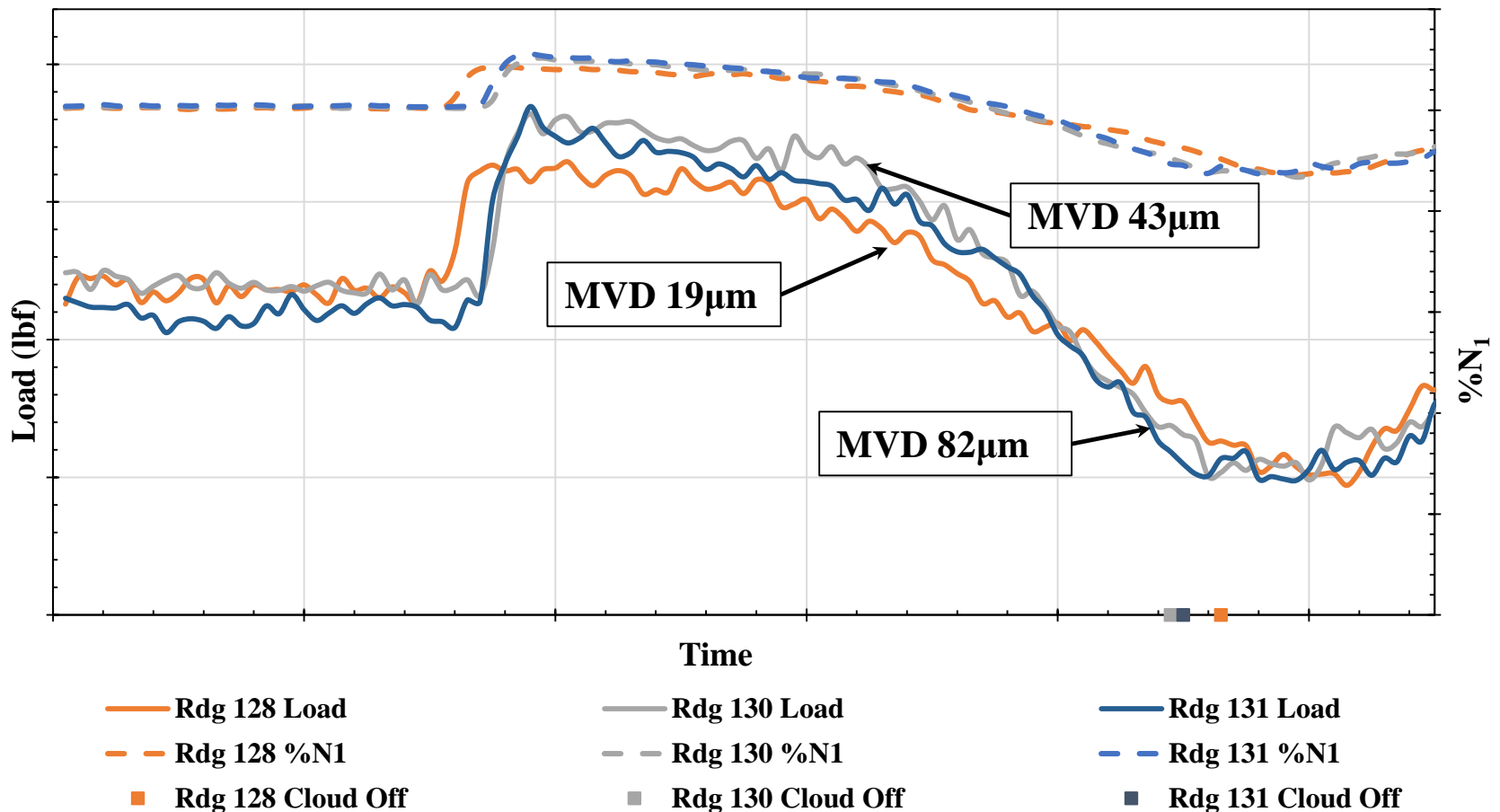

Influences on Rollback: MVD Effects

- Warm E
- Threshold Condition
- MVD does not have an effect until $70\mu\text{m}$

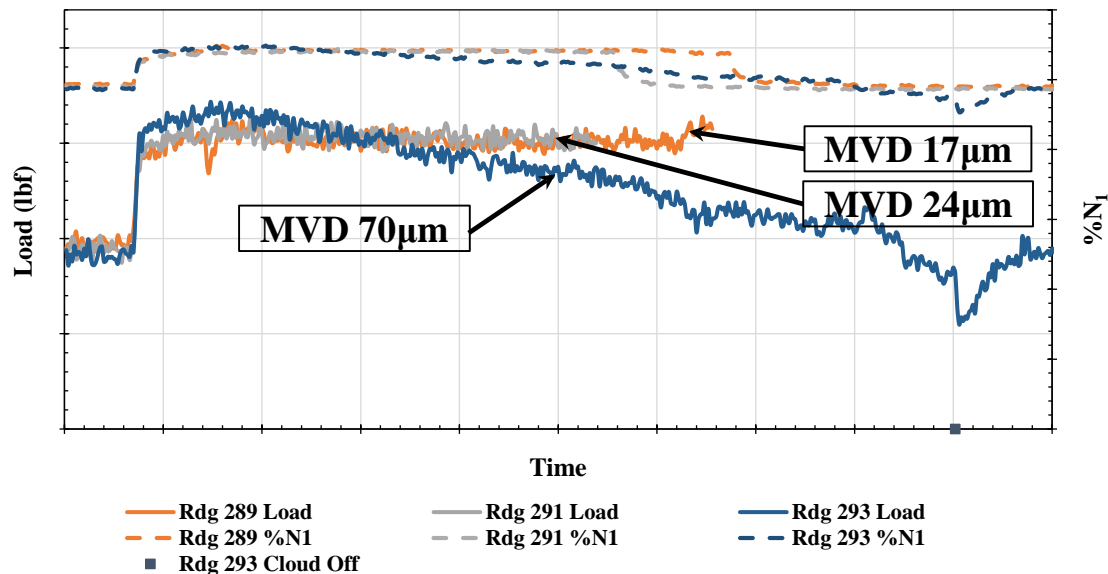

- Cold E
- Threshold Condition
- Increasing MVD decreases CRB time

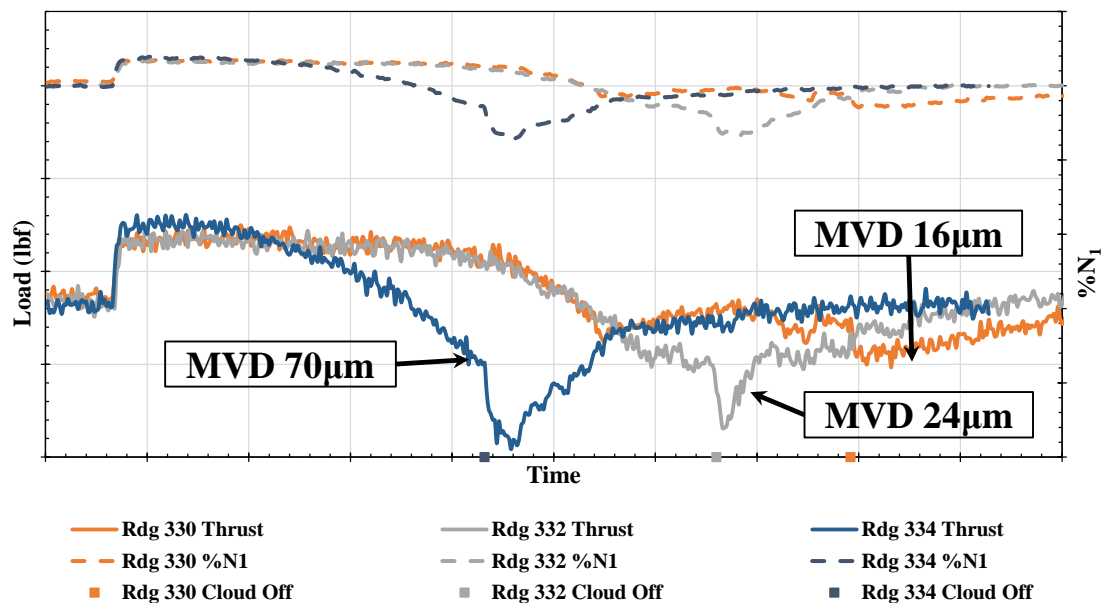

Influences on Rollback: N1 Effects

- FLT850
- Increasing N1 provides more energy into the flow suppressing rollback.
- Ice/water present during N1 increases.
- Little to no water runback observed while decreasing N1.

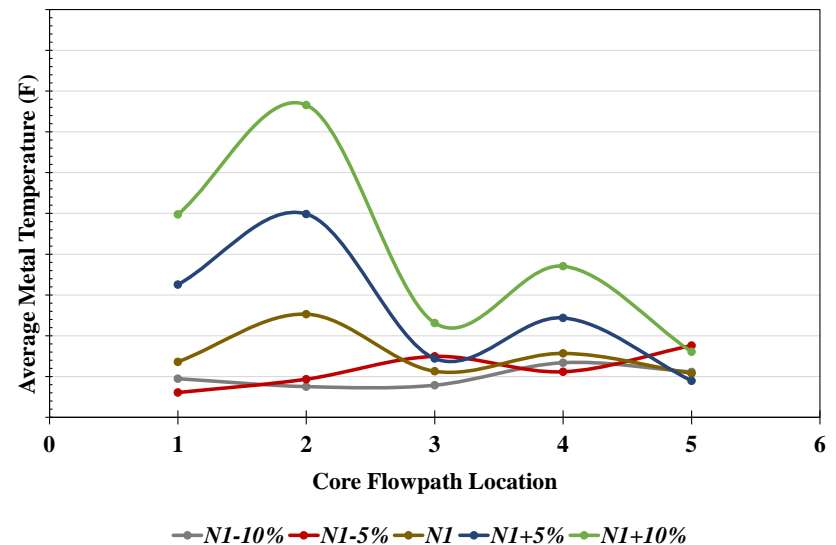
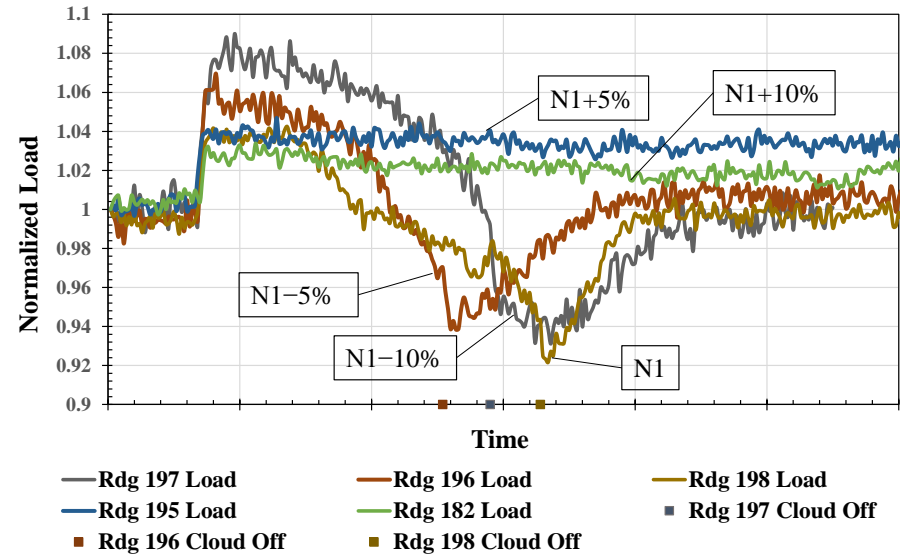

Other Observations

- Observed build and shed in the videos and metal temperature measurements.
- Spinner and IGV A/I Heat was turned off to explore the effects of the additional heat sources.
- Descent operation point was explored in PSL.
- Demonstrated ability to perform peak sensitivity study during a single test entry.
- Performed altitude research points

Ice Accretion at 5 Kft Research Point and FLT850 at Respective CRB Times

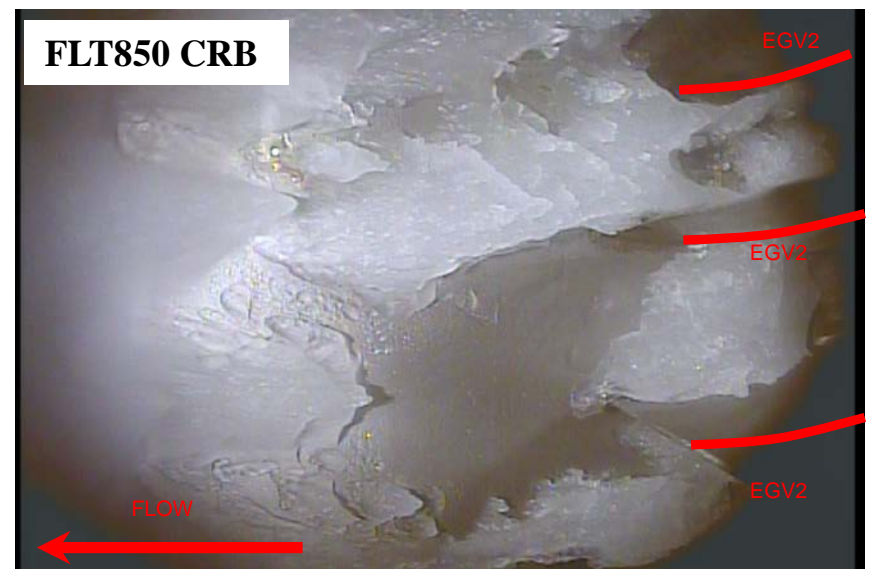
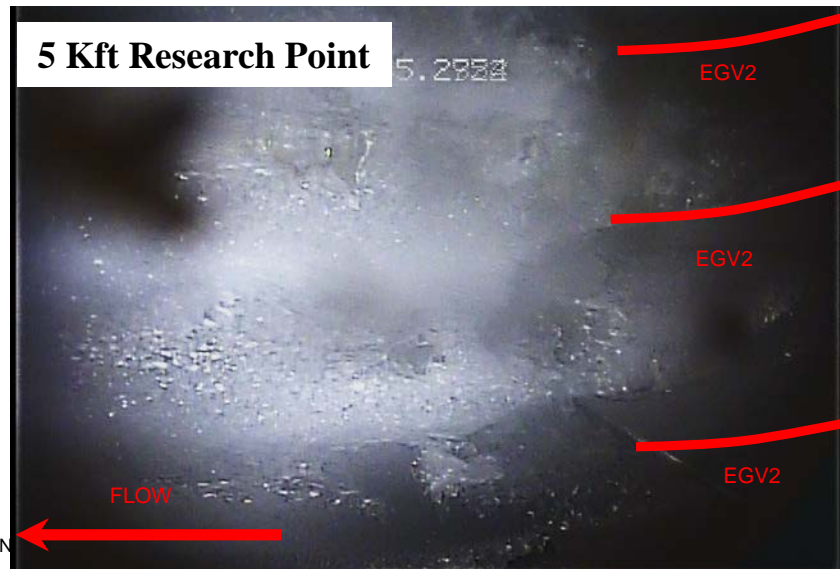

Conclusions

- Tested a Heavily Instrumented ALF502R-5 engine in PSL
- Repeated FLT850 full rollback point with good repeatability
- Repeated key revenue service called rollback points with good agreement.
- Although performance degradation occurred during the test, daily anchor points show facility and engine conditions were very repeatable.
- Cameras were installed downstream of the EGV's to observe accretion. Videos can be correlated to the metal thermocouples and icing sensors.
- For each condition tested, sweeps of the TWC, MVD, N1, and ambient temperature were conducted.

Conclusions

- TWC has the largest effect on the onset of icing.
- MVD had secondary effect, however for strong accretion conditions, MVD had no effect.
- Decreasing the fan speed promotes stronger cooling leading to an increased rate of accretion
- Additional heat sources are not needed for rollback to occur.
- PSL facility demonstrated the ability to simulate peak *TWC* intensities during a single spray and performed a flight descent
- Data generated during this test is being used to validate in-house icing prediction and risk mitigation computational tools
- Data enables the assessment and development of the advanced instrumentation and expands the capabilities of the Propulsion Systems Laboratory

Acknowledgements

- Advanced Air Transport Technology Project (AATT)
- Aeronautics Evaluation and Test Capabilities Project (AETC)
- NASA Engine Icing Research Team
- NASA PSL Staff
- Honeywell
- National Research Council Canada (NRC)
- Ice Crystal Consortium (ICC)

