

578063
p. 24

107

NASA TECHNICAL NOTE

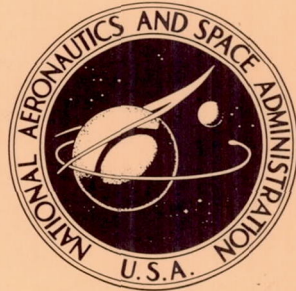

NASA TN D-2075

NASA TN D-2075

24 p.

N 63 23684

CODE-1

**EFFECT OF CONTACT ANGLE AND
TANK GEOMETRY ON THE CONFIGURATION
OF THE LIQUID-VAPOR INTERFACE
DURING WEIGHTLESSNESS**

*by Donald A. Petrash, Ralph C. Nussle,
and Edward W. Otto
Lewis Research Center
Cleveland, Ohio*

(NASA TN)
TECHNICAL NOTE D-2075) \$OTS: \$ 0.75

EFFECT OF CONTACT ANGLE AND TANK GEOMETRY ON THE
CONFIGURATION OF THE LIQUID-VAPOR INTERFACE
DURING WEIGHTLESSNESS

By Donald A. Petrash, Ralph C. Nussle, and Edward W. Otto. *Washington, NASA,*
Oct. 1963 24 p refs
Lewis Research Center
Cleveland, Ohio

EFFECT OF CONTACT ANGLE AND TANK GEOMETRY ON THE
CONFIGURATION OF THE LIQUID-VAPOR INTERFACE
DURING WEIGHTLESSNESS

By Donald A. Petrash, Ralph C. Nussle, and Edward W. Otto

SUMMARY

23684

As a part of the overall study of the behavior of rocket-engine propellants stored in space-vehicle tanks while exposed to weightlessness and solar and planetary radiant-heat sources, an experimental investigation was conducted to determine the effect of contact angle and tank shape on the liquid-vapor interface configuration during weightlessness.

The results of this investigation with liquids that have contact angles of 0° , 40° , and 125° verified the contention that the contact angle remains unchanged from its 1-g value when the liquid is in a zero-g environment. In all tanks investigated (spheres, cylinders, and cones) the liquid-vapor interface tended toward a configuration of constant surface curvature meeting the tank walls at the contact angle.

AUTHOR

INTRODUCTION

The NASA Lewis Research Center is currently conducting a study of the problems associated with the behavior of rocket-engine propellants stored in space-vehicle tanks while exposed to weightlessness (zero g) during coasting periods. In a zero-g environment, the acceleration or gravitational body forces that cause liquids to assume their familiar shapes in containers, that cause bubbles to rise in a liquid, and that create convection currents and hydrostatic pressure are absent. Surface tension, therefore, remains as the dominant force that affects the liquid configuration in propellant tanks during weightless periods, the liquid-configuration dynamics, and the mechanics of heat transfer.

The configuration of the liquid-vapor interface under weightless conditions has been studied analytically by several investigators. Benedikt (ref. 1) and Reynolds (ref. 2) have calculated exact solutions for the configuration of the interface between parallel plates as a function of the gravity level and from these calculations have inferred the configurations of the interface in other geometries. Li (ref. 3) has used the principle of the minimization of the free surface energies to predict the interface configuration in many geometries. All these analyses indicate that the interface configuration is primarily dependent

on the contact angle and that during weightlessness the liquid-vapor interface tends to assume a constant-curvature surface that intersects the tank wall at the contact angle. An experimental study of the configuration of the liquid-vapor interface for alcohol and mercury in spherical containers (ref. 4) tended to verify these analytical predictions. That study, however, was limited to two contact angles and one tank shape, although a range of tank fillings was studied.

This report presents the results of experiments in which the liquid-vapor interface configuration was observed for liquids with contact angles of 0° , 40° , and 125° . The tank shapes studied were spheres, cylinders, and cones, and the liquid filling ranged from 10 to 90 percent.

APPARATUS

Test Facility

The experimental results were obtained in the 100-foot drop tower shown in figure 1. A free-fall time of 2.3 seconds was obtained by allowing the experiment package to undergo an 85-foot unguided free fall. The experiment was prepared on the fifth floor of the tower, hoisted to the eighth floor, and suspended from the ceiling by a highly stressed music wire. Release of the experiment was accomplished by pressurization of an air cylinder that forced a knife edge into the support wire, which rested against an anvil. The experiment package was recovered after the fall by allowing wooden spikes 6 feet long, which were mounted on the package, to embed in a box of sand 7 feet deep and 7 feet in diameter.

Drag Shield

Air resistance on the experiment package was kept below 10^{-5} g by allowing the experiment to free fall inside a protective air-drag shield as shown in figure 2. The drag shield was designed with a high weight to frontal-area ratio and a low drag coefficient so that the deviation from true free fall would be minimized. The sides of the drag shield were removable to permit installation and removal of the experiment package. Prior to deceleration in the sand box, the package came to rest on the bottom of the drag shield, and this resulted in a usable zero-g test time of 2.25 seconds.

Experiment Package

The tanks used in this experimental study were 100-milliliter glass spheres, cylinders, and cones, shown schematically in figure 3. The tanks were mounted in a box having a dull white interior that was illuminated indirectly by four 20-watt bulbs to allow a 16-millimeter high-speed motion picture camera to photograph the liquid motion during the free fall. Power for both lights and camera was carried on board the experiment package and consisted of 48 rechargeable nickel-cadmium batteries. Photographs of the experiment package and the drag shield are presented in figure 4.

Test Liquids

The liquids used in this investigation were 200-proof ethyl alcohol, triple-distilled mercury, and tetrabromoethane. Ethyl alcohol (contact angle on glass, 0°) was selected as representative of a totally wetting liquid, tetrabromoethane (contact angle, 40°) a partially wetting liquid, and mercury (contact angle, 125°) a nonwetting liquid. The contact angle, dependent on the liquid-vapor surface tension, the liquid-solid surface tension, and the vapor-solid surface tension, is defined as the angle at which the liquid-vapor interface meets the solid surface, measured through the liquid. Properties of the test liquids that may be of interest are given in table I. A small amount of methylene blue dye was added to the ethyl alcohol, and a small amount of Sudan red dye was added to the tetrabromoethane to improve the quality of the photographs. The addition of the dye had no measurable effect on the liquid properties.

RESULTS

As mentioned previously, the interface motion during each test was photographed by a high-speed motion picture camera. In order to present the results in report form, one photograph was selected for each test point that represented the steady-state configuration of the liquid-vapor interface (fig. 5). This method of presentation leaves much to be desired because of present reproduction techniques, and hence, as an aid to the reader, a sketch of the interface configuration is given with each photograph as an interpretation of the motion picture data. The technique for determining the liquid contact angle on the solid surface in the zero-g environment was to measure the angle from the film. Another technique was to utilize the constant-curvature geometry of a sphere (described in the appendix).

Interface Configuration in Spheres

The results obtained from the experimental investigation of alcohol, tetrabromoethane, and mercury in spherical tanks are presented in figure 5(a). The liquid-vapor interface configuration of alcohol (contact angle, 0°) in spheres takes the form of a spherical vapor bubble in the interior of the liquid for all percentages of filling investigated (fig. 5(a-1)). This configuration results from the attempt of the liquid-vapor interface to return to its characteristic contact angle with the glass wall; this could not be accomplished because of the continuous curvature of the wall. The interface configuration for both tetrabromoethane (contact angle, 40°) and mercury (contact angle, 125°) is a surface of constant curvature intersecting the walls of the spherical tank at the liquid contact angle.

Interface Configuration in Cylinders

The results of the experimental study of the behavior of the three test liquids in flat-ended cylindrical tanks are presented in figure 5(b). The liquid-vapor interface configuration for alcohol in cylinders is a constant-

curvature liquid-vapor surface having a radius equal to the radius of the cylinder and meeting the tank wall at a contact angle of 0° . This interface configuration was obtained over a wide range of fillings and is illustrated in figure 5(b-1) by the 50-percent-full test. This interface configuration is significantly different from that observed in spherical tanks, in which the walls became totally wetted. This change occurred because the interface could attain the characteristic contact angle of 0° along the straight section of the cylindrical wall. The interface configuration observed for tetrabromoethane and mercury is similar to that observed in spheres; that is, a constant-curvature liquid-vapor surface meeting the walls at contact angles of 40° and 125° , respectively (figs. 5(b-2) and (b-3)).

It can be seen from figure 5(b) that, in some cases, the shape of the interface is altered by interaction with the ends of the cylinder. At low fillings with wetting liquids, if the interface encounters the bottom of the tank, a slight uncovering of the bottom occurs, and the liquid is left in the corners of the tank (see fig. 5(b-1), 10 percent full). At high fillings with wetting liquids, the vapor forms a bubble in the liquid when the liquid-vapor interface encounters the top of the cylinder. In the case of alcohol, the vapor forms a bubble in the liquid as the liquid-vapor interface attempts to attain its contact angle of 0° with the solid surface (fig. 5(b-1)). In the case of tetrabromoethane, the 40° contact angle is attained with the vapor bubble in contact with the top of the cylinder.

Interface Configuration in Cones

Presented in figure 5(c) are the results of the experimental study of alcohol, tetrabromoethane, and mercury in conical tanks. The liquid-vapor interface configurations observed in the conical tanks are much the same as those observed in the cylindrical tanks. The interface is a surface of constant curvature intersecting the tank wall at the contact angle characteristic of the liquid. End effects are again indicated at the high fillings by the vapor bubble in the interior of the liquid. In the case of tetrabromoethane, at a 90 percent filling, the vapor formed a bubble in the liquid as a result of an overshoot of the zero-g equilibrium configuration of sufficient magnitude to wet the top of the tank.

CONCLUDING REMARKS

The results of this experimental investigation indicate that the contact angle of the liquid at the solid-liquid-vapor interface observed at 1 g is preserved in a zero-g environment and that the liquid-vapor interface tends toward a configuration of constant surface curvature that intersects the tank wall at the contact angle. The results are summarized in figure 6, where typical zero-g interface configurations for a range of contact angles are presented. Also shown in the figure are the 1-g interface configurations, in which the contact angle effect can be noted in the meniscus at the solid surface. Upon entering a zero-g environment, the system will adjust until the contact angle has attained the characteristic value and the liquid-vapor interface has assumed

a constant-curvature surface.

The results of this study also reveal that, because the contact angle is preserved, the geometry of the system can significantly alter the interface configuration, and that end effects may be present at low or high fillings. At high fillings, the tendency of wetting liquids is to surround the vapor and form a bubble, whereas at low fillings, several interface configurations occur depending on the contact angle of the liquid. Shown in figure 7 are the interface configurations that would be obtained in cylindrical tanks with differently shaped ends for ethyl alcohol, which is typical of most propellants (contact angle, 0°), and for mercury, which is typical of the nonwetting liquids (contact angle, 125°). It can be concluded from an examination of these interface configurations that wetting liquids tend to fill corners, whereas nonwetting liquids tend to leave corners.

Lewis Research Center
National Aeronautics and Space Administration
Cleveland, Ohio, August 8, 1963

APPENDIX - TECHNIQUE FOR MEASURING CONTACT ANGLE

In addition to direct measurement from the film taken in the zero-g environment, another method of determining the zero-g contact angle was utilized.

A 100-milliliter glass sphere was filled with just enough liquid to establish the contact angle at 1 g with no meniscus. A graph illustrating the proper filling to produce this contact angle in a sphere is presented in figure 8. In the case of tetrabromoethane, a filling of 4 percent of the sphere volume resulted in a contact angle of 40° with no measurable meniscus at 1 g (fig. 9(a)). The sphere, with this filling, was then subjected to a weightless condition in the drop tower. The motion picture film of this test drop revealed that the liquid-vapor interface did not move during the drop, but remained exactly as in the 1-g configuration (fig. 9(b)). Hence, the contact angle was 40° when the sphere was placed in the zero-g environment.

The same procedure was used to check the contact angle of mercury in a zero-g environment. In this case, a higher filling of mercury was required to establish the contact angle with no meniscus (see ref. 4, fig. 21). Because ethyl alcohol is a totally wetting liquid, this method could not be used to check the contact angle of alcohol in a zero-g environment.

REFERENCES

1. Benedikt, E. T.: General Behavior of a Liquid in a Zero or Near Zero Gravity Environment. Rep. ASG-TM-60-9Z6, Norair Div., Northrop Corp., May 1960.
2. Reynolds, William C.: Hydrodynamic Considerations for the Design of Systems for Very Low Gravity Environments. Rep. LG-1, Stanford Univ., Sept. 1, 1961.
3. Li, Ta: Hydrostatics in Various Gravitational Fields. Jour. Chem. Phys., vol. 36, no. 9, May 1, 1962, pp. 2369-2375.
4. Petrash, Donald A., Zappa, Robert F., and Otto, Edward W.: Experimental Study of the Effects of Weightlessness on the Configuration of Mercury and Alcohol in Spherical Tanks. NASA TN D-1197, 1962.

TABLE I. - PROPERTIES OF TEST LIQUIDS

Property	Ethyl alcohol	Tetra-bromo-ethane	Mercury
Density at 20° C, g/cm ³	0.7893	2.9638	13.546
Viscosity at 20° C, centipoises	1.200	9.980	1.554
Surface tension at 20° C in air, dynes/cm	22.3	49.67	476.1
Density/surface tension, sec ² /cm ³	.0354	.0597	.0284
Measured contact angle on glass, deg ^a	0	40	125

^aTilting-plate apparatus.



(a) Exterior view.

Figure 1. - 100-foot drop tower.

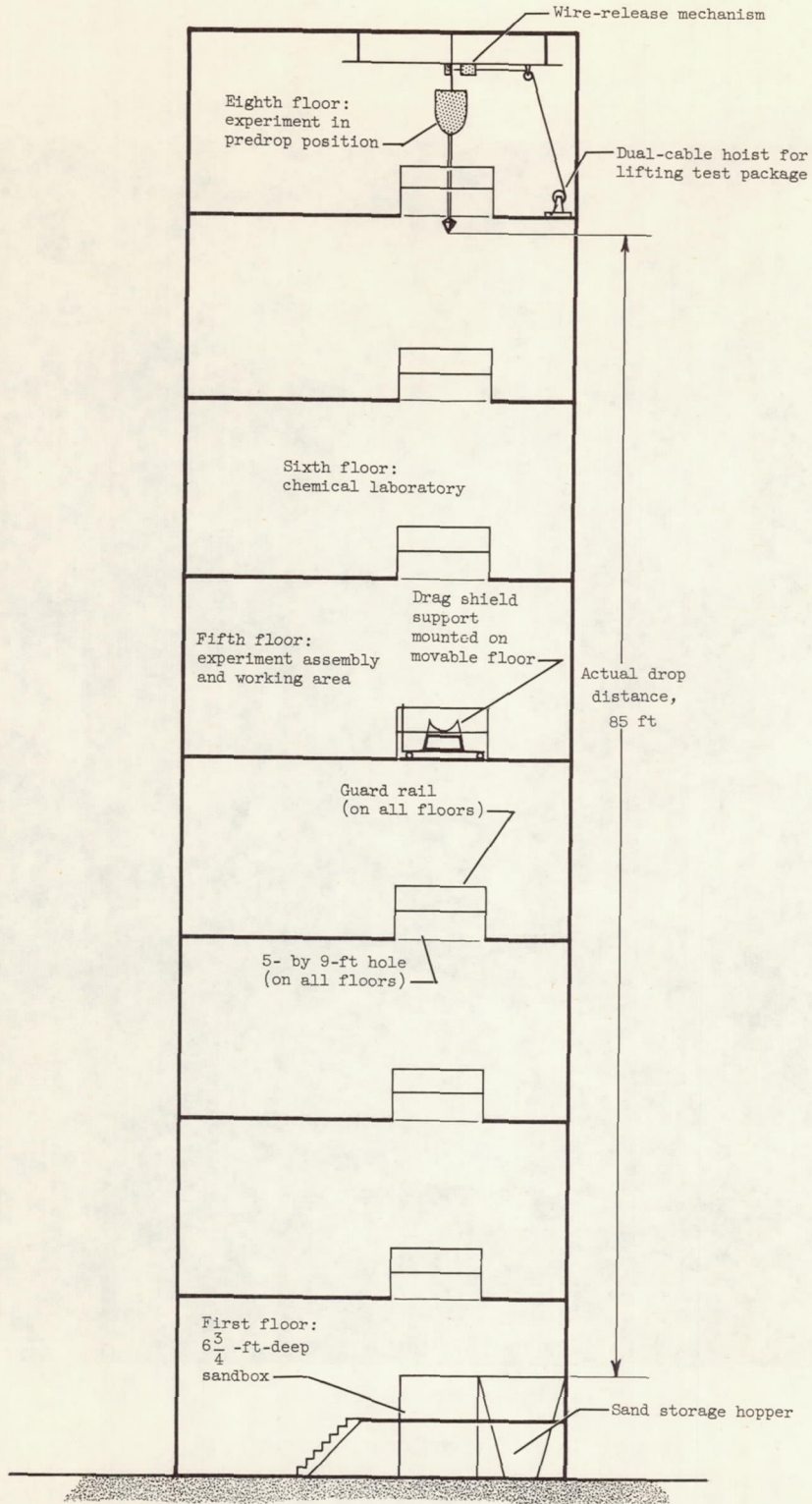

(b) Schematic drawing.

CD-7379

Figure 1. - Concluded. 100-foot drop tower.

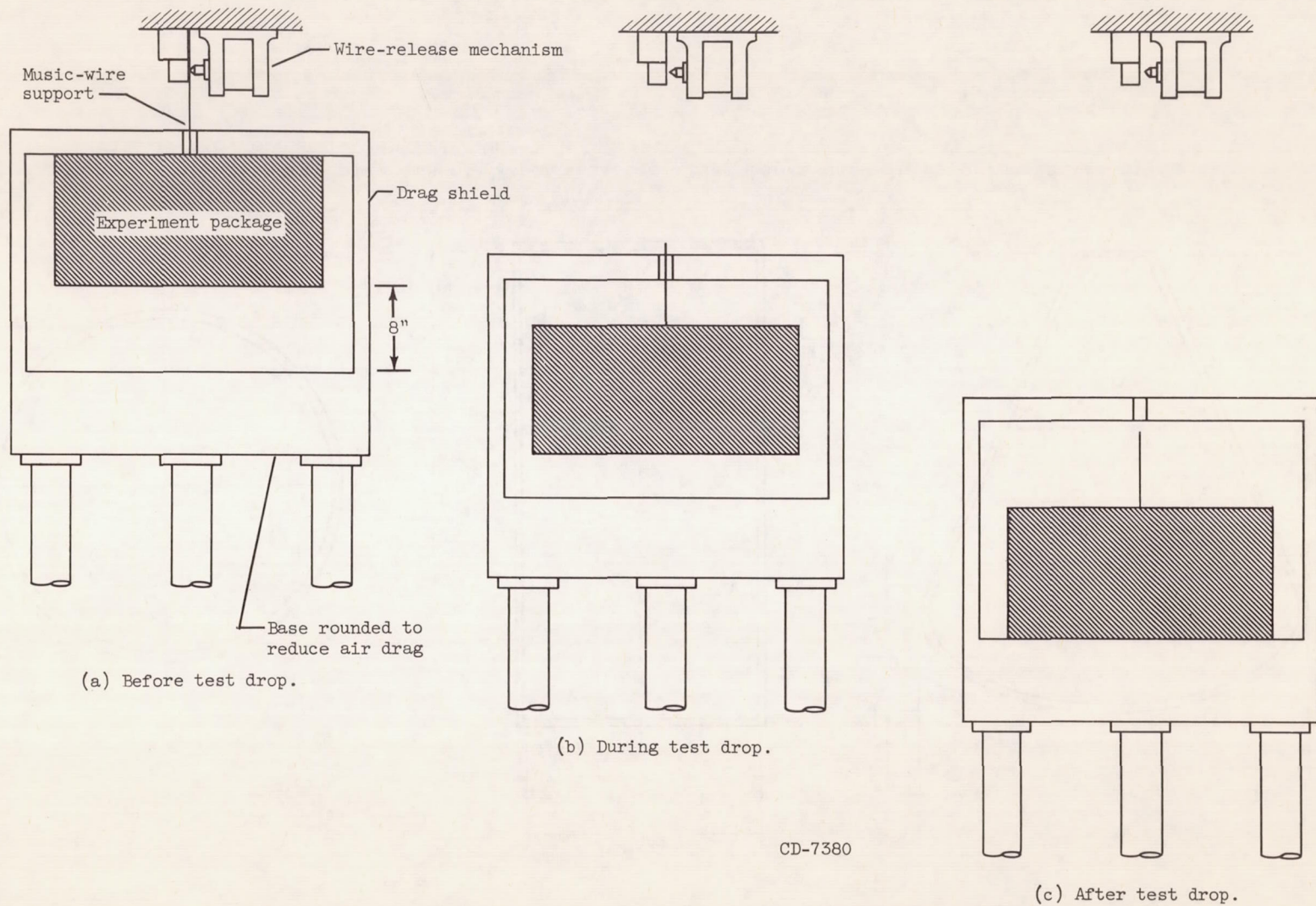

CD-7380

Figure 2. - Schematic drawing showing position of experiment package and drag shield before, during, and after test drop.

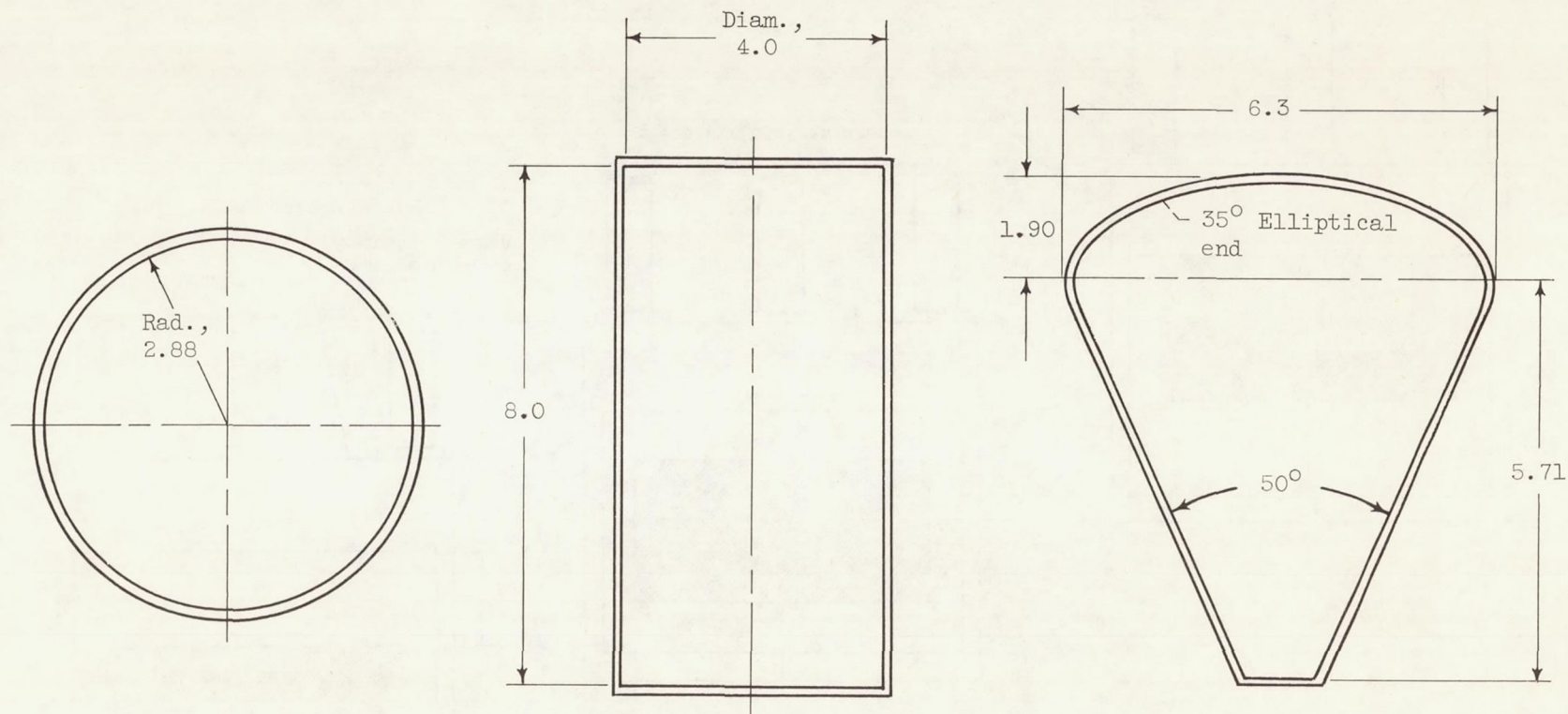
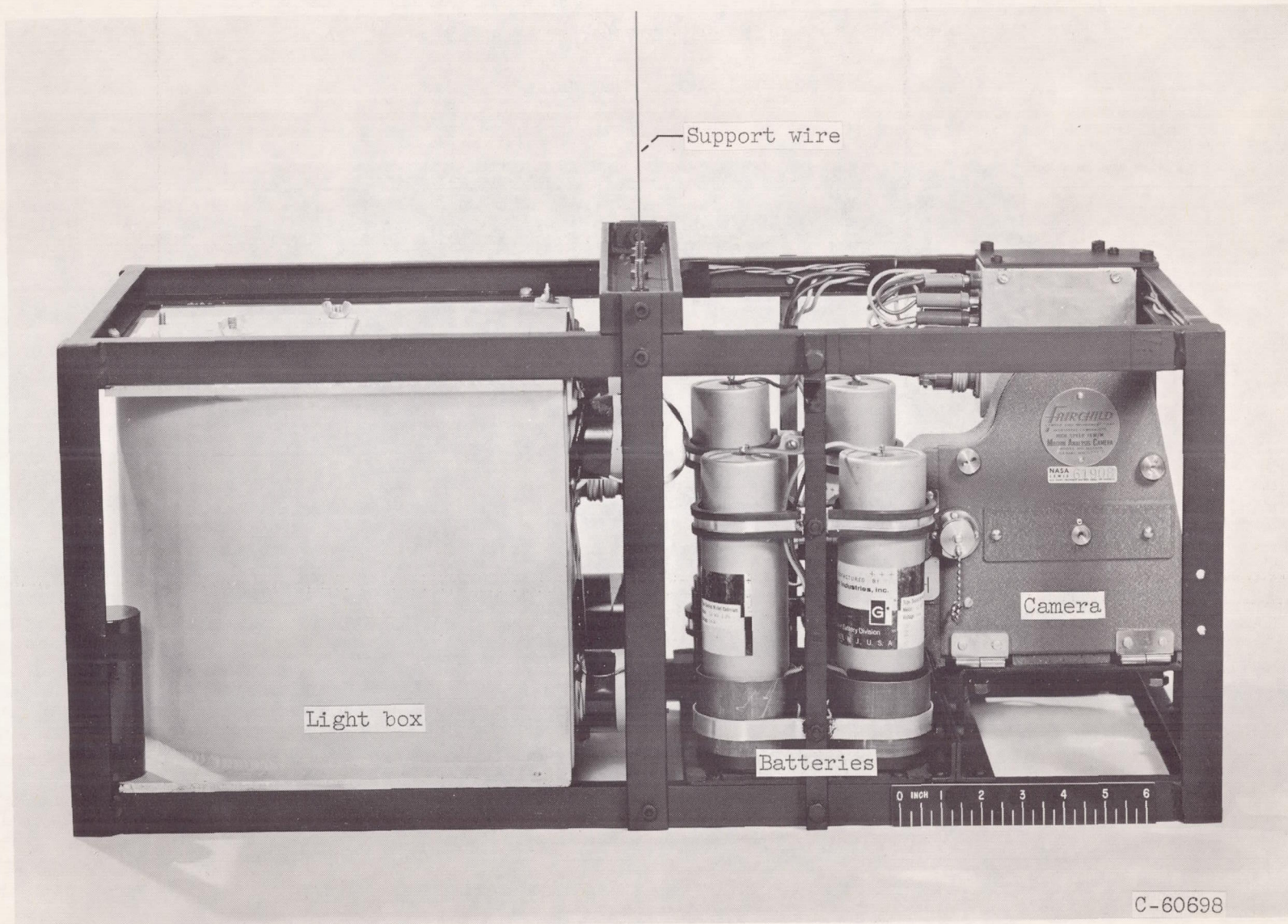
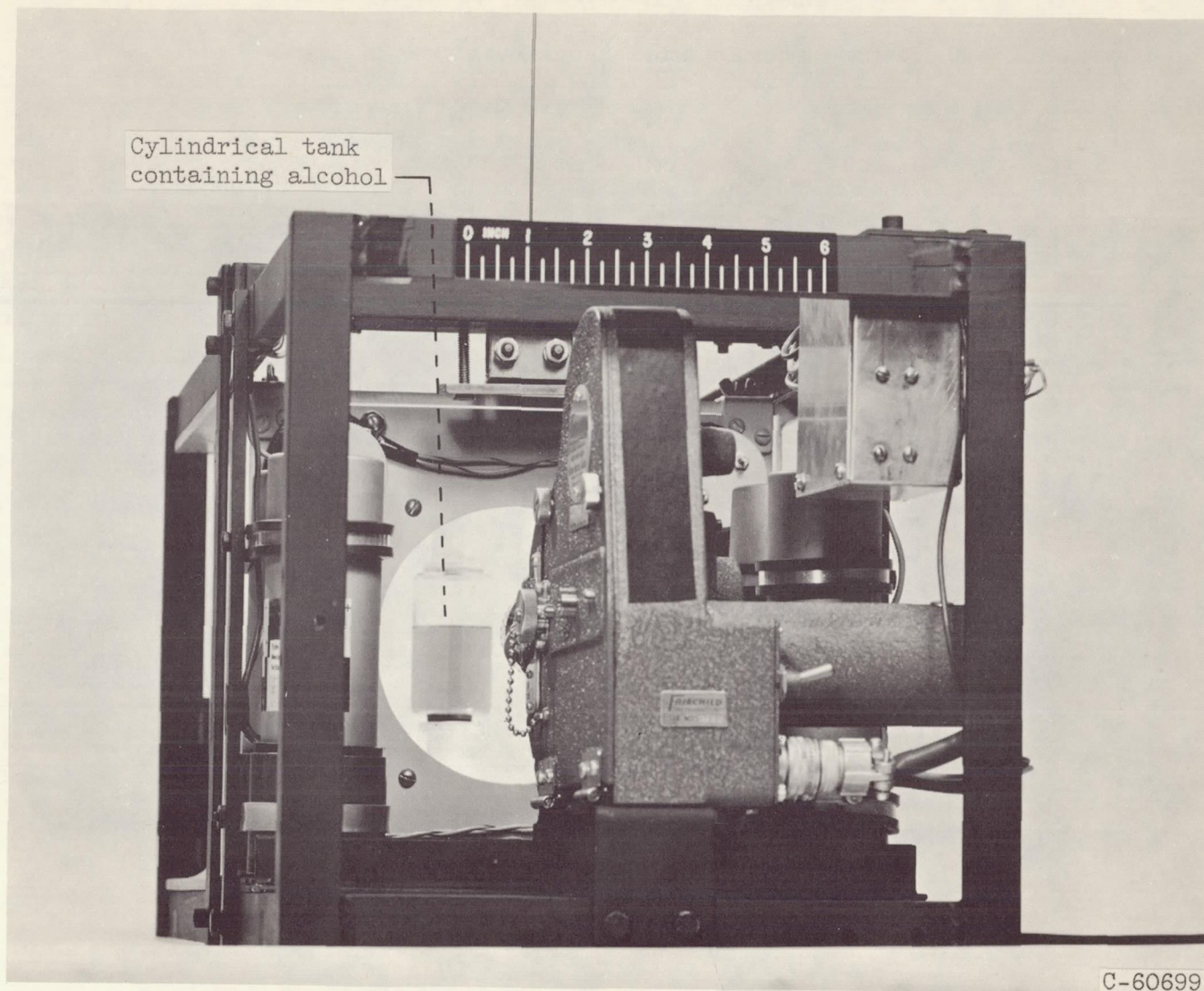

Figure 3. - Schematic diagrams of 100-milliliter glass tanks used in experimental study showing nominal dimensions in centimeters.



(a) View showing components.

Figure 4. - Experiment package.



(b) View of experiment tank mounted in light box.

Figure 4. - Continued. Experiment package.

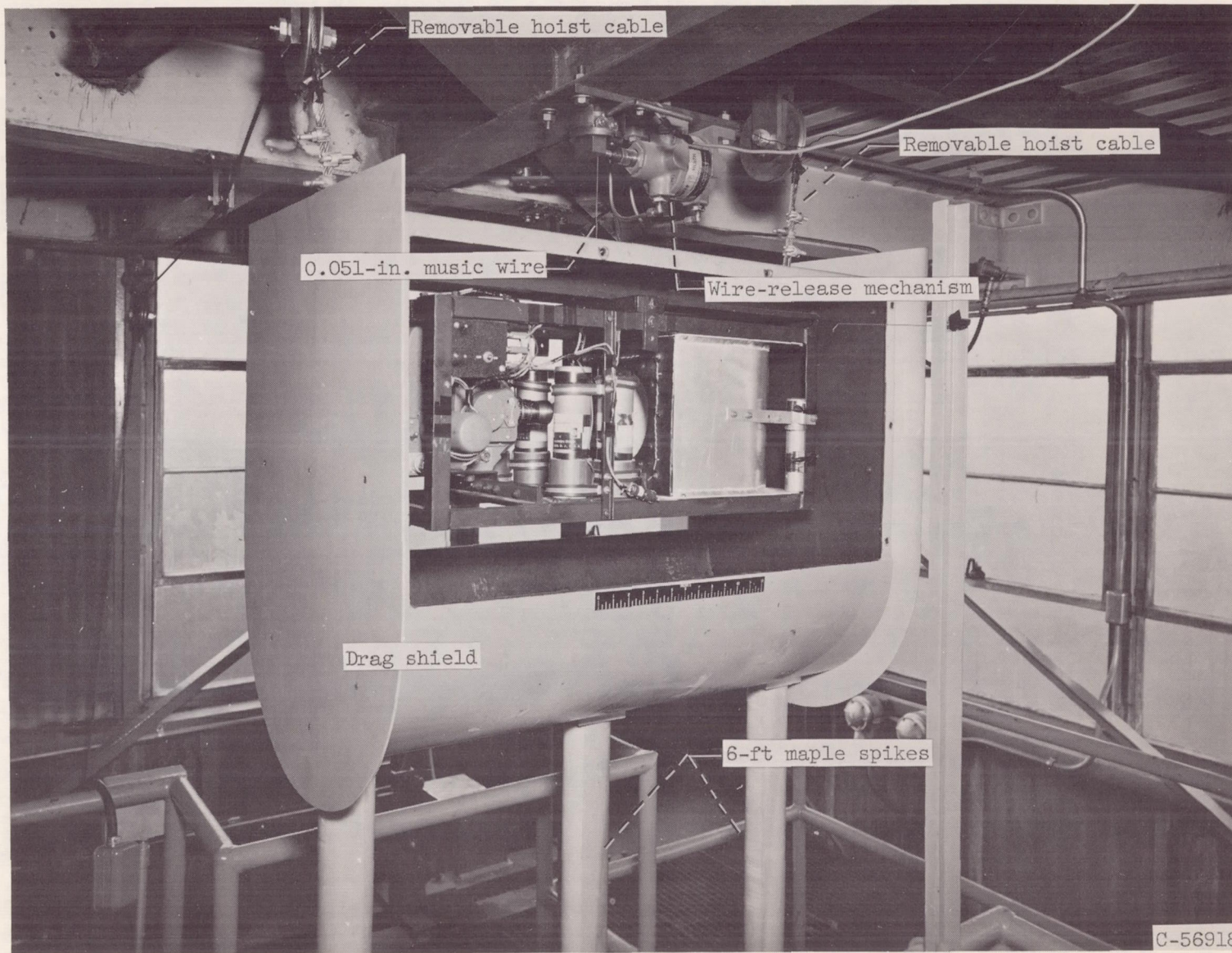

(c) Experiment inside drag shield prior to test drop.

Figure 4. - Concluded. Experiment package.

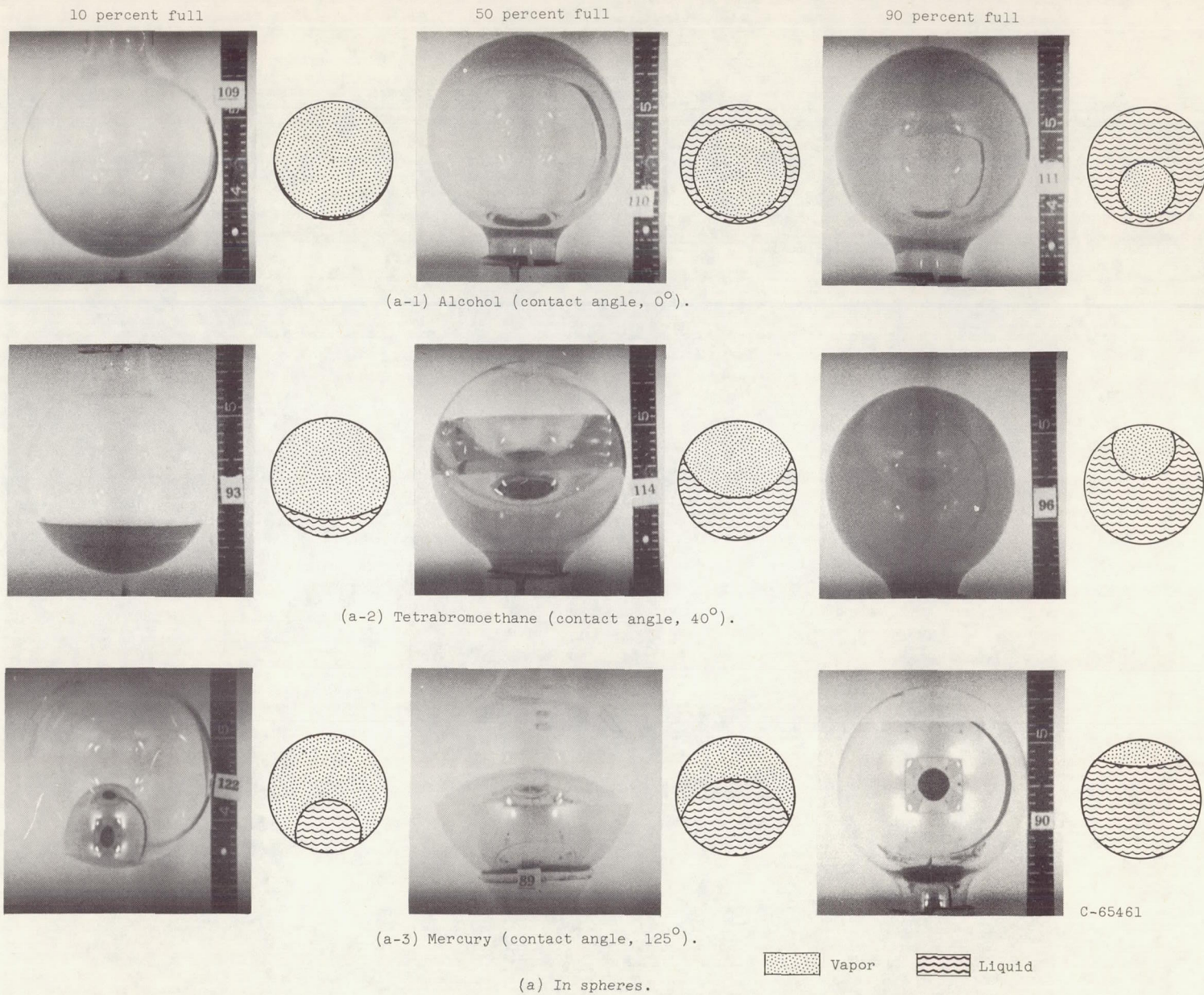
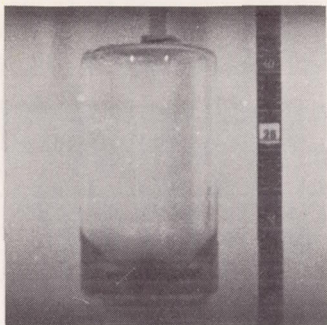
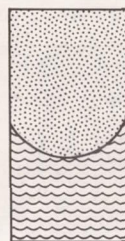
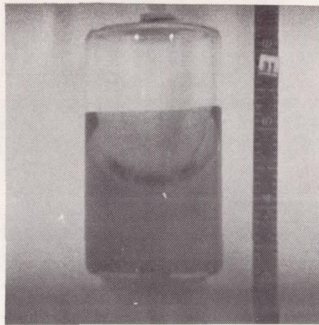

Figure 5. - Configuration of liquid-vapor interface during weightlessness.

10 percent full



50 percent full



90 percent full

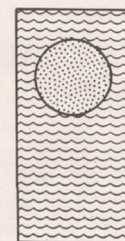
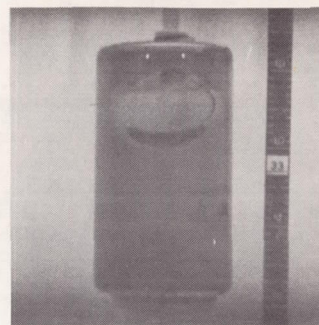

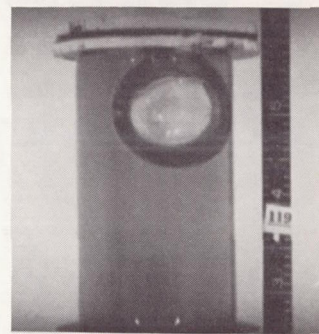
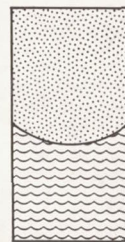
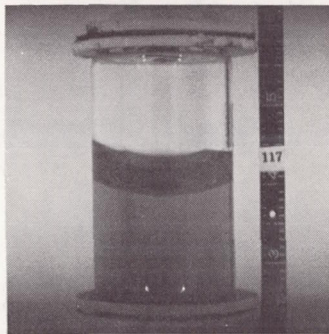
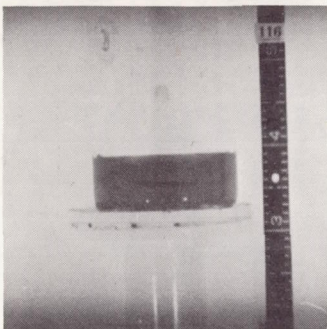

(b-1) Alcohol (contact angle, 0°).

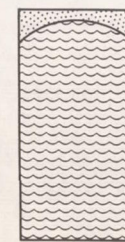
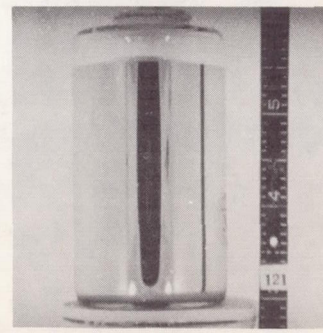
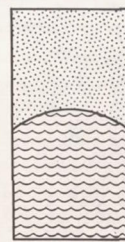
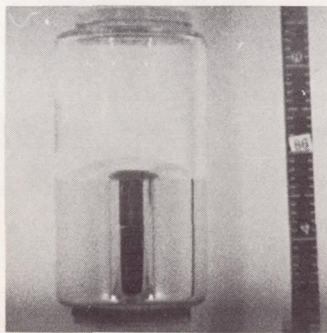
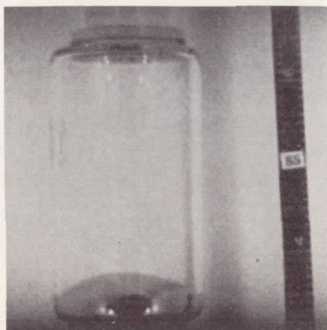

(b-2) Tetrabromoethane (contact angle, 40°).



(b-3) Mercury (contact angle, 125°).

 Vapor  Liquid

(b) In cylinders.

C-65462

Figure 5. - Continued. Configuration of liquid-vapor interface during weightlessness.

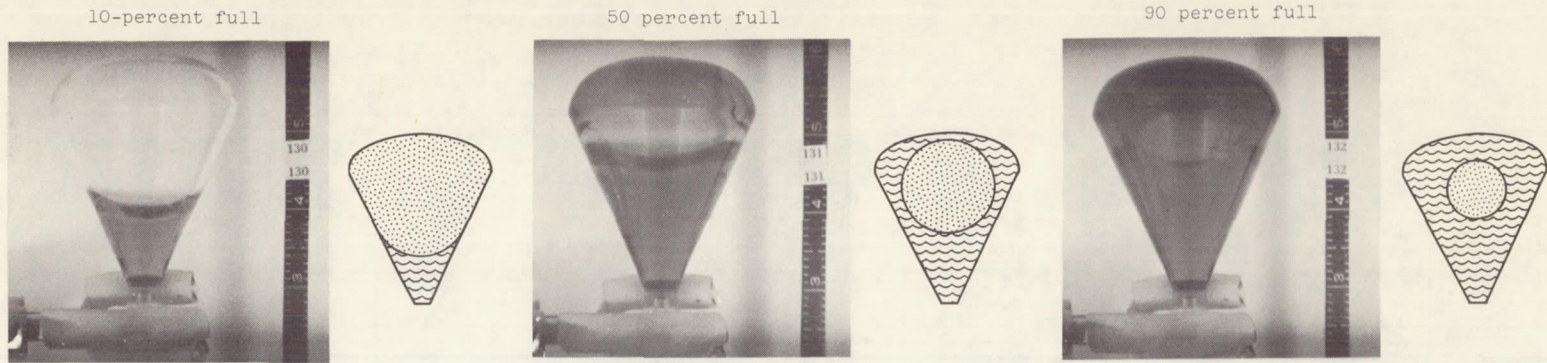

(c-1) Alcohol (contact angle, 0°).

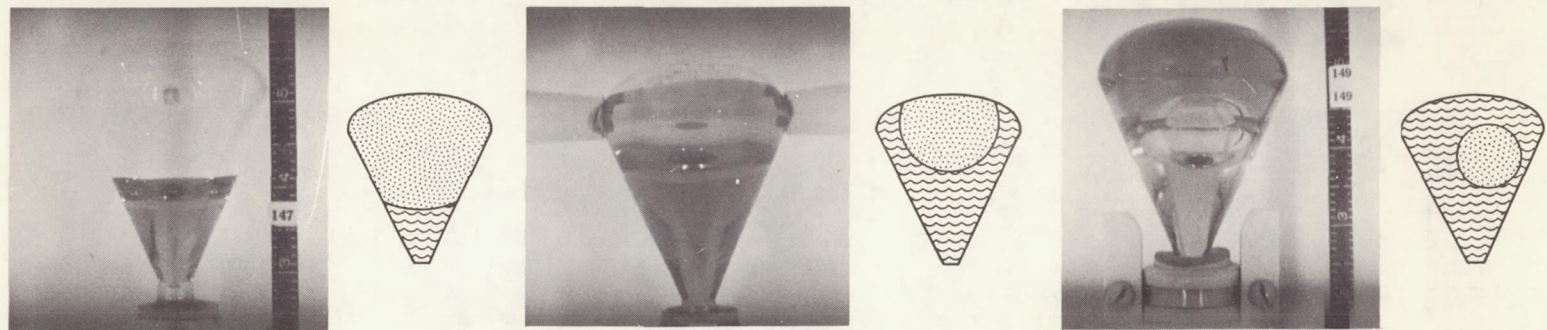

(c-2) Tetrabromoethane (contact angle, 40°).

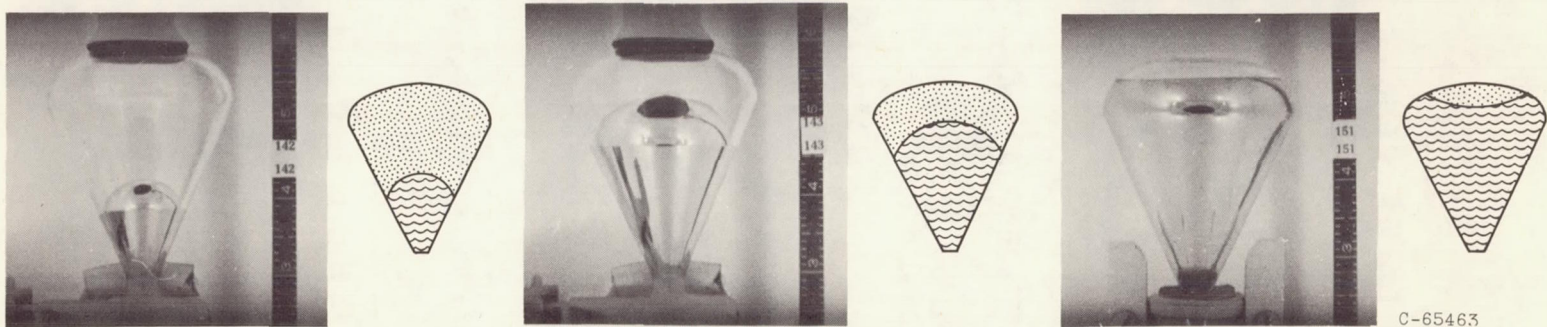

(c-3) Mercury (contact angle, 125°).

 Vapor  Liquid

(c) In cones.

Figure 5. - Concluded. Configuration of liquid-vapor interface during weightlessness.

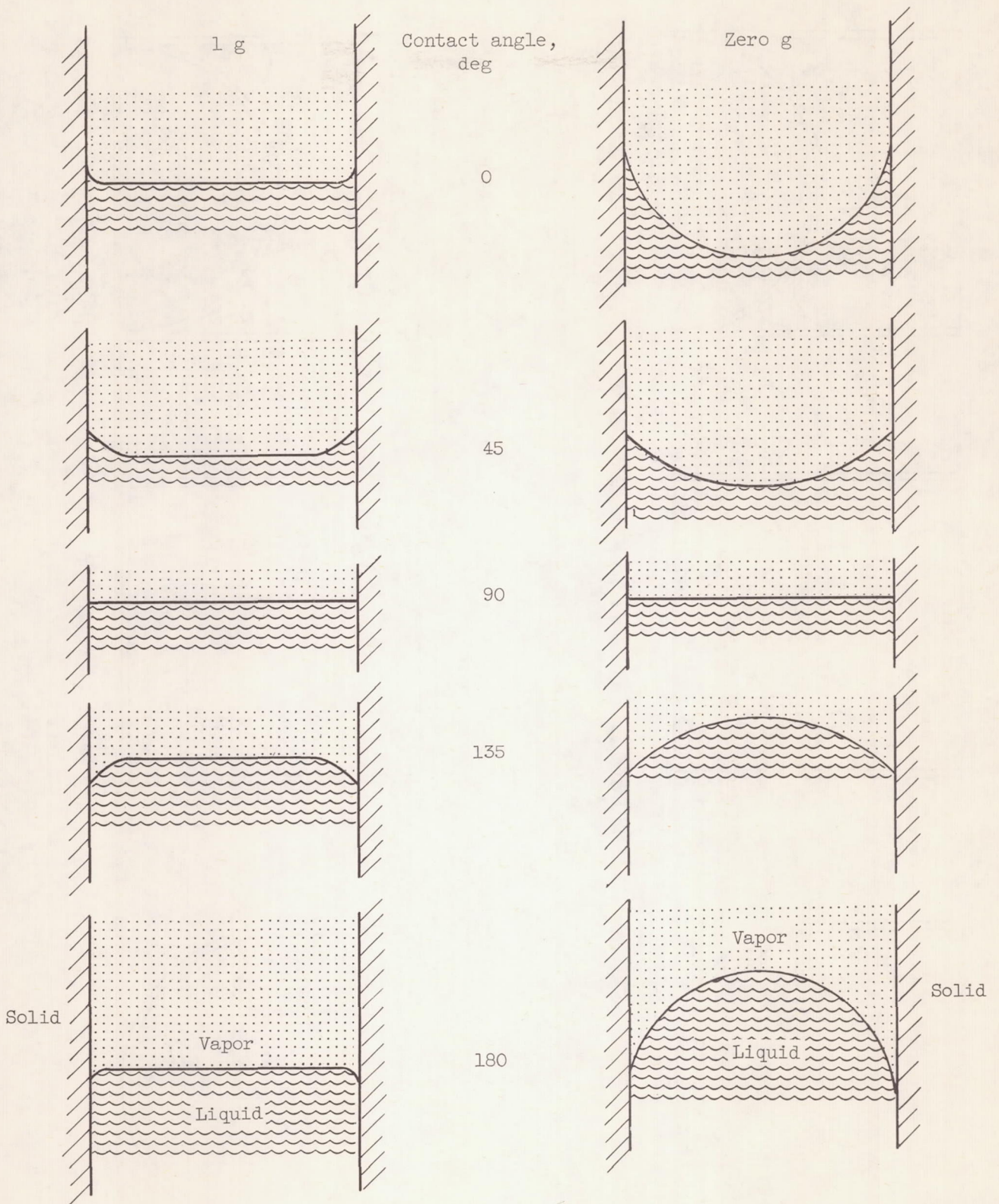
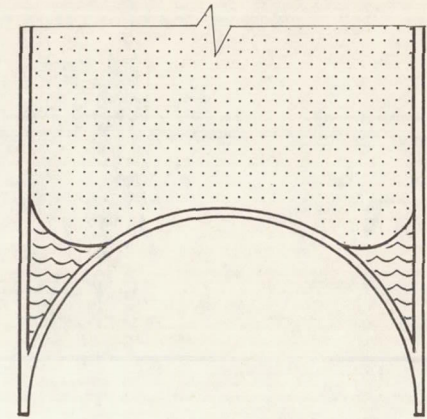
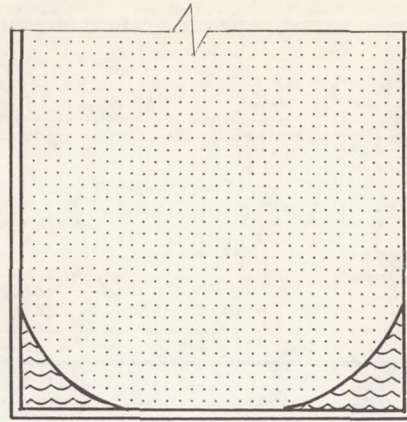
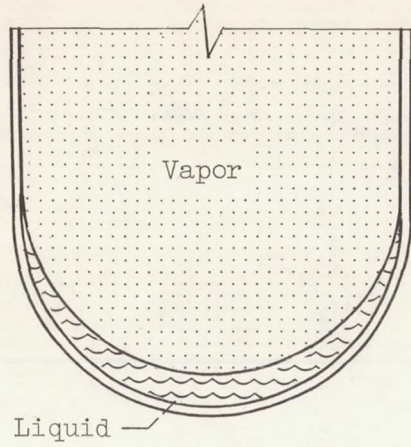
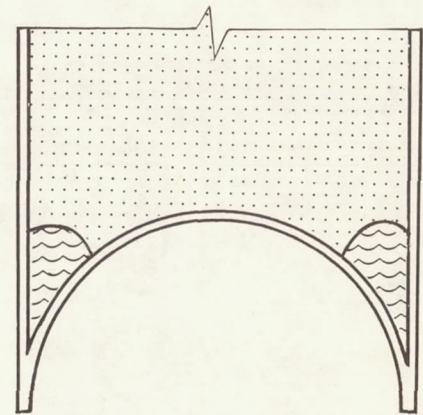
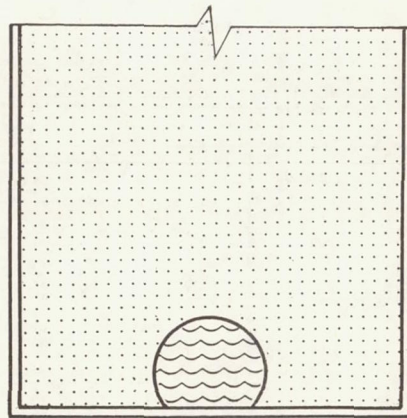
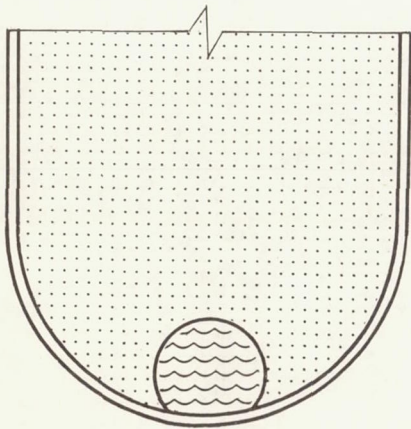

Figure 6. - Interface configurations at 1 g and zero g.



(a) Ethyl alcohol (contact angle, 0°).



(b) Mercury (contact angle, 125°).

Figure 7. - Typical interface configurations at low fillings in cylindrical tanks with various end shapes.

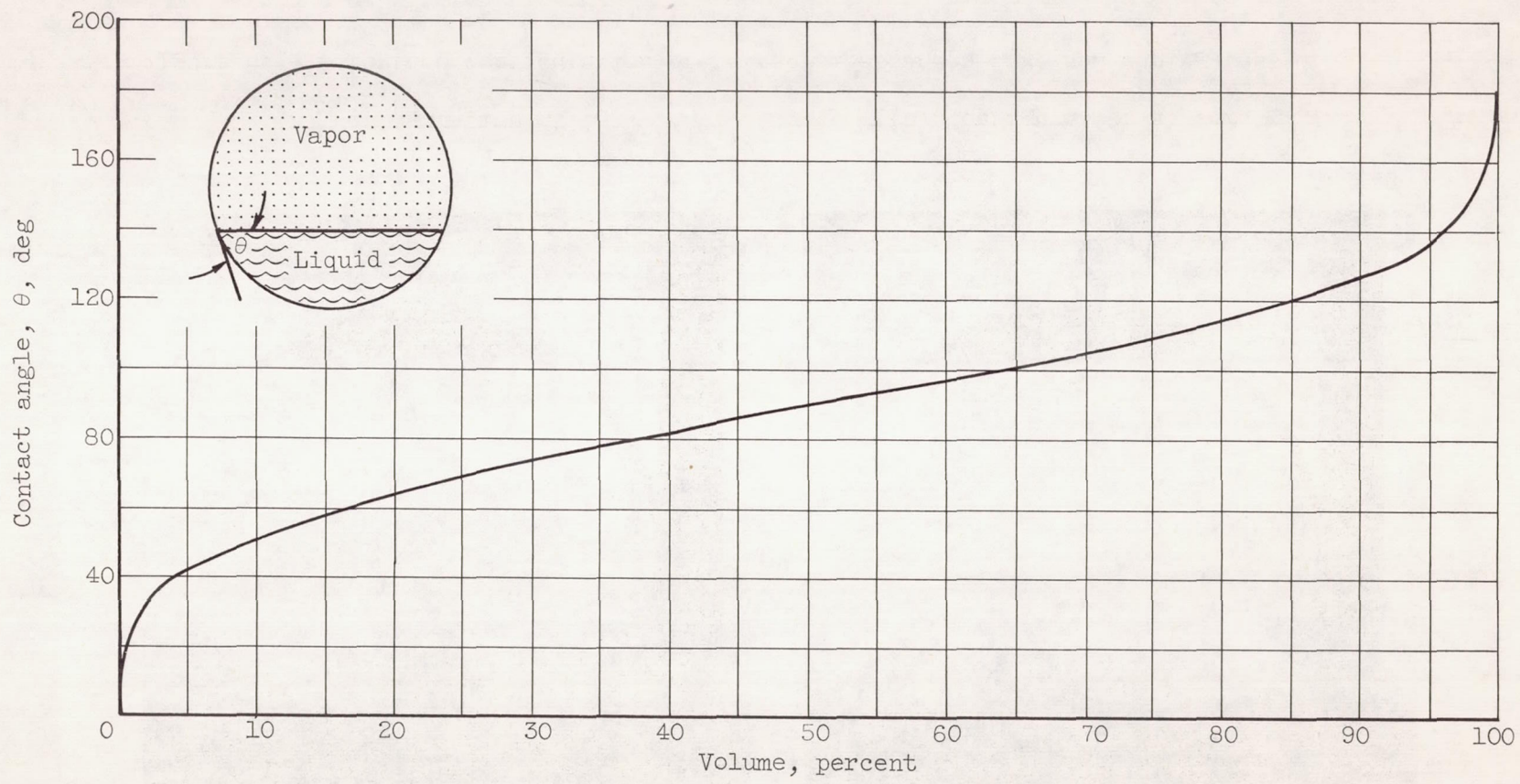
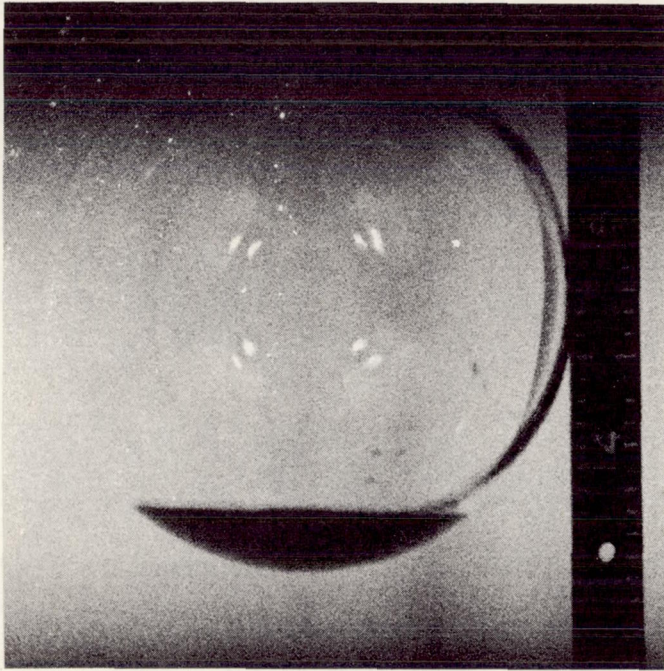
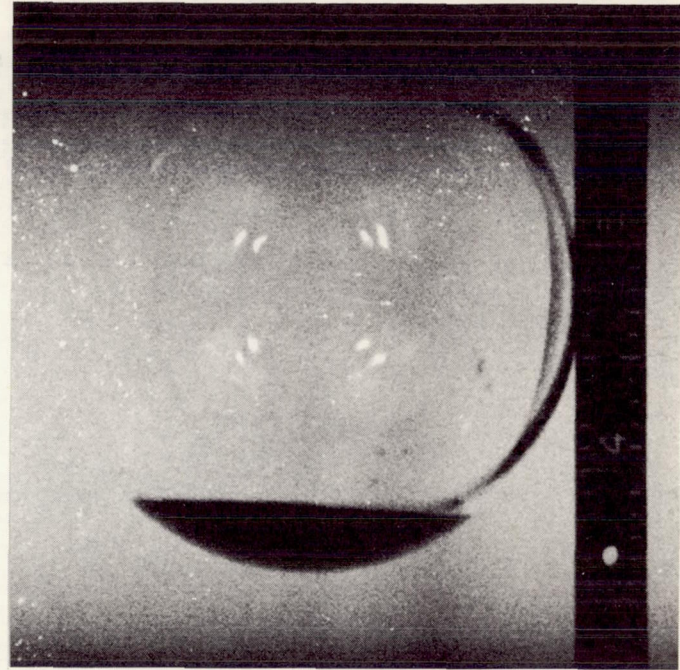

Figure 8. - Contact angle as function of percent of total volume in a sphere.



(a) Configuration at 1 g.



(b) Configuration at zero g.

C-65460

Figure 9. - Interface configuration of tetrabromoethane before and during test drop.