

34 p.

N64-19899

CODE-1

THE X-15 FLIGHT TEST INSTRUMENTATION

By Kenneth C. Sanderson

NASA Flight Research Center  
Edwards, Calif.

Third International Flight Test Instrumentation Symposium  
Buckinghamshire, England  
April 13-16, 1964

-----  
OTS PRICE

XEROX

\$

3.60 pd

MICROFILM

\$

1.22 ref.

-----  
April 21, 1964

## THE X-15 FLIGHT TEST INSTRUMENTATION

By Kenneth C. Sanderson\*

### INTRODUCTION

In 1954, the general requirements for a new research airplane destined to follow the X-1, the Douglas Skyrockets, and the X-2 were established by the National Advisory Committee for Aeronautics. The major goals of the proposed flight research program with the vehicle were to explore aerodynamic heating problems, study stability and control problems in a region where aerodynamic forces are negligible compared to inertia forces, and explore physiological factors affecting the pilot, such as weightlessness.

The configuration decided upon as best suited to meet the program goals is shown in figure 1. This configuration--the X-15--is capable of speeds greater than 6,000 ft/sec and altitudes exceeding 250,000 feet. The powerplant is a rocket engine throttleable from 28,500 pounds to 58,500 pounds of thrust with a burning time of 80 to 85 seconds at full thrust. Liquid oxygen is used as an oxidizer for liquid anhydrous ammonia. The major components of the primary structural elements behind stagnation points were capable of withstanding temperatures of approximately 1,200° F.

The performance envelope of the airplane is shown in figure 2. The wide range in dynamic pressure from less than 1 lb/sq ft to approximately 2,500 lb/sq ft, coupled with high speeds and high altitudes, generated formidable problems for the instrumentation design engineer as well as the aircraft designer. Some typical X-15 flight paths are depicted in figure 3. It is important to note that the X-15 would, during its flight program, range over

---

\*Assistant Chief, Data Systems Division

distances as great as 400 miles, covering a three-state area in the western United States. Hence, a long, well-instrumented test range away from heavily populated areas and major air-traffic lanes would be required.

#### PROGRAM INSTRUMENTATION PHILOSOPHY

The basic instrumentation philosophy for the X-15 program was dictated primarily by two factors. First, if the X-15 were to successfully fulfill its mission of providing timely research data, it had to be built and instrumented quickly. Second, the instrumentation had to be accurate and reliable.

The philosophy adopted was as follows: (1) Onboard recording would be used as the means of recording all the data sensed on the aircraft to eliminate the risk of data loss and degradation inherent in radio-frequency telemetry links. (2) Inasmuch as the X-15 would be carried aloft and launched from a B-52 aircraft, selected parameters, including engine, control system, hydraulic system, environmental control, electrical system, and pilot physiological data, would be telemetered and displayed to ground monitors in real time to insure a safe launch and flight. (3) Continuous ground radar tracking would provide information necessary for ground control and would also provide a source of space position and trajectory information for research purposes. (4) The instrumentation system would have to be flexible to meet the changing requirements of the flight-test and research engineers conducting experiments during the flight program. (5) Finally, maximum use would be made of off-the-shelf instrumentation components and systems and existing facilities to further maximize reliability, minimize costs, and enable program schedules to be achieved.

### BASIC INSTRUMENTATION REQUIREMENTS

A requirement for 1,000 to 1,100 measurements on the airplane was arrived at through an iterative process involving many groups interested in conducting experiments. Based on constraints imposed by the manufacturer of 800 pounds of general instrumentation, 40 cubic feet of space, and 2 kw of power, a total of 800 recording channels and 90 telemetry channels was decided upon as the best compromise between the research and flight-test data requirements and the constraints. A ground test range of three stations capable of providing continuous tracking, communications, and telemetry; a flight simulator for pilot training, flight planning and data analysis; and a digital computer for theoretical computations and flight-data processing rounded out the basic instrumentation requirements.

#### Design Measurements List

The design-measurements list consisted of 1,050 measurements distributed as follows:

##### Research

Skin and internal temperatures . . . . .	588
Strain . . . . .	64
Control positions . . . . .	28
Aerodynamic surface pressures . . . . .	136
Basic flight parameters ( $\alpha$ , $\beta$ , $p_s$ , $\dot{u}$ , $\dot{v}$ , $\dot{w}$ ) . . . . .	22
Flight test (subsystem) . . . . .	212
Total . . . . .	1,050

Most of the measurements, as would be expected, consist of structural temperatures and aerodynamic surface pressures. Approximately 200 measurements were required during the flight demonstration to verify and test subsystem performance. The design-measurements list was formulated on the philosophy that the

measurements would serve to meet flight-test requirements for design verification and would also provide data for research purposes.

## AIRBORNE INSTRUMENTATION

### Instrumentation Location

Figure 4 indicates the locations of surface-temperature and pressure-measuring instrumentation on the X-15. The wing measurements are concentrated in the right wing to provide sufficient coverage and still stay within the instrumentation space and weight limitations. Coverage on the nose area and the upper vertical tail is heavy. There is no instrumentation in the lower half of the vertical tail, since this portion of the fin is dropped before landing.

Instrumentation equipment is carried in compartments in the nose, just to the rear of the pilot, at the center of gravity between the fuel and oxidizer tanks, and in the tail section (fig. 5). The main instrumentation compartment is behind the pilot. All instrumentation wiring and tubing behind this compartment is routed through tunnels running along each side of the airplane. The main instrumentation compartment and the nose compartment are pressurized and temperature-controlled. The center-of-gravity compartment is temperature-controlled, and the tail compartment is insulated against high temperatures but not pressurized or temperature-regulated. This environmental control configuration was dictated by the types of instrumentation equipment installed in each compartment and the external environmental conditions of each compartment. Individual instruments and equipment are shock-mounted or hard-mounted, depending on the characteristics of each unit and the vibration and shock conditions at each location. Instrumentation equipment was designed and constructed for hard mounting wherever practicable to save weight and space.

### Instrumentation Design Considerations

The design and construction of the X-15 provided the aircraft designer with the task of designing new structures using previously untried materials and new systems capable of providing control where inertia forces were predominant. The task of the instrumentation engineers was equally, if not more, difficult. First, the instrumentation system had to be accurate and reliable, which meant, simply, that it had to be an in-being operational system at the start of the flight program. Secondly, it had to produce the required data in an environment where the sensors and wiring would be exposed to temperatures of the order of 1,200° F and atmospheric pressures as low as 0.05 lb/sq ft. Early in the instrumentation design phase, a number of problem areas were delineated that would necessitate development programs or would present difficult design tasks. It became obvious that the weight, volume, and power constraints placed on the instrumentation system would present a severe, if not insurmountable, problem. Measurement of angle of attack, angle of sideslip, dynamic and static pressure, velocity, altitude, and attitude would not be possible with available techniques and equipment. Structural temperatures and aerodynamic surface pressures, which are of prime importance, would be difficult to measure to the required accuracy and precision.

The selection of an instrumentation system which would meet the basic X-15 requirements and philosophy and continue to do so for 5 to 10 years required careful consideration of many factors in addition to reliability, accuracy, weight, volume, and power. Of concern were the cost, the design, fabrication, and test lead times, the capabilities of facilities and required operating personnel, the difficulty and probability of solving major problems, and the data-processing effort and time required to present the data in useful form to the flight-test and research engineers.

System design.- The instrumentation system selected is shown in block-diagram form in figure 6. The system, which relies on oscillographs and precision photographic recorders, was chosen for the following reasons: Most of the components were readily available from commercial sources or NASA stocks, which helped to keep costs within X-15 program funding levels. The lead times for designing, fabricating, and testing the components and systems were consistent with the requirement that the system be operationally ready at the beginning of the flight program. NASA instrumentation personnel were thoroughly familiar with the operating principles, service, and maintenance procedures and could be drawn from the NASA staff with a minimum of training, thus saving time and money. The difficulties of adapting, where necessary, the available techniques and equipment plus the probability of successfully accomplishing the required developments were again consistent with program schedules and costs. The time associated with processing the data from an oscillographic system, especially where masses of data are involved, was, and still is, long compared to the automatic techniques which can be used with magnetic-tape systems. This element was carefully analyzed, and it was concluded that the estimated number of data points required per flight (15,000) would not create processing times that would be detrimental to the planned flight schedules. This, coupled with the fact that during the 1956-57 period a costly, time-consuming development program would have been required to obtain a fully automatic magnetic-tape system, made the oscillographic system the choice from the data-processing standpoint. From the reliability and accuracy standpoint, the oscillographic systems had been proved in flight.

As shown in figure 6, aerodynamic surface pressures, linear accelerations along the aircraft body axes, and total pressure from the nose sensor are sensed and recorded on precision, NASA developed, electromechanical self-recording instruments. Outputs of angles of attack and sideslip from the nose

sensor are recorded on precision NASA recorders employing servo-repeater systems to position a light source on moving film. The attitude-angle outputs from the integrated inertial flight data system are recorded in similar fashion. All other measurements are sensed with electrical transducers. Signals are collected at a central patch panel in the main payload compartment, routed to appropriate signal conditioners, and then to the oscillographs and the telemetry set. The oscillographs are NASA developed, 36-channel units. The telemetry set consists of a 90-channel pulse-duration-modulation system that uses a low-level electronic commutator and an FM-FM system for telemetering pilot physiological data. A low-level mechanical commutator was used early in the flight program. Where required, parallel outputs from instrumentation signal conditioners are sent to the pilot's display instruments. Recording speeds can be varied from 1/4 in./sec to 4 in./sec, which gives recording times ranging from 56 minutes to 3.5 minutes using 70-foot film magazine loads. A blue-sensitive polyester-based thin film with the trade name of Cronar is used. Sixteen-millimeter motion-picture cameras (not shown in fig. 6) photograph portions of the pilot's panel and the wings and empennage during flight.

Air-data and attitude-angle measurement.- Measurement of angles of attack and sideslip and the pressures used to obtain airspeed and Mach number in the speed and altitude regime in which the X-15 operates is limited by the ability of any instrument to withstand the high stagnation temperatures and the low pressures and lags at high altitudes. Thus, conventional methods of measuring angle of attack and angle of sideslip using nose probes with self-aligning vanes were unusable on the X-15. Various means of determining these angles were investigated. The null-seeking nose sphere illustrated in figure 7, without its afterbody skin, was selected as the best method, considering the heat transfer, cooling, accuracy, and operational requirements. The feasibility of constructing such a device had been proved, and the components and materials



were available. The sensor and its supporting, sealing, and hydraulic-actuating mechanisms are designed as an integral assembly. The electronic amplifiers, power supplies, and control valves are mounted in the afterbody. The electric, hydraulic, and pneumatic connections between the sphere and the cone pass through a single central supporting member. Rotary hydraulic actuators provide the two degrees of freedom required. In operation, the sensor is a null-seeking, hydraulically actuated, electronically controlled servomechanism.

A block diagram of the servomechanization of one axis of the nose sensor is shown in figure 8. Two identical servos are used for independent control in each axis. The differential pressure between opposing orifices is measured, and the unbalance signal is fed through amplifiers to the hydraulic actuator. The actuator then positions the sphere to balance the differential pressures. A synchro transmitter is used to detect the position of the sphere with respect to the airframe, and this signal is fed to pilot's display instruments, a servorecorder to record the data, and to the telemetry link for ground monitoring. Since the dynamic pressure can vary between 1 lb/sq ft and 2,500 lb/sq ft, compensation is required in the servo loop to maintain stability and accuracy. This compensation is provided by measuring the pressure difference between the total-pressure port and one angle-sensing port. The resulting signal is used to adjust the gain of the sphere-positioning loop.

The angle-of-attack range of the sensor is from  $-10^{\circ}$  to  $40^{\circ}$ ; the angle-of-sideslip range is  $\pm 20^{\circ}$ . The unit is capable of continuous operation at a skin temperature of  $1,200^{\circ}$  F. Response is flat to about 6 cycles per second with a maximum velocity limit of about 85 deg/sec. The sensor weighs 78 pounds and is 16  $3/4$  inches long. The sphere diameter is 6  $1/2$  inches, and the base diameter is 13  $3/4$  inches.

Figure 9 is a comparison of theoretical and actual angle-of-attack measurements at low dynamic pressures. The theoretical angle-of-attack error (solid

curve) was obtained by comparing angle of attack computed from wind-tunnel and analytical data available for the sensor and angle of attack computed from flight measurements of pitch attitude obtained from the integrated flight data system and flight-path angle obtained with the precision tracking radar. The actual angle-of-attack error was obtained by comparing flight measurements of angle of attack from the sensor and angle of attack computed from the same inertial and radar data. Actual measurements of angle-of-attack error are shown by the solid symbols. The shaded area represents uncertainty in the computation of angle of attack from inertial and radar data. The maximum difference is  $3/4^\circ$  at a dynamic pressure 3.5 lb/sq ft.

Although it was possible to measure total pressure with the nose sensor, the lack of a suitable location on the X-15 for a static-pressure port plus difficulties in sensing and recording the low static pressures led to the selection of a gyro-stabilized inertial reference to provide a source of velocity and altitude data. As a result, and because of the need for measuring true attitude angles, an integrated inertial flight data system (IFDS) was developed. A block diagram of the system is shown in figure 10. The IFDS is basically an earth-slaved, schuler-tuned system alined in azimuth to an equivalent guidance equator which is coincident with the radar-range centerline of the X-15. The stabilizer utilizes three self-balancing accelerometers and three single-degree-of-freedom gyroscopes. A four-gimbal system provides complete attitude freedom in all axes. A direct-current analog computer is used for computing velocity and position data and the necessary acceleration corrections. Attitude angles are picked directly off the gimbals by means of synchro transmitters. A Doppler radar is used as a velocity reference for alinement to the vertical during prelaunch flight. A gyro compass is used for a heading reference. The altitude loop is stabilized by setting in the ground g-condition before takeoff and refining the setting to correct for variation with altitude

until just before launch, when the final setting is made. A control panel in the B-52 launch aircraft aids in monitoring the alinement process and in making minor adjustments during carried flight.

The inertial system provides the measurements shown in the table below. The accuracies selected represent a compromise between the data desired, the X-15 weight and size restrictions, and the inertial state of the art in the 1956-57 period. The eight desired measurements may be classified into three groups: (1) attitude angles, (2) altitude, and (3) velocities. The four velocities are the scalar total or "trajectory" velocity and the three component velocity vectors: the downrange velocity, the crossrange velocity, and the vertical velocity. The downrange and crossrange velocity vectors coincide with the velocity data obtainable from the ground radars.

Measurement specifications (Time duration: 300 sec)		
Measurements required	Range	Accuracy (rms)
Attitude angles, deg	Unlimited	0.5
Altitude, ft	0 to 500,000*	5,000
Velocity, ft/sec		
Total	±7,000*	70
Downrange	±7,000	50
Crossrange	±3,000	50
Vertical	±5,000*	20

\*Required for pilot displays.

Figure 11 is a photograph of the direct-current analog computer and the stabilizer, with covers off. Both units are mounted in the main payload compartment. The stabilizer is mounted on a specially constructed vibration isolator which minimizes attitude changes of the instrument with respect to the

aircraft. The computer is shock-mounted and is shaped to conform to the contours of the payload compartment. Both units are cooled with cold nitrogen gas to counteract the heat generated by the electrical equipment within the units and heat inputs to the compartment during high Mach number flights.

The X-15 inertial-flight-data-system outputs are compared with radar data in figure 12. Good correlation is evident for the total-velocity data, and the altitude curve illustrates the altitude-loop divergence with time that is typical of inertial-guidance systems. This divergence has posed no problem, inasmuch as inertial altitude data are not required for final space position and the landing approach.

Aerodynamic-heating measurements.- As indicated previously, one of the primary goals of the X-15 program was to further knowledge of aerodynamic-heating phenomena. This study on the X-15 is divided into two general research measurement categories: (1) study of structural temperatures, including skin temperatures, and (2) measurement of heat-transfer rates to the airplane. During the instrumentation design phase, it soon became apparent that the only feasible method available for making these measurements involved the use of thermocouples attached to the skin and internal structure plus the use of surface pressure measurements to determine local flow conditions. The use of thermocouples on the X-15 required considerable development and test work to obtain suitable thermocouple materials, to devise a recording scheme that would allow a great number of thermocouple outputs to be recorded on each flight, and, finally, to decide upon a thermocouple-attachment method that would provide protection for the thermocouple during periods of high temperature and high vibration. In addition, the thermocouples would be inaccessible after the airplane was constructed; hence, the installation would need to be long-lived with little or no maintenance.

Figure 13 illustrates the installation of a typical structural thermocouple. The thermocouple material selected was 30-gage chromel-alumel. The 30-gage leads are spot-welded to the structure and routed to 20-gage thermocouple extension leads. The use of 20-gage extension leads to the signal conditioning, reference junction, and recording equipment was necessary to reduce circuit resistance in the thermocouple loops and to minimize measurement errors due to resistance changes caused by large temperature variations along the wire. The thermocouple leads are insulated from each other by silicone-impregnated Fiberglas braid. Outer insulation is the same. Where the thermocouple leads are close to hot skin or other structure, an outer sleeve of unimpregnated Fiberglas sleeving gives additional protection. The length of thermocouple lead enclosed in the sleeving is held firmly to the member by wire tiedowns spot-welded to the member to minimize vibration and shock damage to the insulation. The silicone impregnation gives strength to the Fiberglas insulation, thus allowing it to withstand the stresses of installation. The impregnation eventually sublimates during repeated exposure to elevated temperatures but maintains its electrical insulating properties. Tests indicated that this gassing-off process could result in an explosion if the sample were suddenly brought to 1,200° F. The hazard was eliminated on the X-15 by a gradual buildup to maximum Mach number (1,200° F) during the course of the program.

An internal view of a typical X-15 skin thermocouple and surface-pressure-report installation is shown in figure 14. The surface-pressure orifices are fixed in place by a simple clamp designed to prevent any relative movement between the orifice and wing skin. Tubing of 1/4-inch inner diameter, 0.025-inch wall thickness, fabricated of seamless Inconel and stainless steel is used to route the sensed pressure to the NASA precision pressure recorders in the instrument compartments. These tubing materials were utilized to provide strength at high temperatures. The inner diameter and wall thickness were

chosen as a compromise which would result in minimum pressure lag and minimum space and weight.

Figure 15 is a view of the thermocouple signal conditioner. The conditioner consists of a mechanical commutator capable of switching a total of 480 thermocouples onto 12 oscillograph channels at a rate of 40 per channel per second, the thermocouple reference junction, and the necessary in-flight zero and calibration provisions. The thermocouple reference junctions are maintained at constant temperature.

Data from a typical X-15 heat-transfer flight are shown in figure 16. Three thermocouple outputs are compared with calculated temperatures; good correlation is evident for all three locations. The divergence of measured and calculated data for the spar-web thermocouple illustrates the difficulty in correlating theoretical calculations and measured structural temperature data.

## GROUND INSTRUMENTATION

### Ground Range

One of the basic instrumentation requirements for a highly experimental program such as the X-15 is a well-instrumented ground range. The ground range for the X-15 is shown in figure 17 in relation to a typical X-15 mission. The range is required to perform the following specific functions during an X-15 flight:

Aid in the initial guidance and vectoring of the B-52 launch airplane to the required heading.

Monitor the initial climb of the X-15 airplane.

Provide a backup for altitude and velocity information to the pilot in the event of on-board equipment failure.

Monitor the flight path as an aid in homing or vectoring to a suitable intermediate emergency landing area, if required.

Provide -

Information for escort airplane rendezvous.

Final approach and landing information to the pilot.

Reliable long-range communications capability.

A real-time data-monitoring capability.

Accurate space-trajectory data for research purposes.

To meet these requirements, a ground range was constructed consisting of three stations: a main terminal station in the NASA Flight Research Center at Edwards, Calif., and two up-range stations, one in the vicinity of Beatty, Nev., the other near Ely, Nev. Many considerations entered into the choice of the specific locations for the up-range sites, including required radar overlap capabilities, the power balance in the radar-to-beacon loop, the requirement of a maximum omnidirectional seeing angle, and the overall logistic problem. The locations and elevations of the sites are such that omnidirectional tracking can be accomplished down to an altitude of 10,000 feet.

A functional diagram of the X-15 range is shown in figure 18. The radar system includes the radars and all auxiliary equipment necessary to provide sequential tracking of the test aircraft by the three stations from one end of the range to the other. The radar is an automatic angle and range tracking unit designed to provide accurate azimuth and elevation angle and slant range data. These units operate in "S" band and have a 400-mile ranging circuit capability. The radar may be positioned by means of a remote optical tracker or by computed analog data from the radar data-acquisition system. These remote inputs are used for target acquisition and as tracking aids.

A precision data-recording system operates in conjunction with the radar to permit continuous visual monitoring of target space position (azimuth, elevation, and range) and real time of day, and provides photographic and magnetic-tape recordings of the target position and time of day. An 80-inch

focal length boresight camera associated with the system permits photography of the airborne target at limited ranges. Tracking information in the form of azimuth, elevation, and range is obtained from two optical digital encoders and one electromechanical encoder (range) which are attached directly to the radar antenna and range shafts. Digital information from the encoders is recorded on magnetic tape and constitutes the primary information obtained from the radar system. In addition to the tape recorder, a data camera is included for backup purposes. The camera photographs the same digital information as recorded on the magnetic tape and selsyn dial indications of azimuth, elevation, and range for coarse trajectory information.

Radar data are transmitted between stations for plotting purposes as well as for radar pre-position inputs to aid in sequential tracking of the X-15 over the entire range. Analog voltages representing space position and velocity are converted to digital form and transmitted by either telephone lines or microwave to the next station on the range.

The telemetry ground-receiving, conditioning, and recording equipments are a standard 18-channel FM-FM system and a pulse-duration-modulation system capable of receiving up to 90 channels of information. Reliable reception is achieved through use of a servo-driven cross-dipole tracking antenna. The antenna can be controlled by synchro data from the tracking radar so that the telemetry antenna automatically tracks the target. Complete data from both the FM-FM and pulse-duration-modulation stations are recorded on magnetic tape. Telemetry data from the up-range stations, Beatty and Ely, are transmitted via microwave to the main terminal station at Edwards, recorded on magnetic tape, and displayed in real time.

Voice communications with the X-15 is accomplished by means of standard military UHF ground equipment. Communication with support aircraft and ground vehicles is accomplished through the use of UHF equipment and single-sideband high-frequency equipment. When a UHF transmitter, or transmitters, is keyed at



any range station, transmitters at the other two stations are keyed by means of signals sent over the microwave or telephone lines, so that the same information is transmitted simultaneously by all three stations. Conversely, UHF receivers at all three stations feed their outputs into the microwave or hardlines so that the information is received and heard at all stations. Undesirable beat frequencies, which may be caused by transmitter carrier drift, are eliminated by offsetting the carrier frequencies of the transmitters at each of the three stations. A station-to-station intercommunications system utilizing the microwave and telephone lines is available for range administrative and control purposes.

A timing system furnishes precise timing reference signals to the three stations for the purpose of correlating data recorded by the various instrumentation facilities at the individual sites. The timing reference signals are transmitted by telephone lines.

Figure 19 is a photograph of the X-15 ground control room in the main terminal station at Edwards. In this room are the radar plotting boards and the monitor consoles at which engineers responsible for each subsystem in the X-15 may monitor critical parameters in real time. These displays take the form of oscilloscope bar charts for limit displays, meter presentations, and strip-chart time histories.

#### Flight Simulator

A major role in the X-15 ground instrumentation complex has been played by the X-15 analog flight simulator (fig. 20). The simulator consists of an electronic analog computer to solve the equations of motion in six degrees of freedom and a fixed-base cockpit and control-system mockup. The simulator is used for detailed trajectory planning, pilot training for normal and emergency conditions, exploration of critical stability and control areas, extrapolation

of actual X-15 characteristics to unexplored areas, and investigation into effects of proposed modifications to the X-15 systems or configuration.

A block diagram of the analog simulator is shown in figure 21. The cockpit simulator duplicates, as closely as possible, every detail of the X-15 cockpit, including instrumentation and controls. The hydraulic control system has been mechanized to duplicate the actual hydraulic links and pressure and flow rates, as well as the mass characteristics and natural frequencies of the X-15 horizontal tail. Control-system nonlinearities are also closely duplicated.

Two stability augmentation systems are used on the X-15 airplane, as shown in figure 21. One is a fixed but selectable gain system (SAS) and the other, adaptive or variable gain. These systems are included on the simulator through the use of actual vehicle systems electronic units and are made compatible with the computer with signal-conditioning elements. The simulator also includes a malfunction generator which simulates the major systems failures that might occur in flight. Simulated failures of any of the major X-15 cockpit instruments or 23 possible systems failures are indicated in the simulator cockpit by lights.

The data obtained from the airborne recorders are processed at the Flight Research Center with an IBM 704 computer. The raw data on the oscillograph and photorecorder films are transferred to IBM punched cards by using manually operated film readers. Computer input tapes are then prepared. Magnetic tapes from the range stations are processed automatically by the digital data-processing unit of the U.S. Air Force at Edwards. Radar tapes are converted to IBM computer input tapes from which geometric altitude, plan position, trajectory position, and velocity are obtained and used for research analysis, comparison with data derived from the inertial data system, and operational analysis of radar performance. Telemetry tapes may be played back on the

Edwards ground station for quick-look purposes or processed by the Air Force unit for more precise results.

#### OPERATIONAL EXPERIENCE

Since the start of the X-15 flight program in the spring of 1959, the airplane has flown to slightly over Mach 6 and exceeded an altitude of 350,000 feet. The rigors imposed upon the airborne instrumentation components and systems by sustained operations in the envelope bounded by these limits have demonstrated that the philosophy adopted to meet the program instrumentation requirements was adequate. The reliability of the three major X-15 instrumentation systems is indicated in the following table:

System	Flights	Data	Reliability, percent
Airborne data acquisition	100	Acceptable	97
NASA hypersonic nose sensor	70	$\alpha$ , $\beta$ , $p'$ acceptable	98
Integrated inertial flight data	89	Acceptable	84

As shown in the table, the airborne data-acquisition system has fulfilled all the requirements imposed upon it. The reliability of the system was calculated by dividing the total number of usable data channels by the total number of required data channels for 100 flights of the three X-15 aircraft. This percentage includes the data-recording equipment and display for the inertial flight data system and the nose sensor.

No major performance problems have been encountered with the airborne data-acquisition system. The sensor installations in hot areas of the aircraft have met design objectives and have withstood the high temperatures and

vibration levels encountered. It has not been possible to stay within the original weight constraint imposed on the system; the total weight of the system including the nose sensor and inertial system is 1,400 pounds. The data-processing problem has developed as anticipated. Although the method used is not satisfactory in the light of today's state of the art, it has fulfilled program requirements. The number of data points processed per flight has averaged between 8,000 to 10,000, and tabulated data have been given to the flight-test engineers approximately one week after flight. The most difficult task encountered in processing the data from the airborne system was in transferring the thermocouple data from the oscillograph film to punched IBM cards. At first this was a time-consuming, tedious job but as operator proficiency increased the time required was reduced to acceptable levels.

The NASA hypersonic nose sensor has had a remarkable reliability record. Of the 70 flights on which the sensor has been used, it operated marginally on only 1 flight.

The integrated inertial flight data system has been used in 89 X-15 flights. The reliability shown in the preceding table indicates the approximate overall reliability of the system. This percentage is based on the number of times the system has caused a major delay in a scheduled flight, an in-flight abort prior to launch, or has failed during flight. The system, however, has not been able to perform consistently within the performance specifications set in 1956. In retrospect, the performance specifications established at that time were beyond the capabilities of the state of the art with respect to available gyros, accelerometers, transistors, and circuit techniques. However, the system has been able to perform at levels which, although marginal or subpar in regard to the specifications, have enabled the full performance capabilities of the X-15 to be realized. Continued development, through hardware modifications as new circuit techniques, electronic components, and improved gyros

became available, plus refinements to operational and quality-control procedures have steadily improved the system as the flight program has progressed. A new system, based upon technology and hardware developed by the U.S. Air Force for the X-20 program, is being procured to replace the present system.

#### FOLLOW-ON PROGRAM

The X-15 flight program is at the stage where much of the flight research required to satisfy the original goals has been achieved. The three X-15 airplanes are now embarked in a follow-on program for flight testing scientific instruments, propulsion systems, and advanced flight data and energy management systems, and for studies of the atmosphere and advanced structures research. Included in these tests are: ultraviolet stellar photography, ultraviolet and infrared exhaust-plume observation, horizon definition, optical-degradation measurements, high-temperature-window evaluations, high-temperature leading-edge studies, atmospheric-density measurements, micrometeorite collection, and evaluations of an advanced integrated flight data system, energy management, vapor-cycle cooling, and airbreathing propulsion systems. The data-acquisition system used during the basic program will support these tests.

#### CONCLUDING REMARKS

Many valuable instrumentation lessons applicable to future vehicles have been learned from the X-15 program. Among the most important are the following:

The oscillographic data-acquisition system used in the X-15 represents about the ultimate in the application of this type of system in regard to number of channels, weight per channel, accuracy, and the data-processing task. Although the system has done its job, if the same ground rules were used today as in 1957, a digital, magnetic-tape system with automatic data processing would be selected.

A system such as an FM-FM magnetic-tape recording system for the measurement of dynamic phenomena such as flutter, vibration, and acoustic noise should always be included in the original instrumentation layout on a vehicle such as the X-15. This recorder was found to be a necessary addition to the X-15 data-acquisition system during the flight program.

The necessity for flight testing of complex, new instrument systems before they are required to produce data on a flight program similar to the X-15 is imperative in order to build confidence and discover deficiencies early enough for corrective measures to be applied. This was amply demonstrated by the X-15 inertial system, which was inadequately flight tested before its use was required.

Low-level, low-speed electronic commutators have proved to be reliable on X-15 flights, obviating the need for using low-level, mechanical commutators with their attendant contact noise and maintenance problems.

SYMBOLS

$h$	altitude, ft
$M$	Mach number
$P_1, P_2$	surface pressure, nose sphere, lb/sq ft
$\Delta P$	differential pressure, lb/sq ft
$p'$	total pressure, lb/sq ft
$p_s$	static pressure, lb/sq ft
$q$	dynamic pressure, lb/sq ft
$t$	time, sec
$\dot{u}, \dot{v}, \dot{w}$	acceleration along X, Y, and Z body axes, respectively, g units
$V$	total scalar velocity (inertial), ft/sec
$V_r$	downrange velocity (inertial), ft/sec
$V_v$	vertical velocity (inertial), ft/sec
$V_y$	crossrange velocity (inertial), ft/sec
$\alpha$	angle of attack, deg
$\Delta\alpha$	angle-of-attack error, deg
$\beta$	angle of sideslip, deg
$\gamma$	flight-path angle, deg
$\theta$	angle of pitch, deg
$\phi$	angle of roll, deg
$\psi$	angle of yaw, deg

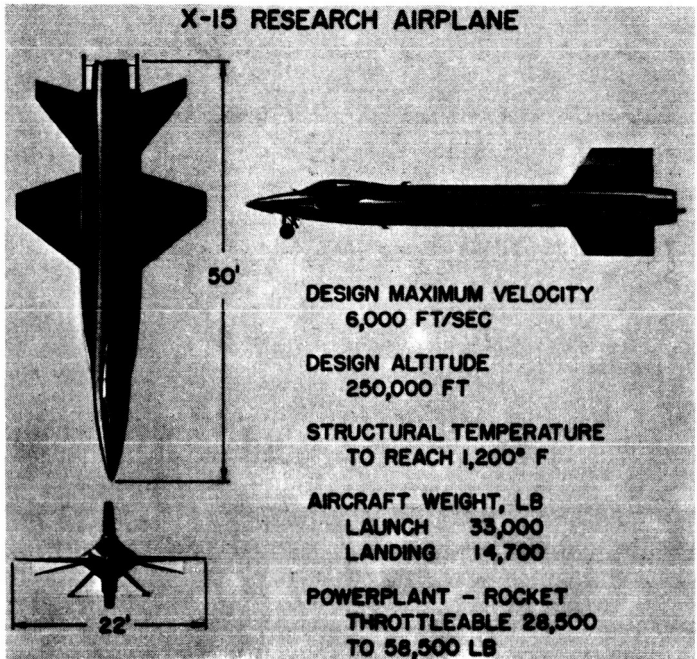

Figure 1

### X-15 PERFORMANCE ENVELOPE

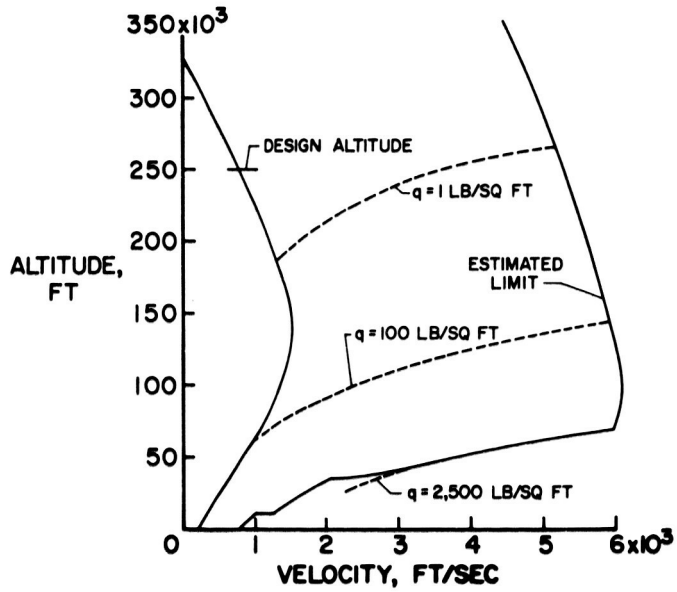

Figure 2



# TYPICAL X-15 MISSIONS

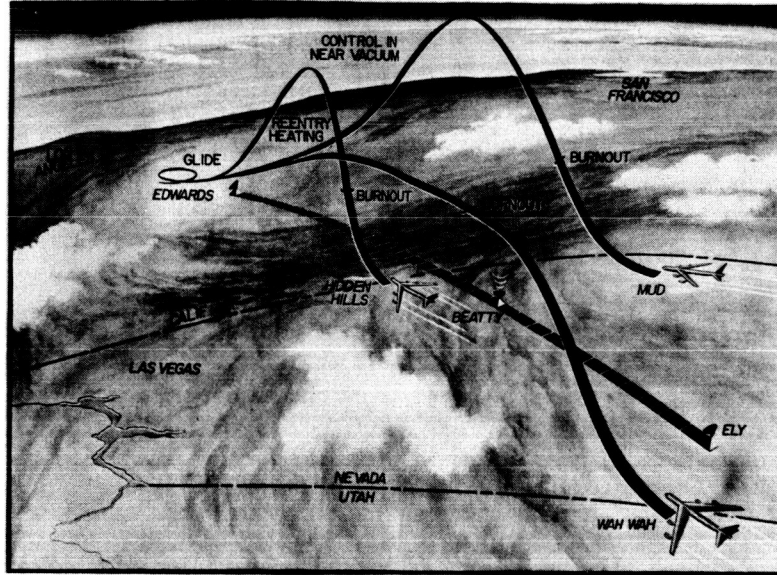

Figure 3

# X-15 AIRPLANE SURFACE INSTRUMENTATION

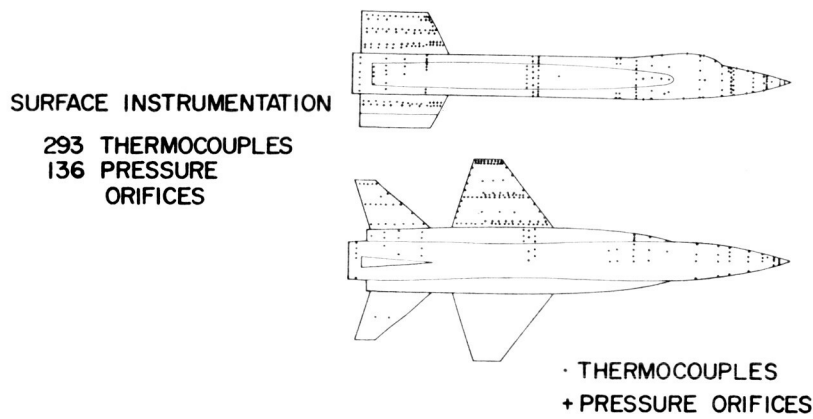

Figure 4

# X-15 INSTRUMENT COMPARTMENTS

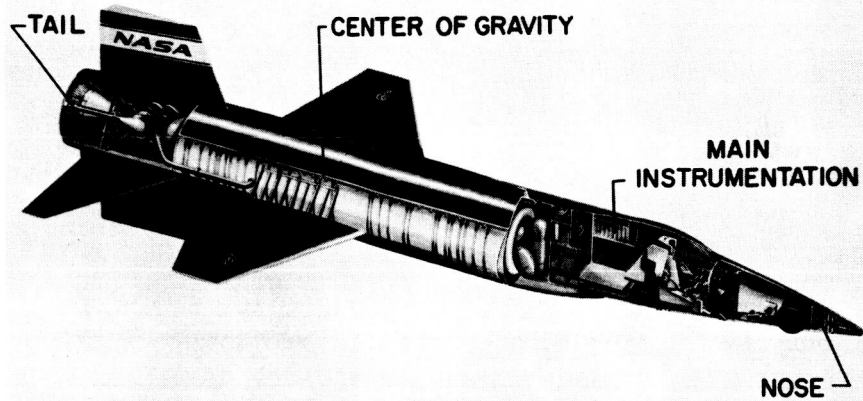

Figure 5

## X-15 INSTRUMENTATION SYSTEM

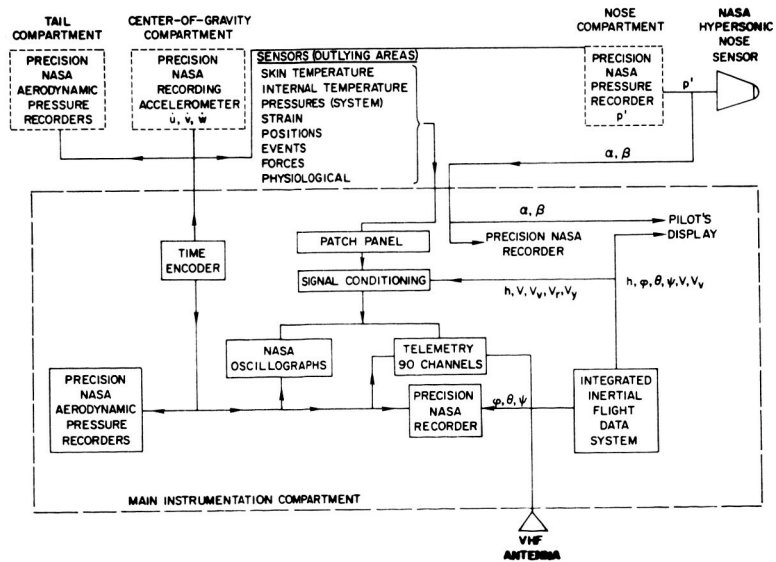

Figure 6

# NASA SENSOR INSTALLED ON THE X-15 AFT CONE REMOVED

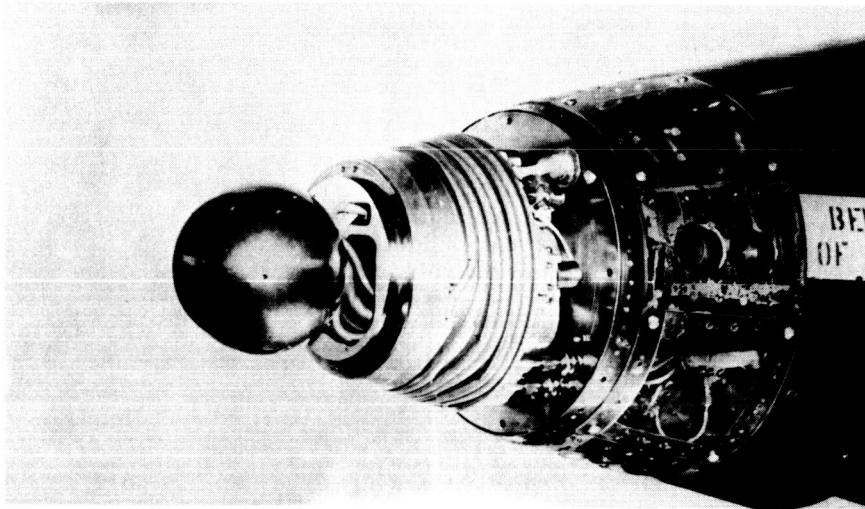

Figure 7

## SENSOR MECHANIZATION $\alpha$ OR $\beta$ AXIS

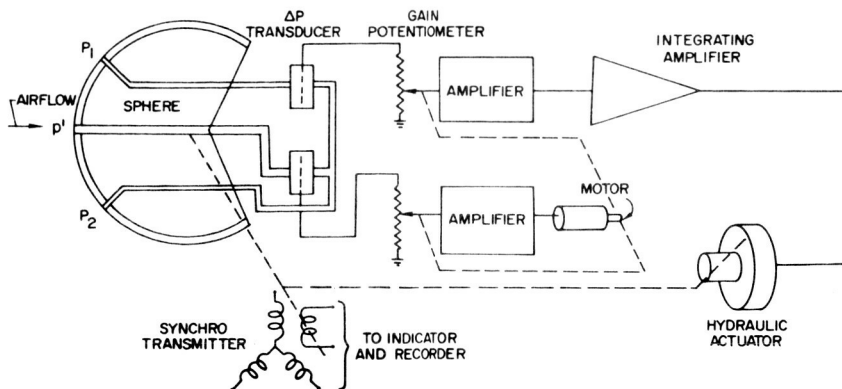

Figure 8

## COMPARISON OF ANGLE-OF-ATTACK MEASUREMENTS AT LOW DYNAMIC PRESSURE

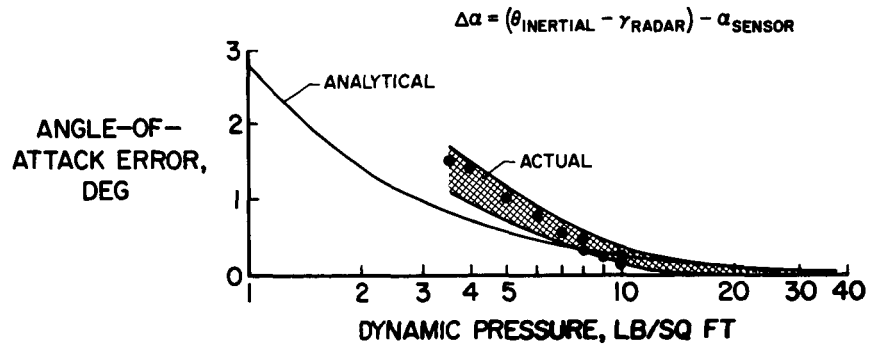

Figure 9

## INTEGRATED INERTIAL FLIGHT DATA SYSTEM

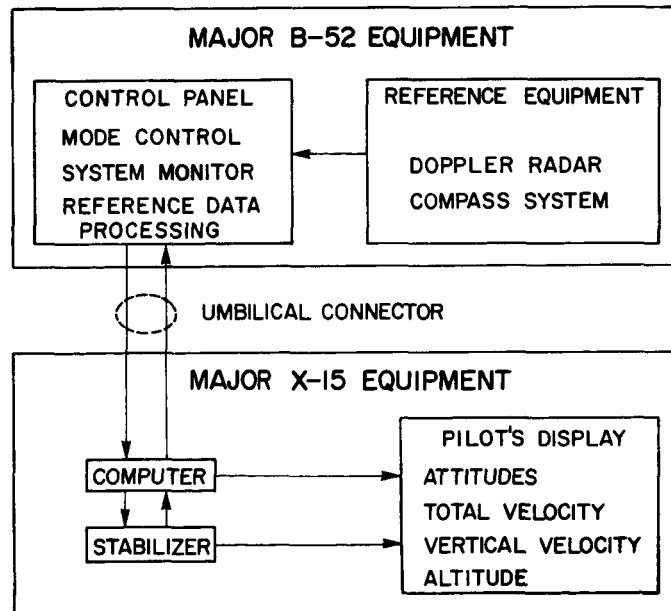

Figure 10

# IFDS COMPUTER AND STABILIZER

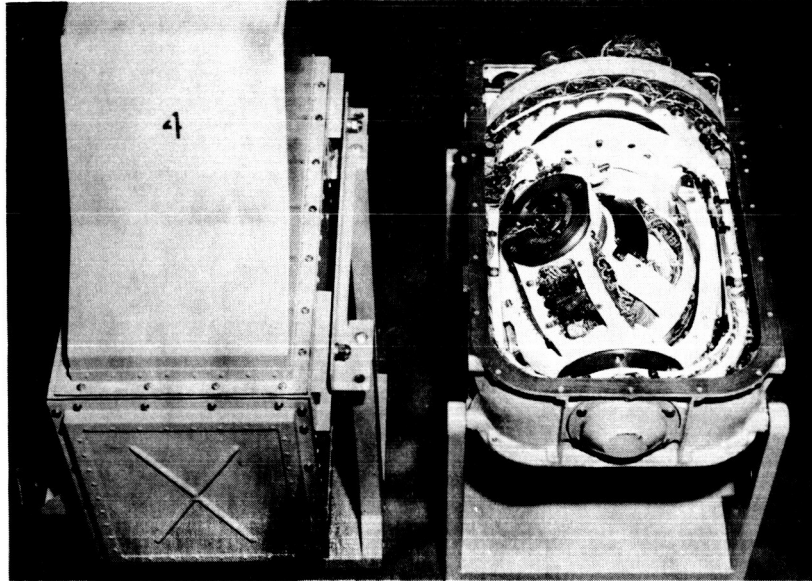

Figure 11

## CHARACTERISTICS OF INERTIAL FLIGHT DATA SYSTEM

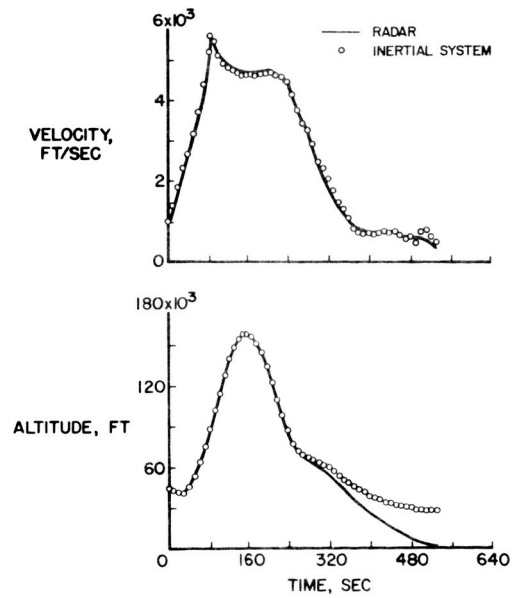

Figure 12

### X-15 SKIN THERMOCOUPLE INSTALLATION

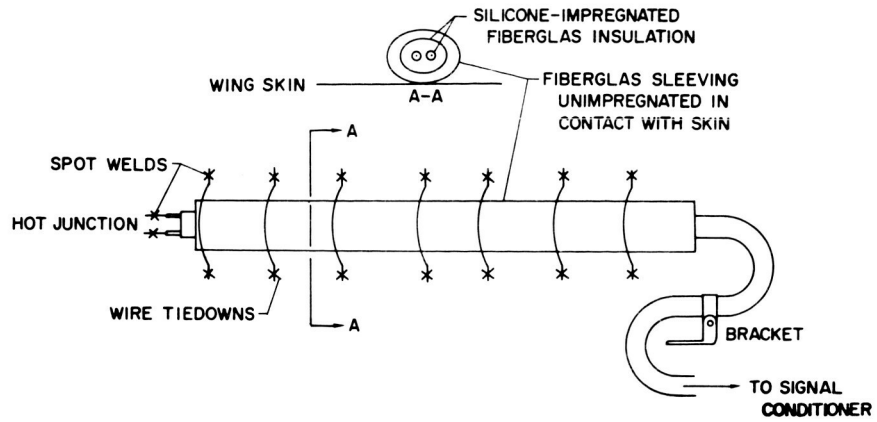

Figure 13

### TYPICAL X-15 THERMOCOUPLE AND PRESSURE-PORT INSTALLATION

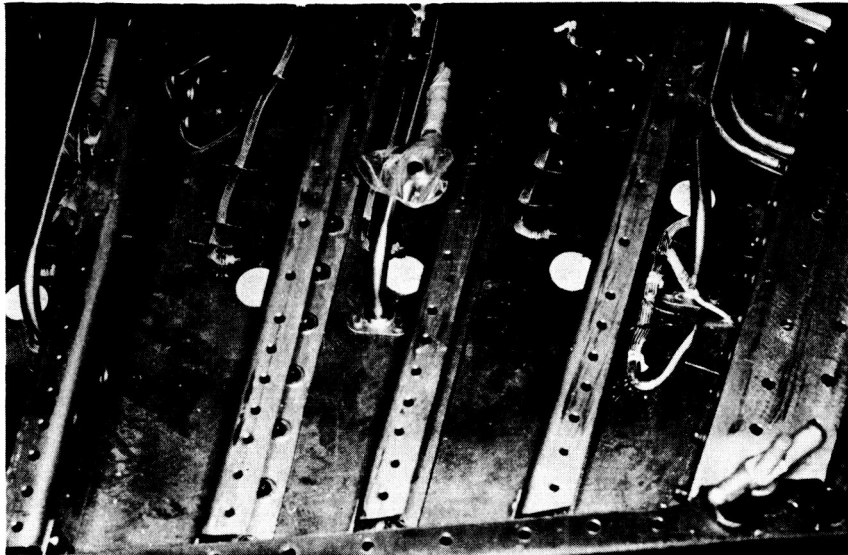

Figure 14

# X-15 THERMOCOUPLE SIGNAL CONDITIONER

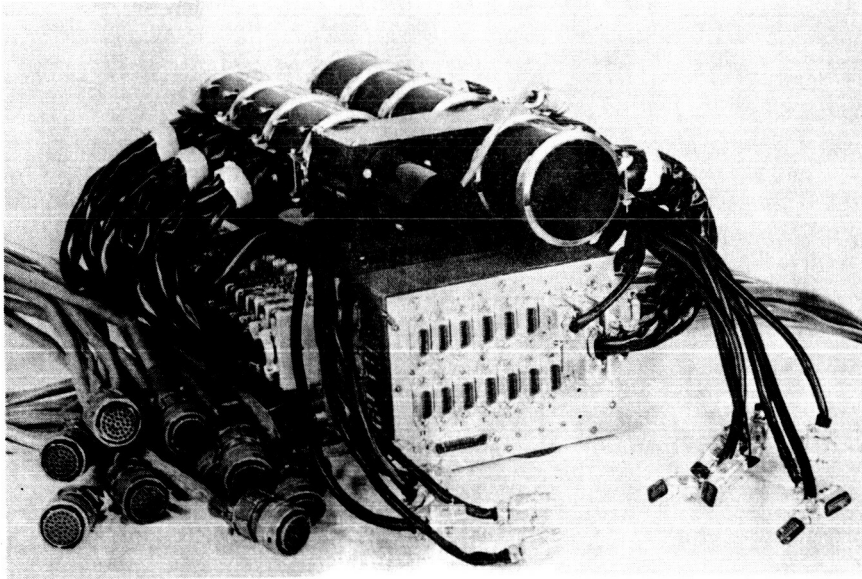

Figure 15

## COMPARISON OF CALCULATED AND MEASURED TEMPERATURES HEAT-TRANSFER FLIGHT

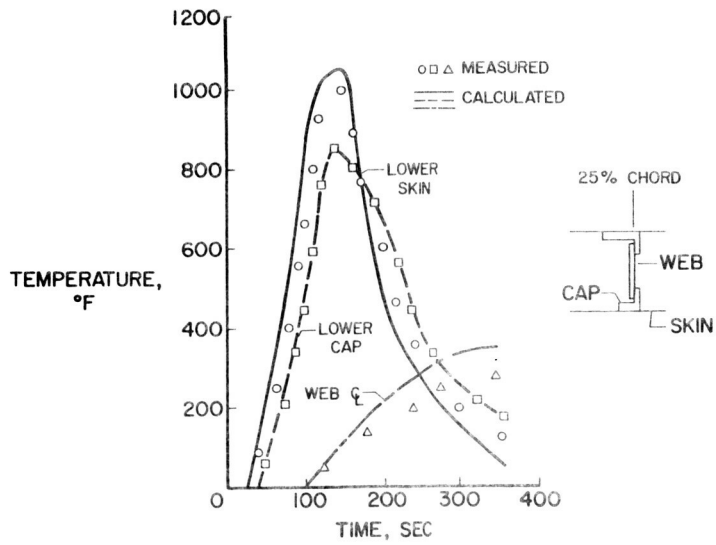

Figure 16

# TYPICAL X-15 RESEARCH MISSION

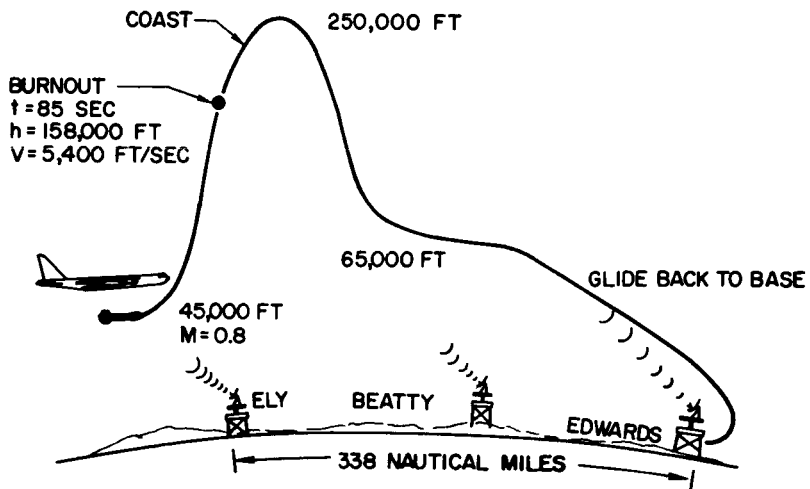

Figure 17

## RANGE FUNCTIONAL DIAGRAM

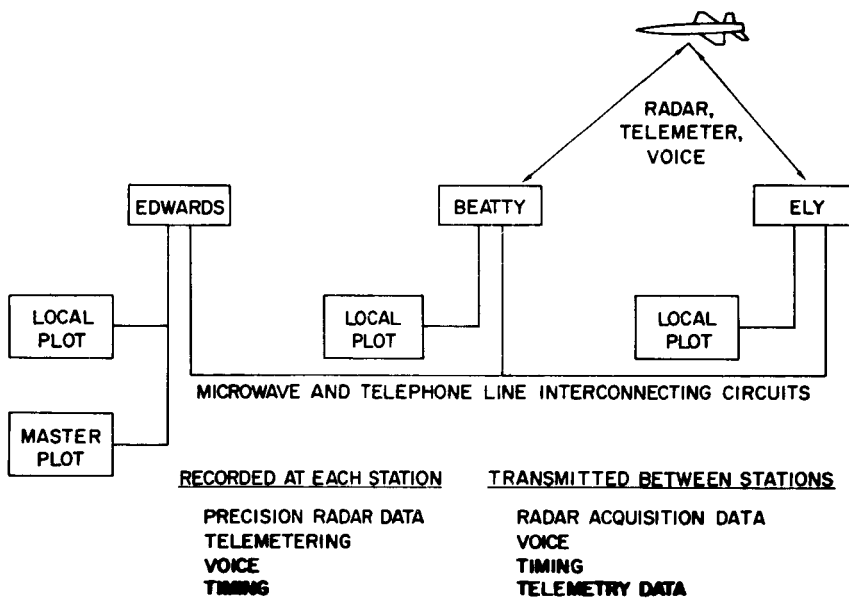

Figure 18



## X-15 GROUND CONTROL STATION AT FRC

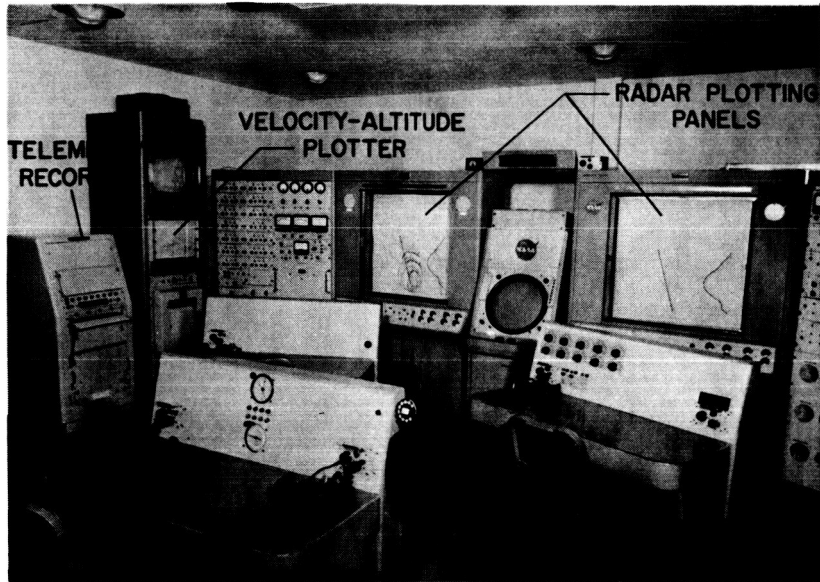
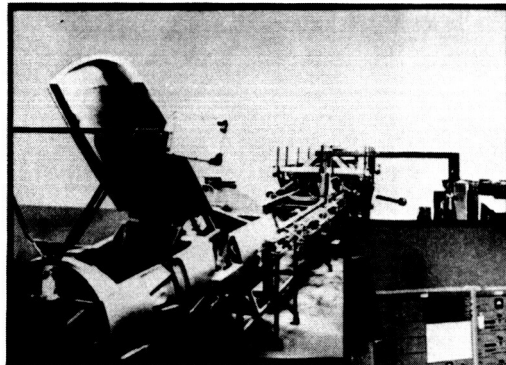

Figure 19

## FIXED-BASE SIMULATOR



### AIRPLANE MOCKUP

- COMPLETE COCKPIT
- ACTUAL HARDWARE CONTROL SYSTEM
- ACTUAL ELECTRONIC SAS
- SIMULATED CONTROL SURFACES

### COMPUTING EQUIPMENT

- 3 MODEL 231R EA ANALOG COMPUTERS
- 92 DIODE FUNCTION GENERATORS
- 33 COMPUTING SERVOS
- 5 ELECTRONIC MULTIPLIERS

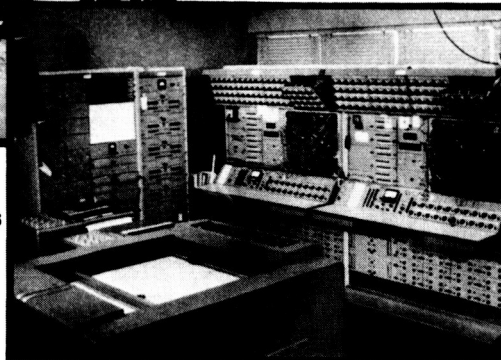

Figure 20

# ANALOG-SIMULATOR DIAGRAM

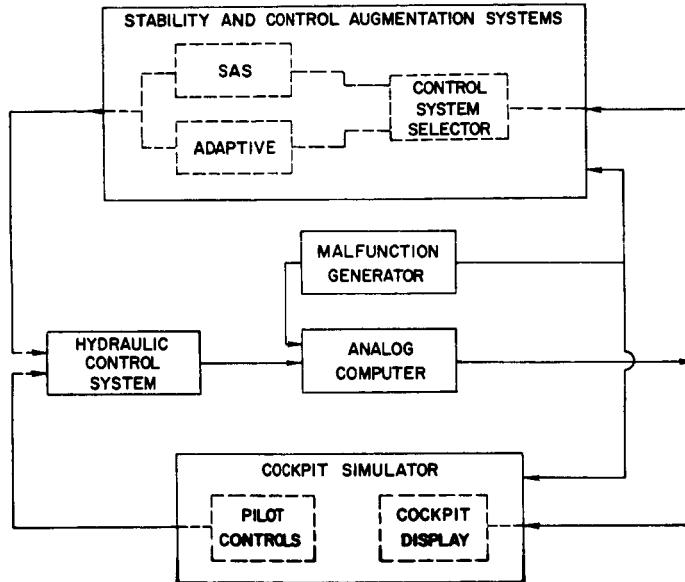

Figure 21