

**NASA TECHNICAL
MEMORANDUM**

NASA TM X-53308

August 2, 1965

NASA TM X-53308

FACILITY FORM 602	N65-31188	
	(ACCESSION NUMBER)	(THRU)
	87	1
	(PAGES)	(CODE)
	TMX-53308	31
	(NASA CR OR TMX OR AD NUMBER)	(CATEGORY)

SA-8 FLIGHT TEST DATA REPORT

by H. J. WEICHEL
Aero-Astrodynamics Laboratory

GPO PRICE \$ 5.00
CFSTI PRICE(S) \$ 3.00

Hard copy (HC) \$10.25
Microfiche (MF) \$10.25

NASA

*George C. Marshall
Space Flight Center,
Huntsville, Alabama*

ff 653 July 65

TECHNICAL MEMORANDUM X-53308

SA-8 FLIGHT TEST DATA REPORT

By

H. J. Weichel

George C. Marshall Space Flight Center

Huntsville, Alabama

ABSTRACT

31188

This report is a presentation of certain flight mechanical data obtained from the SA-8 flight test. Digitized data are presented in graphical form. Also included are schematic drawings showing the instrument location on the vehicle.

The intention of this report is to present the digitized data in an easy-to-read form for use by design and technical personnel. This report is to supplement the Saturn SA-8 Flight Evaluation Report and many other reports published by the various laboratories. *Author*

NASA-GEORGE C. MARSHALL SPACE FLIGHT CENTER

NASA - GEORGE C. MARSHALL SPACE FLIGHT CENTER

TECHNICAL MEMORANDUM X- 53308

SA-8 FLIGHT TEST DATA REPORT

By

H. J. Weichel

AERO-ASTRODYNAMICS LABORATORY
RESEARCH AND DEVELOPMENT OPERATIONS

ACKNOWLEDGEMENT

Mr. Leroy Neece, Data Reduction Branch, NASA Computation Laboratory responsible for the S. C. 4020 data plots.

Mr. Bob Gray, Brown Engineering, prepared the illustrations.

All inquiries concerning this report should be directed to R-AERO-FFD (876-5649).

LIST OF ILLUSTRATIONS

	Page
I. Wind Components	
1. Pitch Plane Wind Components.....	18-19
2. Yaw Plane Wind Components.....	20-21
II. Attitude	
1. S-I Stage	
a. Tilt Program and Pitch Velocity Vector Angle.....	22-23
b. Guidance Commands.....	24
c. Attitude Angles (ST-124)	
(1) Schematic of Measurement Locations.....	5
(2) Digitized Data.....	26-27
d. Angular Velocities (Control Rate Gyros)	
(1) Schematic of Measurements Locations.....	6
(2) Digitized Data.....	28-29
e. Angular Velocities (Tail Section)	
(1) Schematic of Measurement Locations.....	7
(2) Digitized Data.....	30-31
2. S-IV Stage	
a. Steering Command and Pitch Velocity Vector Angle.....	56-57
b. Guidance Commands.....	58-59
c. Attitude Angles (ST-124)	
(1) Schematic of Measurement Locations.....	5
(2) Digitized Data.....	60-61
d. Angular Velocities (Control Rate Gyros)	
(1) Schematic of Measurement Locations.....	6
(2) Digitized Data.....	62-63
3. Orbital	
a. Angular Velocities (Control Rate Gyros)	
(1) Digitized Data.....	78-79
III. Angles of Attack	
1. Nose Cape Differential Pressure Measurements	
a. Schematic of Measurements Locations.....	8
b. Digitized Data.....	32-33

LIST OF ILLUSTRATIONS (CONT'D)

	Page
2. Free-Stream Angles of Attack	
a. Pitch Free-Stream Angles of Attack.....	34-35
b. Yaw Free-Stream Angles of Attack.....	36-37
IV. Actuator Positions	
1. S-I Stage	
a. Pitch Actuators	
(1) Schematic of Measurement Locations.....	9
(2) Digitized Data.....	38-41
b. Yaw Actuators	
(1) Schematic of Measurement Location.....	10
(2) Digitized Data.....	42-45
c. Average Flight Plane Actuator Positions.....	46-47
d. Actuator Position Filtered At Slosh Frequency.....	25
2. S-IV Stage	
a. Pitch Actuators	
(1) Schematic of Measurement Locations.....	14
(2) Digitized Data.....	64-67
b. Yaw Actuators	
(1) Schematic of Measurement Locations.....	15
(2) Digitized Data.....	68-71
c. Engine 5 and 6	
(1) Schematic of Measurement Locations.....	16
(2) Digitized Data.....	72-75
d. Average Flight Plane Actuator Positions.....	76-77
V. Linear Accelerations	
a. Schematic of Measurement Locations.....	11
b. Digitized Data (Filtered).....	48-49
c. Digitized Data (Translated to C. G.).....	50-51

LIST OF ILLUSTRATIONS (CONT'D)

	Page
VI. Vibrations	
1. Pitch Plane	
a. Schematic of Measurement Locations.....	12
b. Digitized Data.....	52-53
2. Yaw Plane	
a. Schematic of Measurement Locations.....	13
b. Digitized Data.....	54-55

TECHNICAL MEMORANDUM X-53308

SA-8 FLIGHT TEST DATA REPORT

SUMMARY

This report is a presentation of certain flight mechanical data obtained from the SA-8 flight test. Digitized data are presented in graphical form. Also included are schematic drawings showing the instrument location on the vehicle.

This report presents digitized data in an easy-to-read form for use by design and technical personnel and supplements the Saturn SA-8 Flight Evaluation Report and many other reports published by the various laboratories.

INTRODUCTION

Included in this report is information concerning the transducers, accelerometers and other measuring devices as well as a descriptive drawing showing their location on the vehicle.

No analysis of data is made in this report. For analysis and interpretation of these measurements, see the Saturn SA-8 Flight Evaluation Report or the additional specialized evaluation reports published by the various laboratories of MSFC. A brief explanation of some of the information is given so that it may be more easily interpreted by the user.

The attitude error angles shown are from the ST-124 stabilized platform. The S-I stage guidance was computed from a time polynomial. The computed yaw and roll commands were zero after 24 seconds for the S-I powered flight; therefore, they are not shown beyond 75 seconds. The tilting program and steering commands shown for the S-IV flight were generated by the ASC-15 digital computer.

Angles of attack were measured only by the Q-ball differential pressure measurements. The data from these measurements were filtered digitally with a 1 cps low pass filter. The free-stream angles of attack are shown calculated from these filtered data in conjunction with a wind tunnel determined coefficient. These measurements are not considered valid in the low dynamic pressure region before 18 seconds and after 120 seconds. The angle of attack is also shown calculated from attitude angles, trajectory angles and rawinsonde measured winds.

This calculated angle of attack is only valid until the loss of rawinsonde measured winds at 103.7 seconds.

The individual measurements of engine actuator position on all engines are shown in pitch and yaw. Also shown is an average of the actuator positions in the pitch and yaw planes. For the S-I stage, the average roll actuator position is obtained by differentially averaging the eight telemetered actuator positions. The average roll actuator position for the S-IV stage is obtained by differentially averaging the actuator positions of engines one through four. An appreciable S-I actuator response due to sloshing was observed. The pitch and yaw actuator deflections are shown after being filtered with a 76-point band pass filter around the sloshing frequency mode.

Six bending accelerometers, as well as the two control accelerometers, are shown. The bending accelerometers, located in the instrument unit, on the spider beam, and on the thrust ring, have been digitally filtered using a band pass filter around the first bending mode. The control accelerometers, active in the control loop from 35 to 100 seconds, are shown after being filtered with a 101-point low pass filter in one graph, and a band pass filter around the first bending mode frequency in another.

All digitized data shown have been shifted by either computing a shift from a balance of the equations of motion or by an amount necessary to make the raw telemetry data read zero before engine ignition. All shifts are shown on the page with the drawing and measuring characteristics.

Any erratic change in the data which occurs at the approximate times of 31, 91, 130, 200, 400, and 600 seconds is due to inflight telemetry calibrations. In some instances, there is a straight line in the data at these times in which the telemetry calibrations have been smoothed through. The telemetry during retro rocket firing was not blacked out completely but is noisy and should be used with caution.

All data were plotted at 0.1 second intervals except for the bending accelerometer data which were plotted at 0.02 second intervals.

TIMES OF EVENTS

Event	Range Time (sec)
Ignition Command	- 3.29
First Motion	- 0.18
Liftoff Signal	0.078
ASC-15 "0" Time	0.107
Start Pitch Command	8.65
Start Roll Command	8.66
End Roll Command	23.66
Control Computer Gain Change	110.11
Enable S-I Level Sensors	138.10
Lock Modules (Tilt Arrest)	138.36
IECO	142.00
OEEO	148.05
S-IV Ullage Rocket Fire	148.82
Retro Ignition, Separation, Control Switch Over	148.92
S-IV Hydraulic Accumulation Open	149.72
S-IV Ignition	150.62
Jettison Ullage/LES	160.92
Introduce Guidance	166.69
Control Computer Gain Change	508.91
S-IV Cutoff (Guidance)	624.151
Insertion	634.151
S-IV and IU Tape Recorders Playback Command	724.8
S-IV and IU Tape Recorders Stop Playback Command	754.87
Close S-IV Auxiliary Non-Propulsive Vent Ports	804.87
Initiate Pegasus Forward Restraint Separation	805.87
Initiate Apollo Shroud Separation	805.97
Initiate Pegasus Wing Restraint Separation and Energize Wing Deployment Motors	865.87
End Deployment	905.87

- ap = Normal acceleration pitch
- ay = Normal acceleration yaw
- aL = Longitudinal acceleration
- $\Delta\phi_p$ = Pitch attitude minus program
- ϕ_y = Yaw attitude
- ϕ_r = Roll attitude
- α_p = Angle of attack pitch
- α_y = Angle of attack yaw
- α_p is nose up
- α_y is nose right

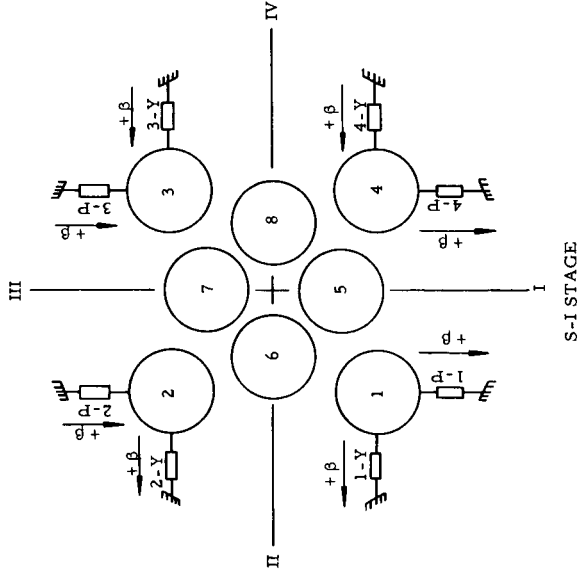
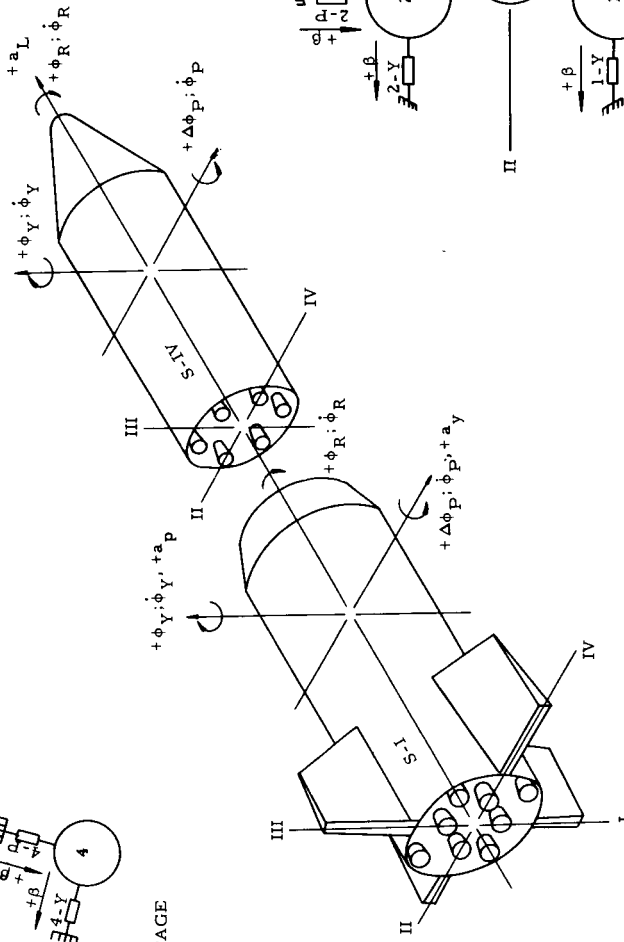
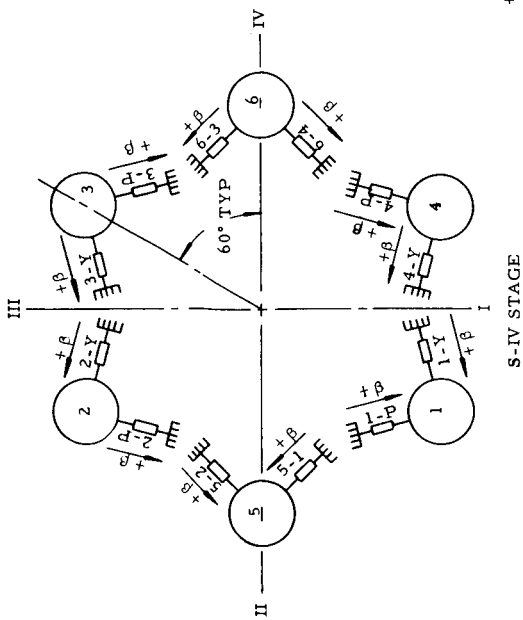

SATURN SIGN CONVENTIONS

ST-124 Stabilized Platform
 H40-802
 H41-802
 H42-802

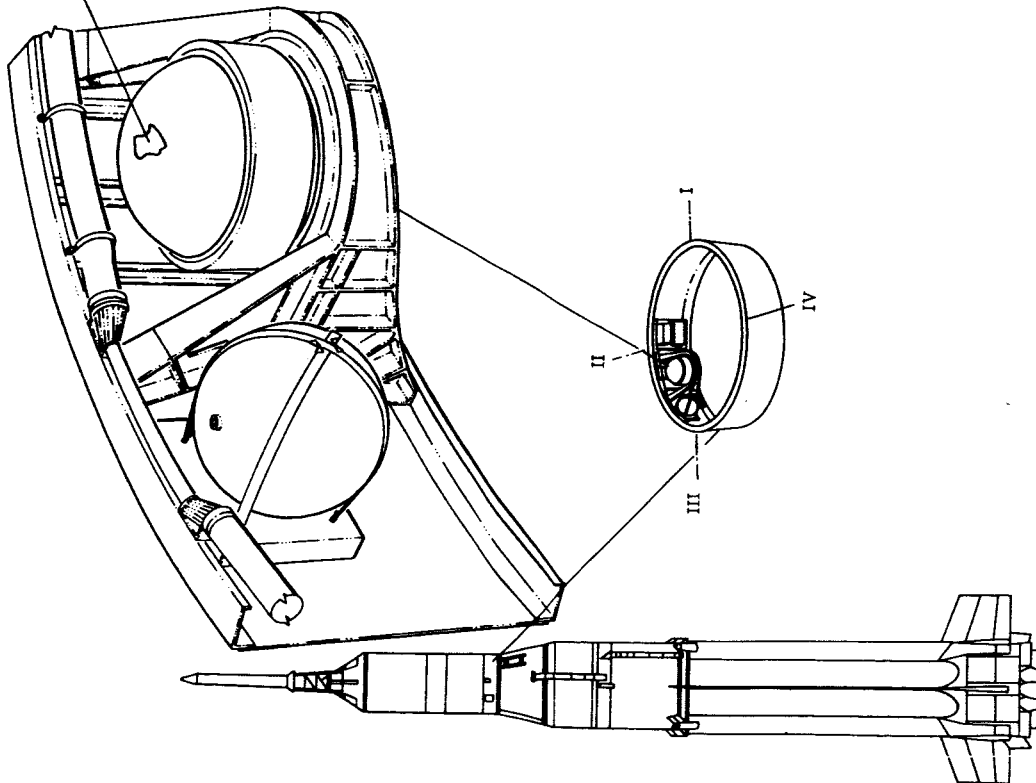

Measurement	Attitude Pitch (ST-124)	Attitude Yaw (ST-124)	Attitude Roll (ST-124)
Measurement No.	H42-802	H41-802	H40-802
Telemeter Channel	F6-06	F5-14M02	F5-17M03
Telemeter Response (cps)	25	8	11
Station Location (in)	1488 (526*)	1488 (526*)	1488 (526*)
Major Component Located on	Wall of Instrument Unit	Wall of Instrument Unit	Wall of Instrument Unit
Radial Location	22.5 deg from Fin II toward Fin III	22.5 deg from Fin II toward Fin III	22.5 deg from Fin II toward Fin III
Measuring Device	ST-124 Stabilized Platform	ST-124 Stabilized Platform	ST-124 Stabilized Platform
Manufacturer	Bendix	Bendix	Bendix
Type of Pick off	Resolver	Resolver	Resolver
Instrument Natural Frequency (cps)	135	135	135
Measuring Range (deg)	± 2.5	± 2.5	± 2.5
Telemeter Shifts Applied to Data (deg)	0	.02	.04

*With reference to S-IV stage

ATTITUDE ANGLES (ST-124) SCHEMATIC OF MEASUREMENT LOCATIONS

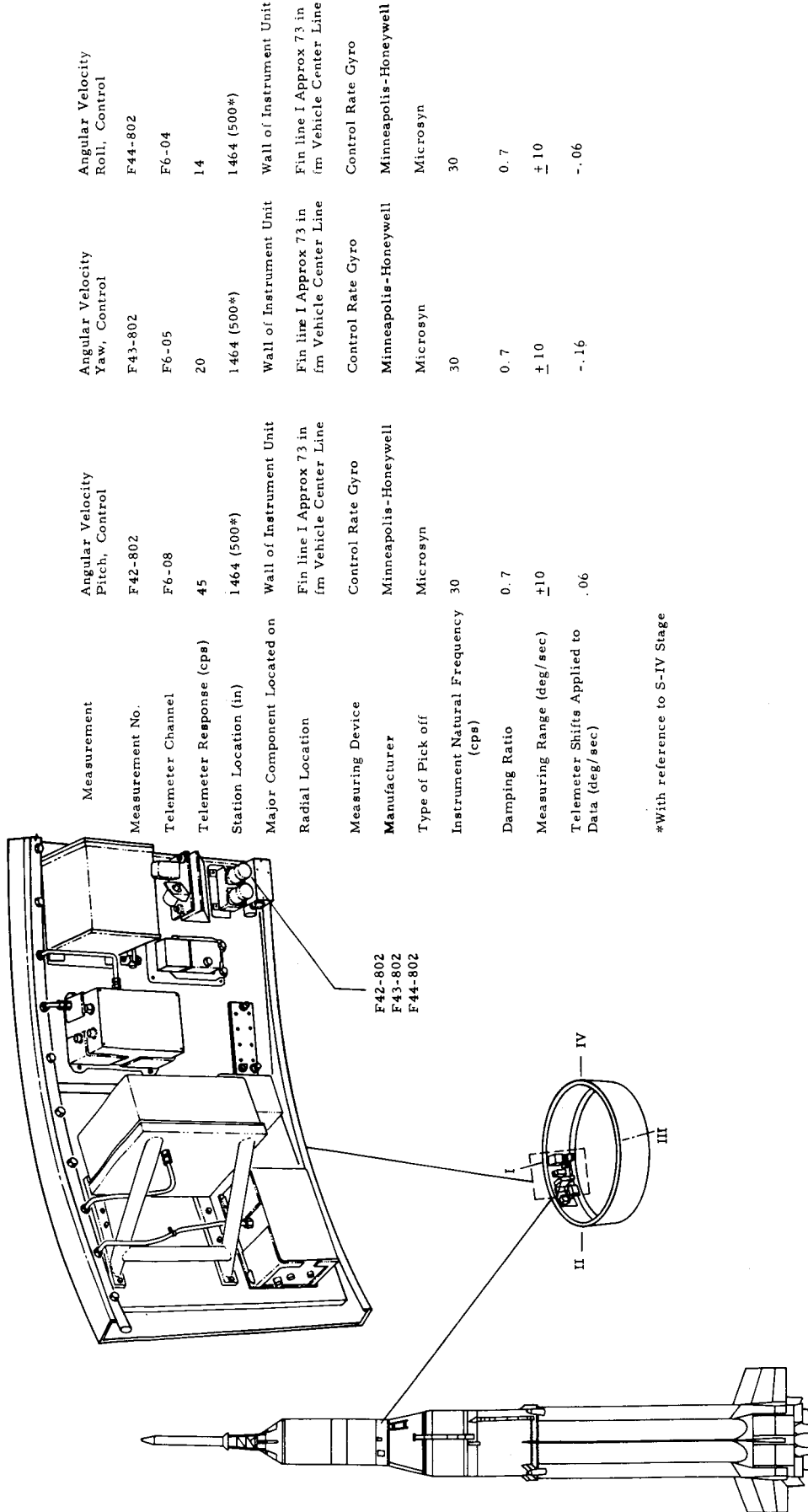

ANGULAR VELOCITIES (CONTROL RATE GYROS)
SCHEMATIC OF MEASUREMENT LOCATIONS

Measurement	Angular Velocity Pitch	Angular Velocity Yaw	Angular Velocity Roll
Measurement No.	F 37-9	F 38-9	F 39-9
Telemeter Channel	F1-03	F1-02	F2 X B24
Telemeter Response (cps)	11	8	25
Station Location (in.)	177	177	177
Major Component Located on	Aft Skirt of Center Tank	Aft Skirt of Center Tank	Aft Skirt of Center Tank
Radial Location	62.5 in from Vehicle Center Line 22.5° From Fin III to Fin IV	62.5 in from Vehicle Center Line 22.5° From Fin III to Fin IV	62.5 in from Vehicle Center Line 22.5° from Fin III to Fin IV
Measuring Device	Control Rate Gyro	Control Rate Gyro	Control Rate Gyro
Manufacturer	Minneapolis-Honeywell	Minneapolis-Honeywell	Minneapolis-Honeywell
Type of Pick off	Microsyn	Microsyn	Microsyn
Instrument Natural Frequency (cps)	30	30	30
Damping Ratio	0.7	0.7	0.7
Measuring Range (deg/sec)	± 10	± 10	± 10
Telemeter Shifts Applied to Data (deg/sec)	.44	.05	-.13

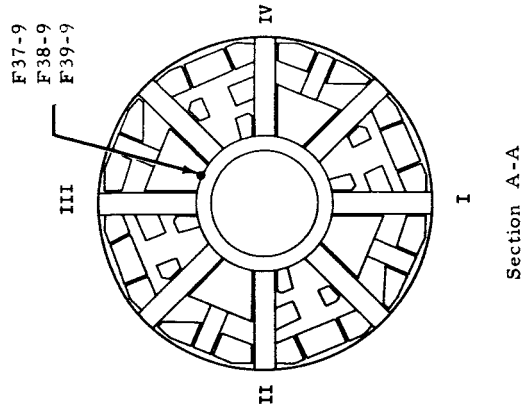

ANGULAR VELOCITIES (TAIL SECTION)
SCHEMATIC OF MEASUREMENT LOCATIONS

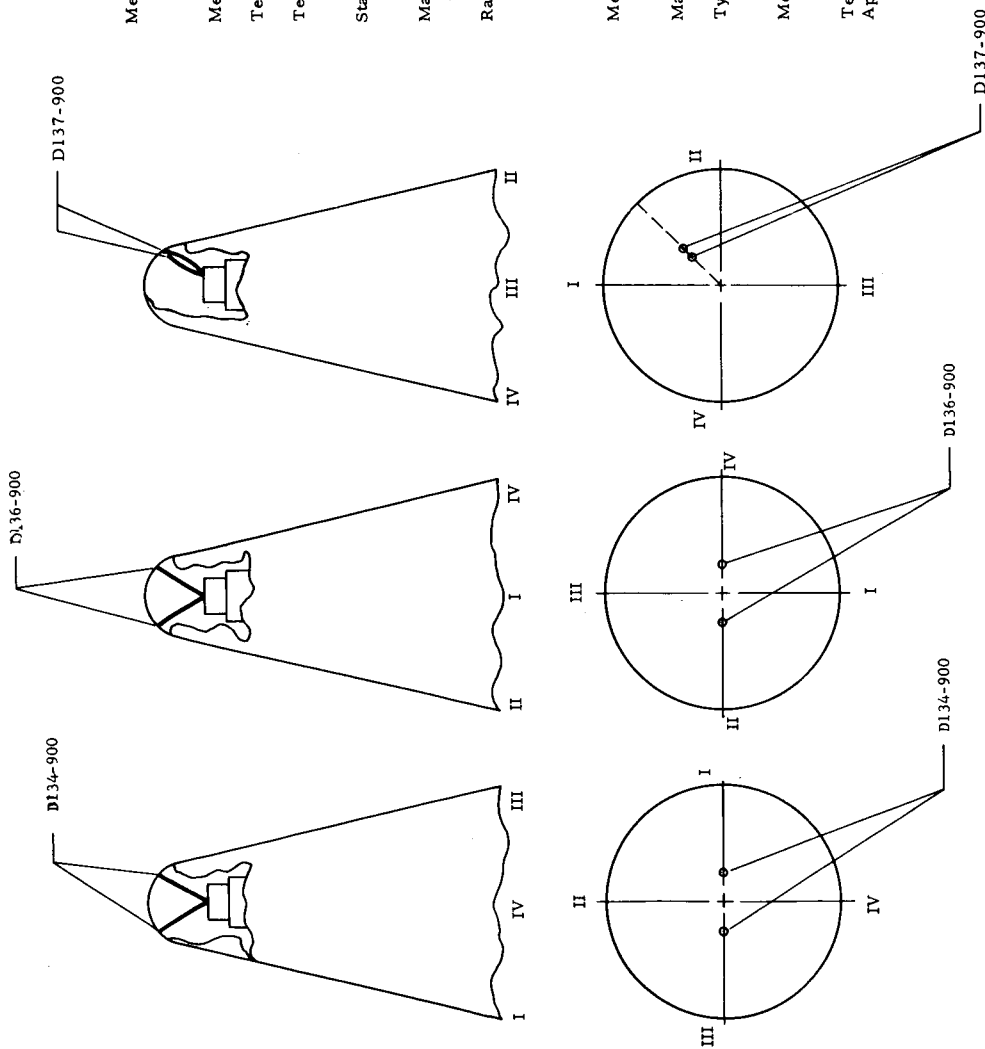

Measurement	Differential pressure Q-ball, pitch	Differential pressure Q-ball, yaw	Differential pressure Q-ball, compensation
Measurement No.	D134-900	D136-900	D137-900
Telemeter Channel	PIB1-15	PIB1-27	F6-X-B19-09
Telemeter Response (cps)	25	25	2.4
Station Location (in.)	2240	2260	2260
Major Component Located on	Inside Q-ball in nose cone	Inside Q-ball in nose cone	Inside Q-ball in nose cone
Radial Location	On fin line I and fin line III, 1.41 inches from vehicle center line	On fin line II and fin line IV, 1.41 inches from vehicle center line	45 degrees between fin I and fin II, 1.41 inches from vehicle center line
Measuring Device	Q-ball angle of attack transducer	Q-ball angle of attack transducer	Q-ball angle of attack transducer
Manufacturer	MSFC	MSFC	MSFC
Type of Pick off	Variable capacitance	Variable capacitance	Variable capacitance
Measuring Range (P _{sid})	± .5	± .5	0±4
Telemeter Shifts Applied to Data (P _{sid})	0	0	.02

ANGLES OF ATTACK
SCHEMATIC OF MEASUREMENT LOCATIONS

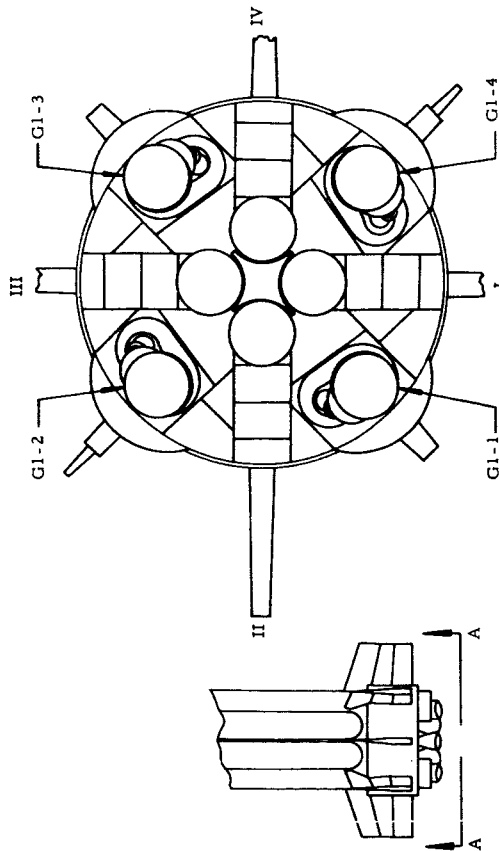

View A-A

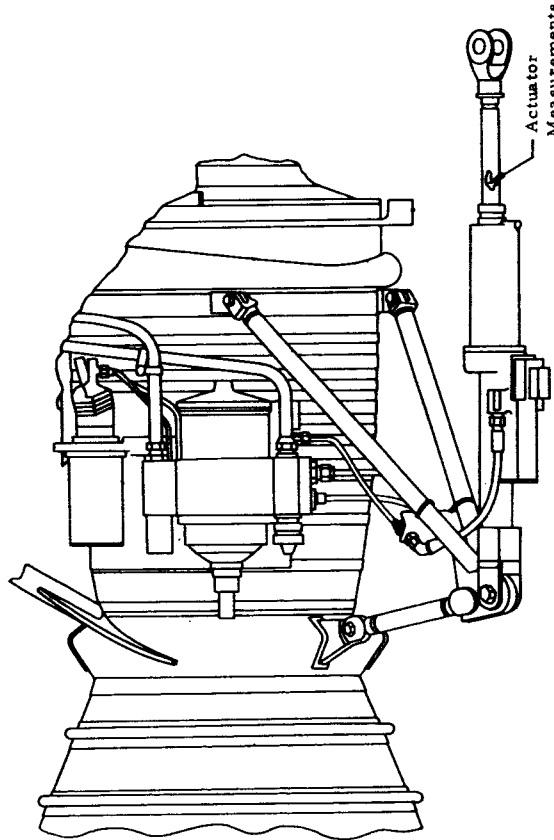

Typical View of Actuator

Measurement	Position pitch actuator	Position pitch actuator	Position pitch actuator	Position pitch actuator
Measurement No.	G1-1	G1-2	G1-3	G1-4
Telemeter Channel	F6-10	F5-07	F5-10	F5-14M06
Telemeter Response (cps)	80	35	80	25
Station Location (in.)	100 (Gimbal Point)	100 (Gimbal Point)	100 (Gimbal Point)	100 (Gimbal Point)
Major Component Located on	Pitch actuator Engine 1	Pitch actuator Engine 2	Pitch actuator Engine 3	Pitch actuator Engine 4
Measuring Device	Potentiometer identical to feedback pot	Potentiometer identical to feedback pot	Potentiometer identical to feedback pot	Potentiometer identical to feedback pot
Manufacturer	Moog Servo Controls, Inc.	Moog Servo Controls, Inc.	Moog Servo Controls, Inc.	Moog Servo Controls, Inc.
Type of Pick off	Potentiometer	Potentiometer	Potentiometer	Potentiometer
Measuring Range (deg)	± 8	± 8	± 8	± 8
Telemeter Shifts Applied to Data (deg)	.04	-.04	-.19	.29

PITCH ACTUATORS
SCHEMATIC OF MEASUREMENT LOCATIONS

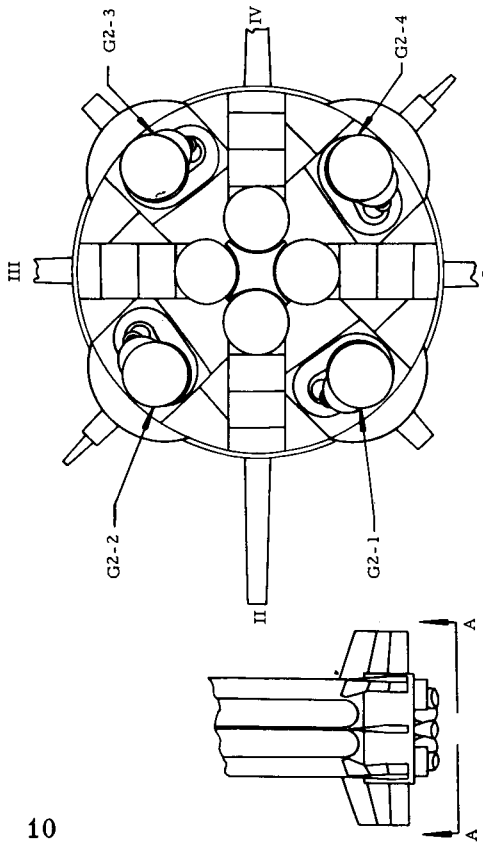

View A-A

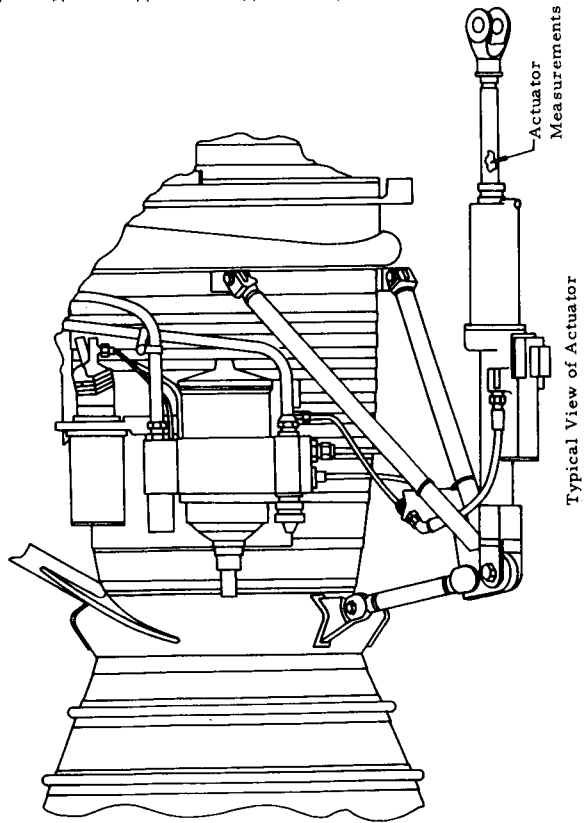

Typical View of Actuator

Measurement	Position yaw actuator	Position yaw actuator	Position yaw actuator	Position yaw actuator
Measurement No.	G2-1	G2-2	G2-3	G2-4
Telemeter Channel	F5-05	F6-07	F5-14M05	F6-14M06
Telemeter Response (cps)	20	35	20	25
Station Location (in.)	100 (Gimbal Point)	100 (Gimbal Point)	100 (Gimbal Point)	100 (Gimbal Point)
Major Component Located on	Yaw actuator Engine 1	Yaw actuator Engine 2	Yaw actuator Engine 3	Yaw actuator Engine 4
Measuring Device	Potentiometer identical to feedback pot	Potentiometer identical to feedback pot	Potentiometer identical to feedback pot	Potentiometer identical to feedback pot
Manufacturer	Moog Servo Controls, Inc.	Moog Servo Controls, Inc.	Moog Servo Controls, Inc.	Moog Servo Controls, Inc.
Type of Pick off	Potentiometer	Potentiometer	Potentiometer	Potentiometer
Measuring Range (deg)	± 8	± 8	± 8	± 8
Telemeter Shifts Applied to Data (deg)	.34	.06	.46	.28

YAW ACTUATORS SCHEMATIC OF MEASUREMENT LOCATION

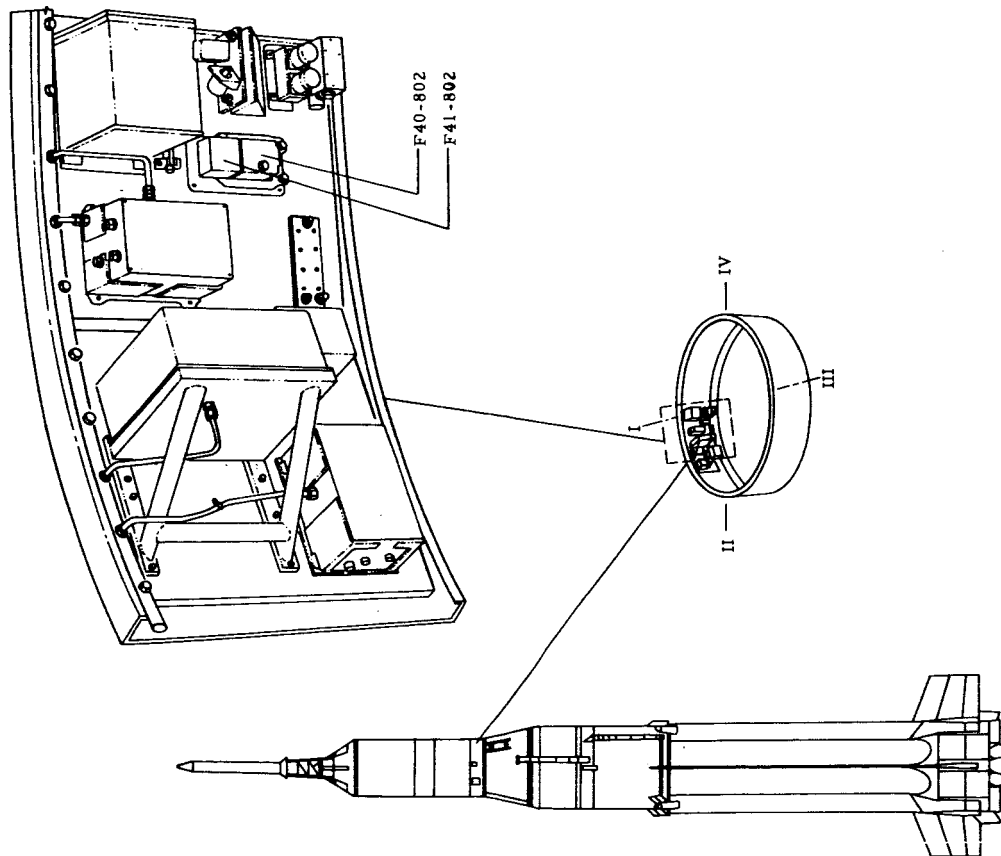

Measurement	Acceleration Pitch, Control	Acceleration Yaw, Control
Measurement No.	F40-802	F41-802
Telemeter Channel	F5-03	F5-17M02
Telemeter Response (cps)	11	8
Station Location (in)	1472 (508*)	1477 (513*)
Major Component Located On	Wall of Instrument Unit	Wall of Instrument Unit
Radial Location	On Fin Line I, 73 in from Vehicle Center Line	On Fin Line I, 73 in from Vehicle Center Line
Measuring Device	Control Accelerometer	Control Accelerometer
Manufacturer	Statham	Statham
Type of Pick off	Differential Transformer	Differential Transformer
Instrument Natural Frequency (cps)	8.0	7.9
Damping Ratio	.62	.73
Measuring Range (m/sec ²)	± 5	± 5
Telemeter Shifts Applied to Data (m/sec ²)	-.03	.055

*With Reference to S-IV stage

LINEAR ACCELERATIONS SCHEMATIC OF MEASUREMENT LOCATIONS

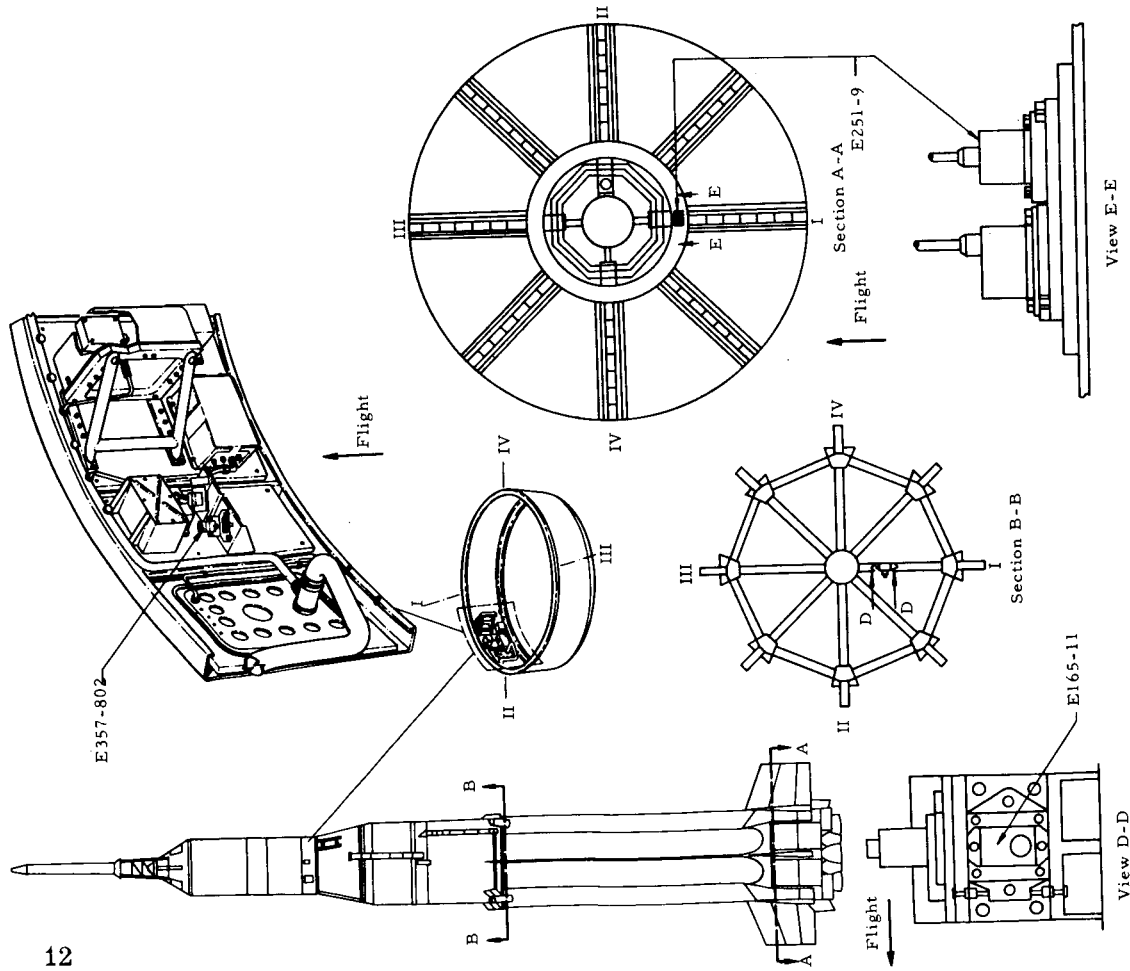

PITCH PLANE
SCHEMATIC OF MEASUREMENT LOCATIONS

Measurement	Vibration Pitch	Vibration Spider Beam, Pitch	Vibration Thrust Ring, Pitch
Measurement No	E357-802	E165-11	E251-9
Telemeter Channel	F6-X-B11	F3-X-B01	F3-X-B09
Telemeter Response (cps)	25	25	25
Station Location (in)	1485	952	189
Major Component Located on	Wall of Instrument Unit	Web of Spider Beam	Thrust Ring
Radial Location	51 deg. from Fin II to I. 73 in from Vehicle Center line	On fin line I, 37.5 in from Vehicle Center line	Fin line I, 45 in from Vehicle Center line
Measuring Device	Accelerometer	Accelerometer	Accelerometer
Manufacturer	Donney-Scientific	Donner-Scientific	Donner-Scientific
Type of Pick off	Force-balance	Force-balance	Force-balance
Instrument Natural Frequency (cps)	57.0	66.0	71.0
Damping Ratio	.7	.72	.68
Measuring Range (g's)	$\pm .5$	$\pm .5$	$\pm .5$
Telemeter Shifts Applied to Data (g's)	.002	.008	.006

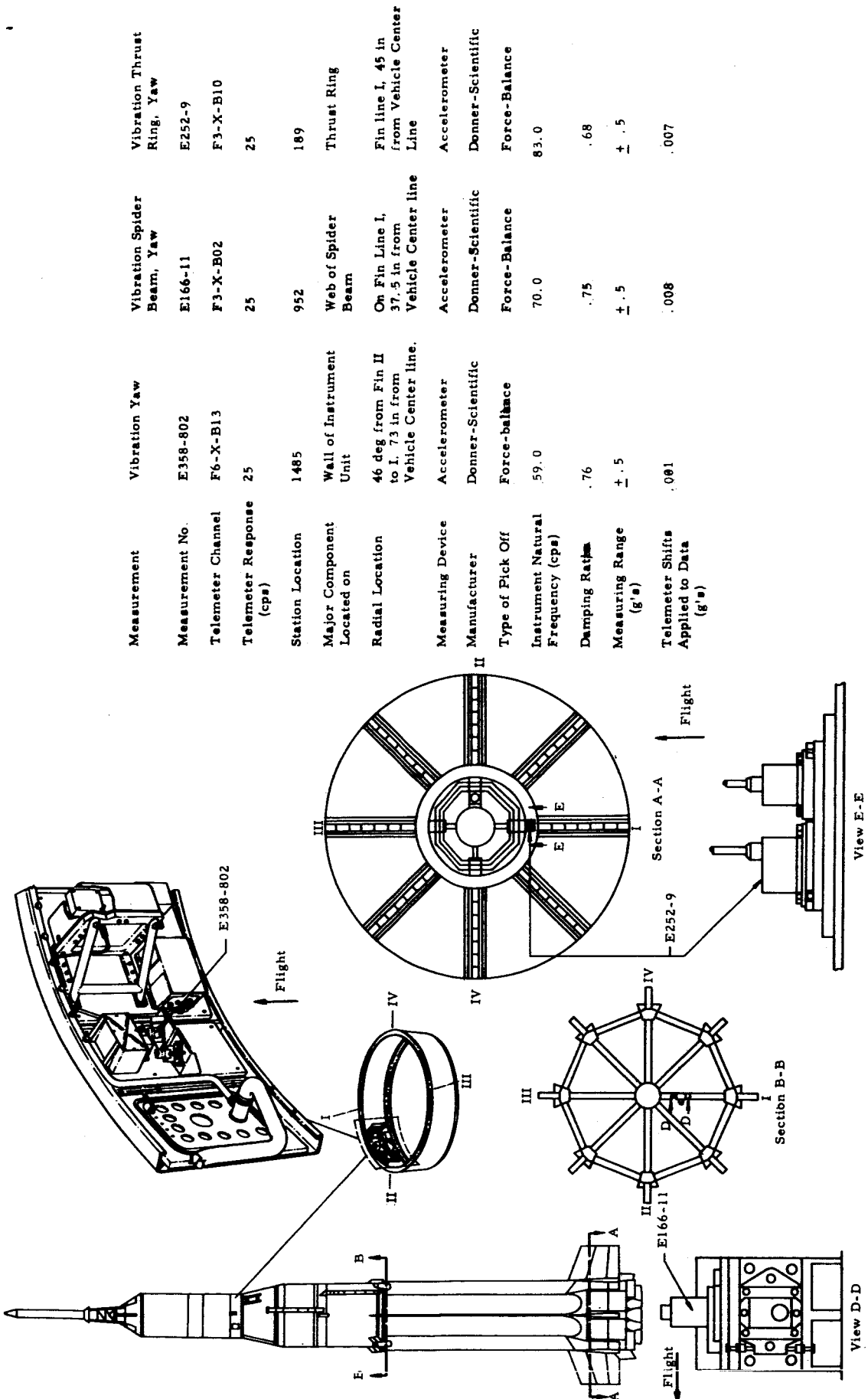

Measurement	Vibration Yaw	Vibration Spider Beam, Yaw	Vibration Thrust Ring, Yaw
Measurement No.	E358-802	E166-11	E252-9
Telemeter Channel	F6-X-B13	F3-X-B02	F3-X-B10
Telemeter Response (cps)	25	25	25
Station Location	1485	952	189
Major Component Located on	Wall of Instrument Unit	Web of Spider Beam	Thrust Ring
Radial Location	46 deg from Fin II to I. 73 in from Vehicle Center line.	On Fin Line I, 37.5 in from Vehicle Center line	Fin line I, 45 in from Vehicle Center Line
Measuring Device	Accelerometer	Accelerometer	Accelerometer
Manufacturer	Donner-Scientific	Donner-Scientific	Donner-Scientific
Type of Pick Off	Force-balance	Force-Balance	Force-Balance
Instrument Natural Frequency (cps)	59.0	70.0	83.0
Damping Ratio	.76	.75	.68
Measuring Range (g's)	± .5	± .5	± .5
Telemeter Shifts Applied to Data (g's)	.081	.008	.007

YAW PLANE
SCHEMATIC OF MEASUREMENT LOCATIONS

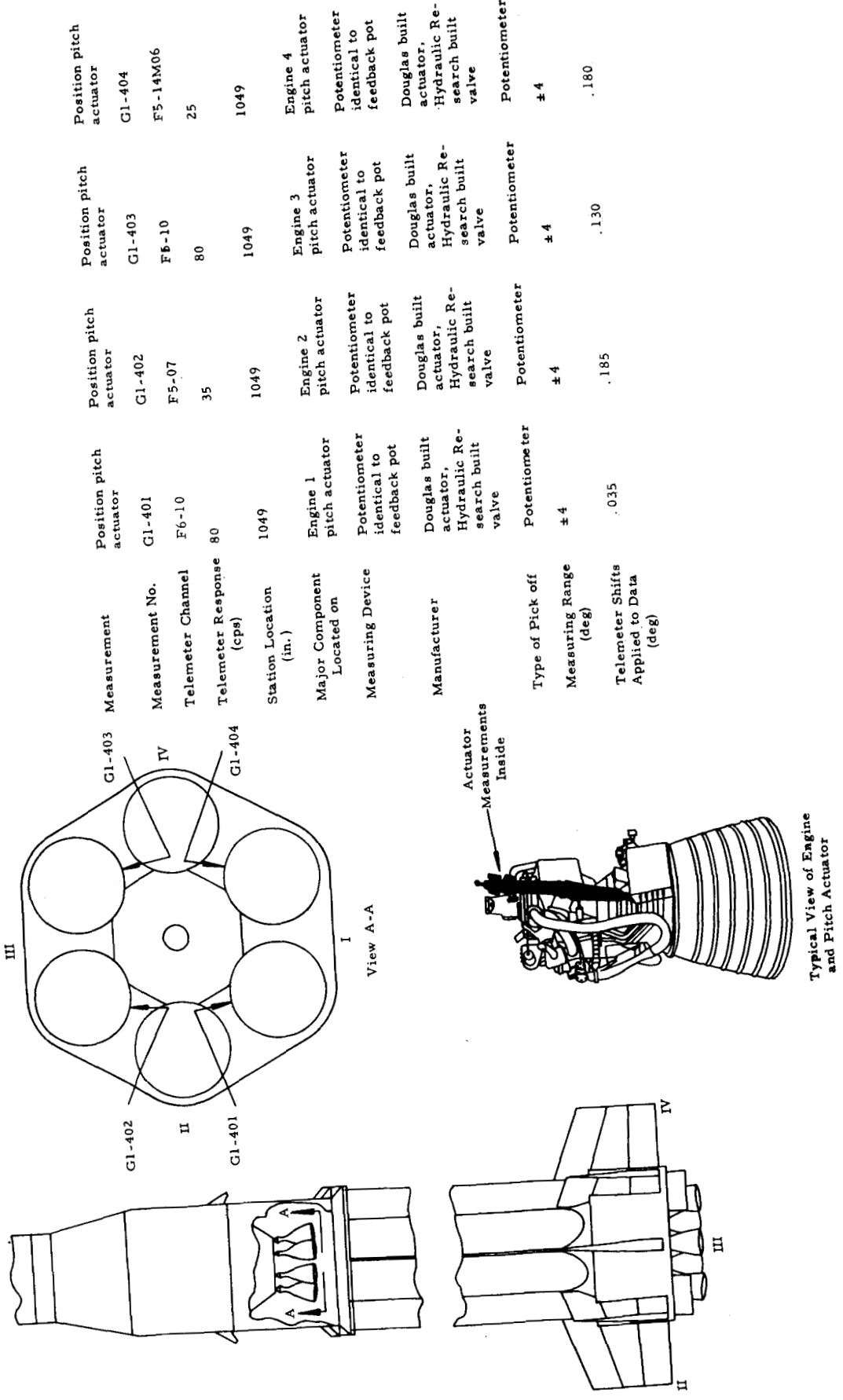

Typical View of Engine and Pitch Actuator

PITCH ACTUATORS
SCHEMATIC OF MEASUREMENT LOCATIONS

Measurement	Position pitch actuator	Position pitch actuator	Position pitch actuator	Position pitch actuator
G1-403	G1-403	G1-402	G1-401	G1-404
IV	F5-14M06	F5-07	F6-10	F5-14M06
	80	35	80	25
G1-404	1049	1049	1049	1049
Station Location (in.)	Engine 3 pitch actuator	Engine 2 pitch actuator	Engine 1 pitch actuator	Engine 4 pitch actuator
Major Component Located on	Potentiometer identical to feedback pot	Potentiometer identical to feedback pot	Potentiometer identical to feedback pot	Potentiometer identical to feedback pot
Measuring Device	Douglas built actuator, Hydraulic Re-search built valve	Douglas built actuator, Hydraulic Re-search built valve	Douglas built actuator, Hydraulic Re-search built valve	Douglas built actuator, Hydraulic Re-search built valve
Manufacturer	Potentiometer	Potentiometer	Potentiometer	Potentiometer
Type of Pick off	± 4	± 4	± 4	± 4
Measuring Range (deg)	.130	.185	.035	.180
Telemeter Shifts Applied to Data (deg)				

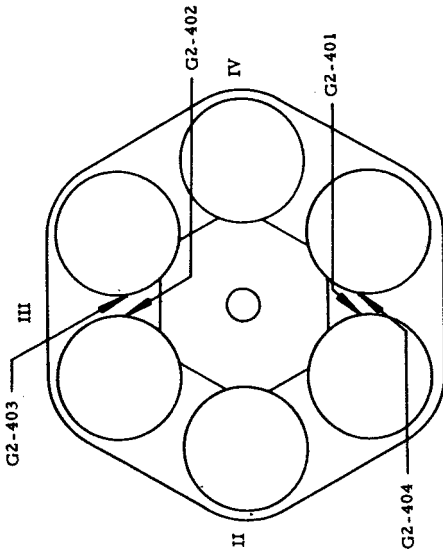

View A-A

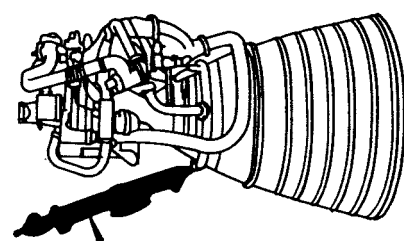
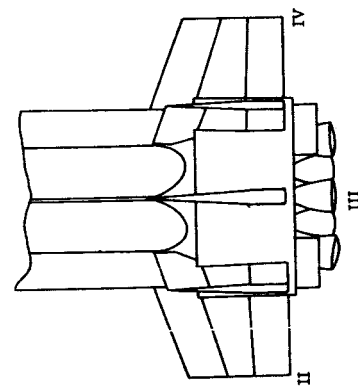
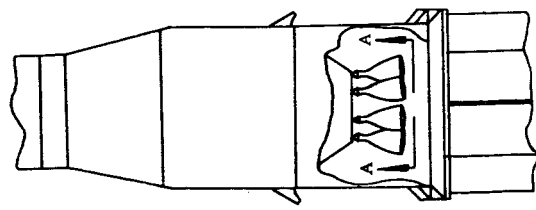

Typical View of Engine and Yaw Actuator

Measurement	Position yaw actuator	Position yaw actuator	Position yaw actuator	Position yaw actuator
Measurement No.	G2-401	G2-402	G2-403	G2-404
Telemeter Channel	F5-05	F6-07	F6-14M05	F6-14M06
Telemeter Response (cps)	20	35	20	25
Station Location (in.)	1049	1049	1049	1049
Major Component Located on	Engine 1 yaw actuator	Engine 2 yaw actuator	Engine 3 yaw actuator	Engine 4 yaw actuator
Measuring Device	Potentiometer identical to feedback pot	Potentiometer identical to feedback pot	Potentiometer identical to feedback pot	Potentiometer identical to feedback pot
Manufacturer	Douglas built actuator, Hydraulic Re-search built valve	Douglas built actuator, Hydraulic Re-search built valve	Douglas built actuator, Hydraulic Re-search built valve	Douglas built actuator, Hydraulic Re-search built valve
Type of Pick off	Potentiometer	Potentiometer	Potentiometer	Potentiometer
Measuring Range (deg)	± 4	± 4	± 4	± 4
Telemeter Shifts Applied to Data (deg)	.4C.	.21	-.045	.12

YAW ACTUATORS
SCHEMATIC OF MEASUREMENT LOCATIONS

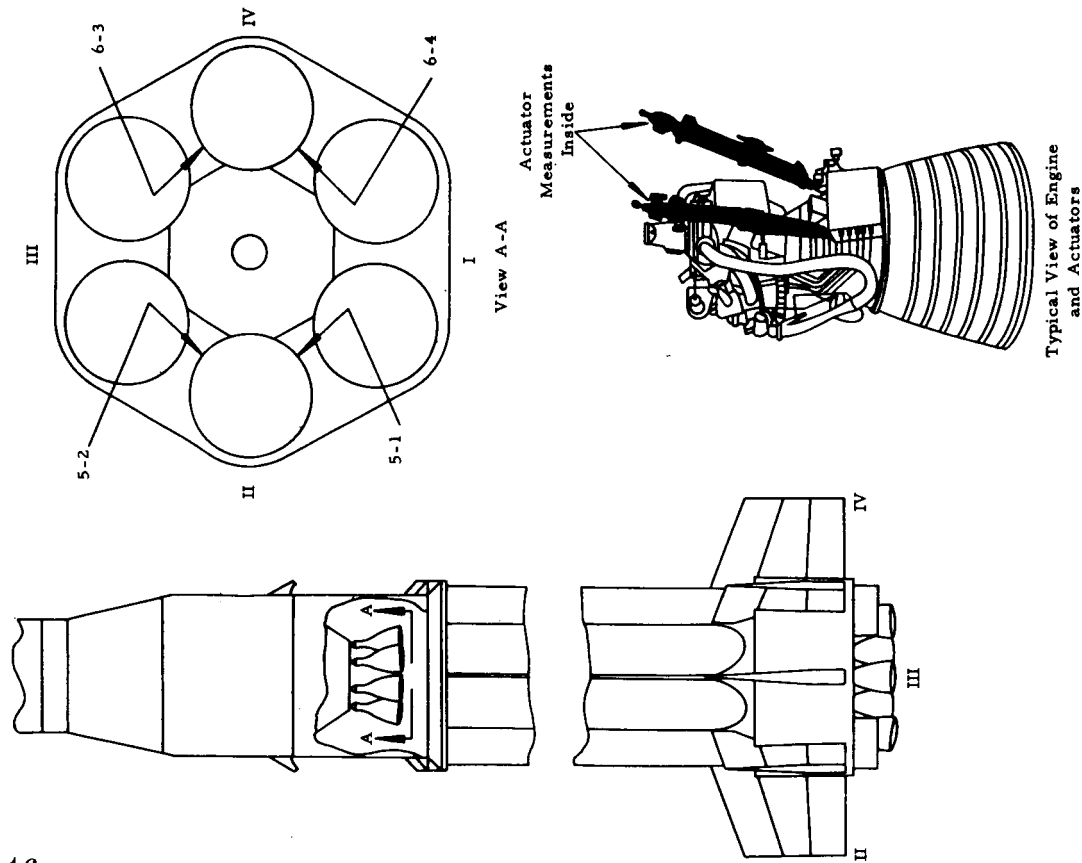

Measurement	Position, actuator 5-1	Position, actuator 5-2	Position, actuator 6-3	Position, actuator 6-4
Measurement No.	G15-405	G16-405	G17-406	G18-406
Telemeter Channel	F5-17M07	F6-14M05	F5-17M05	F5-17M06
Telemeter Response (cps)	35	20	20	25
Station Location (in.)	1049	1049	1049	1049
Major Component Located on	Engine 5 actuator	Engine 5 actuator	Engine 6 actuator	Engine 6 actuator
Measuring Device	Potentiometer identical to feedback pot	Potentiometer identical to feedback pot	Potentiometer identical to feedback pot	Potentiometer identical to feedback pot
Manufacturer	Douglas built actuator, Hydraulic Research built valve	Douglas built actuator, Hydraulic Research built valve	Douglas built actuator, Hydraulic Research built valve	Douglas built actuator, Hydraulic Research built valve
Type of Pick off	Potentiometer	Potentiometer	Potentiometer	Potentiometer
Measuring Range (deg)	±4	±4	±4	±4
Telemeter Shifts Applied to Data (deg)	-4.145	-.03	-.03	.075

ENGINE 5 AND 6
SCHEMATIC OF MEASUREMENT LOCATIONS

DIGITIZED DATA

W_x (Rawinsonde Wind Component) (+ Wind from Rear) (m/sec)

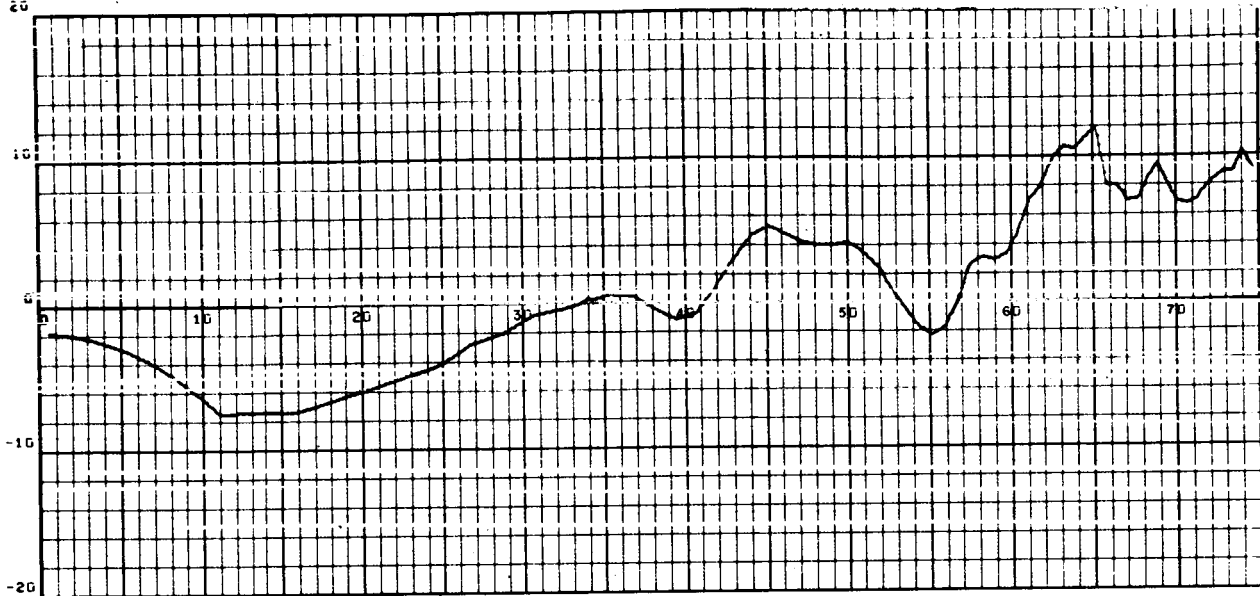

W_x (Angle-of-attack Wind Component) (+ Wind from Rear) (m/sec)

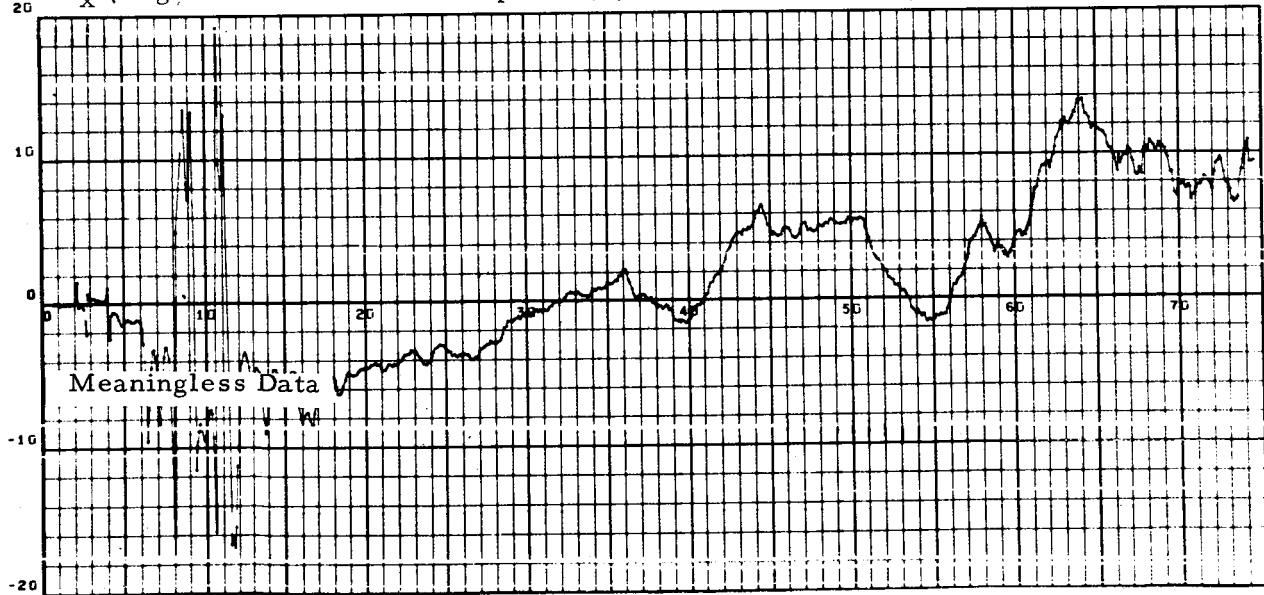

PITCH PLANE WIND COMPONENTS

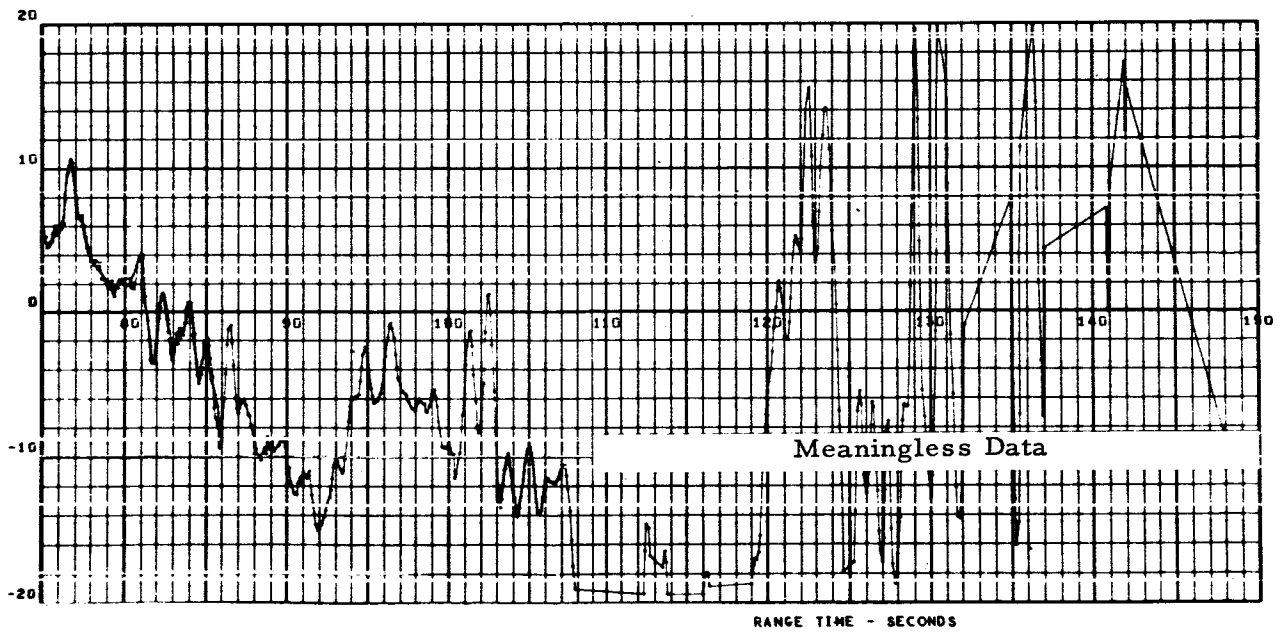
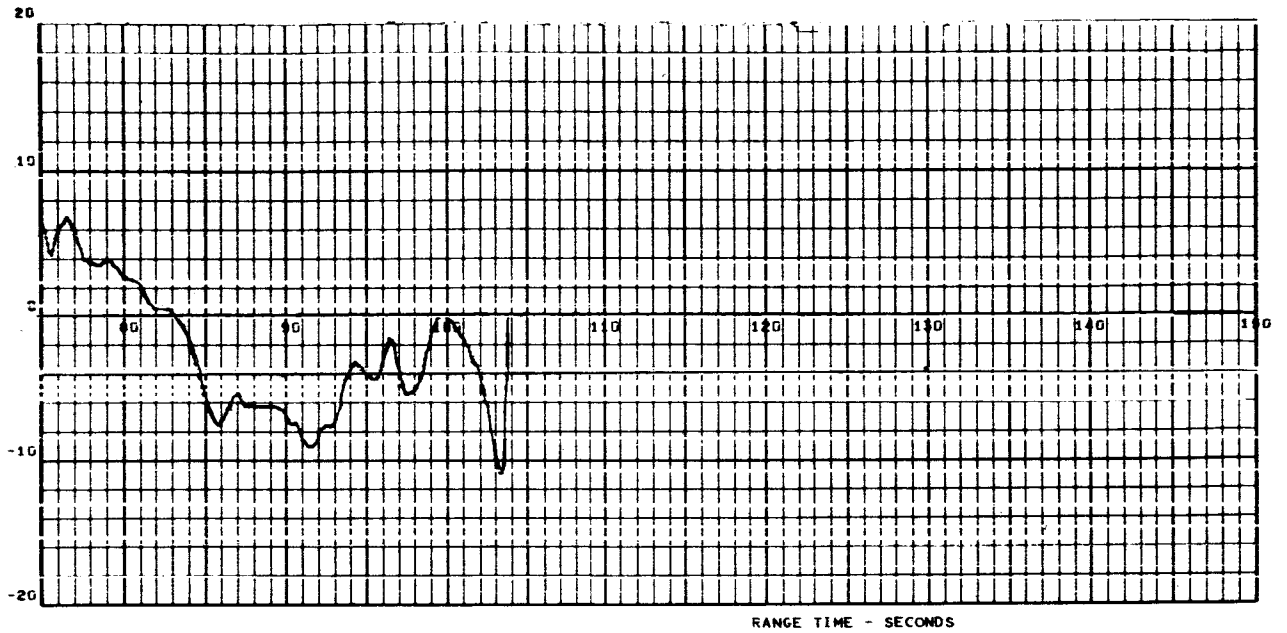

PITCH PLANE WIND COMPONENT (CONTD)

W_z (Rawinsonde Wind Component) (+ Wind from Left) (m/sec)

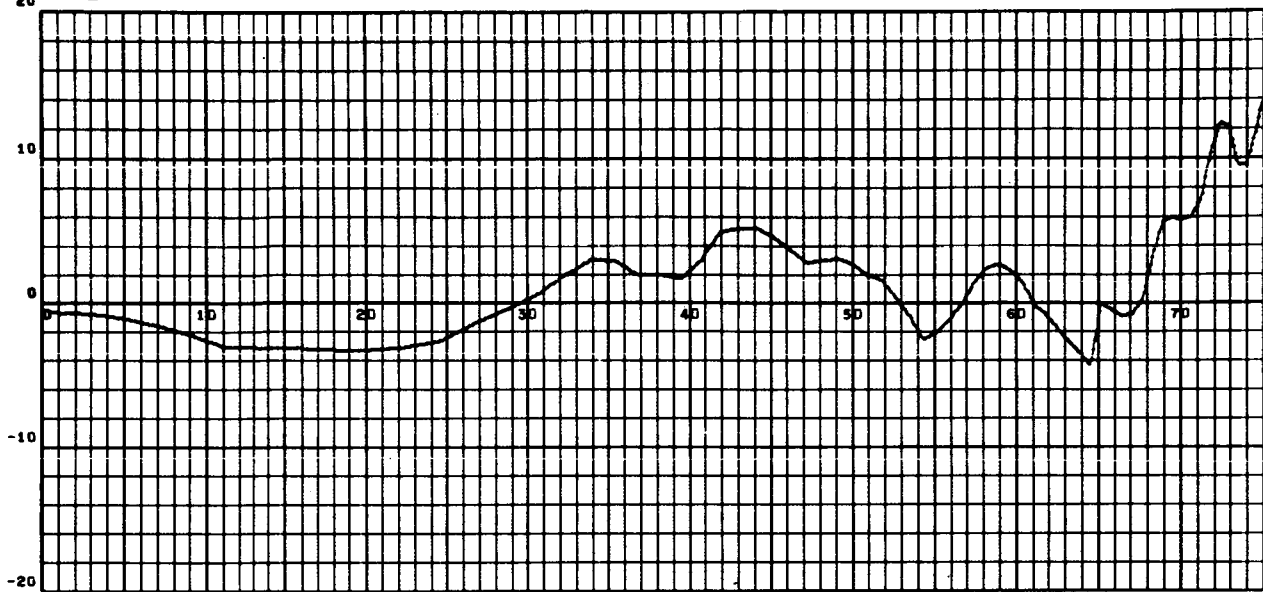

W_z (Angle-of-Attack Wind Component) (+ Wind from Left) (m/sec)

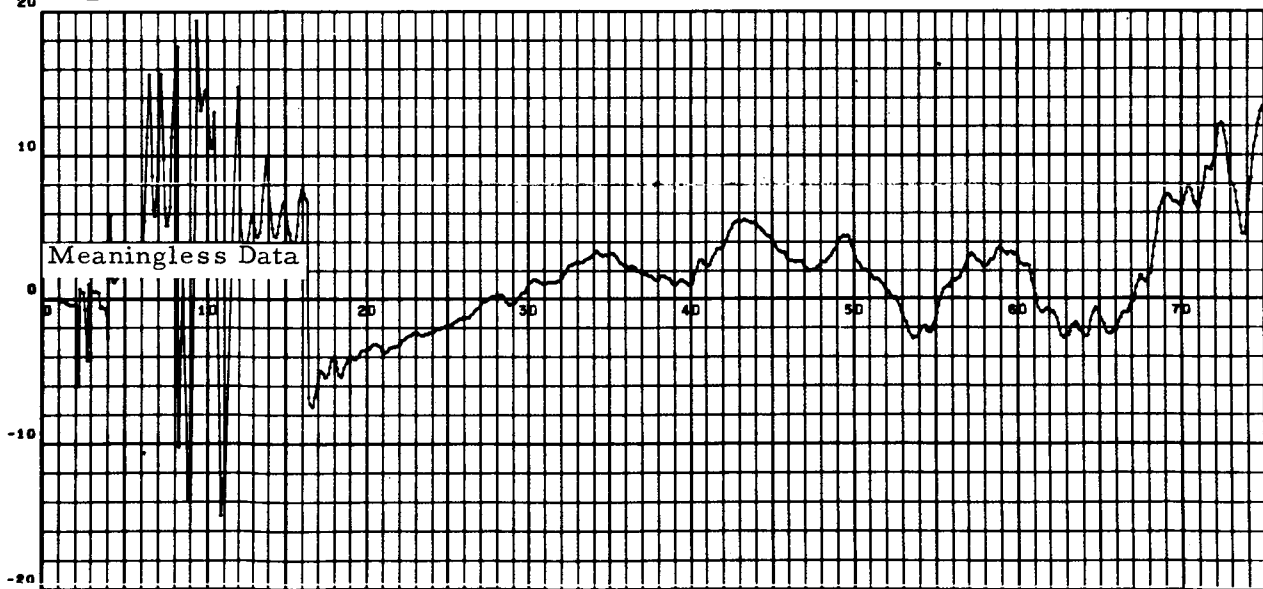

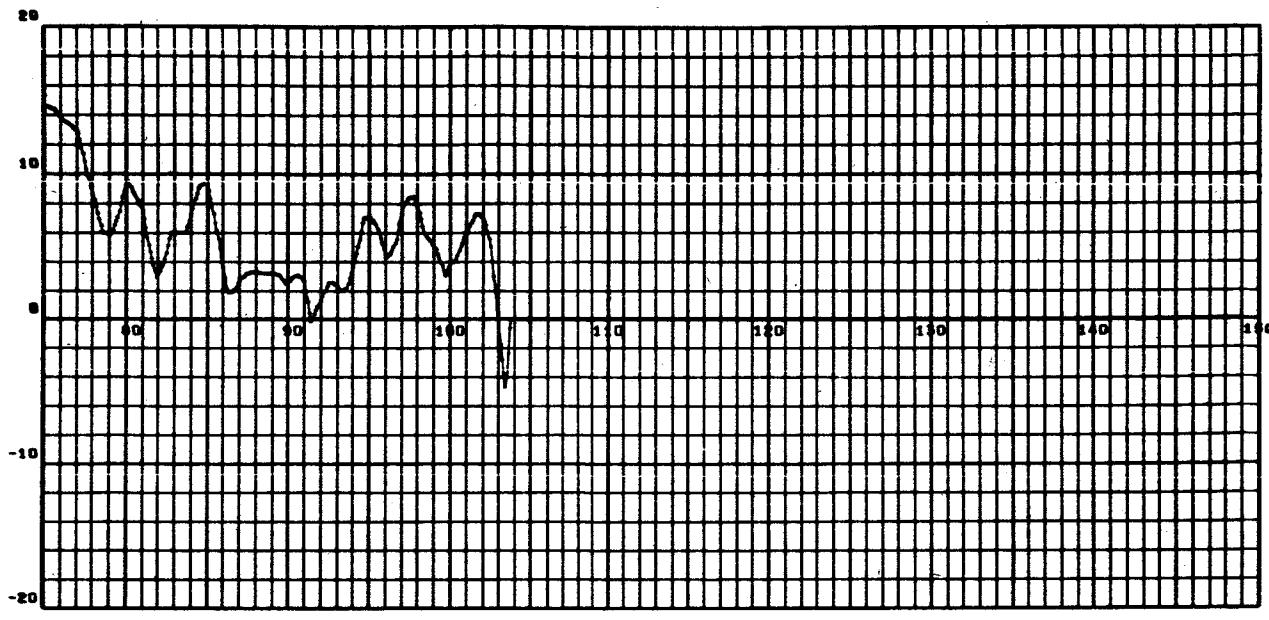

RANGE TIME - SECONDS

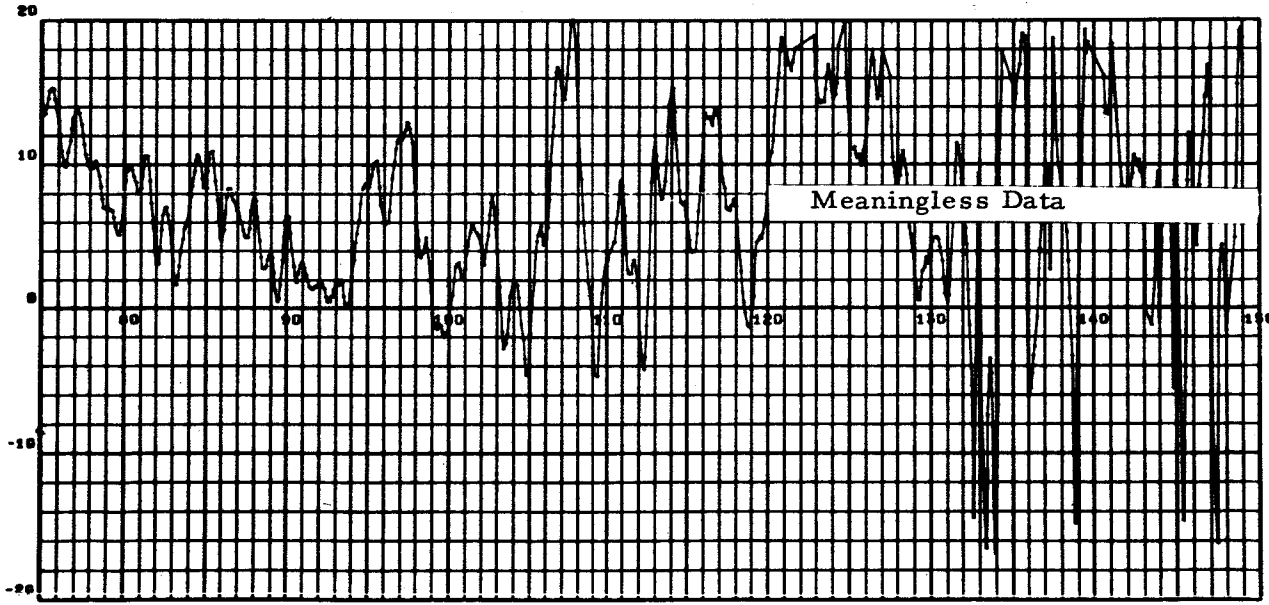

RANGE TIME - SECONDS

Steering Command, Pitch (deg)

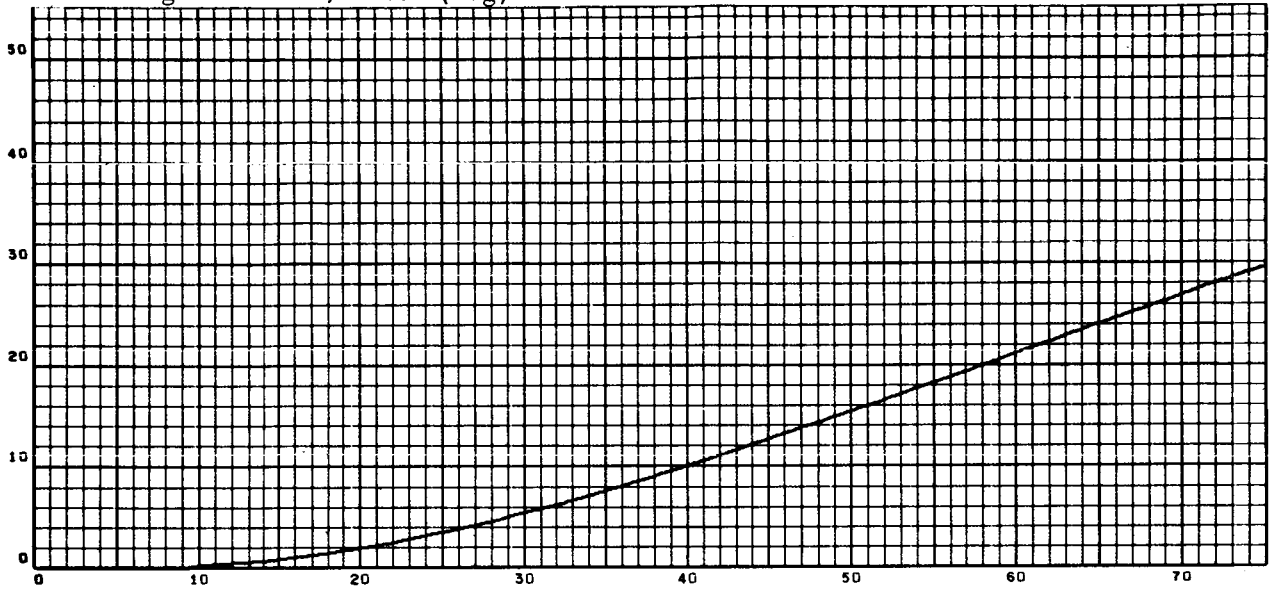

Pitch Velocity Vector Angle (Space-Fixed) (deg)

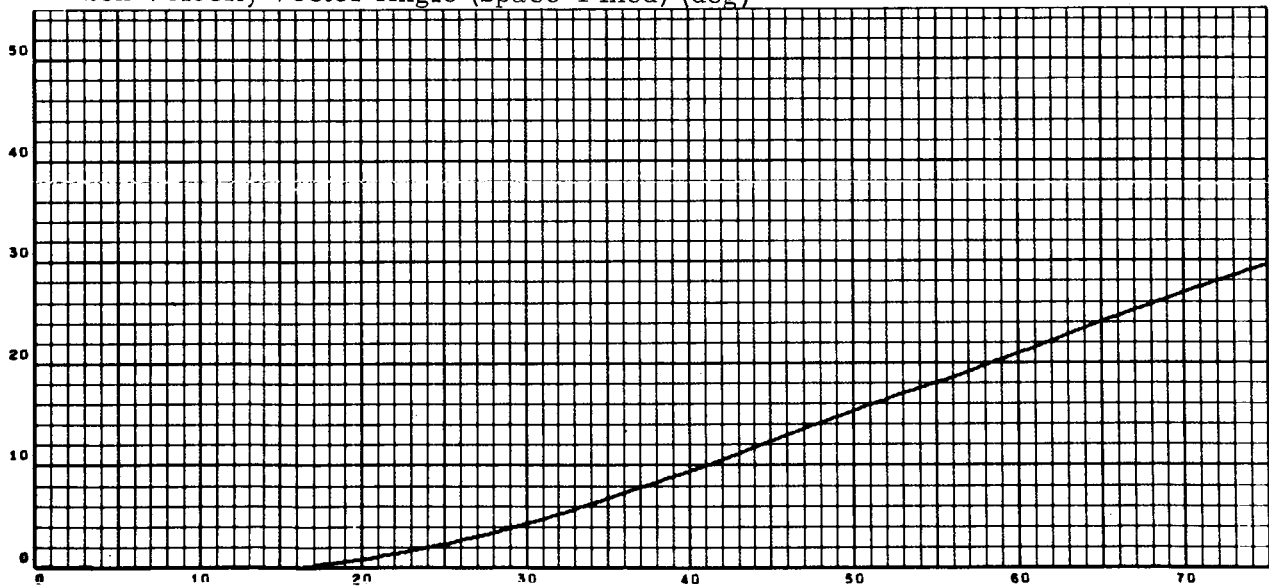

PITCH STEERING COMMAND AND VELOCITY VECTOR ANGLE

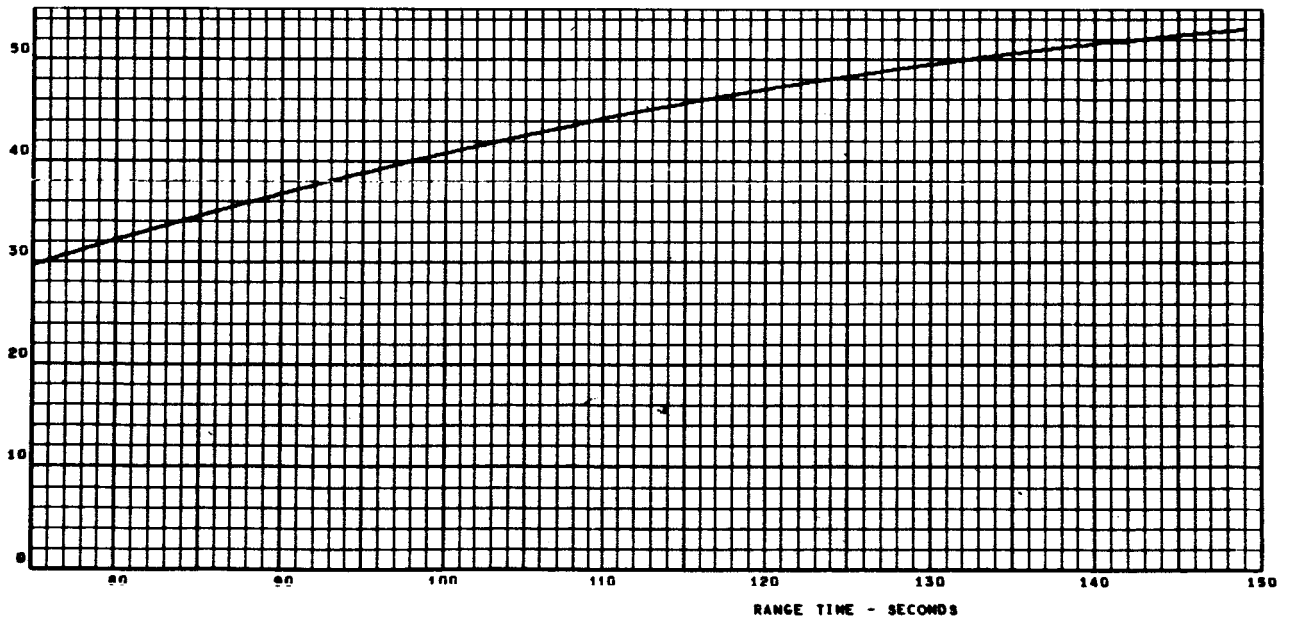
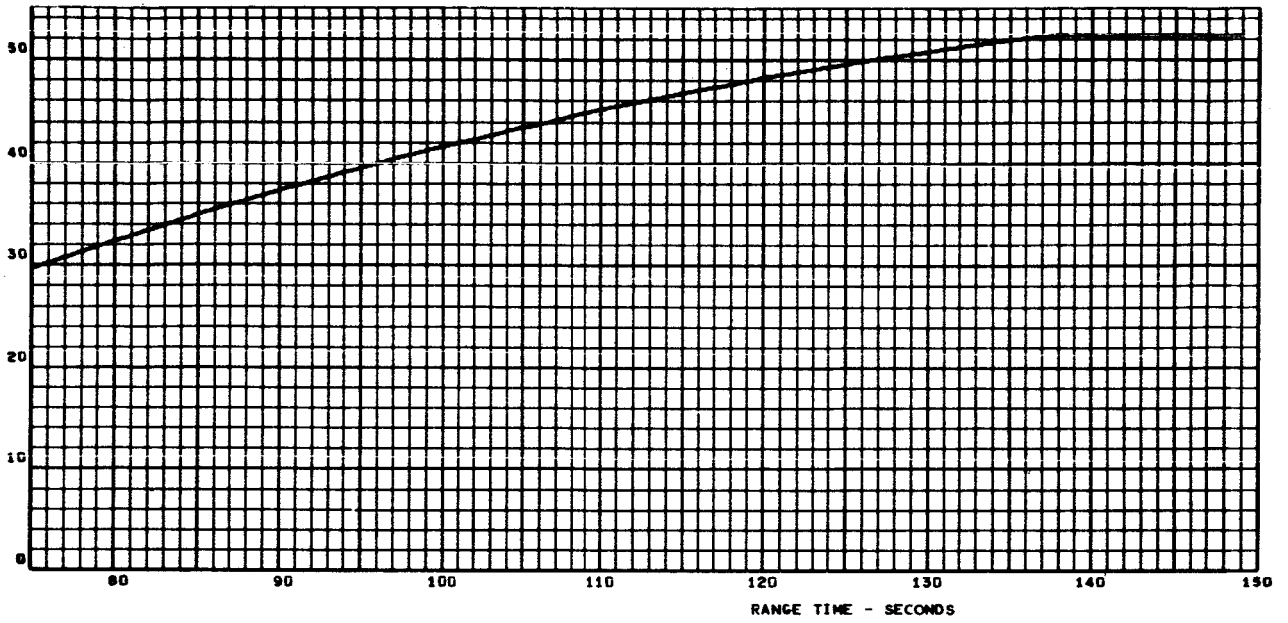

PITCH STEERING COMMAND AND VELOCITY VECTOR ANGLE (CONTD)

CHI X (110-802) (deg)

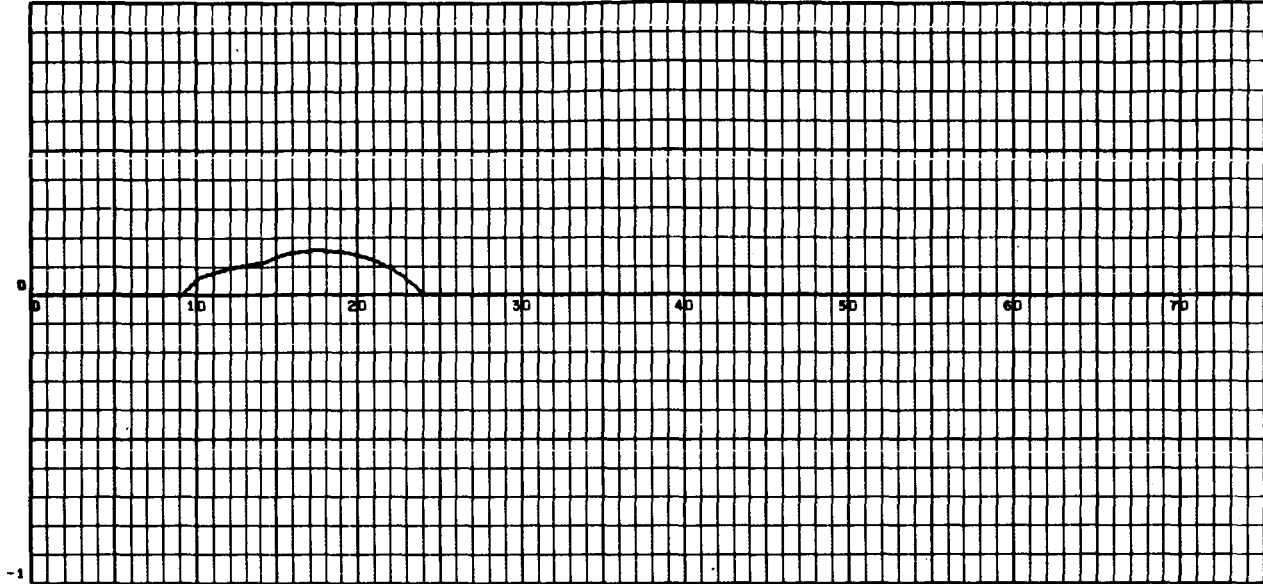

CHI Y (113-802) (deg)

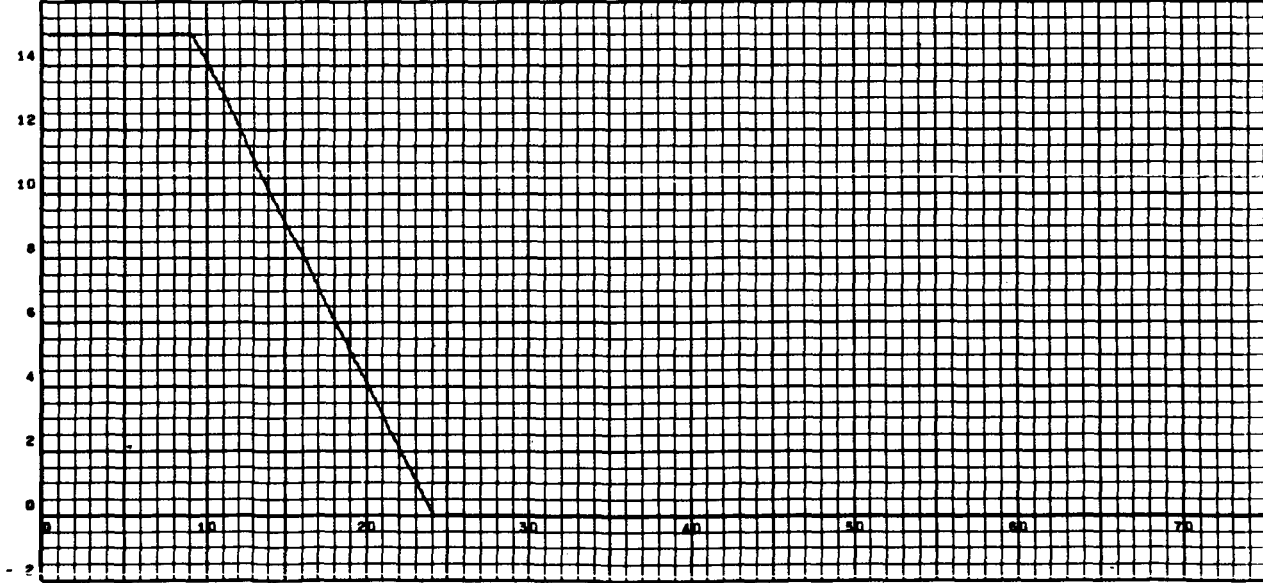

GUIDANCE COMMANDS

1 Pitch Plane Actuator Positon (Filtered*) (deg)

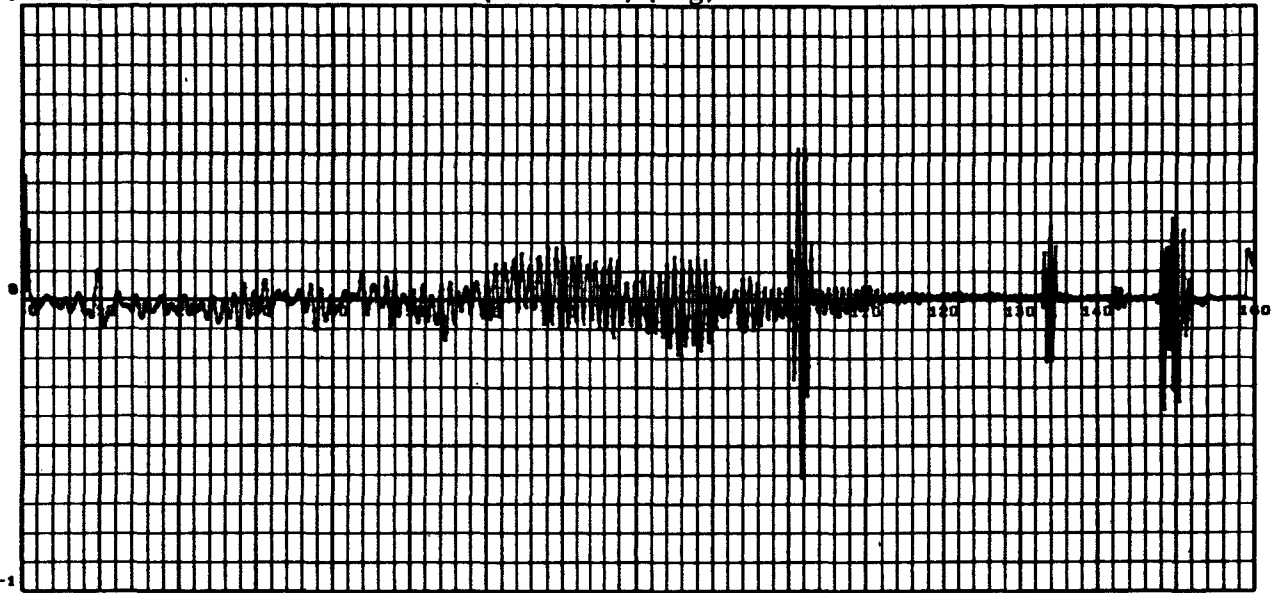

1 Yaw Plane Actuator Position (Filtered*) (deg)

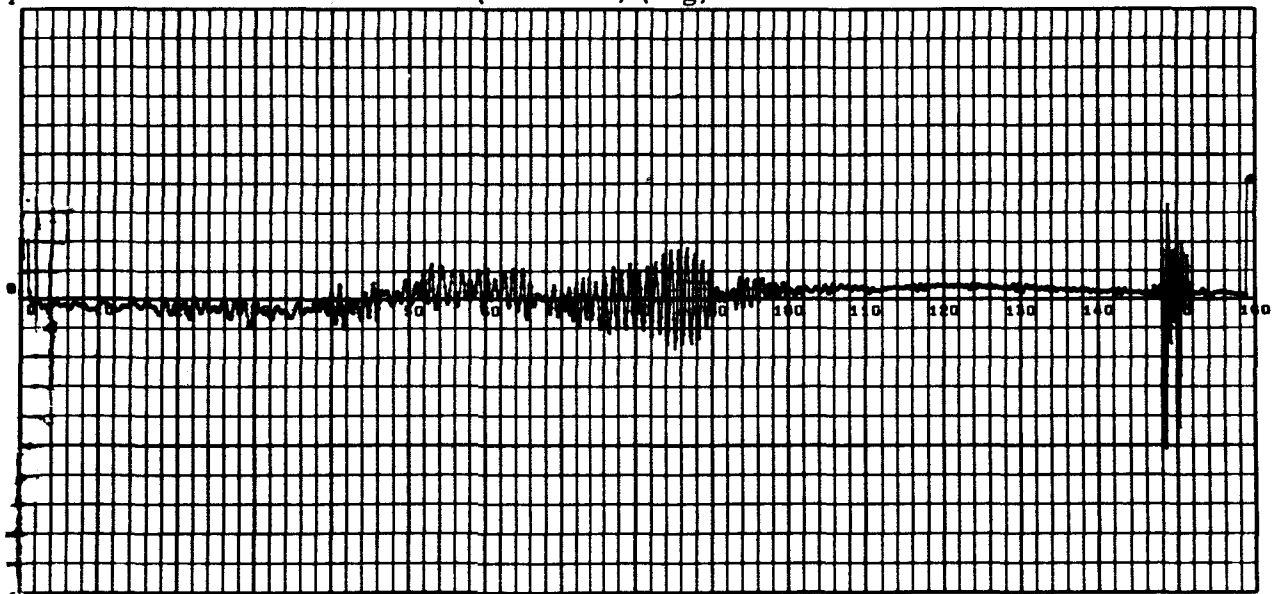

*Filtered Digitally using a 76 point band pass around the Sloshing Frequency Mode

ACTUATOR DEFLECTION AT SLOSHING FREQUENCY

Attitude Pitch Minus Program, ST-124 (H42-802) (deg)

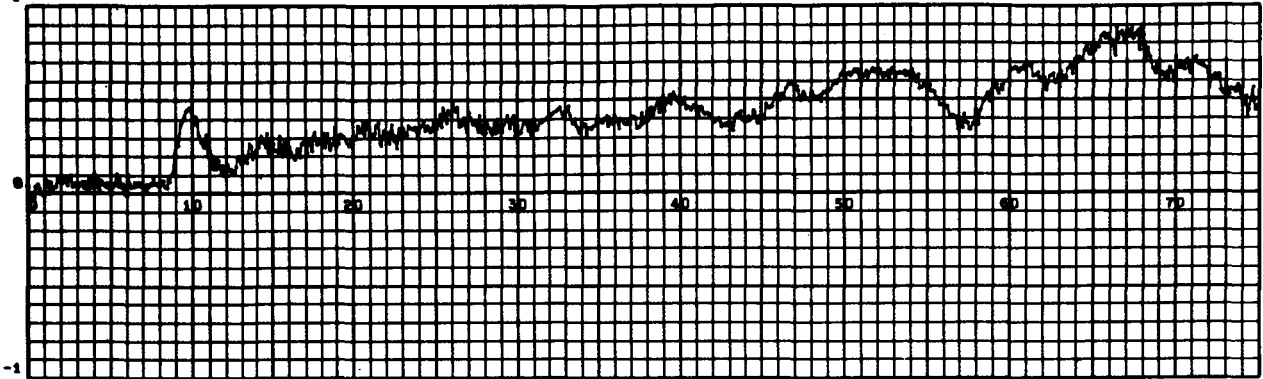

Attitude Yaw, ST-124 (H41-802) (deg)

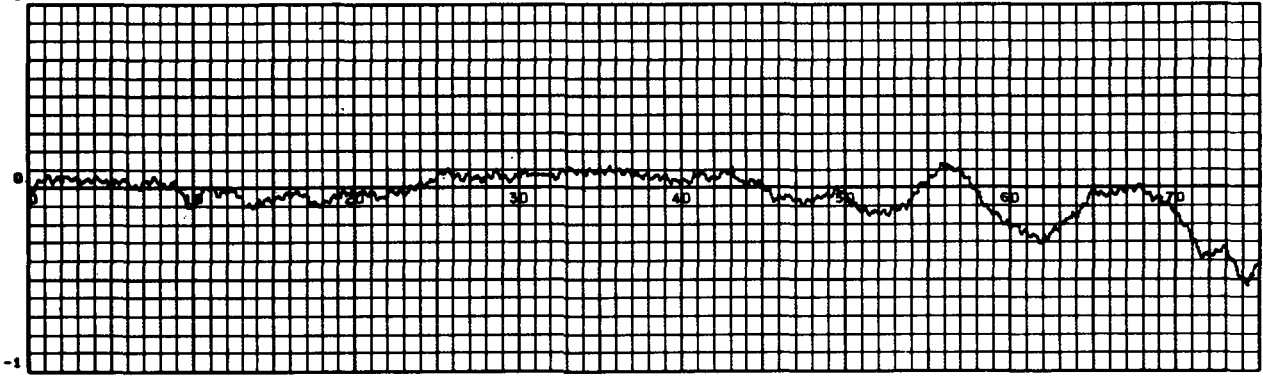

Attitude Roll Minus Program, ST-124 (H40-802) (deg)

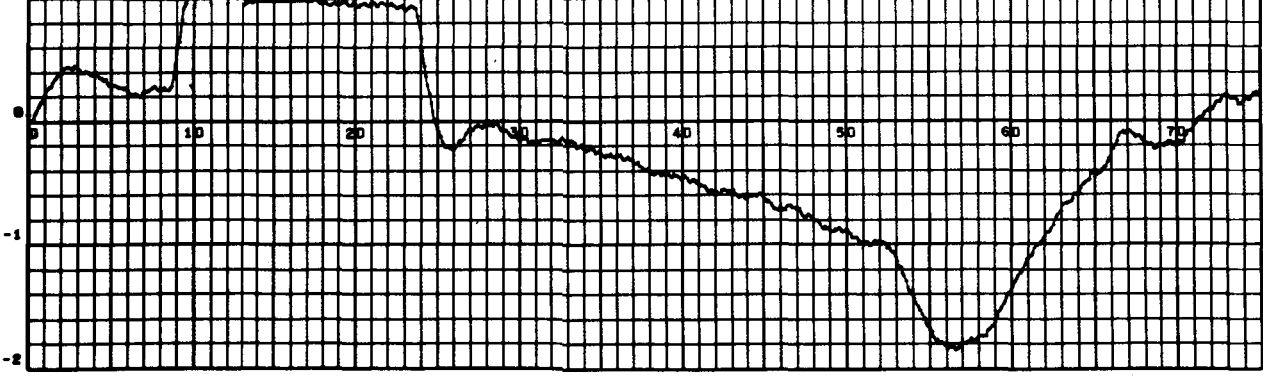

ATTITUDE ANGLES, ST-124

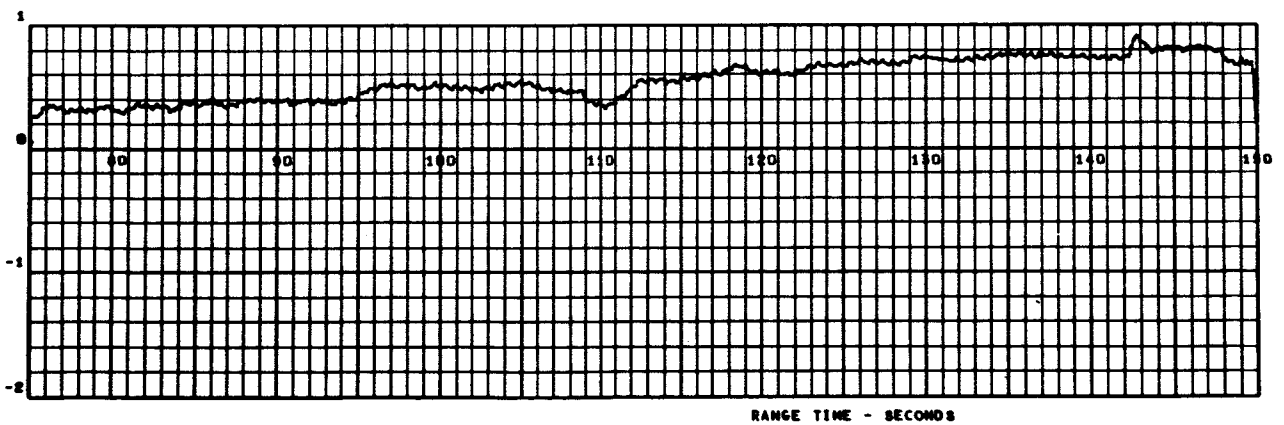
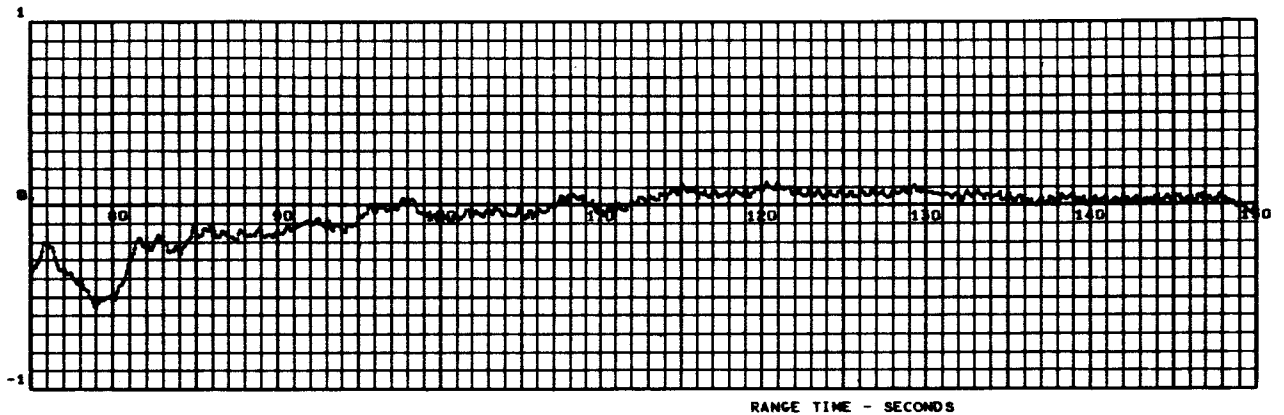
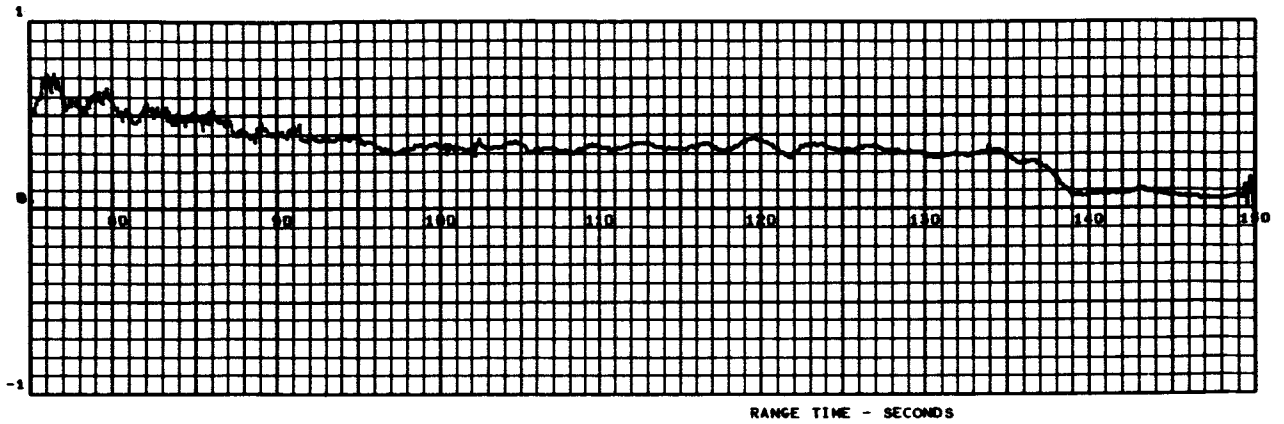

ATTITUDE ANGLES, ST-124 (CONTD)

Angular Velocity, Pitch (F42-802) (deg/sec)

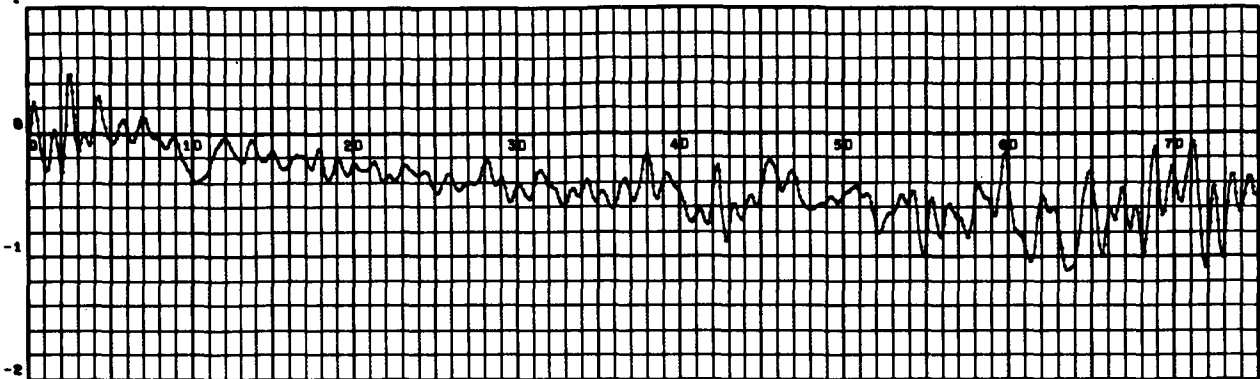

Angular Velocity, Yaw (F43-802) (deg/sec)

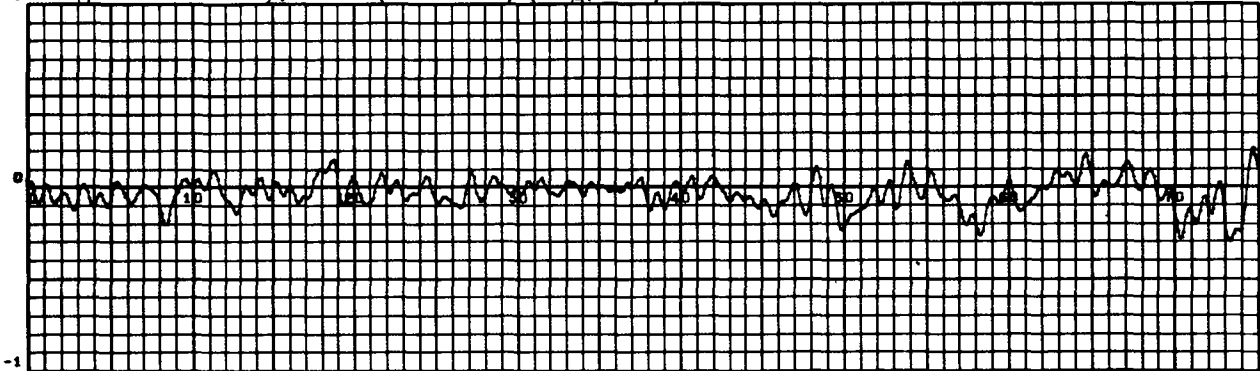

Angular Velocity, Roll (F44-802) (deg/sec)

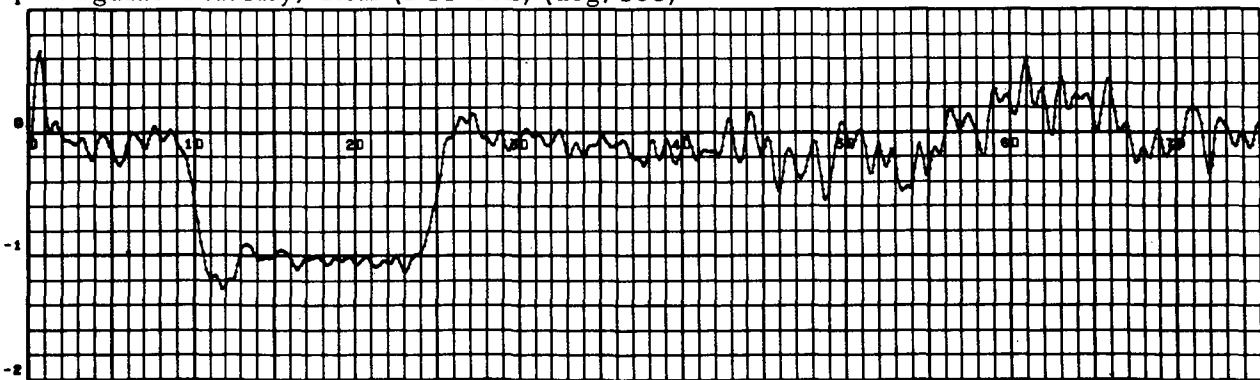

ANGULAR VELOCITIES - CONTROL RATE GYROS

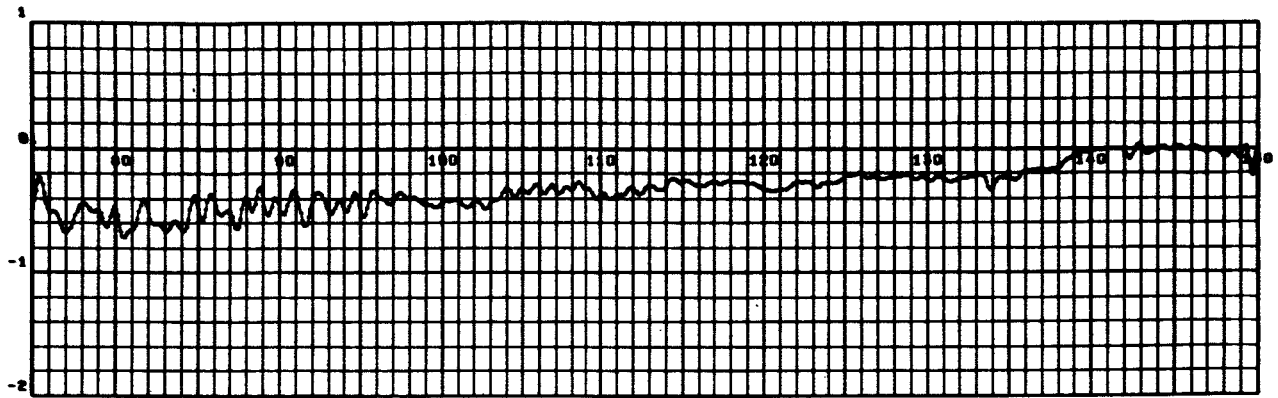

RANGE TIME - SECONDS

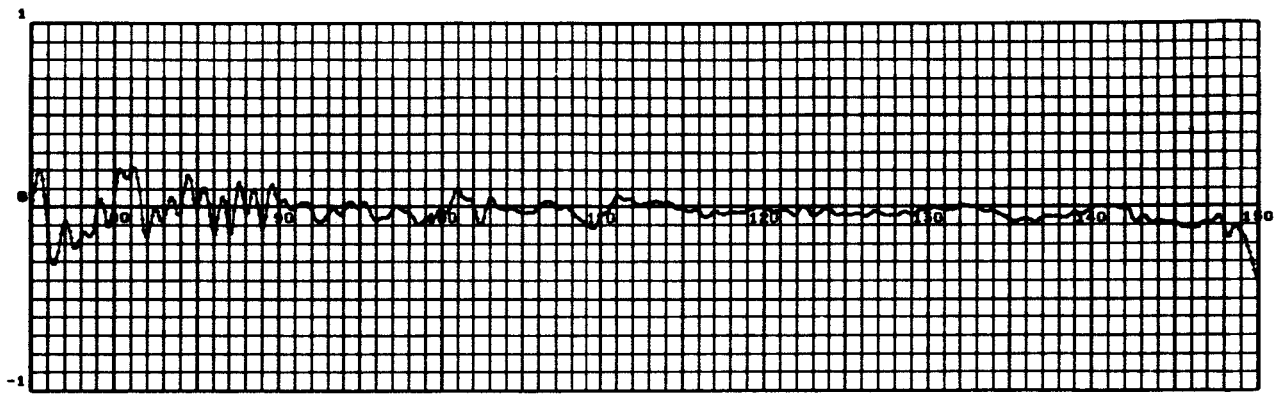

RANGE TIME - SECONDS

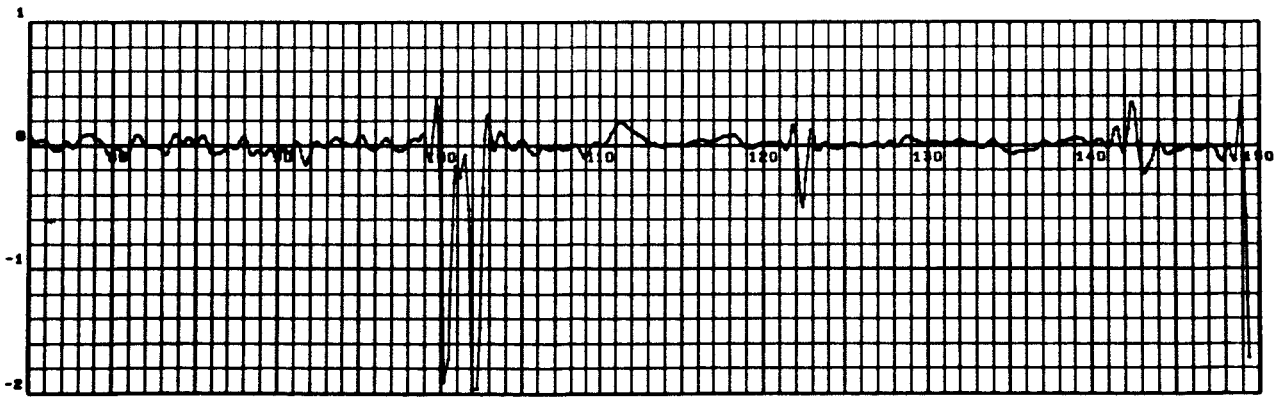

RANGE TIME - SECONDS

Angular Velocity, Pitch (F37-9) (deg/sec)

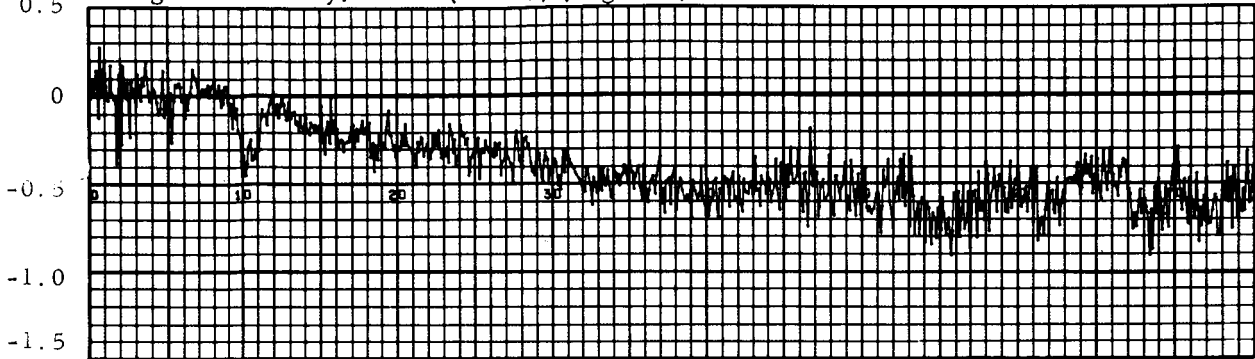

Angular Velocity, Yaw (F38-9) (deg/sec)

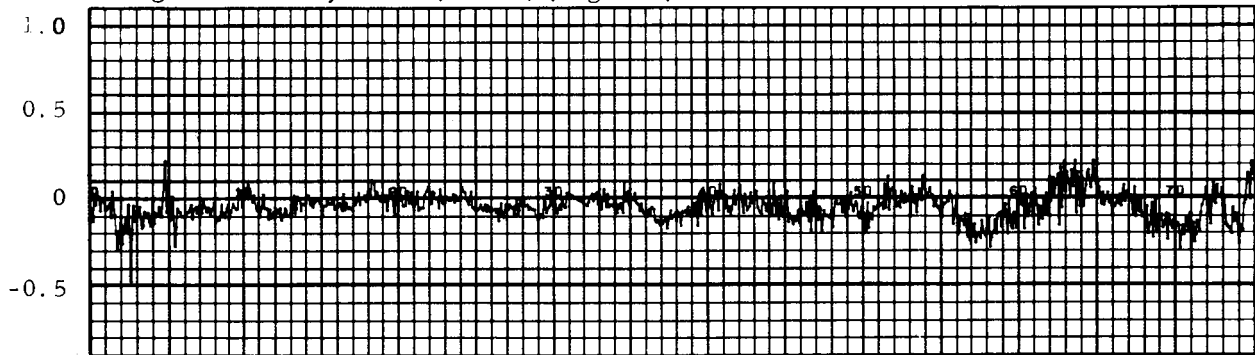

Angular Velocity, Roll (F39-9) (deg/sec)

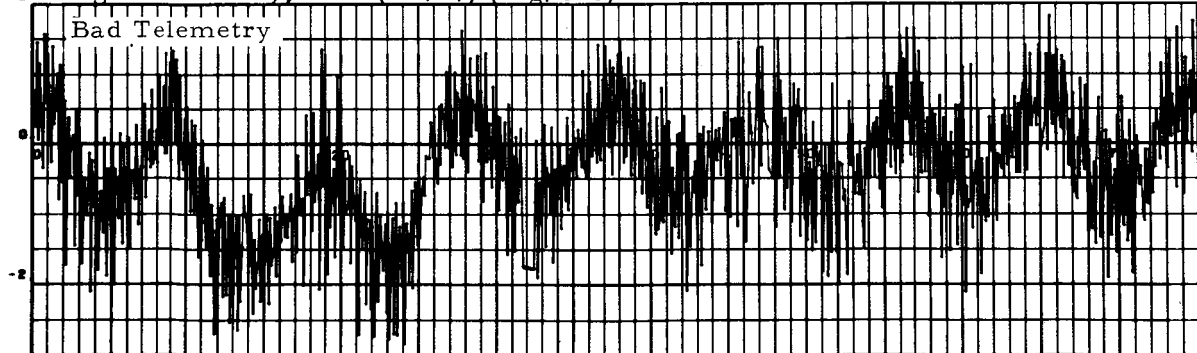

ANGULAR VELOCITIES

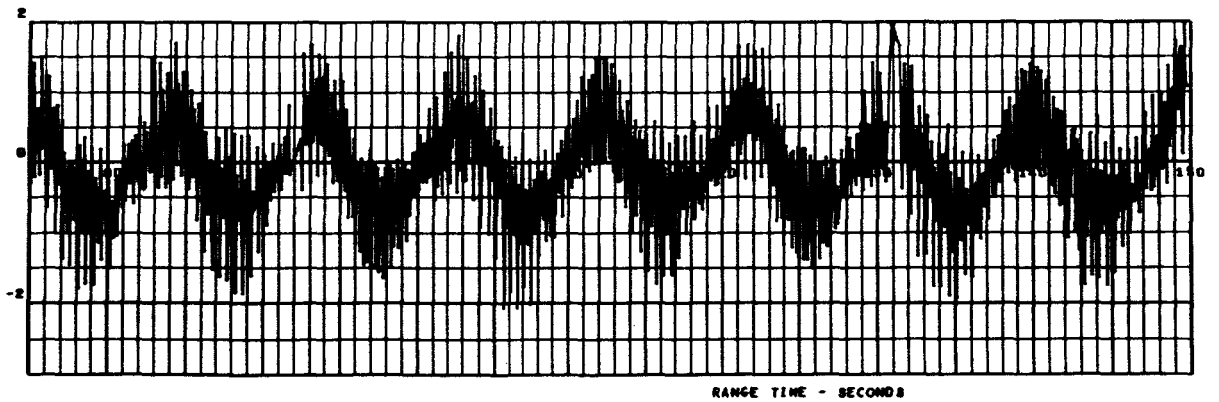
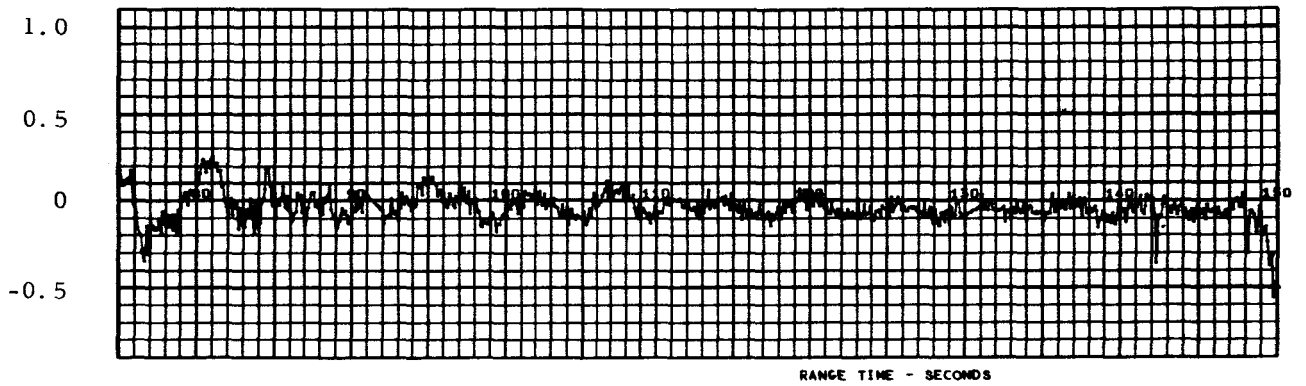
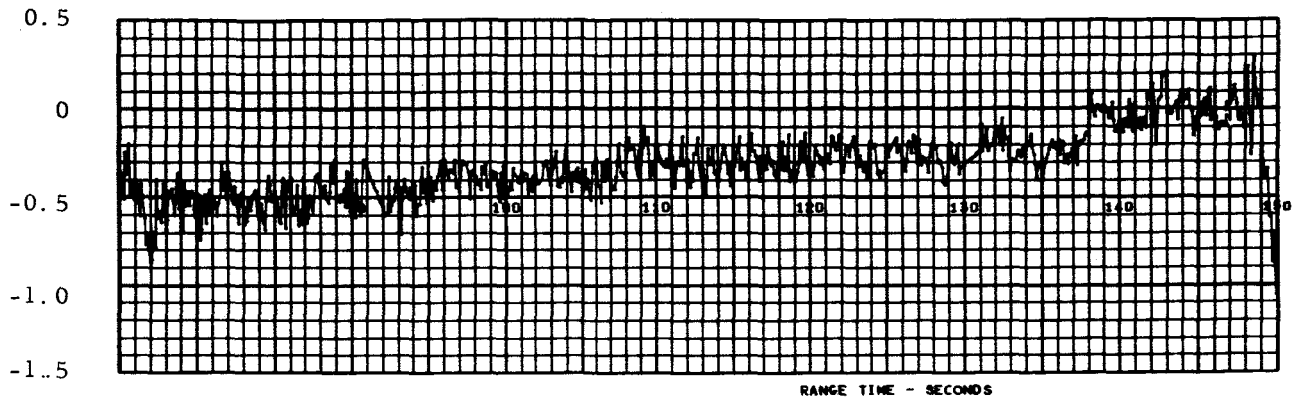

ANGULAR VELOCITIES (CONTD)

Differential Pressure Q-Ball, Pitch (D134-900)* (Psid)

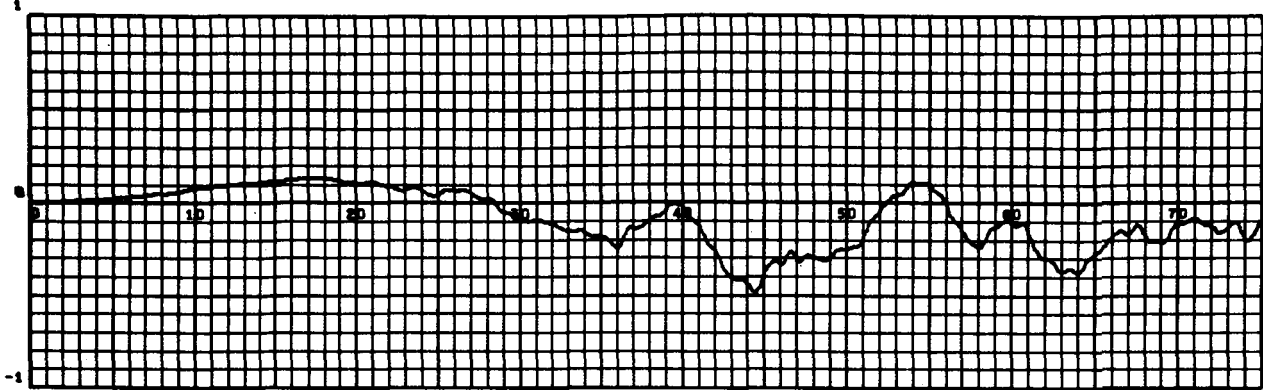

Differential Pressure Q-Ball, Yaw (D136-900)* (Psid)

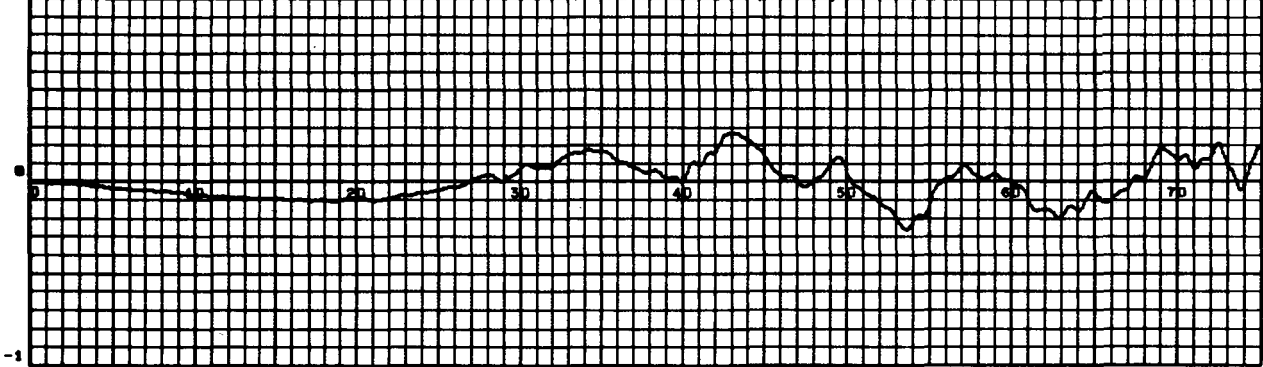

Dynamic Pressure Q-Ball (D137-900) (Psid)

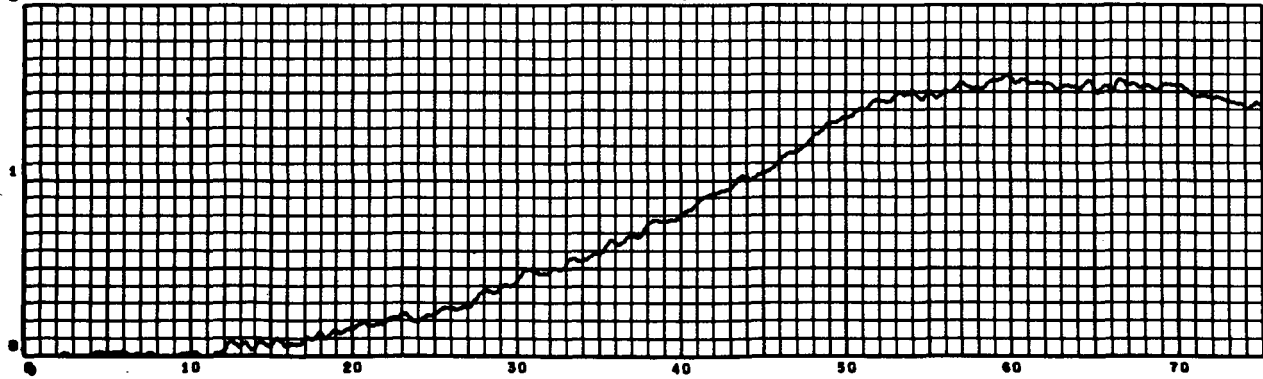

*Filtered with 31 point low pass filter

Q-BALL DIFFERENTIAL PRESSURE MEASUREMENTS

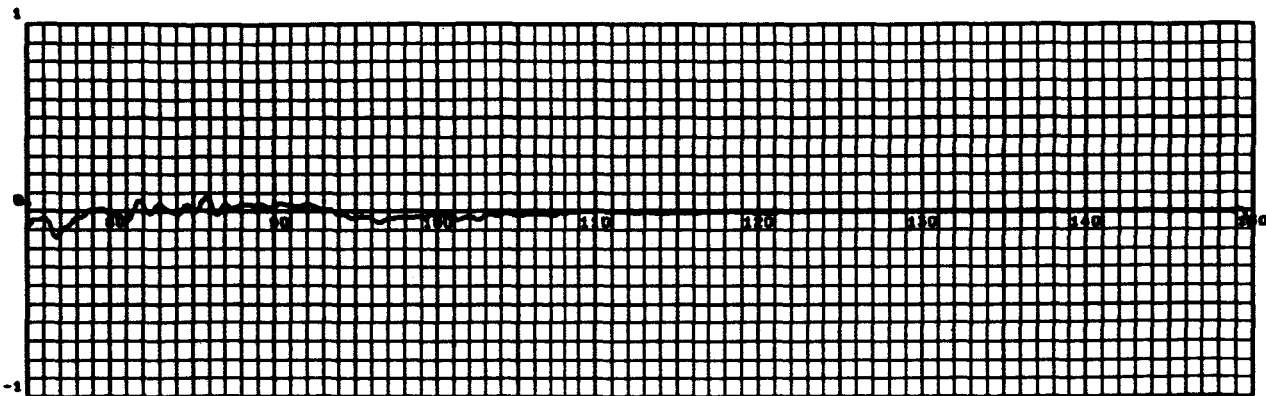

RANGE TIME - SECONDS

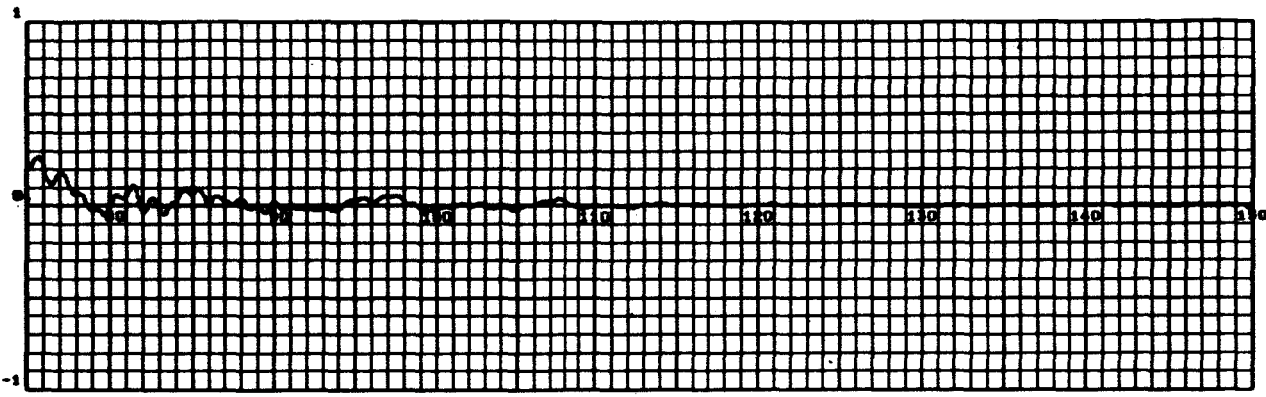

RANGE TIME - SECONDS

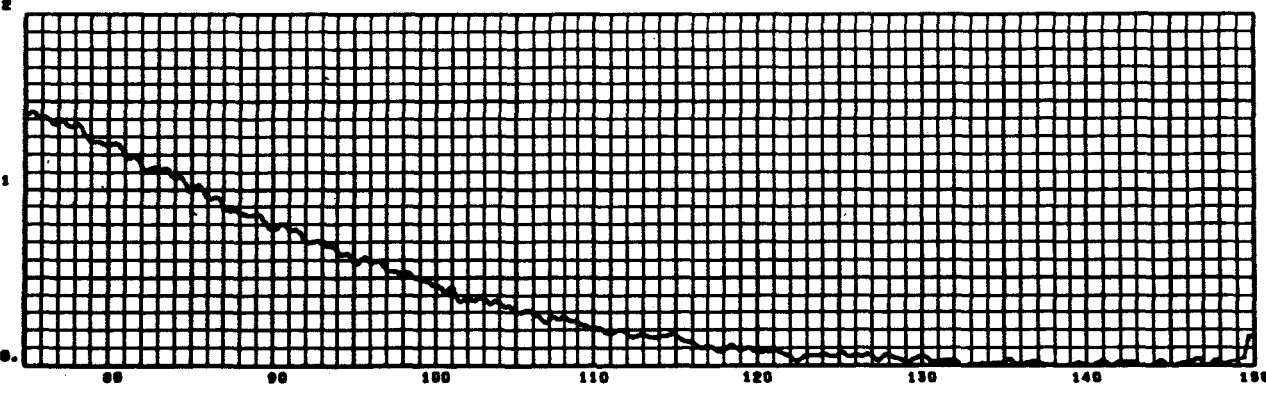

RANGE TIME - SECONDS

Q-BALL DIFFERENTIAL PRESSURE MEASUREMENTS (CONTD)

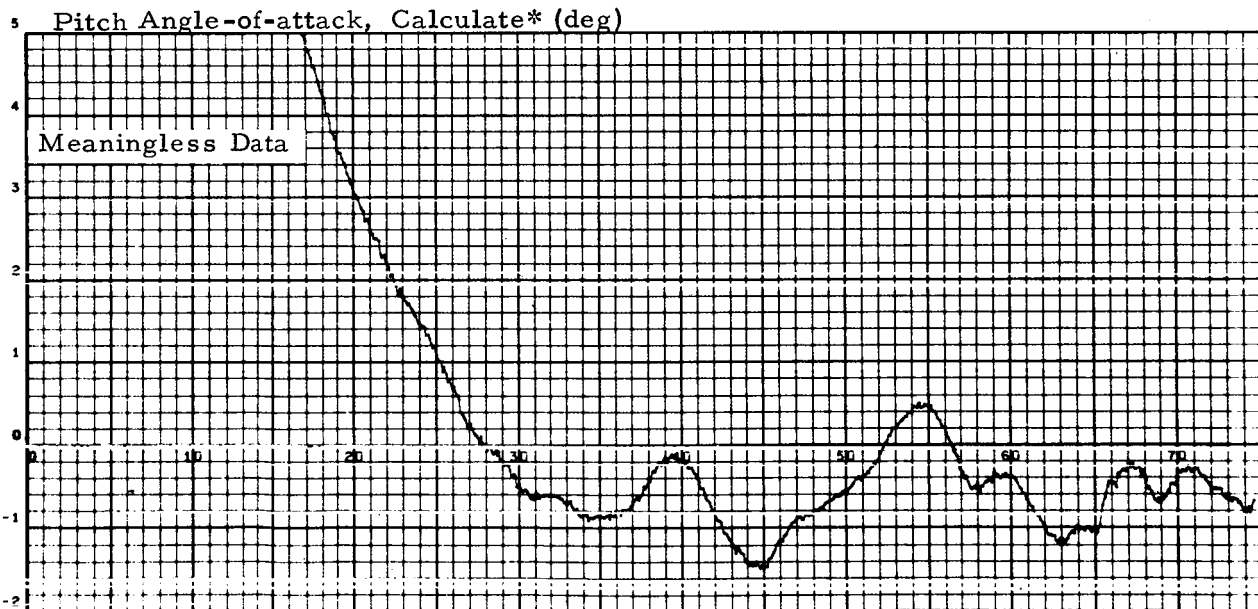
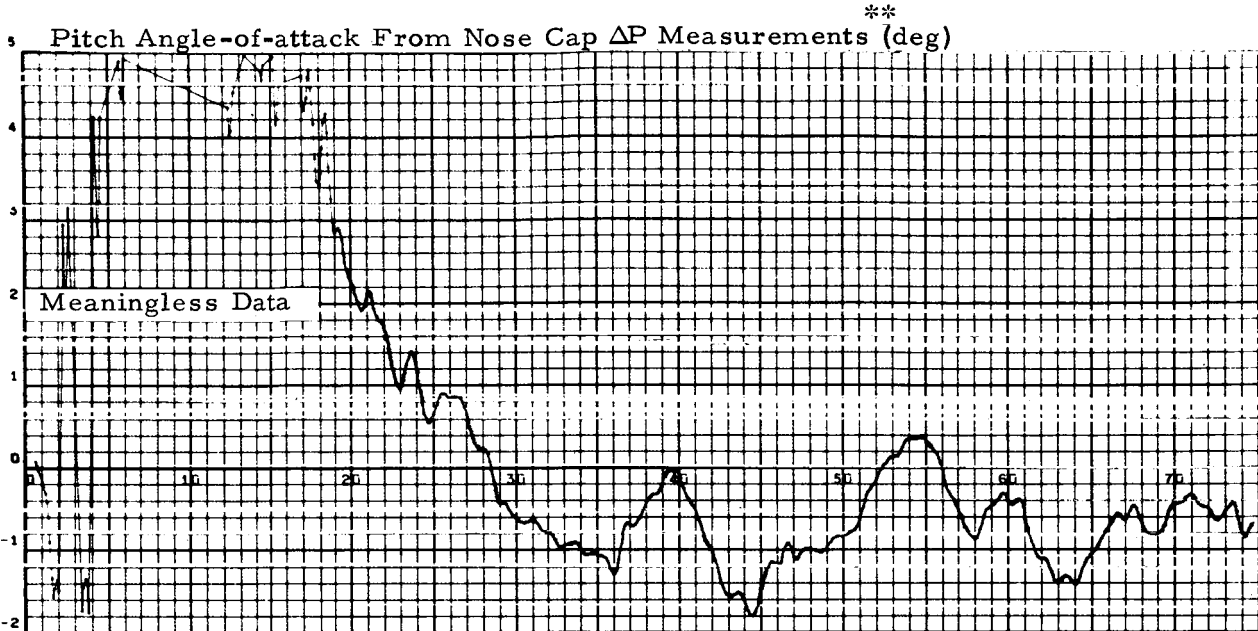

*Calculated from trajectory Angles, Attitude Angles, and Rawinsonde Wind.

**No adjustment made for the 0.2 deg measured Q-Ball misalignment.

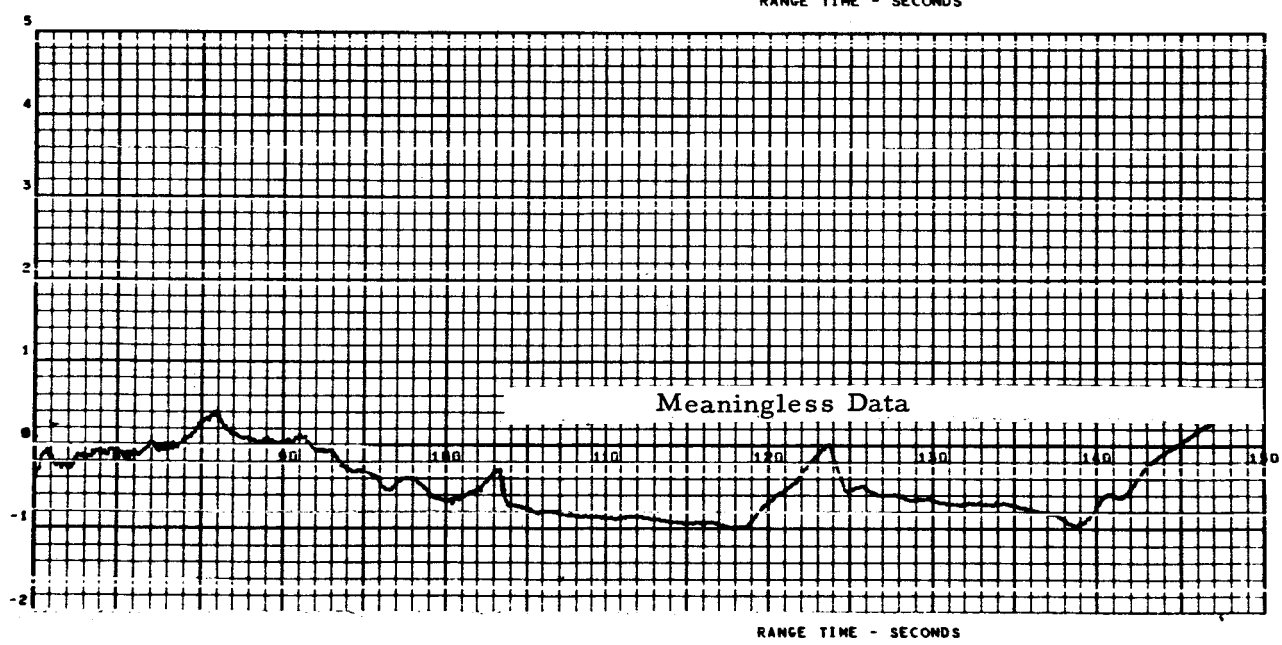
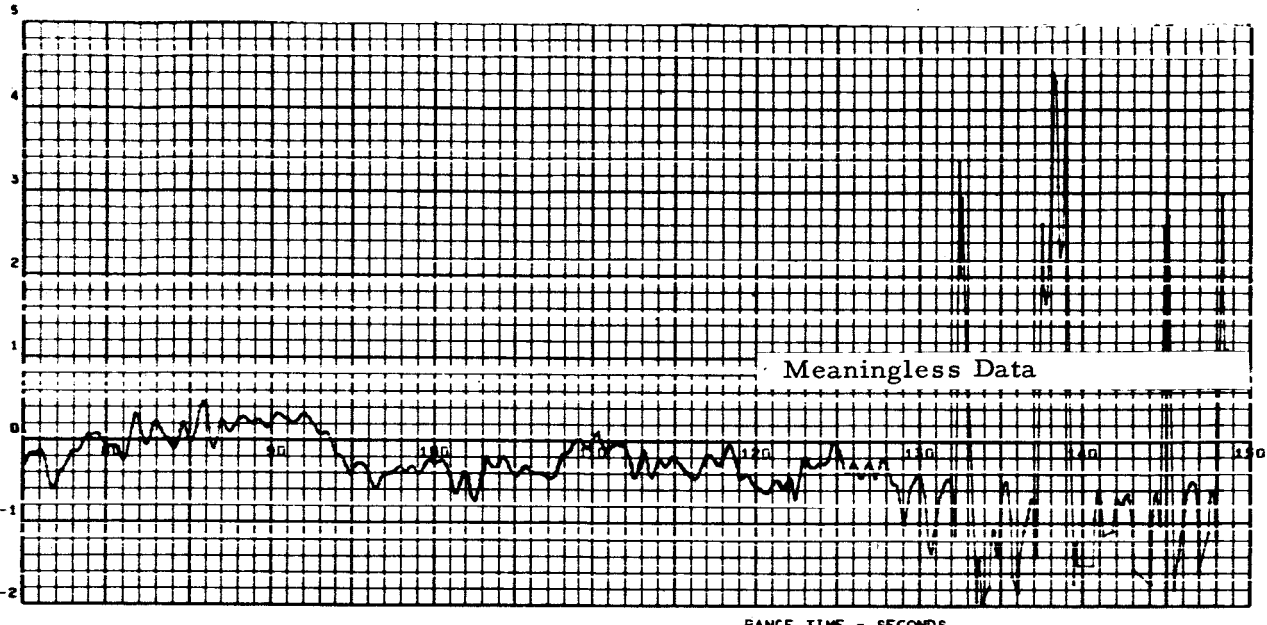

PITCH PLANE CALCULATED ANGLES-OF-ATTACK (CONTD)

1 Yaw Angle-of-Attack from Nose Cape ΔP Measurements (deg)

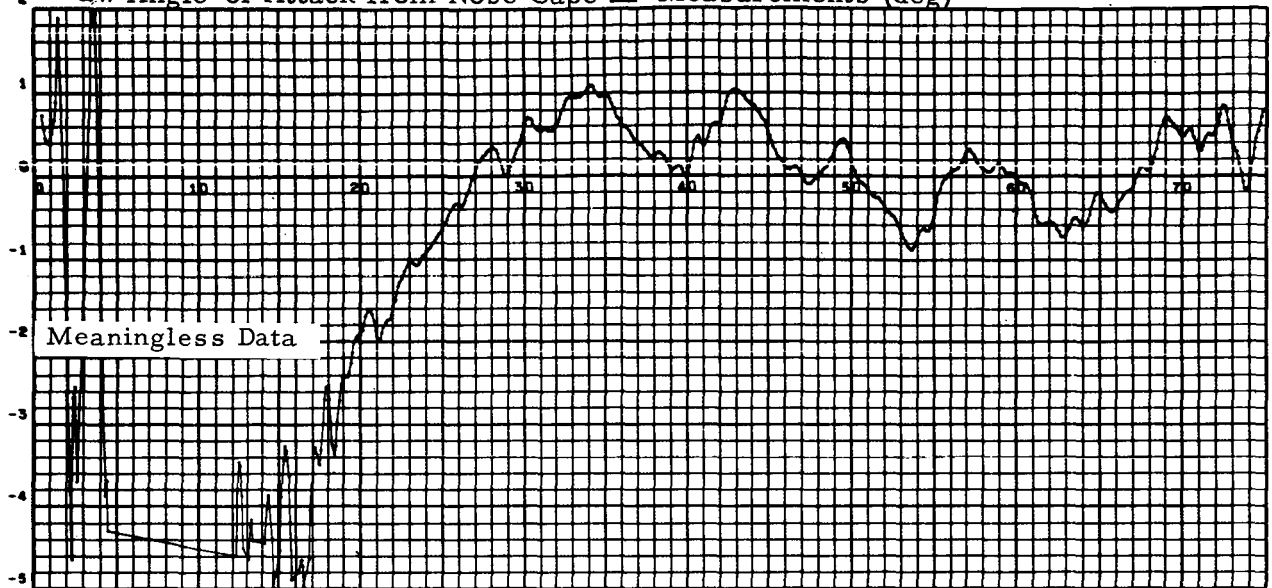

2 Yaw Angle-of-Attack, Calculated* (deg)

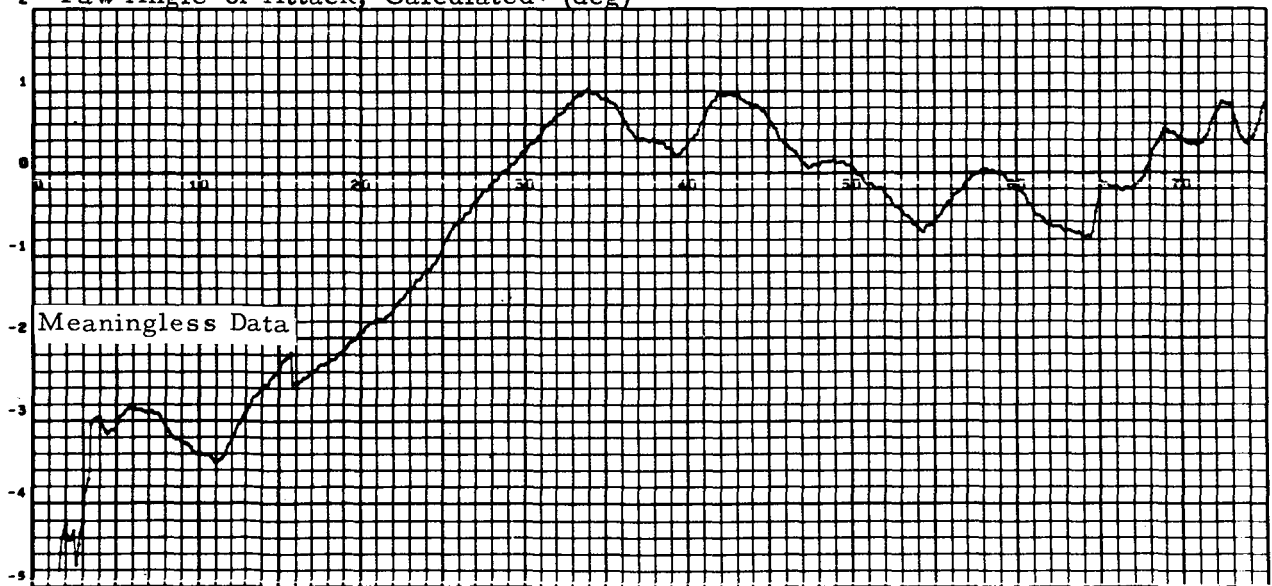

*Calculated from trajectory angles, Attitude angles, and Rawinsonde Wind.

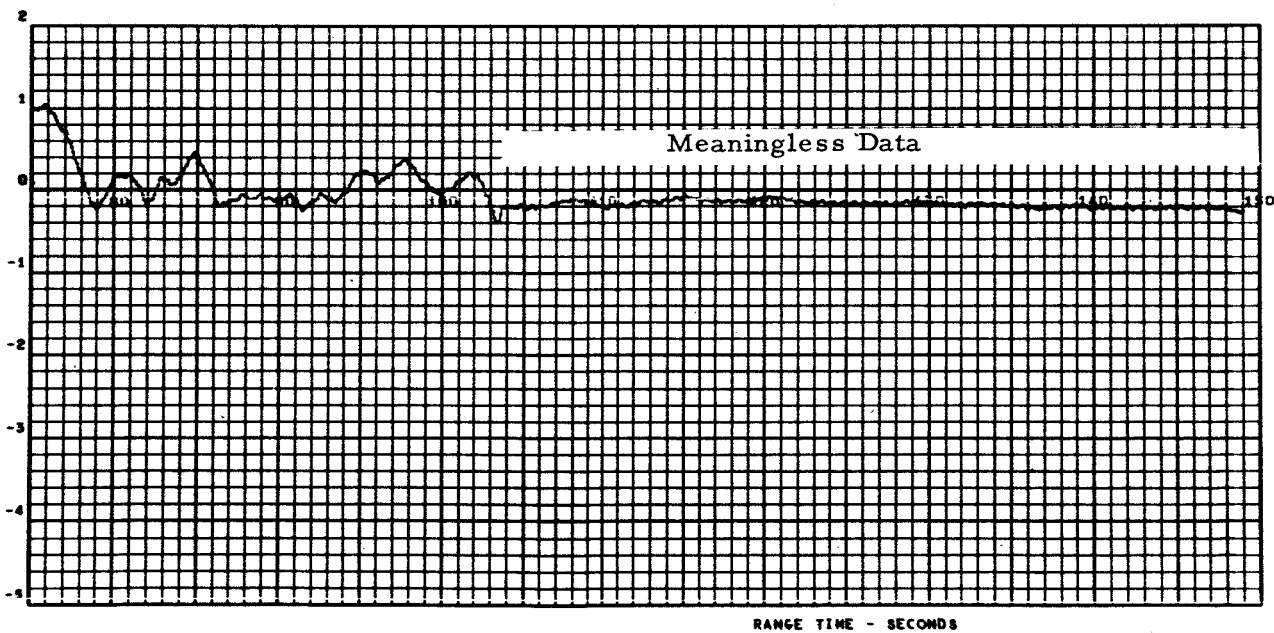
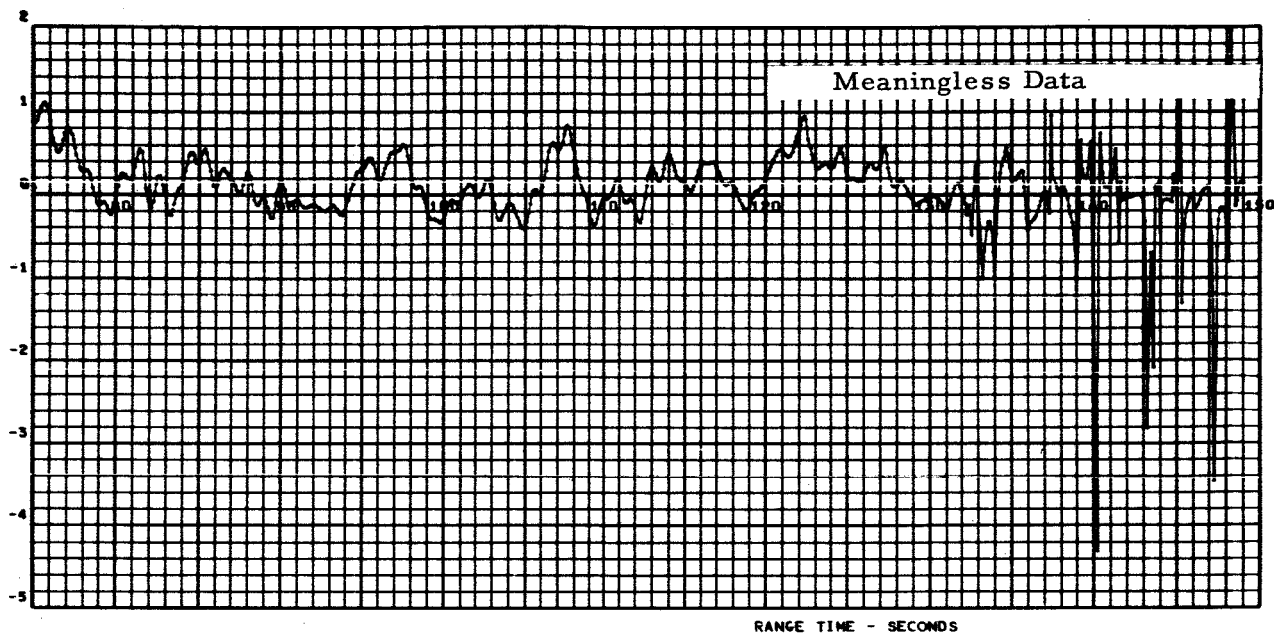

YAW PLANE CALCULATED ANGLES-OF-ATTACK (CONTD)

1 Position Pitch Actuator #1 (G1-1) (deg)

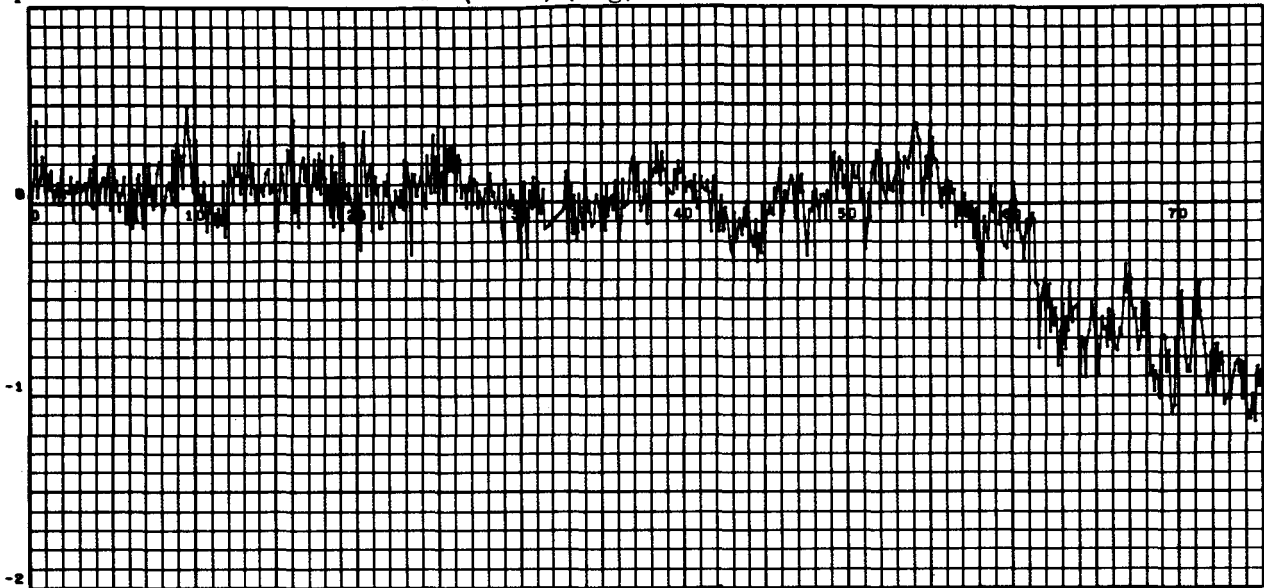

1 Position Pitch Actuator #2 (G1-2) (deg)

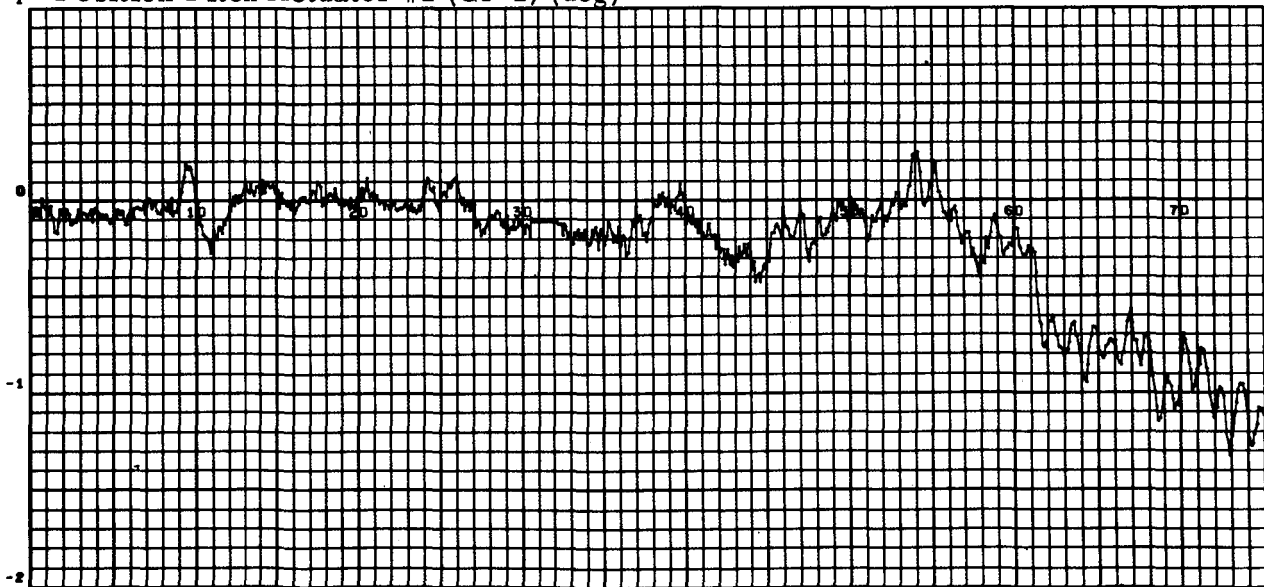

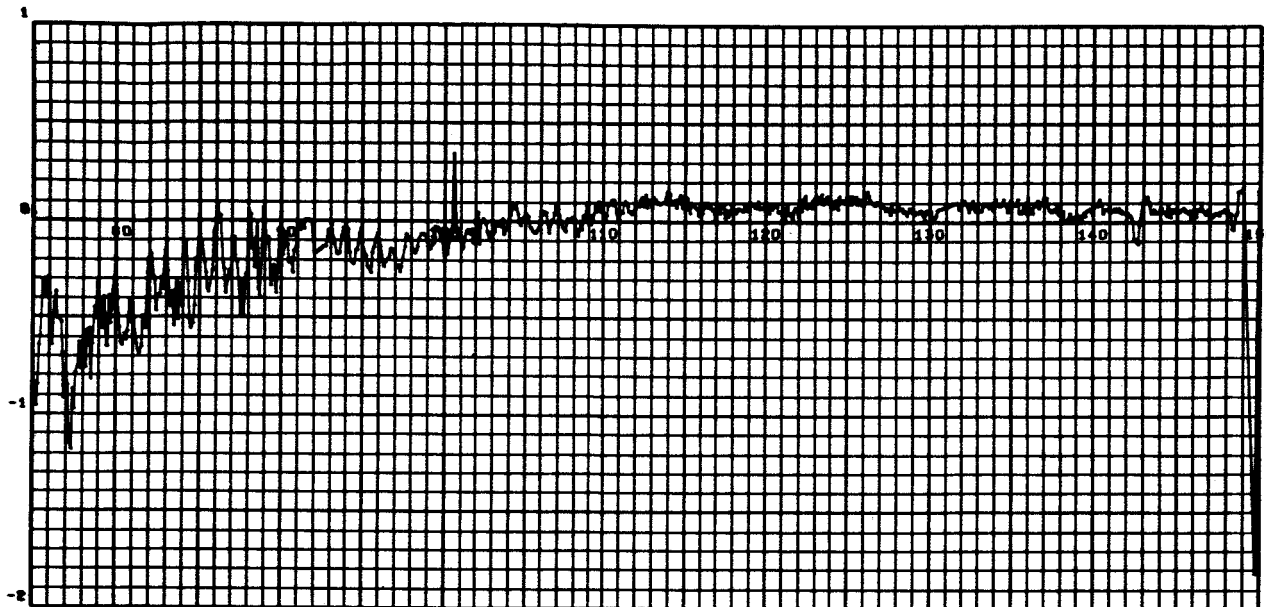

RANGE TIME - SECONDS

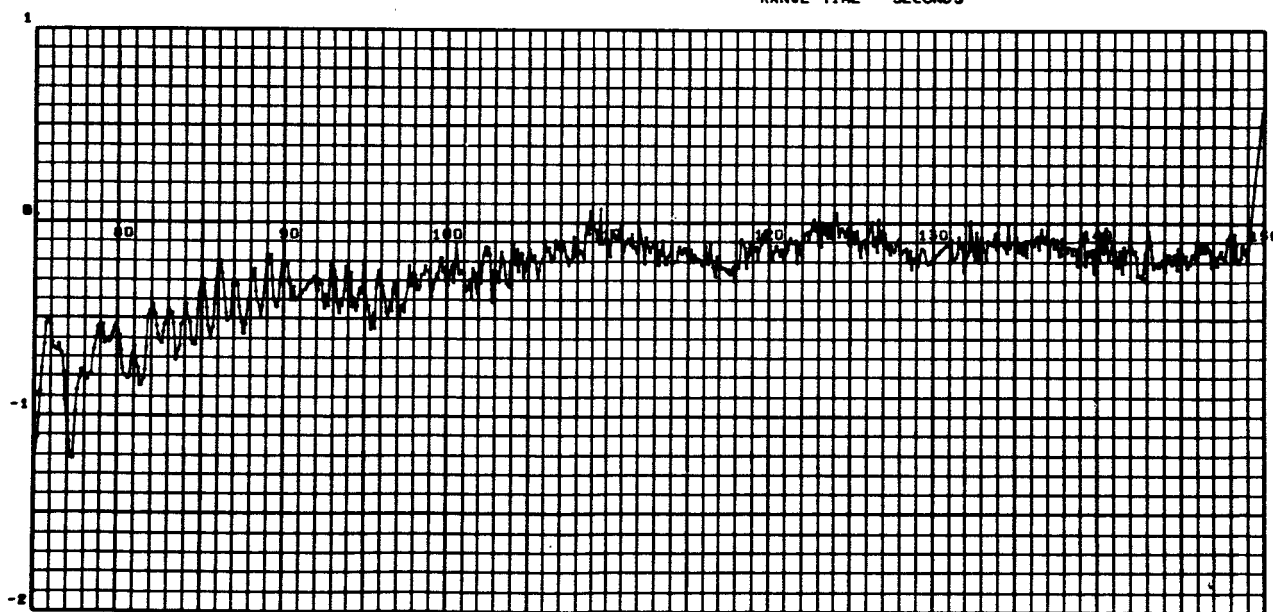

RANGE TIME - SECONDS

PITCH ACTUATOR POSITIONS (CONTD)

Position Pitch Actuator #3 (G1-3) (deg)

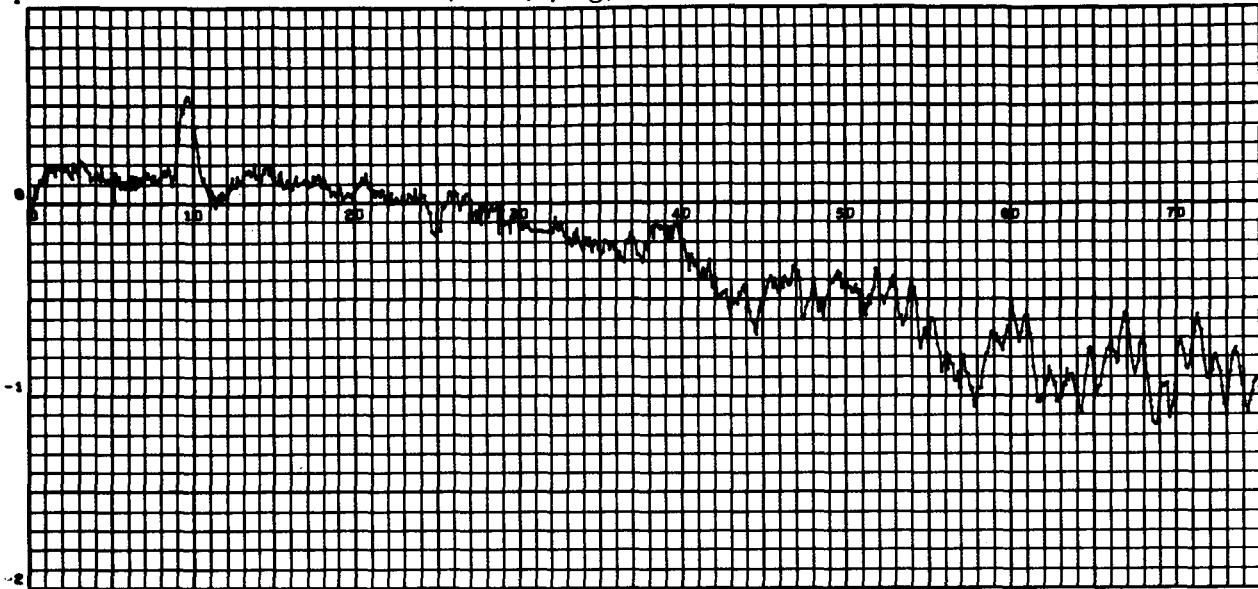

Position Pitch Actuator #4 (G1-4) (deg)

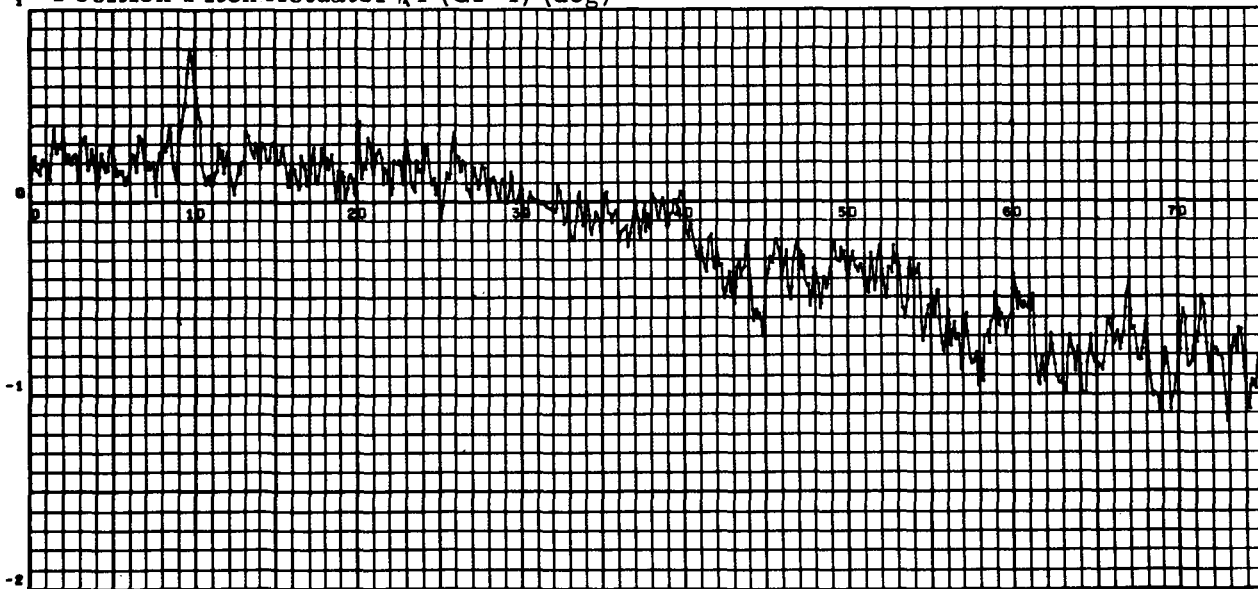

PITCH ACTUATOR POSITIONS

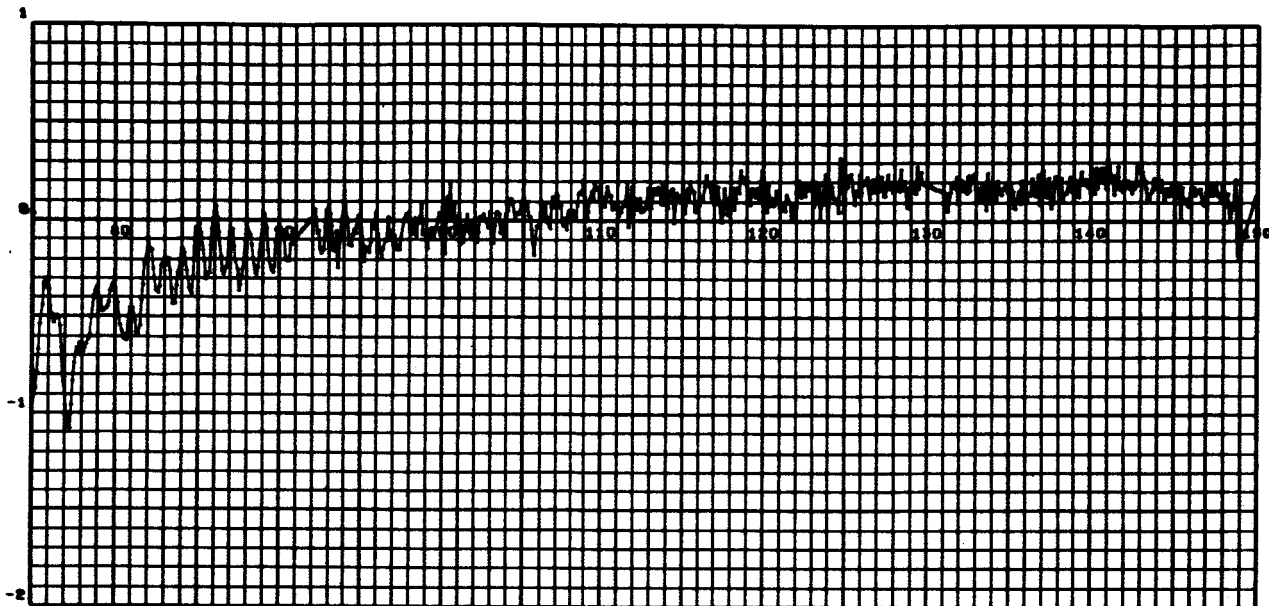

RANGE TIME - SECONDS

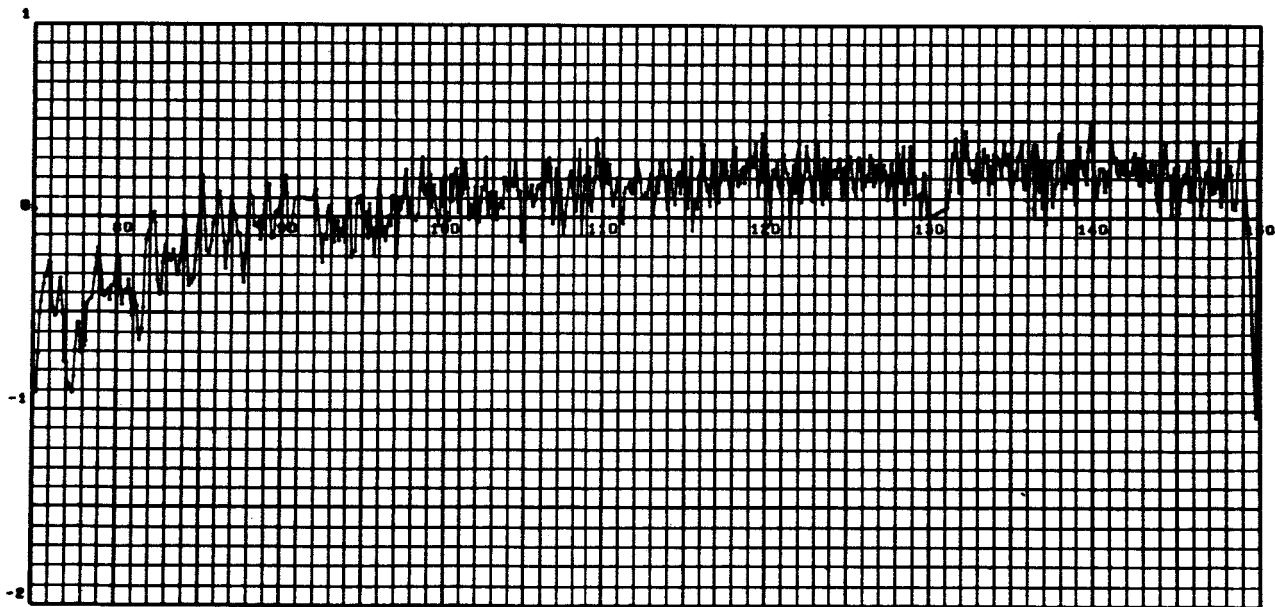

RANGE TIME - SECONDS

PITCH ACTUATOR POSITIONS (CONTD)

1 Position Yaw Actuator #1 (G2-1) (deg)

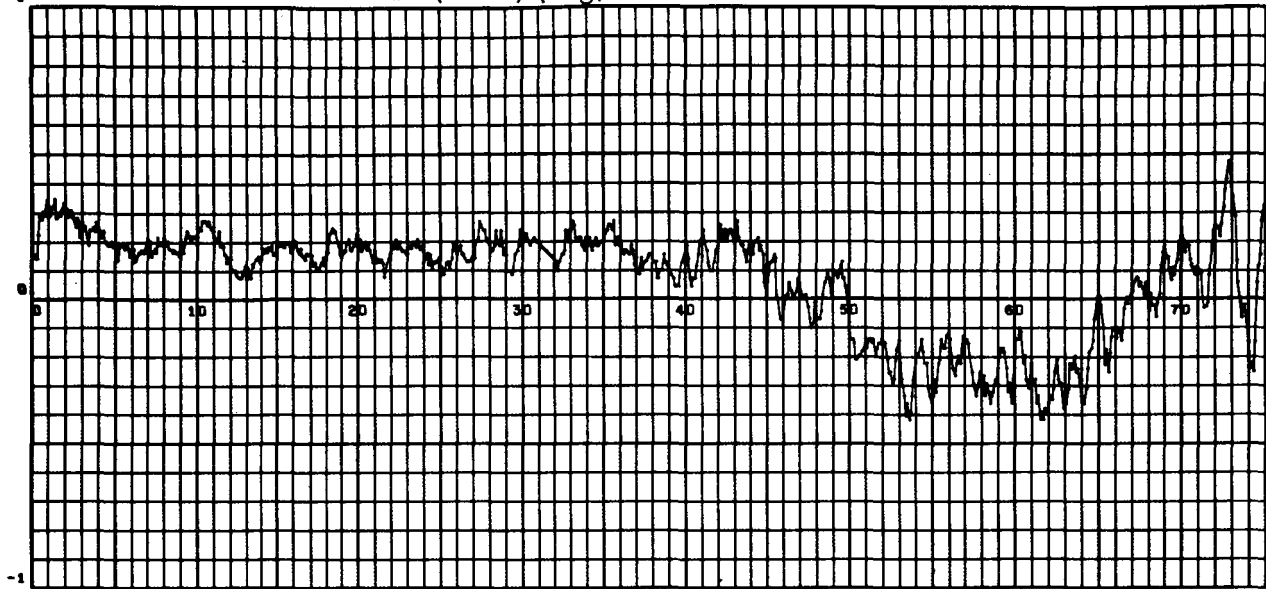

1 Position Yaw Actuator #2 (G2-2) (deg)

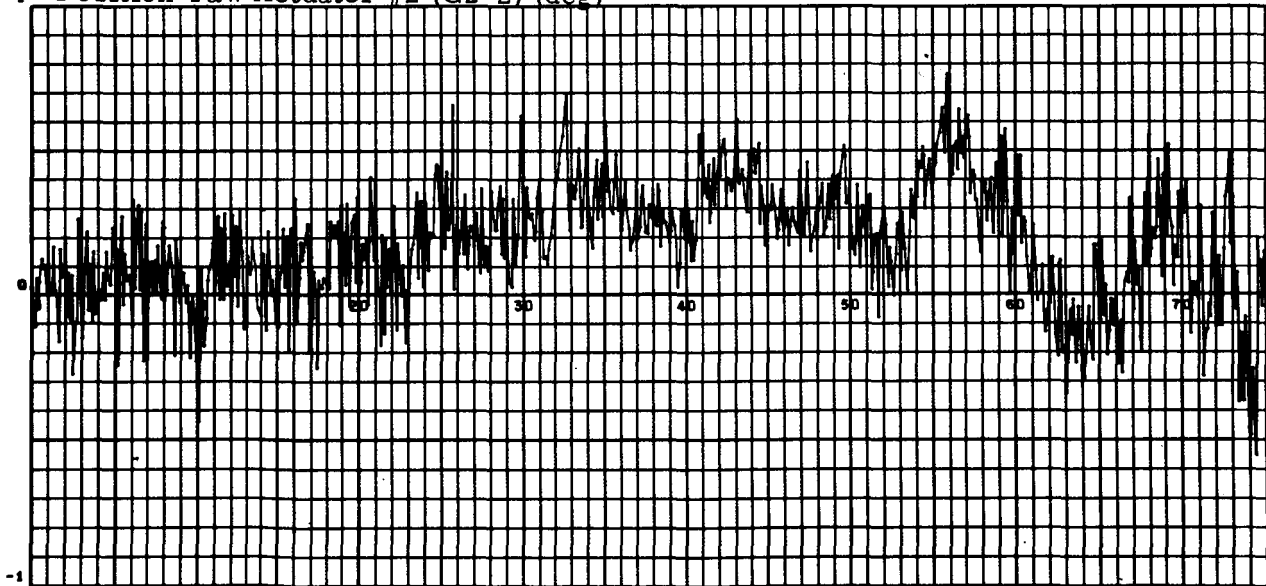

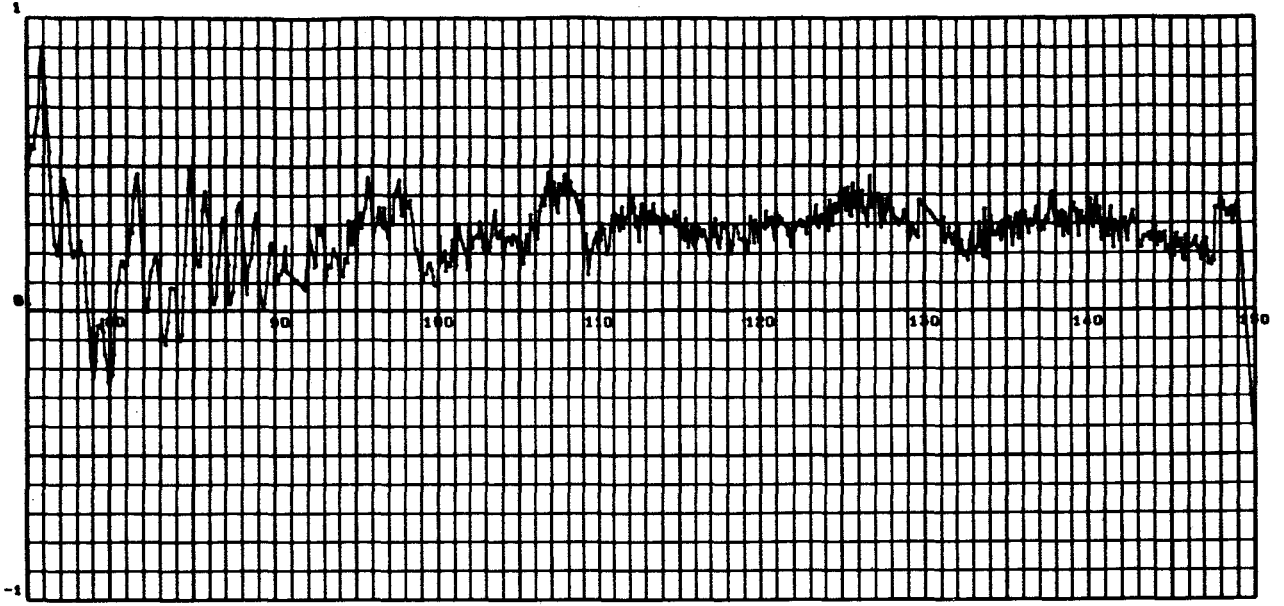

RANGE TIME - SECONDS

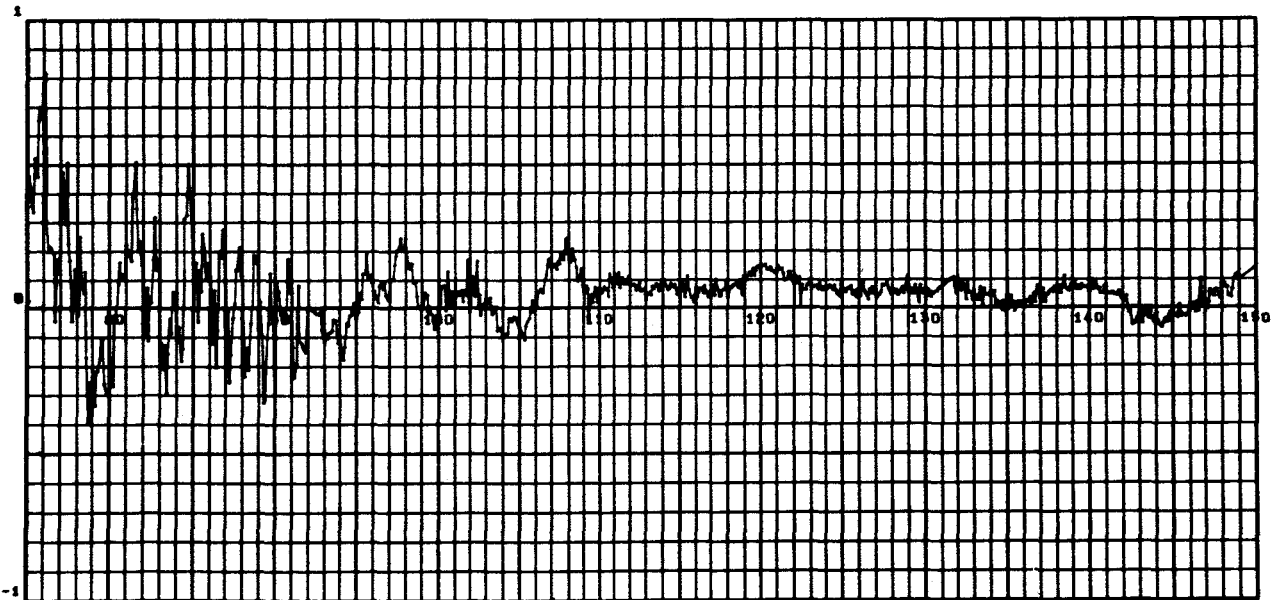

RANGE TIME - SECONDS

YAW ACTUATOR POSITIONS (CONTD)

1 Position Yaw Actuator #3 (G2-3) (deg)

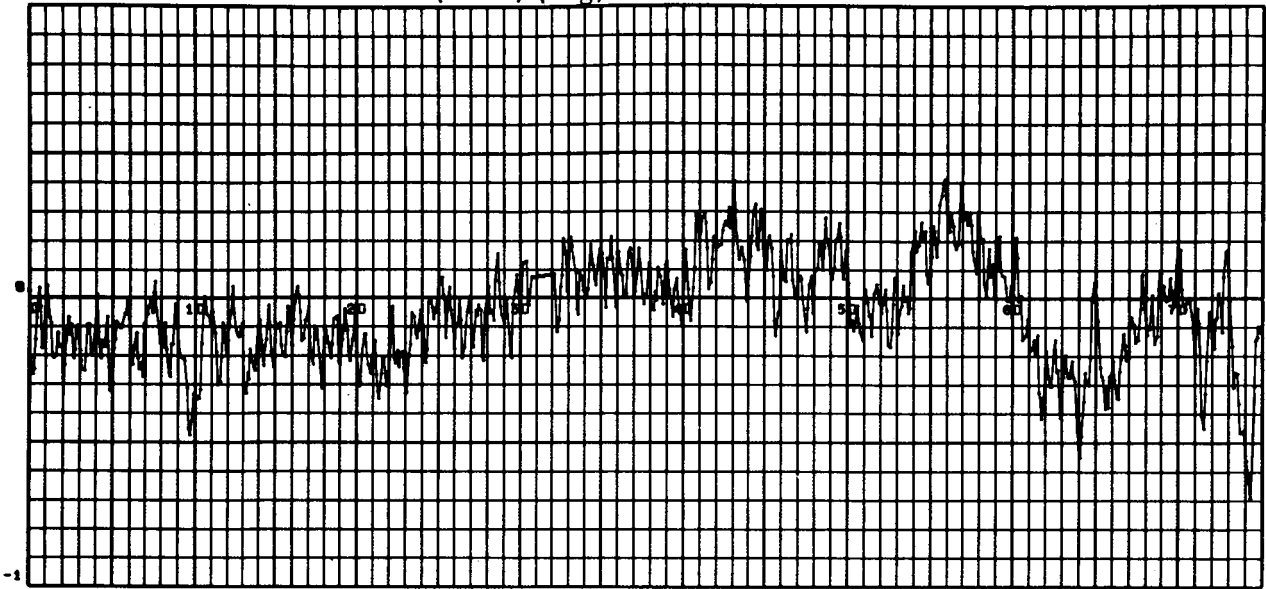

1 Position Yaw Actuator #4 (G2-4) (deg)

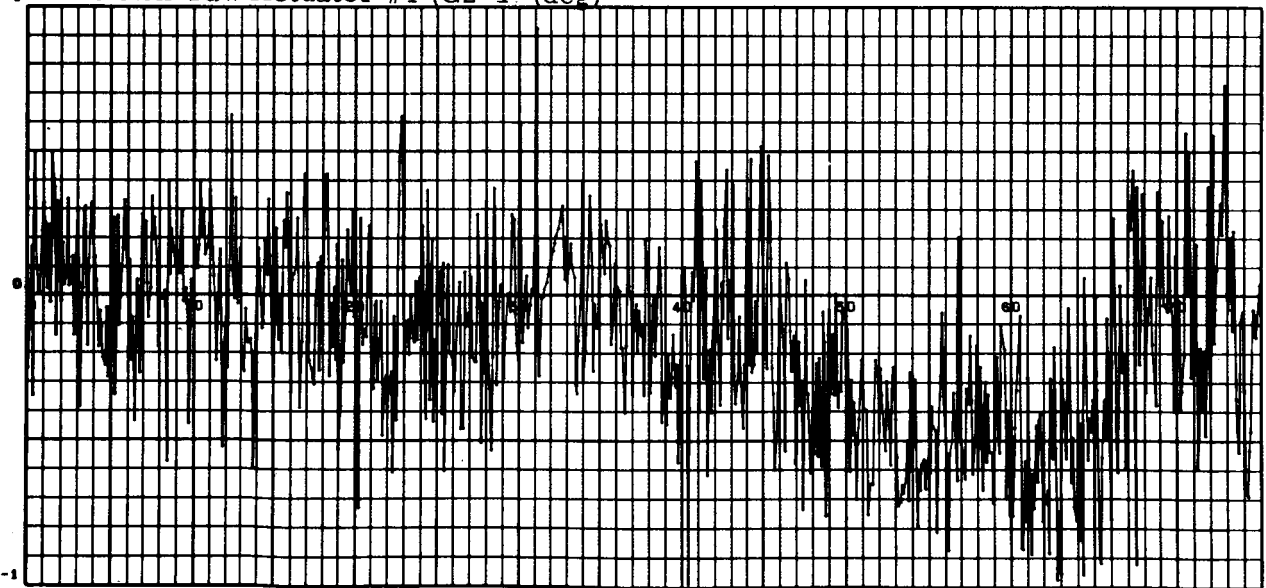

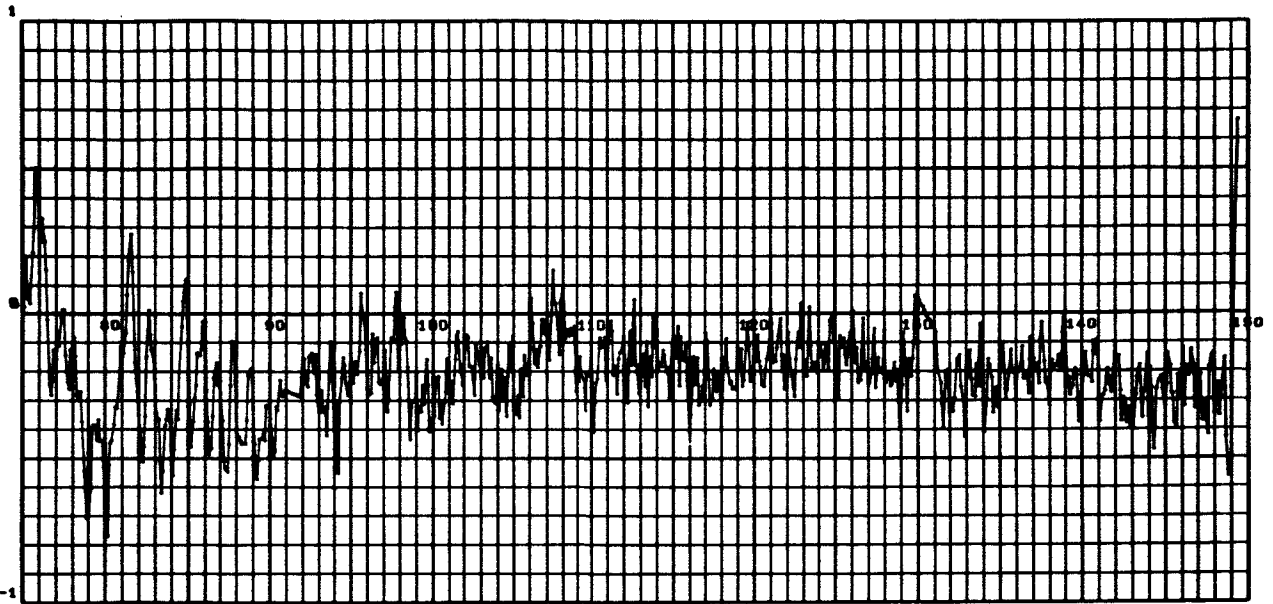

RANGE TIME - SECONDS

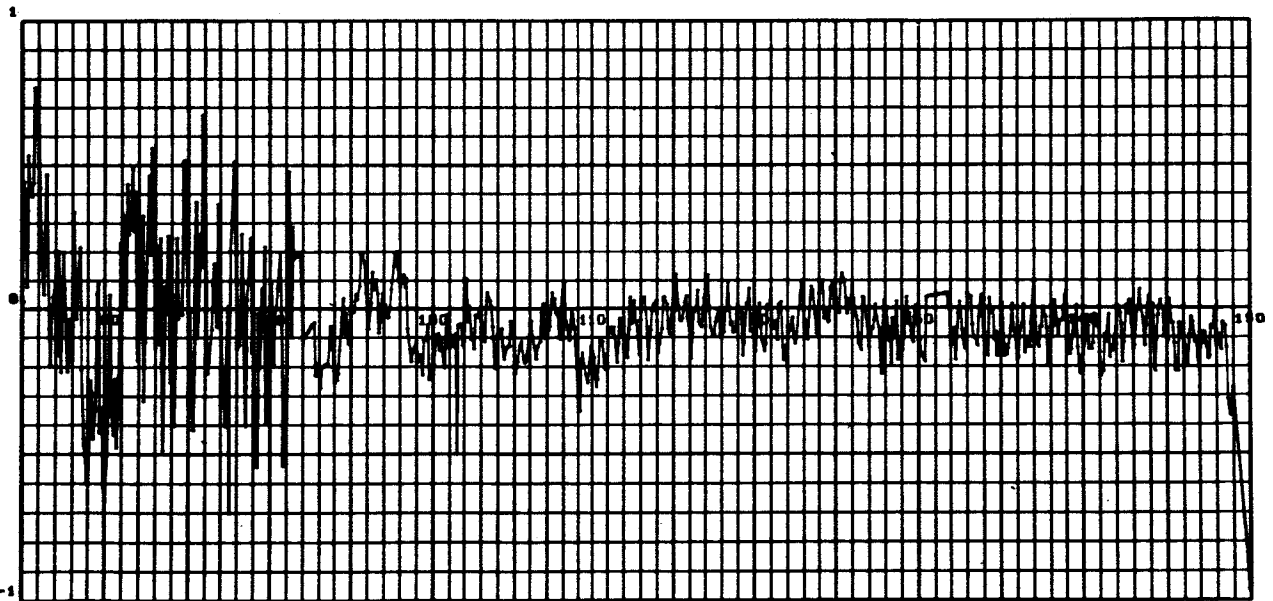

RANGE TIME - SECONDS

YAW ACTUATOR POSITIONS (CONTD)

1 Actuator Position Pitch (average) = $1/4 [(G1-1) + (G1-2) + (G1-3) + (G1-4)]$ (deg)

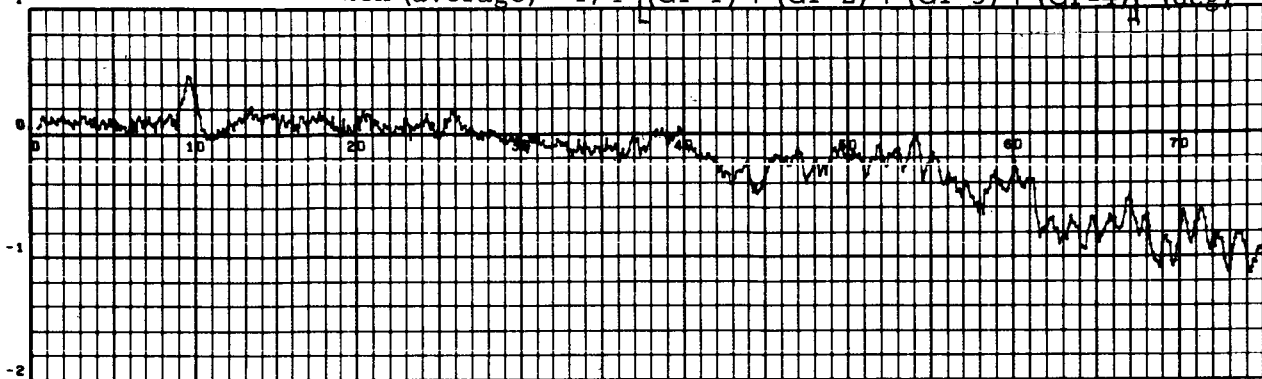

1 Actuator Position Yaw (Average) = $1/4 [(G2-1) + (G2-2) + (G2-3) + (G2-4)]$ (deg)

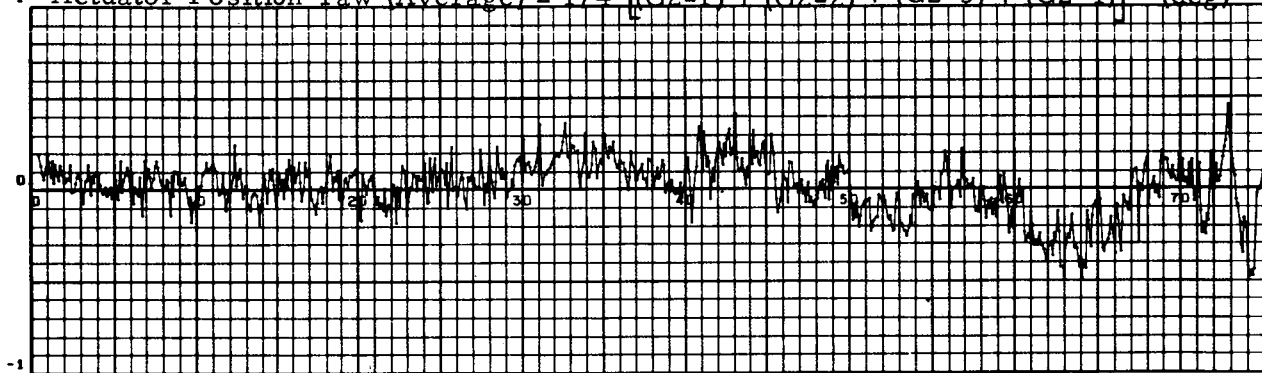

1 Actuator Position Roll (average) = $1/8 [(G2-1) - (G1-1) - (G2-2) + (G1-3) - (G2-3) + (G1-4) + (G1-2) + (G2-4)]$ (deg)

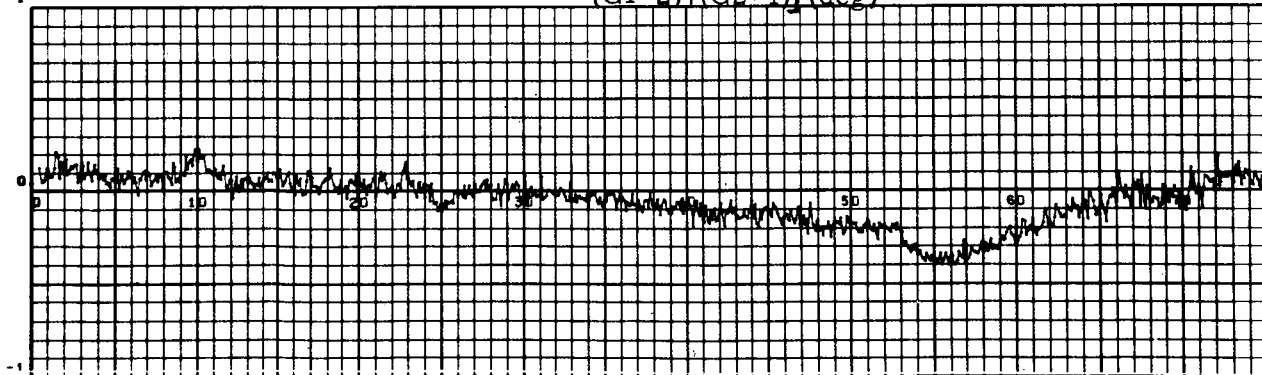

AVERAGE FLIGHT PLANE ACTUATOR POSITIONS

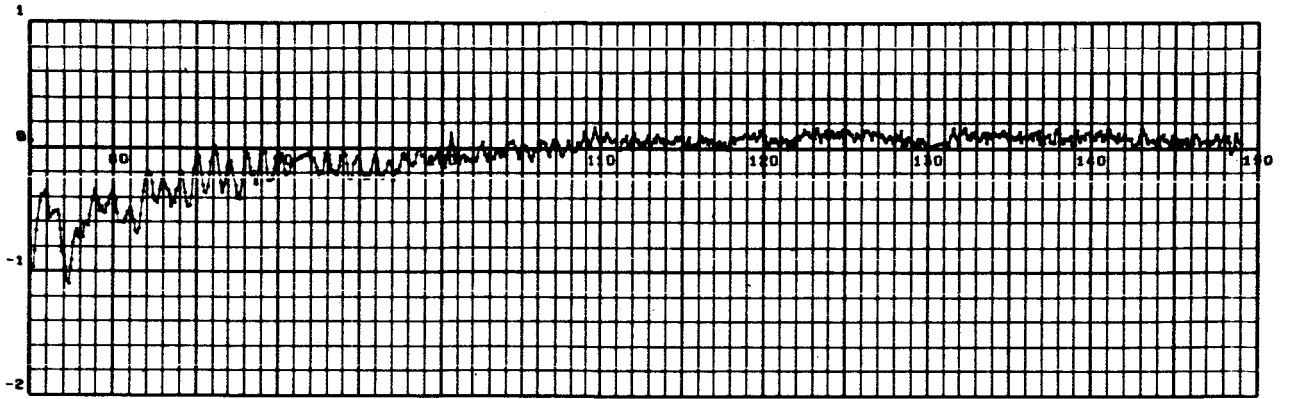

RANGE TIME - SECONDS

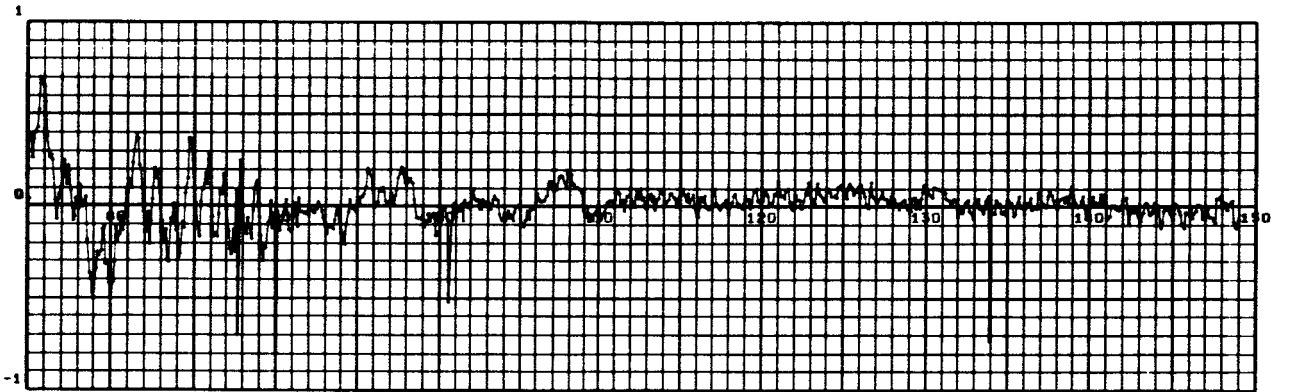

RANGE TIME - SECONDS

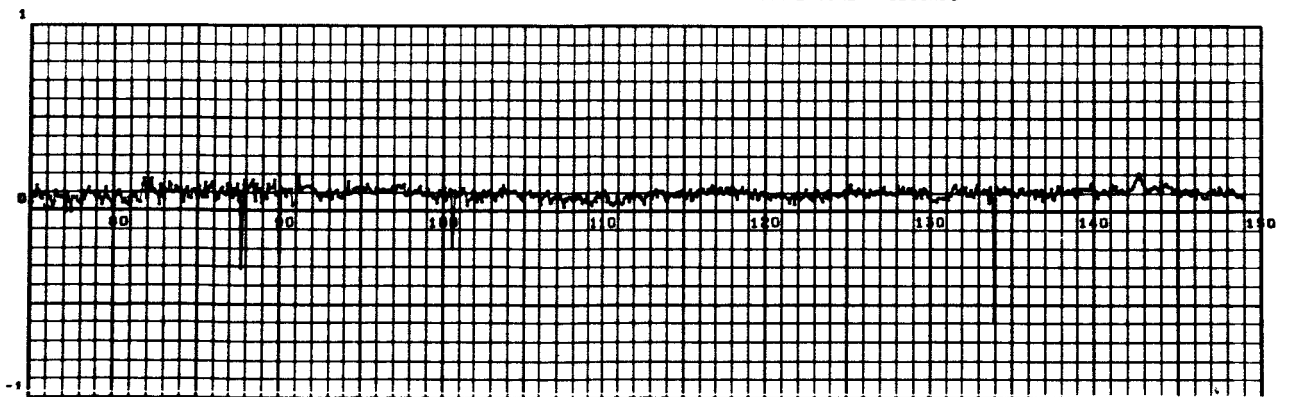

RANGE TIME - SECONDS

AVERAGE FLIGHT PLANE ACTUATOR POSITIONS (CONTD)

2 Acceleration Pitch Control, Filtered* (F40-802) (m/sec²)

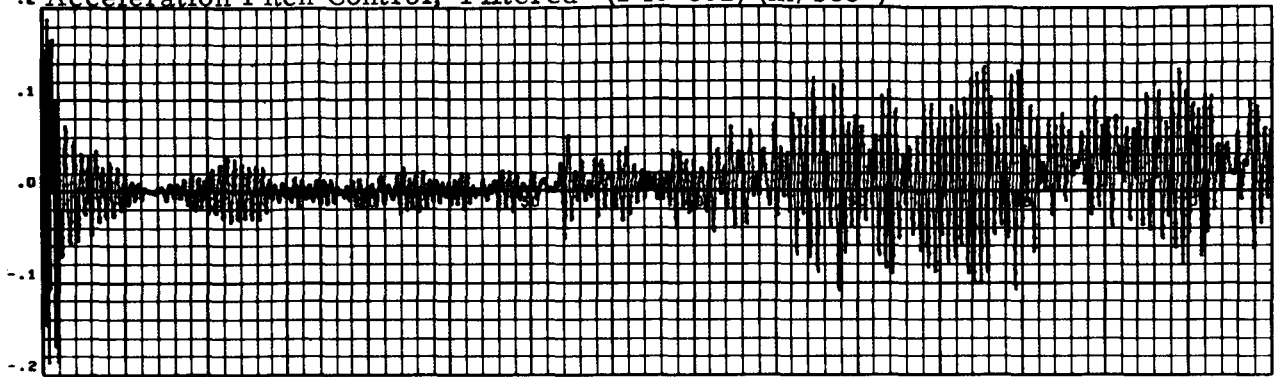

2 Acceleration Yaw Control, Filtered* (F41-802) (m/sec²)

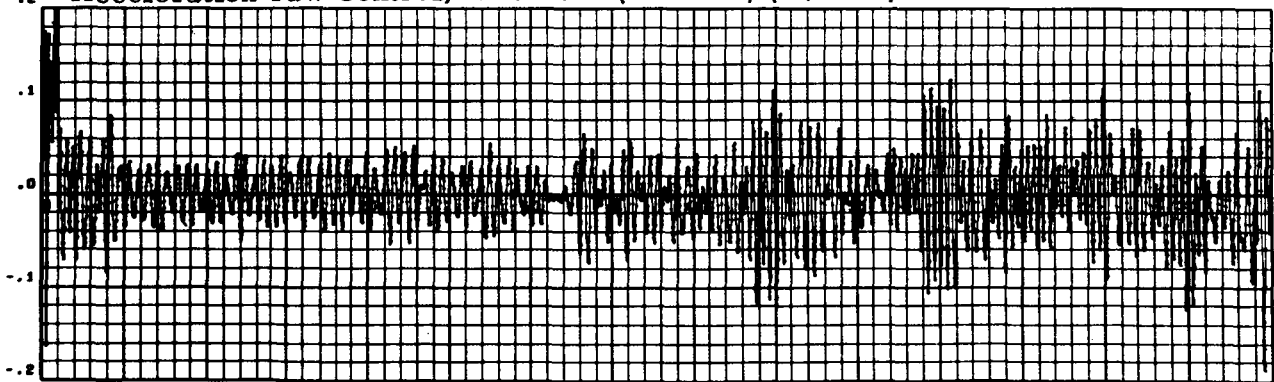

*Filtered Digitally Using a 101 Point band pass filter around the First Bending Mode Frequency.

2 Acceleration Pitch Control, Filtered* (F40-802) (m/sec²)

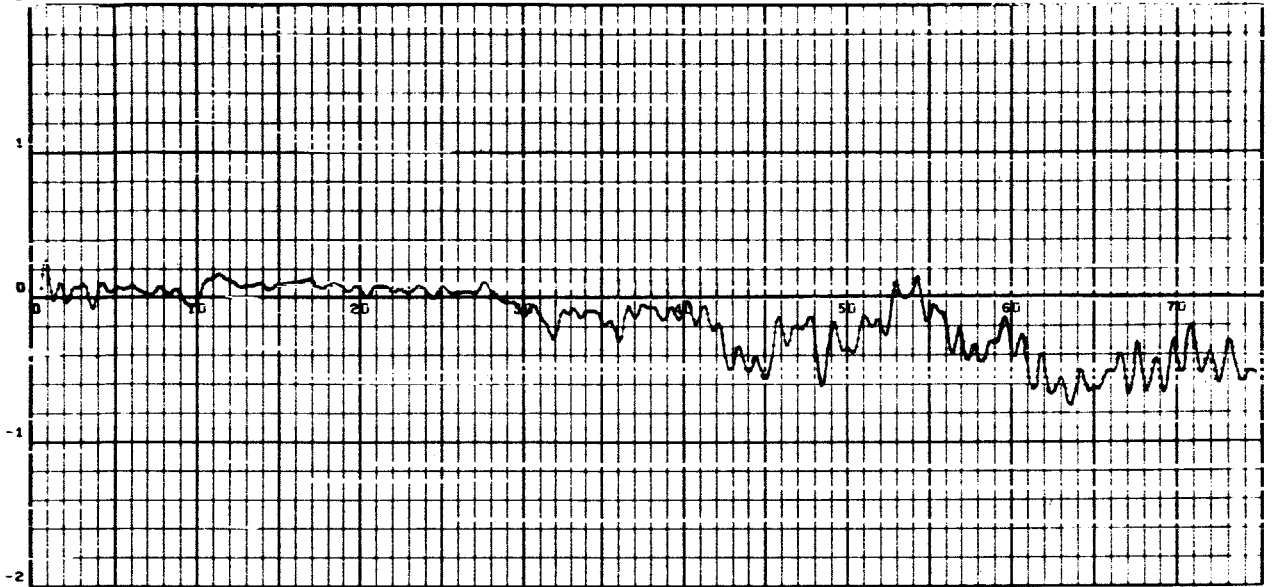

2 Acceleration Yaw Control, Filtered* (F41-802) (m/sec²)

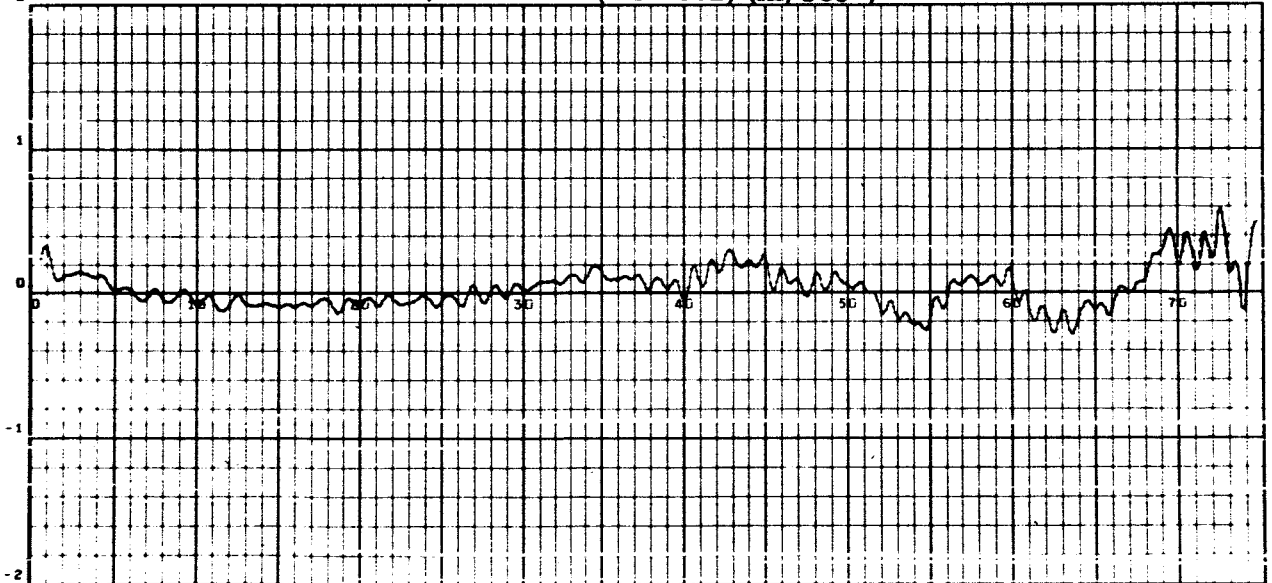

*Note: Filtered Digitally using a 1 Cycle Low Pass Filter

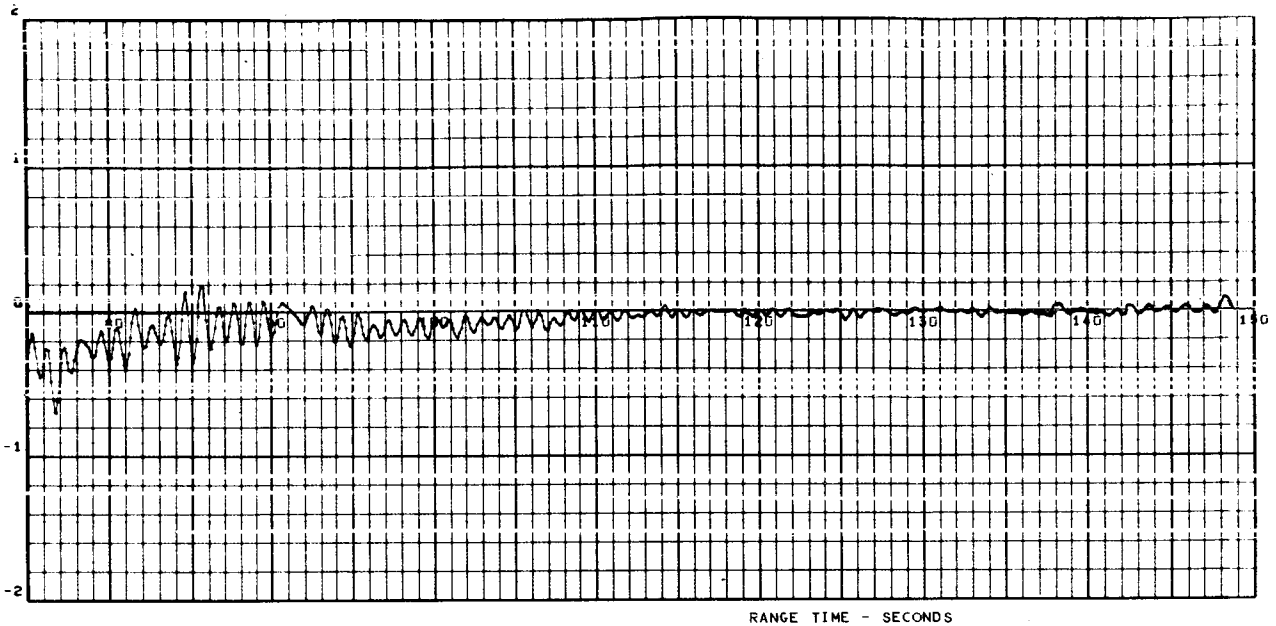

RANGE TIME - SECONDS

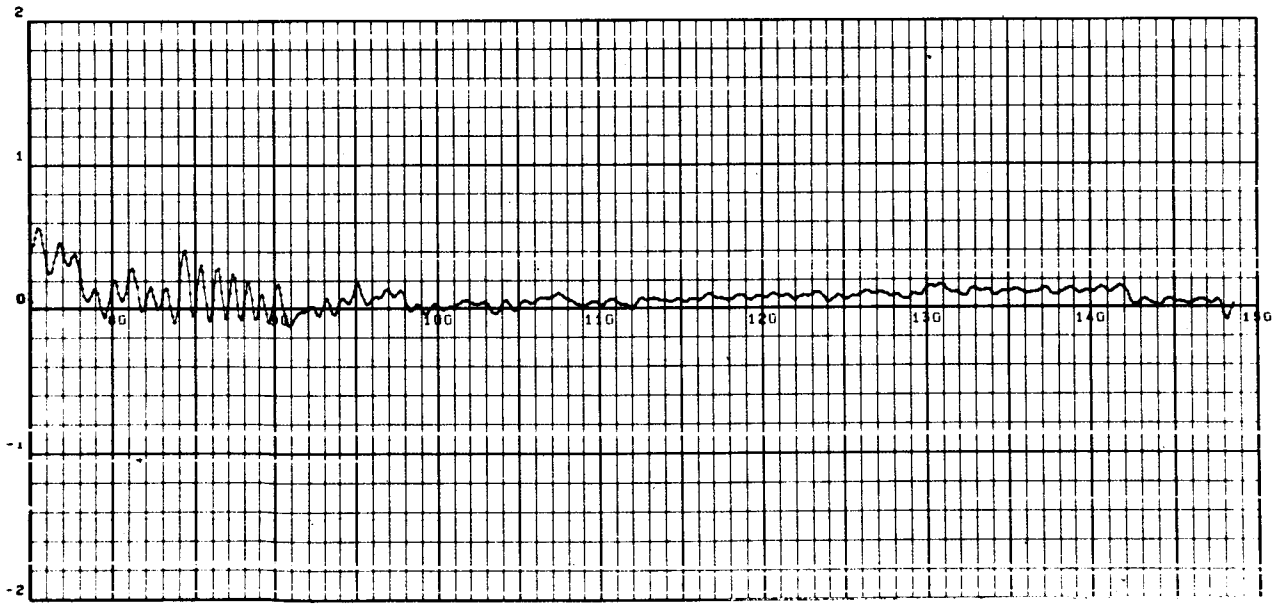

RANGE TIME - SECONDS

PITCH AND YAW NORMAL ACCELERATIONS (CONTD)

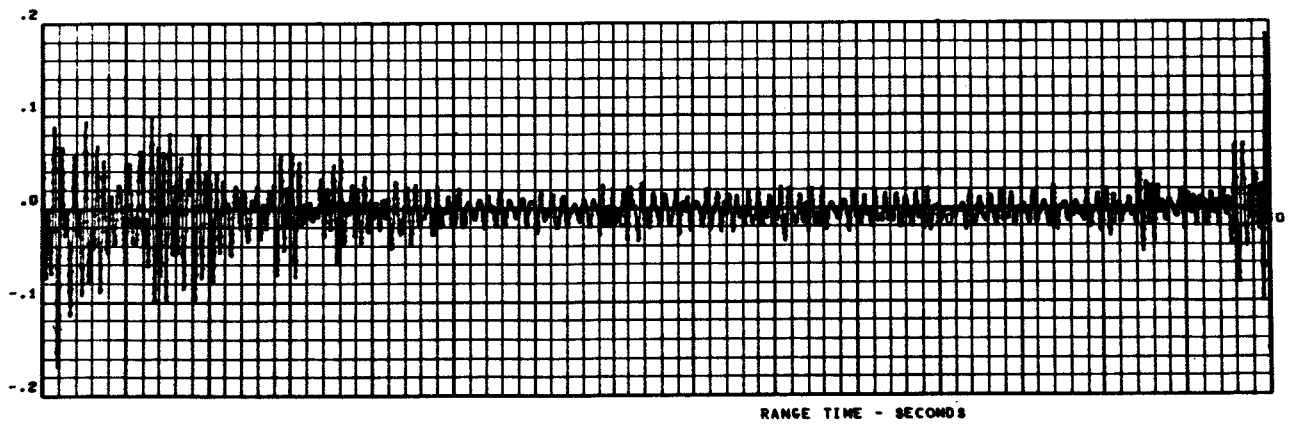

PITCH PLANE BENDING VIBRATIONS-CONTROL ACCELEROMETERS (CONTD)

Pitch Bending Vibration - IU, Filtered* (E357-802) (g's)

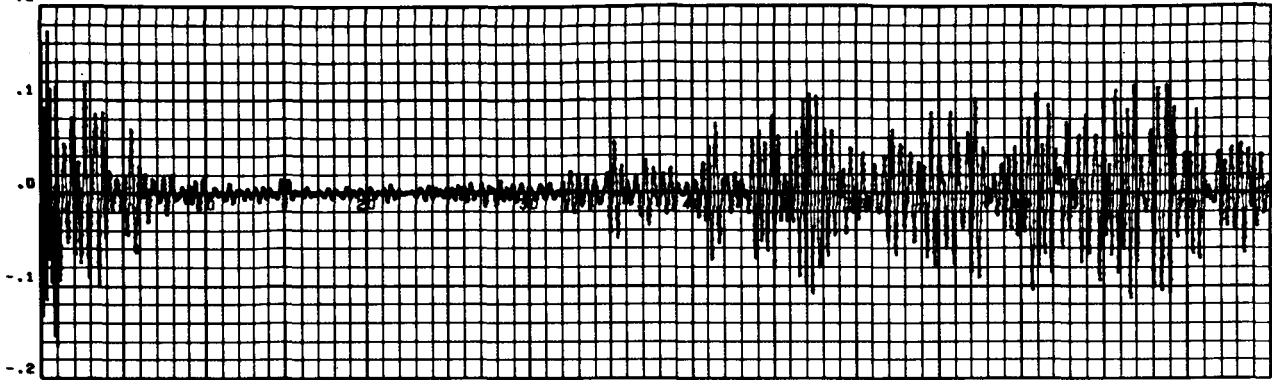

Pitch Bending Vibration - Spider Beam, Filtered* (E165-11) (g's)

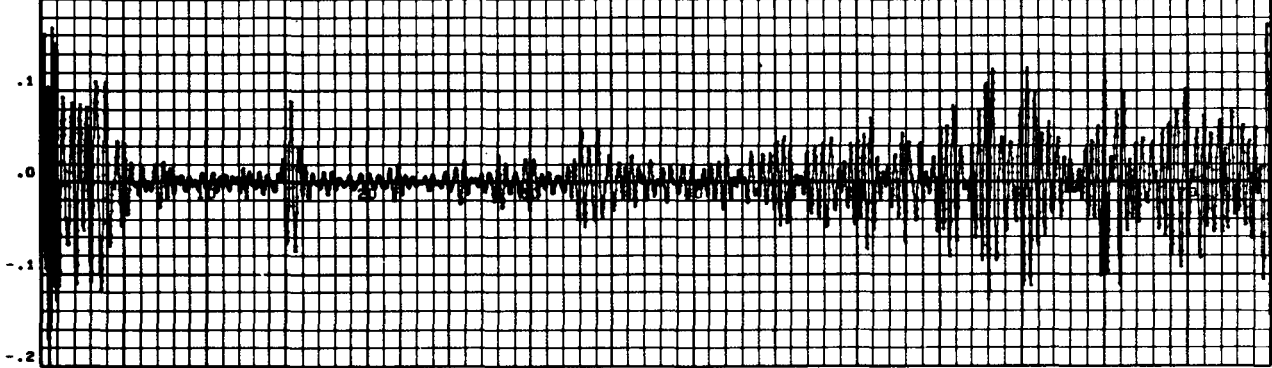

Pitch Bending Vibration - Thrust Ring, Filtered* (E251-9) (g's)

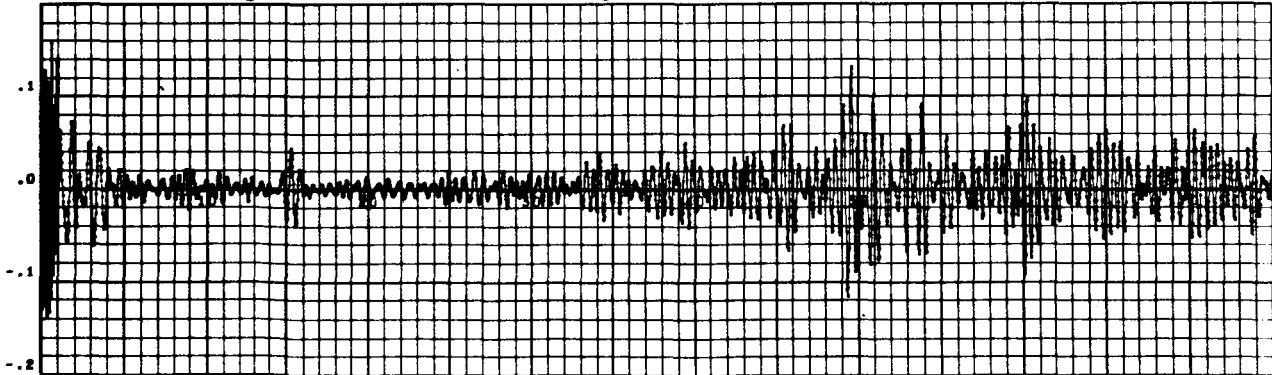

*Note: Filtered Digitally using a 101 Point band pass filter around the First Bending Mode Frequency.

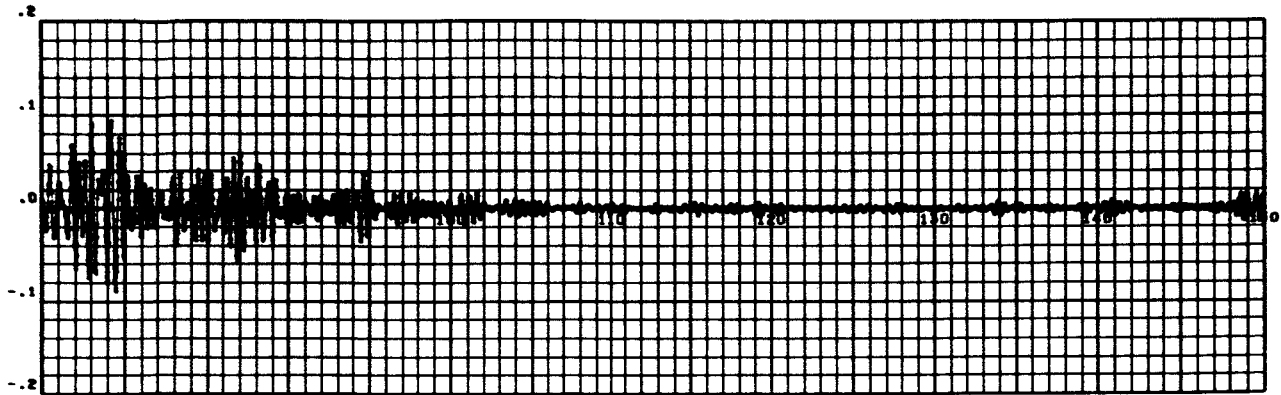

RANGE TIME - SECONDS

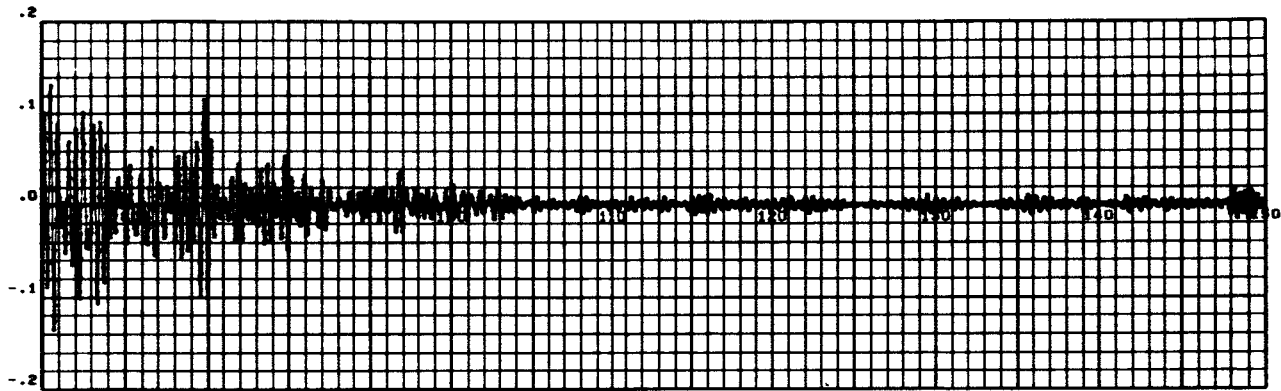

RANGE TIME - SECONDS

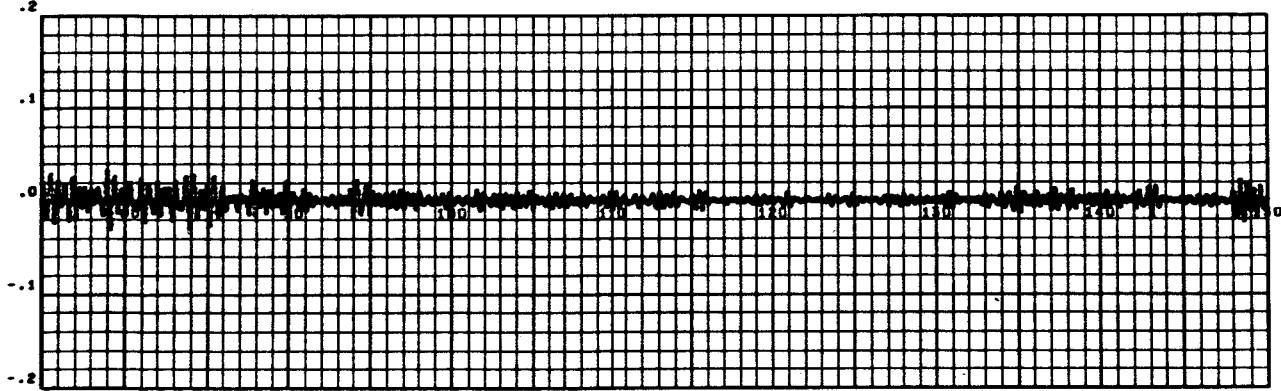

RANGE TIME - SECONDS

.2 Yaw Bending Vibration-IU, Filtered* (E358-802) (g's)

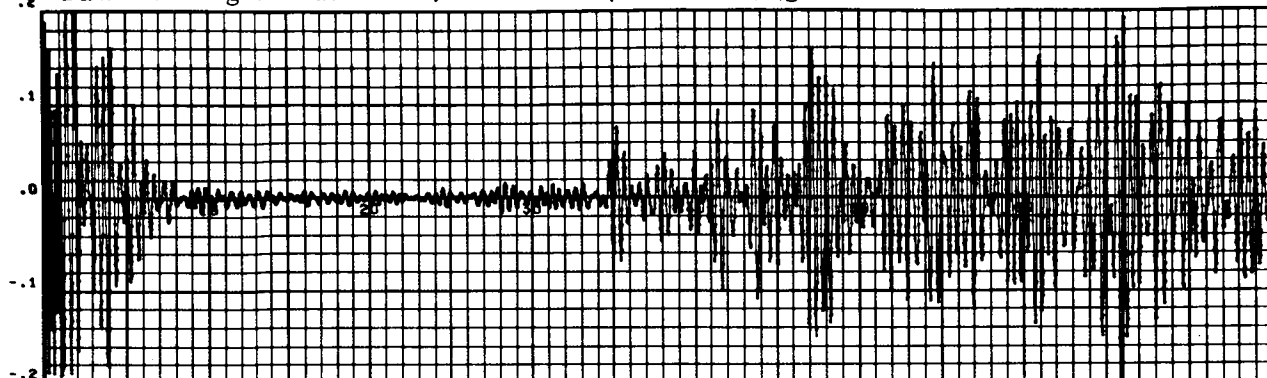

.2 Yaw Bending Vibration-Spider Beam, Filtered* (E166-11) (g's)

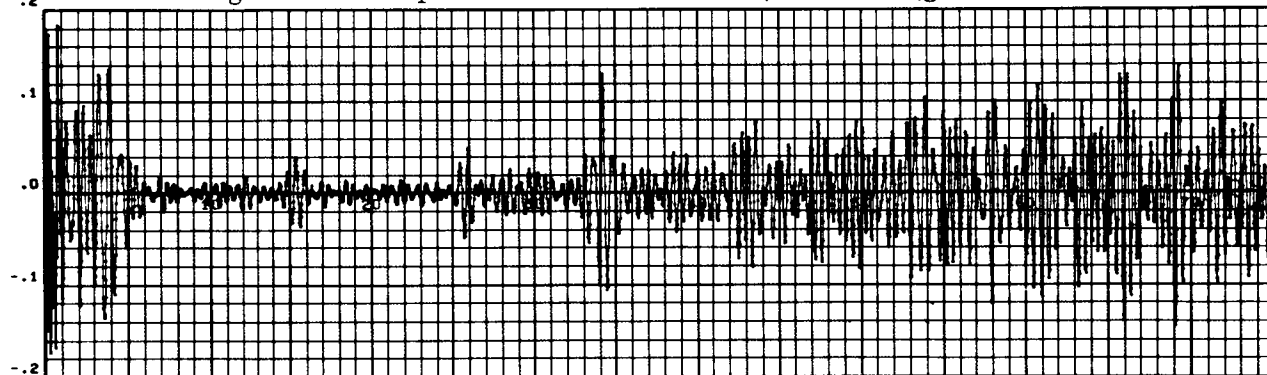

.2 Yaw Bending Vibration-Thrust Ring, Filtered* (E252-9) (g's)

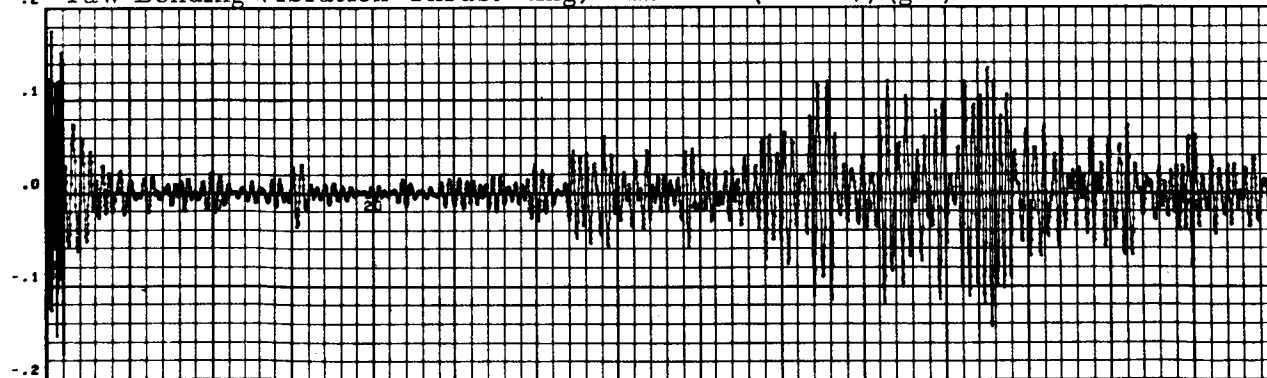

*Note: Filtered Digitally Using a 101 point band Pass Filter around the First Bending Mode Frequency

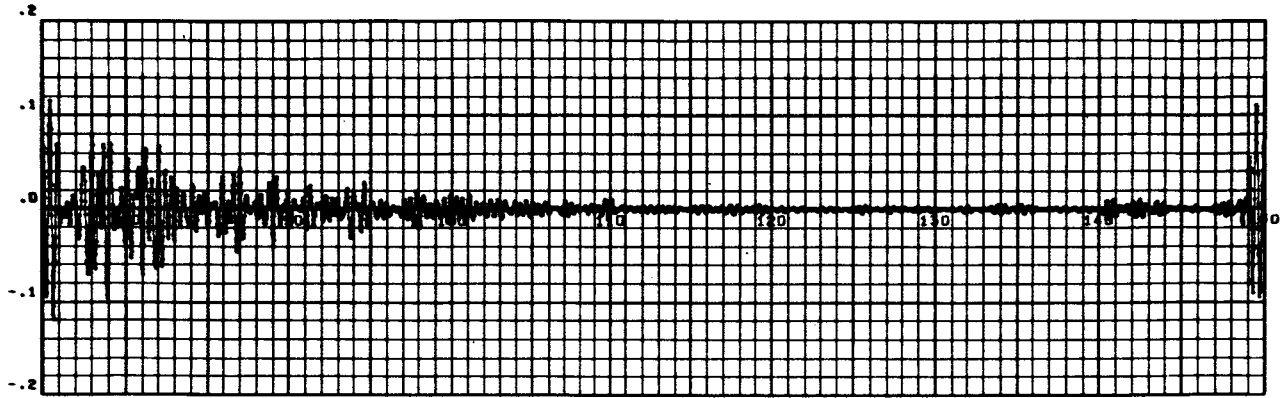

RANGE TIME - SECONDS

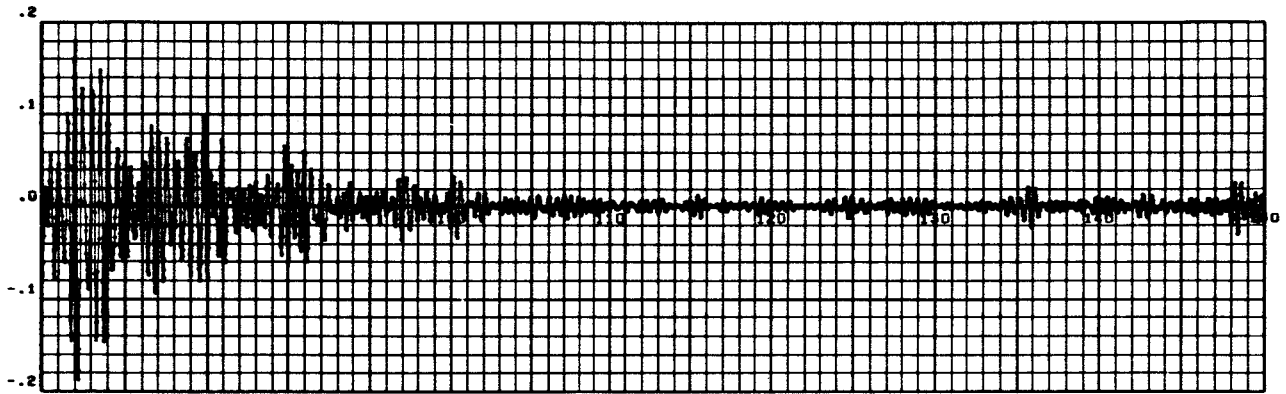

RANGE TIME - SECONDS

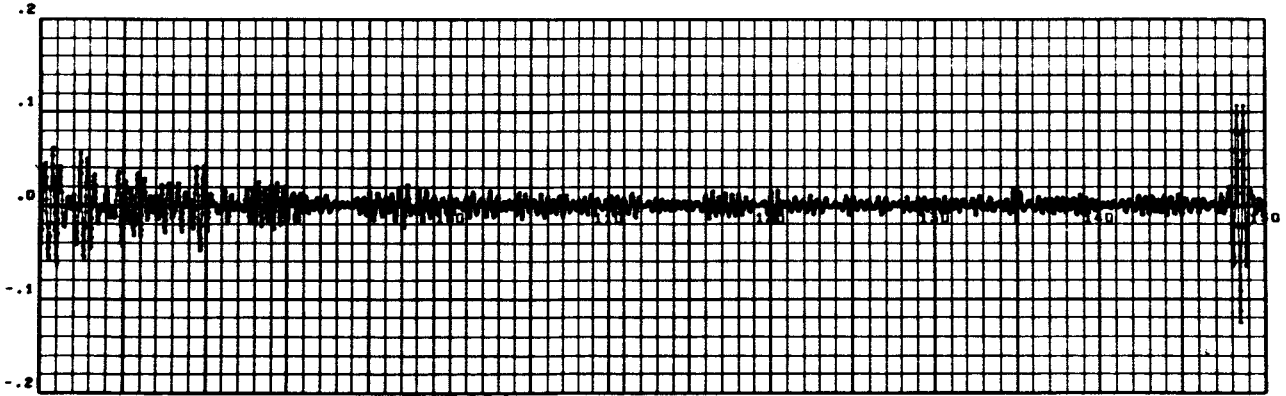

RANGE TIME - SECONDS

YAW PLANE BENDING VIBRATIONS (CONTD)

Steering Command Pitch (deg)

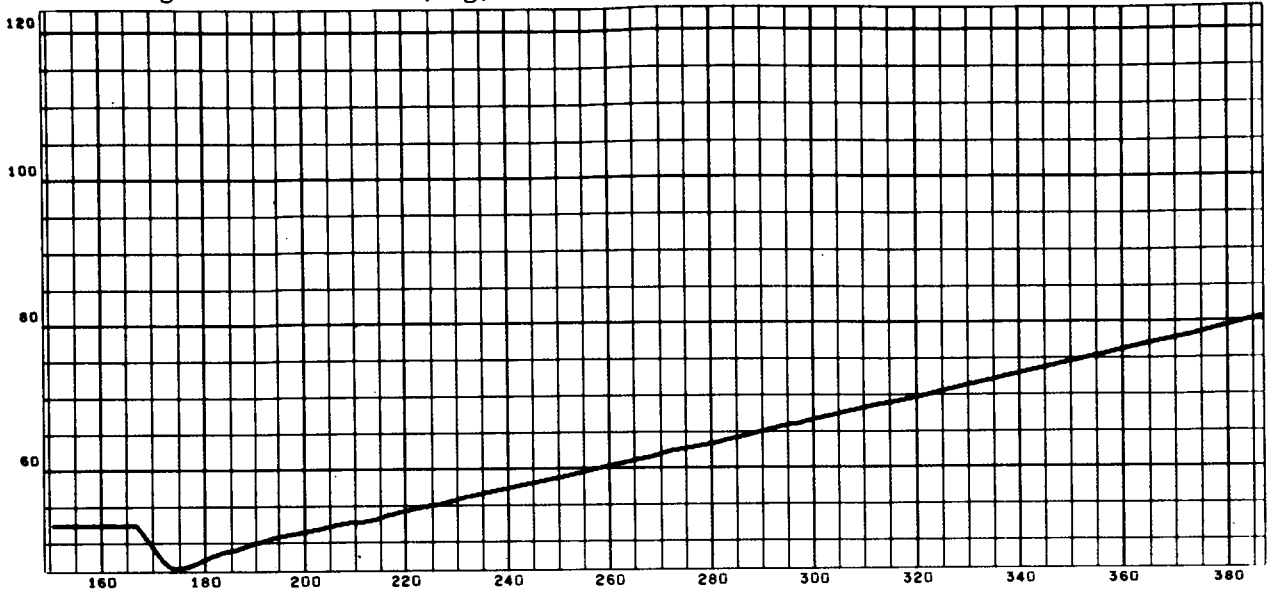

Pitch Velocity Vector Angle Space-Fixed (deg)

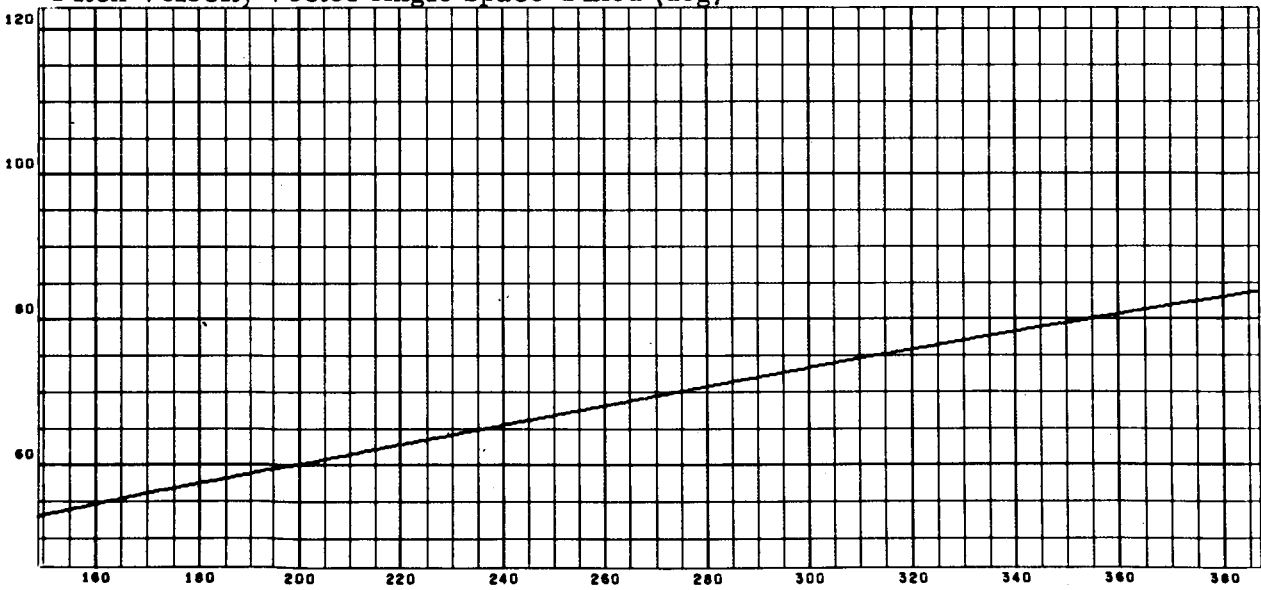

PITCH STEERING COMMAND AND VELOCITY VECTOR ANGLE

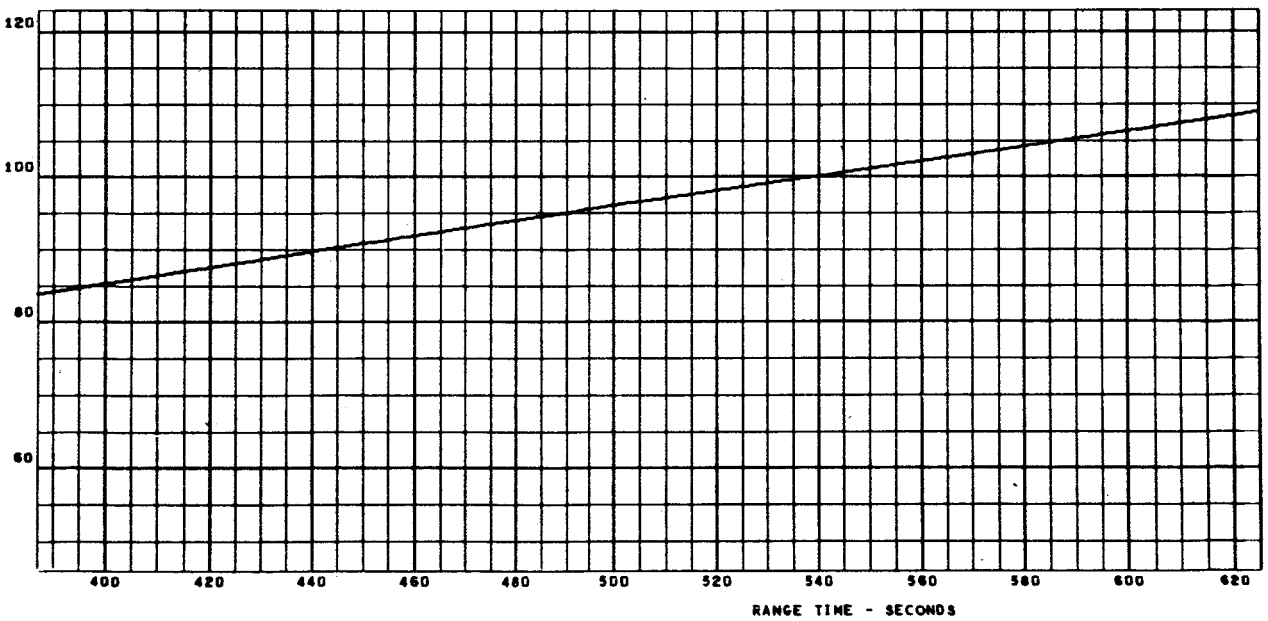
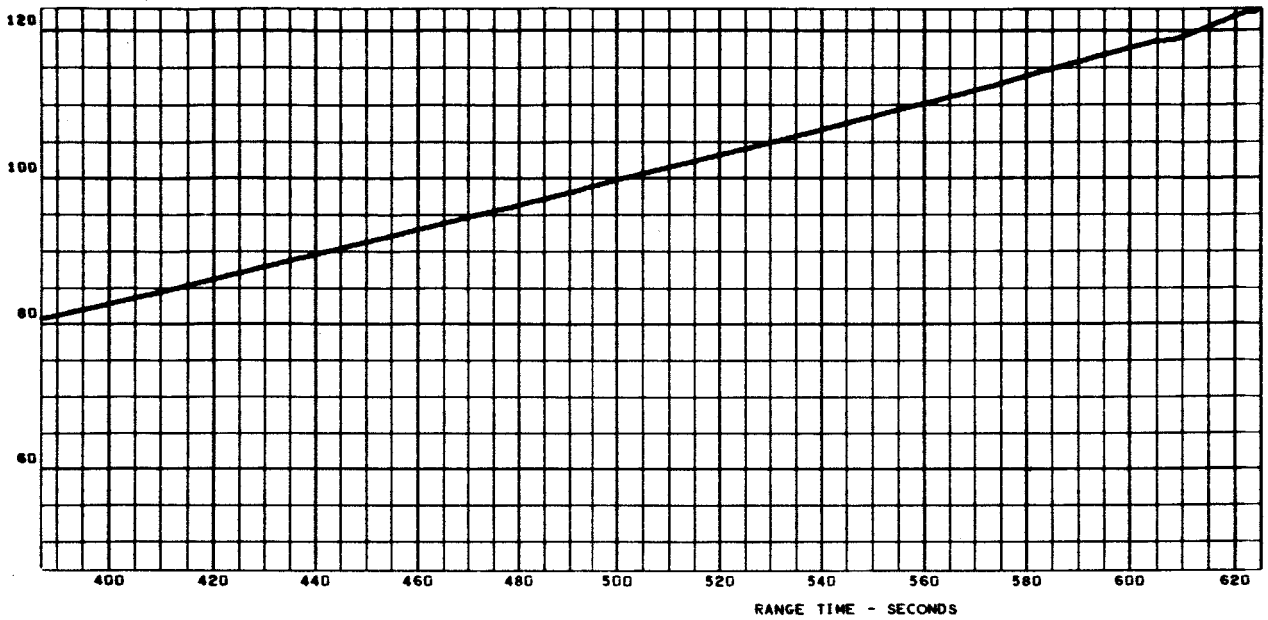

PITCH STEERING COMMAND VELOCITY VECTOR ANGLE (CONTD)

CHI X (I10-802) (deg)

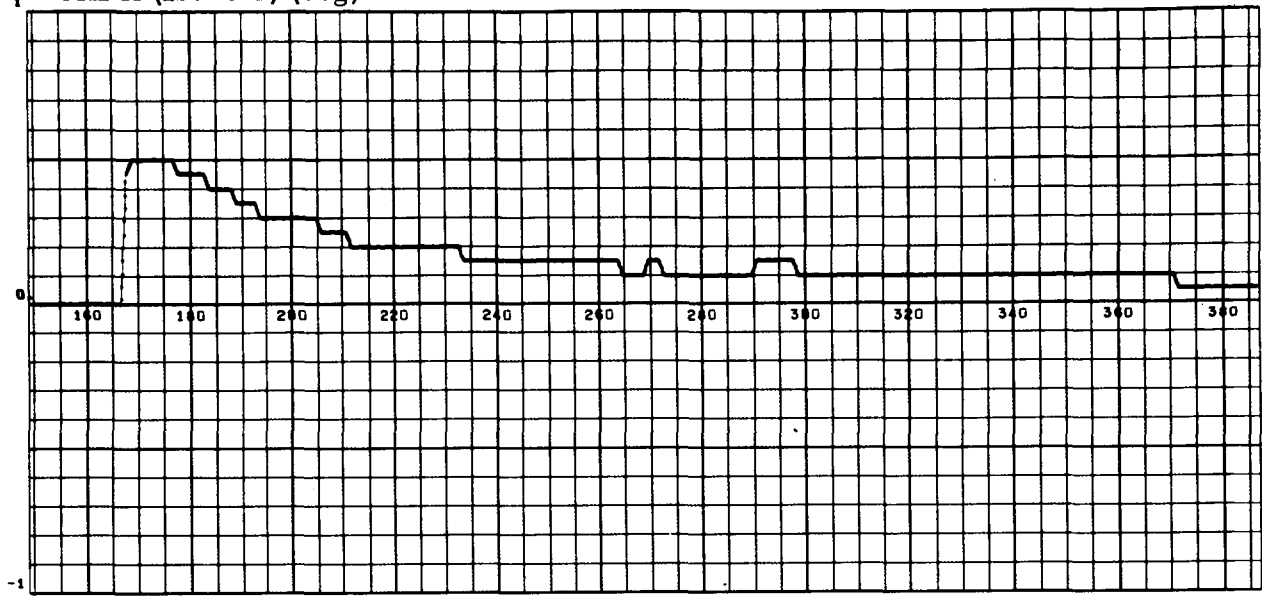

CHI Y (I13-802) (deg)

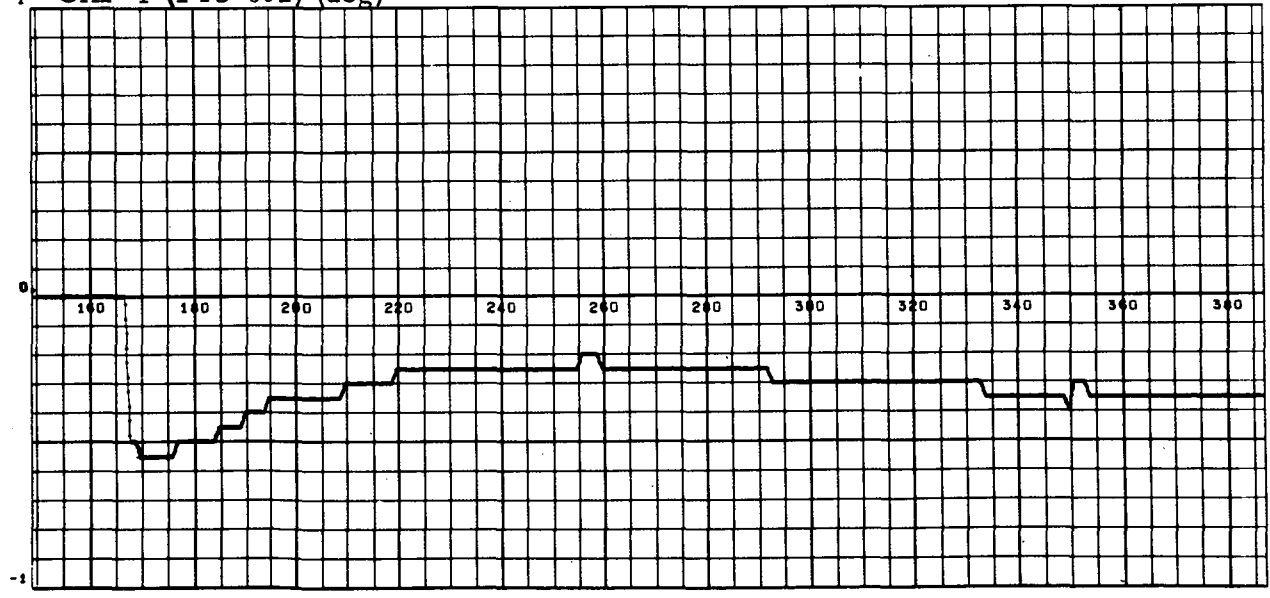

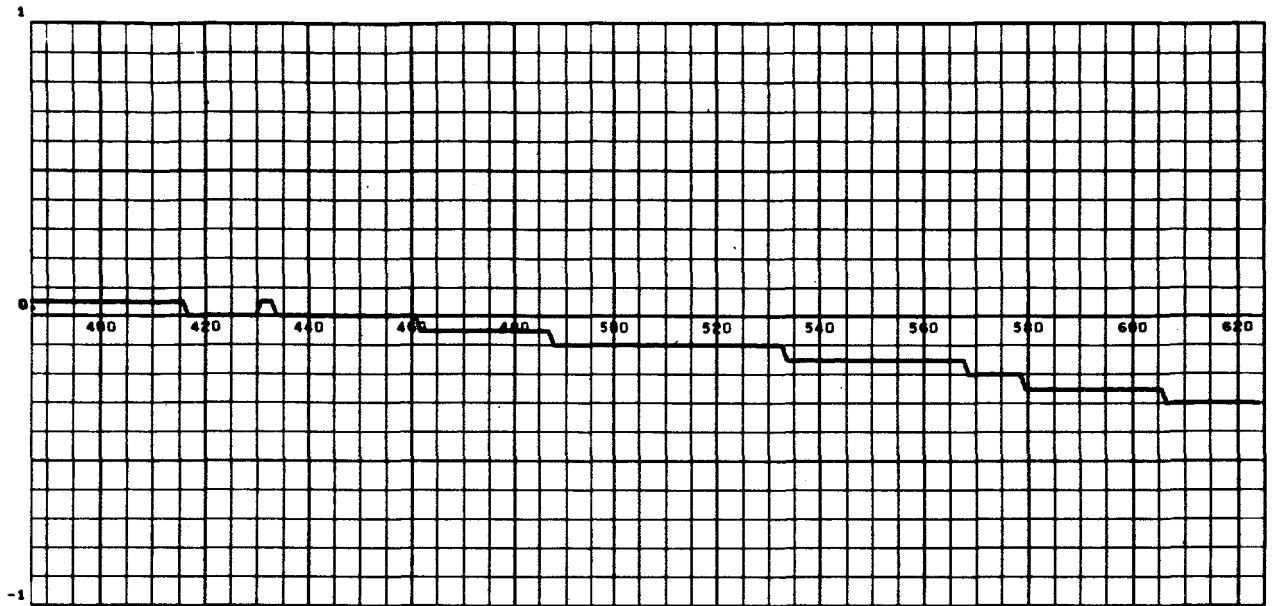

RANGE TIME - SECONDS

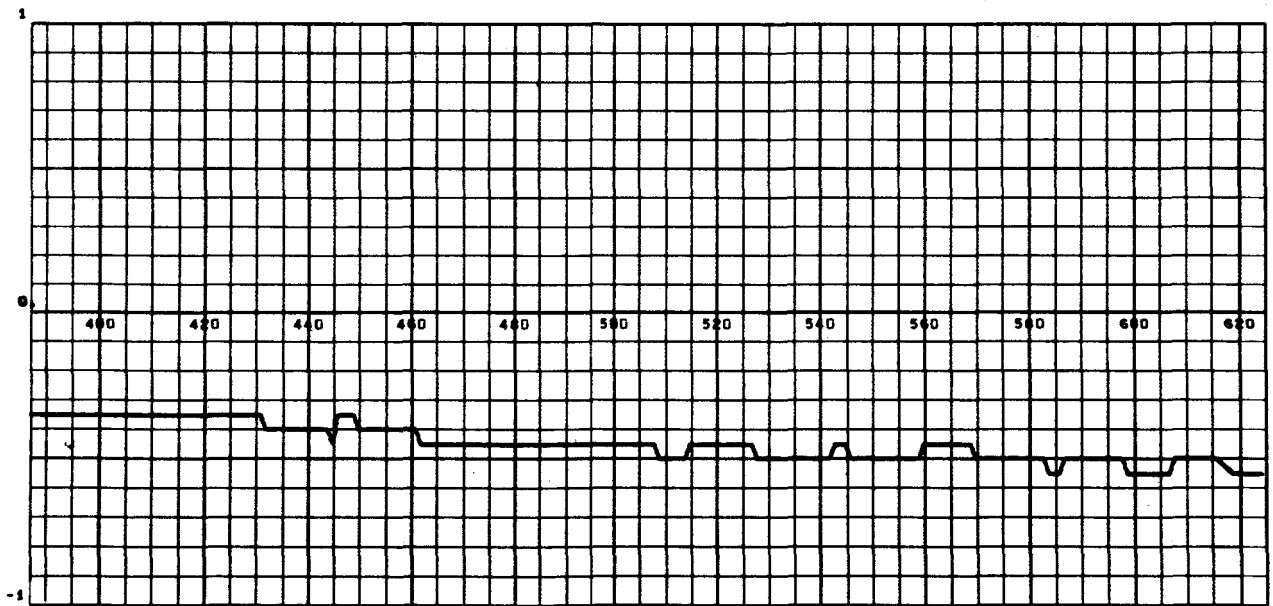

RANGE TIME - SECONDS

GUIDANCE COMMANDS - S-IV STAGE (CONTD)

1 Attitude Pitch, ST-124 (H42-802) (deg)

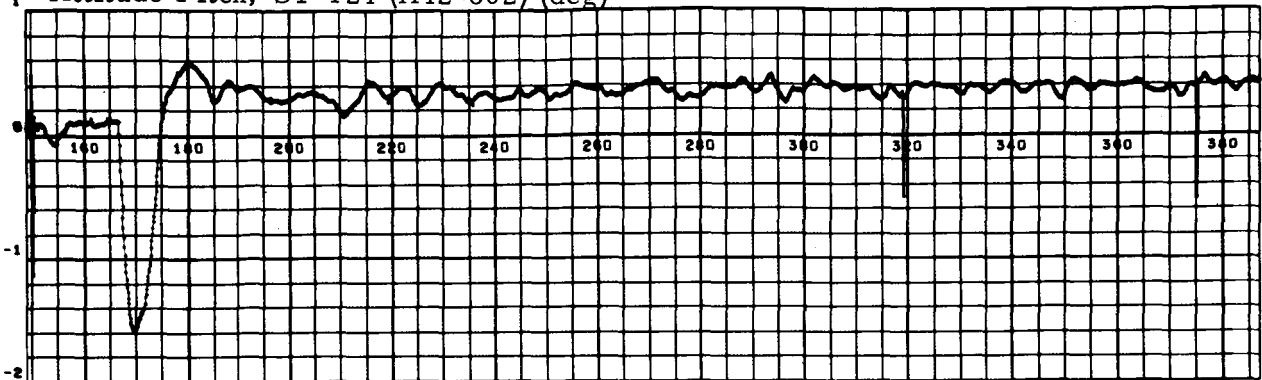

1 Attitude Yaw, ST-124 (H41-802) (deg)

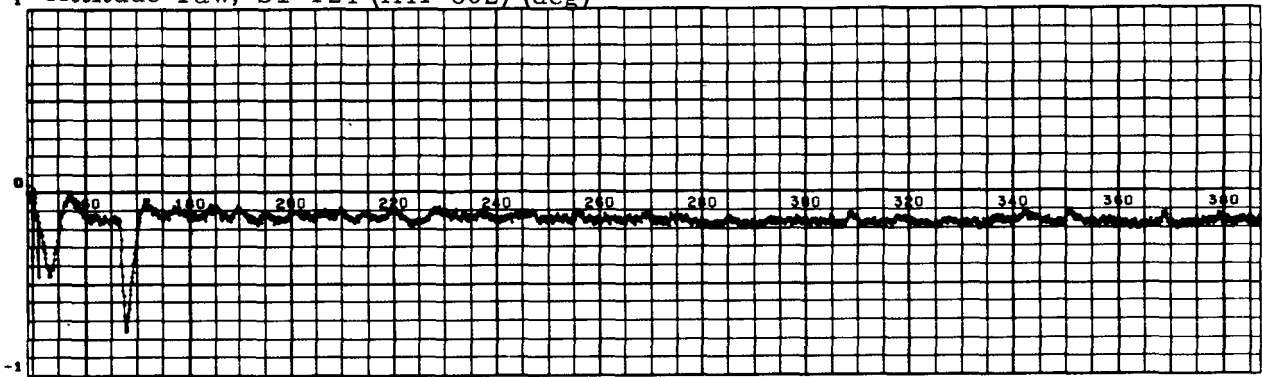

1 Attitude Roll, ST-124, (H40-802) (deg)

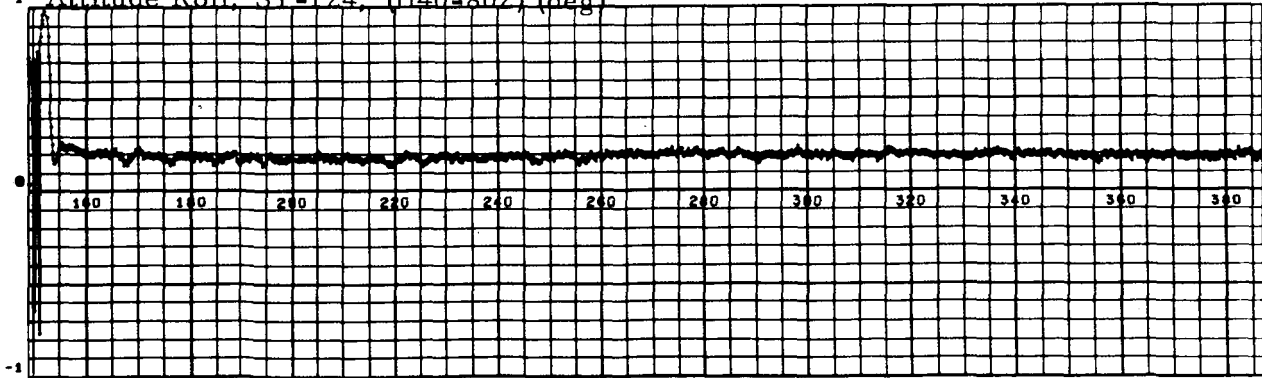

ATTITUDE ERROR - ST-124

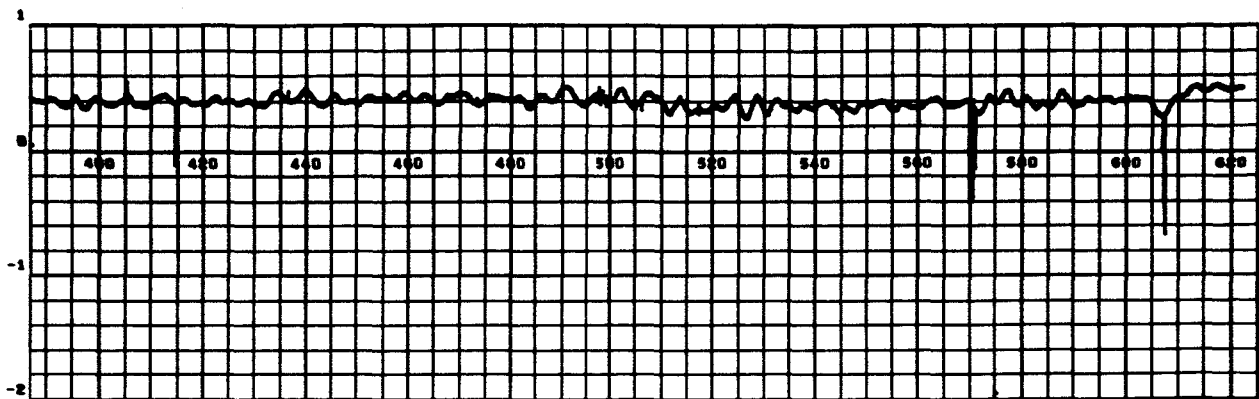

RANGE TIME - SECONDS

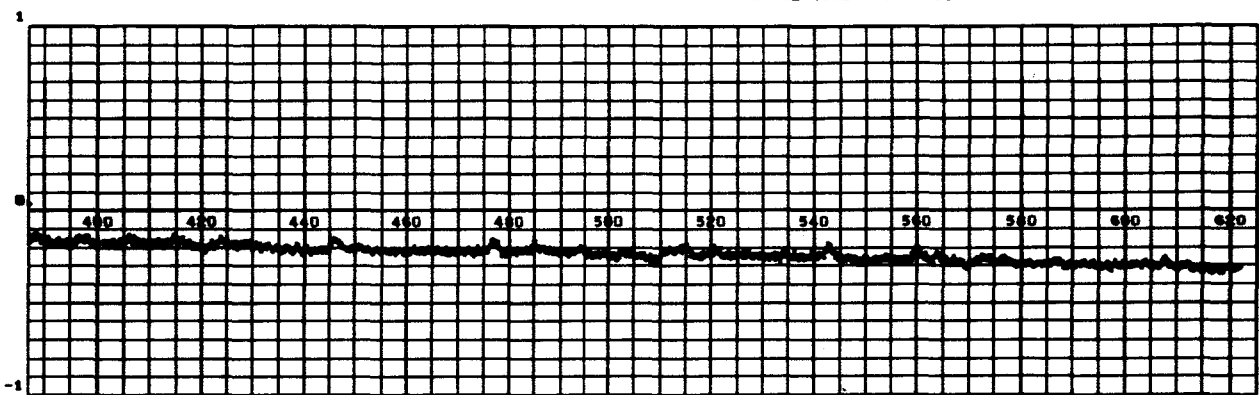

RANGE TIME - SECONDS

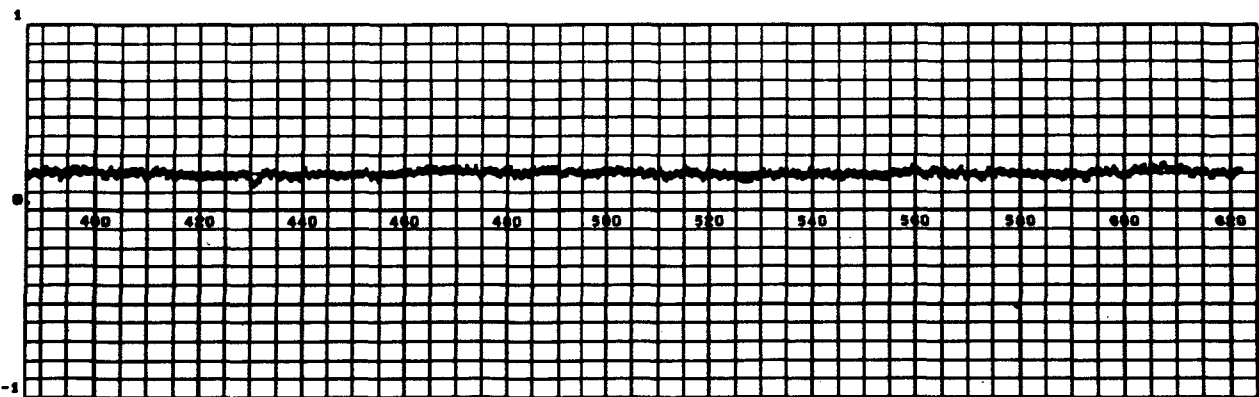

RANGE TIME - SECONDS

ATTITUDE ERROR - ST-124 (CONT'D)

Angular Velocity Pitch, Control (F42-802) (deg/sec)

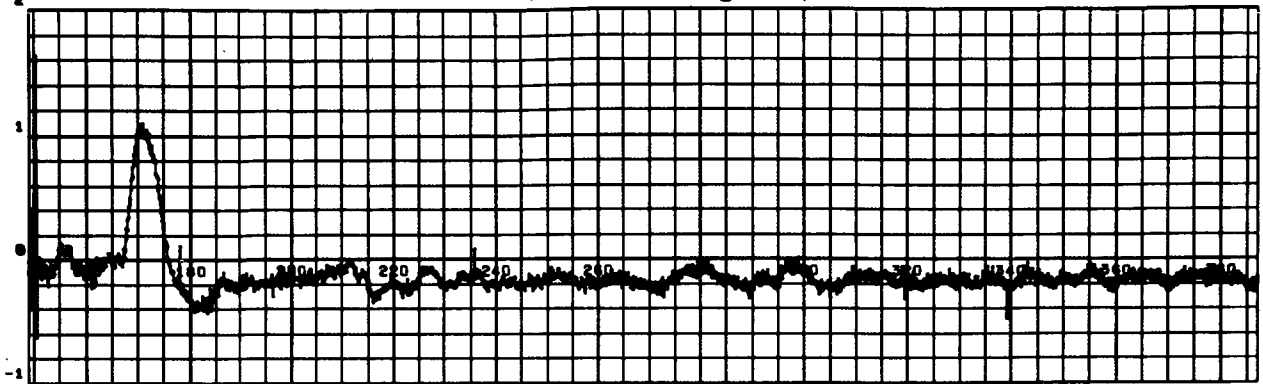

Angular Velocity Yaw, Control (F43-802) (deg/sec)

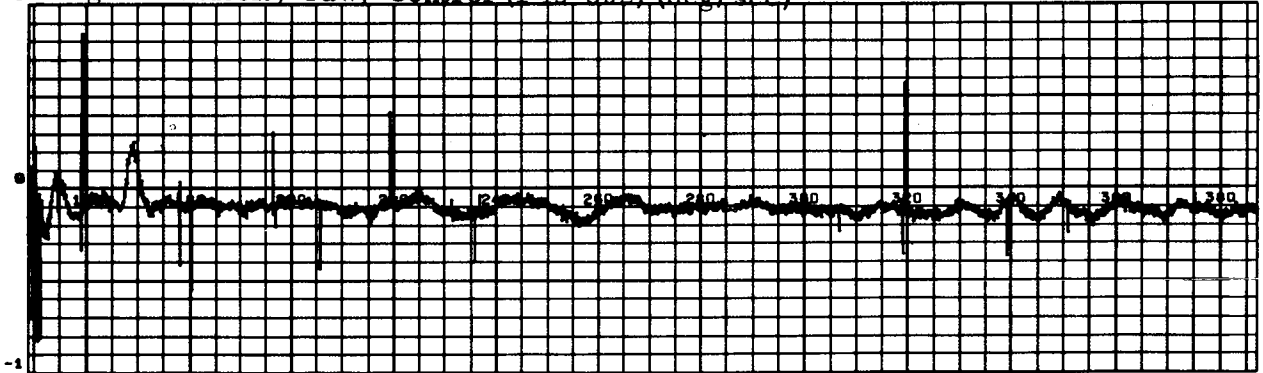

Angular Velocity Roll, Control (F44-802) (deg/sec)

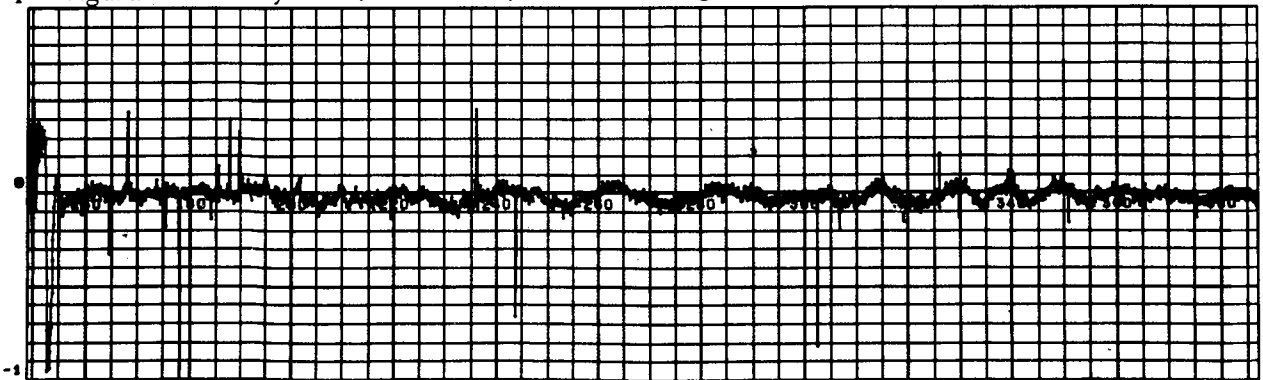

CONTROL ANGULAR VELOCITIES

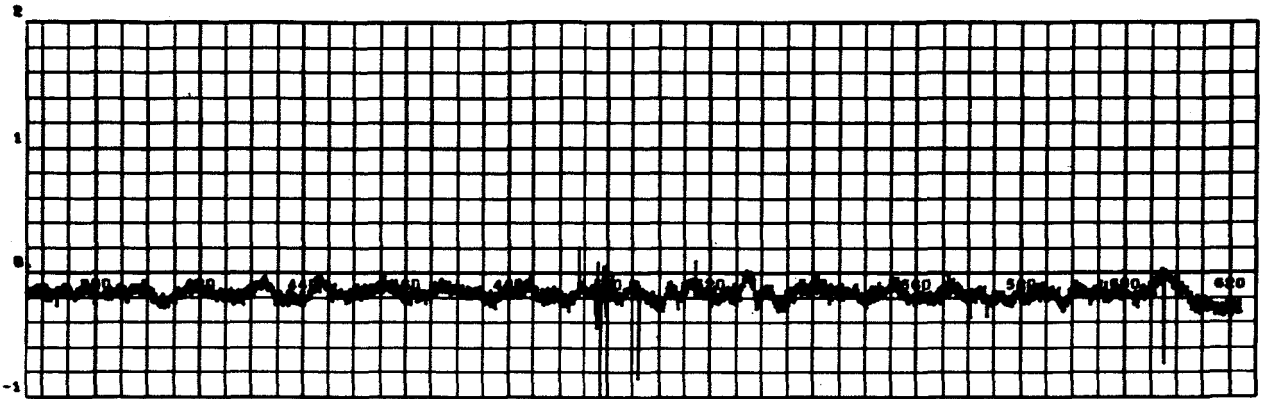

RANGE TIME - SECONDS



RANGE TIME - SECONDS

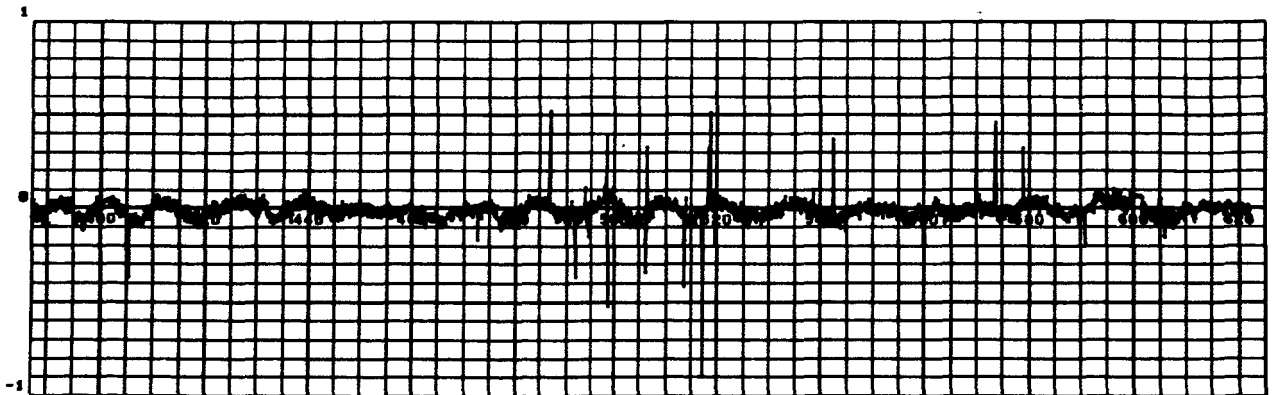

RANGE TIME - SECONDS

CONTROL ANGULAR VELOCITIES (CONTD)

1 Position Pitch Actuator (G1-401) (deg)

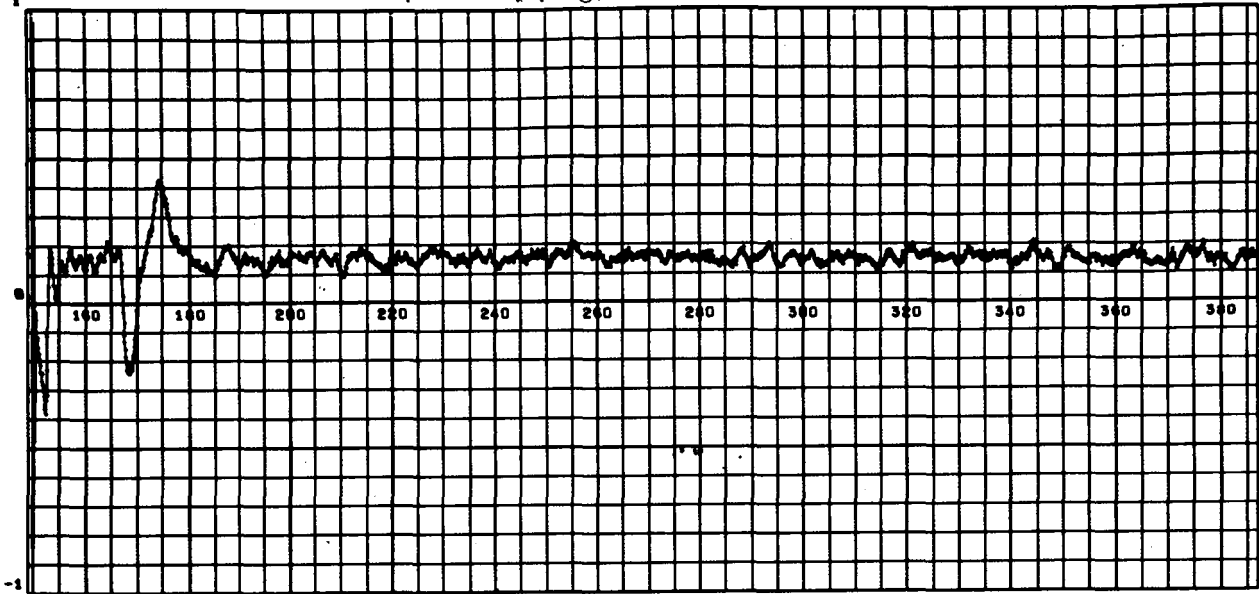

1 Position Pitch Actuator (G1-402) (deg)



PITCH ACTUATOR POSITION

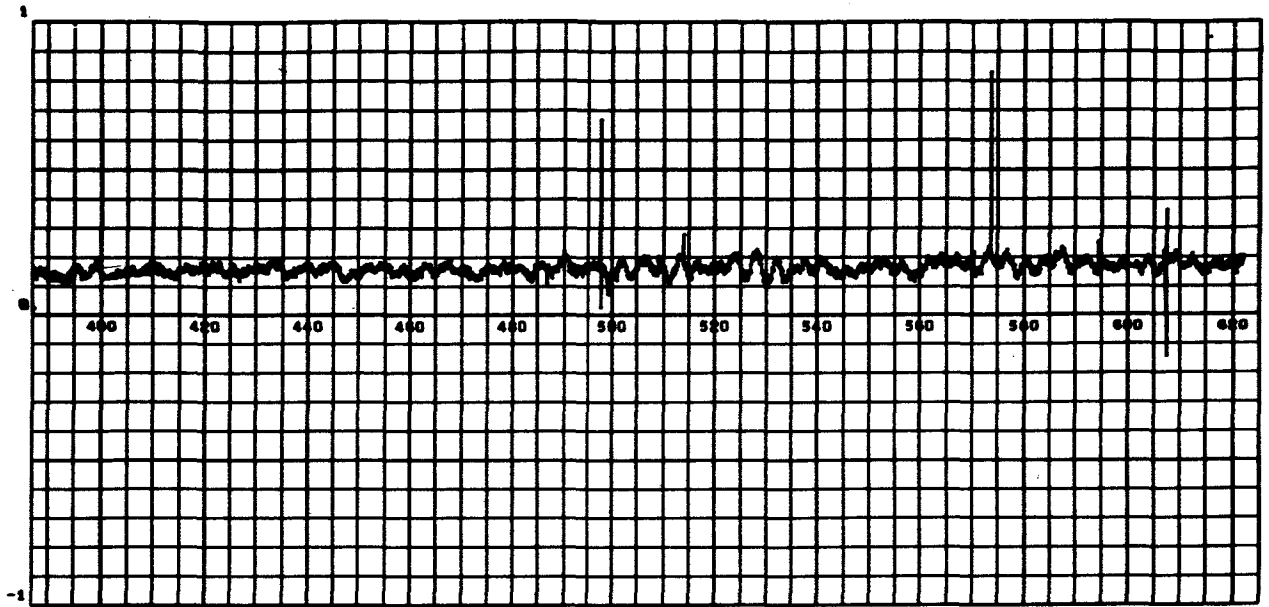

RANGE TIME - SECONDS

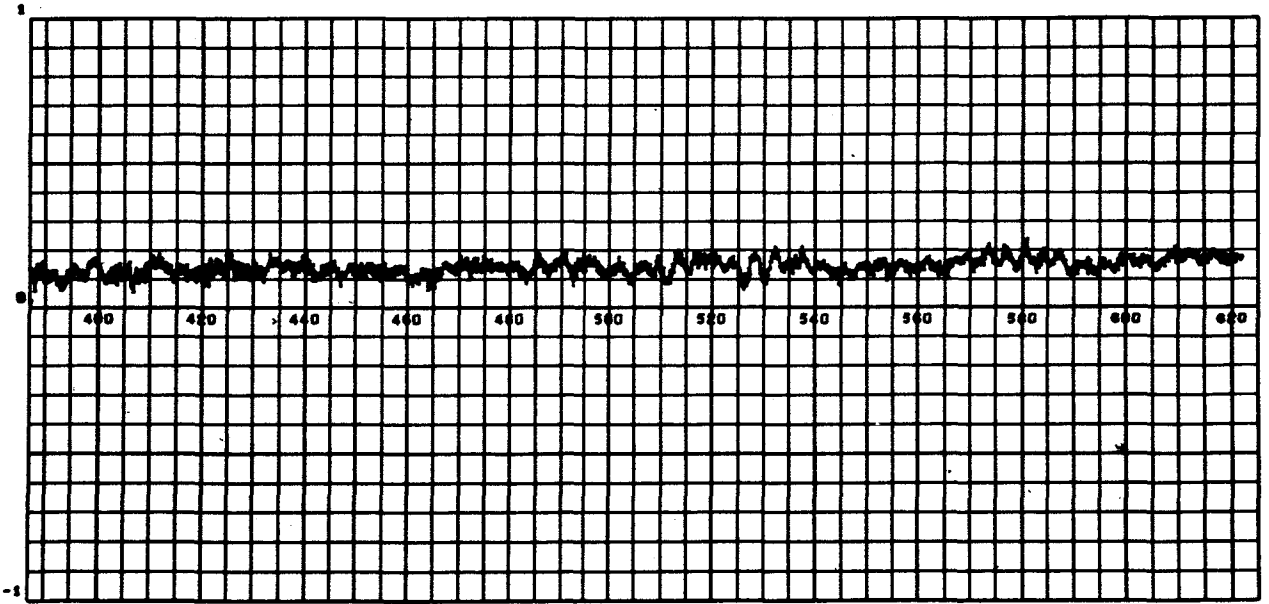

RANGE TIME - SECONDS

PITCH ACTUATOR POSITION (CONTD)

Position Pitch Actuator (G1-403) (deg)

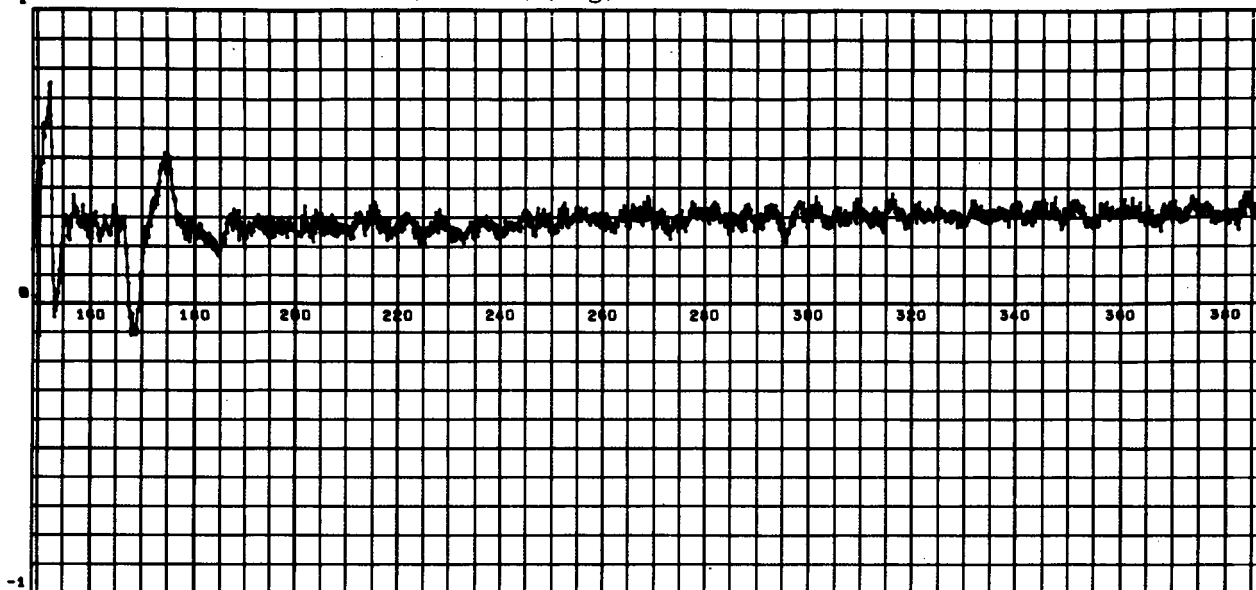

Position Pitch Actuator (G1-404) (deg)

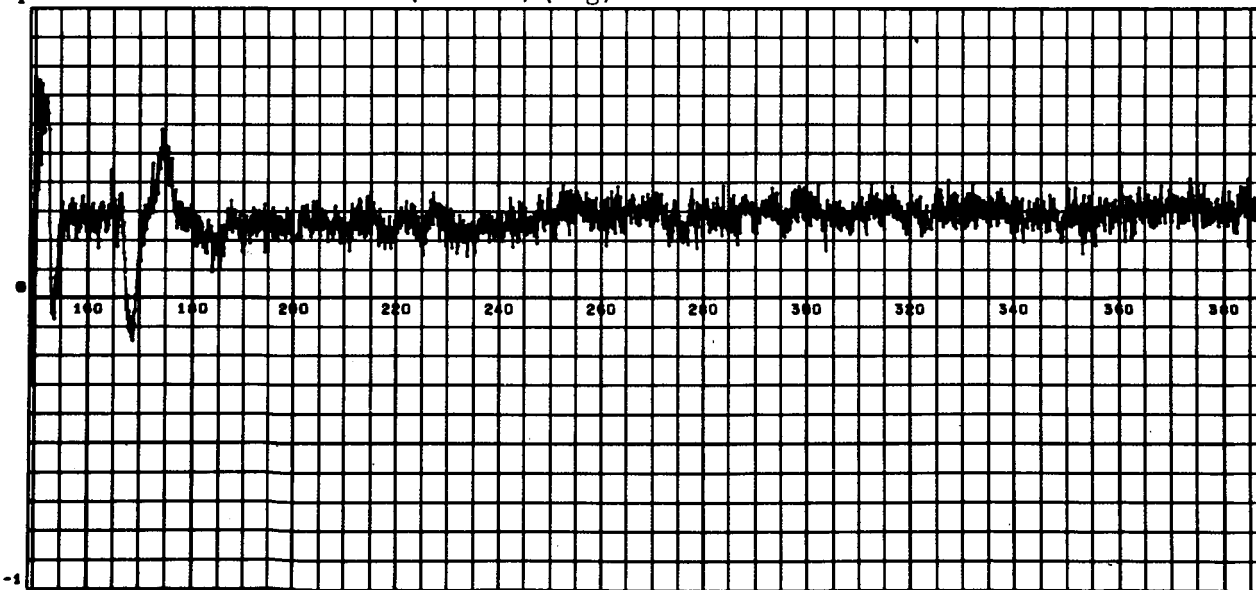

PITCH ACTUATOR POSITION

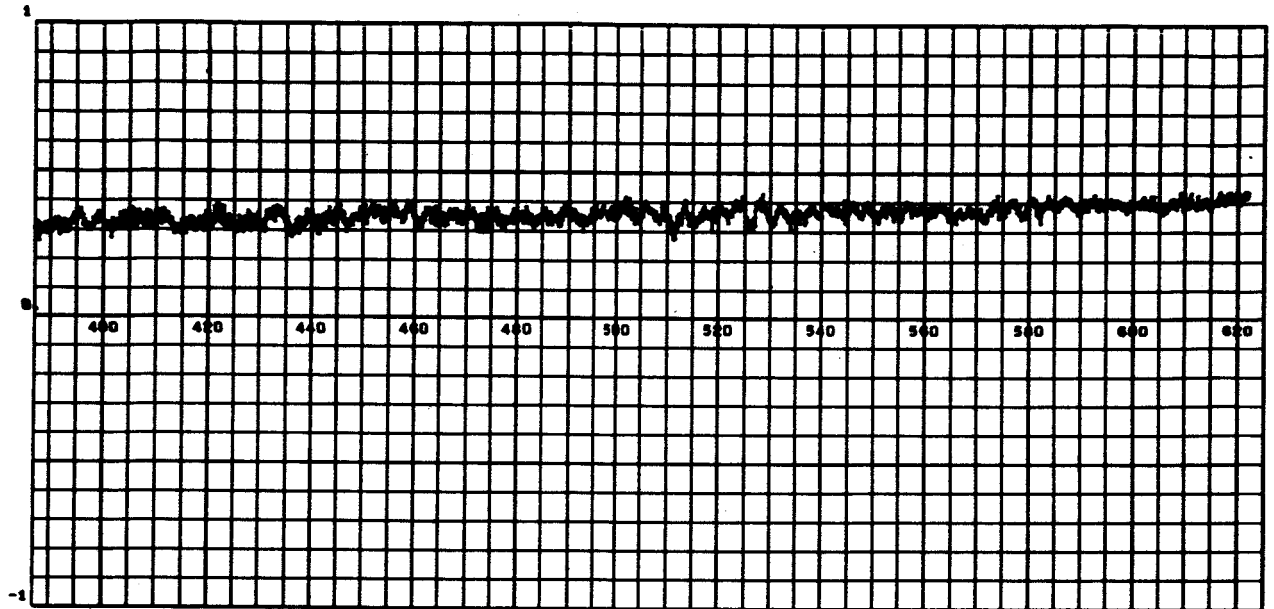

RANGE TIME - SECONDS

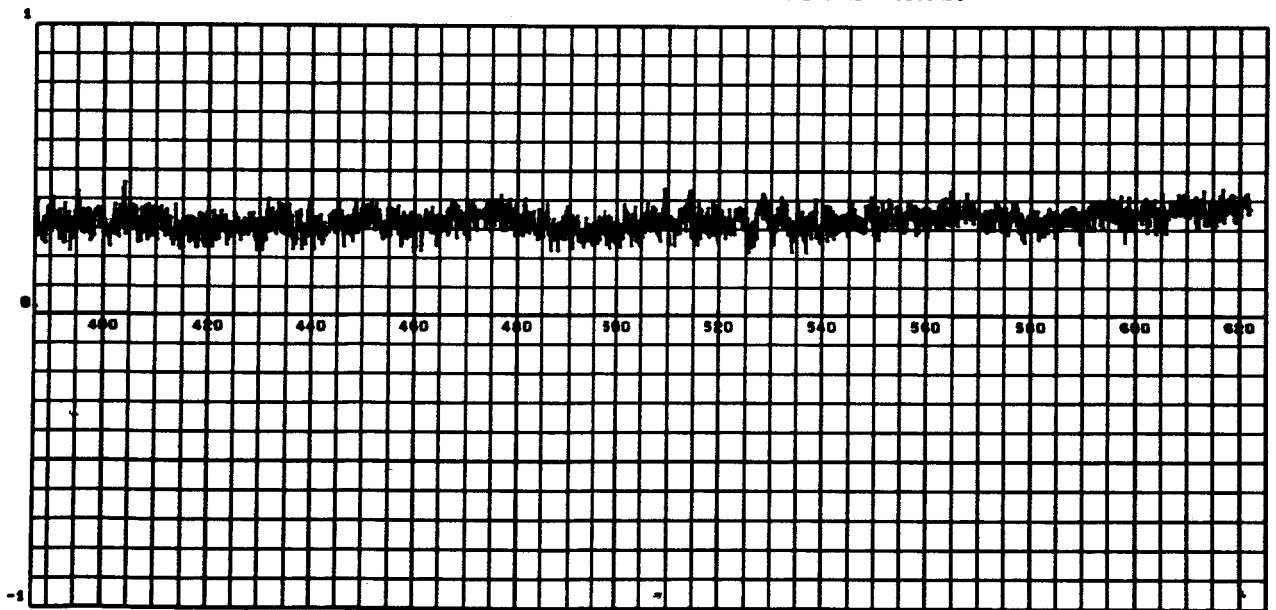

RANGE TIME - SECONDS

PITCH ACTUATOR POSITION (CONTD)

1 Position Yaw Actuator (G2-401) (deg)



1 Position Yaw Actuator (G2-402) (deg)

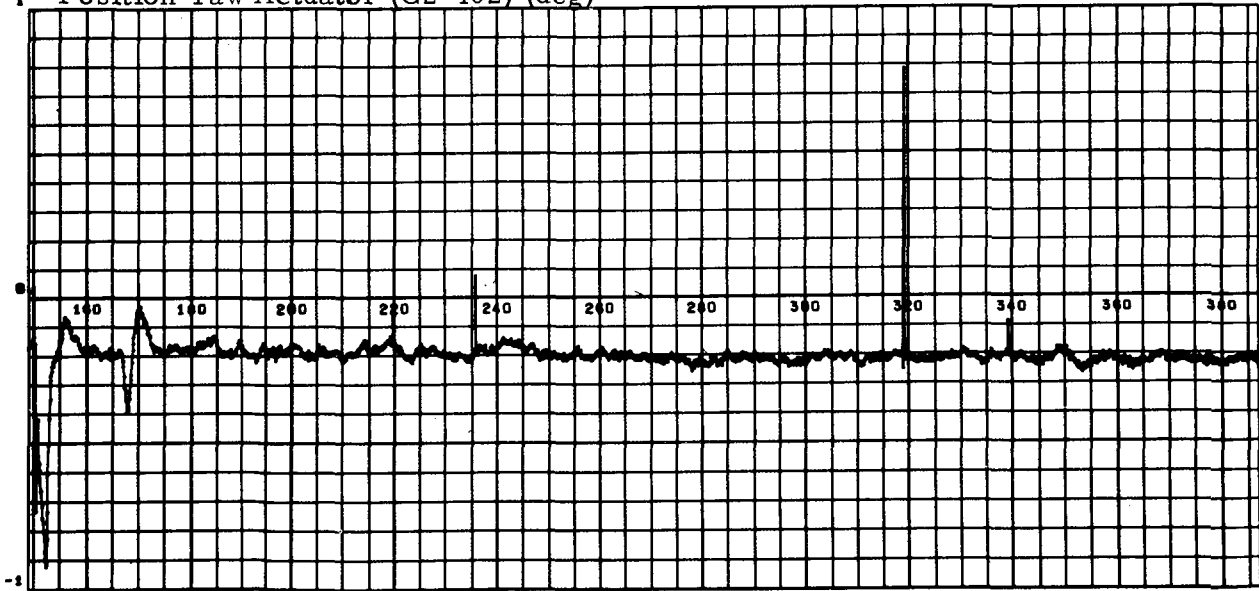



YAW ACTUATOR POSITION (CONTD)

Position Yaw Actuator (G2-403) (deg)

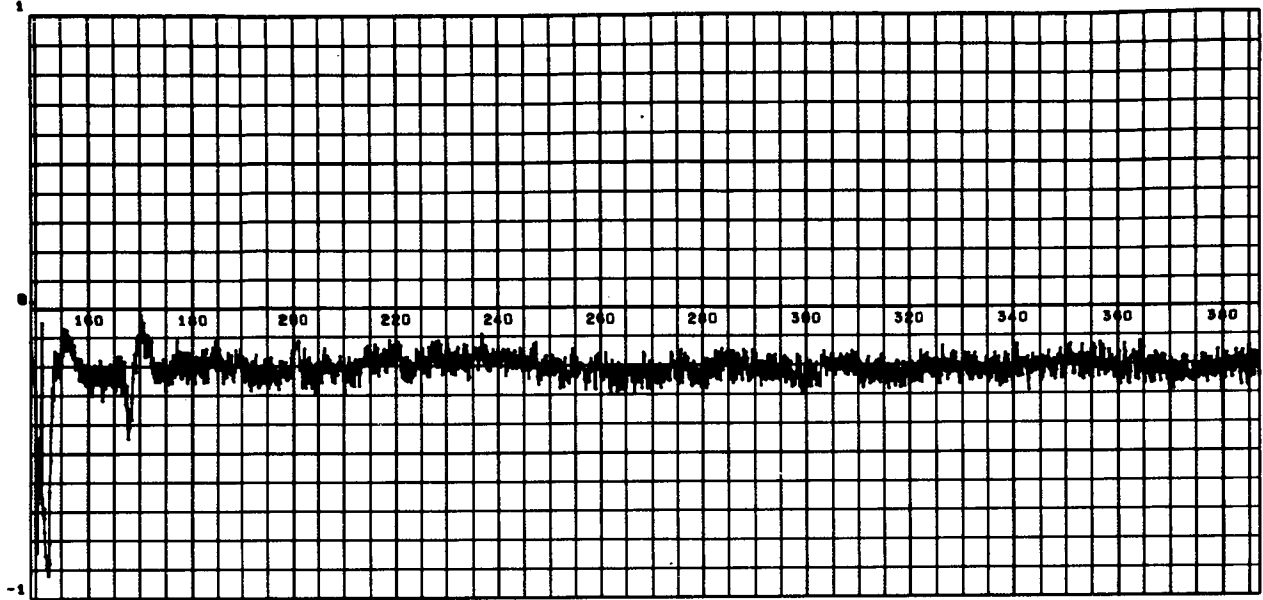

Position Yaw Actuator (G2-404) (deg)

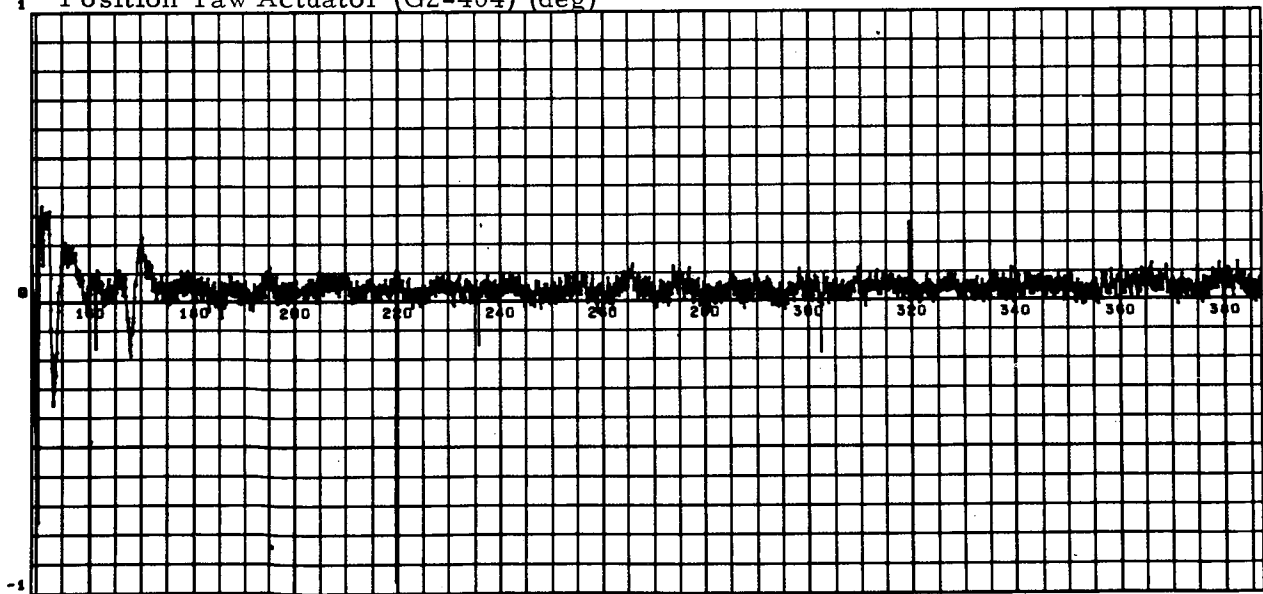

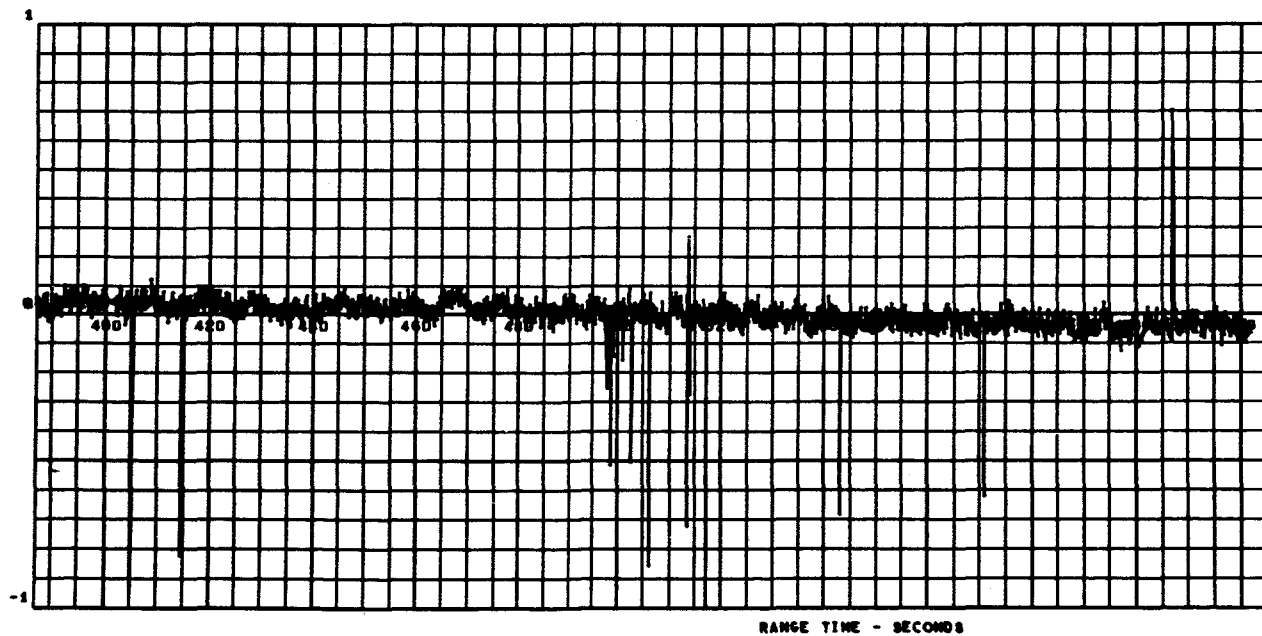
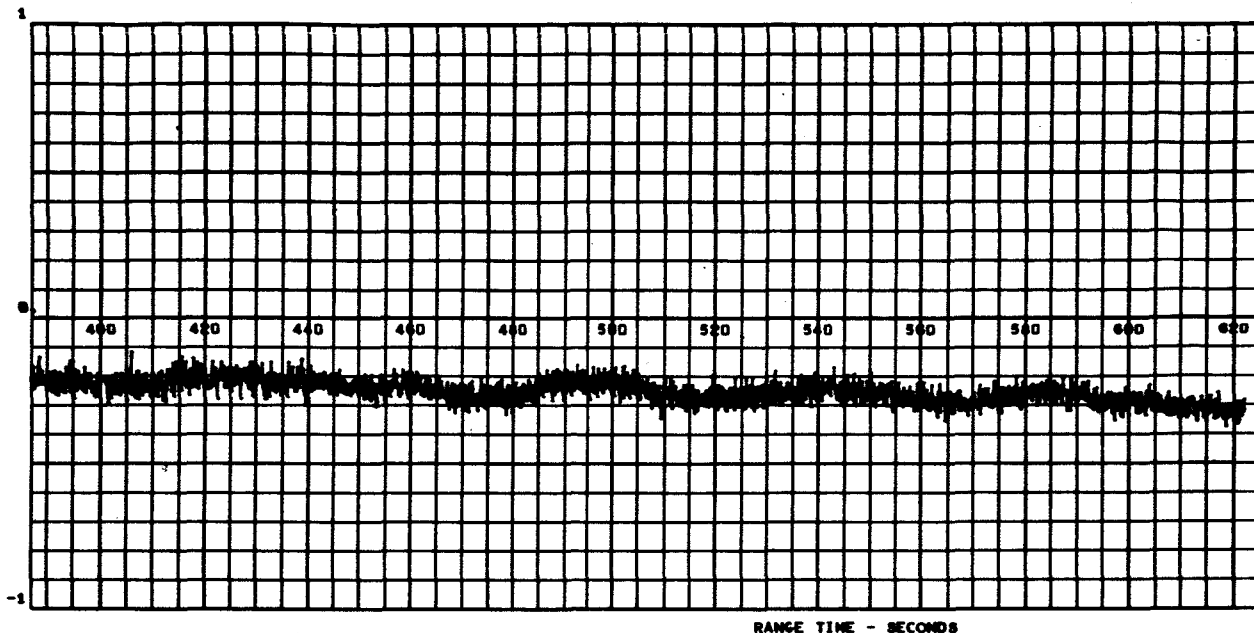

YAW ACTUATOR POSITION (CONTD)

1 Position Actuator 5-1 (G15-405) (deg)

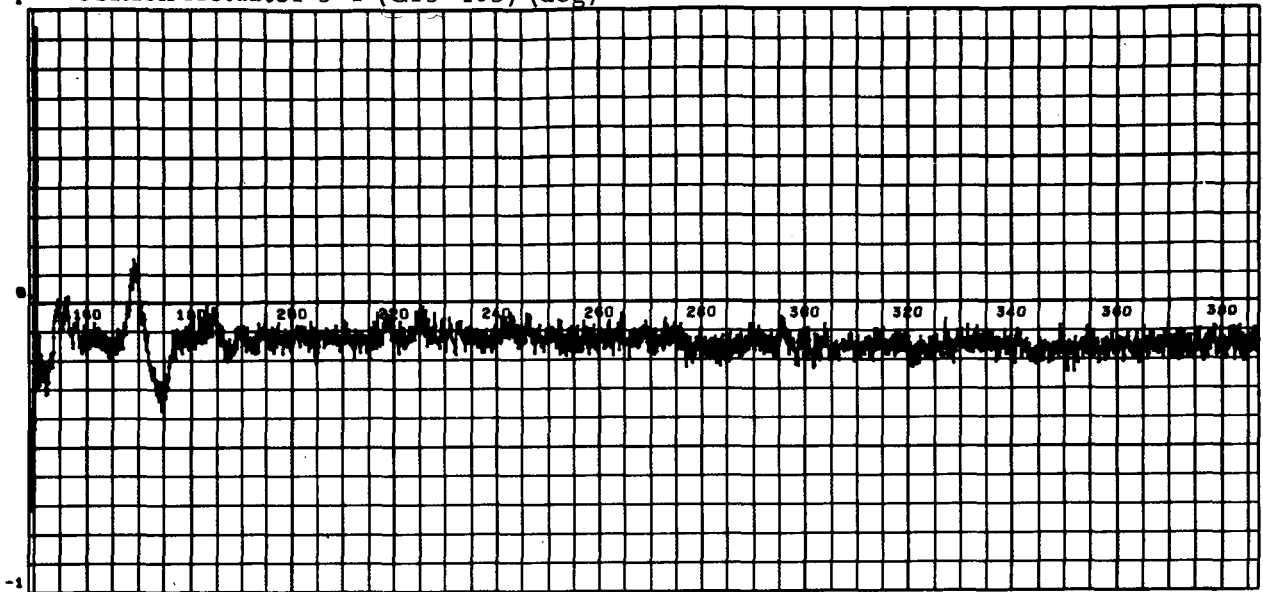

1 Position Actuator 6-3 (G17-406) (deg)

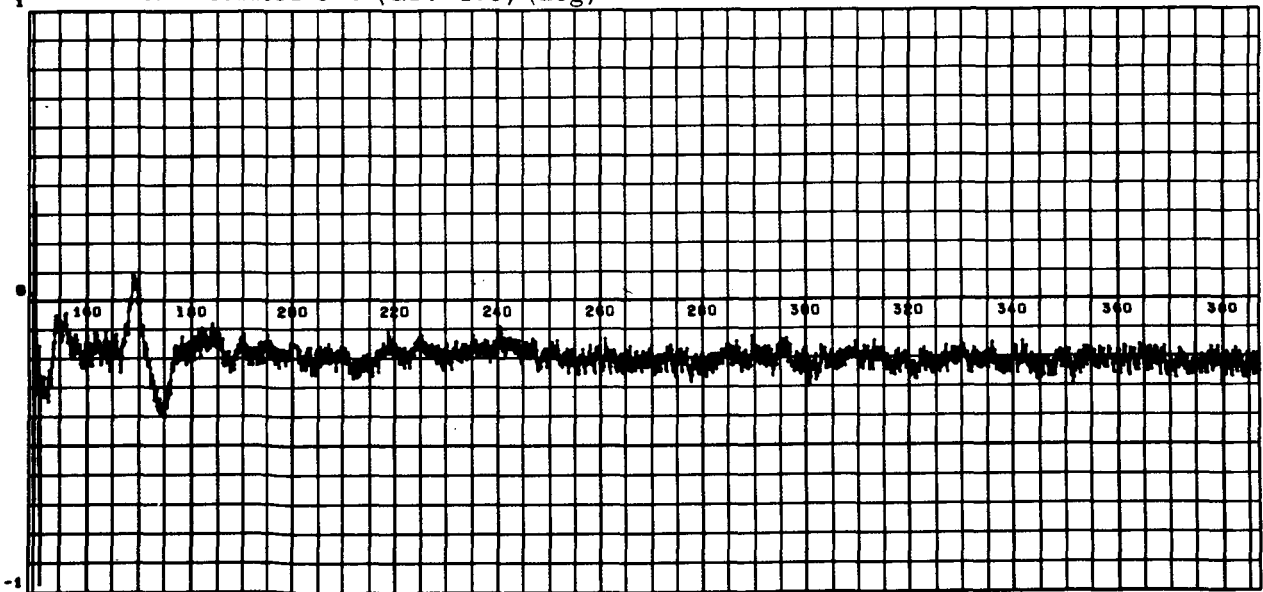

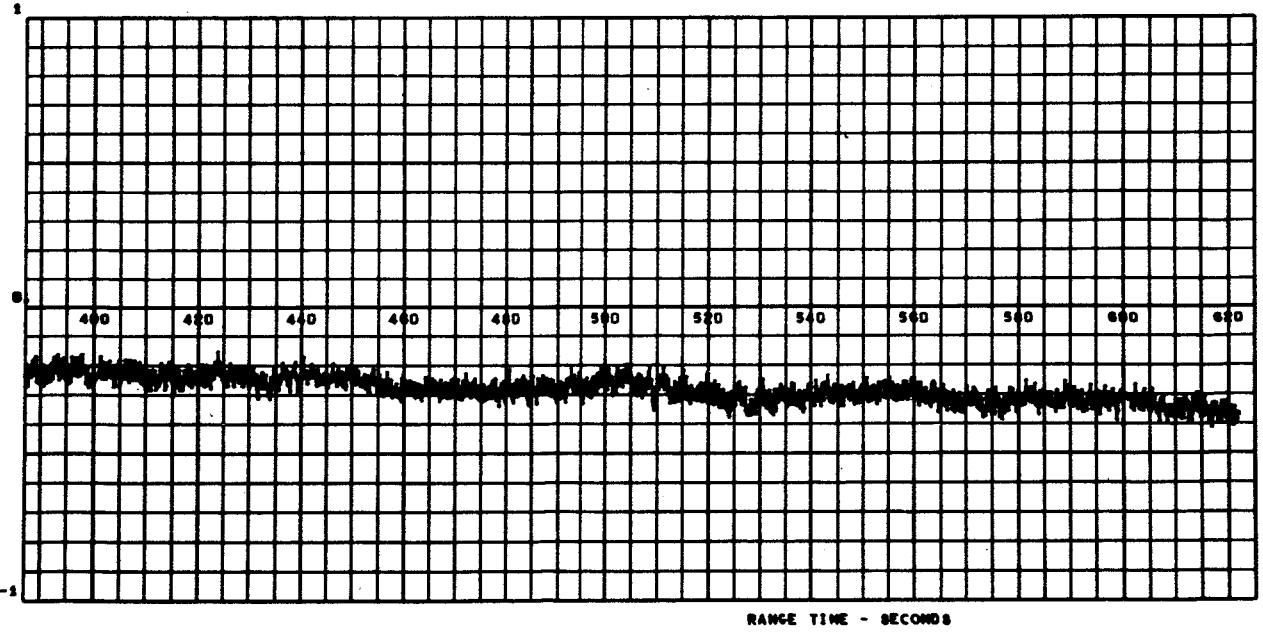
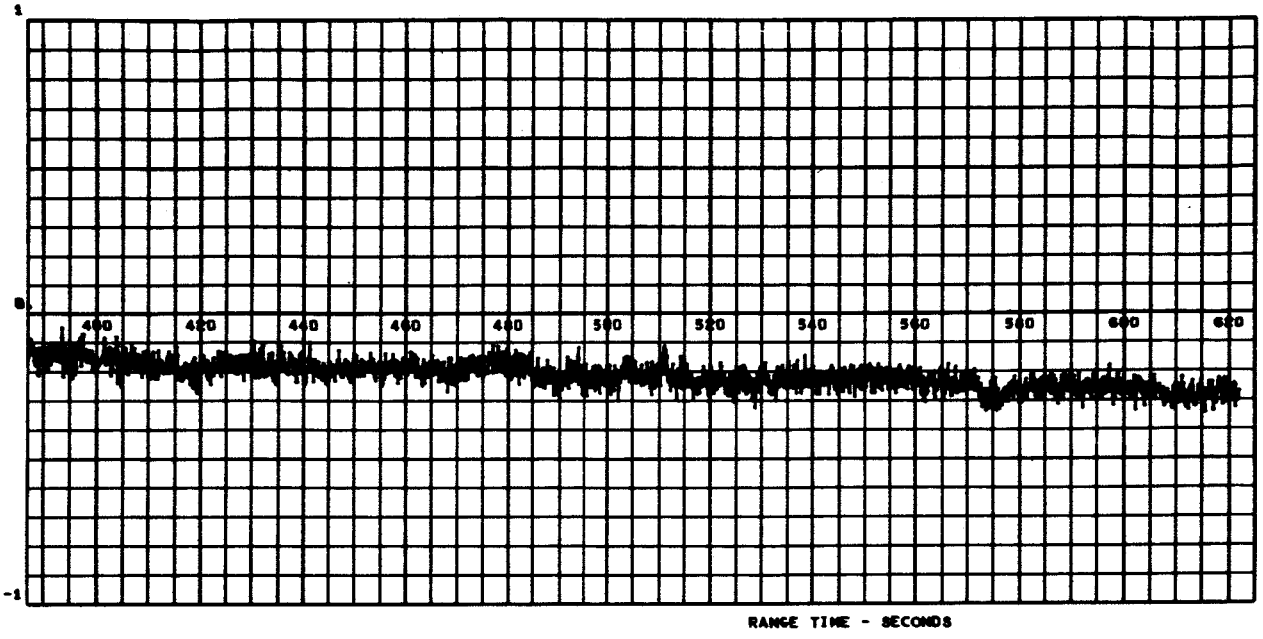

ACTUATOR POSITIONS (CONTD)

1 Position Actuator 5-2 (G15-405) (deg)

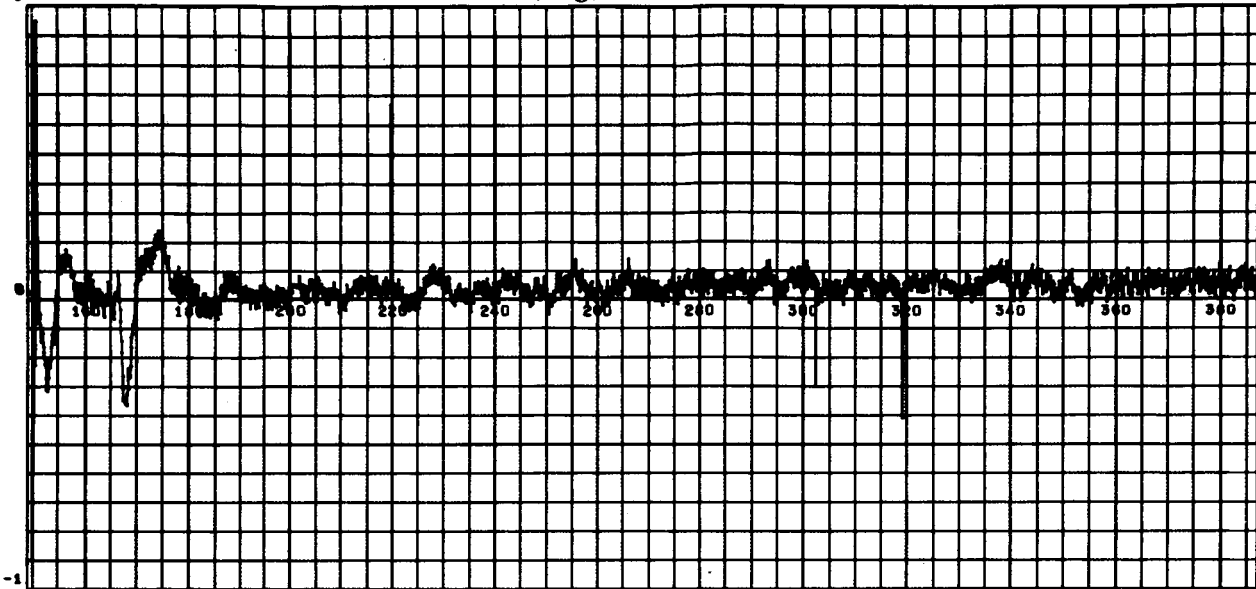

1 Position Actuator 6-4 (G18-406) (deg)

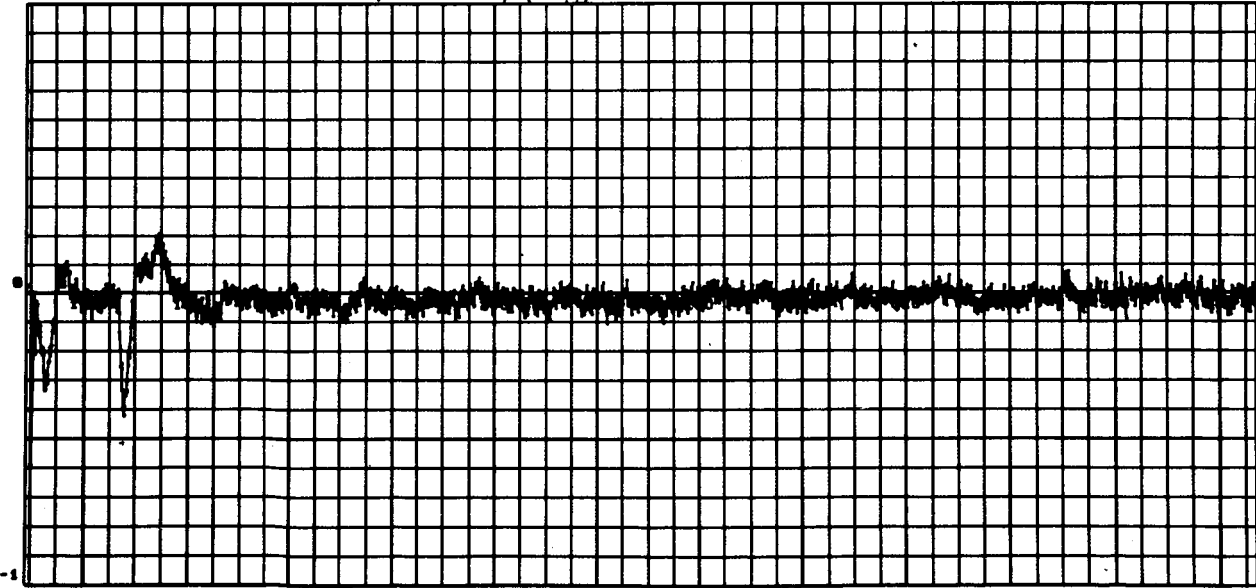

ACTUATOR POSITIONS

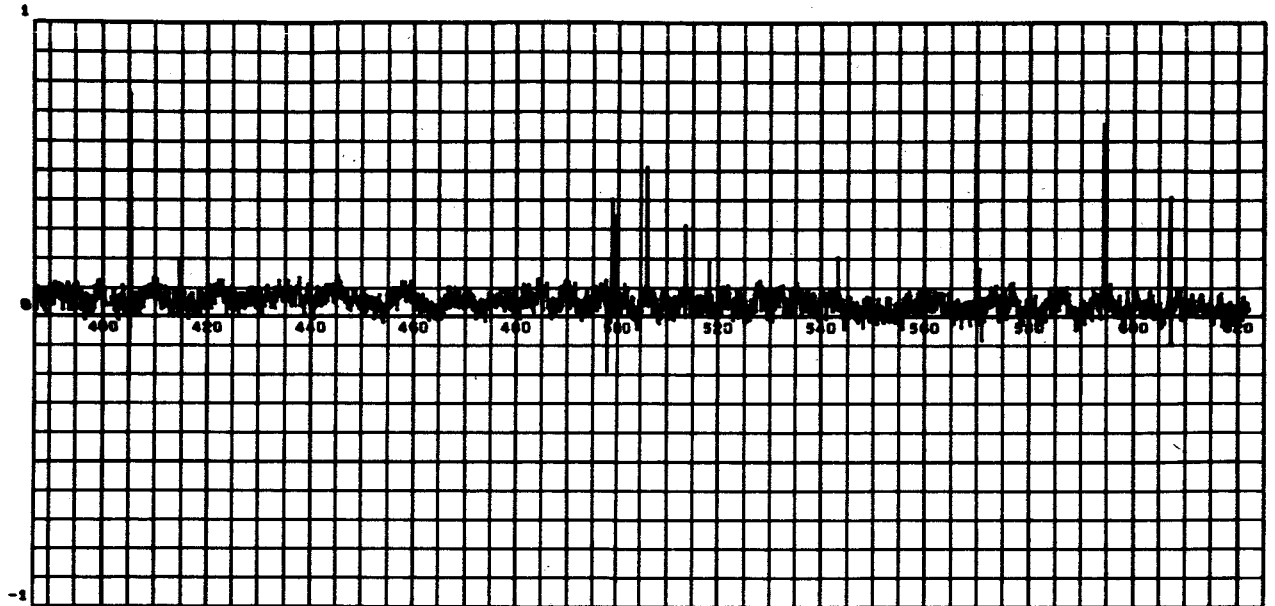

RANGE TIME - SECONDS

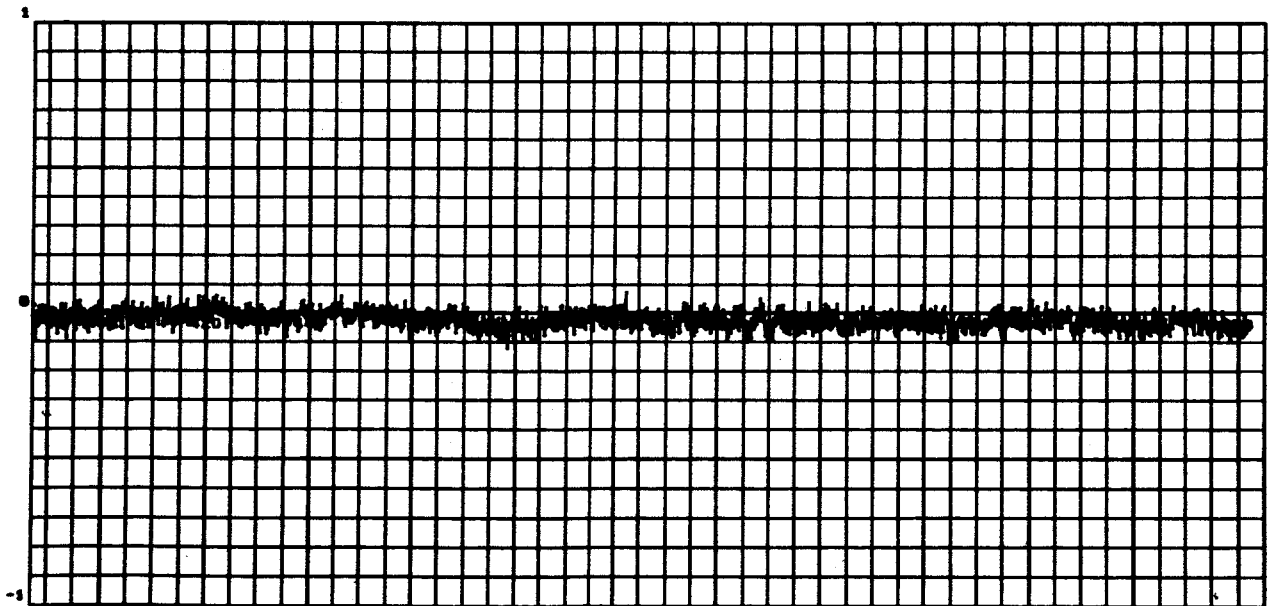

RANGE TIME - SECONDS

ACTUATOR POSITIONS (CONTD)

1 Actuator Position Pitch (Average) (deg)

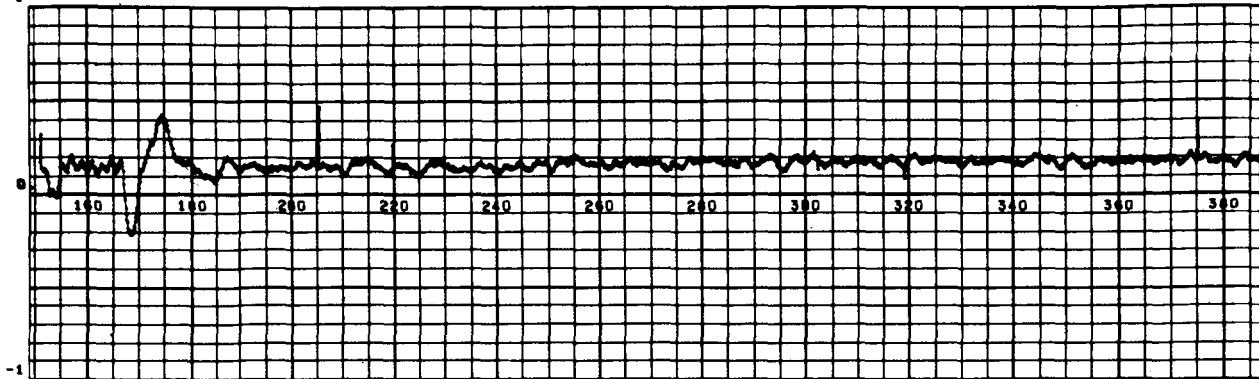

1 Actuator Position Yaw (Average) (deg)

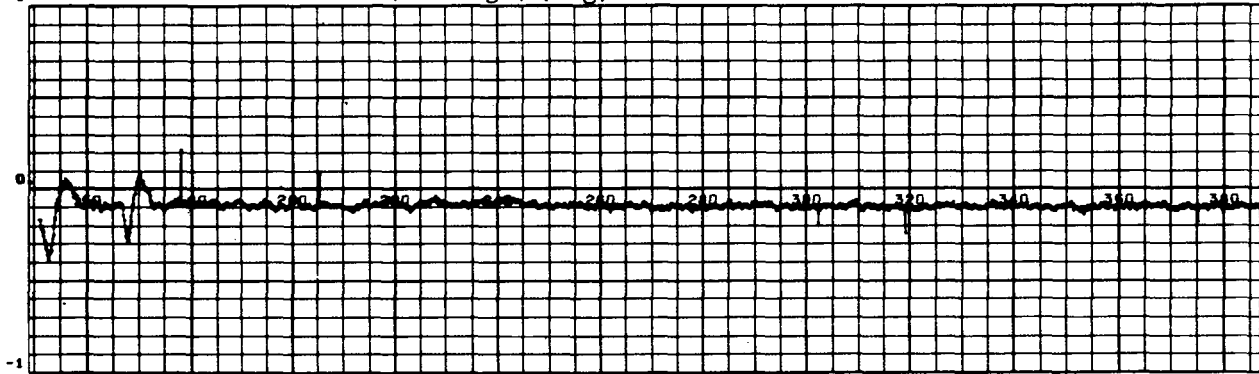

1 Actuator Position Roll (Average) (deg)

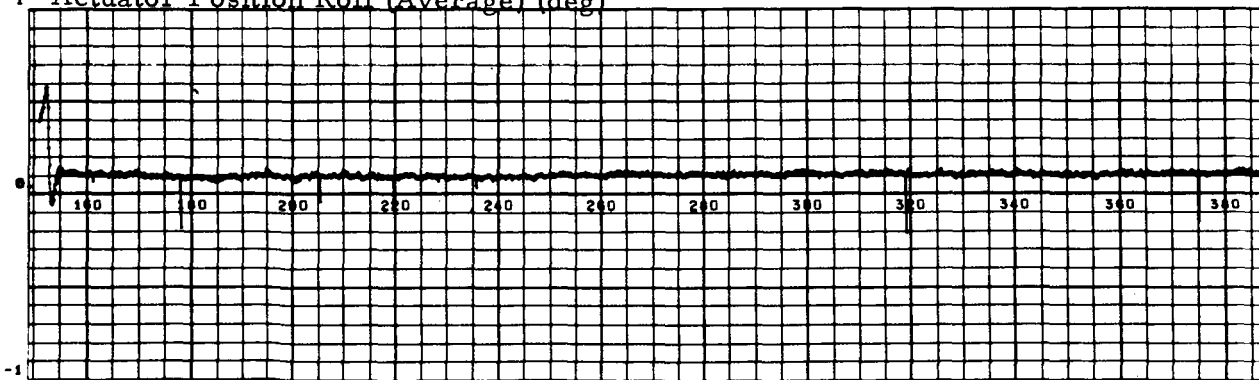

AVERAGE FLIGHT PLANE ACTUATOR POSITIONS

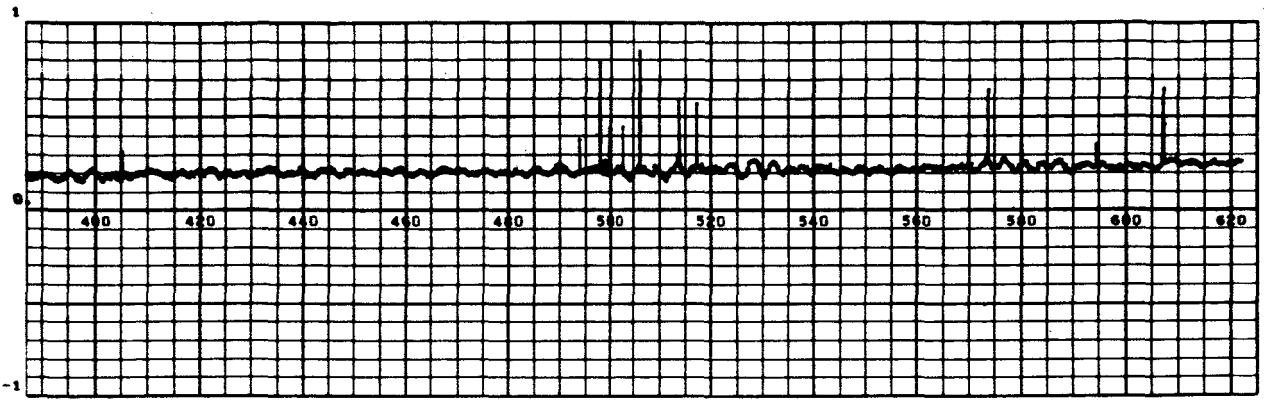

RANGE TIME - SECONDS

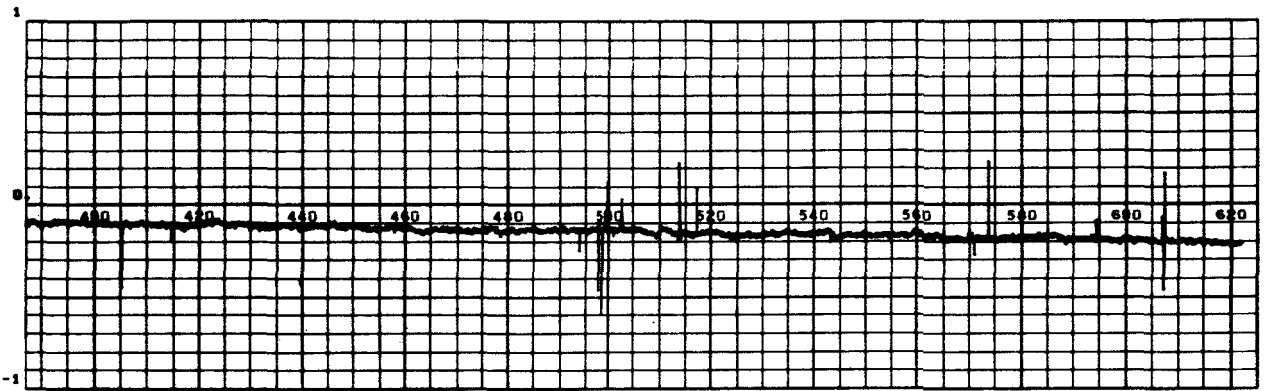

RANGE TIME - SECONDS

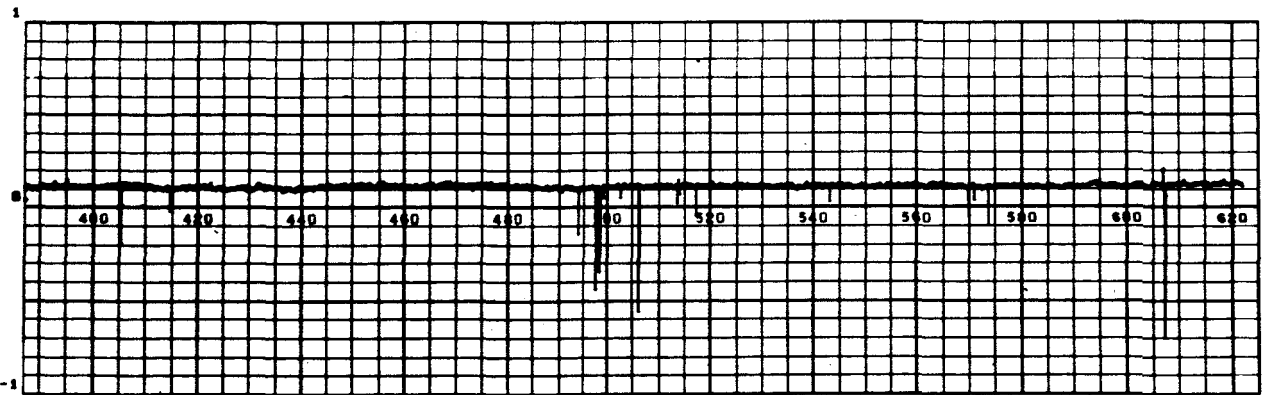

RANGE TIME - SECONDS

AVERAGE FLIGHT PLANE ACTUATOR POSITIONS (CONTD)

1 Angular Velocity, Pitch (F42-802)* (deg/sec)

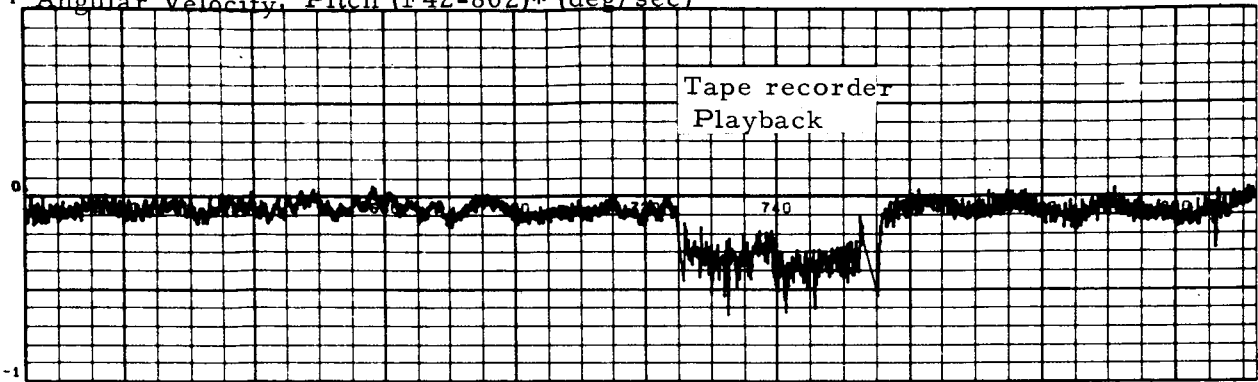

1 Angular Velocity, Yaw (F43-802)* (deg/sec)

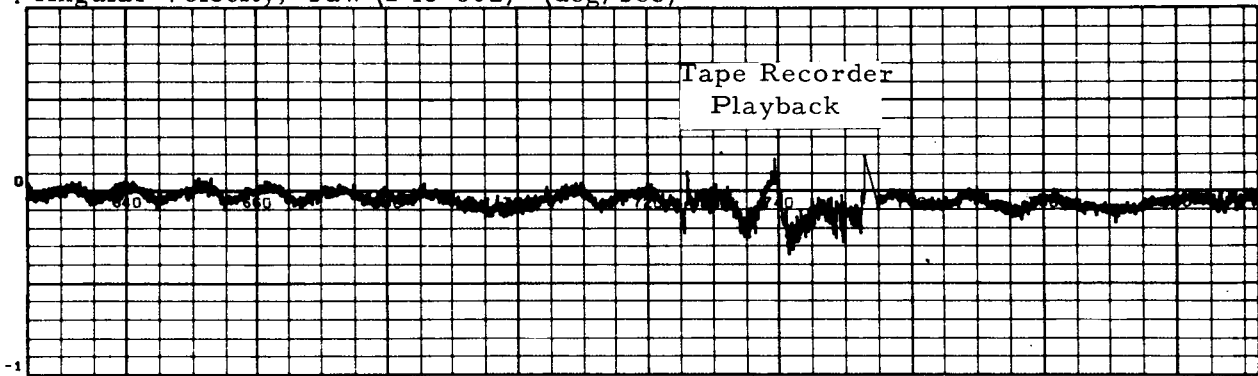

1 Angular Velocity, Roll (F44-802)* (deg/sec)

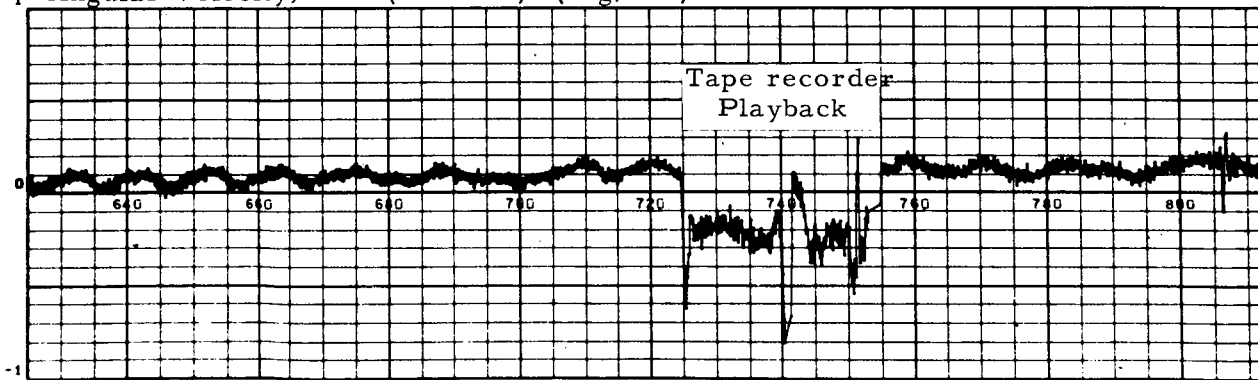

*Data not adjusted for telemetry biases- see page 6

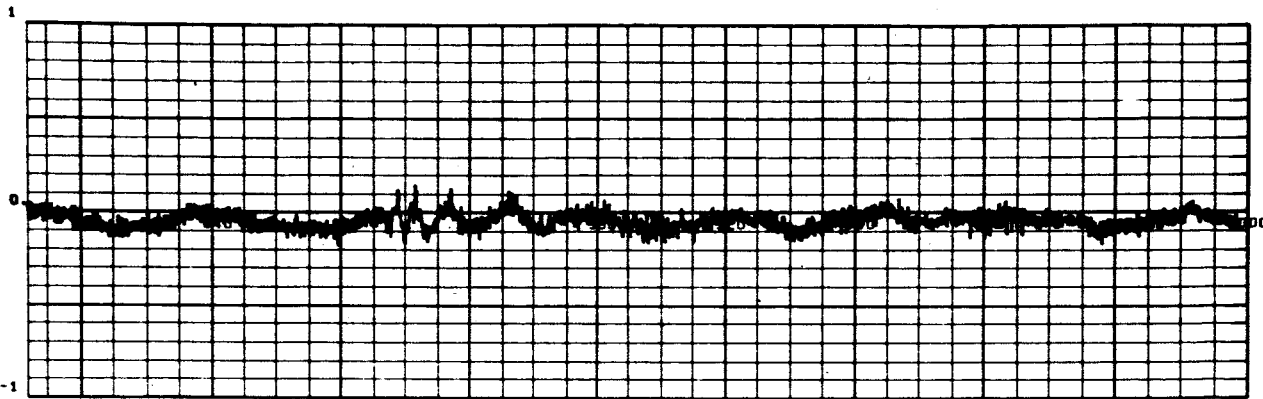

RANGE TIME - SECONDS

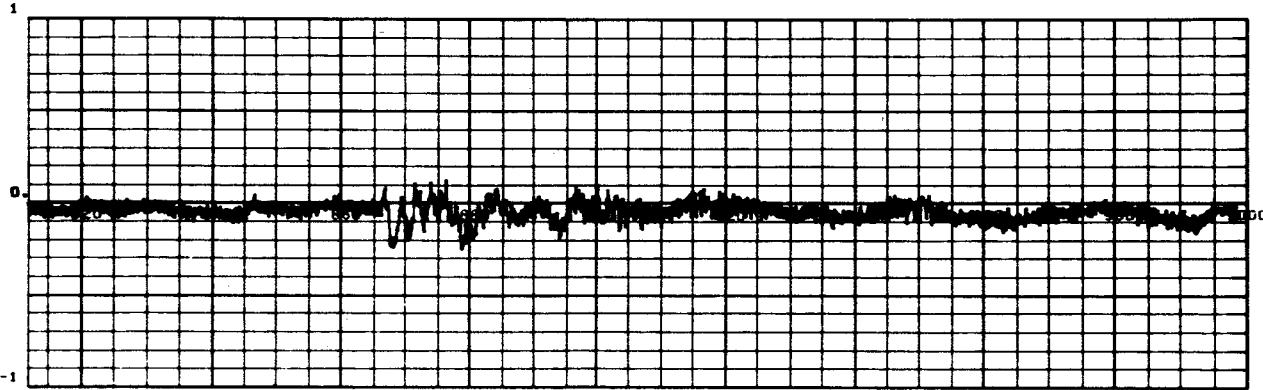

RANGE TIME - SECONDS

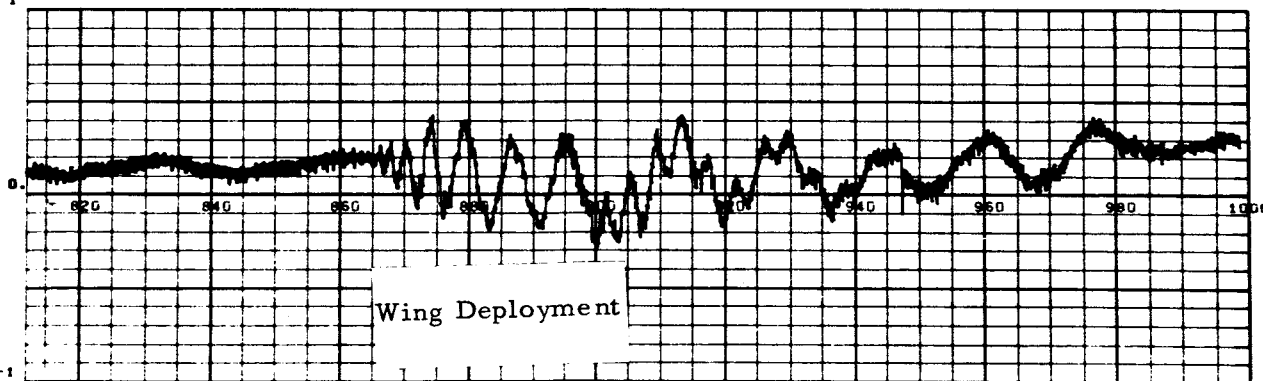

RANGE TIME - SECONDS

ORBITAL ANGULAR VELOCITIES (CONTD)

SA-8 FLIGHT TEST DATA REPORT

By H. J. Weichel

The information in this report has been reviewed for security classification. Review of any information concerning Department of Defense or Atomic Energy Commission program has been made by the MSFC Security Classification Officer. This report, in its entirety, has been determined to be unclassified.

This report has also been reviewed and approved for technical accuracy.



JAMES G. PAPADOPOULOS
Chief, Dynamics & Control Section



JAMES P. LINDBERG
Chief, Flight Evaluation Branch

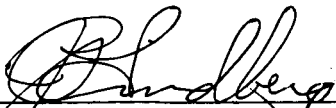

FRIDTJOF A. SPEER
Chief, Flight Evaluation and
Operations Studies Division

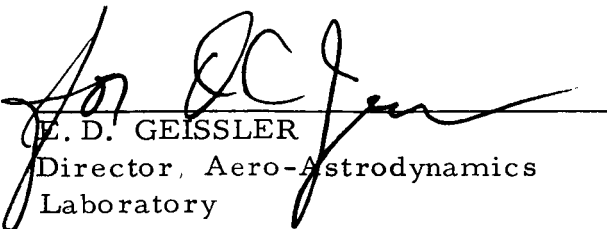

E. D. GEISLER
Director, Aero-Astrodynamic
Laboratory

DISTRIBUTION

DEP-T

R

Mr. Weidner, R-DIR
Dr. Kuettner, R-SA (3)

R-AERO

Dr. Geissler, R-AERO-DIR
Mr. Jean, R-AERO-DIR
Dr. Speer, R-AERO-F
Mr. Lindberg, R-AERO-FF (20)
Mr. Hagood, R-AERO-FF
Mr. Papadopoulos, R-AERO-FFD
Mr. Garcia, R-AERO-FFA
Mr. Sheats, R-AERO-FFR
Mr. Horst, R-AERO-FFT
Mr. Clarke, R-AERO-FP
Mr. W. Vaughan, R-AERO-Y
Mr. Dahm, R-AERO-A
Mr. Belcher, R-AERO-AEO
Mr. Ryan, R-AERO-DD
Mr. Horn, R-AERO-D
Dr. McDonough, R-AERO-D
Mr. Lovingood, R-AERO-G

R-P&VE

Mr. Heusinger, R-P&VE-PP
Mr. Head, R-P&VE-PPE
Mr. Hunt, R-P&VE-S
Mr. Sterett, R-P&VE-S
Mr. Neighbors, R-P&VE-AV
Mr. W. Schulze, R-P&VE-VS
Mr. McCullough, R-P&VE-VG

R-COMP

Mr. Cochran, R-COMP-RR
Mr. Hynes, R-COMP-RR
Mr. Neece, R-COMP-RR

R-ASTR

Mr. Moore, R-ASTR-N
Mr. Noel, R-ASTR-TJ
Mr. Hosenthien, R-ASTR-D
Mr. Mack, R-ASTR-NG
Mr. O. L. Smith, R-ASTR-IP
Mr. Derington, R-ASTR-IMP
Mr. Davis, R-ASTR-IMS
Mr. Taylor, R-ASTR-R
Mr. Escue, R-ASTR-IM
Mr. Humlet, R-ASTR-IMP

R-CUAL

Mr. Covington, R-CUAL-CTM

R-TEST

Mr. Driscoll, R-TEST-S

KSC

Major Petrone, K-P

MS

IPL (8)
IP
H

MS-T

Mr. Roy Bland (5)

MS-H

CC-P

I-RM-M

MSC

Mr. P. E. McKann, PT6 (3)

Scientific and Technical Inf. Facility
Attn: NASA Representative (S-AK/RKT (25)
P.O. Box 5700
Bethesda, Maryland