

NASA TECHNICAL NOTE



NASA TN D-3068

C.1

NASA TN D-3068

LOAN COPY: RETURN TO
AFWL (WLIL-2)
KIRTLAND AFB, NM



EVALUATION OF A SUBSCALE INTERNALLY INSULATED FIBER-GLASS PROPELLANT TANK FOR LIQUID HYDROGEN

by Laurence J. Heidelberg
Lewis Research Center
Cleveland, Ohio





EVALUATION OF A SUBSCALE INTERNALLY
INSULATED FIBER-GLASS PROPELLANT
TANK FOR LIQUID HYDROGEN

By Laurence J. Heidelberg

Lewis Research Center
Cleveland, Ohio

NATIONAL AERONAUTICS AND SPACE ADMINISTRATION

For sale by the Clearinghouse for Federal Scientific and Technical Information
Springfield, Virginia 22151 - Price \$2.00

EVALUATION OF A SUBSCALE INTERNALLY

INSULATED FIBER-GLASS PROPELLANT

TANK FOR LIQUID HYDROGEN

by Laurence J. Heidelberg

Lewis Research Center

SUMMARY

The use of fiber-glass-reinforced plastics as a structural material, in conjunction with internally located foam insulation for liquid-hydrogen propellant tanks, was investigated by designing, fabricating, and experimentally evaluating a subscale tank. The tank consisted of three main components: a structural shell of filament-wound fiber glass, an internal insulation system of polyurethane foam encapsulated in a vacuum-tight jacket of aluminum-Mylar-aluminum foil laminate, and an impermeable liner of the same laminate. Liquid-hydrogen boiloff tests were used to determine the thermal performance and pressure-cycling tests were used to evaluate structural performance.

The investigation shows the current state-of-the-art capable of producing a leak-tight fiber-glass tank for liquid hydrogen. It was found that the internal insulation performed well with a heat flux through the 1/2-inch wall thickness of about 90 Btu/(hr)(sq ft), corresponding to a thermal conductivity of 0.096 (Btu)(in.)/(hr)(sq ft)(°F). Although liner failure occurred 30 percent below the design pressure of 100 pounds per square inch, design changes were indicated that would substantially increase liner performance. The limited extensibility of the liner limits the use of fiber glass to its full potential. Allowing the liner to wrinkle seems to be a promising solution to the problem.

INTRODUCTION

The use of liquid hydrogen as a propellant in both chemical and nuclear rocket systems results in a significant increase in performance over any other fuel or propellant. Unfortunately, liquid hydrogen also has some undesirable properties such as a very low boiling point, -423° F, and a low density, 4.4 pounds per cubic foot. The theoretical increase in rocket performance by the use of liquid hydrogen instead of more dense propellants is partially lost due to the need for larger, and thus, heavier, tanks. Because the liquid-hydrogen tank weight is a large part of the total vehicle weight, a small percentage reduction of the tank weight can result in a sizable increase in the payload capabilities of a vehicle.

As a part of a general research program on liquid-hydrogen tankage problems, pressurization, insulation, and structures, the NASA Lewis Research Center is investigating the use of fiber-glass-reinforced plastics as a structural material for tanks. Fiber-glass-reinforced plastics weigh at least 30 percent less than the most competitive metal for the same loading conditions (refs. 1 and 2). Filament-wound fiber-glass-reinforced plastics have been successfully used where minimum-weight structures were essential such as, motor cases on the Polaris missile and high-pressure gas storage bottles. The present state of knowledge on the use of fiber-glass-reinforced plastic structures as liquid-hydrogen tanks is limited to analytical and a few preliminary experimental studies. No experimental evaluation of a complete fiber-glass cryogenic propellant tank has been reported.

Although filament-wound fiber-glass-reinforced plastic tanks are lightweight, they have a serious limitation. Even when unstressed they are usually porous unless they have a thick wall or an excess of plastic resin. In all cases, porosity begins at a stress level well below the design burst stress. Thus an internal impermeable liner or sealer is required. Sealers and liners have been developed for use at normal and elevated temperatures but not for cryogenic temperatures. The thermal contraction of conventional sealers is greater than for reinforced plastics. Thus, as the tank is filled with cryogen, the sealer is subjected to thermal stress that in most cases would be high enough to cause failure of the sealer and/or the tank. In addition, conventional sealers, like most materials, become very brittle at liquid-hydrogen temperatures. Development of a suitable sealer or impermeable liner is one of the major problems associated with the use of filament-wound fiber-glass tanks for storing liquid hydrogen. This problem is further complicated by the high extensibility of filament-wound fiber-glass-reinforced plastic structures. Elastic strains of 3 to 5 percent at liquid-hydrogen temperature are to be expected of these structures (ref. 3). No liner material has yet been found that is capable of this much elastic strain at liquid-hydrogen temperature.

The low boiling temperature of liquid hydrogen requires the propellant tanks be insulated to maintain liquid losses and/or tank operating pressures within acceptable limits. The insulation may be applied internally or externally on the tank walls. Since insulation is another weight penalty which detracts from the high performance of liquid hydrogen, the insulation should be as light as possible. At the present time, the low-density, low thermal-conductivity polyurethane foams are receiving much attention. These foams, although of a closed-cell structure, are permeable to gases; thus externally applied insulation must be designed to prevent air and atmospheric moisture from condensing in and behind the insulation due to the cryopumping action of the cold tank wall. Liquid inside insulations greatly increases the thermal conductivity. Internally applied insulation also requires that the insulation be designed to prevent liquid and gaseous hydrogen permeation. Thus, the insulation must be either sealed or purged with helium gas. The sealed insulation can be evacuated by either cryopumping or mechanical pumping. Evacuation of the insulation decreases the thermal conductivity while purging increases the thermal conductivity. Another problem associated with the insulation, internal or external, is the attachment of the insulation to the tank structure. The low-density foams, like most good insulating materials, are structurally very weak. As a result, the weight of the attachments can be a significant fraction of the total insulation-system weight.

The filament-wound fiber-glass-reinforced plastic concept for liquid-hydrogen tanks may not only result in a considerable weight savings in the tank structure itself, but may provide a convenient lightweight method of attaching the insulation to the inside of the tank by winding the tank over the insulation. In addition, a single impermeable liner may satisfy both the need to seal the filament-wound structure and the need to seal the insulation for improved thermal performance. Thus a composite tank structure in which the insulation and sealers are used as part of the mandrel over which the tank is wound appears to have considerable merit. This concept, however, has to be evaluated experimentally because theoretical analysis of composite structures such as this is impractical at the present state of the art. Theoretical analysis is also hampered by the fact that all the thermal and physical properties of the individual materials of such a composite structure are not known over the range of conditions encountered in liquid-hydrogen application.

The objective of the research reported herein was to design, fabricate, and evaluate experimentally the thermal and structural performance of a simple composite subscale tank structure. It should be noted that the structural evaluation was limited to pressure loading only and before this tank concept can be applied to launch regions, other loadings such as bending and axial compression must be considered. The subscale test tank was designed to the following general requirements:

- (1) A lightweight load-carrying reinforced-plastic shell constructed by the filament-winding process
- (2) A capacity of about 40 gallons
- (3) A maximum operating pressure of 100 pounds per square inch gage
- (4) Withstand six temperature cycles from room temperature to -420° F at 1 atmosphere
- (5) A thin impermeable liner capable of containing gaseous and liquid hydrogen
- (6) A lightweight thermal-insulation system employing low-density plastic foam encapsulated in a vacuum-tight casing and located inside the structural shell.

The design, in conjunction with NASA, and fabrication of the test tank was done by Goodyear Aerospace Corporation, Akron, Ohio under contract number NAS3-2291 for Lewis Research Center. Details of the design and fabrication are presented in reference 4. Experimental evaluation was performed at Lewis Research Center. The results of these tests, thermal and structural performance, are presented in this report along with a summary of the design and fabrication of the tank. Included also are limited data obtained in preliminary tests on some properties of materials that were required in the design of the tank.

DESIGN AND DESCRIPTION OF TANK

An 18-inch-diameter by 36-inch-long pressure-vessel configuration with an approximate capacity of 40 gallons was selected for the test tank. The major components as shown in figure 1 are: (1) a filament-wound fiber-glass structural

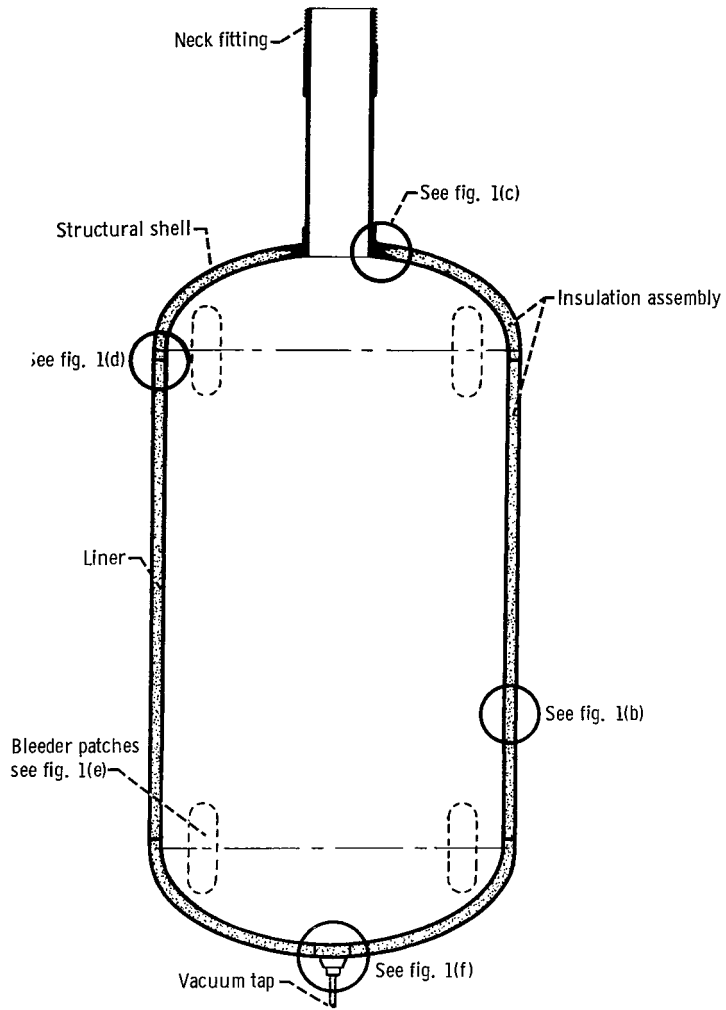

(a) Complete test tank.

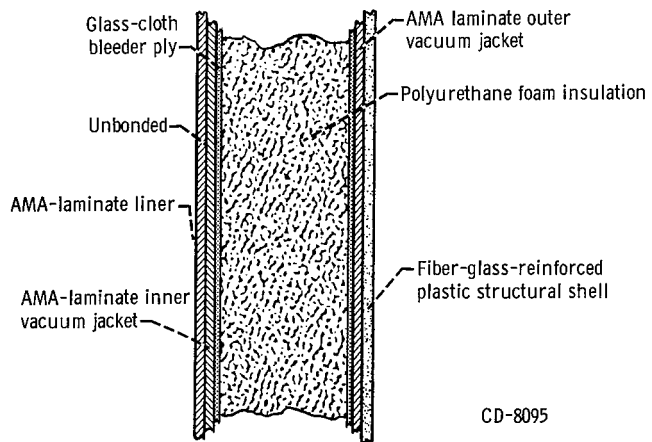

(b) Enlarged typical section through tank wall.

Figure 1. - Details of filament-wound liquid-hydrogen test tank. All surfaces bonded except as indicated. (Not to scale.)

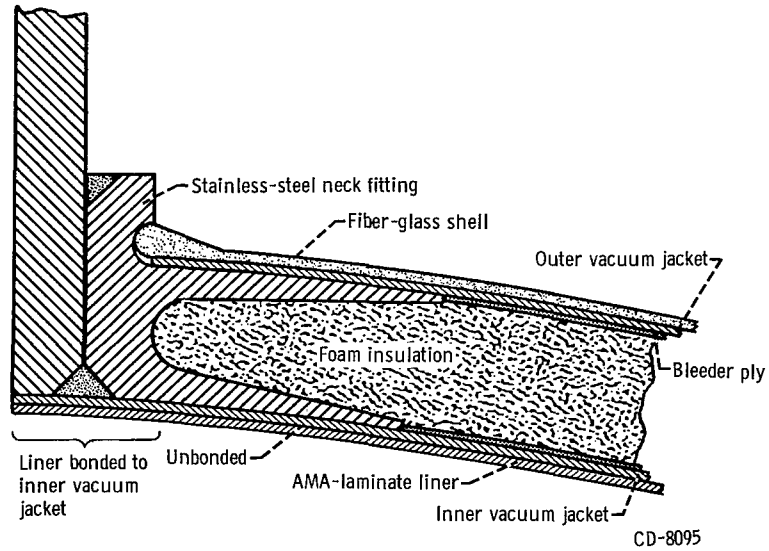

(c) Detail of neck fitting (doublers not shown).

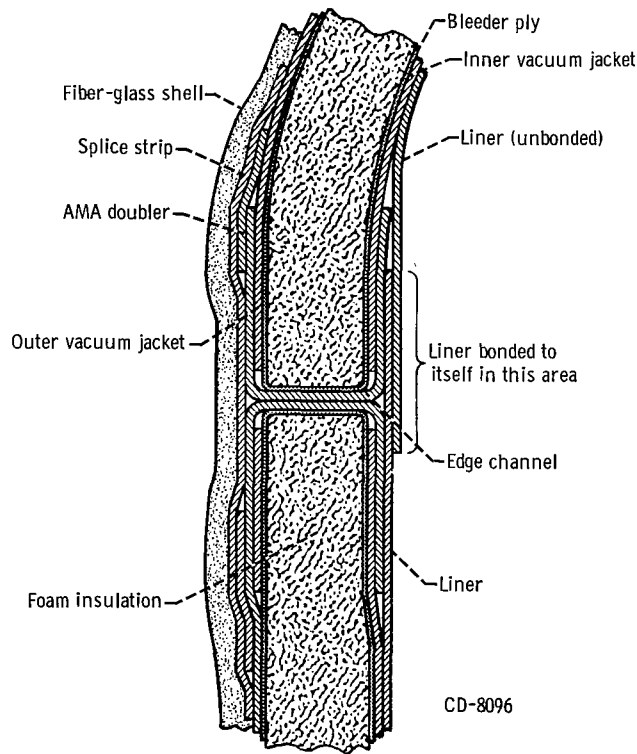

(d) Detail of typical splice between dome and cylinder.

Figure 1. - Continued. Details of filament-wound liquid-hydrogen test tank. All surfaces bonded except as indicated. (Not to scale.)

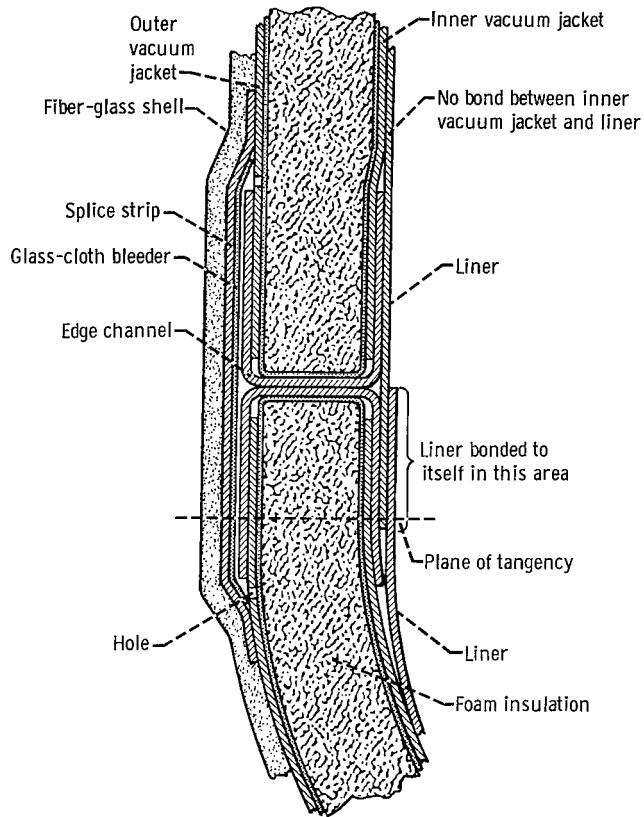

(e) Detail of section through bleeder patch (doublers not shown).

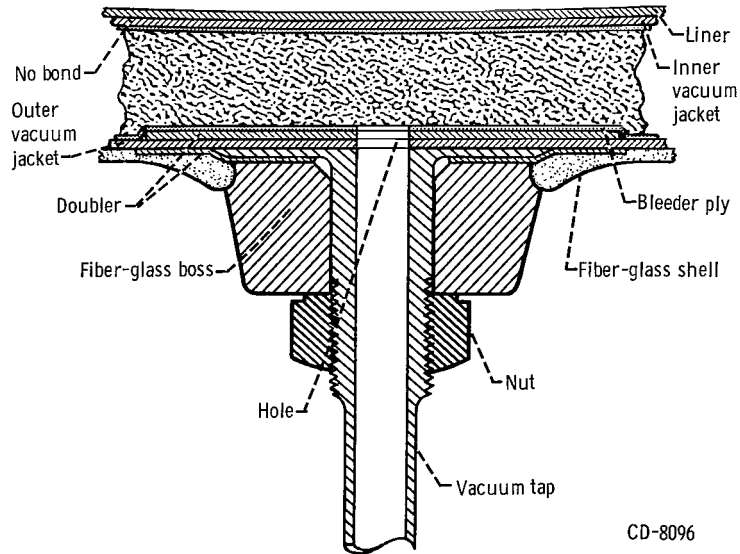

(f) Detail of vacuum tap.

Figure 1. - Concluded. Details of filament-wound liquid-hydrogen test tank. All surfaces bonded except as indicated. (Not to scale.)

CD-8096

shell; (2) a three-piece insulation assembly comprised of a top dome, a cylinder section, and a bottom dome; and (3) a cryogenic liner assembly comprised of two dome ends and a cylinder which are assembled to fit closely against, but not bonded to, the inner walls of the insulation assembly.

Filament-Wound Fiber-Glass Structural Shell

The construction of the structural shell is heavier than required for 100 pounds per square inch gage internal pressure; however, this construction is considered a practical minimum to create a tank shell sufficiently rigid to withstand handling loads. In order to stress a tank with the same wall thickness to near its breaking point with a pressure of 100 pounds per square inch gage, the tank diameter must be 9 feet. This size tank was considered impractical since there were no available test facilities large enough to handle it.

The filament-wound shell is of balanced design consisting of two layers of longitudinal wrap (412 total ends per in.) and four layers of circumferential wrap (736 total ends per in.). Roving, consisting of 20-end S/HTS fiber-glass wet impregnated with a low-temperature curing epoxy resin system, was used in winding the shell. Figure 2 shows the completed filament-wound tank.

Internal Insulation Assembly

The internal insulation is divided into three sections; namely, (1) the upper dome, (2) the cylindrical section, and (3) the bottom dome. Each section is comprised of polyurethane foam, two bleeder plies, and an inner and outer vacuum jacket of aluminum-Mylar-aluminum foil laminate, hereinafter designated as AMA in this report.

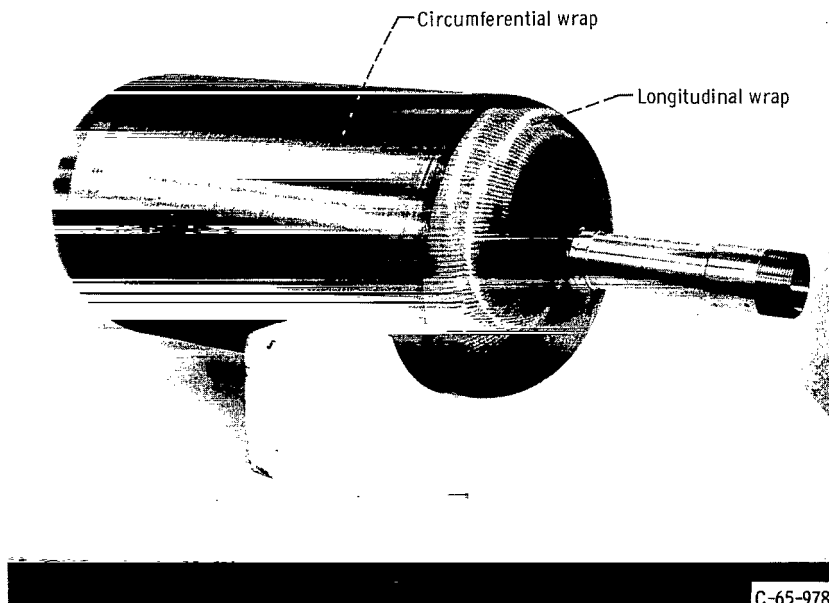

C-65-978

Figure 2. - Completed filament-wound test tank.

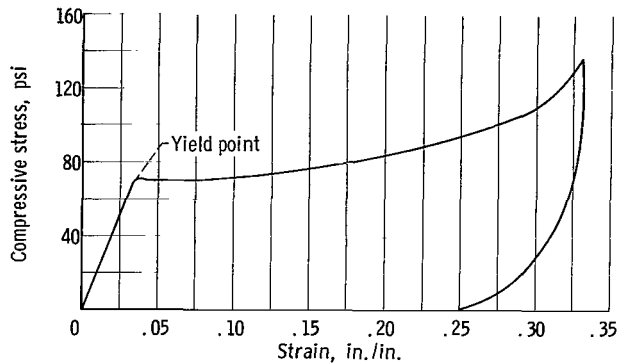

Figure 3. - Typical stress-strain curve for polyurethane foam. Room-temperature compression test; density, 4 pounds per cubic foot; modulus of elasticity, 2500 pounds per square inch.

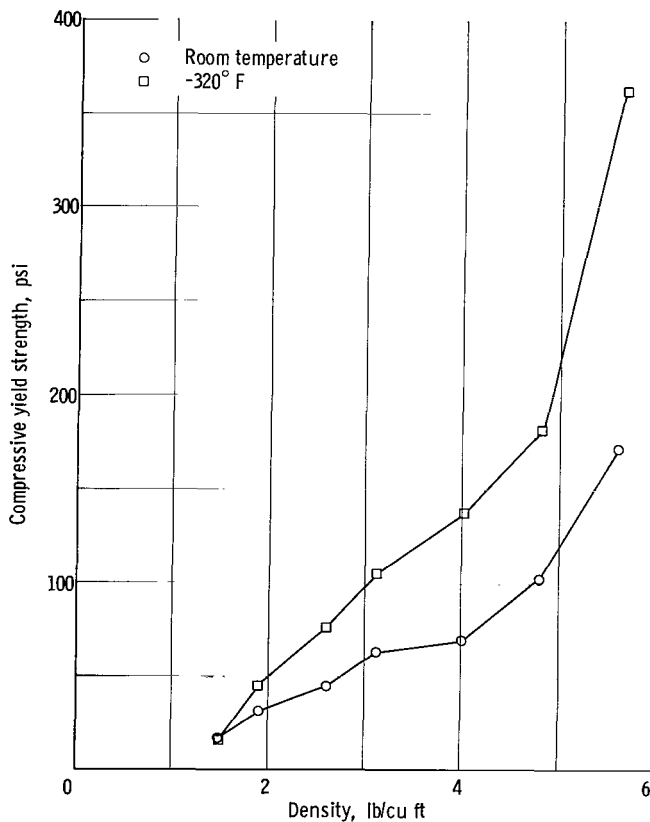

Figure 4. - Compressive yield strengths of various density polyurethane foams.

The foam acts as both an insulator and a structural media for transmitting the internal loads to the structural shell. The foam-insulation thickness for this tank was 0.50 inch and was selected to facilitate the fabrication of the dome ends by foam-in-place techniques. The cylindrical section of foam insulation was made by machining a foam cylinder. Various density foams were tested at the Lewis Research Center to determine compressive yield strength at both room temperature and -320° F. Figure 3 shows a stress-strain curve obtained during testing. This curve shows a distinct yield point typical of all the tests in this series. Figure 4 summarizes the results of these tests. As expected there is a substantial increase in strength with a decrease in temperature. The selection of a 4-pounds-per-cubic-foot density foam was based on its strength at -320° F being greater than the 100 pounds per square inch required. Later in the program, it was realized that the room-temperature strength is the controlling factor in the selection of the density. Since a temperature gradient from near room temperature to -423° F exists in the foam when storing liquid hydrogen, local yielding would occur first in the foam at the highest temperature (that is on the outer surface). For the 4-pounds-per-cubic-foot foam, yielding would occur when a pressure of just 70 pounds per square inch is exerted.

Because the insulation is evacuated, it always has a 1 atmosphere load on it and when the tank is pressurized the stress in the foam is equal to the absolute pressure in the tank. This is only true when the liner and inner vacuum jacket are unstressed. Since this is unlikely at a tank pressure of 100 pounds per square inch gage, they would take

some of the load and not transmit the full pressure to the foam. Thus, selecting a foam with a yield strength at room temperature equal to the maximum absolute pressure in the tank would be building in a safety factor.

The cryopumping of residual gas which takes place within the foam insulation during actual storage of liquid hydrogen is essential to the thermal performance of the system. It can be seen that the reliability of this insulation system is dependent on one stringent requirement - that the vacuum jacket over the foam be leak-tight and remain so throughout the useful life of the tank. On the basis of previous experience with the AMA laminate used as a vacuum jacket in external insulation systems, it was selected as the vacuum jacket for this tank. A laminate is a more reliable barrier than a single layer because the chance of pinholes lining up in the different layers to create a leak is extremely small. This material can be joined with an adhesive bond and formed into the shapes required.

The vacuum jackets on the cylindrical section of the insulation are prestressed (the reason for prestressing will be discussed later) 0.0024-inch thick AMA (two 0.7-mil thick layers of aluminum foil on each side of 1-mil thick Mylar) sheets fitted and bonded to the inner and outer walls of the foam cylinder. The ends of the AMA sheets are connected by a longitudinal lap joint. Sealing the vacuum jacket is completed at each end of the cylinder by bonding a spin-formed 0.005-inch-thick AMA (2 mil aluminum-1 mil Mylar-2 mil aluminum) channel to the jackets (see fig. 1(d), p. 5). The dome-section vacuum jackets were spin formed necessitating the use of a heavier, 0.005-inch thick AMA.

An important feature incorporated in the design of this tank is a glass-cloth layer between the foam to vacuum jackets (see figs. 1(b) and 5). The glass cloth is a bleeder ply (provides a path for gas flow) incorporated to serve the following purposes: (1) facilitate checking the vacuum jackets of each of the insulation components, (2) permit monitoring of the vacuum within the insulation during evaluation tests, and (3) permit rapid detection and vacuum

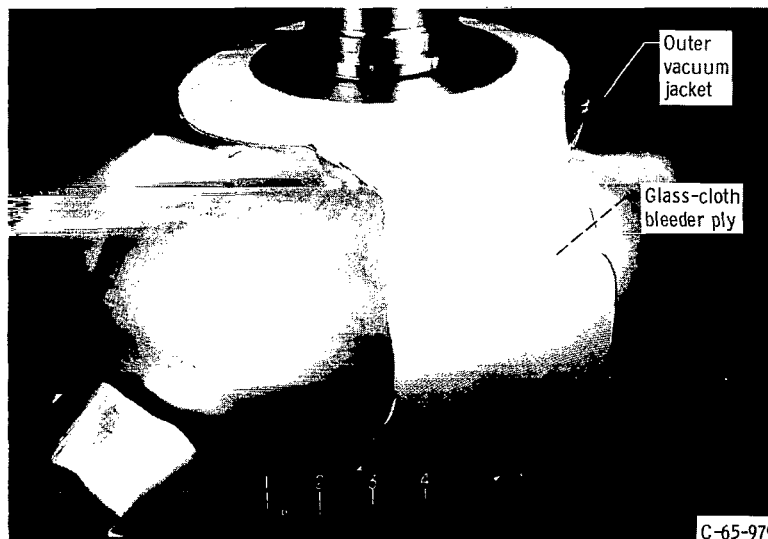

Figure 5. - Top dome insulation (outer vacuum jacket peeled away to expose bleeder ply).

near room temperature to -423° F will be established in the foam. For this reason the foam was considered to be made up of five separate isothermal shells, each 0.100 inch thick and free to contract upon cooling. The total decrease in thickness for all five layers is 0.0062 inch. If the tank is pressurized and all the layers are forced together the inner radius of the foam will be 0.0062 inch larger due to thermal contraction. This will cause an additional strain in the liner of 0.0007 inch per inch when the internal pressure forces the liner against the foam. Thus, the total thermal strain after pressurization will be $0.004 + 0.0007$ or 0.0047 inch per inch.

The fiber-glass shell will expand upon pressurization of 100 pounds per square inch gage as follows: If it assumed that the tank shell carries the entire load in the structure (for the purpose of this calculation, the preceding approximation is sufficient), the composite stress of the circumferential wrap S is given by

$$S = \frac{PR}{t}$$

where P is the internal pressure, R is the tank-shell radius, and t is the circumferential wrap thickness. For this tank shell, $P = 100$ pounds per square inch gage, $R = 8.95$ inches, and $t = 0.025$ inch. Then

$$S = \frac{100(8.95)}{0.025} = 35\ 800 \text{ psi}$$

The tank-shell strain ϵ may be found by

$$\epsilon = \frac{S}{E}$$

where E is the modulus of elasticity of the hoop material. If $E = 7.4 \times 10^6$ pounds per square inch, then

$$\epsilon = \frac{35\ 800}{7.4 \times 10^6} = 0.0048 \text{ in./in.}$$

(All symbols are defined in the appendix.)

The compression of the foam due to the 100-pound per square inch load will cause an additional liner strain. The average modulus of elasticity of the foam insulation in compression with the more than 400° R temperature gradient through its thickness was chosen as 3000 pounds per square inch, an arbitrary increase over 2500 pounds per square inch as shown in figure 4. The foam strain is then $\epsilon = \frac{100}{3000} = 0.033$ inch per inch and the resultant liner strain is

$$\epsilon = \frac{2\pi \Delta R_g}{2\pi R_g}$$

where the liner radius $R_g = 8.40$ inches. For the 1/2-inch foam thickness

$$\Delta R = 1/2 (0.033) = 0.017 \text{ in.}$$

Thus

$$\epsilon = \frac{0.017}{8.40} = 0.0020 \text{ in./in.}$$

Therefore, if the tank is filled and pressurized to 100 pounds per square inch gage the liner will have to expand a total of 0.0047 inch (thermal strain) + 0.0048 inch (shell strain) + 0.0020 inch (liner strain due to foam compression) or 0.0115 inch per inch. The mechanical properties of the liner material must be known before the effect of such a strain can be predicted.

A materials-testing program was undertaken to determine the properties of the AMA laminates. Tests were conducted at both room temperature and -300° F. Table I shows the results of these tests. Figures 6 through 9 are typical stress-strain curves recorded during the tests. Figure 6 is a curve of a room-temperature tensile test of the AMA laminate. It should be noted that this curve does not exhibit a yield point but, yields gradually rather than abruptly. When the same test is run at -300° F (fig. 7), the curve shape is the same but the stress values are nearly twice as high for the same strain. It is obvious that a strain of 0.0115 inch per inch is much beyond the elastic limit of this material. Thus, when this material is used as a liner it will be oversized after the first pressure cycle and wrinkles will occur.

TABLE I. - RESULTS OF TENSILE TESTS ON AMA LAMINATE

[Ultimate Tensile Strength and Modulus]

Material	Test temperature, °F	Number of specimens	Gage length, in.	Specimen direction (a)	Average ultimate tensile strength, psi	Average modulus of elasticity, psi
0.0007 Aluminum .001 Mylar .0007 Aluminum ↓	Room temperature	5	4	L	12 740	2.42×10 ⁶
		5	4	C	13 530	2.43
		5	8	L	12 770	2.66
		5	8	C	13 280	3.11
		5	12	L	12 950	3.02
	↓ -300 -300	5	12	C	13 050	3.10
		5	20	L	13 610	2.99
		5	20	C	13 070	2.94
		1	5	L	26 020	4.56
		6	6	L	24 240	-----
0.002 Aluminum .001 Mylar .002 Aluminum	Room temperature	5	4	L	10 500	3.76×10 ⁶
	Room temperature	5	20	L	10 300	5.39
	-300	3	6	L	18 450	-----
	-240	1	6	L	17 420	-----

^aThe laminated material was supplied by the manufacturer in rolls.

C - Across the direction the material is rolled in.

L - Along the direction the material is rolled in.

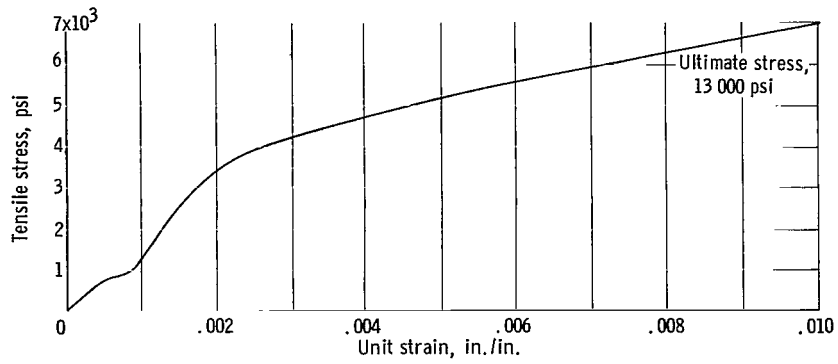

Figure 6. - Room-temperature stress-strain curve for AMA laminate (0.0007 in. aluminum, 0.001 in. Mylar 0.0007 in. aluminum).

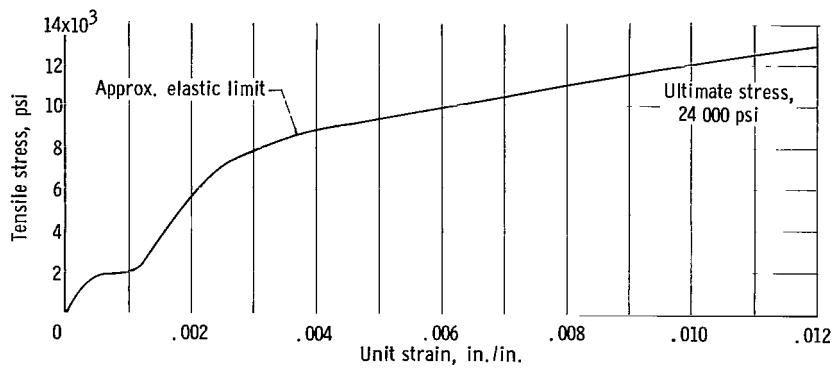

Figure 7. - -300°F stress-strain curve for AMA laminate (0.0007 in. aluminum, 0.001 in. Mylar, 0.0007 in. aluminum).

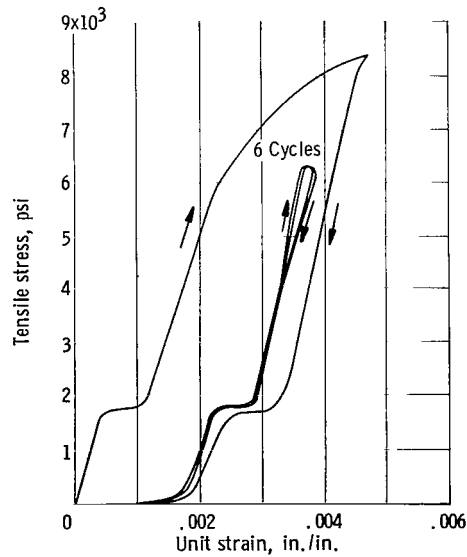

Figure 8. - Stress-strain curve of AMA laminate showing six loading cycles after an initial stress of 8300 pounds per square inch. Temperature, -300°F .

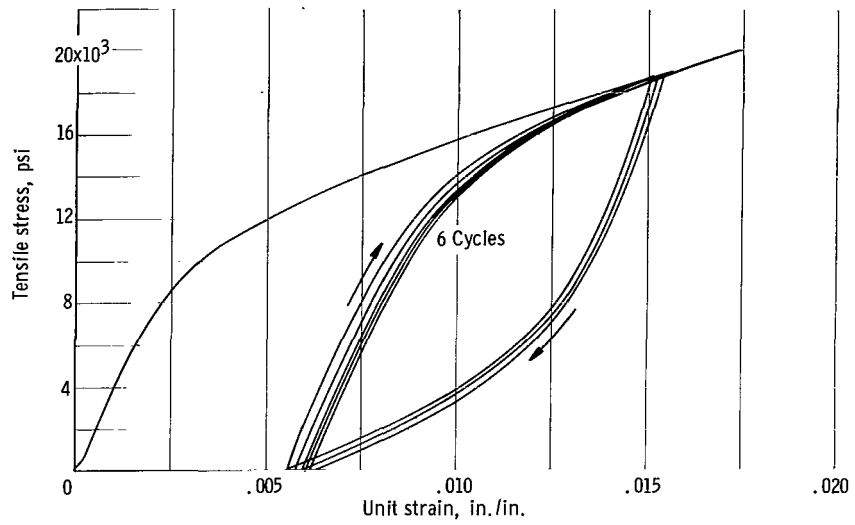

Figure 9. - Stress-strain curve for prestressed (10 040 psi at room temperature) AMA laminate at -300° F.

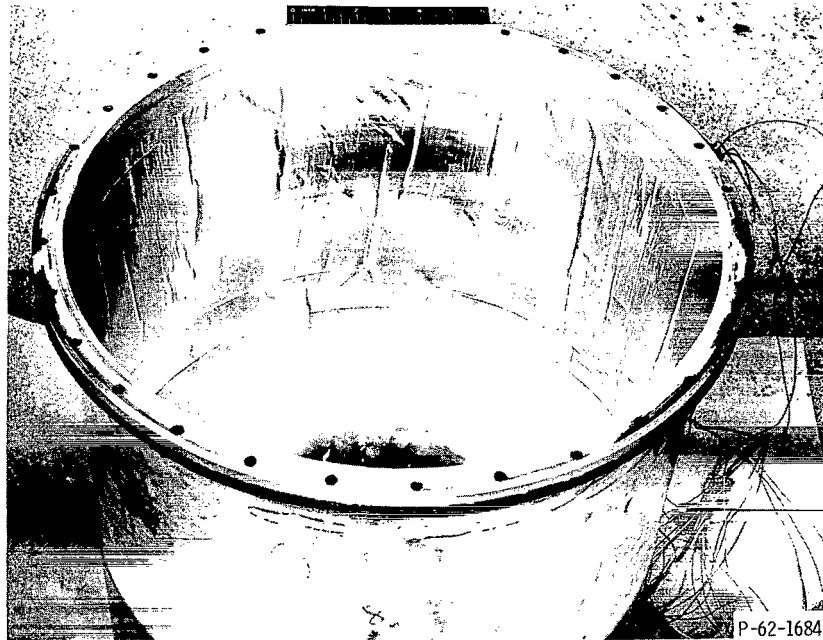

Figure 10. - Uninsulated filament-wound tank with test liner wrinkles after two temperature and pressure cycles.

Prior to fabrication of the test tank, uninsulated but lined filament-wound tanks, similar in geometry to the test tank, were pressure cycled with liquid hydrogen in a vacuum chamber to check the reliability of the adhesive joints with respect to maintaining a seal. The liner shown in figure 10 has gone through two temperature and pressure cycles. After some initial failures a reliable leak-tight adhesive bond was achieved. However, it was decided that some method of reducing the size of the wrinkles in the liner must be found or the resulting sharp creases formed upon repressurization would cause leaks or even breaks. If the liner material is stressed beyond its elastic limit, subsequent loadings to a lower stress produce no further permanent set. This can be seen in figure 8 where the AMA laminate was first stressed to 8300 pounds per square inch and then cycled from 0 to 6250 pounds per square inch six times. It was decided to fabricate the liner and vacuum jackets from 25-pound-per-inch-load (10 040 psi) prestretched AMA laminate to keep the permanent set and, therefore, the wrinkles to a minimum. Figure 9 shows a cycling test of this prestretched material at a temperature of -300° F and a strain of 0.015 inch per inch. It should be noted that most of the strain is within the elastic range. Even with this prestressed material some permanent set was expected when it was used in the test tank. But, it was felt that the bond between the foam insulation and the inner vacuum jacket would stabilize the wrinkles that would occur thus preventing the formation of sharp creases.

WEIGHT SUMMARY

The completed tank, shown in figure 2, weighs 17.20 pounds. A weight breakdown is as follows:

Cryogenic liner	0.63 lb
Insulation Assembly	
Top dome	1.26
Cylinder section	3.64
Bottom dome	<u>1.17</u>
Subtotal	6.70
Filament-wound structure	<u>5.37</u>
Subtotal less hardware	12.07 lb
Hardware	
Neck fitting	4.95
Vacuum tap	<u>.18</u>
Total weight	<u>17.20 lb</u>

EXPERIMENTAL EVALUATION OF TANK

The experimental evaluation was divided into three areas: (1) preliminary testing, (2) thermal performance of insulation, and (3) structural performance of tank. The preliminary tests were checks for the purpose of determining if the tank was operational prior to filling with liquid hydrogen. Thermal performance was evaluated by a liquid-hydrogen boiloff test. The structural

performance was evaluated by a cyclic pressurization of the tank while measuring the wall strain.

Apparatus and Procedure

Preliminary testing. - Before filling the tank with liquid hydrogen it was leak checked with a helium mass-spectrometer leak detector. The leak detector was connected to the vacuum tap on the lower dome of the tank and the insulation was evacuated. Helium was then sprayed on both the inside and outside surfaces of the tank. This method is capable of detecting leaks as small as 10^{-9} standard cubic centimeters per second.

The tank was next cold shocked by filling with liquid nitrogen and the leak check was repeated.

The insulation was evacuated and vented several times and its pumpdown characteristics noted.

Thermal performance of insulation. - In order to evaluate the thermal performance of the insulation, the test tank was filled with liquid hydrogen and the flow rate of the boiloff gas was measured after thermal equilibrium was established. Boiloff tests were run both indoors, in a controlled-environment facility and outdoors. The controlled-environment test facility consisted of a large stainless-steel tank with a dry-nitrogen purged atmosphere and a heat source of steam coils (see fig. 11). The test tank was installed on the lid of the facility where the fill, vent, insulation vacuum, and instrumentation line connections were made. The tank was then filled with liquid hydrogen and the dry-nitrogen purge started. The steam flow was regulated manually to maintain constant purge-gas temperature (65° and 85° F). The vent gas from the test tank flowed first through a heat exchanger, where it was brought up to ambient temperature, and then to a bellows-type gas meter where the total volume was measured. Gas-meter measurements were taken as soon as thermal equilibrium was established and continued until the tank was empty. The flow rate of the boiloff gas was found by measuring the time it took for 25 cubic feet of gas to pass through the gas meter. Variation in tank pressure was small enough to make the use of a pressure regulator unnecessary.

An insulation vacuum line ran from the bottom of the test tank through the lid to a vacuum gage and pump. The insulation was valved off and not pumped on when the tank was being tested. Thermal performance tests were run with insulation vacuums ranging from 5 to 250×10^{-3} torr. Copper-constantan thermocouples with a liquid-nitrogen reference temperature were used to measure the outside surface temperatures of the tank wall.

It was felt that an outdoor boiloff test would provide an overall check of the insulation system under more realistic conditions. For the outdoor test, the lid of the test facility was removed with the test tank and its plumbing still attached except for the steam coils, and placed on a portable stand.

Structural performance of tank. - The tank was pressure cycled while on the portable stand outdoors. The apparatus and instrumentation used here was the

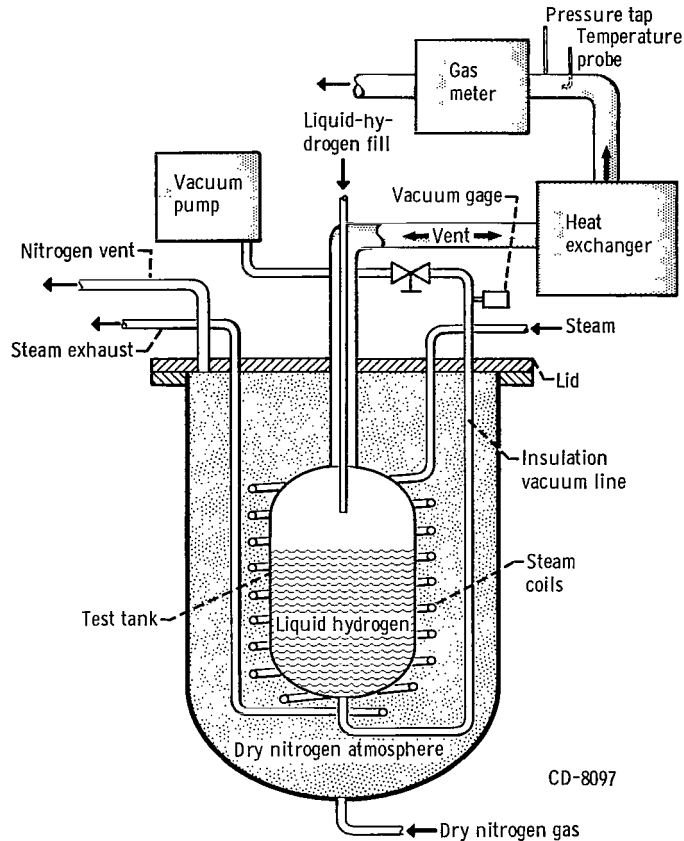

Figure 11. - Controlled-environment test facility.

same as used in the outdoor boiloff test previously described except no attempt was made to measure the boiloff gas flow. In addition, the circumferential strain of the tank wall was measured with the strain gage shown in figure 12. This device consisted of a two to one ratio scissors linkage with a potentiometer attached to one end and a stainless-steel band on the other end. The band was wrapped around the test tank and thus operated the scissors in proportion to tank strain. The estimated accuracy of this gage was ± 0.0001 inch per inch unit strain.

Thermal-Performance Data Reduction

The thermal conductivity of the insulation system was determined by the measurements of boiloff gas flow rate, total volume of flow, and the outside wall temperatures, during the complete boiloff of the liquid. The total heat-transfer rate to the liquid hydrogen was found from the boiloff gas flow rate. Next, the area wetted by the liquid was found from the total volume of boiloff gas. The total-heat-transfer rate was then plotted against the wetted area to obtain the heat flux through the insulation. Finally, the thermal conductivity was obtained from the heat flux and temperature difference across the insulation.

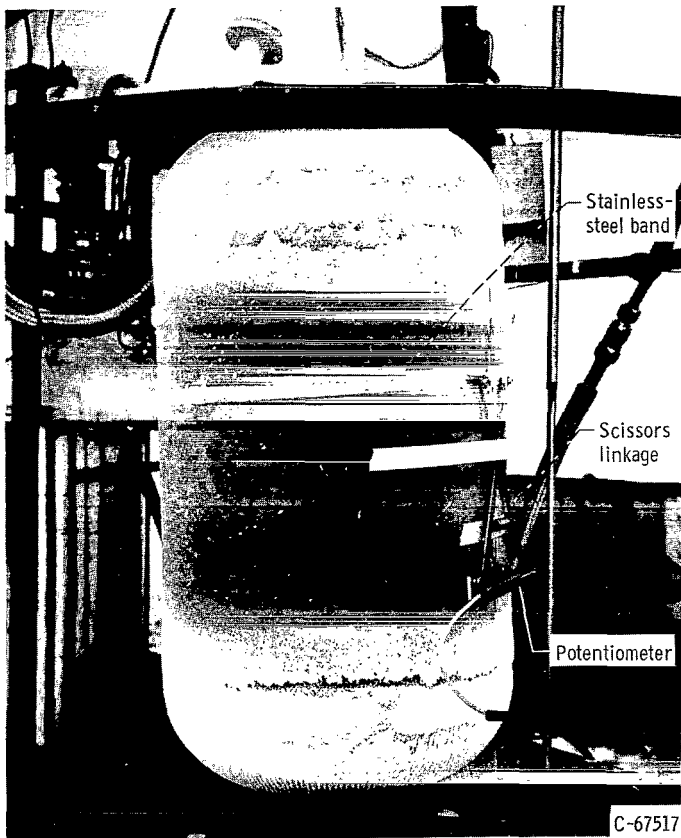

Figure 12. - Strain-gage equipped tank in outdoor test facility.

The total heat-transfer rate to the liquid was found from

$$Q = \dot{m}h_{fg} = \dot{V}\rho_G h_{fg} \quad (1)$$

The mass flow rate \dot{m} of the boil-off gas was determined from the gas meter-volume flow rate \dot{V} and gas density ρ_G at the meter. The heat of vaporization of liquid hydrogen h_{fg} is 194 Btu per pound mass. An assumption made here is that there is no storage or release of energy within the liquid (constant liquid temperature). This is valid if the absolute pressure in the tank is held constant. At the heat fluxes encountered with this tank, pressure regulation is not as critical as in a very low heat leak tank.

Next, the volume of liquid in the tank at any time t during the boiloff is

$$V_L = (G_F - G) \frac{\rho_G}{\rho_L} \quad (2)$$

where G_F is the final gas meter reading (when the tank has boiled dry), G is the reading at time t and ρ_L is the density of the liquid hydrogen. The relation between wetted area A_W and V_L is fixed by the geometry of the tank. Thus A_W is found from V_L .

The total heat-transfer rate to the liquid is the sum of the heat transferred by the different paths. Thus

$$Q = Q_W + Q_S + Q_I \quad (3)$$

where Q_W is the heat-transfer rate to the liquid through the insulation, Q_S is the heat-transfer rate through any thermal shorts below the liquid level and Q_I is the heat transfer rate through the liquid-vapor interface (see fig. 13). For one-dimensional, steady-state heat transfer through the insulation, the Fourier conduction equation can be used.

$$Q_W = KA_W \frac{\Delta T}{\Delta X} \quad (4)$$

where K is the thermal conductivity of the insulation, ΔT is the temperature difference across the insulation and ΔX is the insulation thickness.

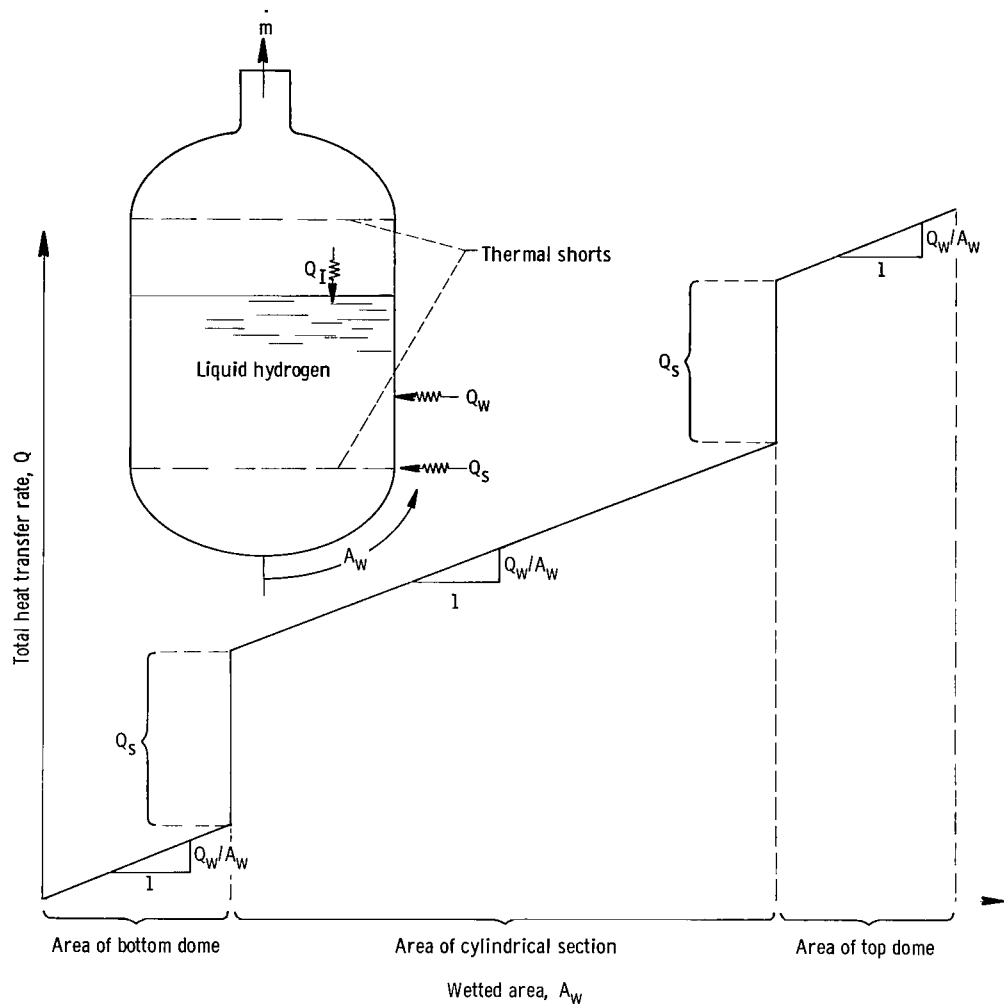

Figure 13. - Idealized curve of heat-transfer rate and wetted area for a liquid-hydrogen tank.

Substitution of equation (4) into equation (3) yields

$$Q = KA_W \frac{\Delta T}{\Delta X} + Q_S + Q_I \quad (5)$$

where K , ΔT , ΔX , Q_S , and Q_I are constant and independent of A_W . Differentiation of equation (5) with respect to A_W gives

$$\frac{dQ}{dA_W} = K \frac{\Delta T}{\Delta X} \quad (6)$$

The heat flux through the insulation Q_W/A_W , is equal to the slope of the Q against A_W plot since from equations (4) and (6)

$$K \frac{\Delta T}{\Delta X} = \frac{Q_W}{A_W} = \frac{dQ}{dA_W}$$

Thus the Q against A_W plot is made and the slope is measured to obtain the heat flux through the insulation. The value for K is then found from this heat flux, the temperature difference, and the insulation thickness. The inside boundary of the insulation was assumed to be at the normal boiling point of liquid hydrogen (-423°F). It was decided to measure the outside tank-wall temperature rather than the outer-insulation boundary due to the simplicity of measuring the former. The error thus introduced is negligible because the thermal resistance of the fiber-glass wall is two orders of magnitude lower than that of the insulation.

Figure 13 shows an idealized curve of Q against A_W . It is possible to use the slope of either of the dome sections or the cylindrical section to obtain the heat flux. The wetted area of the bottom dome is not shown on the data plots because of the more complicated geometry of the dome sections, the heavier liner in this section (excessive deviation from one-dimensional heat transfer), and the nearness of a heat short. The axis of the data plots was shifted to the right so that the wetted area of the bottom dome was eliminated. Since the heat-transfer rate through the bottom dome is assumed to be constant, the dome area can be eliminated without effecting the result, the slope of the Q against A_W plot. Thus, the heat flux is determined only for the cylindrical section which is by far the largest section of the tank.

The aforementioned assumption of thermal equilibrium where ΔT and Q_S were considered constants is valid when enough time is allowed to establish this equilibrium.

When a tank is tested outdoors, there is frost formation and ΔT and Q_S may not be constant due to the buildup with time of an insulating layer of frost. It can be shown that Q_T is small compared to the other heat-transfer rates and, thus, assuming it constant will not cause any significant error. Deviation from one-dimensional heat transfer was estimated to be small for the cylindrical section of the tank, where the slope of the Q against A_W plot was measured.

RESULTS AND DISCUSSION

Preliminary Testing

The leak checks made with the mass-spectrometer leak detector both before and after the liquid-nitrogen cold shock revealed no leaks (within the maximum sensitivity of the detector).

Initially it took two weeks to pump the insulation down to a pressure of 5×10^{-3} torr. Whenever the insulation vacuum was broken, it took only a few days to pump it back down. It is thought that the closed cells of the foam slowly release trapped gases by diffusion and thus require a long pumpdown time. When the vacuum is broken, air diffuses back into the cells. Thus, the insulation should be kept evacuated and venting to the atmosphere should be avoided. The pressure rise within the insulation due to outgassing was usually about 10^{-1} torr per minute which seems high but it should be noted that the gas volume in which this occurs is in the order of 4 cubic inches (the free volume

within the insulation system, vacuum line, and gage). When the tank is filled with liquid hydrogen and the insulation vacuum is below 2×10^{-1} torr, a slow cryopumping occurs with the result that the pressure is reduced to about one-half of the initial pressure in 2 hours.

Thermal Performance

The results of three boiloff tests are shown in figures 14, 15, and 16 where the heat-transfer rate is plotted against the wetted area of the cylindrical section of the tank. The two runs in the controlled-environment facility (figs. 14 and 15) resulted in an average thermal conductivity of $0.096 \text{ (Btu)(in.)}/(\text{hr})(\text{sq ft})(^\circ\text{F})$.

As shown in figures 14, 15, and 16, there is a large heat short at the intersection of the bottom dome and the cylindrical section of the insulation. This heat short is caused by the heavy AMA laminate used on the edge of each insulation section (see fig. 1(d), p. 5). The heat short was calculated to be 1050 Btu per hour, while the value, determined by extrapolating the curve (see figs. 14 to 16) and assuming the heat flux through the bottom dome the same as in the cylindrical section, varied from 1000 to 1340 Btu per hour, depending on ambient conditions. At 75 percent of tank capacity more than 50 percent of the heat transfer was due to this heat short. Calculations show that if Mylar were used instead of the AMA laminate to seal the edges of the insulation sections, the heat short to the liquid would be reduced to approximately 1 Btu per hour.

The outdoor run (fig. 16) yielded a thermal conductivity K of $0.117 \text{ (Btu)(in.)}/(\text{hr})(\text{sq ft})(^\circ\text{F})$ which is about 15 percent higher than the runs in the controlled environment. It is felt that this value is not as accurate as those obtained from the runs in the controlled environment for the following reasons:

(1) The increase in frost thickness with time causes the temperature difference across the insulation to drop during the test. This deviation from thermal equilibrium has the effect of increasing the slope of the Q against A_w plot. Thus, when the heat flux is determined by the previously described method, it will be higher than the actual heat flux.

(2) The occasional breakaway of an area of frost and changes in wind velocity cause a scatter in boiloff data which makes the determination of thermal conductivity more unreliable. Figure 12 shows the frost formation on the tank during a test. Note the areas of frost that have fallen off and that frost only occurs in the vicinity of the heat shorts; that is, the intersections of the the domes with the cylinder.

Structural Performance

The tank was filled with liquid hydrogen for a total of 11 hours during the boiloff tests without developing any leaks in the liner. During this phase of testing the tank pressure never exceeded 5 pounds per square inch gage.

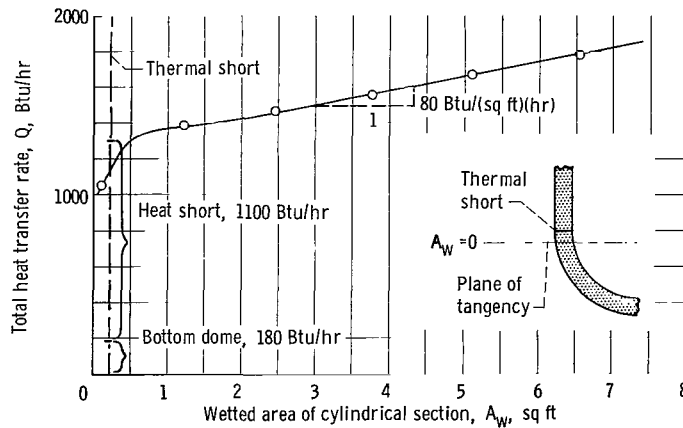

Figure 14. - Variation of total heat-transfer rate with wetted area for liquid-hydrogen test tank in an atmosphere of dry nitrogen at 65° F. Thermal conductivity of insulation, 0.094 (Btu)(in.)/(hr)(sq ft)(°F).

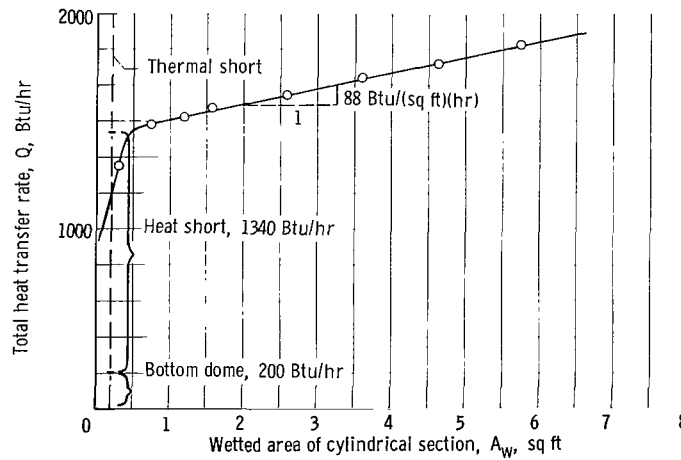

Figure 15. - Variation of total heat-transfer rate with wetted area for liquid-hydrogen test tank in an atmosphere of dry nitrogen at 85° F. Thermal conductivity of insulation, 0.097 (Btu)(in.)/(hr)(sq ft)(°F).

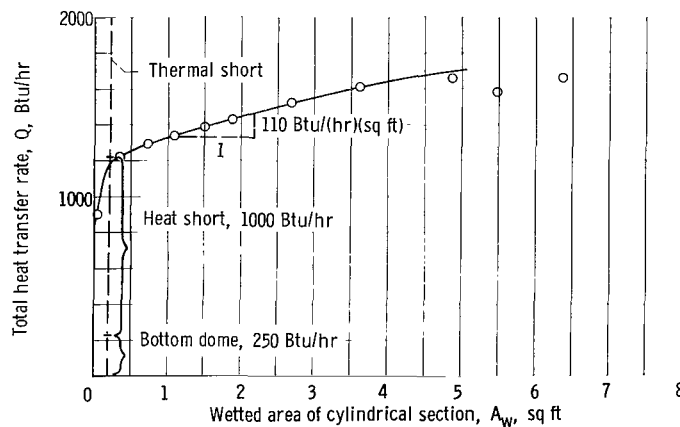

Figure 16. - Variation of total heat-transfer rate with wetted area for liquid-hydrogen tank in outdoor test. Temperature, 60° F, wind speed 17 mph, dew point, 45° F; thermal conductivity of insulation 0.117 (Btu)(in.)/(hr)(sq ft)(°F).



C-68340

Figure 17. - Inside of tank (showing failure in liner).



Figure 18. - Section of liner material at break.

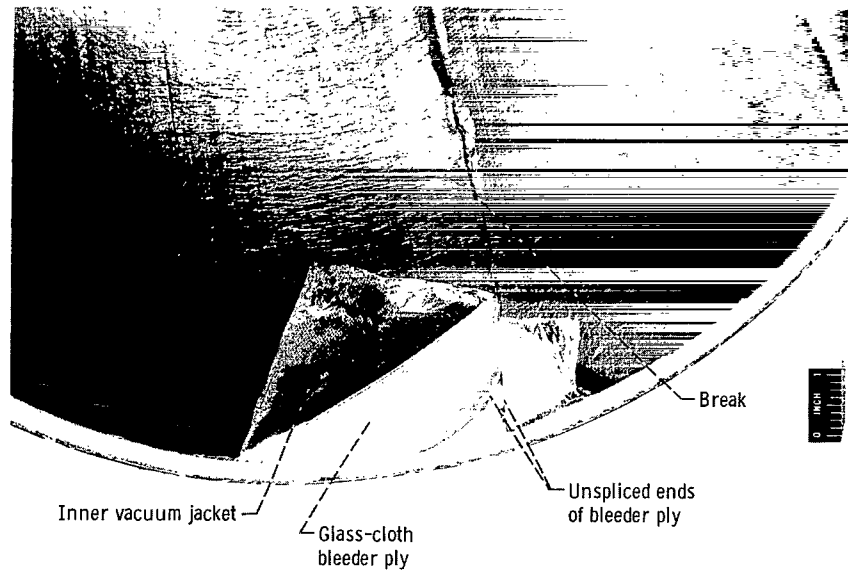

C-69086

Figure 19. - Failure in inner vacuum jacket (liner removed from tank).

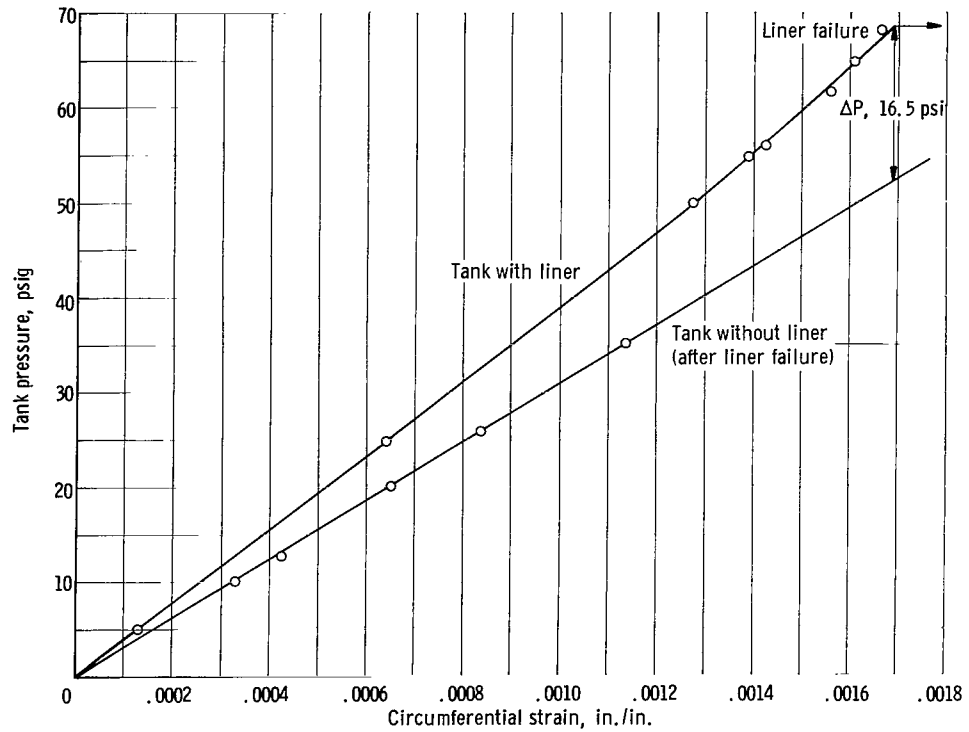

Figure 20. - Effect of liner failure on circumferential strain of tank wall.

The pressurization tests consisted of 1 cycle to 35 pounds per square inch gage, 2 cycles to 50 pounds per square inch gage, and a final increase to 68 pounds per square inch gage where liner failure occurred. During the first two cycles, no leaks developed but on the third a very small leak was observed. The leak rate was in the order of 10^{-6} cubic centimeters per second at a tank pressure of 50 pounds per square inch gage. As soon as the valve between the insulation and the pump was opened, the pressure in the insulation would drop to less than 5 microns, indicating that this leak presented no pumping problem. The size of this leak did not change even up to the point of liner failure.

Liner failure occurred suddenly with a longitudinal break in the cylindrical section of the tank (see fig. 17). Figure 18 shows the brittle fracture of the Mylar in the liner. Both the liner and the inner vacuum jacket failed at the same place. It should be noted that, even though the liner was highly stressed, all adhesive joints remained leak-tight. Upon examination of the inner vacuum jacket it was discovered that the break occurred along the butt joint of the glass-cloth bleeder ply (see fig. 19). Since the glass-cloth reinforced the vacuum jacket everywhere but at the butt joint where the cloth ends were not spliced, this was the area of highest stress. Instead of the inner vacuum jacket uniformly straining along the entire circumference, most of the expansion occurred over the very small length of this maximum stress area. Thus, the local unit strain was many times higher than it would have been for a uniformly strained material. It is probably the vacuum-jacket failure that initiated the failure in the liner at the same location. It is possible that this failure could have been prevented if the ends of the glass cloth were spliced at the butt joint with a bonded glass-cloth tape.

The circumferential strain of the fiber-glass shell was measured during pressure tests of this tank both before and after liner failure. Figure 20 shows a plot of this strain against internal tank pressure. When failure occurred at 68.4 pounds per square inch gage, the release of the load carried by the liner and vacuum jacket resulted in increased load on a corresponding strain in the fiber-glass shell. Since the strain at failure, 0.0017 inch per inch, results from a load of only 51.9 pounds per square inch gage after failure, the difference between 68.4 and 51.9 pounds per square inch gage was assumed to be the load the liner and vacuum jacket were taking. Thus, the liner and jacket were taking an internal pressure load of 16.5 pounds per square inch and correspondingly stressed to 29 000 pounds per square inch at failure. This is an increase in tensile strength from the 25 000 pounds per square inch at -300° F listed in table I. The 51.9 pounds per square inch gage carried by the fiber-glass shell results in a composite wall stress of 12 000 pounds per square inch, well below its ultimate of 120 000 pounds per square inch.

Final examination of the tank revealed the existence of wrinkles indicating the liner and inner vacuum jacket material has been stressed beyond its elastic limit and thus has taken a permanent set in spite of prestressing the AMA laminate. It was found that the wrinkles in the vacuum jacket (see fig. 21) are not sharply creased as in the preliminary liner tests but rather they are rounded and not likely to be leak sources. It appears that the glass cloth and foam help stabilize the wrinkles and prevent the formation of sharp creases.

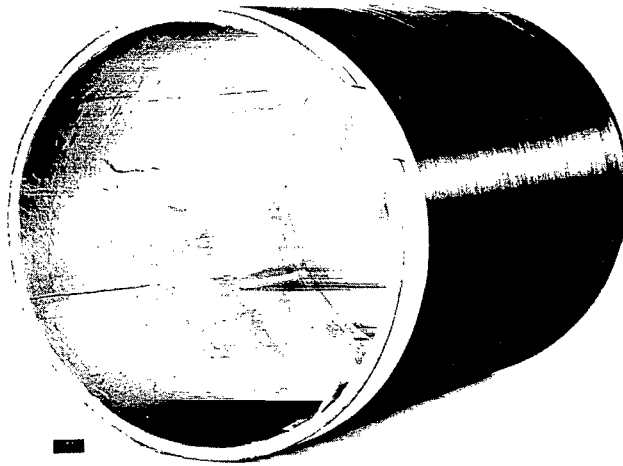

C-69087

Figure 21. - Inner vacuum jacket after testing.

CONCLUDING REMARKS

A leak tight, internally insulated, fiber-glass tank for liquid hydrogen was built under the present state of the art. The results of the structural tests indicate that adhesive-bonded joints are capable of maintaining vacuum-tight seals under cryogenic conditions. This indicates that in the future more advantage can be taken of adhesives in the field of cryogenics.

In general, the results of the tests run on the subscale tank were encouraging. The insulation system performed well with the exception of thermal shorts at the intersections of the domes and the cylindrical section. These heat shorts are not inherent in this type of system and can easily be eliminated. There are no heat shorts due to structural supports penetrating the insulation as in external insulation systems.

The heat flux through the 1/2-inch thick insulation was about 90 Btu/(hr)(sq ft). The corresponding thermal conductivity is 0.096 (Btu)(in.)/(hr)(sq ft)(°F).

The concept of internal insulation seems to be promising. An inherent limitation is that the insulation must be able to withstand a compressive stress equal to the internal pressure of the tank. For insulations of the type used on boost vehicles this does not appear to be a serious limitation.

Although the liner failed at approximately 70 pounds per square inch gage, 30 percent below the design pressure of 100 pounds per square inch, this is a significant first step in the development of a successful liner. With simple changes in construction, for instance, correcting the local straining of the jacket at the bleeder ply joint, the working pressure of this tank could be substantially increased. Although the prestressing of the liner material reduced the amount of permanent set and resulting wrinkles, some did occur.

With a total composite stress of only 12 000 pounds per square inch in the cylindrical wall, this tank is only about one tenth of the full potential of fiber glass. The liner must be capable of expanding more if fiber glass is going to be used to full advantage. The solution of the problem of getting the liner to strain as much as the fiber glass by allowing it to yield and thus wrinkle seems to be the best approach. The wrinkles must be stabilized to prevent sharp creases and improve cycling life. A promising method of stabilizing these wrinkles is to bond a cloth to one or both sides of the liner. The cloth should have a very elastic type of weave and probably an organic fiber. It seems likely that the wrinkles can be put in while the tank is at room temperature by pressurizing to near the burst point. Future effort in this area is required.

Lewis Research Center,
National Aeronautics and Space Administration,
Cleveland, Ohio, May 27, 1965.

APPENDIX - SYMBOLS

A	area, cu ft
E	modulus of elasticity, lb/sq in.
G	gas meter reading, cu ft
h_{fg}	heat of vaporization of liquid-hydrogen, Btu/lb m
K	thermal conductivity of insulation, (Btu)(in.)/(hr)(sq ft)($^{\circ}$ F)
\dot{m}	mass flow rate, lb m/sec
P	internal pressure, lb/sq in.
Q	total heat transfer rate to liquid, Btu/hr
R	radius, in.
s	hoop stress, lb/sq in.
ΔT	temperature difference, $^{\circ}$ F
t	hoop material thickness, in.
V	volume, cu ft
\dot{V}	volume flow rate, cu ft/sec
ΔX	insulation thickness, in.
ϵ	unit strain, in./in.
ρ	density, lb m/cu ft

Subscripts:

f	final
G	boiloff gas
I	liquid vapor interface
L	liquid
ℓ	liner
S	thermal liner
W	wetted surface

REFERENCES

1. Morris, Edgar E.: Glass Cases for the Biggest Solids. *Astronautics and Aeronautics*, vol. 2, no. 7, July 1964, pp. 28-38.
2. Hickel, Robert O.; Johnson, Donald F.; and Kemp, Richard H.: A Summary of the Behavior of Materials at Cryogenic Temperatures. *Metals Eng. Quarterly*, vol. 3, no. 2, May 1963, pp. 18-28.
3. Hanson, Morgan P.; Richards, Hadley T.; and Hickel, Robert O.: Preliminary Investigation of Filament-Wound Glass-Reinforced Plastics and Liners for Cryogenic Pressure Vessels. NASA TN D-2741, 1965.
4. Shriver, C. B.: Design and Fabrication of an Internally Insulated Filament Wound Liquid Hydrogen Propellant Tank. NASA CR-127, 1964.
5. Hacker, Paul T.; DeVos, Francis J.; and Stutesman, Harley: Evaluation of Adhesives for Sealing Metallic and Plastic Films for Use at Liquid-Hydrogen Temperatures. NASA TM X-1057, 1965.