

FINAL REPORT
PROPERTIES OF NON-STOICHIOMETRIC
METALLIC CARBIDES

GPO PRICE \$ _____

CSFTI PRICE(S) \$ _____

Hard copy (HC) _____

Microfiche (MF) _____

ff 653 July 65

N 65-35844

FACILITY FORM 802

(ACCESSION NUMBER)	(THRU)
41	1
(PAGES)	(CODE)
SC 67380	17
(NASA CR OR TMX OR AD NUMBER)	(CATEGORY)

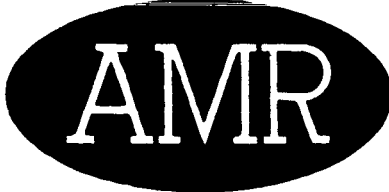

ADVANCED METALS RESEARCH CORPORATION

625 MC GRATH HIGHWAY
SOMERVILLE 45, MASS.

CONTRACT NO. NASw-663

FINAL REPORT

PROPERTIES OF NON-STOICHIOMETRIC METALLIC CARBIDES

J. T. Norton
R. K. Lewis

ADVANCED METALS RESEARCH CORPORATION
Somerville 45, Mass.

April 6, 1964

FOR

Headquarters

National Aeronautics and Space Administration
Washington 25, D. C.

ABSTRACT

3584A

A study of the carbides of the group IV transition metals (Ti, Zr, Hf) has been made with primary emphasis on the Ti-C system. Specimens of high purity were prepared by powder metallurgy techniques over the non-stoichiometric range $\text{TiC}_{0.50}$ to $\text{TiC}_{0.95}$. Specimens of sufficiently low oxygen content and low free carbon were obtained only in the range $\text{TiC}_{0.75}$ to $\text{TiC}_{0.92}$.

The following properties which could be measured on powders or non-dense specimens were determined as a function of carbon content, lattice parameter, specific gravity, thermal expansion, and thermoelectric power.

The electronic structure of the non-stoichiometric carbides is discussed on the basis of the observed properties.

Author

TABLE OF CONTENTS

I	Introduction	1
II	Structural Model for Non-Stoichiometric Carbides.....	4
III	Variation of Lattice Parameter with Carbon Content.....	7
IV	Density Measurements on Ti-C Alloys.....	11
V	Thermal Expansion Measurements on Ti-C Alloys.....	12
VI	Thermoelectric Power of Ti-C Alloys.....	14
VII	Conclusions.....	17
	References.....	22

TABLES

Table I	Comparison of Analyses for TiH ₂ Starting Material and Typical Sintered Analysis in ppm.....	23
Table II	HfC Specimens for Lattice Parameter Measurement.....	24
Table III	TiC Specimens for Density Measurements.....	25
Table IV	Average Value of Thermal Expansion Coefficient per °Cx10 ⁶	26
Table V	Absolute Thermoelectric Power Microvolts per Degree Centigrade.....	27

FIGURES

Figure 1	Lattice Parameter vs Carbon Composition TiC Alloys..	28
Figure 2	Lattice Parameter vs Carbon Composition for Zr-C System.....	29
Figure 3	Lattice Parameter vs Carbon Composition for Hf-C System.....	30
Figure 4	TiC Density vs Carbon Composition.....	31
Figure 5	Thermal Expansion of TiC.....	32
Figure 6	Diagram of Circuit Used for Determining Thermoelectric Power.....	33
Figure 7	Absolute Thermoelectric Power of TiC Alloys Temperature.....	34
Figure 8	Absolute Thermoelectric Power vs Carbon Content.....	35
Figure 9	Density of States vs Energy.....	36

Contract No. NASw-663

Final Report

Properties of Non-Stoichiometric Metallic Carbides

I. Introduction

The carbides of the transition metals of the IVth, Vth and VIth group of the periodic table, combining as they do the properties of high melting temperature, high strength and hardness, together with good electrical and thermal conductivities, have long been of interest as materials for high temperature service. They have found many useful applications when formed into structural parts by combining the powder with an auxiliary metal such as cobalt or nickel as a binder. The full potential of these refractory substances, however, cannot be realized until they can be fabricated into dense bodies of the desired shape without the use of the auxiliary binder. In spite of a great deal of effort, this has not yet successfully been accomplished.

Many of these carbides show a stability over a range of carbon contents and this is particularly true of the carbides of the IVth group, namely Ti, Zr and Hf. For the intelligent application of these substances it is essential that the variation of properties with carbon content be known and that a thorough understanding of the basic structure which underlies these properties be established. The work under the present contract has been directed toward the proposal of a structural model applicable to the non-stoichiometric carbides and the testing of the model by the experimental observation of a

number of the physical properties. The study has been restricted to the carbides of the IVth group metals and most of it with primary emphasis on the Ti-C system.

The measured properties have been limited to those which could be determined on powders or on non-dense solid specimens, this limitation being dictated by the powder metallurgy technique of specimen preparation. The properties measured as a function of carbon content were: lattice parameter, density, thermal expansion and thermoelectric power. Some very limited data on electrical resistivity was obtained.

The preparation of suitable specimens is an essential criterion of any program involving measurement of properties and has presented an especially difficult problem in the current work. The methods of specimen preparation and the limitations imposed by the powder metallurgy method have been discussed in the Final Report, Contract No. NASr-98 dated March 29, 1963.¹ This will be referred to herein as Report 3/29/63. To summarize these conclusions, it is a particular problem to prepare specimens of low enough oxygen content so that the results are characteristic of a true binary system of metal and carbon. A reasonable limitation seems to be that specimens having less than 10 ppm oxygen can be considered suitable while a value greater than 100 ppm would definitely be considered an impure sample.

Substitutional impurities in the carbides are not difficult to control if high purity starting materials are used. The high temperature high vacuum treatment has, in fact, a distinct purifying effect. Table I compares the spectroscopic analysis of the TiH_2 starting material and two typical specimens after reaction and final sintering. In this respect the resulting specimens can be considered of "high purity".

In the preparation of specimens by reaction of mixed powders, oxygen inevitably is included in the charge and during reaction finds its way into solution in the carbide. It has been demonstrated that heating to a high enough temperature in a good vacuum will reduce the oxygen content to acceptable levels. Opposed to this is the fact that at high temperatures the carbides, particularly at the lower carbon contents, lose metal by evaporation so rapidly that homogeneous specimens are impossible to obtain.

In considering oxygen impurities, it is also necessary to consider nitrogen since both are present in the air and both can occupy the carbon lattice sites in the carbides. While no quantitative analyses for nitrogen were made, the results of the vacuum fusion analyses give indications of the overall gas content and an examination of these results suggest that the nitrogen does not exceed 20 percent of the oxygen content. Strictly speaking in the following discussion one should refer to oxygen and/or nitrogen but it is felt that if the oxygen is down to an acceptable level, the nitrogen content would be negligible.

Because of these conditions the study of the Ti-C system was limited to the range of $\text{TiC}_{0.75}$ to $\text{TiC}_{0.95}$ the latter being the upper limit of the TiC phase. In the case of the Zr-C and the Hf-C systems, a temperature of 2200°C was the limit of the available facility and this was insufficient to yield truly low oxygen specimens.

II. Structural Model for Non-Stoichiometric Carbides

The crystal structure of the IVth group carbides is of the B1 type, that is, the metal atoms are arranged in cubic close packing with the carbon atoms in the octahedral interstitial sites. At the stoichiometric composition, all of the carbon sites are occupied but as the carbon content decreases, more and more of the sites are vacated, the vacancies being distributed at random.

From the observed good electrical conductivity and high hardness it may be concluded that the bonding is partly metallic and partly covalent. The electrons responsible for the bonding occupy a band of states derived from the outer s and d states of the metal atom and the 2s and 2p states of the carbon atom. This band should be somewhat similar to the overlapping sd band of a IVth group transition metal. On the basis of such a model one would predict that this band of states has a capacity of 80 electrons per unit cell (cubic cell containing 4 metal atoms) but somewhat less than half of the states are occupied by electrons since at the stoichiometric composition only 32 electrons per cell are available. The energy of the upper most occupied level, measured from the bottom of the band is the Fermi energy. As the carbon content of the substance increases from $MC_{0.75}$ to $MC_{1.0}$, the electron concentration increases from 28 to 32 electrons per unit cell and one would expect the Fermi energy to increase, the amount depending upon the density of states in the band at this level.

Electrons occupying states of essentially s character near the Fermi level in the band contribute to the electrical conductivity. Reported values of the Hall constant^{2,3,4} suggest

that these are few in number, certainly less than 1 per unit cell. The remaining electrons of essentially p and d character contribute to the bonding in a manner similar to electron pair covalent bonds. Thus one would expect the bond strength to increase as the carbon content increases.

This simple model assumes that the density of states curve as a function of energy does not undergo drastic changes in the energy range considered and that there are no complications due to the proximity of the Fermi surface to the boundary of a Brillouin zone involving a significant energy discontinuity. Such questions cannot be answered specifically on the basis of present knowledge but the simple model can be tested by comparing its predictions with observed properties which vary with the carbon content. What then does the model predict?

With reference to the lattice constant, there are two factors at work. If one accepts the usual values of the atomic radii, then if the metal atoms are close packed, the octahedral hole is smaller than the carbon atom which is to occupy it and the lattice constant should increase progressively as carbon is added. The increase probably would not be linear but the curve could not show a maximum and then decrease. On the other hand the electron concentration increases with carbon content and this results in an increase in bond strength which would operate in a direction to decrease the lattice parameter. The combination of these two effects should result in values of the parameters which are less than the hard sphere model predicts and the curve might well show a broad maximum. Another possible influence on the variation of lattice parameter is suggested by the analysis

of Rostoker⁵ on the behavior of the Ti-O system which is somewhat similar. He points out the possibility that the stability of the structure may be determined by a maximum number of electrons per unit cell and that the maintenance of this maximum as the oxygen content increases beyond the stoichiometric composition requires the creation of vacant sites in the metal lattice with consequent decrease in the lattice parameter. This seems unlikely in the carbide systems, first because the phases are not stable beyond the stoichiometric limit and, in fact never quite reach it, and secondly because, if a metal atom and a carbon atom each contribute 4 electrons, a vacancy in either lattice would have the same effect on the electron concentration. However, this concept is easily tested by measuring the density (specific gravity) of the carbide as a function of carbon content and comparing with the x-ray density calculated on the basis of 4 metal atoms per unit cell.

Changes in the binding energy of the crystal are reflected in the magnitude of the thermal expansion. On the basis of the simple band model, the electron concentration and the binding energy increase with increasing carbon content. It would be expected therefore that the thermal expansion coefficient would show a regular decrease as the carbon sites are progressively filled.

The thermoelectric power or Seebeck coefficient of a substance is quite sensitive to changes in electronic structure and in the case of the Ti-C phase should show changes if the electron concentration and Fermi energy change with carbon content. A detailed prediction of the thermoelectric power requires a much more specific picture of the energy band structure than is

currently available. On the basis of a simplified band picture, where electrons in states near the Fermi surface can be considered as nearly "free", the value is given by the expression:

$$Q = \text{Const.} \frac{T}{eE_F}$$

where T is the absolute temperature, e the electronic charge and E_F is the Fermi energy. One would expect, therefore that the absolute thermoelectric power should be negative, should have a magnitude which increases linearly with the absolute temperature and should decrease in magnitude as the carbon content increases.

Considerations of the experimental results will show how well these predictions are fulfilled.

III. Variation of Lattice Parameter with Carbon Content

The lattice parameter curve for the Ti-C system and the experimental procedures involved were reported in Report 3/29/63 and Fig. 1 is reproduced from that publication. The low carbon portion of the curve is considered unreliable because of the high oxygen content of the specimens but the portion from about $\text{TiC}_{0.75}$ to the upper limit of the phase is believed to be a correct representation of the binary Ti-C system. Evidence gathered since the curve was established, based on a considerable number of specimens is in agreement.

As seen from Fig. 1, the curve rises from composition $\text{TiC}_{0.75}$ to a broad maximum at about $\text{TiC}_{0.85}$ and then falls to its termination at $\text{TiC}_{0.95}$. This apparently anomalous behavior seems to be in complete accord with the interaction of the size effect and the electron concentration effect associated with

changing carbon content. Values of the lattice parameter at all points are lower than those calculated from a hard sphere model using the generally accepted values of atomic radii. Obviously a force is at work tending to contract the lattice and it seems reasonable to believe that the concentration of bonding electrons which is increasing with carbon content is responsible. At this stage it cannot be stated that all of the occupied states in the combined band are bonding orbitals but it does seem clear that as more and more of the carbon sites are filled, the number of bonding orbitals increases.

The fact that the phase terminates with an upper limit of $\text{TiC}_{0.95}$ is definitely established and is significant in showing that carbon atoms prefer to combine as graphite rather than occupy the last few sites in the carbon lattice. This cannot be due to the occupation of these sites by oxygen atoms since something like 1.3 wt percent of oxygen would be required and analysis shows at least 50 times less than this is present in the specimens. Rather it must be concluded that because of the shape of the Fermi surface and its possible approach to a zone boundary at the critical electron concentration, the TiC phase of stoichiometric composition is less stable than the graphite phase with which it is competing. An alternate explanation, on the basis of the free energy curves of the several phases is that even though the minimum in the curve for the TiC phase is at the stoichiometric composition, the free energy of graphite is lower and the common tangent will thus touch the TiC curve slightly to the left or at a slightly lower carbon content than the minimum.

It is of interest to compare the results obtained on ZrC with those of TiC and for this purpose Fig. 2 is reproduced from Report 3/29/63. The results of Benesovsky and Rudy⁶ are also shown on this figure. It is clear that specimens prepared at the lower temperatures give low values of the lattice constant and it can be assumed that these contain excessive amounts of oxygen. The results of Dolloff⁷ on ZrC specimens which were heated to melting, give the highest parameters and probably are close to the true oxygen free values. The curve is very similar to the TiC curve showing a broad maximum and a phase boundary at a carbon content slightly lower than the stoichiometric composition. On the basis of existing evidence, the behavior of the two systems appears to be entirely analogous.

The lattice parameter vs. carbon content of Hf-C system was examined in the same manner as for the Ti-C system. Two methods of preparing the specimens from hydride-carbon mixtures were used. In one case the mixed powders were reacted and heat treated in open graphite crucibles in high vacuum. In the other case, the mixed powders were compressed into compacts and reacted and heat treated in this form also in high vacuum. In both cases the maximum available temperature of 2200°C was used for the final treatment.

The results are shown in Table II and Fig. 3. In all samples reported, the total and free carbon contents were determined, permitting the combined carbon in the carbide phase to be calculated and it is this value which is plotted vs. lattice constant. It is obvious that the two methods of preparation give values falling in two distinct groups. It is

reasonable to assume that the difference is due to oxygen content and that it is more difficult to remove the oxygen from the compacts than from the loosely sintered powders. Only two specimens were analyzed for oxygen, Nos. 4 and 7, and the results show a lower value for the specimen prepared in the open crucible i.e., 400 ppm vs. 710 ppm but even the former is too high to permit much confidence in the results.

Dolloff and coworkers⁸ have examined the Hf-C system and their specimens were prepared by heating to a considerably higher temperature, namely 3150°C. The specimens were compacts which were encapsulated and heated in an argon atmosphere. The maximum values of the lattice constant reported by these investigators are comparable with the values obtained in the present work but a detailed comparison is difficult because the carbon content appears to be total carbon and it is not clear whether it is nominal or the result of an actual analysis. Oxygen contents are not reported. It has become quite clear as the present work has progressed that there are variables in these very high temperature processes that are very difficult to control and that each sample on which lattice constant data is reported should be analyzed for combined carbon and for oxygen.

If one accepts the lattice parameter data of Fig. 3 from the open crucible specimens at its face value the same broad maximum and the same limit of carbon content of the phase at slightly less than the stoichiometric composition is observed as was the case for the Ti-C system. The true curve for the oxygen free Hf-C system might be slightly higher but probably would have the same general shape and be subject to the same interpretation as the Ti-C and Zr-C systems.

IV. Density Measurements on Ti-C Alloys

In order to determine the possible existence of vacant metal atom sites in the carbide phase, measurements of the density of powder specimens of a range of carbon contents were made and compared with values of the x-ray density calculated from the measured lattice constants of the same samples on the basis of 4 metal atoms per unit cell.

The technique of the density measurement was described in detail in Progress Report No. 2 of the current contract dated 9/12/63. In summary the pycnometer method was employed using a low vapor pressure oil as the working fluid. The pycnometer vial containing the specimen was placed in a container with the oil which was heated and evacuated. The oil level was then raised so that the vial was filled and the whole cooled to room temperature. The filled vial was then transferred to a constant temperature bath, the oil level adjusted and the vial capped. After thorough cleaning the final weighing was made.

The density results are reported in Table III and Fig. 4. The solid line is the x-ray density calculated from the lattice parameter-composition curve of Fig. 1. The solid circles are values calculated from the measured lattice parameters of the actual analyzed specimens used in the density determinations. The agreement is a good justification of the original curve. The open circles are the values of the measured density. All of the difficulties inherent in the density measurement of fine powders were encountered and are evident in a degree of scatter in the experimental points. Probably the greatest difficulty is lack of complete dispersion of aggregates of fine powder by the oil.

In spite of the lower precision of the measured density as compared with the calculated values, it is evident that there is no systematic difference between the two sets of values as the carbon content is changed and it must be concluded that vacancies in the metal atom lattice do not play a role in the changing values of the lattice parameter of the carbide phase.

V. Thermal Expansion Measurements on Ti-C Alloys

Thermal expansion measurements were made on specimens of the Ti-C system over the range from room temperature to 1000°C. The specimens for this work were prepared by loading the starting mixtures into high purity graphite tubes and carrying out the reaction and final sintering in place. The resulting specimens were approximately 2 inches long and 1/4 inches in diameter. They were sintered to about 85% of theoretical density. Specimens were selected for measurement which were straight and free from cracks. The ends were ground flat and square.

The dilatometer which was described in Progress Report No. 3 dated 1/13/64 had a body and push rod of quartz and the dilation was measured electrically by a differential transformer. The entire unit was placed within the vacuum enclosure of the high temperature Brew furnace and the metal parts of the transducer were maintained at constant temperature by water cooling. Calibration of the unit showed a reproducibility of length measurement of ± 10 microinches and a deviation from linearity over the expansion range of less than one percent.

The expansion data for four specimens is shown in Fig. 5. Only the experimental points are shown since the curves would overlap in a confusing manner. The average values of the

thermal expansion coefficient for several temperatures ranges are given in Table IV. For the first three specimens where the free carbon is present in negligible amounts, it is observed that the expansion coefficient increases with increasing temperature for each of the carbon contents. It is also observed that at all temperature ranges the expansion coefficient decreases with increasing carbon content.

Specimen D which contains a considerable amount of free graphite and evidently is not completely in equilibrium is out of line on the basis of combined carbon. It is difficult to predict the effect on the expansion of several percent of free graphite in the porous bars such as were used in these measurements. However it is reasonable to believe that such a specimen would be a non-conformist.

The change in the expansion coefficient with carbon content, as shown by these results, while not large, is in the direction predicted by the proposed model. With increasing carbon content, the electron concentration increases and with it the bond strength. Increased bond strength results in a decrease in the thermal coefficient of expansion. There appears to be little information in the literature on thermal expansion of the Ti-C system and none in which it is correlated with carbon content. Gangler⁹ investigated hot pressed specimens of Ti-C and reported a value of $7.42 \times 10^{-6}/^{\circ}\text{C}$ for the range of 0-590°C, a value with which the present results are in good agreement.

As would be expected, the added bond strength resulting from the electrons contributed by the carbon is reflected in the decrease in the thermal expansion of the carbide as compared with that of metallic titanium which is reported¹⁰ as 8.8×10^{-6} at room temperature and 9.7×10^{-6} at 600°C.

VI. Thermoelectric Power of Ti-C Alloys

The thermoelectric power or Seebeck coefficient was measured for a number of specimens of the Ti-C system having a range of carbon contents, the measurement being carried out over a range of temperature from 0 to 900°C. The specimens used for this investigation were prepared in the same way as those used for the thermal expansion as described in Section V. They were approximately 2 inches long and 1/4 inch in diameter. They were porous and of about 85% of theoretical density.

Thermocouples of platinum-platinum 10 percent rhodium were welded to the specimens at points about 3/4 inch apart. The welding was done by heating the specimen with an electron beam to just above the melting point of the platinum, then bringing the tip of the junction against the specimen and immediately cooling the specimen. This proved to be a very delicate operation but once mastered provided strongly bonded junctions. In the high vacuum, the platinum wets the carbide and there is a slight infiltration of the porous body in the immediate vicinity of the joint.

The temperatures were measured by means of two potentiometers connected to the junctions through suitable cold junctions. The thermal E.M.F. was measured with another potentiometer between the two pure platinum leads. The measured thermoelectric

power of the carbide vs. platinum was corrected for the absolute thermoelectric power of platinum¹¹ to give the absolute value of the carbide.

The specimen was mounted vertically in the electron beam furnace and heated locally at a point below the lower junction. Thus the specimen could be raised to the desired temperature and a temperature gradient automatically established between the heated area and the upper end of the specimen. The lower end of the specimen was grounded so that the electron current from the hot filament did not pass through the part of the specimen between the junctions. The arrangement is shown diagrammatically in Fig. 6.

The results of the thermoelectric measurements are shown in Fig. 7. In each case the variation with temperature is essentially linear and is best shown by the straight lines through the points. The values for specimens E and F fall together and are represented by a single line on the diagram. Table V gives the carbon content of the specimens and values of the thermoelectric power at 0, 500 and 800°C, taken from the curves of Fig. 7.

Examination of the results show that for all specimens, the absolute thermoelectric power or Q_0 is negative and that its magnitude increases with temperature. In fact this increase is roughly proportional to the absolute temperature. This suggests that the charge carriers are electrons and that the temperature effect is in accord with the predictions of the simple model. On the other hand, the trend of the value of Q_0 at all temperatures is definitely upward (more negative) with increasing

carbon content of the carbide. This is shown more clearly if the results of Table V are plotted as in Fig. 8. This behavior is not in accord with the simple model which predicts an increasing Fermi energy resulting in a decreasing magnitude of Q_0 with increasing carbon content.

One specimen tested gave very unusual results. The thermal E.M.F. was comparable with the others at room temperature but dropped to values several times lower (less negative) at the higher temperatures. X-ray analysis showed strong graphite lines in the pattern in an amount estimated at several wt. percent. While it is not possible to correlate this behavior directly with the free graphite present, it does emphasize the fact that property measurements are meaningless without a detailed specification of the specimen upon which the measurements are made.

Limited measurements of the thermoelectric power of titanium carbide have been made by others. Hollander¹² measured single crystal specimens corresponding to $TiC_{0.94}$ and his value, corrected to the absolute value at room temperature was - 6.0 microvolt per degree centigrade. L'vov et al⁴ using unspecified samples report a value, corrected to absolute, of -12.4 microvolts per degree centigrade. Noguhi and Sato¹³ on sintered specimens of unspecified composition report an absolute value -10.81 at room temperature. Williams and Lye³ used specimens of crystalline TiC with nominal compositions ranging from $TiC_{0.79}$ to $TiC_{0.95}$ and found values ranging from -1 to -8 microvolts per degree.

In spite of considerable range of data at each composition, the increasing trend of their values with increasing carbon content is clear. The present results confirm this observation both in trend and in actual magnitude.

VII. Conclusions

In spite of the shortcomings of the specimens which have been available for examination both in this project and by other investigators, a picture of the electronic structure of the TiC alloy is beginning to emerge. The basis of this picture is a structure in which the outer electrons originating from both metal and carbon atoms occupy states which form a continuous band extending over a considerable range of energies. The number of electrons available, namely four from each metal atom and four from each carbon atom are not sufficient to fill the band and only states in the lower portion are occupied. The occupied portion however includes states of such character as to provide the good electrical conductivity as well as those responsible for the strong bonding which gives rise to the observed high hardness and extreme brittleness.

The band model is deficient in that it does not indicate in a direct way the specific nature of metal-to-metal or metal-to-carbon bonds nor the directed nature of these bonds, except insofar as states of p or d character correspond to wave functions which are not spherically symmetrical. This model presents a more general picture of the bonding mechanism but one which could be very useful in understanding the behavior if a detailed representation of the band of states could be obtained in the form of a density of states curve as a function of energy. Such a curve has been presented by Bilz¹⁴ as derived from detailed quantum mechanical calculations and is shown in Fig. 9.

The range of homogeneity of the cubic TiC phase is clearly the result of vacancies in the carbon atom sites and as the carbon content decreases from the stoichiometric values, the electron concentration decreases from the value of 32 electrons per unit cell. Bilz has calculated the position of the Fermi level for the stoichiometric case and it is shown in Fig. 9. It will be seen that the level is located in a region of the density of states curves which is decreasing sharply as the energy increases. On the same basis it is possible to make a rough estimate of the position of the Fermi level for the composition $\text{TiC}_{0.75}$ with an electron concentration of 28 electrons per cell. As shown in Fig. 9 it would fall below the second maximum of the density of states curve and in a region where the density of states is rising rapidly as the Fermi Energy or electron concentration increases.

This band model provides a satisfactory explanation of the variations in lattice parameter and thermal expansion with carbon content on the basis that the increasing number of electrons per unit cell increases the binding energy, thus pulling the lattice together and increasing its rigidity. With the increase in binding energy, the Fermi energy increases. The prediction of the variation in thermoelectric power is not as straightforward since it depends on details which the density of states curve only partially presents.

The density of states curve of Fig. 9 indicates that the assumption of an "almost free" electron model is not a very good approximation and that the prediction of the thermoelectric power

on this basis is inadequate. A more complete expression for the thermoelectric power is:

$$Q_0 = \text{Const.} \frac{T}{e} \left[\frac{\partial L + \partial A}{\partial E} \right]_{E = E_F}$$

where L is the length of the mean free path of the conduction electrons and A is the area of the Fermi surface.

If the slope of the density of states curve is taken as an indication of the changing area of the Fermi surface, then the sign of the second term in the bracket i.e. $\partial A / \partial E$ is positive in the range of $\text{TiC}_{0.75}$ to $\text{TiC}_{0.88}$ but is negative over the range $\text{TiC}_{0.88}$ to $\text{TiC}_{1.0}$. Thus if this term is always smaller in magnitude than the first term i.e. $\partial L / \partial E$, then the predicted value Q_0 would be negative but its magnitude should be greatest for the lowest carbon content. Unfortunately the experimental results of table V and Fig. 8 show the opposite trend although all of the values are negative and the temperature dependence is as expected. Of course the assumption that the mean free path is constant is obviously incorrect but on the basis of the presently available information, its behavior cannot be specified. The explanation of the thermoelectric power must await a more detailed description of the Fermi surfaces of these substances and of the electronic transport properties involved.

The key to the understanding of the non-stoichiometric carbides is the preparation of proper specimens upon which the more sophisticated physical measurements such as are required for a detailed electronic model can be made. Such specimens should be monocrystals but this alone is not sufficient. The

crystals must be uniform in composition from point to point and free from significant contamination, particularly of interstitial impurities such as oxygen and nitrogen. The amount of material required for the conventional chemical analyses makes it imperative that the sample be uniform so that individual specimens cut from it can be considered identical. Experience with a single crystal specimen illustrates the problem.

A single crystal sample of TiC in the form of a small cylindrical rod was obtained through the kindness of a colleague but its origin was unknown. Chemical analysis showed it to be $\text{TiC}_{0.94}$ and its lattice constant fell on the curve of Fig. 1. The crystal cleaved fairly readily on the cube planes but the cleavage faces while regular in the center portion of the crystal were very irregular near the surface. A small angle tilt boundary was also evident extending for some distance through the crystal. Electrical resistivity measurements on two bars cut from adjacent portions of the crystal gave definitely different values of 160 ± 5 and 180 ± 5 microhm centimeters.

An attempt was made to observe the local variations in composition with the electron microbeam analyzer. At present, carbon cannot be determined quantitatively with the instrument but variations in the titanium can be observed by direct comparison with a pure titanium standard. Scans of the resistivity specimens showed variations of the titanium content from point to point or from 2 to 3 wt percent and the low resistivity bar had an average value of titanium about 2 wt percent lower than the bar with the higher resistivity. Scans across the full cross section of the crystal showed significant variations from center

to surface. This points up the need for a spot method of analysis, preferably non-destructive, by means of which individual specimens can be characterized. Current developments of the microbeam analyzer give promise of a direct carbon determination with essentially the same precision as the current analytical method for carbon in these carbide crystals.

On the basis of the experience gained during the present program, it is strongly recommended that the emphasis of future work on the carbide systems be directed toward methods of specimen preparation and methods for determining the significant composition and uniformity of the specimen. There is still much to learn about these interesting and important substances but the application of the powerful tools which are available for probing their basic structure is largely a wasted effort unless proper specimens are available.

References

1. Norton, J.T. and Lewis, R.K. NASA Contract No. NASr-98(1963)
2. Piper, J. J. Appl. Phys. 33 2394 (1962)
3. Williams, W.S. and Lye, R.G. ASD Contract AF33(657)-10109
Progress Report No. 2
4. L'vov, S.N. et al Doklady Akademii Nauk USSR 135 577 (1960)
5. Rostoker, W. Trans. AIME 194 981 (1952)
6. Benesovsky, F. and Rudy, E. Planseeberichte fur Pulvermet.
8 66 (1960)
7. Dolloff, R.T. ASD Contract No.s AF33(616)-10286 and
AF33(657)-8025 Progress Report Nos. 2 and 3.
8. Dolloff, R.T. ASD Contract Nos. AF33(616)-10286 and
AF33(657)-8025 Progress Report No. 6
9. Gangler, J.J. American Ceramic Soc. 33 367 (1950)
10. Smithells, Metals Reference Book 2nd Ed. Vol. 2 p.638
Butterworth 1955
11. Kendall, P. Phys. Soc. Proc. 72 898 (1958)
12. Hollender, L.E. J. Appl. Phys. 32 996 (1961)
13. Noguchi, S and Sato, T. J. Appl. Phys. Soc. Japan 15
2359 (1960)
14. Bilz, H. Zeitschrift fur Physik 153 338 1958.

Table I

Comparison of Analyses for TiH_2 Starting Material and
Typical Sintered Specimens Analysis in ppm

	<u>TiH_2 Grade E⁽¹⁾</u>	<u>$TiC_{0.85}$⁽²⁾</u>	<u>$TiC_{0.95}$⁽²⁾</u>
H	3.5 - 3.8%	N.A.	N.A.
N	200	10	N.A.
O		80	N.A.
Mg	50	1	N.D.
Al	100 to 300	10	N.D.
Si	100	1	N.D.
Ca	50	N.D.	N.D.
Ti	95 - 96%	High	High
Cr		N.D.	< 100
Fe	100	10	10
Ni		1	N.D.
Cu		1	N.D.
Zr	100	10	10
Ag		1	1
Sn		< 100	10

(1) Metal Hydrides Analysis

(2) Jarrell-Ash spectrograph analysis except for
N and O which were obtained by vacuum fusion
analysis

N.A. = not analyzed

N.D. = not detected

Table II

HfC Specimens for Lattice Parameter Measurements

<u>Specimen No.</u>	<u>Method</u>	<u>Time-Hrs</u>	<u>Temp °C</u>	<u>C/Hf</u>	<u>a_o</u>
1 - H1A	Compact	2	2000	0.650	4.6118
2 - H1E	"	"	2200	0.687	4.6104
3 - H1A	"	"	2200	0.751	4.6278
4 - H1C	"	"	2200	0.812	4.6290
5 - H1E	"	"	2200	0.860	4.630
6 - H1C	"	"	2200	0.908	4.627
7 - H1E	O.C.	"	2200	0.741	4.6411
8 - H1A	"	"	2200	0.795	4.6412
9 - H1A	"	"	2200	0.888	4.641
10 - H1D	"	"	2200	0.895	4.6414
11 - H1A	"	"	2200	0.914	4.6397
12 - H1B	"	6	2200	0.940	4.6413

No significant amount of free carbon was found. Specimens No. 4 and No. 9 were analyzed for oxygen and found to be 710 and 400 ppm.

TABLE III

TiC Specimens for Density Measurements

<u>Specimen No.</u>	<u>C/Ti</u>	<u>a_o</u>	<u>D_{x-ray} (gm/cm³)</u>	<u>D_{pyc}^{23°C}</u>
1 - T24A	0.614	4.3144	4.57	4.60
2 - T24A	0.654	4.3185	4.60	4.55
3 - T27B	0.818	4.3319	4.72	4.70
4 - T27B	0.821	4.327	4.72	4.66
5 - T24B	0.835	4.3305	4.75	4.75
6 - T22H	0.861	4.3307	4.76	4.78
7 - T27B	0.856	4.3303	4.76	4.66
8 - T27B	0.912	4.3308	4.82	4.86
9 - T K	0.940	4.3268	4.85	4.90
10 - T L	0.942	4.3298	4.84	4.83

Table IV

Average Value of Thermal Expansion Coefficient per °Cx10⁶

Sample	TiC	<u>Carbon Content w/o</u>			<u>Temperature Range °C</u>				
		F.C	C.C	C/Ti	0-200	0-400	0-600	0-800	0-1000
A	17.18	0	17.18	.828	5.75	6.62	7.42	7.44	7.55
B	17.57	0	15.57	.850	5.25	6.38	6.92	7.25	7.50
C	18.31	0.01	18.30	.895	5.70	6.25	6.75	6.94	7.00
D	21.23	4.25	17.08	.815	6.50	6.88	7.08	7.19	7.25

T.C = total carbon content

F.C = free carbon content

C.C = combined carbon content

Table V

Absolute Thermoelectric Power, Microvolts per Degree Centigrade

<u>Sample</u>	<u>Carbon Content w/o</u>				<u>Temperature °C</u>		
	<u>T.C.</u>	<u>F.C.</u>	<u>C.C.</u>	<u>C/Ti</u>	<u>0</u>	<u>500</u>	<u>800</u>
E	15.96	0	1596	0.757	-2.1	-5.3	-7.3
F	16.73	0	16.73	0.803	-2.1	-5.3	-7.3
G	17.50	0	17.50	0.846	-2.7	-6.1	-8.2
H	18.18	0	18.18	0.886	-3.8	-7.5	-9.7
I	18.44	0.20	18.24	0.891	-4.7	-8.6	-11.0

T.C = total carbon content

F.C = free carbon content

C.C = combined carbon content

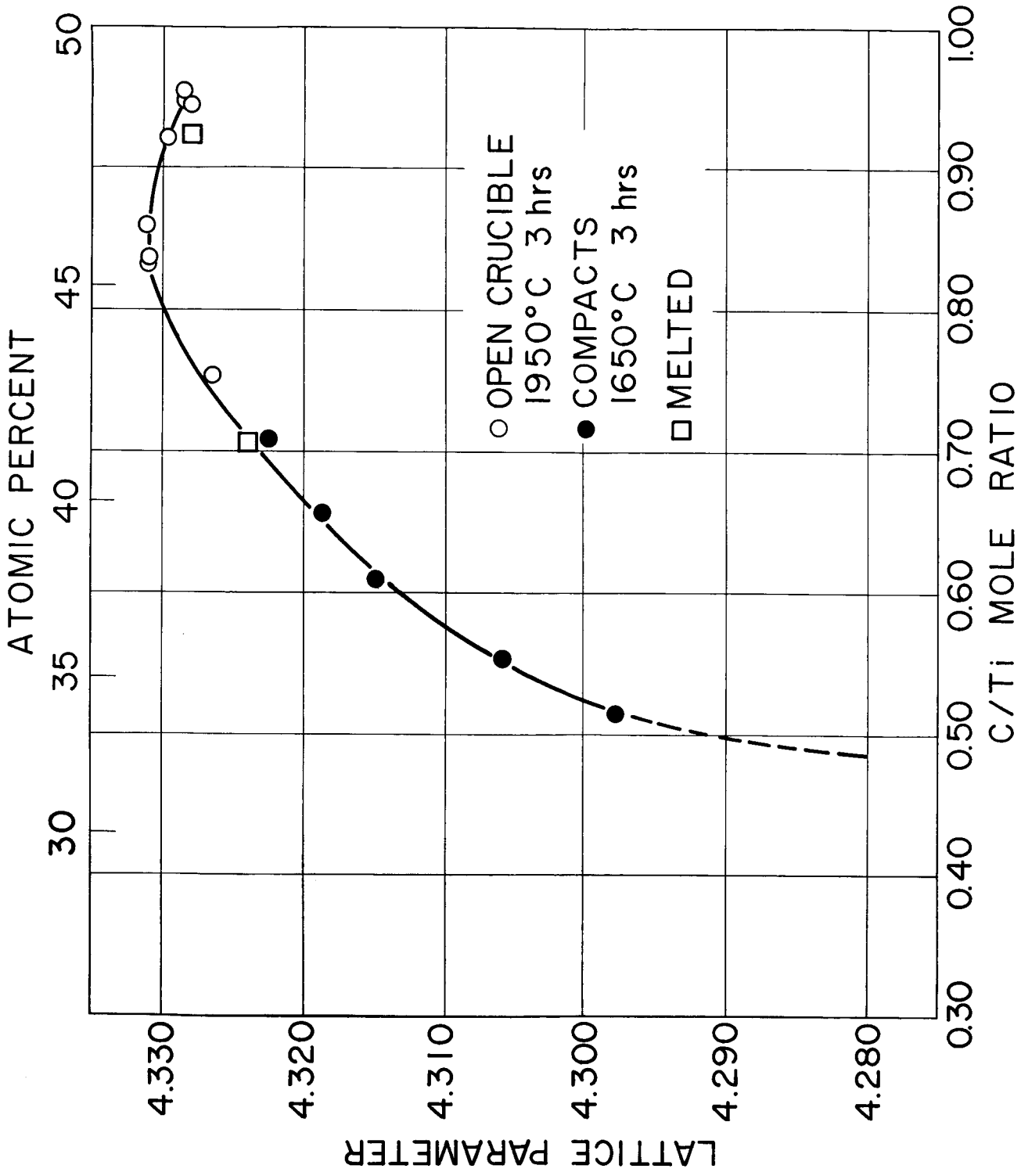

FIG. 1 LATTICE PARAMETER VS. CARBON COMPOSITION
TiC ALLOYS T24 SERIES

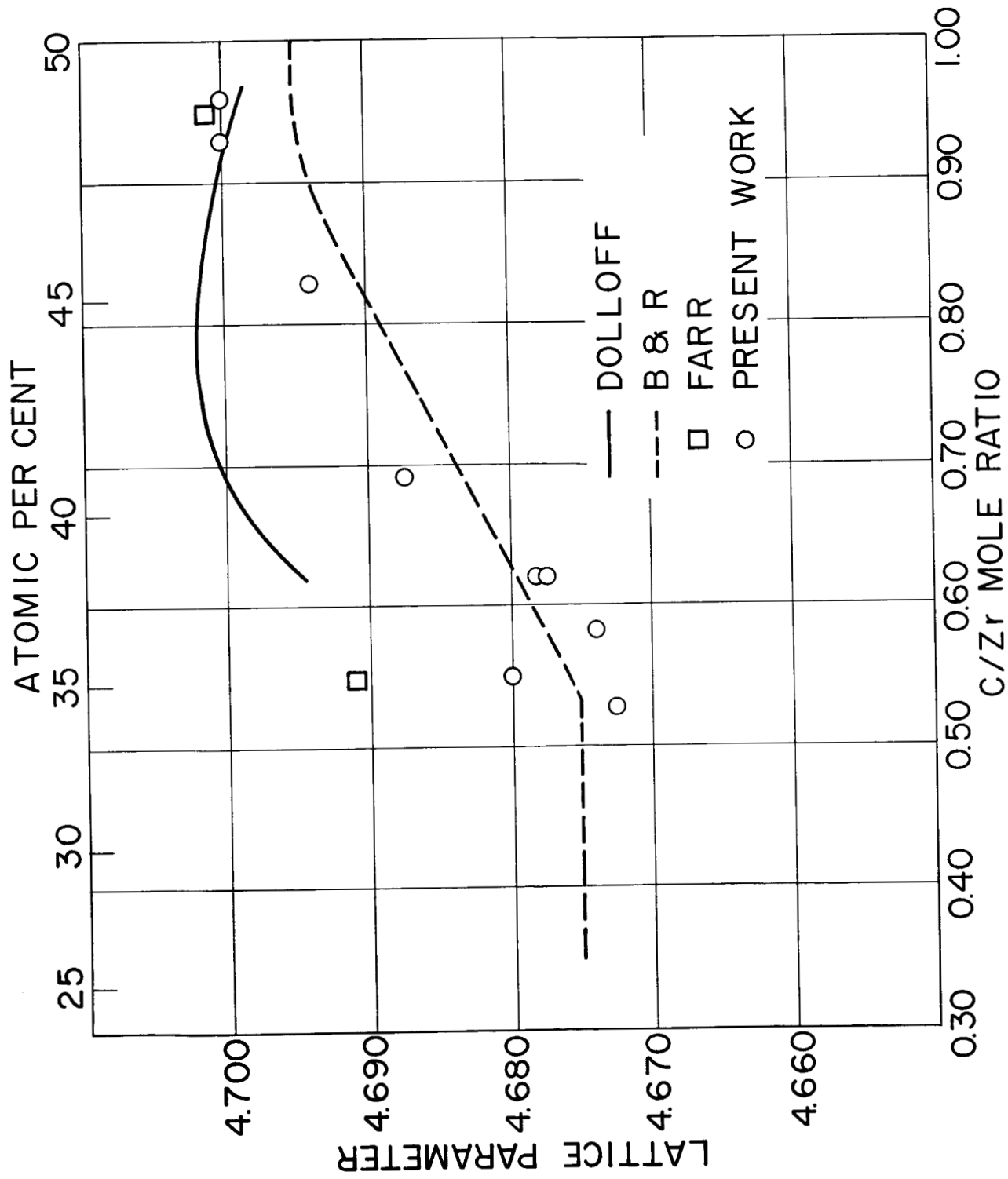

FIG. 2 LATTICE PARAMETER VS CARBON COMPOSITION
 COMPARISON OF LATTICE PARAMETER RESULTS
 FOR Zr-C SYSTEM

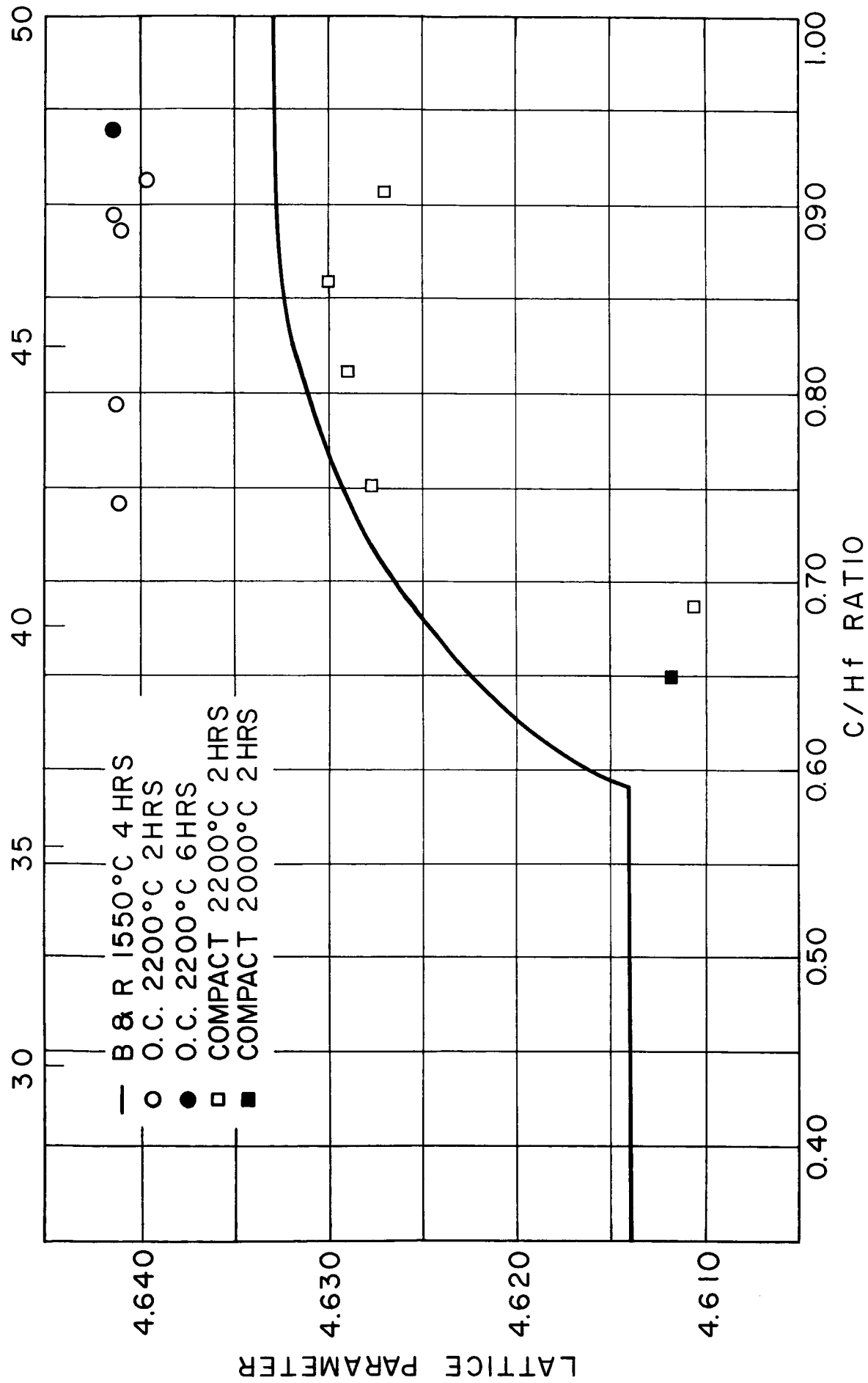

FIG. 3 HfC LATTICE PARAMETER VS COMPOSITION

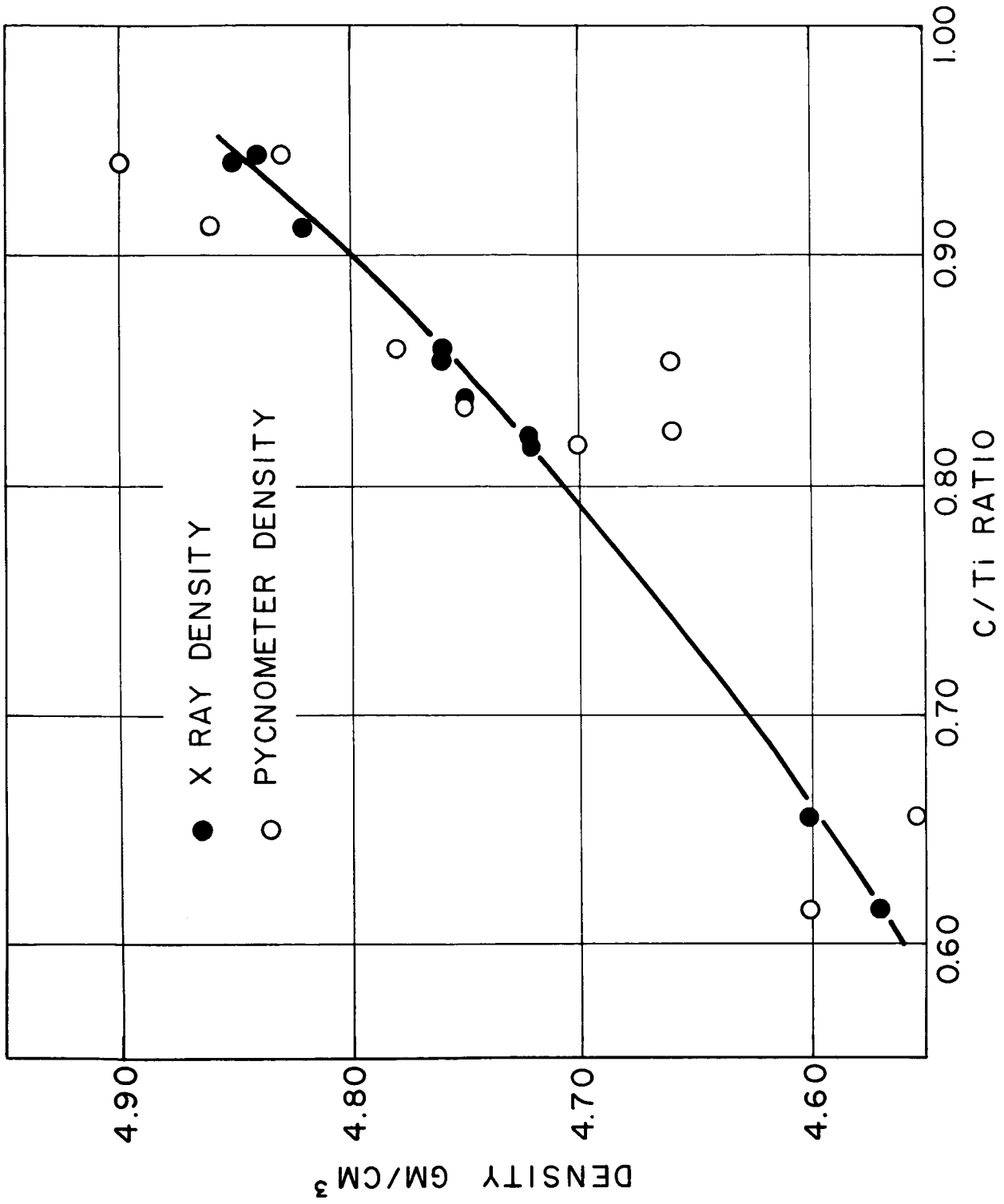

FIG. 4 TiC DENSITY VS CARBON COMPOSITION

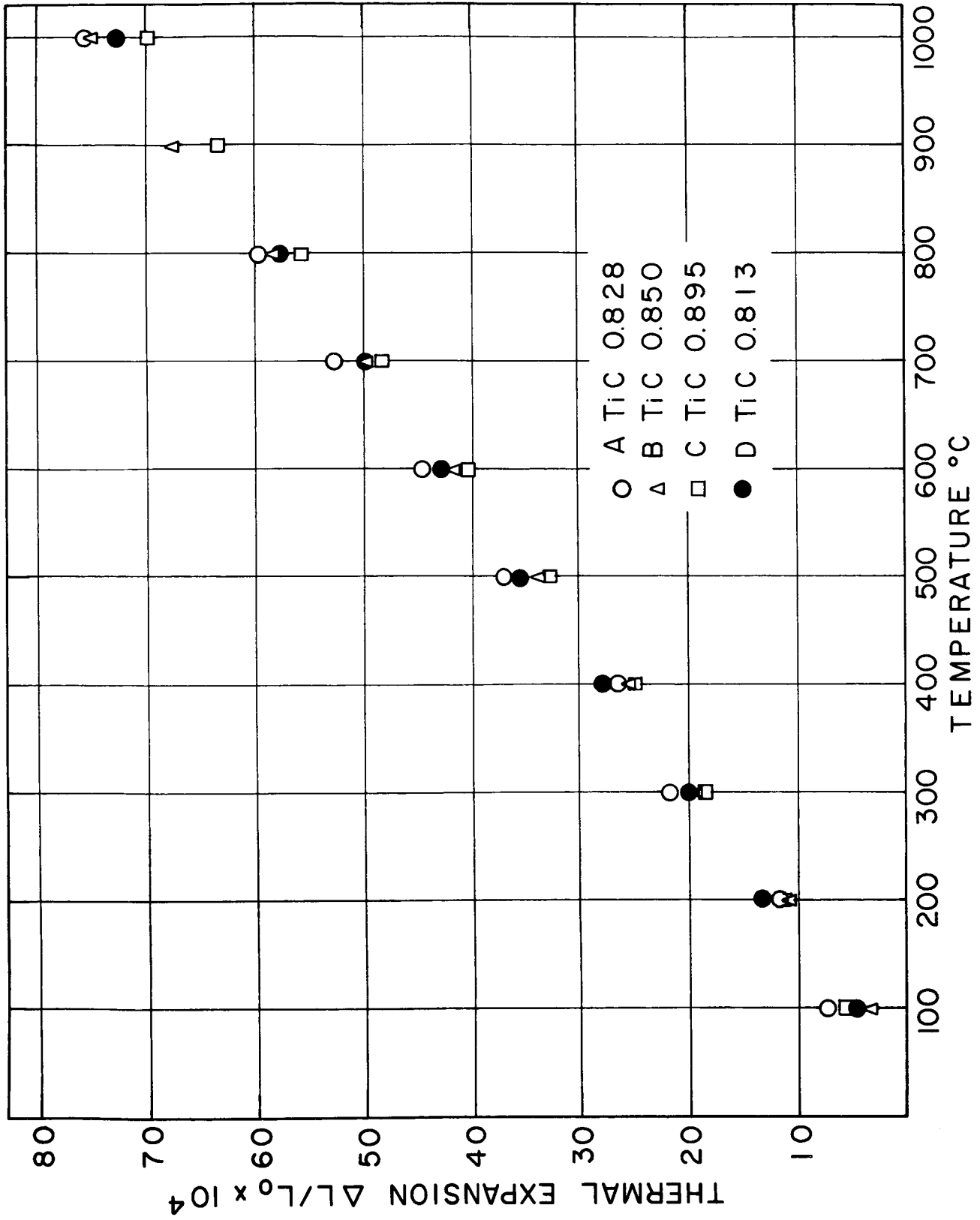

FIG. 5 THERMAL EXPANSION OF Ti - C ALLOYS

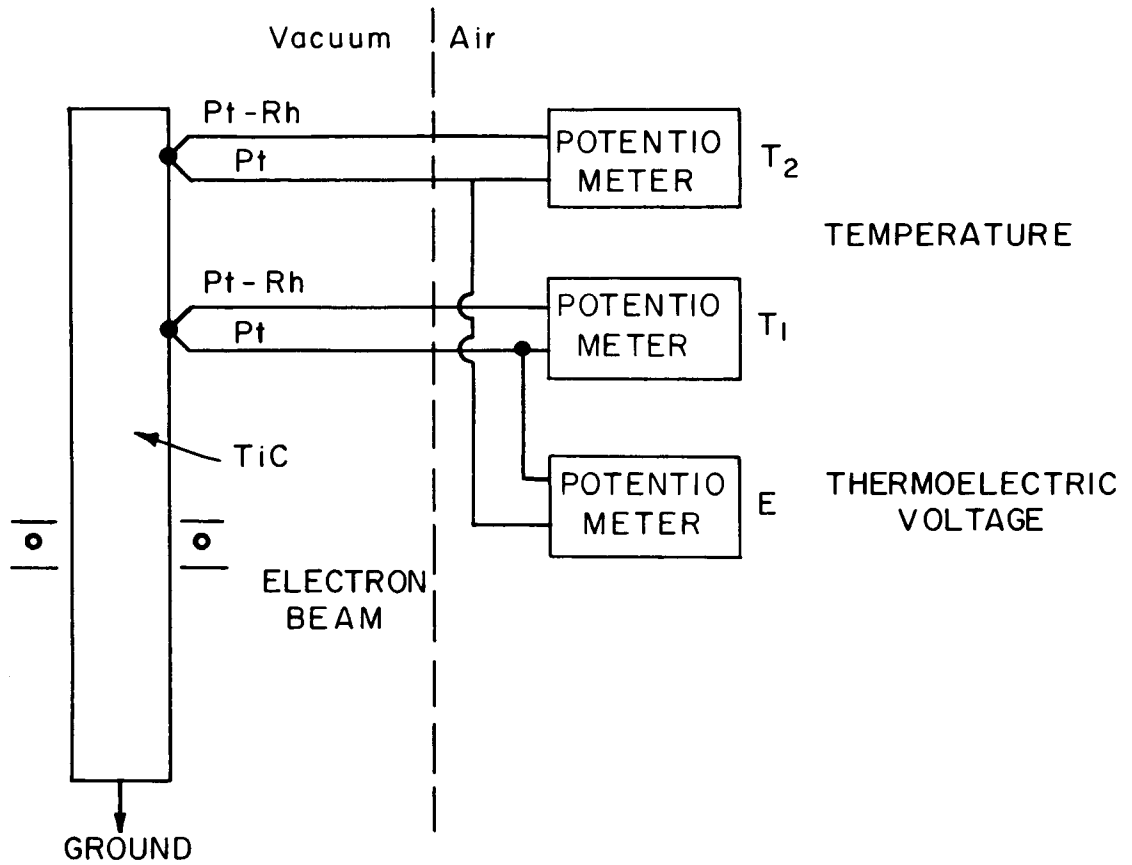

FIG. 6 DIAGRAM OF CIRCUIT USED FOR DETERMINING THERMOELECTRIC POWER

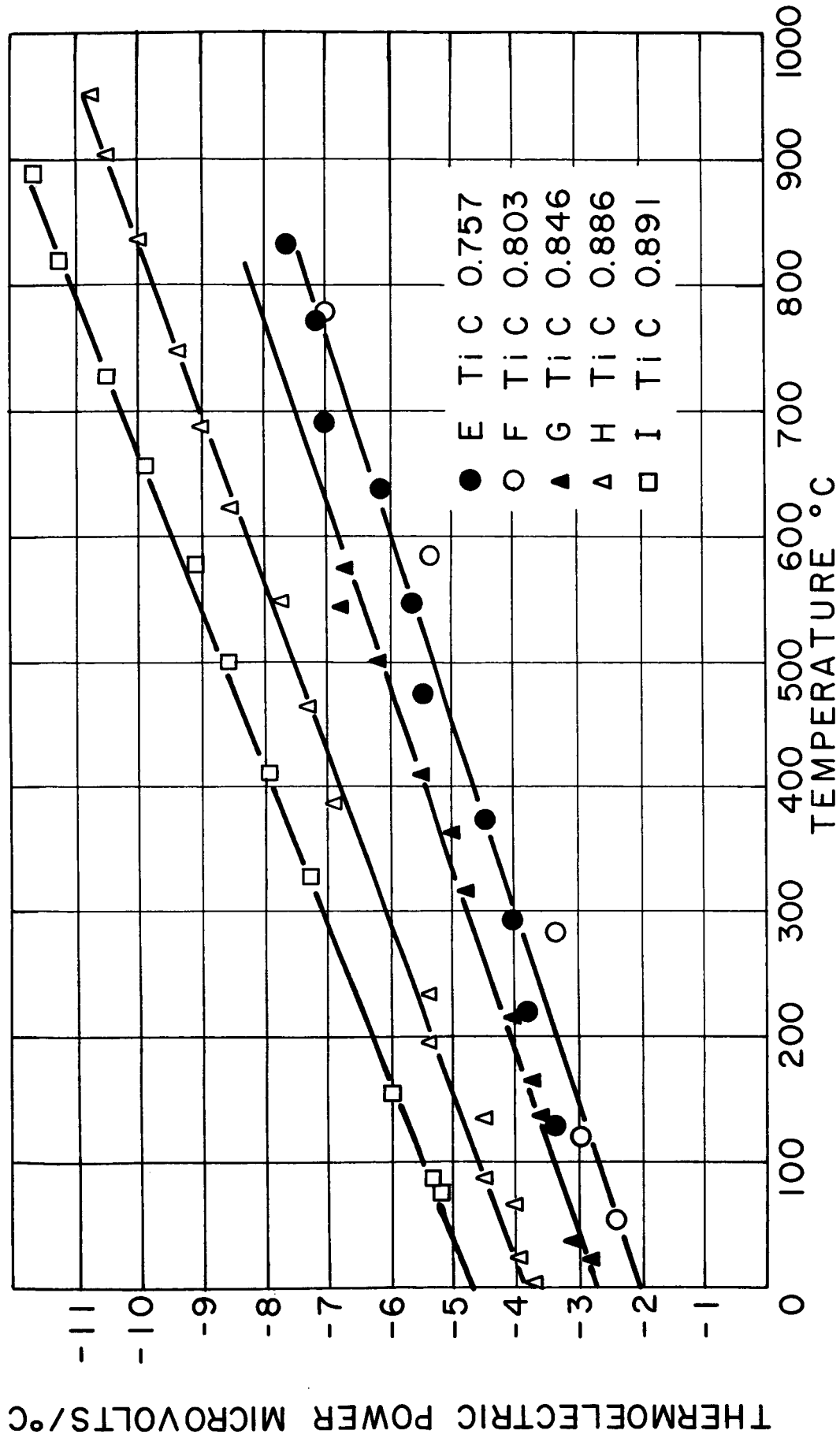

FIG. 7 ABSOLUTE THERMOELECTRIC POWER OF Ti-C ALLOYS VS TEMPERATURE

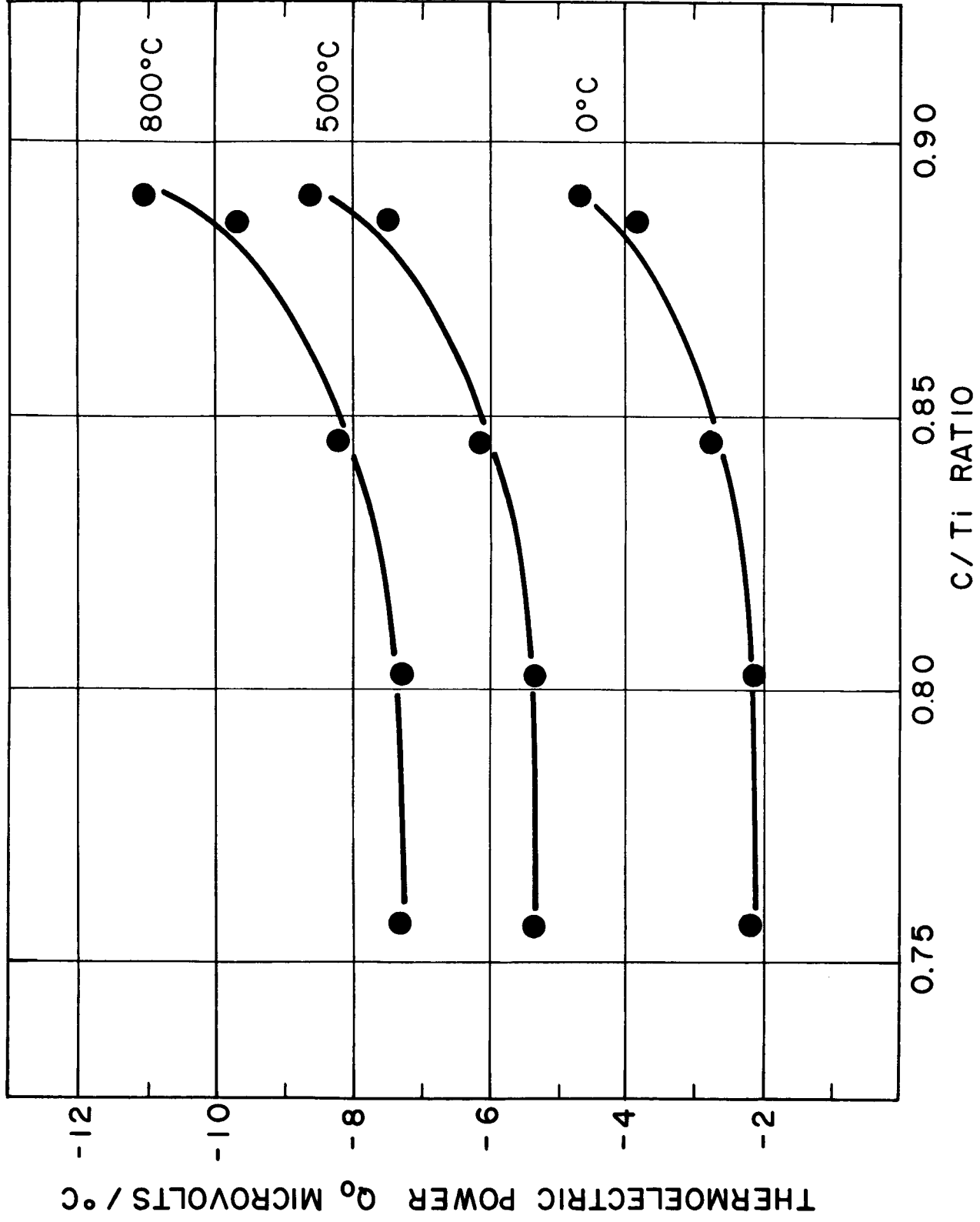

FIG. 8 ABSOLUTE THERMOELECTRIC POWER VS CARBON CONTENT

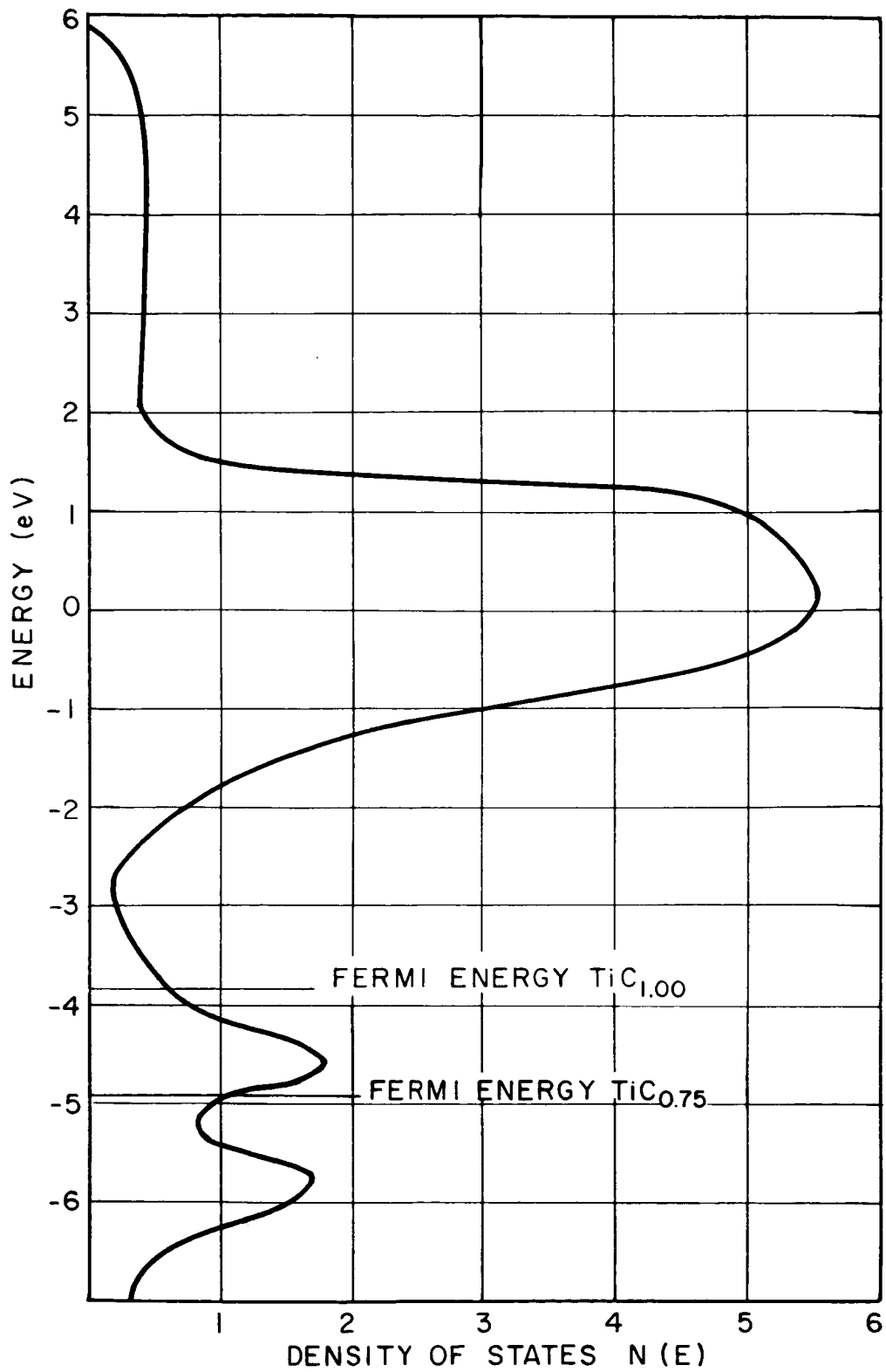

FIG. 9 DENSITY OF STATES VS. ENERGY
(After Bilz¹⁴)