

CHLORELLA

*Physiology and Taxonomy
of Forty-one Isolates*

BY

IKUKO SHIHIRA

*Research Assistant
Department of Botany
University of Maryland
College Park, Maryland*

AND

ROBERT W. KRAUSS

*Professor of Plant Physiology
Department of Botany
University of Maryland
College Park, Maryland*

**UNIVERSITY OF MARYLAND
COLLEGE PARK
MARYLAND**

Support for the work described in this publication was received in part from the Rockefeller Foundation and in part from the United States National Aeronautics and Space Administration.

PREFACE

At what time in the continuum of research it becomes desirable to publish a statement of the characteristics of a group of microorganisms depends as much on the need for information by others as on the extent of the data in the private possession of an investigator or of a laboratory. A researcher, knowing full well that subsequent years will enlarge and modify his current knowledge, is understandably reluctant to give the impression of completeness which publication invariably suggests. Yet the pressure of inquiry from the scientific community and the state of the literature often demand that some start be made to put things in order and to make available information that will, in turn, suggest means toward increased understanding. Such concerns—common to most authors, especially in biology—were especially acute in the case of the genus *Chlorella*. For 12 years physiological studies have been under way on various isolates of *Chlorella* in the laboratories at the University of Maryland. Often they have been seriously hampered by lack of a comprehensive treatment of the physiological and biochemical capabilities within the genus. The lack of a sound taxonomic framework on which to orient the identities of isolates has also been a serious deterrent to intelligent experimentation and reasonable interpretation of results. Communications have indicated a similar situation in other institutions. Therefore, in February 1959, a concentrated study was begun to achieve a physiological classification of as many isolates as possible in the hope that this approach would provide the necessary structure for future work. It was also decided to make the initial diagnostic approach as simple as possible so that other laboratories could use our methods with relatively uncomplicated apparatus. This was done with the conscious risk of overlooking some intriguing and important biochemical characteristics. The cultures studied in detail thus far are only a part of those available, as more are being added rapidly to collections throughout the world. However, they do represent a large cross section of the genus and give a view of what may be expected in the future.

As the data were collected, careful consideration was given to the methods of classification. Newer bacteriological techniques, such as the Kauffmann-White antigenic method, seemed promising but were rejected as being premature for *Chlorella*. Detailed studies of genetic stability, while highly desirable, also were deferred. Instead, easily repeatable experiments, with primary attention to nutrition, and careful observations on morphology, were employed to establish characteristics which could be objectively com-

pared. Where differences were obvious, species and varieties were established according to the International Rules of Botanical Nomenclature.

The vagaries of nomenclatural decision will always be a shock to physiologists and biochemists, but a legalistic approach is essential to ultimate stability in any classification and cannot be intelligently avoided. The fact that most of the hundreds of papers that have been published on an organism, which was called *Chlorella pyrenoidosa*, probably were not pertinent to that species at all is a case in point. The availability of a large list of carefully named species, all of which are deposited in the Indiana Algal Culture Collection, Indiana University at Bloomington, should render the path of physiologists and biochemists, not wishing to become involved in nomenclature, easier in the future. Where a physiologist is not absolutely sure of the identity of a *Chlorella* he has isolated, his publication should list only an identifying number. A culture should then be deposited at Indiana or Göttingen pending future diagnosis.

The authors are deeply indebted to many who have helped in the preparation of this work. Publication of the manuscript was delayed numerous times to permit adequate cross checking of the nomenclature and to repeat and confirm growth responses of the species. Although the errors are surely ours, much that is good in the book has come from the advice of our colleagues at the University of Maryland—Drs. Gauch, Galloway, Sorokin, and Paterson. Mr. Anthony Osretkar has given invaluable assistance in the laboratory and Mary Myers and Dorothy Keough have rendered technical assistance in the thousands of tests that have been made. Mr. Bernard Epel and Mr. Rudolph Gross have served with skill in photographing all the species many times. Dr. Richard Starr of Indiana University has been of great help on numerous occasions. Dr. Paul Silva of the University of California, Berkeley, and Dr. Karl Soeder of the University of Freiburg have critically reviewed the manuscript with special attention to nomenclature. Professor William T. Avery prepared the Latin diagnoses and the manuscript was diligently checked and typed by Patricia Alderton and Helen Kelly.

The authors have corresponded at length with Dr. Karl Soeder who also has been working toward a classification of isolates in the Göttingen Culture Collection. His kind suggestions have been appreciated and the authors look forward to an additional contribution to our knowledge of the genus in the near future.

December 1963

IKUKO SHIHIRA
ROBERT W. KRAUSS

TABLE OF CONTENTS

	PAGE
PREFACE	iii
INTRODUCTION	1
HISTORY	2
METHODS	6
DESCRIPTION OF SUBGENERA	13
DESCRIPTIONS OF SPECIES	15
<i>Subgenus Chlorella</i>	15
<i>Subgenus Auxenochorella</i>	39
<i>Nomina Inquirenda</i>	42
PHYSIOLOGICAL KEY	56
REVIEW OF CELLULAR CHARACTERISTICS	60
EVOLUTIONARY TRENDS WITHIN THE SUBGENERA	65
SUMMARY	77
APPENDIX	78
LITERATURE CITED	90
INDEX TO DESCRIPTIONS AND CITATIONS OF GENERA, SUBGENERA, AND SPECIES	93
INDEX TO AUTHORS	97

INTRODUCTION

Since the isolation of algae in pure culture by Beyerinck in 1890, unicellular green species have become increasingly prominent in physiological and biochemical studies. Among the many species those of the genus *Chlorella* have been the most common subject for investigation. Much of what is now known about the fundamentals of photosynthesis and inorganic nutrition has come from experiments with species of *Chlorella*. Furthermore, rapid growth and efficient photosynthesis have made them leading candidates as food producers (Krauss 1962) and gas exchangers (Myers 1960) in the closed ecological systems being prepared for space exploration. An object of intensive experimentation, the genus *Chlorella* has never been the subject of a discriminating study to determine clearly the characteristics of the various species and to arrive at a reasonable classification. The most probable reasons for this neglect have been two. First, the genus evidences few diagnostically useful morphological characters. The small spherical- or spindle-shaped cells are very much alike in isolates conspicuously different in their physiology. Second, the physiological variability evidenced by individual species, and by even clones of species, has made a simple physiological classification appear a major task.

The evident difficulty in attempting a comprehensive treatment of the genus from both a physiological and taxonomic viewpoint cannot prevent the resolution of the problem forever. However, despite the early work of Krüger (1894), Chick (1903) and Chodat (1913), a classification of a genus of green algae, built primarily on physiological characters, has never been achieved. Knowing that any first attempt can only but lay the groundwork for future study, the intent of this publication is to provide such a foundation.

HISTORY

The genus *Chlorella* was first delineated by Beyerinck in 1890(c) as a genus of four species, two of which were previously described by Brandt (1881, 1882) as *Zoochlorella*. Beyerinck believed that the algae classed as *Zoochlorella* were also able to live free of the sponges and hydras in which they were most usually found and were related to his free-living *Chlorella vulgaris*. Beyerinck's description of the genus is translated as follows:

Chlorella: Single celled green algae belonging to the Pleurococcaceae, with spherical, ellipsoid, or flattened cells of from 1 to 6 μ , normally with only one chromatophore with the structure of a segment of a spherical cup; the pyrenoid indistinct or absent. In the light, paramylum, which on death turns brown, arises, with the evolution of oxygen, out of carbon dioxide. The nucleus mostly simple, sometimes double, of changing size, composed only of chromatin. Reproduction is based on free cell growth through successive divisions into two. The products of division become free through rupture of the mother cell wall; they can be very different in size from 0.5 to 4 μ . Motile spores are completely absent; in fresh and salt water and apparently also on land.

Since Beyerinck's initial description, the definition of the genus has changed very little. However, Beyerinck's transfer of the species *Zoochlorella parasitica* Brandt and *Zoochlorella conductrix* Brandt to *Chlorella* cannot be accepted under the International Rules of Botanical Nomenclature (1961). If the symbiotic forms and the free-living forms do, in fact, belong in the same genus, then Brandt's existing genus *Zoochlorella* should have been retained rather than to erect the new genus *Chlorella*. Failure to respect Brandt's priority causes *Chlorella* to be an invalid name which should be discarded in favor of *Zoochlorella*. This is true in spite of the fact that Brandt (1883) withdrew the new genus name because of research indicating that the new algae were not obligate parasites. In view of the widespread use of the name *Chlorella*, and the unfortunate connotation of the name *Zoochlorella*, the former is retained in this treatment. Final disposition of this case rests with the International Botanical Congress. The authors intend to propose *Chlorella* as a *nomen conservandum* to the Committee on Nomenclature for action at the next Botanical Congress.

The last serious revision of the genus was that of Brunthaler in Pascher's Süsswasserflora (1915). He described the family Chlorellaceae as having two tribes, the Chlorelleae, characterized by smooth membranes or walls,

and the Micractinieae, having cells covered with bristles or spines. The Chlorelleae contained four related genera: *Chlorella*, *Placosphaera*, *Radio-coccus* and *Tetracoccus*. *Chlorella* was characterized as the single-celled species free of both calcium incrustation and gelatin sheaths. To the three sections of *Chlorella* named by Wille (1909) was added the section *Chloroideum* of Nadson (1906) to give four as follows:

Euchlorella Wille—Cells spherical or elliptic with a thin membrane, a bell shaped chromatophore, and pyrenoid.

Palmellococcus (Chodat) Wille—Cells spherical, with very thick membranes, chromatophores parietal and platelike, without a pyrenoid and mostly covered with orange colored oil.

Chloroideum Nadson—Cells spherical, elliptic, or eggshaped, green, chromatophores platelike without a pyrenoid.

Aerosphaera (Gerneck) Wille—Cells spherical, green, with a netlike folded chromatophore without a pyrenoid.

With the exception of certain primitive members of the *Cyanophyta*, *Chlorella* has perhaps the simplest structure and form of reproduction known among the algae. Common in nature, the genus is one of the most conspicuous of those green unicells showing no motility during reproduction. Commenting on the lack of motility in the genus, Oltmanns (1923) expressed the opinion that the non-mobile autospores of *Chlorella* are the result of the evolutionary loss of flagella by typical zoospores common in closely related groups of the Chlorococcales. However, in the family Chlorellaceae (or as some would call it, the Oocystaceae) all genera are characterized by lack of flagella and reproduction by autospores.

Although the concept of the genus has remained constant, the number of described species has increased over the years. A list of the published species of *Chlorella* can be found in the index. To a large extent these species have been based on morphological differences and most have been described directly from nature. This has been true in spite of Beyerinck's admonition that the study and identification of species be undertaken only from pure culture (1890). However, some work has been done in pure culture and what information we have about the physiology of *Chlorella* has come from these investigations. Typical of the early studies are the papers of Chodat (1909, 1913) and Artari (1892). From such work it became obvious, at a very early date, that the mode of nutrition in the genus varied from the independent photosynthesis in forms called autotrophic photolithotrophs, to that in which the tendency toward heterotrophic chemo-organotrophy is so well developed that chlorophyll is promptly lost in the presence of sugars. There is no doubt that the genus *Prototheca* is

the end in the evolutionary line of *Chlorella* leading toward complete heterotrophy.

Two other characteristics of some species of *Chlorella* aroused the interest of Beyerinck (1890), Chodat (1913), and Krüger (1894). First, increased growth was detectable when sugars were present in the medium. Apparently the presence of a reduced carbon source was a distinct stimulus to photosynthesizing algae and caused not only a different growth rate, but differences in pigmentation and morphology (Chodat 1913). That this is not true in some species has been well demonstrated by Bristol-Roach (1927) and Myers (1960). Second, enormous variability in performance of the cultures could be observed. Some species, which were considered to be in the genus *Prototheca* and were quite colorless during weeks of culture, would suddenly turn green. Others which were green would lose their pigmentation almost as suddenly (Beyerinck 1890). This inherent variability, which was so disconcerting to the early workers, has been confirmed in this study and must almost surely be a source of much of the conflict in evidence produced by modern physiologists when using species of *Chlorella*.

Until the present, Chodat's studies of the genus in pure cultures were the most complete from a physiological point of view. Chodat's approach (1909, 1913) was to culture the algae on different types of media, but always on agar or gelatin, and to observe their growth. Especial interest was taken in the structure and color of the colonies formed. Most of the cultures were grown for months before the colonies were characterized. The differences in responses of the algae to the media containing various nitrogen and carbon sources are still good enough to permit identification of some species. However, for most species the variables in humidity, temperature, light, and nutrient source make the slight differences in response almost impossible to duplicate. Furthermore, colony structure, which becomes a helpful diagnostic technique for bacteria a few days after inoculation, requires months of growth for algae. In brief, though some of Chodat's species are recognizable, most are too poorly characterized to be identified.

Meyer (1932) also used Chodat's technique in attempting to develop a theory for chlorosis and variegation in all plants. He examined a number of species of *Chlorella* and recorded color changes of colonies grown on agar containing various organic carbon and nitrogen sources.

More recent workers have tabulated the characteristics of species of *Chlorella* in greater detail. Chick (1903) has described *Chlorella pyrenoidosa* in fair detail so that it can probably be recognized. Sorokin (1959) has obtained, under carefully controlled environments, perhaps the most precise characterization of an alga which he has called *Chlorella pyrenoidosa*

strain 7-11-05. Other strains or species used in physiological studies, especially those dealing with photosynthesis, have been so poorly described that there is no hope of repeating the work with algae other than those from the same culture collection used in each laboratory. Of course, in many cases, these cultures have been lost and are no longer available.

A complication which has consistently plagued investigators is the difficulty in matching an environment prepared for a culture in the laboratory with that encountered by an alga in nature. It is not a simple matter to match all the variables of the ecological niche into which a species has evolved. An organism will appear to be stimulated in growth by glucose in one medium, but in another, which supplies some other metabolite or growth factor that overcomes the need for glucose, no stimulation at all may be observed. A report of stimulation in one laboratory may therefore differ from that in another where conditions are not identical.

The classification of the genus, therefore, has been chaotic. No comprehensive treatment, in which all variables were reduced to reproducible conditions, has been attempted, and consequently few species of *Chlorella* can be identified on the basis of the original descriptions.

METHODS

The organisms selected for this study were 41 strains of the genus *Chlorella* including all of those in the algal culture collection at Indiana University, Bloomington, Indiana, as well as some in the collection in the Botany Department at the University of Maryland. Of the 41 cultures, 11 had been assigned species names by persons making the isolations. Cultures from

TABLE 1
Basal Inorganic Medium for Culture of *Chlorella*

Salt	Grams Per Liter
<i>Major Nutrients</i>	
NH ₄ NO ₃	1.00
K ₂ HPO ₄	1.00
MgSO ₄ ·7H ₂ O	0.25
<i>Trace Metals</i>	
Na ₂ ·Mn·EDTA*	0.0071
Na ₂ ·Ca·EDTA	0.0071
Na ₂ ·Co·EDTA	0.0077
Na ₂ ·Cu·EDTA	0.0093
Na ₂ ·Zn·EDTA	0.0067
Na·Fe·EDTA	0.038
MoO ₃	0.001
H ₃ BO ₃	0.010

* EDTA = Ethylenediaminetetraacetic acid.

To prepare agar slants 15 grams of agar are added to 1 liter of medium.

Indiana are hereafter listed according to the algal culture collection number according to Starr (1960). The corresponding numbers from the original collection of Dr. E. G. Pringsheim are listed also as Cambridge numbers. Where the question of type is involved the Indiana numbers should be given priority inasmuch as all cultures so designated were obtained directly from Indiana.

Stock cultures of these strains were maintained in 25 ml screw top test tubes on agar slants of basal inorganic medium or proteose medium. The inorganic culture medium is listed in Table 1. Micronutrients were supplied as inner complex salts of ethylenediaminetetraacetic acid as suggested by Thomas and Krauss (1955). Proteose agar was used for stock cultures

being kept for a long period. It was prepared by adding 1 gram of proteose to each liter of Bristol's solution according to Starr (1960) (see Table 2). Inoculation of experimental media was always made from agar slants of the inorganic medium to avoid any carry-over of organic components of the proteose medium. Fluorescent lamps provided an illuminance of approximately 200 foot-candles to the stock cultures. The temperature was maintained at 25° C.

During experiments test tubes, 16 mm wide and 125 mm long plugged with cotton and containing 5 ml of inoculated medium, were incubated on a shaking apparatus which held them at a 15° angle and rocked them with an

TABLE 2
Proteose-Agar Medium for Cultures of *Chlorella*

Stock Solutions *	
Compound	Grams Per Liter
NaNO ₃	10.0
CaCl ₂	1.0
MgSO ₄ ·7H ₂ O	3.0
K ₂ HPO ₄	3.0
KH ₂ PO ₄	7.0
NaCl	1.0

* Ten ml of each of the stock solutions are added to 940 ml of distilled water. To this is added 0.05 ml of 1.0% FeCl₃ and 15 grams of agar. Media were adjusted to pH 6.5 with dilute HCl.

amplitude of 3 inches at the rate of 68 cycles per minute (Fig. 1). The shaker was illuminated by fluorescent lamps which supplied an incident illuminance between 300 and 400 foot-candles at the surface. The ambient temperature was maintained at 25° C. Dark cultures were obtained by wrapping whole test tubes with aluminum foil. When light cultures were to be compared directly with dark cultures, cotton plugs were covered with foil in order to maintain the same conditions of gas exchange. During tests of the effect of supplemental CO₂, bubble-cultures were also employed. Five percent CO₂-in-air was bubbled in 18 ml test tubes containing 10 ml of medium. The tubes were supported in water baths maintained at 25° C and illuminated by fluorescent lamps giving an illuminance of 500 foot-candles.

A standardization procedure was essential to eliminate the effect of differing past histories on the performance of the cells. The protocol was as fol-

lows: Algal cells were transferred from agar slants into inorganic basal medium for all strains capable of good autotrophic growth, or into yeast-extract medium for strains requiring an organic supplement. On reaching an optical density of 0.5 in the 16 mm diameter culture tubes, 0.1 ml of cell suspension was transferred into each of a series of test tubes containing the various test media. When the experiments were designed to determine the comparative value of different nutrient sources, the inoculant was first pre-cultured in a medium in which the nutrient in question was absent.

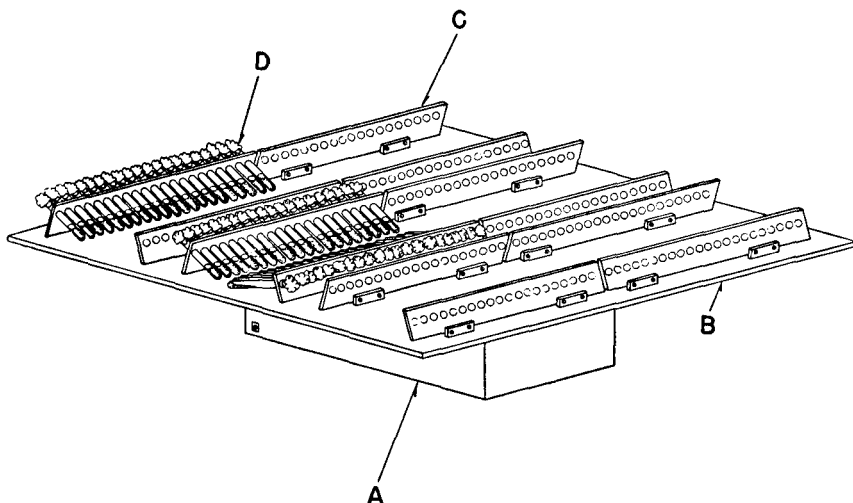


FIGURE 1. Shaking apparatus for the culture of unicellular green-algae. A—Eberbach Reciprocating Shaker, B—White plywood mounting board, C—Masonite test-tube racks, D—Cotton-plugged culture tubes.

This resulted in elimination of any carryover of a nutrient into the experimental medium. For those strains showing a requirement for organic factors, the transfer into a strictly inorganic medium was repeated numerous times until the carryover of organic factors was almost exhausted, as indicated by a greatly reduced growth rate. The time of incubation in the experiments was normally 5 days. However, especially rapid- or slow-growing strains were incubated from 3 to 10 days depending on differences in growth rate.

Growth was measured as optical density on a Coleman Universal Spectrophotometer set at $525\text{ m}\mu$. In each experiment, the reading of optical density was the average of two test-tube cultures. All experiments were

repeated at least twice. In the case of variable species, experiments were repeated many times.

Cultures were always maintained free of contamination from bacteria and fungi. Inoculations were made in a sterile transfer-room. Autoclaving was employed for the sterilization of most media and equipment. For sterilizing the unstable organic compounds, an ultra-fine sintered-glass bacteriological filter or a Seitz Filter was used.

EXPERIMENTAL MEDIA

Sugars.—The test for sugar requirements included the pentose, arabinose; four hexoses, fructose, glucose, galactose, and mannose; three disaccharides, sucrose, lactose, and maltose; a trisaccharide, raffinose, and a polysaccharide, alcohol-precipitated dextrin. Sugars were added to the basal medium to give a concentration of 0.1%. Glucose, as a representative organic carbon source, was also tested in combination with other factors in culture media. Preliminary experiments showed that the most suitable concentration of glucose generally was 0.1%. Sugars were always autoclaved separately from the inorganic basal medium. A two-fold concentration of the sugar medium and a two-fold concentration of the inorganic basal medium were mixed under sterile conditions after autoclaving.

A standard initial pH of 6.5 was obtained for all media by adjustment with HCl or KOH.

Yeast Extract.—As a test of the requirements for a growth factor, 0.01% yeast extract (DIFCO Certified Bacto Yeast Extract) was employed. A 0.1% solution was utilized to search for any other requirement for organic components not found in the basal inorganic medium.

Vitamins.—A vitamin mixture added to the basal inorganic media served to explore any total vitamin requirement. It was composed of thiamin 0.002%, Ca-pantothenate 0.02%, pyridoxamine 0.001%, and inositol 0.2%, as suggested by Wetherell and Krauss (1957). Thiamin, biotin, and vitamin B₁₂ were also tested separately at concentrations of 1 μ g/l and 10 μ g/l. Thiamin, supplied in the basal medium for auxenotrophs, was at a concentration of 1 μ g/l.

Amino Acids.—Casein hydrolysate (DIFCO Vitamin-Free Casamino Acids) was tested for the total requirement of amino acids at a concentration of 0.1%. When the casein hydrolysate was tested as a N source, the NH₄NO₃ in the inorganic basal medium was deleted. The simple amino acids, glycine, alanine, cysteine, and tryptophane, were also tested to determine the specificity of the amino acid requirement. They were added to give an equivalent nitrogen concentration of 1 mg/l.

Sulfur.—The media containing different sources of sulfur were prepared to contain 30 ppm of sulfur in each. As a control, a medium containing no sulfur was prepared with $MgCl_2$ instead of $MgSO_4$. Media containing 0.15 g of methionine and 0.1 g of Na-thioglycollate, cysteine, and cystine were each supplied to 1 liter of sulfur-free medium. Sterilization was accomplished with the microfilter.

Nitrate and Ammonium.— KNO_3 and NH_4Cl were supplied as nitrogen sources in a nitrogen-free medium. A medium supplied 0.2 g of KNO_3 per liter or 0.1 g of NH_4Cl per liter maintained a nitrogen content similar to that in the inorganic basal medium.

Microphotography.—A Bausch & Lomb Dynazoom Laboratory Microscope, attached to a Kodak camera, with an apochromat $90\times$ oil-immersion objective lens, NA.1.3, served for photomicrography. Film used was indoor Kodachrome Professional Type A. Maximum illumination from the substage illuminator was reduced by a 1.3 (5% transmission) neutral filter and a blue filter, Harrison No. 3, B-2. The exposure time was 3 sec using a diaphragm setting giving a two-thirds cone. The magnification in all photographs in this paper is $900\times$ as reproduced. Algal cells for photographs were prepared using the same standardized culture technique as mentioned above. When growth reached near 0.5 O.D., culture tubes were removed from the shaker and were left standing for one hour. Dense cultures were obtained from the bottom of the tube after settling. Cells for photographing were obtained from an even mixture prepared from those which had settled to the bottom of the tube. Drawings of chromatophore types in Figure 2 were intended to be diagrammatic. They were drawn without attempting to assign them previously to species. They represent the main types of chromatophores and are referred to in the descriptions of species. The drawings do not attempt to take into account the various sizes of organisms in which they are found. However, cell shape and the presence or absence of pyrenoids are characteristic of the species showing a given chromatophore type.

The nomenclature of the algae was determined by following the International Code of Botanical Nomenclature (1961). Strict attention was paid to priority of publication. Previously published names were rejected only when they were insufficiently described to be identified. An earlier name was retained if there was enough evidence to link a previous description to the alga at hand. In every case the description of the species has been amended and greatly enlarged to include all available data. Most of the described characters are physiological but morphological differences are apparent and, especially with regard to chromatophore structure, are of considerable aid in strengthening the classifications.

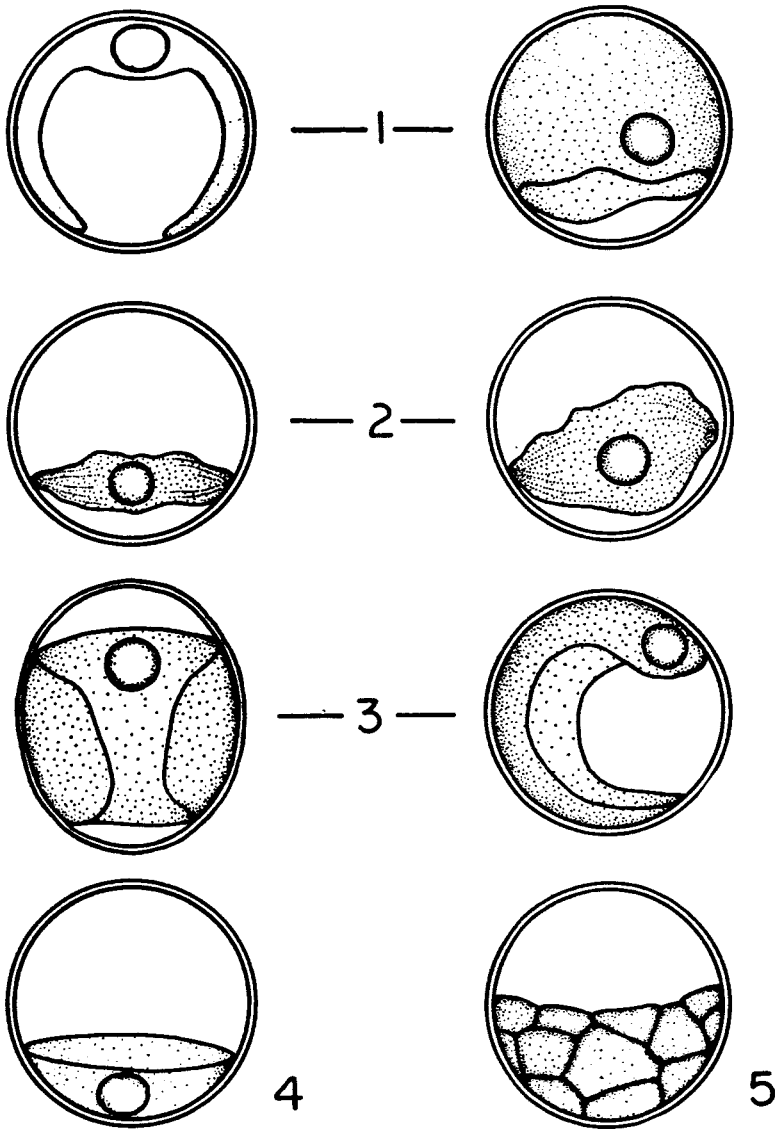


FIGURE 2. Chromatophore type:

1. Mantle-shaped chromatophore (Figure on the left is a cross-section).
2. Discoid or disc-shaped chromatophore.
3. Girdle-shaped chromatophore.
4. Shallow, cup-shaped chromatophore.
5. Granular cup-shaped chromatophore.

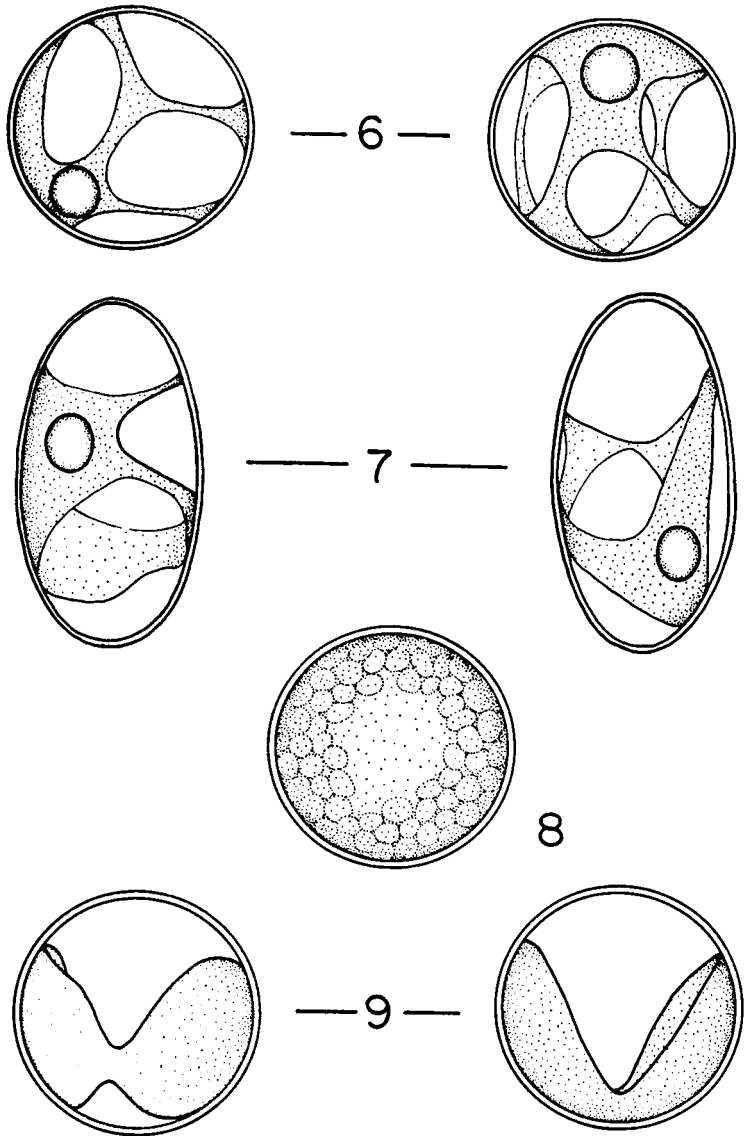


FIGURE 2. Chromatophore type (cont'd):

6. Net-like chromatophore.
7. Net-like chromatophore in a spindle-shaped cell.
8. Alveolar chromatophore.
9. Dumbbell-shaped chromatophore.

DESCRIPTION OF SUBGENERA

Wille (1909) subdivided the genus into 4 subgenera based on morphological criteria which are often not stable even in clones, much less in species or subgenera, and cannot be considered valid on these grounds. The genus does, however, have a conspicuous dichotomy which can conveniently be recognized on the subgeneric level. Therefore, two subgenera are erected based primarily on the requirements for growth factors, although other characteristics also support this division.

Subgenus *Chlorella* subgenus nov.

Id subgenus generis *Chlorellae* cuius natura talis est ut absoluta vitaminarum necessitate careat; cellulae auctus in luce in mediis omnino inorganicis capaces; cellulae aut capaces aut incapaces auctus in quibusdam fontibus carbonei organicis in tenebris; cellulae in fontibus carbonei organicis in luce viriditatem plerumque retinentes; cellulae aut NO₃ aut NH₃ fontibus nitrogenii utentes; cellulae sphaericae ad ellipsoideas; chromatophori formam amiculi, aut disci, aut cinguli, aut calicis, aut retis praebentes, aut granulares.

Species typica: *Chlorella vulgaris* Beyerinck Indiana Algal Culture Collection No. 257.

That subgenus of the genus *Chlorella* characterized by the lack of an absolute vitamin requirement; cells capable of growth in the light on strictly inorganic media; cells either capable or incapable of growth on certain organic carbon sources in the dark, cells usually remaining green on organic carbon sources in light; cells using either NO₃ or NH₃ as N source; cells spherical to ellipsoidal; chromatophores either mantle-shaped, discoid, girdle-shaped, cup-shaped, netlike, or granular.

Type species: *Chlorella vulgaris* Beyerinck, Indiana Algal Culture Collection No. 257

Synonyms: *Palmellococcus* Chodat 1894:601
Euchlorella Wille 1909:56
Palmellococcus (Chodat) Wille 1909:56
Chloroideum Nadson 1906:13
Chloroideum (Nadson) Wille 1909:56
Aerosphaera Gerneck 1907:251
Aerosphaera (Gerneck) Wille 1909:56

Subgenus *Auxenchlorella* subgenus nov.

Id subgenus generis *Chlorellae* cuius natura talis est ut necessitatem vitaminarum absolutam habeat; cellulae quosdam carbonei organici fontes ad optime

crescendum requirentes, sed carboneo organico suppeditato flavescentes; cellulae acidis aminosis et quibusdam carbonei organici fontibus suppeditatis viriditate opaca viridescentes; cellulae in tenebris et acetate cultae virides sunt; cellulae NO_3 fonte nitrogenii utendi incapaces; cellulae sphaericae; chromatophori formam manubrii gymnastici praebentes.

Species typica: *Chlorella protothecoides* Krüger Indiana Algal Culture Collection No. 25, Cambridge Collection No. 211/7.

That subgenus of the genus *Chlorella* characterized by an absolute vitamin requirement; cells requiring certain organic carbon sources for optimum growth, but turning yellow when supplied with organic carbon; cells turning deep green when supplied amino acids and certain organic carbon sources; cells grown in the dark on acetate are green; cells incapable of using NO_3 as a N source; cells spherical; chromatophores dumbbell-shaped.

Type species: *Chlorella protothecoides* Krüger Indiana Algal Culture Collection No. 25, Cambridge Collection No. 211/7a

It can be seen that *Euchlorella* of Wille is retained but amended and enlarged in scope to include all the autotrophic species. According to the International Rules of Nomenclature (1961) (Articles 22), the subgenus containing the type species of the genus must bear the same epithet as the genus. Three subgenera are reduced to synonymy. The subgenus *Auxenchlorella* is erected to include all of the auxenotrophic species. Although future discoveries may cause a revision of the subgeneric characters, it is to be expected that the ultimate character sustaining the dichotomy will be the requirement for vitamins.

DESCRIPTIONS OF SPECIES

The organisms in this section include both new species and those which have been described previously. In each of the latter cases the descriptions are amended to include new data. Where possible the habitat is listed with the descriptions. However, in numerous cases the habitat of the isolates in the collection is not known. In some cases common habitats of the species described in the literature have been included. Listed at the end of the descriptions are species which have been published, but which have not been seen in this study. Undoubtedly some of these are valid and are so indicated. For others permanent rejection is necessary because of the inadequacy of the descriptions. These are also listed separately. A physiological key to the genus is given at the conclusion of the descriptions.

Subgenus *Chlorella*

Chlorella variabilis spec. nov.

(Figures 3, 4)

Cellulae semper sphaericae, 4–12 μ diametro, in mediis e glucoso constantibus cultae diametron propriorem ad 12 μ attingentes, chromatophorus paterae parum profundae formam praebens, nonnumquam parvis alveolis, nonnumquam granulatus; viridis, sed in culturis vetustis in luce in mediis vel inorganicis vel organicis vel organicis albescens. Pyrenoideum in mediis inorganicis praesens.

Bonus auctus in mediis inorganicis ex agar constantibus. In mediis inorganicis in luce bene crescit; glucosum auctum inhibet aut effectum caret; acetum quoque auctum inhibet; CO₂ auctum amplificat et inhibitionem, quae e glucoso fit, in luce superat. Alia sacchara auctum in luce non amplificant et omnia media auctum in tenebris plerumque non sustentant.

Nitras ut fons nitrogenii effectum caret; NH₃ auctum in luce sustentat; effectus acidorum aminosorum obscurus est, nonnumquam valide efficacia in luce et insuper auctum aliquantulum stimulant in tenebris, sed plerumque auctum valide inhibent in quibuslibet mediis.

Extractum saccharomycitis et thiamina in mediis vel inorganicis vel organicis auctum interdum stimulant, sed aliquando effectum carent.

Lux ad auctum per NH₄NO₃ necessaria est, sed, acidis aminosis auctum in luce stimulantibus, experimenta similia stimulationem in tenebris demonstrant.

Progenies experimento inconstans, responso variabilis et levibus in conditionibus culturae differentibus obnoxia.

Cultura typica: Indiana Algal Culture Collection No. 130, Cambridge Collection No. 211/6, a J. B. Loefer segregata.

Cells always spherical, 4–12 μ in diameter, nearer to 12 μ when grown on glucose media. Chromatophore shaped like a shallow bowl, sometimes

with small alveoli and sometimes granulated; green, but turning white in old cultures in light either on inorganic or organic media. Pyrenoid present in inorganic media.

Good growth on inorganic agar media. Grows well on inorganic media in light; glucose inhibits growth or is ineffective; acetate is also inhibitory; CO₂ enhances growth and overcomes glucose inhibition in light. Other sugars fail to enhance growth in light and all media normally fail to support growth in dark.

Nitrate does not serve as a N source; NH₃ supports growth in light; the effect of amino acids is obscure, sometimes strongly effective in light and also somewhat stimulating to growth in dark, but usually strongly inhibiting to growth with any media.

Yeast extract and thiamin sometimes stimulate growth either on inorganic or organic media, but sometimes are ineffective.

Light is essential for growth on NH₄NO₃ but, when amino acids stimulate growth in light, parallel experiments show stimulation in darkness.

A strain erratic in test, extremely variable in response and sensitive to slight differences in culture conditions.

Type culture: Indiana Algal Culture Collection No. 130, Cambridge Collection No. 211/6, by Loefer from *Paramecium* (Loefer, 1936)

This organism bears the name of *Chlorella paramecii* Loefer in the Indiana Algal Culture Collection. However, diligent search failed to reveal any such publication by Loefer. Dr. Loefer has confirmed the fact that he did not publish. Therefore, *Chlorella paramecii* must be a *nomen nudum*.

Chlorella variabilis is so named because of its extreme variability. Many characteristics seem clear in experiment after experiment, but, then, an exception in response will occur.

For instance, although the alga appears to be an obligate autotroph, there is some stimulatory effect of amino acids in the dark in certain experiments. Amino acids also are generally inhibitory, but occasionally they may support good growth in the light. In a similar manner, yeast extract and thiamin usually stimulate growth, but repeated tests may reveal no stimulation. Such responses indicate a strong capacity to adapt. Attempts to increase the precision of the tests by more rigorous standardization were to no avail, either because of the probability of mutation, or, because the past history of the cells has an unusually persistent effect.

The difficulty in describing such an organism is obvious. Variability is clearly a character of this species. Therefore it has been included in two parts of the diagnostic key and can be located regardless of a response to

a test known to be variable. Studies of its genetic stability are in order. Physiologists seeking reproducible data in their experiments should avoid this species.

Chlorella autotrophica spec. nov.

(Figures 5, 6)

Cellulae semper sphaericae, diametro 4–10 μ . Chromatophorus granularis, cellulas partim implens, semper viridis. Pyrenoideum praesens.

In quolibet medio ex agar constanti crescit, sed lente.

In mediis liquidis inorganicis in luce plerumque bene crescit. Glucosum effectu caret aut auctum in luce valide inhibet. Alia sacchara insigniter non stimulant, sed non inhibent etiam aliis nutrimentis inorganicis aucta. Acetas quoque auctum in luce inhibet, sed interdum fieri potest ut in acetate in tenebris colatur.

NH₃ fonti nitrogenii est, NO₂ quoque sed non tam bene. Acida aminosa pro fonte nitrogenii adhibita auctum vel inhibent vel omnino comprimunt.

Extractum saccharomycitis et thiamina auctum stimulant, praesertim cum NH₄NO₃ fons nitrogenii est.

Auctum in tenebris in glucoso tenuissimum est.

Progenies similis *Chlorellae* variabili, sed responso minus variabilis et fortiore proclivitate ad autotrophiam.

Cultura typica: Indiana Algal Culture Collection No. 580 a R. Lewin segregata.

Cells always spherical, 4–10 μ in diameter. Chromatophore granular cup-shaped, partially filling the cells, always green. Pyrenoid present.

Grows on any agar medium but slowly.

Usually grows well on inorganic liquid media in light. Glucose is ineffective or strongly inhibits growth in light. Other sugars not remarkably stimulatory, but not inhibitory even when supplemented with other organic nutrients. Acetate also inhibitory in light, but it may occasionally be grown on acetate in darkness.

NH₃ serves as a N source, NO₂ does not serve as well. Amino acids inhibit or halt growth when used as a N source.

Yeast extract and thiamin stimulate growth, especially when NH₄NO₃ is the N source.

Growth in darkness on glucose is negligible.

A strain similar to *Chlorella variabilis* but less variable in response and with a stronger tendency to autotrophy.

Type culture: Indiana Algal Culture Collection No. 580 isolated by R. Lewin.

Chlorella autotrophica appears to be the nearest to a completely obligate autotroph in the collection—hence the name. However, it should be re-

membered that some species, like *Chlorella reticulata*, also will not continue to grow in the dark even though they are capable of a few divisions after being removed from the light. They may be obligate autotrophs also, but this characteristic would not be definitely established during the duration of the tests conducted here.

This strain has been grown in sea water by Dr. V. L. Loosanoff as a food for bivalve larvae at Milford, Connecticut.

Chlorella mutabilis spec. nov.

(Figures 7, 8)

Cellulae semper sphaericae, diametro 5–12 μ , in mediis e glucoso constantibus cultae diametron propriorem ad 12 μ attingentes. Chromatophorus formam disci praebens; luteoviridis. Pyrenoideum praesens.

In agar facile non colitur, etiam cum materiis organicis.

In mediis inorganicis in luce crescit, sed lentissime. Glucosum vel effectum caret vel auctum in luce inhibet, sed interdum contra morem solitum valide stimulat; in glucoso in tenebris semper crescit. Galactosum, mannosum, fructosum et sucrosus auctum in luce et in tenebris stimulant, glucoso stimulant, fructosum tamen et sucrosus plerumque non stimulant. Acetas auctum in luce et in tenebris sustentat.

Nitras efficacior fons nitrogenii est quam NH_3 . In mediis, acida aminosae pro fonte nitrogenii continentibus auctus maior fit quam per NH_4NO_3 . Hoc idem fit glucoso in luce et glucoso saccharomycitisque extracto in tenebris adhibit.

Extractum saccharomycitae aut thiamina inefficacia nisi ut synergista ad auctum augendum cum acidis aminosae in tenebris. Haec species responso variabilis inconstansque est.

Cultura typica: Indiana Algal Culture Collection No. 24, Cambridge Collection No. 211/5a, a Pringsheim segregata.

Cells always spherical 5–12 μ in diameter, nearer to 12 μ when grown on glucose media. Chromatophore disc-shaped; yellow-green. Pyrenoid present.

Not easily grown on agar even with organic substances.

Grows on inorganic media in light, but very slowly. Glucose ineffective or inhibitory for growth in light, but sometimes atypically strongly stimulating; always grows in darkness on glucose. Galactose, mannose, fructose and sucrose stimulate growth in light and dark when glucose is stimulatory, however, fructose and sucrose are not normally stimulatory. Acetate supports growth in light and dark.

Nitrate serves more effectively than NH_3 as a N source. Better growth is obtained on media containing amino acids as a N source than on NH_4NO_3 . This is true with glucose in the light and with glucose and yeast extract in the dark.

Yeast extract or thiamin ineffective except to act as a synergist for improved growth with amino acids in the dark. This species is variable and erratic in response.

Type culture: Indiana Algal Culture Collection No. 24, Cambridge Collection No. 211/5a, isolated by Pringsheim.

Chlorella mutabilis resembles *Chlorella variabilis* in its response to tests. It shows the same variability in many characteristics. Whether this is a matter of mutation or adaptation is yet to be determined. It is also found in several places in the key to species. Enough of the characteristics are stable, however, so that it can be identified as a separate species.

This species was previously labeled *Chlorella miniata* (Naegeli) Oltmanns in the Indiana Algal Culture Collection but it cannot be this species. *Chlorella miniata* was described as turning bright red in the old cultures, a phenomenon which has never been observed in the present strain.

Chlorella nocturna spec. nov.

(Figures 9, 10)

Cellulae semper sphaericae, 5–10 μ diametro, in mediis e glucoso constantibus cultae diametron propiore ad 10 μ attingentes. Chromatophori in cellulis parvis parum profundi, formam calicis praebentes, sed in maioribus chromatophoro granulati impleti; virides sed in culturis vetustis in luce albescentes, viriditate opaca in tenebris, glucoso suppeditato. Pyrenoideum non semper praesens.

Bonus auctus in agar inorganico vel in mediis liquidis inorganicis in luce. Glucosum auctum non accelerat, in luce aliquantum inhibet; CO₂ auctum amplificat et in luce inhibitionem, quae e glucoso fit, superat; glucosum auctum in tenebris valide stimulat, plerumque auctus maior quam in luce. Nulla alia sacchara in luce stimulant praeter aliquid levis festinationis ob galactosum. Mannosum primum ad valide inhibendum in luce, nihil nisi glucosum in tenebris stimulat; acetum in tenebris stimulat.

Nitras melior fons nitrogenii quam NH₃, probabiliter est, cum cultura in mediis inorganicis colitur. Acida aminosa inefficacia ut fons nitrogenii; extractum saccharomycitis plerumque vel effectum caret vel inhibet. Thiamina paulo magis quam extractum saccharomycitis stimulat caseinae hydrolysate cum mediis e glucoso constantibus suppeditato.

Cultura typica: Indiana Algal Culture Collection No. 490, Cambridge Collection No. 211/5b, Gaffron segregata.

Cells always spherical, 5–10 μ in diameter, nearer to 10 μ when grown on glucose media. Chromatophores in small cells shallow, cup-shaped, but in larger cells filled with a granular chromatophore; green but turning white in old cultures in light; deep green in darkness when supplied glucose. Pyrenoid not always present.

Good growth on inorganic agar or inorganic liquid media in light. Glucose not accelerative, rather inhibitory in light; CO₂ enhances growth and overcomes glucose inhibition in light; glucose extremely stimulating in darkness, normally better growth is obtained than in light. No other sugars stimulate in light except some slight acceleration due to galactose. Mannose tends to be strongly inhibitory in light; only glucose is stimulating in darkness; acetate is stimulatory in darkness.

Nitrate probably serves more effectively than NH₃ as a N source when grown on inorganic media. Amino acids ineffective as a N source; yeast extract mostly ineffective or inhibitory. Thiamin is slightly more stimulating than yeast extract when supplied with casein hydrolysate on glucose media.

Type culture: Indiana Algal Culture Collection No. 490, Cambridge Collection No. 211/5b, isolated by Gaffron.

Chlorella nocturna grows especially well on glucose in the dark—better, in fact, than in light and is consequently named *nocturna*. It is different from *Chlorella mutabilis* in that it is strongly inhibited by mannose in the light, and will not utilize amino acids as a N source. This species also has been called *Chlorella miniata* (Naegeli) Oltmanns but cannot be the same species because of its failure to turn red with age.

Chlorella photophila spec. nov.

(Figures 11, 12)

Cellulae semper sphaericae, 4–9 μ diametro. Chromatophorus formam calicis praebens; viridis ad luteoviridem. Pyrenoideum praesens.

In agar crescit, interdum bene, sed saepe tenuiter. Auctus tardus.

In mediis inorganicis in luce crescit; glucosum in luce et in tenebris fonte nitrogenii inorganico vel effectu caret vel inhibet; glucosum in tenebris acido aminoso nitrogenii fonte interdum stimulat. CO₂ auctum amplificat inhibitionem, quae e glucoso fit, in luce superat. Nulla alia sacchara auctum vel in luce vel in tenebris sustentant; mannosum in luce valide inhibet, sed in luce paulum modo requisitum. Acetas auctum in tenebris non sustentat.

Tam nitras quam NH₃ fontibus nitrogenii sunt. Acida aminosa auctum melium quam NH₄NO₂ sustentant, nullis aliis nutrimentis organicis suppeditis.

Extractum saccharomycetis auctum in luce fonte nitrogenii inorganico sustentat. Thiamina leviter stimulat vel effectu caret.

Auctus tenuis in tenebris in quolibet medio.

Cultura typica: Indiana Algal Culture Collection No. 26 Cambridge No. 211/8a, a Pringsheim segregata.

Cells always spherical, 4–9 μ in diameter. Chromatophore cup-shaped; green to yellow-green. Pyrenoid present.

Grows on agar, sometimes well, but often poorly. Slow growth rate.

Grows on inorganic media in light; glucose ineffective or inhibitory in light and dark when on an inorganic N source; glucose sometimes stimulatory in dark when amino acid is the N source. CO₂ enhances growth and overcomes glucose inhibition in light. No other sugars support growth in light or dark; mannose strongly inhibitory in light. Acetate does not support growth in dark.

Nitrate and NH₃ serve equally as N sources. Amino acids support growth better than NH₄NO₃, when there are no other organic nutrients.

Yeast extract promotes growth in light on an inorganic N source. Thiamin stimulates slightly or is ineffective.

Poor growth in dark on any medium.

Type Culture: Indiana Algal Culture Collection No. 26, Cambridge Collection No. 211/8a, isolated by Pringsheim.

Chlorella photophila will not grow in the dark on glucose and acetate unless casein hydrolysate is present. It clearly is a member of the evolutionary line leading to complete autotrophy. Its epithet *photophila* suggests its affinity for light.

This culture was labeled *Chlorella pyrenoidosa* Chick in the Indiana Algal Culture Collection, but it does not show the NH₃ preference of Chick's organism.

Chlorella vulgaris Beyerinck 1890:758

(Figures 13, 14)

Cell always spherical, 4–10 μ in diameter. Chromatophore a reduced cup-shape; pea green. Pyrenoid present.

Not easily grown on agar, usually grows in a thin sheet. Slow growth rate.

Grows on inorganic media in light; glucose stimulatory in light and dark, although still with a slow growth rate. Galactose, mannose, and fructose strongly stimulate growth in light and support some growth in dark. Lactose, maltose, raffinose, and dextrin sometimes promote growth slightly in light. Acetate supports some growth in darkness.

Nitrate and NH₃ serve equally as N sources. Casein hydrolysate is generally more stimulatory than NH₄NO₃ as a N source.

Yeast extract enhances growth on glucose in either light or dark with NH₄NO₃ as a N source.

Neotype culture: Indiana Algal Culture Collection No. 257, Cambridge Collection No. 211/10d, isolator anonymous, from Delft.

Identical strain: Indiana Algal Culture Collection No. 258, Cambridge Collection No. 211/10e, from Prague.

Synonym: *Pleurococcus Beyerinckii* Artari 1892:246

This organism was only briefly described by Beyerinck in 1890 as mentioned earlier. He discussed at great length the physiological characteristics of *Chlorella vulgaris*. They were noteworthy in that peptone was an especially useful N source. It was clearly superior to NH_3 and NO_3 . We have assumed that this may have been stimulation due to amino acids. Therefore, the autotrophic *Chlorellas*, showing no stimulation in the light when supplied casein hydrolysate, are certainly not the organisms Beyerinck described as *Chlorella vulgaris*. Of the varieties tested Nos. 257, 258, 21 and 22 seem most close to Beyerinck's organism. There was some question whether the isolates listed as 211/11d and 211/11e now in Göttingen grow in the same manner as those from Indiana. When this point came to our attention fresh isolates of 257 and 258 were obtained from Indiana and reexamined. They showed the same strong autotrophic growth described here as characteristic of the species. The only remaining discrepancy is Beyerinck's reference to the chromatophore as a segment of a sphere. In the present organisms the chromatophore seems more reduced. Considering the optics at Beyerinck's disposal, the difference between a reduced-cup and a segment of a sphere would be very difficult to resolve. Furthermore, the cells described by Beyerinck were 2–6 μ which corresponds well with the size of our strain. This strain had been labeled *Chlorella variegata* Beyerinck in the Indiana Culture Collection. However, it does not exhibit the variability with regard to color which is characteristic of this species.

Chodat (1913) reports that his study of *Pleurococcus Beyerinckii* Artari indicates synonymy with *Chlorella vulgaris* (Brandt) Beyerinck.

Chlorella vulgaris var. *luteoviridis* (Chodat) comb. nov.

Chodat, R. 1913. Monographie d'algues en culture pure.

Materiaux Flore Cryptogamique Suisse. Vol. 4, p. 107.

(Figures 15, 16)

Cellulae semper sphaericae, 4–10 μ diametro. Chromatophorus formam disci praebens; viridis ad luteoviridem. Pyrenoideum praesens.

In mediis culturae inorganicis facile non colitur. Etiam in mediis organicis auctus tardus.

In mediis liquidis inorganicis crescit. Glucosum auctum in luce stimulat et bonum auctum in tenebris efficit. Mannosum, fructosum, et sucrosam in luce et in tenebris stimulant; galactosum auctum tenuem in tenebris sustentat. Acetas et in luce et in tenebris stimulat.

Ammonia et nitras ut fontes nitrogenii usurpata, sed NO_3 in luce, glucoso

suppeditato, magis quam NH_3 stimulat. Auctus semper melior caseinae hydrolysate potius pro fonte nitrogenii quam NH_4NO_3 usurpato. Cultura viridior in caseinae hydrolysate.

Extractum saccharomycitis auctum in mediis inorganicis accelerat; thiamina in loco extracti saccharomycitis substitui non potest.

Cultura neotypica: Indiana Algal Culture Collection No. 22, Cambridge Collection No. 211/3, nescitur a quo segregata sit, ex Baarn.

Eaedem progenies: Indiana Algal Culture Collection No. 21, Cambridge Collection No. 211/2a, et Indiana Algal Culture Collection No. 248, Cambridge Collection No. 211/26

Cells always spherical, 4–10 μ , in diameter. Chromatophore disc-shaped; green to yellow-green. Pyrenoid present.

Not easily grown on inorganic culture media. Low growth rate even on organic media.

Grows on inorganic liquid media. Glucose stimulates growth in light and gives good growth in darkness. Mannose, fructose and sucrose inhibitory in light and dark; galactose supports weak growth in dark. Acetate usually stimulatory both in light and darkness.

Ammonia and nitrate both utilized as N sources, but NO_3 is more stimulatory than NH_3 in light when glucose is supplied. Always better growth when casein hydrolysate is the N source than when NH_4NO_3 is employed. Culture is greener in casein hydrolysate.

Yeast extract accelerates growth on inorganic media; thiamin not replaceable for yeast extract.

Neotype culture: Indiana Algal Culture Collection No. 248, Cambridge Collection No. 211/2b isolator anonymous, from Baarn.

Identical strains: Indiana Algal Culture Collection No. 21, Cambridge Collection No. 211/2a and Indiana Algal Culture Collection No. 22, Cambridge Collection No. 211/3.

Synonyms: *Chlorella luteoviridis* Chodat 1913:107
Chlorella aureoviridis Meyer 1932:510.

Chlorella vulgaris variety *luteoviridis* appears to be an organism physiologically similar to Chodat's *Chlorella luteoviridis* which was the label applied to the culture in the Indiana Algal Culture Collection. However, Chodat described the chromatophore as netlike which is not the case with this organism. In order to preserve the name and to show the very close affinity of this strain to *Chlorella vulgaris*, the species is lowered to varietal status.

Chlorella aureoviridis Meyer was described as being a strain quite similar to *Chlorella luteoviridis* Chodat in that it had a tendency to turn yellow on media containing sugars. The only differences were that the chromatophore was more variable in *C. aureoviridis* than in *C. luteoviridis*, and that the membrane of *C. aureoviridis* was stronger. Meyer, himself, speculated that this strain might not be an independent species. In view of the absence of this strain from collections and the similarity to *C. luteoviridis*, it is reduced to synonymy. Meyer's species was based on Indiana Algal Culture Collection No. 22, isolated by Kluyver.

Chlorella miniata (Naegeli) Oltmanns

(Figures 17, 18)

Cells always spherical, 6–15 μ in diameter, nearer to 15 μ when grown on glucose media. Chromatophore large, homogeneous, granular, or very large and parietal; sometimes green on inorganic or organic agar media, but mostly golden, turning color differently in different media, but usually to light brown or golden brown.

Grows well on inorganic or glucose agar media.

Grows on inorganic liquid media turning brown as the culture ages. Glucose, galactose, mannose, fructose and sucrose stimulatory in light and darkness; lactose and raffinose sometimes weakly enhance growth in light; arabinose inhibits growth in light; acetate slightly stimulatory in light, no growth in dark.

Nitrate always supports growth better than NH_3 . Casein hydrolysate is a better source of N than NH_4NO_3 .

Yeast extract or thiamin does not accelerate growth.

Often growing on walls and flower pots.

Neotype culture: Indiana Algal Culture Collection No. 32, Cambridge Collection No. 211/14, isolated by Dönz.

Synonyms: *Chlorella zopfingiensis* Dönz 1934: 128

The changes in color of *Chlorella miniata* which accompany aging permit its retention as a good species although other diagnostic characters are missing. The neotype culture was labeled *Chlorella zopfingiensis* Dönz in the Indiana Algal Culture Collection, but Dönz's paper gives no clear features not described for the earlier species. Figure 86 illustrates the color variations obtained on different media. It shows clearly the loss of chlorophyll on glucose whenever NH_3 is present in the medium either from NH_4NO_3 or from casein hydrolysate. However a good green color is retained when the N source is NO_3^- .

Chlorella emersonii spec. nov.

(Figures 19, 20)

Cellulae sphaericae vel ellipsoideae, 4–16 μ diametro, in mediis e glucoso constantibus cultae diametron propiorem ad 16 μ attingentes. Chromatophorus reticulatus; viridis sed ad fulvum colorem vetustate et absentia nitrogenii vertens. Pyrenoideum semper praesens.

In mediis ex agar constantibus auctus bonus. Auctus rapidus.

In mediis inorganicis in luce bene crescit; glucosum fonte nitrogenii inorganico vel organico auctum in luce valide stimulat; mannosum et fructosum auctum in luce et in tenebris valide stimulant; sucrosus tantum in luce stimulat. Acetas auctum in luce aliquantum inhibet et in tenebris effectu caret.

Nitras et NH_3 fontibus nitrogenii pariter sunt. Caseinae hydrolysas ut fons nitrogenii auctum melius quam NH_4NO_3 sustentat.

Extractum saccharomycitidis effectu caret et in mediis e glucoso constantibus suppeditatum auctum nonnumquam leviter inhibet.

Auctus in tenebris semper tardissimus. Omnis auctus in quolibet medio post tres quattuorve dies in tenebris desinit.

Cultura neotypica: Maryland Culture Collection No. 2, ab Emerson segregata, ut videtur.

Cells spherical or ellipsoidal, 4–16 μ in diameter, nearer to 16 μ when grown on glucose media. Chromatophore netlike; green but turning to brown with age and in the absence of nitrogen. Pyrenoid always present.

Good growth on agar media, good growth rate.

Grows well on inorganic media in light; glucose strongly stimulates growth in light on inorganic or organic sources; mannose and fructose also strongly stimulatory in light and dark; sucrose stimulates only in light. Acetate inhibits growth somewhat in light and is ineffective in dark.

Nitrate and NH_3 serve equally as N sources. Casein hydrolysate supports growth better than NH_4NO_3 as a N source.

Yeast extract ineffective and sometimes slightly inhibitory when supplied on glucose media.

Dark growth always very slow. All growth stops after 3 to 4 days in the dark on any medium.

Neotype culture: Maryland Culture Collection No. 2, isolator presumably Emerson.

This is the strain used in many studies as the "Emerson strain of *Chlorella vulgaris* Beyerinck." It was obtained for the collection at Maryland from Dr. van Niel. The fact that it stops growth completely after 3 to 4 days in the dark makes it impossible that it could be the same strain as the one in the hands of Beyerinck when he described *Chlorella vulgaris*.

This organism is almost as complete an autotroph as *Chlorella autotrophica*. It will grow for only a brief time in total darkness. Its principal

sterol is chondrillasterol (Patterson, 1963). The net-like chromatophore is best seen when the N-source is NH_4NO_3 , otherwise it may appear mantle-shaped.

Chlorella emersonii var. *globosa* var. nov.

(Figures 21, 22)

Cellulae sphaericae, 5–14 μ diametro, in mediis e glucoso constantibus cultae diametron propiorem ad 14 μ attingentes. Chromatophorus forma reticulata; viridis, ad colorem aureofulvum vetustate et in mediis liquidis nitrogenii egenis vertens. Pyrenoideum semper praesens.

Bonus auctus in mediis inorganicis ex agar constantibus.

In mediis inorganicis in luce bene crescit; glucosum auctum in luce et in tenebris stimulat. Mannosum fructosumque auctum in luce stimulant et auctum tenuem in tenebris sustentant. Sucrosom auctum in luce sustentat. Galactosum auctum in luce tenuiter stimulat, in tenebris non stimulat. Acetas in tenebris inefficax.

Nitras et NH_3 fontibus nitrogenii pariter sunt. Caseinae hydrolysis ut fons nitrogenii meliorem auctum sustentat quam NH_4NO_3 in quibuslibet mediis. Extractum saccharomycitis thiaminaque inefficacia sunt.

Cultura typica: Indiana Algal Culture Collection No. 252, Cambridge Collection No. 211/8c, ab Emerson segregata.

Cells spherical, 5–14 μ in diameter, nearer to 14 μ when grown on glucose media. Chromatophore net-like shaped; green, turning to golden brown with age and when on N-deficient liquid media. Pyrenoid always present.

Good growth on inorganic agar media.

Grows well on inorganic media in light; glucose stimulates growth in light and darkness. Mannose and fructose stimulate growth in light and support weak growth in darkness. Sucrose supports growth in light. Galactose stimulates growth weakly in light, no stimulation in dark. Acetate ineffective in darkness.

Nitrate and NH_3 serve equally as N sources. Casein hydrolysate supports better growth than NH_4NO_3 as a N source on any media.

Yeast extract and thiamin are ineffective.

Type culture: Indiana Algal Culture Collection No. 252, Cambridge Collection No. 211/8c, isolated by Emerson.

Chlorella emersonii var. *globosa* is very similar to the type variety. The name *globosa* signifies the cell shape of this variety, which is in contrast to the ellipsoidal shape of the type variety. However, it does show a response to yeast extract by growing faster when it accompanies glucose on organic media. It was labeled *Chlorella pyrenoidosa* Chick in the Indiana Algal Culture Collection, but this is in error because it demonstrates no preference for NH_3 , is smaller and turns orange with age. Robert Emerson isolated

this organism from tapwater in Berlin in 1926. The net-like chromatophore in the variety is also seen as a mantle under other conditions of culture.

Chlorella saccharophila (Krüger) Migula

(Figures 23, 24)

Cells spindle-shaped, 6–12 μ in length and 2–6 μ in width, nearer to 12 μ in length and 6 μ in width, tending to become spherical when grown on glucose media. Chromatophore net-like shaped; always green. Pyrenoid present.

Grows well on inorganic media in light. Glucose stimulates strongly in light and dark. Galactose, mannose, fructose and sucrose stimulatory in light; weak growth on mannose, fructose and sucrose in darkness. Acetate ineffective in light and not stimulatory in darkness.

Nitrate and NH_3 serve equally as N sources. Casein hydrolysate utilized somewhat better than NH_4NO_3 . Accelerated by an amino acid supply.

Yeast extract or thiamin ineffective.

In nature found often in the sap of maple trees, especially near wounds.

Isotype culture: Indiana Algal Culture Collection No. 27, Cambridge Collection No. 211/9, isolated by Krüger.

Chlorella saccharophila can be identified by the spindle shape of the cells and by the strong growth on glucose in either light or dark. It is similar to *Chlorella emersonii* var. *globosa*, but it never turns brown with age.

Chlorella regularis (Artari) Oltmanns

(Figures 25, 26)

Cells spherical, 5–11 μ in diameter, nearer to 11 μ when grown on glucose. Chromatophore parietal, mantle-shaped; always deep green. Pyrenoid present.

Grows easily on agar even without an organic carbon supply.

Good growth in inorganic liquid media. Glucose strongly stimulatory either in light or in dark. Galactose and fructose stimulatory in light or dark, mannose ineffective, occasionally supports growth slightly in light. Acetate stimulates growth weakly in light and supports some growth in darkness.

Ammonia and NO_3 utilized equally. Casein hydrolysate utilized as a N source, but growth is never superior to that in NH_4NO_3 .

Neotype culture: Indiana Algal Culture Collection No. 262, Cambridge Collection No. 211/11g, isolated by Winokur.

Identical strain: Indiana Algal Culture Collection No. 397.

Chlorella regularis was described by Artari rather poorly. However his description of the chromatophore fits our species well. The physiological characters attributed to it by Oltmanns do not eliminate the possibility that it is the organism at hand. In the interest of preserving as many of the older names as possible, *Chlorella regularis* is retained in part because its description matches a typical deep green, rapidly growing *Chlorella* which also grows well in darkness. It is at a midpoint in evolution between the obligate autotrophs and those species which are very likely to lose their chlorophyll and become completely heterotrophic.

This organism was incorrectly labeled in the Indiana Algal Culture Collection as *Chlorella vulgaris* Beyerinck. Indiana Culture Collection No. 397 was used in experiments reported by Craig and Trelease (1937) and Granick (1948).

Chlorella regularis (Artari) Oltmanns var. *umbricata* var. nov.

(Figures 27, 28)

Cellulae semper sphaericae, 5–12 μ diametro, in mediis e glucoso constantibus cultae diametron propiorem ad 12 μ attingentes. Chromatophorus parietalis, amiculi formam praebens; semper viridis opaca viriditate. Pyrenoidum praesens.

In agar rapide crescit etiam sine ulla materia organica.

Media liquida inorganica bonum auctum in luce sustentant. Glucosum auctum valide amplificat ita ut culturas virides opaca viriditate vel in luce vel in tenebris producat. Galactosum fructosumque auctum in luce et in tenebris stimulant. Mannosum in luce effectu caret et in tenebris nihil auctus. Lactosum in luce inefficax, sed aliquid auctus in tenebris sustentat. Acetas quoque auctum in tenebris stimulat.

Ammonii nitras et caseinae hydrolysas ut fons nitrogenii pariter usurpata, sed caseinae hydrolysas cum extracto saccharomycitis aut cum glucoso in luce et in tenebris auctum aliquantum interdum inhibet.

Extractum saccharomycitis aut thiamina in quibuslibet mediis inefficacia. Luce opus non est cum in medio e glucoso constanti colitur et auctus in tenebris tantus est quantus auctus in luce.

Cultura typica: Indiana Algal Culture Collection No. 398.

Cells always spherical, 5–12 μ in diameter, nearer to 12 μ when grown on glucose media. Chromatophore parietal, mantle-shaped; always deep green. Pyrenoid present.

Grows rapidly on agar even without any organic supply.

Inorganic liquid media supports good growth in light. Glucose strongly enhances growth producing deep green cultures either in light or in darkness. Galactose and fructose stimulate growth in light and darkness. Mannose is ineffective in light and there is no growth in the dark. Lactose is ineffective in light but supports some growth in the dark. Acetate also stimulatory in darkness.

Ammonium nitrate and casein hydrolysate are equally utilized as N sources, but casein hydrolysate is sometimes rather inhibitory with yeast extract or glucose in light and darkness.

Yeast extract or thiamin ineffective in any media. Light not essential when grown on a glucose medium and dark-growth is as great as light-growth.

Type culture: Indiana Algal Culture Collection No. 398.

The variety *umbricata* is very close in structure and physiology to the type variety. It is different in being stimulated by lactose in the dark. It is named *umbricata* to suggest that light does not enhance growth on glucose. This is in contrast to the next variety, *aprica*, where light does stimulate the organism to more rapid growth even when glucose is supplied.

This is the variety used by Pratt (1941) in his attempt to produce an ideal inorganic culture solution.

Chlorella regularis (Artari) Oltmanns var. *aprica* var. nov.

(Figures 29, 30)

Cellulae semper sphaericae, 5–13 μ diametro, in mediis e glucoso constantibus cultae diametron propiore ad 13 μ attingentes. Chromatophorus parietalis, amiculi formam praebens; semper viridis opaca viriditate. Pyrenoideum praesens.

Bonus auctus in mediis liquidis inorganicis. Glucosum bonum auctum in luce sustentat et aliquid auctus in tenebris. Galactosum fructosumque auctum in luce et in tenebris stimulant. Mannosum effectum caret sed non inhibet. Aliquid auctus in lactoso in tenebris. Acetas auctum in luce et in tenebris amplificat.

Ammonia et NO_3 ut fontes nitrogenii pariter usurpata. Caseinae hydrolysis meliorem auctum quam NH_4NO_3 nonnumquam sustentat.

Thiamina inefficax. Extractum saccharomycitis auctum in mediis e glucoso constantibus stimulat.

Auctus in glucoso non est tam bonus in tenebris quam in luce.

Cultura typica: Indiana Algal Culture Collection No. 263, Cambridge Collection No. 211/11h.

Cells always spherical, 5–13 μ in diameter, nearer 13 μ when grown on glucose. Chromatophore parietal, mantle-shaped; always deep green. Pyrenoid present.

Good growth on inorganic liquid media. Glucose supports good growth in light and some growth in darkness. Galactose and fructose stimulate growth in light and dark. Mannose ineffective but not inhibitory. Some growth in lactose in darkness. Acetate promotes growth in light and dark.

Ammonia and NO_3 utilized equally as N sources. Casein hydrolysate may support better growth than NH_4NO_3 .

Thiamin ineffective. Yeast extract stimulates growth on glucose media.

Growth on glucose in the dark is not as great as in the light.

Type culture: Indiana Algal Culture Collection No. 263, Cambridge Collection No. 211/11h.

The two varieties of *Chlorella regularis* may be isolates of the original strain from the laboratory of Dr. Trelease. Both var. *umbricata* and var. *aprica* appear to have been involved in work by Dr. Pratt. However, only var. *aprica* was sent directly to the Cambridge Collection with the note that it was the source of chlorellin (Pratt *et al.* 1945). The physiological differences between the three varieties are very slight and their genetic constitution must be quite similar.

Chlorella sorokiniana spec. nov.

(Figures 31, 32)

Cellulae sphaericae aut ellipsoideae in mediis liquidis inorganicis, $3 \times 2 \mu$ in cellulis parvis ad $4.5 \times 3.5 \mu$ in cellulis magnis, saepe sphaericae factae, 4.5 ad 5.5μ diametro in glucoso cultae. Chromatophorus parum profundus, paterae formam praebens; viridis sed in vetustis culturis inorganicis albescens, atque etiam celerius in mediis e glucoso constantibus. Pyrenoidium praesens.

In agar celeriter sine nutrimentis organicis crescit.

Bonus auctus in mediis liquidis inorganicis. Glucosum bonum auctum in luce et aliquid auctus in tenebris sustentat. Galactosum auctum in luce stimulat et in tenebris tenuiter stimulat. Mannosum auctum plerumque inhibet aut fieri potest ut parum aut nihil auctus sustentet. Alia sacchara inefficacia. Acetas auctum in tenebris nonsustentat.

Ammonia et nitras pariter usurpata. Caseinae hydrolysas ut fons nitrogenii auctum sustentat melius quam NH_4NO_3 .

Extractum saccharomycitis tantum leviter efficax, thiamina inefficax. Auctus maximus 9.2 duplicationum in die, temperatura 39°C .

E rivo in statu Texas segregata.

Ut plura indicia diagnostica habeas, vide Sorokin (1959).

Cultura typica: Maryland Culture Collection No. 7-11-05 a C. A. Sorokin segregata.

Cells spherical or ellipsoidal in inorganic liquid media, $3 \times 2 \mu$ in small cells to $4.5 \times 3.5 \mu$ in large cells, often becoming spherical, 4.5 to 5.5μ in diameter when grown on glucose. Chromatophore shallow, bowl-shaped; green but turning white in old inorganic cultures, and even more quickly on glucose media. Pyrenoid present.

Grows rapidly on agar without organic nutrients.

Good growth on inorganic liquid media. Glucose supports good growth in light and some growth in darkness. Galactose stimulates growth in light and weakly stimulates it in darkness. Mannose usually inhibits growth or may support little or no growth. Other sugars not effective. Acetate supports no growth in darkness.

Ammonia and nitrate utilized equally. Casein hydrolysate as a N source supports growth better than NH_4NO_3 .

Yeast extract only slightly effective, thiamin not effective.

Maximum growth rate of 9.2 doublings per day at 39° C.

Isolated from a stream in Texas.

For further physiological diagnosis see Sorokin (1959).

Type culture: Maryland Culture Collection No. 7-11-05 isolated by C. A. Sorokin.

This species is named after its isolator, Dr. Constantine Sorokin, who has published more detailed information about this species of *Chlorella* (as *Chlorella pyrenoidosa* Chick, strain 7-11-05) than exists for any other. It was isolated from a sample collected on June 10, 1951, from Waller Creek on the University of Texas campus in Austin, Texas. It appears to be closely related, because of its rapid growth rate, to the vigorously growing *Chlorella regularis*, but its ability to grow with great rapidity at high temperatures warrants giving it the rank of species.

Chlorella vanniellii spec. nov.

(Figures 33, 34)

Cellulae semper sphaericae, 3–13 μ diametro, in mediis e glucoso constantibus cultae diametron propiorem ad 13 μ attingentes. Chromatophorus paterae profundae formam praebens; semper viridis. Pyrenoideum praesens sed non semper evidens.

Bonus auctus in agar aut in quolibet medio in luce.

In mediis inorganicis in luce bene crescit, glucosum auctum in luce stimulat, sed tantum tenuiter in tenebris. Galactosum auctum in luce amplificat sed in tenebris tantum tenuiter, mannosum auctum in luce inhibet, alia sacchara inefficacia. Acetas auctum in luce non stimulat et in tenebris non sustentat.

Nitras auctum melius quam ammonia ut fons nitrogenii semper sustentat, Caseinae hydrolysas et NH_4NO_3 fontibus nitrogenii pariter sunt.

Extractum saccharomycitis et thiamina inefficacia.

Auctus in tenebris semper tenuis.

Cultura typica: Maryland Culture Collection No. 1, a van Niel segregata.

Cells always spherical, 3–13 μ in diameter, nearer to 13 μ when grown on glucose media. Chromatophore deep bowl-shaped; always green. Pyrenoid present, but not always evident.

Good growth on agar or on any medium in light.

Grows well on inorganic media in light, glucose stimulatory in light, but weakly so in the dark. Galactose enhances growth in light but only weakly in the dark, mannose inhibits growth in light, other sugars ineffective. Acetate not stimulating in light and does not support dark growth.

Nitrate always supports better growth than ammonia as a N source. Casein hydrolysate and NH_4NO_3 serve equally as N sources.

Yeast extract and thiamin ineffective.

Dark growth always poor.

Type culture: Maryland Culture Collection No. 1, isolated by van Niel.

Chlorella vanniellii is named after Dr. C. B. van Niel from whom it was obtained. It was named "van Niel's strain of *Chlorella pyrenoidosa* Chick" in many publications from the University of Maryland. It is clearly not *Chlorella pyrenoidosa* because it shows no preference for NH_3 . It fails to grow on acetate like *Chlorella regularis*, but otherwise it is quite similar in chromatophore structure and physiology. Its sterol has been shown to be ergosterol (Patterson 1963).

Chlorella infusionum Beyerinck

(Figures 35, 36)

Cells slightly ellipsoidal in inorganic liquid media, 3–4 μ in the longest diameter, tend to become spherical, nearer to 10 μ in diameter when grown on glucose media. Chromatophore incomplete, girdle-shaped, not filling the cells; always green. Pyrenoid usually but not always present.

Good growth on any agar media.

Grows very well on inorganic culture in light; glucose strongly stimulatory both in light and dark; galactose stimulatory only in light; fructose ineffective; mannose strongly inhibits growth in light. Acetate effective in light but not in darkness.

Nitrate and NH_4 serve equally as N sources. Casein hydrolysate and NH_4NO_3 also serve equally as N sources, sometimes casein hydrolysate is slightly better than NH_4NO_3 .

Yeast extract and thiamin ineffective.

Neotype culture: Indiana Algal Culture Collection No. 396, isolated by Chodat.

Identical strain: Indiana Algal Culture Collection No. 30, Cambridge Collection No. 211/12, isolated by Chodat.

Synonym: *Chlorella vulgaris* var. *viridis* Chodat 1913:88

Chlorella infusionum was described by Beyerinck as a small ellipsoidal organism of 1–4 μ . In spite of the poor description the name is employed for the small ellipsoidal organisms in the collection which have a mantle-type chromatophore and are normally autotrophic. Chodat's original strain

No. 30 is listed as identical to *Chlorella infusionum* and the earlier Beyerinck name is used for the species. Indiana Algal Culture Collection No. 396 was the isolate studied by Winokur (1948) as *Chlorella vulgaris* var. *viridis* Chodat.

Chlorella infusionum Beyerinck var. *auxenophila* var. nov.

(Figures 37, 38)

Cellulae parvae aliquantulum ellipsoideae, 3–4 μ longitudine, pronae ad formam sphericam assumendam. Cellulae maiores sphaericae, 7–12 μ diametro in mediis inorganicis, in mediis e glucoso constantibus cultae diametron propiorem ad 12 μ attingentes. Chromatophorus imperfectus, cinguli formam praebens, cellulas non implens; semper viridis. Pyrenoideum praesens.

In quolibet medio ex agar constanti in luce bene crescit.

In mediis inorganicis in luce bene crescit. Glucosum auctum in luce et in tenebris stimulat; nullum aliud saccharum auctum in tenebris sustentare potest. Galactosum et fructosum auctum in luce stimulant, mannosum auctum in luce inhibet. Acetas auctum in luce stimulat sed in tenebris effectu caret.

Nitras et NH_3 fontibus nitrogenii pariter sunt. Caseinae hydrolysas et NH_4NO_3 ut fons nitrogenii pariter usurpantur.

Extractum saccharomycitidis aut thiamina in mediis e glucoso constantibus auctum in luce aut in tenebris semper amplificant.

Cultura typica: Indiana Algal Culture Collection No. 261, Cambridge Collection No. 211/11d, Brannon segregata.

Small cells slightly ellipsoidal, 3–4 μ in length, tend to become spherical. Larger cells spherical, 7–12 μ in diameter in inorganic media, nearer to 12 μ when grown on glucose media. Chromatophore incomplete, girdle-shaped, not filling the cells; always green. Pyrenoid present.

Good growth on any agar medium in the light.

Grows well on inorganic media in light. Glucose stimulates growth in light and dark; no other sugar can support growth in darkness. Galactose and fructose stimulate growth in light, mannose inhibits growth in light. Acetate stimulatory in light, but ineffective in darkness.

Nitrate and NH_3 serve equally as N sources. Casein hydrolysate and NH_4NO_3 are equally utilized as N sources.

Yeast extract or thiamin always enhances growth on glucose media in light or darkness.

Type culture: Indiana Algal Culture Collection No. 261, Cambridge Collection No. 211/11d, isolated by Brannon.

This organism differs from the species in its response to yeast extract. Apparently an unknown factor in yeast stimulates growth of this variety. The name is intended to suggest this response although no specific vitamin requirement is identified.

Chlorella simplex (Artari) Migula

(Figures 39, 40)

Cells always spherical, 4–11 μ in diameter, nearer to 11 μ when grown on glucose media. Chromatophore shallow, bowl-shaped; always green. Pyrenoid present but not always seen.

Good growth on agar in any media in the light.

Grows well on inorganic culture in light; glucose supports good growth in light, but very little in darkness, galactose stimulatory in light, but not in darkness; mannose inhibitory in light and darkness; other sugars ineffective; acetate weakly stimulatory in light, and ineffective in darkness.

Nitrate supports better growth than ammonia. Casein hydrolysate is equal to NH_4NO_3 as a N source.

Yeast extract and thiamin are not ordinarily stimulatory, but thiamin does replace yeast extract when cultures show some stimulation.

Light strongly enhances growth on any media.

Neotype: Indiana Algal Culture Collection No. 265 Cambridge Collection No. 211/11j, isolator anonymous.

Chlorella simplex as described by Artari, Migula, and Brunthaler is a dark-green to olive-green species with a shallow bowl-like chromatophore. In view of the fact that this description, however meager, does not exclude the organism studied, the name is used and the description amended.

Chlorella ellipsoidea Gerneck

(Figures 41, 42)

Cells ellipsoidal, 5–14 μ in length and 4–10 μ in width, but increasing in size to become nearly spherical, reaching 12x14 μ when grown on glucose. Chromatophore irregular mantle-shaped often with starch grains in the dark; always green. Pyrenoid present.

Grows poorly on agar media.

Grows on inorganic culture media in light, but at a low growth rate; glucose stimulates growth strongly in light and weakly in dark; galactose, mannose and fructose stimulate growth in light and support growth slightly in dark. Sucrose, lactose, and raffinose are usually ineffective but may stimulate growth slightly in light. Acetate stimulatory in light, but ineffective in darkness.

Nitrate and ammonia serve equally as N sources. Casein hydrolysate usually ineffective.

Yeast extract or thiamin ineffective. Dark growth is slow even with glucose or amino acids.

Neotype culture: Indiana Algal Culture Collection No. 247, Cambridge Collection No. 211/1c, isolated by Rodhe.

The ellipsoidal structure of the large cells is apparent in this form and was so described by Gerneck. His description seems to fit this species very well.

Chlorella fusca spec. nov.

(Figures 43, 44)

Cellulae plerumque ellipsoideae in cultura liquida inorganica, 4.5–8 μ longitudine et 3.5–7 μ latitudine, cellulae maiores pronae ad formam sphericam assumendam in mediis inorganicis; pleraeque cellulae, cum in mediis e glucoso constantibus coluntur, sphaericae fiunt et diametron 8 μ praebent. Chromatophorus imperfectus, cinguli aut paterae profundae formam praebens; viridis ad fulvum colorem vetustate aut cum in medio haud sufficienti coluntur vertens. Pyrenoideum praesens.

Bonus auctus in quolibet medio ex agar constanti. In cultura inorganica in luce bene crescit; glucosum auctum in luce et in tenebris semper stimulat; galactosum, mannosum et fructosum auctum in luce stimulat; galactosum auctum in tenebris tantum leviter stimulat; mannosum et fructosum aliquid auctus in tenebris sustentant; alia sacchara inefficacia. Acetas auctum in luce stimulat, in tenebris effectum caret.

Ammonia aliquantum melior fons nitrogenii quam NO_3 est. Caseinae hydrolysas par NH_4NO_3 ut fons nitrogenii est.

Extractum saccharomycitidis auctum in glucoso stimulat, sed fieri potest ut in glucoso, hydrolysate caseinae suppeditato, inhibeat.

Cultura typica: Indiana Algal Culture Collection No. 343, a Lewin segregata.

Cells usually ellipsoidal in inorganic liquid culture, 4.5–8 μ long and 3.5–7 μ wide, larger cells tend to be spherical in inorganic media; most cells become spherical with a diameter of 8 μ when grown on glucose media. Chromatophore incomplete, girdle-shaped or deep cup-shaped; green turning brown with age or when cultured on N deficient media. Pyrenoid present.

Good growth on any agar medium. Grows well on inorganic culture in light; glucose always stimulatory in light and dark; galactose, mannose and fructose stimulatory in light; galactose only slightly stimulatory in dark; mannose and fructose support some growth in darkness; other sugars ineffective. Acetate stimulatory in light, ineffective in darkness.

Ammonia serves slightly better than NO_3 as a N source. Casein hydrolysate is equal to NH_4NO_3 as a N source.

Yeast extract stimulates growth on glucose, but may be inhibitory on glucose supplied with casein hydrolysate.

Type culture: Indiana Algal Culture Collection No. 343 isolated by Lewin.

Chlorella fusca is a spherical or ellipsoidal alga related to *Chlorella emersonii*. It is characterized by a brown color which develops with age and a girdle-shaped chromatophore. In contrast to *Chlorella ellipsoidea* casein hydrolysate does not stimulate growth on glucose media. It is one of the species the growth of which was not supported by sucrose. *Chlorella fusca* has a large distinct pyrenoid in contrast to the small one in *Chlorella ellipsoidea*.

Chlorella fusca var. *vacuolata*

(Figures 45, 46)

Cellulae in cultura inorganica ellipsoideae, 5.5–12 μ longitudine et 3.5–11 μ latitudine. Cellulae maiores in mediis inorganicis paene sphaericae; pleraeque cellulae in mediis e glucoso constantibus cultae formam sphericam assumentes et diametron propiorem ad 12 μ attingentes. Chromatophorus reticulatus; viridis, vetustate aut cum in medio, quod nitrogenio careat, coluntur, ad colorem fulvum vertentes. Pyrenoideum praesens.

Bonus auctus in agar inorganico; in mediis liquidis inorganicis in luce bene crescit. Glucosum auctum in luce et in tenebris stimulat. Mannosum et fructosum auctum in luce stimulant et auctum tenuem in tenebris sustentant; sucrosus in luce effectu caret. Galactosum auctum leviter tantum in luce stimulat.

Acetas auctum in luce leviter stimulat; auctum in tenebris non sustentat.

Nitras et ammonia fontibus nitrogenii pariter sunt; caseinae hydrolysis auctum melius quam NH_4NO_3 sustentat.

Extractum saccharomycitis et thiamina inefficacia.

Cultura typica: Indiana Algal Culture Collection No. 251, Cambridge Collection No. 211/8b, ab Emerson segregata.

Cells ellipsoidal in inorganic culture, 5.5–12 μ long and 3.5–11 μ wide. Larger cells almost spherical in inorganic media; most cells becoming spherical and nearer to 12 μ in diameter when grown on glucose media. Chromatophore net-like; green, turning brown with age or if cultured on N-deficient media. Pyrenoid present.

Good growth on inorganic agar; grows well on inorganic liquid media in light. Glucose stimulates growth in light and dark. Mannose and fructose stimulate growth in light and support weak growth in darkness; sucrose ineffective in light. Galactose stimulates growth slightly only in light.

Acetate slightly stimulatory in light; does not support growth in dark. Nitrate and ammonia serve equally as N sources; casein hydrolysate supports better growth than NH_4NO_3 .

Yeast extract and thiamin ineffective.

Type culture: Indiana Algal Culture Collection No. 251, Cambridge Collection No. 211/8b, isolated by Emerson.

The varietal name, *vacuolata*, refers to the strongly-vacuolate appearing chloroplast which is in fact commonly filled with large starch grains which differentiates it from the species. It is a light-green organism normally ellipsoidal in shape. Dr. Emerson isolated this species from tree bark in Philadelphia in 1923.

Chlorella pringsheimii spec. nov.

(Figures 47, 48)

Cellulae plerumque ellipsoideae 4–10 μ longitudine et 3–9 μ latitudine, sed in mediis e glucoso constantibus cultae se in formam sphericam mutant et diametron propiorem ad 10 μ attingentes. Chromatophorus parum profundus, formam paterae praebens: semper viridis. Pyrenoideum semper praesens.

In mediis ex agar constantibus crescit, sed semper tenuiter. In mediis inorganicis in luce lente crescit; glucosum vel in luce vel in tenebris stimulat, sed in tenebris tantum leviter; galactosum, mannosum, et fructosum in luce leviter stimulant, et in tenebris aut levissime stimulant aut inefficacia sunt. Acetas in luce stimulat et in tenebris inefficax.

Nitras et ammonia fontibus nitrogenii pariter sunt; caseinae hydrolysis NH_4NO_3 par est. In culturis ex agar vetere translatis, caseinae hydrolysis melior fons nitrogenii est.

Extractum saccharomycitis et thiamina inefficacia; mediis e glucoso constantibus addita raro stimulant.

Auctus tenuissimus in quibuslibet mediis in tenebris.

Cultura typica: Indiana Algal Culture Collection No. 20 Cambridge Collection No. 211/1a, a Pringsheim segregata.

Cells normally ellipsoidal 4–10 μ long and 3–9 μ wide, but changing to a spherical shape near 10 μ in diameter when grown on glucose media. Chromatophore shallow, bowl-shaped; always green. Pyrenoid always present.

Grows on agar, but always poorly. Grows slowly on inorganic media in light; glucose stimulatory in light and dark, but only slightly in dark; galactose, mannose and fructose slightly stimulatory in light, and very slightly stimulatory or ineffective in darkness. Acetate stimulatory in light and ineffective in darkness.

Nitrate and ammonia serve equally as N sources; casein hydrolysate is equal to NH_4NO_3 . In cultures inoculated from old agar slants, casein hydrolysate is a superior N source.

Yeast extract and thiamin ineffective; rarely stimulatory when supplied with glucose media.

Very poor growth on any media in darkness.

Type culture: Indiana Algal Culture Collection No. 20, Cambridge Collection No. 211/1a, isolated by Pringsheim.

Chlorella pringsheimii is a smaller ellipsoidal organism of the two described by Gerneck. It is also closely related to *Chlorella ellipsoidea*. Mannose, however, fails to support dark growth of this species. The organism was incorrectly labeled *Chlorella ellipsoidea* Gerneck in the Indiana Culture Collection. The species is named in honor of the isolator, Dr. E. G. Pringsheim.

Chlorella candida spec. nov.

(Figures 49, 50)

Cellulae semper sphaericae, 5–10 μ diametro, in mediis a glucoso constantibus cultae, diametron propiore ad 10 μ attingentes. Chromatophorus profundus paterae formam praebens; viridis, sed etiam in mediis inorganicis in luce facile albescens. Pyrenoideum praesens.

In mediis ex agar constantibus bene crescit, sed in agar ex glucoso constanti candida facile fit. In mediis inorganicis in luce crescit; interdum difficile est culturam liquidam e mediis ex agar constantibus transferre; glucosum auctum in luce stimulat, in tenebris auctum bonum sustentat; galactosum auctum tantum in luce stimulat; nulla alia sacchara auctum in tenebris sustentant. Acetas auctum in luce tenuiter stimulat, in tenebris effectu caret.

Nitras et ammonia fontibus nitrogenii pariter sunt. Caseinae hydrolysas auctum melius quam NH_4NO_3 semper sustentat.

Extractum saccharomycitis in luce inefficax, in tenebris auctum stimulat; thiamina pro extracto saccharomycitis substitui non potest.

Cultura typica: Indiana Algal Culture Collection No. 260, Cambridge Collection No. 211/11c, a Pringsheim segregata.

Eaedem progenies: Indiana Algal Culture Collection No. 259, Cambridge Collection No. 211/11b.

Cells always spherical, 5–10 μ in diameter, nearer to 10 μ when grown on glucose media. Chromatophore deep bowl-shaped; green, but turning white readily even on inorganic media in light. Pyrenoid present.

Grows well on agar, but bleaches readily on glucose agar. Grows on inorganic media in light; sometimes difficult to transfer to liquid cultures from agar media; glucose stimulatory in light, in dark it supports good growth; galactose stimulatory only in light; no other sugars support growth in light or darkness. Acetate weakly stimulatory in light, ineffective in darkness.

Nitrate and ammonia serve equally as N sources. Casein hydrolysate always supports better growth than NH_4NO_3 .

Yeast extract ineffective in light, stimulates growth in darkness; thiamin cannot replace yeast extract.

Type culture: Indiana Algal Culture Collection No. 260, Cambridge Collection No. 211/11c, isolated by Pringsheim.

Identical strain: Indiana Algal Culture Collection No. 259, Cambridge Collection No. 211/11b.

This organism stands somewhat by itself. It is always spherical and is apparently not closely related to the ellipsoidal forms. It bleaches readily when grown on glucose, and therefore resembles the species with a proclivity for heterotrophy. It grows well only on glucose in the dark. Its facility for turning white when glucose is supplied suggests the name *candida*.

Subgenus *Auxenochlorella*

Chlorella protothecoides Krüger

(Figures 51, 52)

Cells always spherical, 3–10 μ in diameter; chromatophore dumbbell-shaped; green when grown on media without a sugar supply, turning to yellow or white on sugar media both on agar and in liquid subject either to light or darkness. Pyrenoid always present.

No growth on inorganic media in light; no growth on media supplemented with any sugar in the absence of a vitamin component; casein hydrolysate sometimes stimulates growth slightly without supplements.

Thiamin always required; yeast extract replaceable by thiamin; biotin and vitamin B₁₂ cannot replace yeast extract; thiamin supports growth on inorganic media in the light.

Thiamin supports growth on glucose in light and darkness accompanied by a change in color to yellow or white. Good growth in darkness never exceeds growth in light. Thiamin also supports growth on fructose in light and darkness. Mannose strongly inhibits growth in light and darkness even with thiamin. Galactose supports growth in darkness, but is not stimulatory in the light with thiamin. Thiamin also supports some growth in acetate media in light and darkness.

Thiamin incapable of supporting growth in light on NO₃ media even with glucose; with NH₃ as a N source growth is good.

Growing in nature on the sap of trees, often around wounds.

Isotype culture: Indiana Algal Culture Collection No. 25, Cambridge Collection No. 211/7a, isolated by Krüger.

Chlorella protothecoides was described well enough by Krüger to be easily recognized. However, a number of workers, examining organisms identical to Krüger's, saw fit to publish new species names. Examination of the strains to which these names were attached in the Indiana Algal Cul-

ture Collection, indicated that they all belonged to the same species. This was true even for the strain isolated by Beyerinck, Indiana Algal Culture Collection No. 31, which he had named *Chlorella xanthella*. Fortunately, it is possible to designate Krüger's original strain as the type culture.

The species is characterized by a dumbbell-shaped chromatophore and an absolute thiamin requirement. In the absence of light the cells turn yellow or white as the chlorophyll disappears. The evolutionary tendency to heterotrophy is well developed.

Figure 59 shows the loss of chlorophyll by the alga grown on organic media in the dark. Chlorophyll is also lost in the light when casein hydrolysate is not present in the medium. Why casein hydrolysate should stimulate chlorophyll formation is an intriguing problem.

Chlorella protothecoides Krüger var. *galactophila* var. nov.

(Figures 53, 54)

Proprietates morphologicae et physiologicae similes varietati typicae sunt praeter has quae sequuntur: mannosum auctum in luce et in tenebris inhibet. Galactosum bonum auctum in luce et in tenebris sustentat.

Cultura typica: Indiana Algal Culture Collection No. 411, Cambridge Collection No. 211/7d, a Czurda segregata.

Morphological and physiological characteristics similar to the type variety except for the following: Mannose inhibits growth in light and darkness Galactose supports good growth in light and darkness.

Type culture: Indiana Algal Culture Collection No. 411, Cambridge Collection No. 211/7d, isolated by Czurda.

Chlorella protothecoides var. *galactophila* can be distinguished from the type variety, which is inhibited by mannose in the light, in that it will grow on galactose in both light and darkness. Like the type variety it will not grow on mannose in either light or darkness. The differences between varieties are slight but clearcut. In view of what is known about galactose metabolism in *Chlorella* (Galloway and Krauss 1959) this organism should be a most useful subject for study.

Chlorella protothecoides Krüger var. *communis* var. nov.

(Figures 55, 56)

Proprietates morphologicae et physiologicae similes varietati typicae sunt praeter has quae sequuntur: cum thiamina, mannosum auctum in luce leviter stimulat, sed in tenebris nihil auctus. Thiamina auctum et in luce et in tenebris caseinae hydrolysate nitrogenii fonte sustentat. Cum thiamina, galactosum auctum in luce et in tenebris sustentat.

Cultura typica: Indiana Algal Culture Collection No. 28, Cambridge Collection No. 211/10c, a Beyerinck segregata.

Eaedem progenies: Indiana Algal Culture Collection Nos. 264 (211/1i), 255 (211/10a), 256 (211/10b), 31 (211/13), 250 (211/7c), 249 (211/7b), 636.
Numeri uncis inclusi ad "Cambridge Collection" pertinent

Morphological and physiological characteristics similar to the type variety except for the following; with thiamin, mannose slightly stimulates growth in light, but there is no growth in darkness. Thiamin supports growth with casein hydrolysate as a N source in both light and darkness. With thiamin, galactose supports growth in light and darkness.

Type culture: Indiana Algal Culture Collection No. 28, Cambridge Collection No. 211/10c, isolated by Beyerinck.

Identical strains: Indiana Algal Culture Collection Nos. 264 (211/1i), 255 (211/10a), 256 (211/10b) 31 (211/13) 250 (211/7c), 249 (211/7b), 636.
Numbers in parentheses are those of the Cambridge Collection.

Synonym: *Chlorella variegata* Beyerinck 1904:14.

This variety is different from the type variety in that mannose does stimulate growth in light. Apparently this is the most common variety of the species—hence the name *communis*. Beyerinck's name, *Chlorella variegata*, represented by his own isolate, Indiana Algal Culture Collection No. 31, must be reduced to synonymy because of its identity with Krüger's species of the variety *communis*. Meyer (1933), working with a number of isolates, including Nos. 28, 255, 256, observed that this variety can show morphological as well as physiological aberrations, especially on agar. This often results in the typical variegated pattern on slants.

Chlorella protothecoides Krüger var. *mannophila* var. nov.

(Figures 57, 58)

Proprietates morphologicae et physiologicae similes varietati typicae sunt praeter has quae sequuntur: cum thiamina, mannosum aliquid auctus in luce atque in tenebris sustentat. Thiamina auctum in caseinae hydrolysate aequae in luce ac in tenebris bene sustentat. Galactosum auctum in luce stimulabit et auctum in tenebris cum thiamina sustentabit. Nullum medium viriditatem opacam producit.

Cultura typica: Indiana Algal Culture Collection No. 29, Cambridge Collection No. 211/11a, a Pringsheim segregata.

Morphological and physiological characteristics similar to the type variety except for the following: with thiamin, mannose supports some growth in light and also in darkness. Thiamin supports growth on casein hydrolysate equally well in light and darkness. Galactose will stimulate growth in the light and will support growth in darkness with thiamin. A deep green color is not obtained in any media.

Type culture: Indiana Algal Culture Collection No. 29, Cambridge Collection No. 211/11a, isolated by Pringsheim.

This variety is different from the type variety in that it apparently can utilize mannose in both light and darkness. Its name *mannophila* suggests its ability to use mannose.

Nomina inquirenda

Of the names and descriptions for *Chlorella* found in the literature there are a number which do not even remotely match any of the organisms studied. These are listed below with the reasons for their exclusion from the previous section. In some cases further isolation of organisms from nature or further study of cultures already at hand will permit inclusion of these taxa in the list of known species. In other cases the descriptions are so poor that it will never be possible to match the names with any organisms and they must be forever rejected as epithets for species of this genus.

Chlorella parasitica (Brandt) Beyerinck 1890:758
Zoochlorella parasitica Brandt 1881:143

This species, found as a symbiont in *Spongilla fluviatilis*, is not now in culture. Whether it is a good species or whether it is identical to another described here cannot be determined. Careful studies on isolates from sponges should be made to determine if it is a separate genus.

Chlorella Conductrix (Brandt) Beyerinck 1890:759
Zoochlorella Conductrix Brandt 1881:143

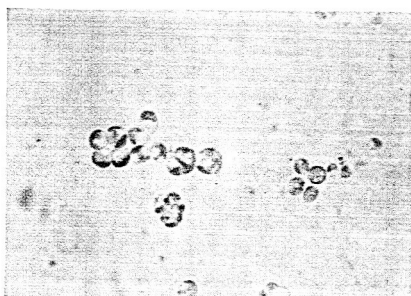
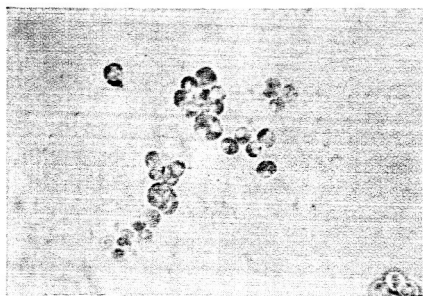
Like *Chlorella parasitica* this organism was described as a symbiont but in Hydra, Stentor, and Paramecium. It also is poorly described and does not appear to be in culture at present.

Chlorella conglomerata (Artari) Oltmanns 1904:183
Pleurococcus conglomeratus Artari 1892:244

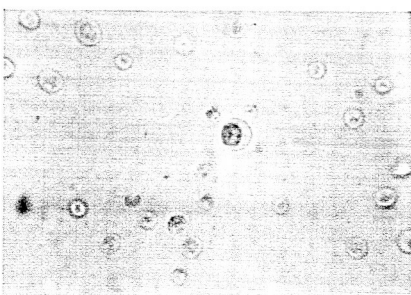
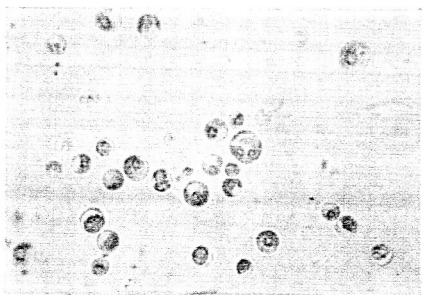
Divided cells of this species characteristically stay together in a large cell

PHOTOMICROGRAPHS OF SPECIES AND VARIETIES OF CHLORELLA AND
PHOTOGRAPHS OF PIGMENT CHANGES IN CERTAIN CULTURES

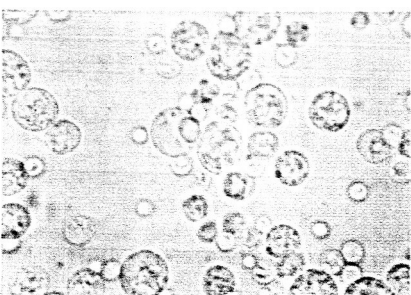
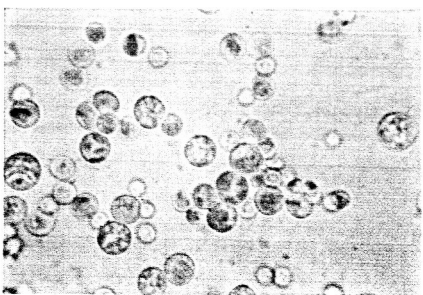
FIGURES 3-60



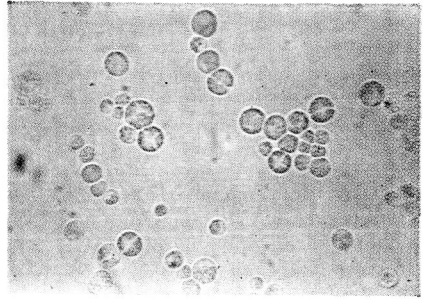
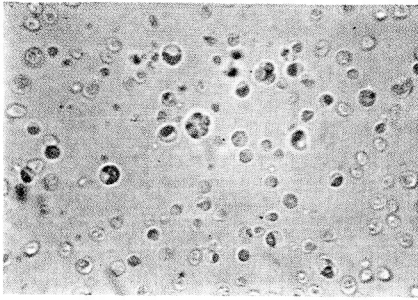
FIGURES 3, 4. *Chlorella variabilis* spec. nov. Indiana Algal Culture Collection No. 130, Cambridge Collection No. 211/6. Photographed from an actively growing liquid culture. $\times 900$. Left: Cultured on inorganic media. Right: Cultured on glucose media.



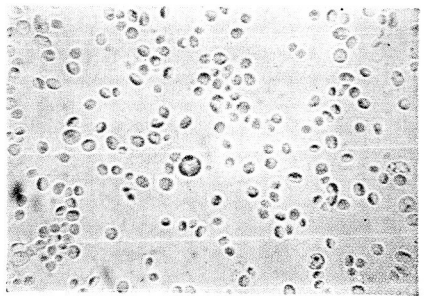
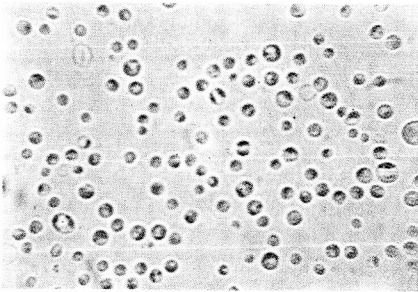
FIGURES 5, 6. *Chlorella autotrophica* spec. nov. Indiana Algal Culture Collection No. 580. Photographed from an actively growing liquid culture. $\times 900$. Left: Cultured on inorganic media. Right: Cultured on glucose media.



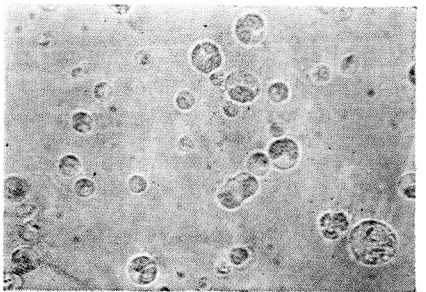
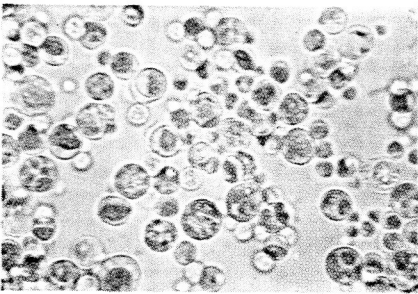
FIGURES 7, 8. *Chlorella mutabilis* spec. nov. Indiana Algal Culture Collection No. 24, Cambridge Collection No. 211/5a. Photographed from an actively growing liquid culture. $\times 900$. Left: Cultured on inorganic media. Right: Cultured on glucose media.



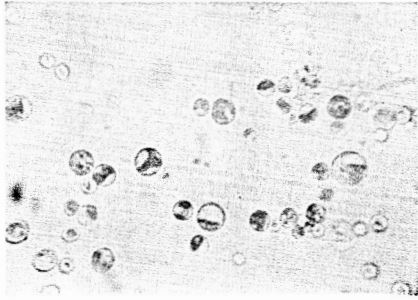
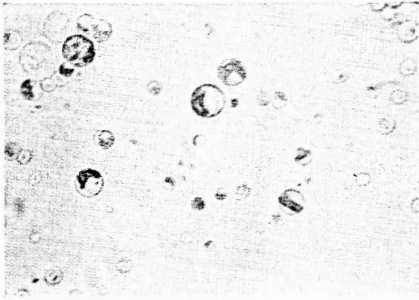
FIGURES 9, 10. *Chlorella nocturna* spec. nov. Indiana Algal Culture Collection No. 490, Cambridge Collection No. 211/5b. Photographed from an actively growing liquid culture. $\times 900$. Left: Cultured on inorganic media. Right: Cultured on glucose media.



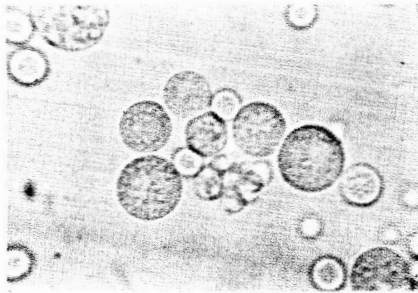
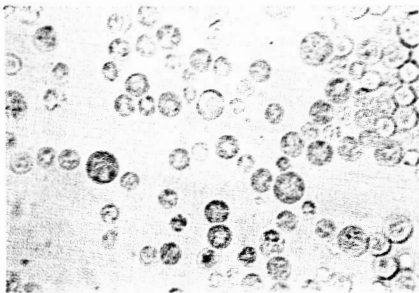
FIGURES 11, 12. *Chlorella photophila* spec. nov. Indiana Algal Culture Collection No. 26, Cambridge Collection No. 211/8a. Photographed from an actively growing liquid culture. $\times 900$. Left: Cultured on inorganic media. Right: Cultured on glucose media.



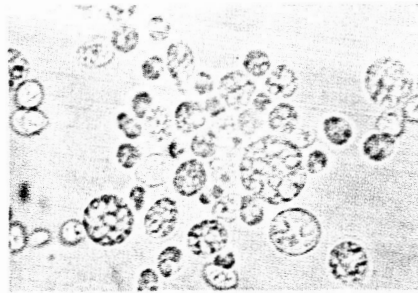
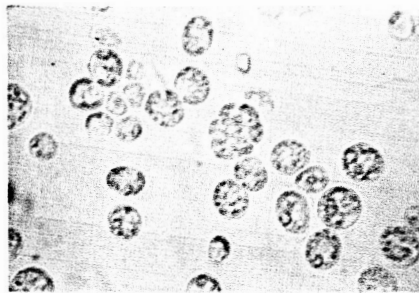
FIGURES 13, 14. *Chlorella vulgaris* Beyerinck. Indiana Algal Culture Collection No. 257, Cambridge Collection No. 211/10d. Photographed from an actively growing liquid culture. $\times 900$. Left: Cultured on inorganic media. Right: Cultured on glucose media.



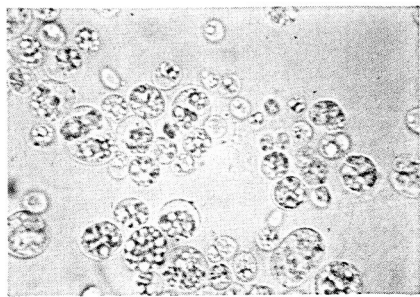
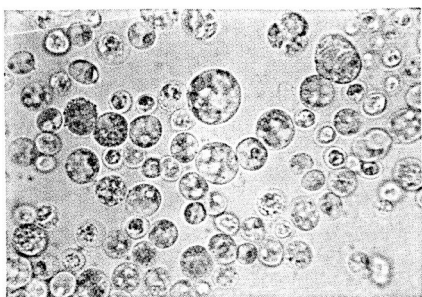
FIGURES 15, 16. *Chlorella vulgaris* Beyerinck var. *luteoviridis* (Chodat) comb. nov. Indiana Algal Culture Collection No. 248, Cambridge Collection No. 211/2b. Photographed from an actively growing liquid culture. $\times 900$. Left: Cultured on inorganic media. Right: Cultured on glucose media.



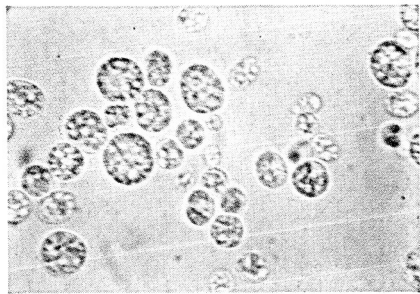
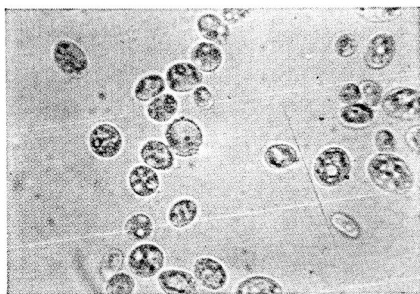
FIGURES 17, 18. *Chlorella miniata* (Naegeli) Oltmanns. Indiana Algal Culture Collection No. 32, Cambridge Collection No. 211/14. Photographed from an actively growing liquid culture. $\times 900$. Left: Cultured on inorganic media. Right: Cultured on glucose media.



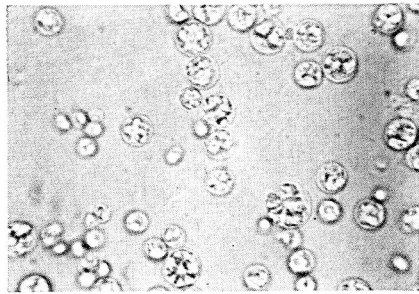
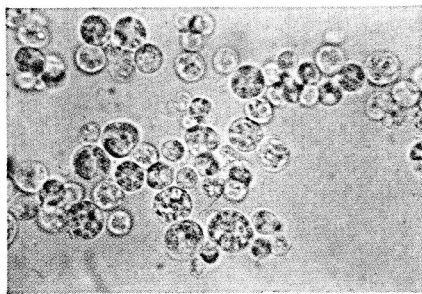
FIGURES 19, 20. *Chlorella emersonii* spec. nov. Maryland Algal Culture Collection No. 2. Photographed from an actively growing liquid culture. $\times 900$. Left: Cultured on inorganic media. Right: Cultured on glucose media.



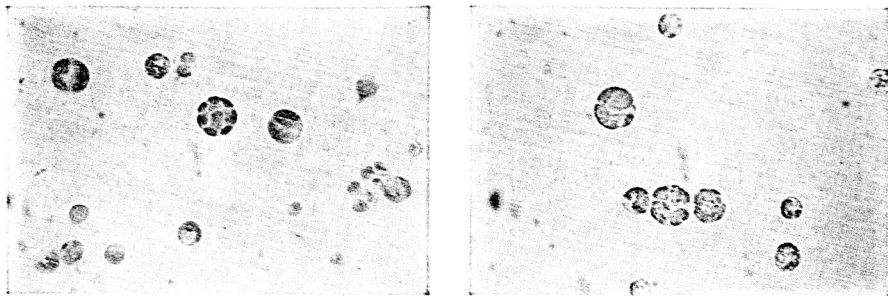
FIGURES 21, 22. *Chlorella emersonii* var. *globosa* var. nov. Indiana Algal Culture Collection No. 252, Cambridge Collection No. 211/8c. Photographed from an actively growing liquid culture. $\times 900$. Left: Cultured on inorganic media. Right: Cultured on glucose media.



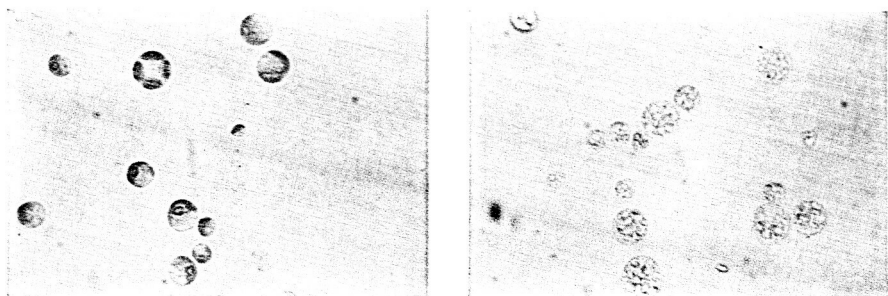
FIGURES 23, 24. *Chlorella saccharophila* Krüger. Indiana Algal Culture Collection No. 27, Cambridge Collection No. 211/9. Photographed from an actively growing liquid culture. $\times 900$. Left: Cultured on inorganic media. Right: Cultured on glucose media.



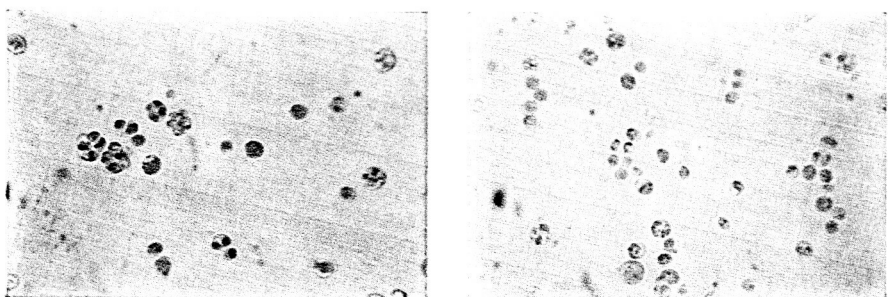
FIGURES 25, 26. *Chlorella regularis* (Artari) Oltmanns. Indiana Algal Culture Collection No. 262, Cambridge Collection No. 211/11g. Photographed from an actively growing liquid culture. $\times 900$. Left: Cultured on inorganic media. Right: Cultured on glucose media.



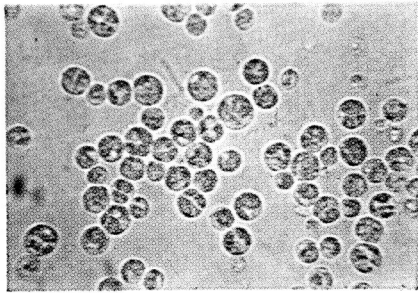
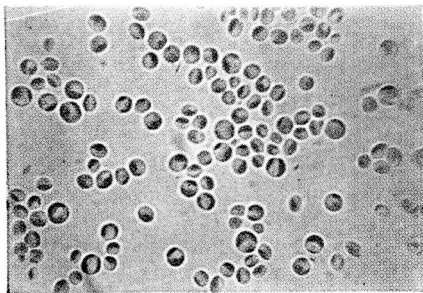
FIGURES 27, 28. *Chlorella regularis* var. *umbricata* var. nov. Indiana Algal Culture Collection No. 398. Photographed from an actively growing liquid culture. $\times 900$. Left: Cultured on inorganic media. Right: Cultured on glucose media.



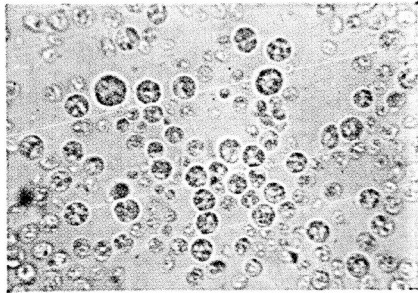
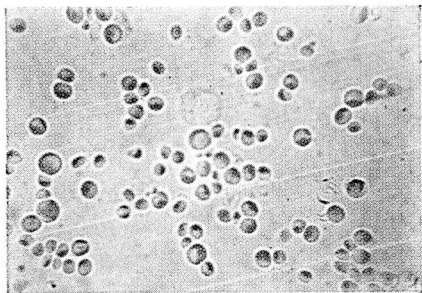
FIGURES 29, 30. *Chlorella regularis* var. *aprica* var. nov. Indiana Algal Culture Collection No. 263. Cambridge Collection No. 211/11h. Photographed from an actively growing liquid culture. $\times 900$. Left: Cultured on inorganic media. Right: Cultured on glucose media.



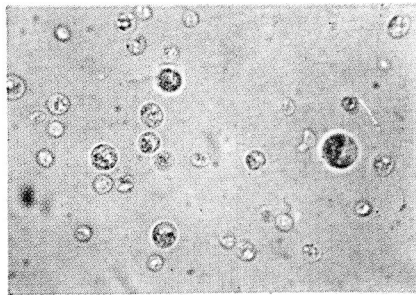
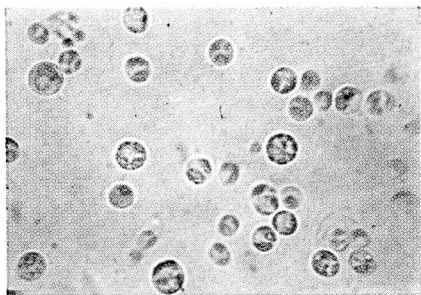
FIGURES 31, 32. *Chlorella sorokiniana* spec. nov. Maryland Algal Culture Collection No. 7-11-05. Photographed from an actively growing liquid culture. $\times 900$. Left: Cultured on inorganic media. Right: Cultured on glucose media.



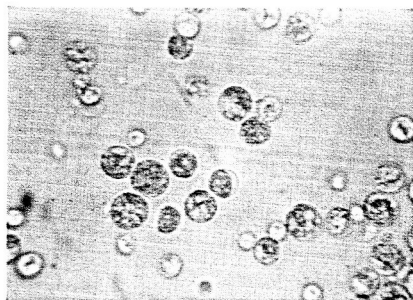
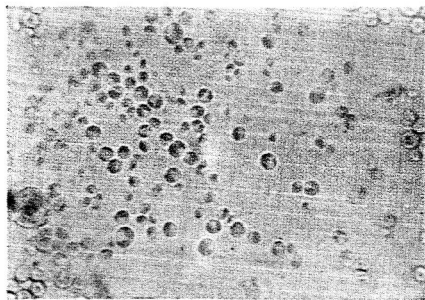
FIGURES 33, 34. *Chlorella vannielii* spec. nov. Maryland Algal Culture Collection No. 1. Photographed from an actively growing liquid culture. $\times 900$. Left: Cultured on inorganic media. Right: Cultured on glucose media.



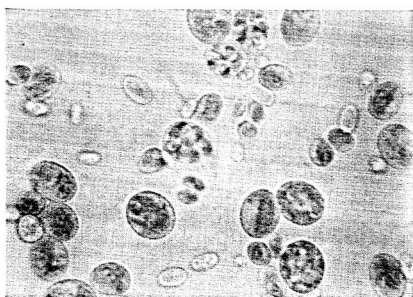
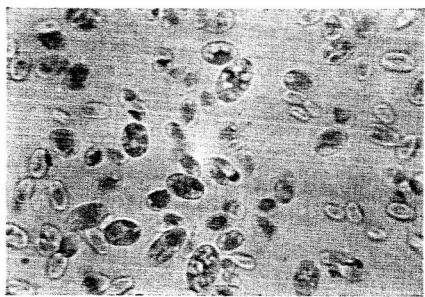
FIGURES 35, 36. *Chlorella infusionum* Beyerinck. Indiana Algal Culture Collection No. 396. Photographed from an actively growing liquid culture. $\times 900$. Left: Cultured on inorganic media. Right: Cultured on glucose media.



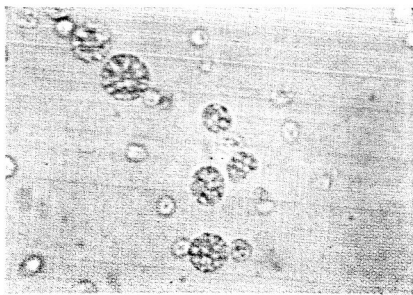
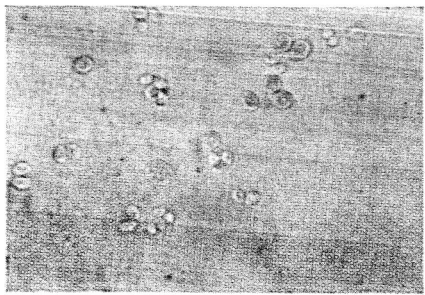
FIGURES 37, 38. *Chlorella infusionum* Beyerinck var. *auxenophila* var. nov. Indiana Algal Culture Collection No. 261, Cambridge Collection No. 211/11d. Photographed from an actively growing liquid culture. $\times 900$. Left: Cultured on inorganic media. Right: Cultured on glucose media.



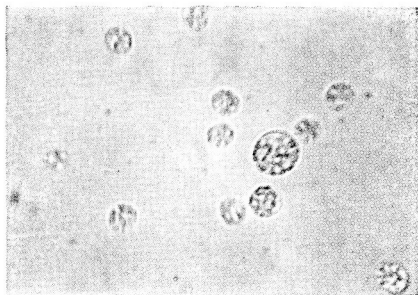
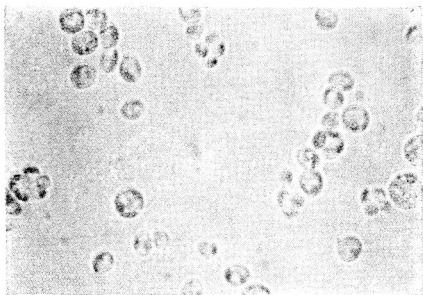
FIGURES 39, 40. *Chlorella simplex* (Artari) Migula. Indiana Algal Culture Collection No. 265, Cambridge Collection No. 211/11j. Photographed from an actively growing liquid culture. $\times 900$. Left: Cultured on inorganic media. Right: Cultured on glucose media.



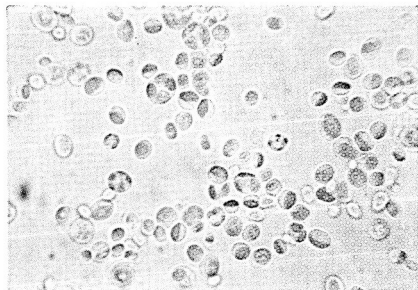
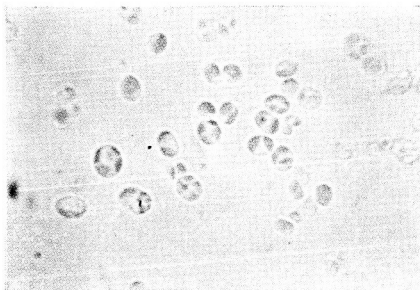
FIGURES 41, 42. *Chlorella ellipsoidea* Gerneck. Indiana Algal Culture Collection No. 247, Cambridge Collection No. 211/1c. Photographed from an actively growing liquid culture. $\times 900$. Left: Cultured on inorganic media. Right: Cultured on glucose media.



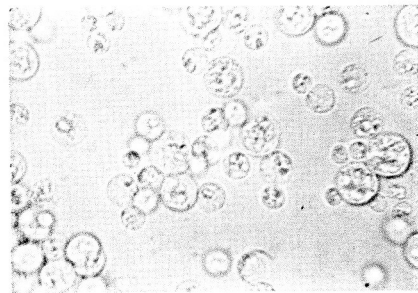
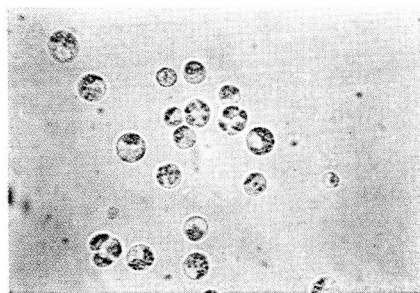
FIGURES 43, 44. *Chlorella fusca* spec. nov. Indiana Algal Culture Collection No. 343. Photographed from an actively growing liquid culture. $\times 900$. Left: Cultured on inorganic media. Right: Cultured on glucose media.



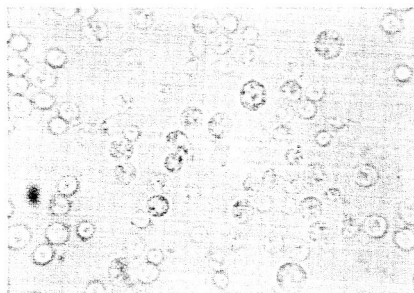
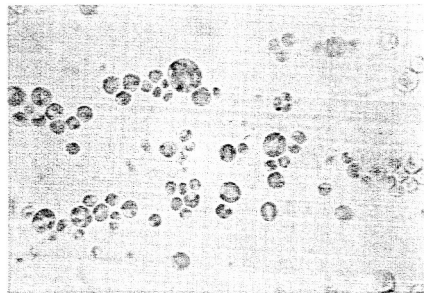
FIGURES 45, 46. *Chlorella fusca* var. *vacuolata* var. nov. Indiana Algal Culture Collection No. 251, Cambridge Collection No. 211/8b. Photographed from an actively growing liquid culture. $\times 900$. Left: Cultured on inorganic media. Right: Cultured on glucose media.



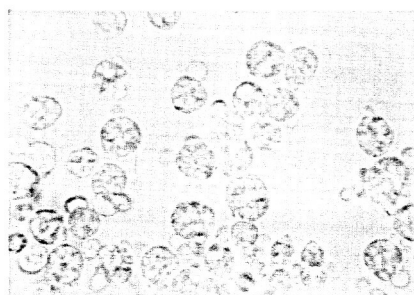
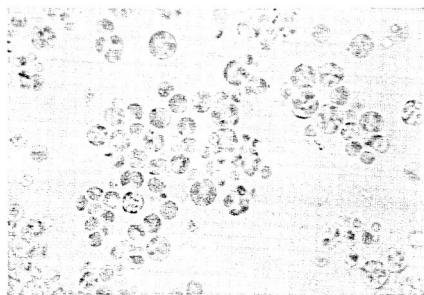
FIGURES 47, 48. *Chlorella pringsheimii* Indiana Algal Culture Collection No. 20, Cambridge Collection No. 211/1a. Photographed from an actively growing liquid culture. $\times 900$. Left: Cultured on inorganic media. Right: Cultured on glucose media.



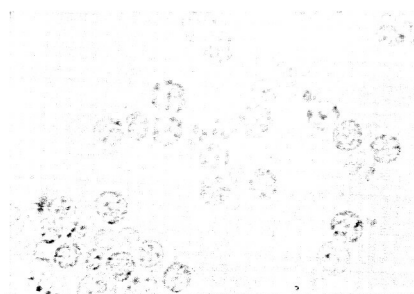
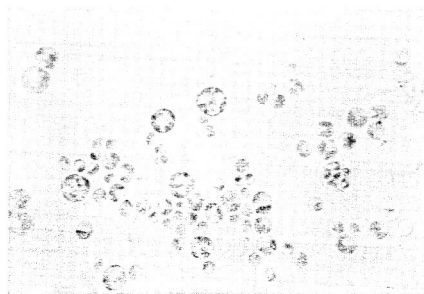
FIGURES 49, 50. *Chlorella candida* spec. nov. Indiana Algal Culture Collection No. 260, Cambridge Collection No. 211/11c. Photographed from an actively growing liquid culture. $\times 900$. Left: Cultured on inorganic media. Right: Cultured on glucose media.



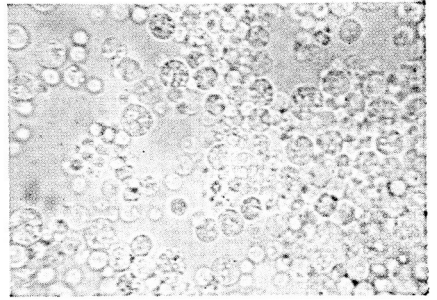
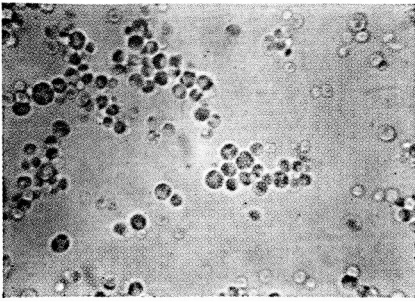
FIGURES 51, 52. *Chlorella protothecoides* Krüger. Indiana Algal Culture Collection No. 25, Cambridge Collection No. 211/7a. Photographed from an actively growing liquid culture. $\times 900$. Left: Cultured on inorganic media. Right: Cultured on glucose media.



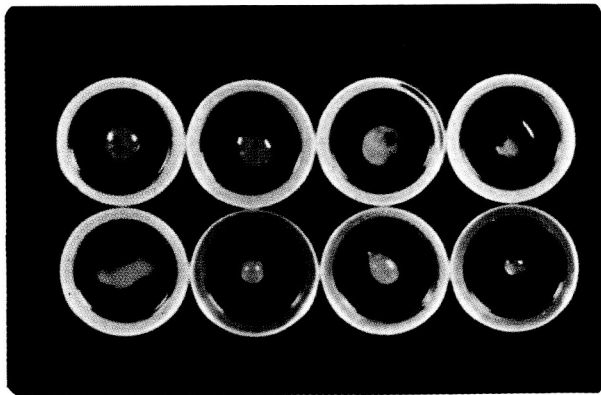
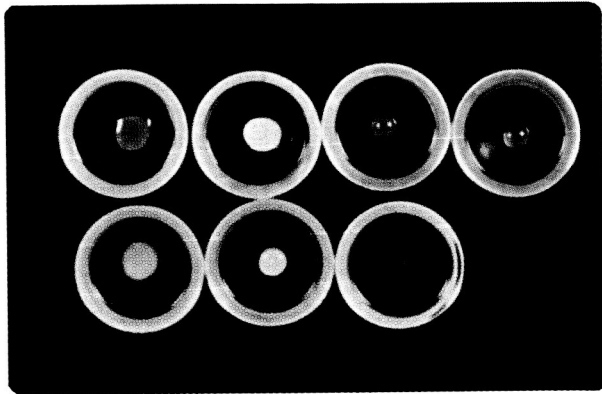
FIGURES 53, 54. *Chlorella protothecoides* Krüger var. *galactophila* var. nov. Indiana Algal Culture Collection No. 411, Cambridge Collection No. 211/7d. Photographed from an actively growing liquid culture. $\times 900$. Left: Cultured on inorganic media. Right: Cultured on glucose media.



FIGURES 55, 56. *Chlorella protothecoides* Krüger var. *communis* var. nov. Indiana Algal Culture Collection No. 28, Cambridge Collection No. 211/10c. Photographed from an actively growing liquid culture. $\times 900$. Left: Cultured on inorganic media. Right: Cultured on glucose media.



FIGURES 57, 58. *Chlorella protothecoides* Krüger var. *mannophila* var. nov. Indiana Algal Culture Collection No. 29, Cambridge Collection No. 211/11a. Photographed from an actively growing liquid culture. $\times 900$. Left: Cultured on inorganic media. Right: Cultured on glucose media.



membrane or matrix. This organism was not observed, but may exist in nature.

Chlorella pyrenoidosa Chick 1903:458

The epithet *pyrenoidosa*, given by Miss Chick in 1903, has become the most commonly used epithet in the genus. However it does not appear to be among the isolates studied here. Some of the species above evidence the marked preference for NH_3 as a N source described by Miss Chick. However these species, the *Auxenochlorella*, *Chlorella variabilis*, and *Chlorella autotrophica* are not stimulated by glucose. Furthermore all of the members of *Auxenochlorella* show a strict thiamin requirement. Just prior to the printing of this monograph an isolate matching Chick's description was obtained from a canal in Pompano, Florida. It is now in the University of Maryland Culture Collection as *Chlorella pyrenoidosa* Chick, MCC 18b. Clearly it is not as common as frequent reference to it in the literature would indicate.

FIGURE 59. Color variation cells of *Chlorella protothecoides* Krüger cultured on different media. Top: Cultured in light. Right to left: 1. On inorganic basal medium with thiamin; 2. On casein hydrolysate medium with thiamin; 3. On inorganic basal medium with glucose and thiamin; 4. On casein hydrolysate medium with glucose and thiamin. Bottom: Cultured in darkness. Right to left: 1. On casein hydrolysate medium with thiamin; 2. On inorganic basal medium with glucose and thiamin; 3. On casein hydrolysate medium with glucose and thiamin.

FIGURE 60. Color variation in cells of *Chlorella miniata* (Naegeli) Oltmanns cultured on different media in light. Top: Right to left: 1. Cultured on an inorganic medium with NH_4Cl as a N source, plus glucose; 2. Cultured on an inorganic medium with NH_4Cl as a N source; 3. Cultured on a casein hydrolysate medium with glucose; 4. Cultured on a casein hydrolysate medium with yeast extract. Bottom: Right to left: 1. Cultured on an inorganic medium with KNO_3 as a N source, plus glucose; 2. Cultured on an inorganic medium with KNO_3 as a N source; 3. Cultured on an inorganic basal medium with glucose; 4. Cultured on an inorganic basal medium with yeast extract.

Chlorella lacustris Chodat 1913:94

No species were found with the small papillae on the cell wall described by Chodat. Such a conspicuous morphological mark should be easily recognized.

Chlorella coelastroides Chodat 1913:102

Chodat described this species as one that remains clumped. None of those examined showed this characteristic. Furthermore it is listed as being able to liquefy gelatin. This is accomplished, among the species described here, only by *Chlorella fusca*.

Chlorella viscosa Chodat 1913:105

The best means of identifying this organism is that it is isolated from *Cladonia endividifolia*. None of the species examined here was known to have come from a lichen.

Chlorella lichina Chodat 1913:92

This organism, isolated from *Cladonia rangiferina*, has a rough cell wall. This characteristic does not fit any organism studied.

Chlorella Cladoniae Chodat 1913:108

This species also comes from the lichen *Cladonia rangeferina*. It cannot be identified otherwise.

Chlorella rubescens Chodat 1913:101

On glucose-agar the colonies of this species turn vivid red. Only *Chlorella miniata* turns vivid red, but its chromatophore is granular—unlike the parietal chromatophore with the conspicuous pyrenoid described by Chodat.

Chlorella faginea (Gerneck) Wille 1909:56*Aerosphaera faginea* Gerneck 1907:251

Cells of this species are described as very large reaching 50 μ with a net-like chromatophore. In the cells grown in this study 30 μ was the maximum size observed.

Chlorella spärckii Alvik 1934:31*Chlorella stigmatophora* Butcher 1952:180

Chlorella salina Butcher 1952:179

Chlorella ovalis Butcher 1952:180

Chlorella marina Butcher 1952:181

The above five species are marine *Chlorellae*, which will be discussed in a future publication. *Chlorella* is conspicuously euryhaline and whether these are indeed good species must await further examination.

Chlorella paramecii Loefer

The organism, isolated from *Paramecium* by Loefer (1936), was sent to Dr. Pringsheim at Prague, who listed it as #211/6, *C. paramecii* Loefer. According to Dr. Loefer, it has never been described. The name is, hence, a *nomen nudum*.

Chlorella caldaria (Tilden) M. B. Allen 1954:41

This species was transferred to the genus *Chlorella* by M. B. Allen (1954). However the presence of phycocyanin in the alga caused Allen (1959) to withdraw the transfer in favor of *Cyanidium caldarium* Geitler.

Chlorella Koettlitzii (Fritsch) Wille 1924:401

Pleurococcus Koettlitzii Fritsch 1912a:15

Chlorella antarctica (Fritsch) Wille 1924:399

Chlorosphaera antarcticus Fritsch 1912b:302

Wille (1924) transferred *Pleurococcus Koettlitzii* Fritsch to *Chlorella*. This seems to be correct, considering the method of cell division. Fritsch himself tentatively referred it to *Chlorella*. The description is not too helpful—the presence of an oil droplet between the cell wall and tonoplast is the only unusual feature. Wille also lists *Chlorella antarctica* which Fritsch (1921b) called *Chlorosphaera antarctica*. Culture of antarctic *Chlorellas* would be required to establish the validity of these species.

Chlorella homosphaera Skuja 1948:130

The description by Skuja (1948) is not in sufficient detail to determine just where his organism fits in the present classification.

Chlorella acuminata Gerneck

This species was described by Gerneck (1907) as being acuminate and always pointed at one end. It was isolated from the north side of trees in Göttingen, but appears in no current collections.

PHYSIOLOGICAL KEY FOR THE GENUS *CHLORELLA*

I. Subgenus *Chlorella*

All species require only inorganic media for growth in light.

An organic carbon source and nitrogen source promote growth or are ineffective and sometimes inhibitory. (Autotrophs)

A. Not stimulated or rather inhibited by glucose when grown in the light on inorganic media with NH_4NO_3 as a N source.

1. Will not grow in dark on any substrate.

a. NH_3 utilized as a N source, but NO_3 not normally utilized, loses chlorophyll in liquid culture in several days.

Chlorella variabilis

aa. NH_3 utilized and NO_3 also slightly utilized, cultures are always green.

Chlorella autotrophica

2. Will grow in dark on certain media. NH_3 and NO_3 equally utilized.

a. Will grow in dark when supplied glucose or acetate with NH_4NO_3 as a N source.

b. Casein hydrolysate supports growth better than NH_4NO_3 when supplied as a N source. Mannose is stimulatory in light and darkness.

Chlorella mutabilis

bb. Casein hydrolysate is ineffective. Mannose is stimulatory neither in light nor in darkness.

Chlorella nocturna

aa. Will not grow in the dark when supplied glucose or acetate with NH_4NO_3 as a N source, but will grow with casein hydrolysate as a N source.

b. Casein hydrolysate accelerates growth in light better than NH_4NO_3 .

Chlorella photophila

bb. NH_4NO_3 accelerates growth in light better than casein hydrolysate.

Chlorella variabilis

B. Stimulated by glucose when grown in the light or inorganic media with NH_4NO_3 as a N source.

1. Sucrose, fructose and mannose promote growth in light.

a. Sucrose, fructose and mannose promote growth in darkness. Low growth rate. NO_3 is utilized better than NH_3 on glucose media. Cells always spherical.

b. Acetate supports growth slightly in darkness. Cultures are always pea-green. Chromatophore disc-shaped.

c. Glucose always promotes growth.

d. Concentrations of acetate above 1% inhibit growth.

Chlorella vulgaris var. *vulgaris*

dd. Concentrations of acetate above 1% do not inhibit growth.

Chlorella vulgaris var. *luteoviridis*

cc. Glucose sometimes promotes growth but sometimes inhibits.

Chlorella mutabilis

bb. Acetate does not support growth in darkness. Cultures are always golden-brown to orange in liquid culture.

Chlorella miniata

aa. Sucrose does not promote growth in darkness. Good growth rate. NH_3 and NO_3 are used equally on glucose media.

Acetate does not support growth in darkness.

Cells spherical or ellipsoidal.

Chromatophore net-like.

b. Yeast extract inhibits growth on glucose media.

Chlorella emersonii var. *emersonii*

bb. Yeast extract accelerates growth on glucose media.

c. Cells are spherical. Cells changing to brown with age.

Chlorella emersonii var. *globosa*

cc. Cells always spindle-shaped and over 10 microns in length. Cells not changing to brown with age.

Chlorella saccharophila

2. Sucrose does not promote growth in light.

a. Acetate promotes growth in dark.

b. Not stimulated by yeast extract when grown on glucose in light or darkness. Cells are always spherical.

c. Good growth on glucose, galactose and fructose in darkness.

d. Not stimulated by lactose in darkness.

Chlorella regularis var. *regularis*

dd. Stimulated by lactose in darkness.

e. Light does not enhance growth on glucose.

Chlorella regularis var. *umbricata*

ee. Light enhances growth when grown on glucose.

Chlorella regularis var. *aprica*

cc. Good growth on glucose, but poor growth on galactose and no growth on fructose in darkness.

Chlorella sorokiniana

aa. Acetate does not promote growth in darkness.

b. Mannose inhibits growth in light and darkness.

c. Galactose supports weak growth in darkness.

Chlorella vanniellii

cc. Galactose does not support growth in darkness.

d. Glucose supports good growth in darkness.

e. Yeast extract is ineffective on glucose media.

Chlorella infusionum var. *infusionum*

ee. Yeast extract promotes growth on glucose media.

Chlorella infusionum var. *auxenophila*

dd. Glucose supports growth very slightly in darkness.

Chlorella simplex

bb. Mannose enhances growth or is ineffective in light.

c. Mannose stimulates good growth in light and some growth in darkness.

d. Casein hydrolysate accelerates growth on glucose media. Cells always ellipsoidal unless sugars are supplied. Cells always green.

Chlorella ellipsoidea

dd. Casein hydrolysate is ineffective on glucose media. Cells spherical on agar but often ellipsoidal in liquid. Cells changing to brown with age.

e. Cells dark-green with girdle-shaped chromatophore, spherical to slightly ellipsoidal.

Chlorella fusca var. *fusca*

ee. Cells light-green with starch filled chromatophore, ellipsoidal.

Chlorella fusca var. *vacuolata*

cc. Mannose, ineffective in light, does not support growth in darkness.

d. Poor growth on glucose in darkness. Cells are small and ellipsoidal unless sugars are supplied. Chromatophore shallow, cup-shaped.

Chlorella pringsheimii

dd. Good growth on glucose in darkness. Cells always spherical with deep cup-shaped chromatophore.

Chlorella candida

II. Subgenus *Auxenochlorella*

All species require thiamin. An organic carbon source is required for good growth, but cultures turn yellow when supplied an organic C source in the absence of amino acids. Cultures grow deep green when supplied glucose plus casein hydrolysate. All species grow green in darkness in acetate media. No species can utilize NO_3 as a N source. All species fail to grow in organic media in the dark even when supplied thiamin. However, casein hydrolysate plus thiamin will support growth in the darkness when it is the sole organic N source. All species are spherical. (Mesotrophs and Auxenotrophs)

A. Mannose either slightly accelerates growth or has no effect.

1. Mannose not stimulatory in darkness.

Chlorella protothecoides var. *communis*

2. Mannose supports some growth in darkness.

Chlorella protothecoides var. *mannophila*

B. Mannose inhibits the growth in light.

1. Galactose ineffective in light and stimulatory in darkness.

Chlorella protothecoides var. *protothecoides*

2. Galactose stimulatory in light and darkness.

Chlorella protothecoides var. *galactophila*

REVIEW OF CELLULAR CHARACTERISTICS

Correlations between Chromatophore Type and Physiology

Regrettably the structure of the chromatophore varies with culture conditions. Descriptions of chromatophores, therefore, were made from cells grown on inorganic, liquid culture-media in light. Descriptions of chromatophores in the subgenus *Auxenochlorella* were made from cells grown on inorganic media supplemented with thiamin.

In media supplemented with sugar, cells generally enlarge and the chromatophore fills the cell and often becomes granular. Granular chromatophores (Fig. 2, No. 5) are also observed in abnormal cells, such as those which are not growing well because of an unsuitable environment. The small granular chromatophore type (Fig. 3, No. 8) is seen in cells likely to accumulate carotene, as in *Chlorella miniata* and old cultures of *C. emersonii*.

Species which form deep-green, thick cultures have the mantle-shaped chromatophore (Fig. 2, No. 1), which in *C. regularis* covers more than ninety percent of the cell membrane. The most efficient absorption of light can be expected by this type of chromatophore, because of its location in the cell and the large amount of chlorophyll exposed to light.

A disc-shaped chromatophore (Fig. 2, No. 2) is found in *C. vulgaris*. The color is pea-green and only the edge of the disc touches the cell membrane. Strains characterized by this type of chromatophore are weak autotrophs and demonstrate a slow growth rate—presumably because of a less efficient photosynthetic mechanism.

The sizes of the mantle-shaped chromatophores are different in the various species. A small mantle-shaped chromatophore is similar to the shallow cup-shaped ones (Fig. 2, No. 4). The size of the chromatophore is approximately proportional to the growth rate of the species. *Chlorella simplex*, with a shallow cup-shaped chromatophore, requires strong light in any medium—suggesting an inefficient absorption of light.

The girde-shaped chromatophore (Fig. 2, No. 3) is apparently evolved from the mantle-shaped type. It appears in small cells and ellipsoidal cells. The shape of the chromatophore correlates well with the ellipsoidal form of the cell body.

The dumbbell-shaped chromatophore (Fig. 2, No. 9) is characteristic of *Auxenochlorella* where the growth on all media must be supported by thiamin. The pyrenoid is invisible or may be entirely absent in this type of chromatophore. When glucose is supplied, however, the chromatophore entirely disappears and only colorless cells remain.

Parker, Bold, and Deason (1961) discussed the association of obligate photoautotrophs with the cup-shaped chromatophore, and of facultative heterotrophs with discoid, net-like, or sponge-like chromatophores. In the genus *Chlorella*, obligate photoautotrophs are few. However, cup-shaped chromatophores were observed in species where the organic requirements were less than with species possessing discoid chromatophores. The net-like chromatophore, in *C. saccharophila* and *C. emersonii*, however, can be seen to be associated with species that are strongly autotrophic.

The Effect of Carbon Sources on Growth

The following is a review of the important physiological responses classed according to the sugars studied.

In general, hexoses are utilized by most species. Di- and tri-saccharides are usually not metabolized. In most strains, cells increase in volume when hexoses are supplied. It must be remembered that cultures grown on inorganic media are not receiving an optimal C supply, and that the sugars should be expected to accelerate growth for this reason alone. Autotrophic growth under the test conditions was limited to some degree by the rate of CO₂ diffusion into the test tubes.

Arabinose.—Mostly ineffective or slightly inhibitory. *Chlorella miniata* and *C. variabilis* are both severely inhibited by arabinose.

Glucose.—Most species were stimulated by glucose in both light and darkness. The degree of acceleration differs in each species. Generally, light enhances glucose stimulation, but in some strains light seems to be ineffective, because of the overriding stimulation of glucose. In *Chlorella nocturna* light is rather inhibitory to glucose utilization.

In *C. variabilis* and *C. autotrophica*, glucose is ineffective and sometimes inhibitory. There is no stimulation in light and no growth in darkness on glucose. The inhibition or ineffectiveness of glucose in these strains is obscured when CO₂ is added and growth proceeds rapidly.

In the *Auxenochlorellas* glucose is also stimulatory. However, it cannot be utilized without a thiamin supply. All members of this group lose chlorophyll and alter their appearance and physiological characteristics to those of strict heterotrophs in the presence of glucose.

Galactose.—This sugar is stimulatory to many species of the subgenus, *Chlorella*, but generally the acceleration is less than for glucose. Dark growth cannot be supported with galactose except in some species. In *Auxenochlorella*, galactose supports growth as well as glucose with thiamin, in either light or dark. *Chlorella protothecoides* is an exception, because galactose cannot stimulate growth in light, although it does in darkness.

Mannose.—The rather unexpected inhibition of growth by mannose is definite in a number of species. Generally, in the subgenus *Chlorella*, the spherical species, having mantle-shaped or cup-shaped chromatophores, were not stimulated by mannose in light or darkness. Eight of these species were completely inhibited by mannose in the light. Thirteen species of *Chlorella*, whose chromatophores are discoid or net-like, were stimulated in the light. In *C. vulgaris* and *C. miniata* there was good growth in darkness, but only slight growth was obtained in the remainder of the 14 species.

In *Auxenochlorella*, except for *C. protothecoides* and *C. protothecoides* var. *galactophila*, mannose was slightly inhibitory in light, but growth in darkness was entirely inhibited.

Fructose.—The species, in which mannose stimulation occurred in the subgenus *Chlorella*, were also stimulated by fructose to the same degree as mannose in both light and darkness. Strains which were classified as *C. regularis* were remarkably accelerated by fructose in both light and in darkness.

Sucrose.—None of the group with cup-shaped chromatophores can utilize sucrose in light and darkness. *Chlorella emersonii* and *C. saccharophila*, whose chromatophores are net-like, were stimulated only in light. *Chlorella vulgaris* and *C. miniata*, with disc-shaped chromatophores, were supported by sucrose in light and also in darkness. In *Auxenochlorella*, no stimulation occurred either in light or in darkness.

Acetate as a Carbon Source

In the *Auxenochlorellae*, Na-acetate and galactose were equally effective when either thiamin or yeast extract were supplied. Yeast extract appeared to be somewhat more effective as a synergist for acetate. With yeast extract, growth was sustained at acetate concentrations up to 1.0%. No exception was observed in this subgenus. It could be one of the representative characteristics of *Auxenochlorella* and the ability to utilize acetate can be correlated with the evolutionary trend to heterotrophy.

In contrast to *Auxenochlorella* the response of the species in the subgenus *Chlorella* was not uniform. Stimulation by Na-acetate was never greater than that by glucose except in two species, *Chlorella nocturna* and *C. autotrophica*, in which glucose was inhibitory. Acetate supported growth in darkness in 12 species of the subgenus *Chlorella*. However, dark growth in *C. vulgaris* was very poor and sometimes not evident. Whether acetate was actually utilized is doubtful.

Generally, higher concentrations of Na-acetate than 1.0% are inhibitory. In some species, this inhibition was great enough to prevent growth, but in some species only a depression of growth resulted.

Six strains of *Chlorella* were not stimulated by Na-acetate in the light.

Two of them, *C. mutabilis* and *C. nocturna* grew in darkness, but the rest of the six, *C. ellipsoidea*, *C. acuminata*, *C. saccharophila*, and *C. autotrophica*, did not. *Chlorella autotrophica* was sometimes slightly stimulated in light, but sometimes was not. In some experiments Na-acetate supported some growth in darkness, but this could not be routinely obtained, and at this time one can only conclude that acetate does not support growth. *Chlorella variabilis* was always inhibited by a Na-acetate supply, even in the light.

The Growth Factor Requirement

Early experiments with 0.1% yeast extract gave confusing data. This was probably due to organic substances, such as sugars and amino acids, present in the yeast extract which had an effect on the growth. After the concentration was reduced to 0.01%, clear data were obtained. Yeast extract, at a concentration of 0.01%, never supported dark-growth in inorganic basal media. In light, or with organic nutrients, 0.01% yeast extract affected each species somewhat differently.

The response to the addition of growth factors can be summarized for each of the subgenera.

Chlorella.—Generally, yeast extract tends to enhance growth somewhat on any medium in the light and, very frequently, in darkness. However, in some rapidly growing species, yeast extract added to inorganic basal media had little effect, and was even inhibitory when supplied with an organic carbon source. In contrast to *Auxenochlorella*, none of the species of *Chlorella* can grow in the dark with yeast extract alone when casein hydrolysate is the N source. Possible replacement of the yeast extract by thiamin was tested. In some strains, thiamin was observed to substitute, but in others it did not.

Auxenochlorella.—Thiamin completely replaced yeast extract and, in some cases, it was more effective than yeast extract. Two concentrations, 1 $\mu\text{g}/\text{l}$ and 10 $\mu\text{g}/\text{l}$ were both effective. Vitamin B₁₂ and biotin were also tested for possible replacement of yeast extract. However, they were observed to be, at best, only slightly stimulatory in a few cases. No growth occurs on any medium without thiamin. Thiamin is completely effective, except on inorganic basal media in darkness, although thiamin can support growth in dark when casein hydrolysate is supplied as a N source. This may be because the amino acids are also being used as C sources.

Thiamin enhances colorless growth when glucose is supplied. Green cultures were obtained in NH₃ media with thiamin and casein hydrolysate. Nevertheless, the growth maximum is limited and never surpassed 0.7 in

optical density. The deepest green cultures are obtained on media with thiamin, casein hydrolysate, and glucose.

The Utilization of Nitrogen Sources

Most of the species of the subgenus *Chlorella* are supported in growth by both NH_3 and NO_3 as N sources. The only exceptions are *C. variabilis* and *C. autotrophica* which are grown only on NH_3 . The preference for NO_3 or for NH_3 was investigated with nitrogen-starved cells cultured carefully to avoid the carry-over of N from the previous culture. However, no remarkable difference was observed. Some nitrate preference in inorganic media appeared for several species, *C. simplex*, *C. nocturna*, *C. mutabilis*, *C. vanniellii*, and *C. emersonii*. Nitrate preferences, on nutrient media with glucose and yeast extract, were observed for *C. vulgaris* and *C. miniata*. In contrast to the subgenus, *Chlorella*, there is a remarkable NH_3 preference in *Auxenchlorella*, where NO_3 cannot support any growth in any media, and is, in fact, often inhibitory.

Growth in casein hydrolysate is generally better than in NH_4NO_3 , possibly because some amino acids are being utilized intact. Generally, when species grow well on inorganic media, there is no preference for amino acids. Amino acids are always more stimulatory than NH_4NO_3 for *Auxenchlorella*. They also support growth in dark when thiamin is supplied. When casein hydrolysate is supplied to glucose-thiamin media for *Auxenchlorella*, the culture turns a deep-green and growth reaches the maximum. This is in sharp contrast to the colorless condition when casein hydrolysate is absent.

Pure glycine, alanine, methionine, and tryptophane were supplied to N-deficient media, in order to determine which amino acids are available. Such tests were inconclusive, but preliminary data suggest that all amino acids are utilized.

EVOLUTIONARY TRENDS WITHIN THE SUBGENERA

In order to depict the evolutionary development within the genus, a series of diagrammatic representations of the physiological character of six main types has been prepared. The diagrams will be understood by referring to the key given in Figure 61. They can be compared to diagrams for ideal heterotrophs and for ideal autotrophs shown in Figures 62 and 63.

Figure 62 is representative of the subgenus *Auxenochlorella* where 11 of the 41 cultures were observed to require thiamin for growth. Organic nutrient media, such as glucose and casein hydrolysate plus inorganic components, cannot support growth without thiamin. Amino acids and ammonia are utilized as N sources, but there is a total inability to reduce nitrate. With glucose, cells lose chlorophyll and turn white or yellow. The daughter cells are also colorless and only heterotrophic growth is possible. In darkness, except when supplied acetate, cultures always lose chlorophyll immediately, even without glucose, and, of course, there is no growth in darkness without an organic C supply. Glucose, thiamin, and casein hydrolysate are essential factors for the production of deep-green cells and maximum growth. A diagram for *Chlorella protothecoides*, showing the complexity of response to various combinations of media, is given in Figure 64.

On the following three points, *Auxenochlorella* is different from an ideal heterotroph (Fig. 62): (a) light is essential to support growth on inorganic media with thiamin or yeast extract, (b) thiamin is required to enhance growth on glucose media, (c) light always causes some acceleration of the growth in any medium.

In contrast to the identical physiological characteristics which appeared in the 11 cultures of subgenus *Auxenochlorella*, 30 cultures of subgenus *Chlorella* showed intricate variations. These strains are related through their capacity to grow in light on strictly inorganic media. The subgenus *Chlorella* is nevertheless different from the ideal autotroph (Fig. 63) in the following respects: (a) glucose supports growth in darkness, but the culture remains deep-green for a number of generations except under certain conditions, (b) glucose also enhances growth on inorganic media in the light, (c) organic nutrients, added in addition to sugars, generally support even better growth.

Chlorella autotrophica (Fig. 65) is very nearly the ideal autotroph. Light is essential for growth of this organism and none of the sugars, yeast extract, or casein hydrolysate is stimulatory in darkness. Amino acids and glucose in the light have no effect, or are even ineffective or inhibitory. However, growth on inorganic media is very slow in the absence of yeast extract, and

maximum growth is never obtained on strictly inorganic media. Some factor necessary for optimum growth is supplied by yeast extract.

Growth of *Chlorella photophila* is stimulated by amino acids. However, the difference between it and *Chlorella autotrophica* is that yeast-extract, added to glucose in the medium, stimulated growth in darkness. If *Chlorella photophila* (Fig. 66) were to lose the ability to grow in light without yeast extract, it would be classified in the subgenus *Auxenchlorella*.

Another organism approaching the ideal autotroph is *Chlorella nocturna* (Fig. 67). In this strain, organic substances, such as glucose, yeast extract, or casein hydrolysate, are ineffective, or rather inhibitory. Furthermore, growth on inorganic media reaches a maximum optical density very rapidly. The difference between this strain and an ideal autotroph is the strong stimulation due to glucose in darkness. The stimulation frequently surpasses growth supported only by photosynthesis on inorganic media. Supplying CO₂ will accelerate growth in light on an inorganic medium, but in this species an organic carbon supply is ineffective.

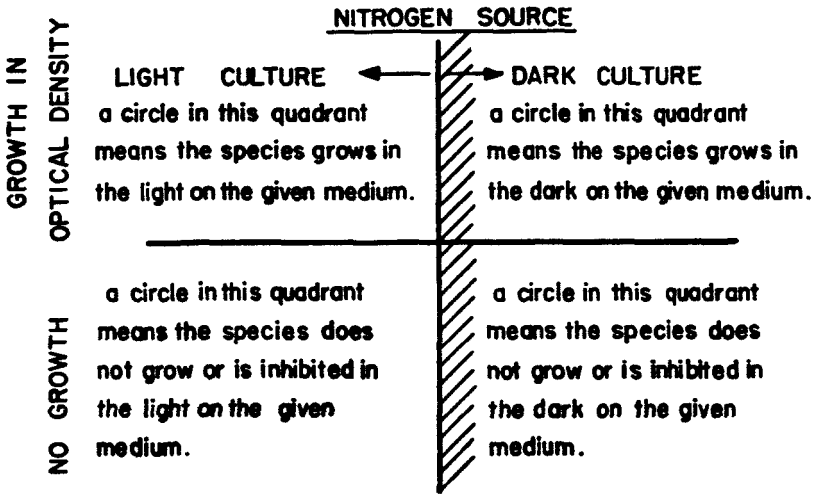
Chlorella regularis has the same tendency toward autotrophy as *C. nocturna* (Fig. 68) although glucose usually enhances growth in light. Yeast extract is only slightly stimulatory. Casein hydrolysate is inhibitory in *C. nocturna*, but not in *C. regularis*.

If the ability to use glucose in darkness, which is seen in the above species, is reduced and only very slight growth occurs in darkness, a group of organisms represented by *C. ellipsoidea* (Fig. 69) evolves. Glucose is remarkably stimulatory in light and yeast extract is also effective. Amino acids are neither very stimulating nor inhibitory.

Chlorella vulgaris (Fig. 70) grows better when yeast extract or casein hydrolysate is supplied. Possibly this species can be characterized as having a stronger requirement for yeast extract than *C. ellipsoidea*. A further difference from *C. ellipsoidea* is the strong stimulation of growth by casein hydrolysate in darkness. Supposedly this species is transitional to a heterotrophic existence.

None of the 41 strains of the genus is observed to be an ideal autotroph, nor an ideal heterotroph. However, the evolutionary physiological development within the genus is apparent, and is probably the combined result of mutation and physiological adaptation to the environment during a long history.

Species
ACC Number



In light	In dark	
○	⊗	- basal medium only
⊙ G	⊗ G	- basal + glucose medium
⊙ Y	⊗ Y	- basal + yeast extract medium
⊙ T	⊗ T	- basal + thiamine medium
⊙ GY	⊗ GY	- basal + glucose + yeast extract medium
⊙ GT	⊗ GT	- basal + glucose + thiamine medium

FIGURE 61. Key to the diagrammatic representation of suitable culture conditions for species of *Chlorella*.

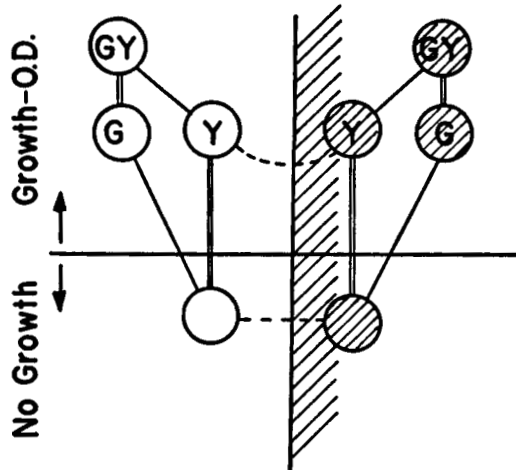
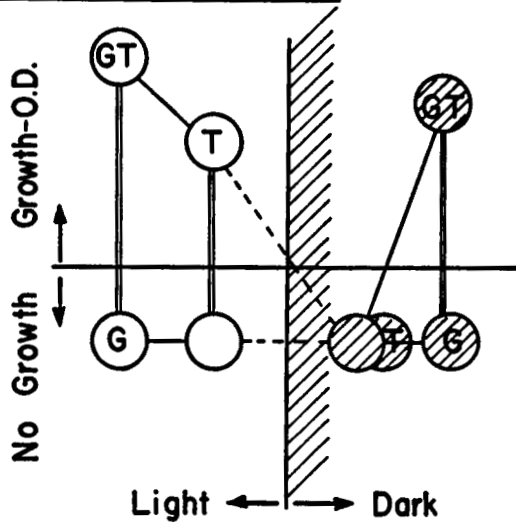
Ideal HeterotrophSubgenus Auxenochlorella

FIGURE 62. Physiological differences of *Auxenochlorella* from an ideal heterotroph. For a key to the symbols see figure 61.

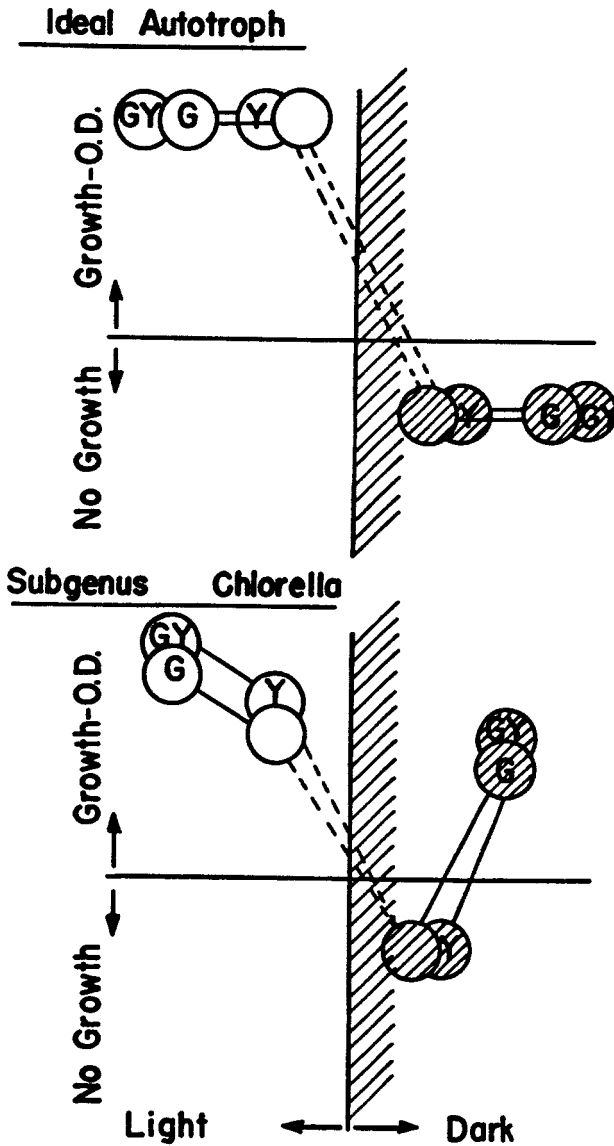


FIGURE 63. Physiological differences of the subgenus *Chlorella* from an ideal autotroph. For a key to the symbols see Figure 61.

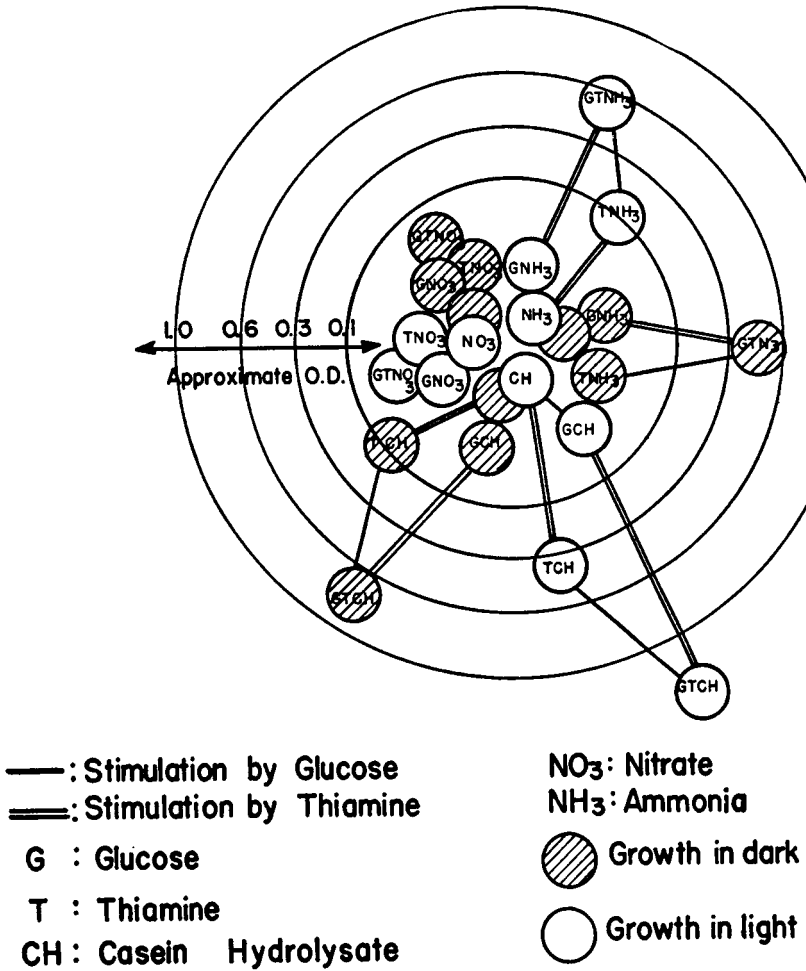


FIGURE 64. A diagrammatic representation of the response of *Chlorella protothecoides* to different nitrogen sources, glucose, and thiamin in the culture medium.

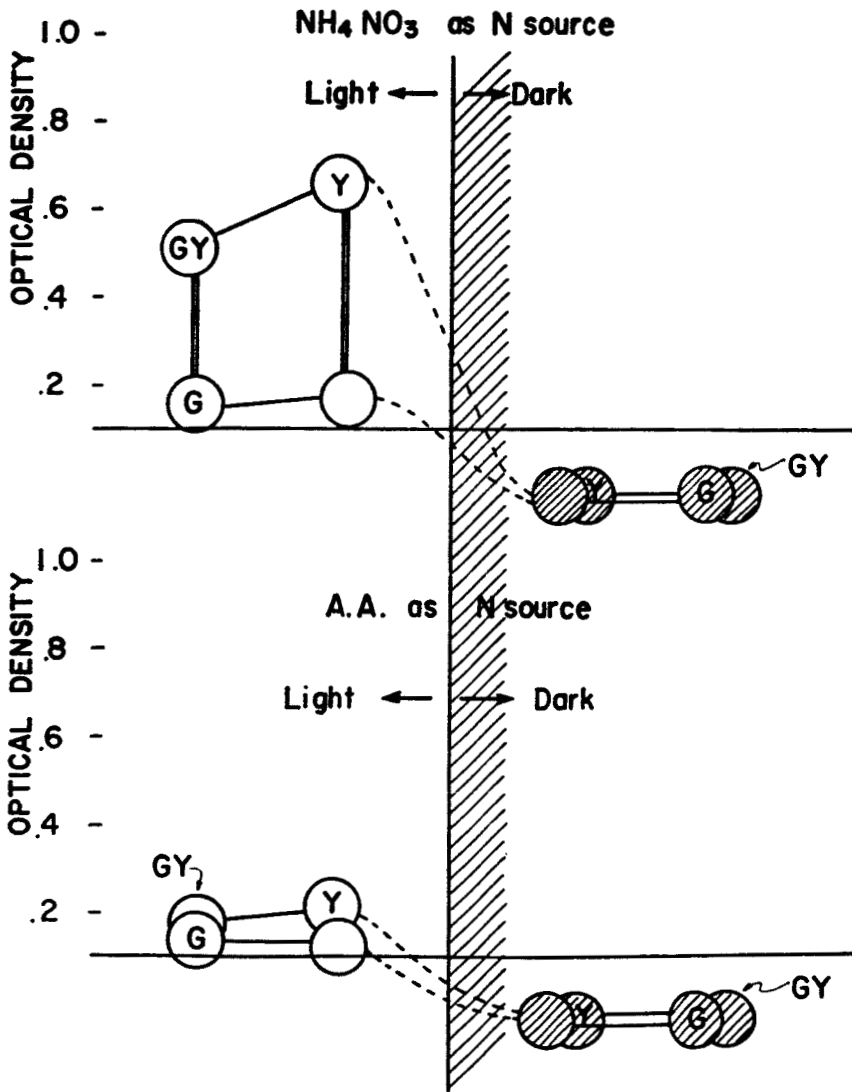


FIGURE 65. A diagrammatic representation of the nutritional characteristics of *Chlorella autotrophica* Indiana Algal Culture Collection No. 580. Growth is given as it would appear after 6 days. For the key to the symbols see Figure 61.

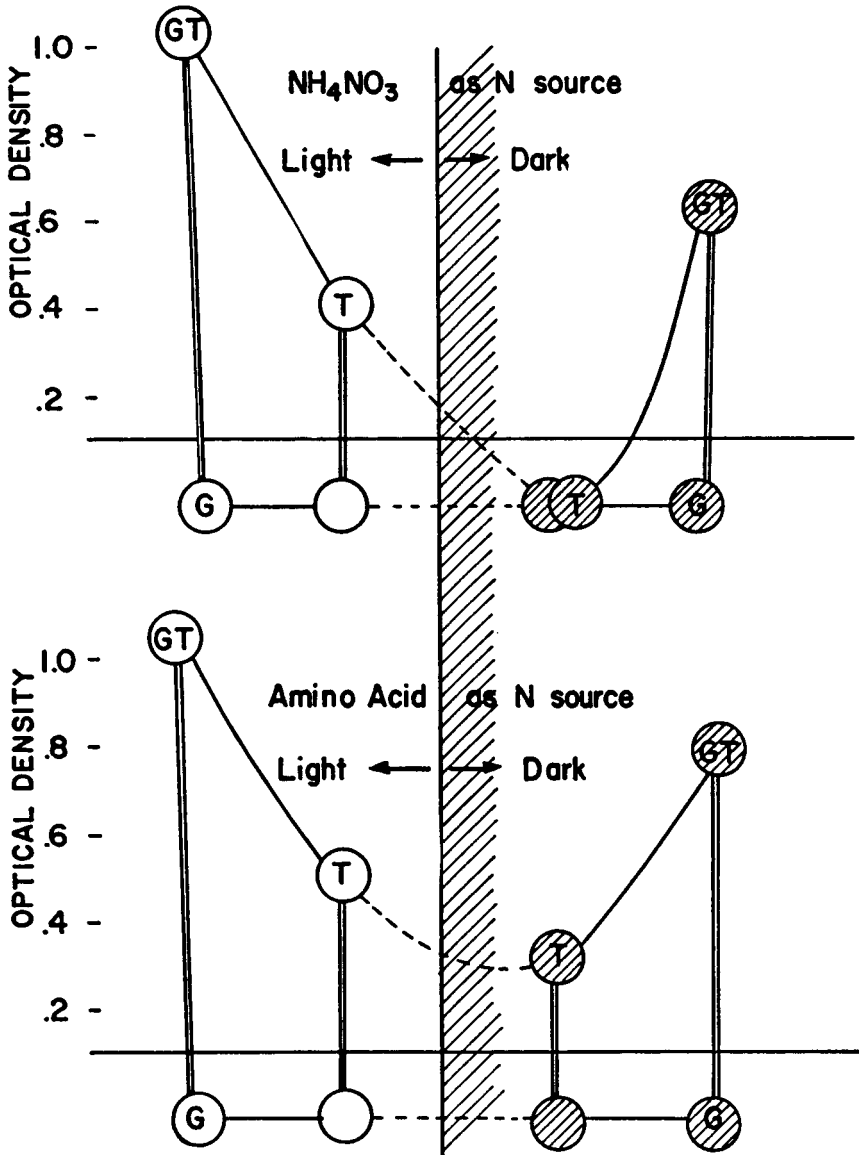


FIGURE 66. A diagrammatic representation of the nutritional characteristics of *Chlorella protothecoides* Indiana Algal Culture Collection No. 25. Growth is given as it would appear after 6 days. For the key to the symbols see Figure 61.

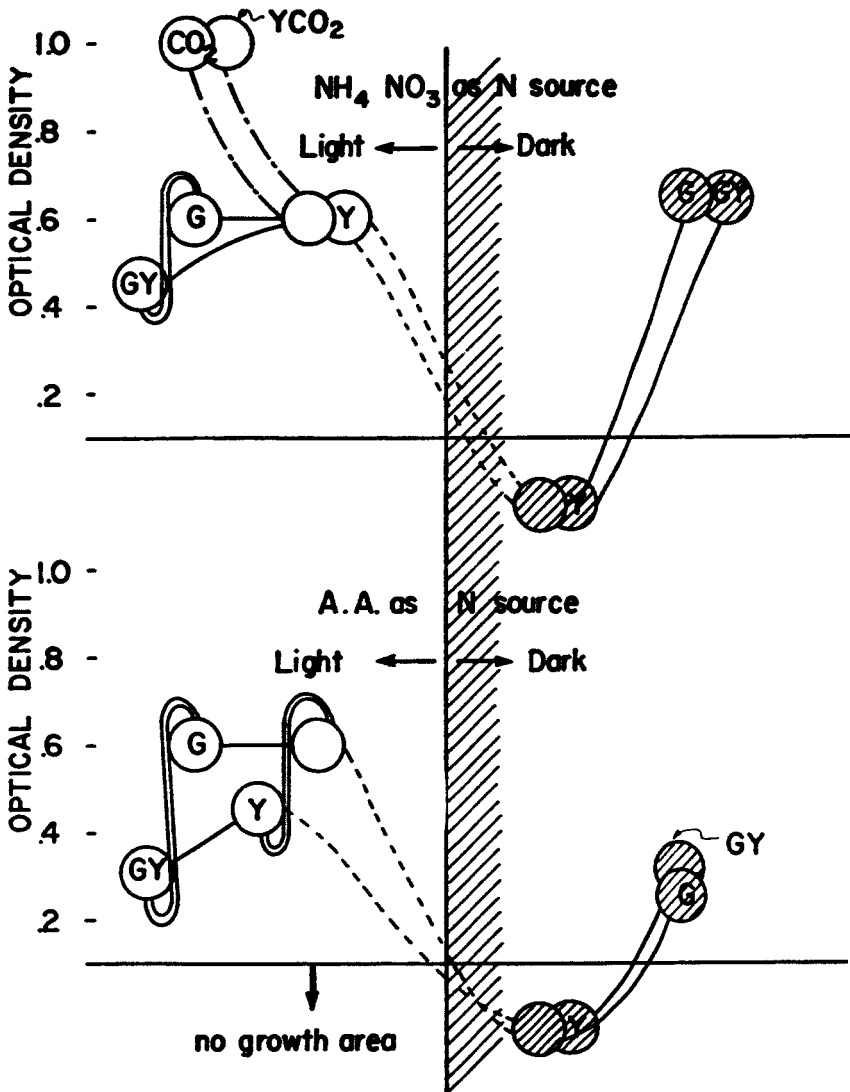


FIGURE 67. A diagrammatic representation of the nutritional characteristics of *Chlorella nocturna* Indiana Algal Culture Collection No. 290. Growth is given as it would appear after 4 days. For a key to the symbols see Figure 61.

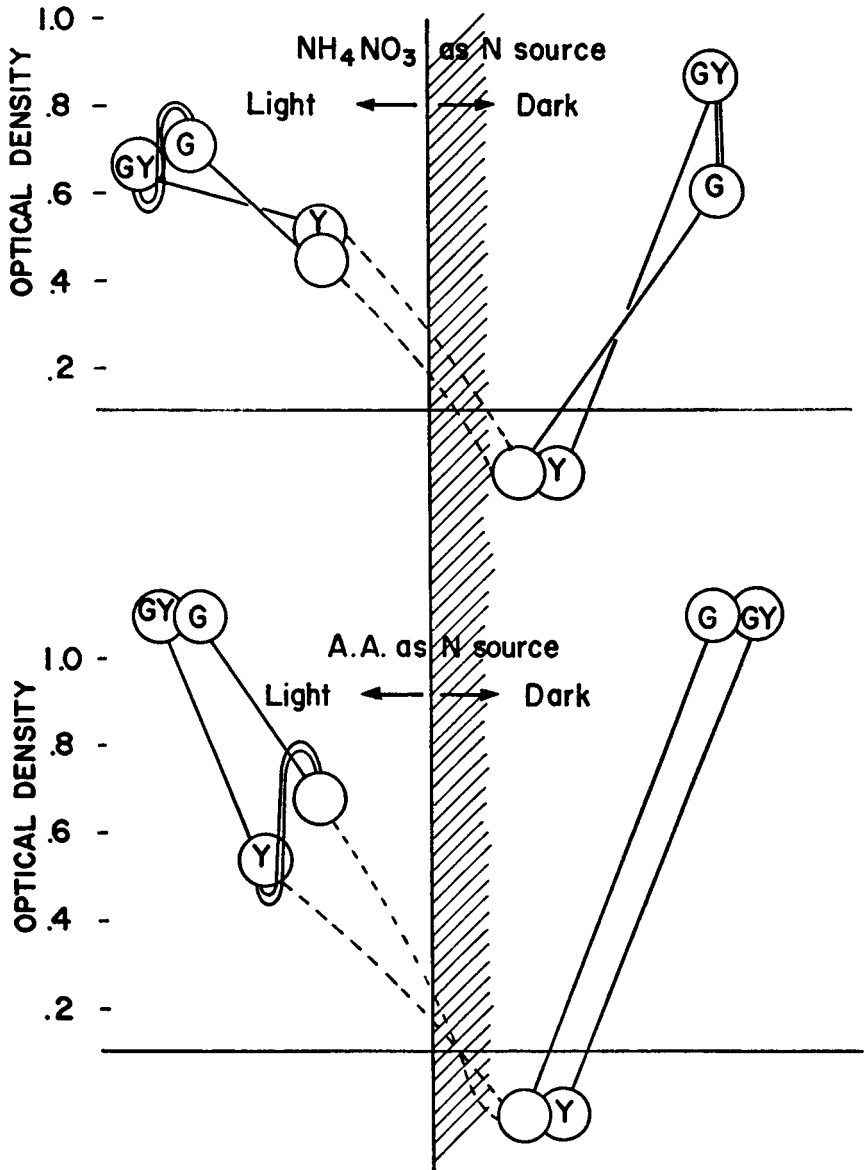


FIGURE 68. A diagrammatic representation of the nutritional characteristics of *Chlorella regularis* var. *umbricata* Indiana Algal Culture Collection No. 398. Growth is given as it would appear after 4 days. For a key to the symbols see Figure 61.

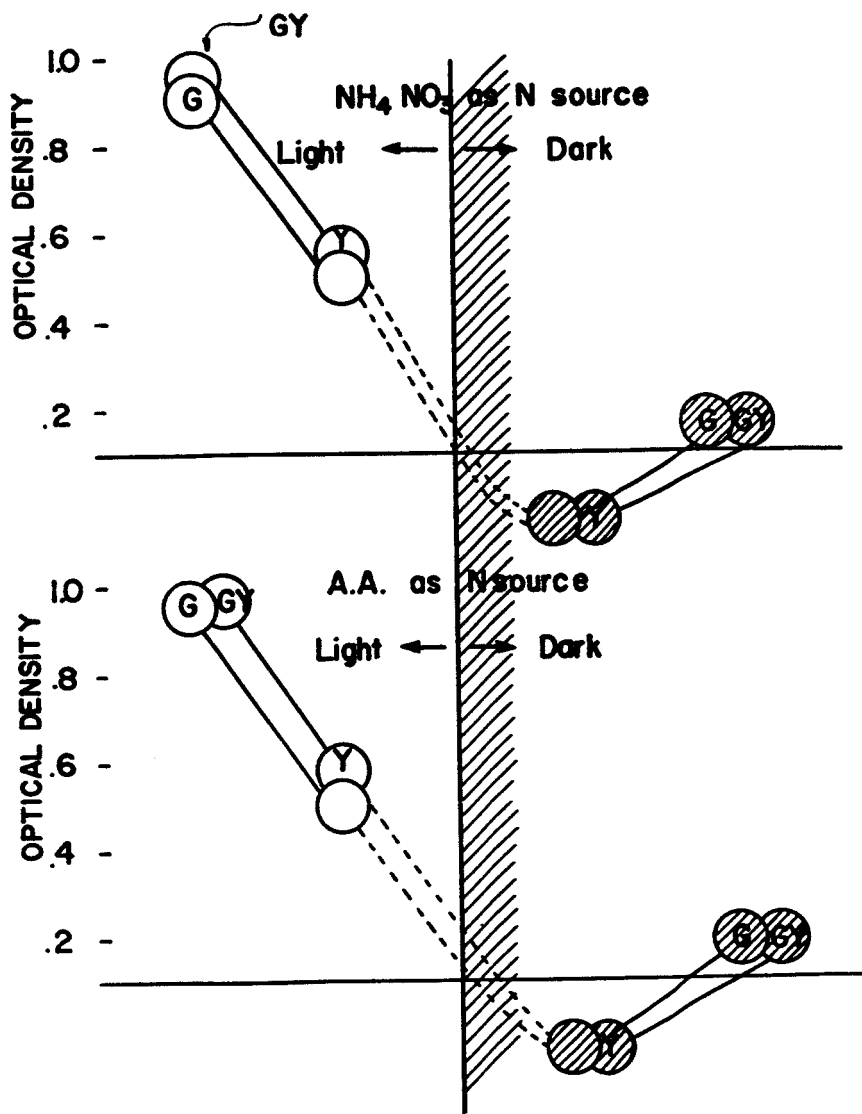


FIGURE 69. A diagrammatic representation of the nutritional characteristics of *Chlorella ellipsoidea* Indiana Algal Culture Collection No. 247. Growth is given as it would appear after 6 days. For a key to the symbols see Figure 61.

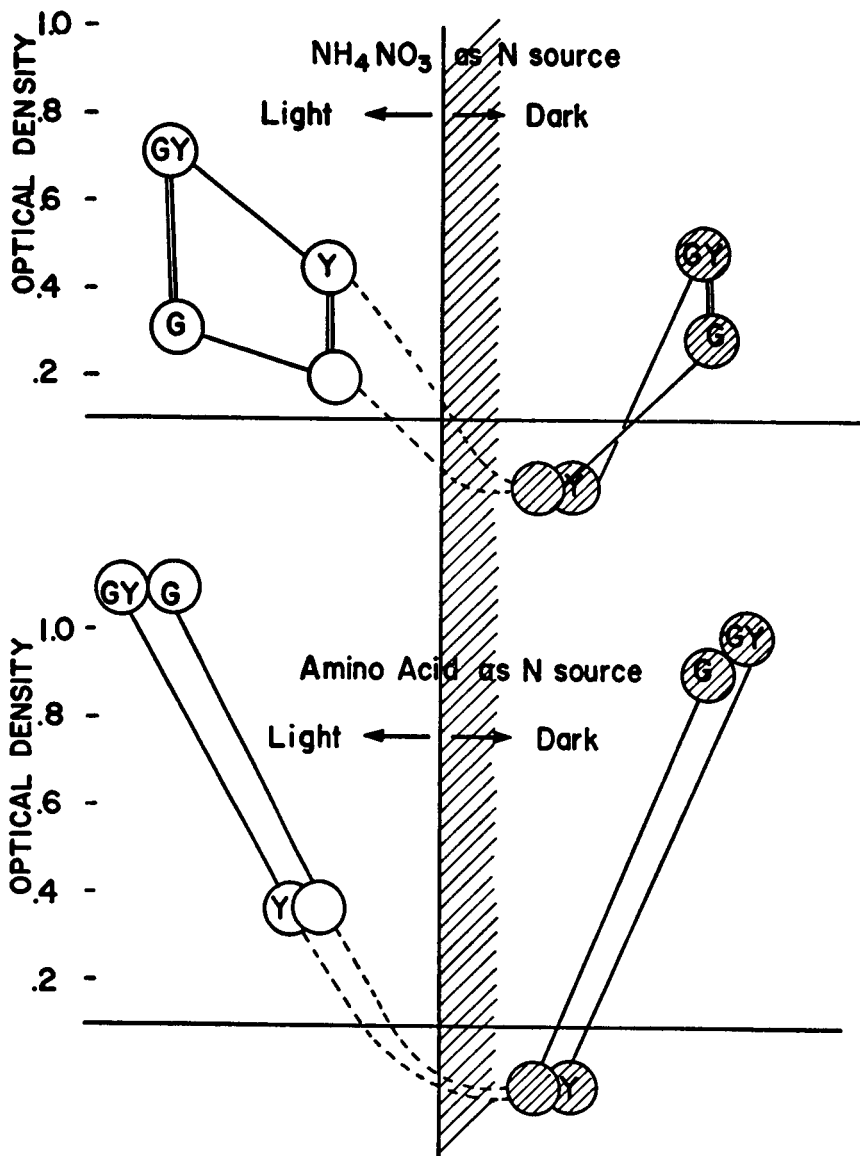


FIGURE 70. A diagrammatic representation of the nutritional characteristics of *Chlorella vulgaris* var. *luteoviridis* Indiana Algal Culture Collection No. 22. Growth is given as it would appear after 8 days. For a key to the symbols see Figure 61.

N 6614638

SUMMARY

Forty-one isolates of the genus *Chlorella* were examined to establish physiological and morphological characteristics of taxonomic value. The algae were grown free of bacteria, under controlled light and temperature conditions, in liquid shake-cultures. From standardized cultures the algae were photographed in color and described according to their morphology, with special emphasis on the structure of the chromatophore. Comparisons of morphology were made between algae growing on organic and inorganic media.

Physiological response to hexoses, pentoses, mono-, di-, and tri-saccharides, and dextrin were recorded for cultures growing in both light and darkness. Ability to use, and preferences for NO_3 , NH_3 , amino acids, and proteins were observed. Vitamin requirements were determined. Pigment changes indicated tendencies of the organisms to either heterotrophic or autotrophic growth, and suggested evolutionary patterns within the genus.

Two subgenera were differentiated. The subgenus *Chlorella* comprised species requiring no vitamins to support growth. All species of the subgenus *Auxenchlorella* required thiamin. The *Chlorellae* embrace 26 species and varieties; the *Auxenchlorellae* contained 4 species and varieties. All species of *Chlorella* described in the literature were discussed in arriving at the accepted nomenclature.

The physiological characteristics of the species were reviewed in the light of morphological similarities, and schematic diagrams were presented to compare the major types of nutrition to that of idealized heterotrophs and autotrophs. An artificial key to the species makes possible their identification using physiological characters only.

APPENDIX

1. Protocol for Identification of an Unknown Alga in the Genus *Chlorella*

Prior to submitting the unknown alga to a series of physiological tests, it is essential that a clonal, unialgal, bacteria-free culture of the organism be available. This can be achieved by methods established and described in the literature—for which see Starr (1960). Assuming that these requirements are met, both sterile, minimal, inorganic media and sterile, complete, organic media in test tubes should be inoculated and placed on a shaking apparatus as described in *Materials and Methods*. The cultures should be grown until they reach an O.D. of 0.5. Whenever possible cultures growing in the minimal media should serve as a source for inocula in subsequent tests. Tests should then be carried out as specified in *Methods* in the following order. At the same time color, cell size, cell shape, and chromatophore structure should be observed:

1. Determining of a possible thiamin requirement on inorganic medium. This will determine the subgenus.

2. If the organism is in the subgenus *Chlorella*, determine the degree of stimulation or inhibition achieved by the addition of glucose during culture on both light and darkness. The effect of sucrose and acetate in darkness may be determined at the same time. Refer to the key and descriptions. If the organism is in the subgenus *Auxenochlorella*, proceed to (6) below.

3. If glucose does not stimulate light-growth, determine the relative effects of NO_3 , NH_3 , and casein hydrolysate as N sources on otherwise inorganic media. Refer to the key and descriptions.

4. If glucose does stimulate light-growth, determine the effect of yeast extract added to inorganic media with and without glucose in light and darkness. Refer to the key and descriptions.

5. If still in doubt, test mannose, galactose, fructose, and lactose to determine stimulation or inhibition when they are added to inorganic basal medium in light and darkness. Refer to the key and descriptions.

6. If the organism is in the subgenus *Auxenochlorella*, determine growth in light and darkness on the following media:

- (a) Basal medium, with NH_4Cl substituted for NH_4NO_3 , plus thiamin.

- (b) Basal medium, with NH_4Cl substituted for NH_4NO_3 , plus glucose.

(c) Basal medium, with NH_4Cl substituted for NH_4NO_3 , plus glucose, plus thiamin.

(d), (e), (f) As in (a), (b), and (c) above except that NH_4NO_3 is replaced by KNO_3 .

(g), (h), (i) As in (a), (b), and (c) above except that NH_4NO_3 is replaced by casein hydrolysate.

Add mannose and galactose to the basal medium plus thiamin and culture in light and darkness. Refer to the key and descriptions.

APPENDIX TABLE 1
 The Effect of Sugars on the Growth of Species of *Chlorella* on Basal Medium in Light and Darkness with and without Supplements of Thiamin and Yeast Extract

Species	Isolate Number	Supplement	D-(-) Arab- inose	α, D-Glu- cose	D-Galac- tose	D-(+) Man- nose	D-Fruc- tose	Su- crose	Lac- tose	Mal- tose	Raffi- nose	Dex- trin
<i>Chlorella</i>												
<i>C. sorokiniana</i>	7-11-05	None	0	4+	2s	-,s	0	0	0	0	0	0
<i>C. candida</i>	260	"	0	4+	3	0	0	0	0	0	0	0
<i>C. infusionum</i> var. <i>auxenophila</i>	261	"	0	3+	3	-,s	1	0	0	0	0	0
<i>C. regularis</i>	262	"	0	8+	5+	0	6+	0	0	0	0	0
<i>C. vulgaris</i> var. <i>aprica</i>	263	"	0	5+	2+	0	3+	0	0+	0	0	0
<i>C. simplex</i>	265	"	0	5+	3	-	0	0	0	0	0	0
<i>C. infusionum</i>	396	"	0	5-	4	-	0	0	0	0	0	0
<i>C. regularis</i>	397	"	0	7+	3+	0	3+	0	0	0	0	0
<i>C. regularis</i> var. <i>umbricata</i>	398	"	0	7++	3+	0	5+	0	0+	0	0	0
<i>C. candida</i>	259	"	0	4+	4	0	0	0	0	0	0	0
<i>C. infusionum</i>	30	"	0	4+	1	-	0	0	0	0	0	0
<i>C. nocturna</i>	490	"	0	0+	2	-,s	0	0	0	0	0	0
<i>C. mutabilis</i>	24	"	0	4?+	3+	4s	3s	3s	0	0	0	0
<i>C. saccharophila</i>	27	"	0	4+	2	3s	3s	2	0	0	0	0
<i>C. fusca</i> var. <i>vacuolata</i>	251	"	0	6+	2	5+	6+	0	0	0	0	0

APPENDIX TABLE 1 (Continued)

Species	Isolate Number	Supplement	D-(-) Arab-inose	α, D-Glu-cose	D-Galac-tose	D-(+) Man-nose	D-Fruc-tose	Su-crose	Lac-tose	Mal-tose	Rafi-nose	Dex-trin
<i>C. emersonii</i> var. <i>globosa</i>	252	"	0	4+	1	3+	4+	4	0	0	0	0
<i>C. fusca</i>	343	"	0	4+	1	5+	2s	0	0	0	0	0
<i>C. photophila</i>	26	"	0	2-, s	2-, s	-, s	2-, s	1	0	0	0	0
<i>C. ellipsoidea</i>	247	"	0	4+	2s	3+	2+	0	0	0	0	0
<i>C. pringsheimii</i>	20	"	0	2s	2s	0	2s	0	0	0	0	0
<i>C. vulgaris</i> var. <i>luteoviridis</i>	248	"	0	4+	1s	4+	4+	2+	0	0	0	0
<i>C. vulgaris</i> var. <i>luteoviridis</i>	21	"	0	4+	1s	4+	6+	5+	0	0	0	0
<i>C. vulgaris</i> var. <i>luteoviridis</i>	22	"	0	4+	3s	3+	3+	2+	0	0	0	0
<i>C. miniata</i>	32	"	some	4+	3+, s	3+	3+	3+	3?	0	0	0
<i>C. vulgaris</i>	257	"	0	4+	3s	4+	4+	3+	1.0	1.0	1.0	0
<i>C. vulgaris</i>	258	"	0	3+	2s	2+	2+	3+	0	0	0	0
<i>C. variabilis</i>	130	"	some	0	0	0	-, 0	0	-, s	-, s	0	-
<i>C. autotrophica</i>	580	"	0	0	0	0	0	0	0	0	0	0
<i>C. vanniellii</i>	Md.#1	"	0	3+	2+	-	0	0	0	1	0	0
<i>C. emersonii</i>	Md.#2	"	0	6+	0	4+	8+	2	0	0	0	0

Symbols:

0 indicates no stimulation over growth on inorganic medium in light. 1-8 indicate the degree of stimulation over growth on inorganic medium in light in terms of tenths of an O.D., i.e., 3 = O.D. + 0.3. s indicates a very slight response. — indicates prevention of growth in inorganic medium in light. + indicates support of growth in the dark at least 0.2 O.D. greater than growth on inorganic medium in darkness. ++ indicates support of growth in the dark almost equivalent to growth on glucose medium in the light.

APPENDIX TABLE 1 (Continued)

Species	Isolate Number	Supplement	D-(-) Arab- inose	α, D- Glu- cose	D- Galac- tose	D-(+) Man- nose	D- Fru- ctose	Su- crose	Lac- tose	Mal- tose	Raffi- nose	Dex- trin
<i>Auxenochlorella</i>												
<i>C. protothecoides</i>	25	thiamin yeast	0	3++	0++	-	3++	0	0	0	0	0
			0	3++	0++	-	3++	0	0	0	0	0
<i>C. protothecoides</i> var. <i>mannophila</i>	29	thiamin yeast	0	1++	3++	3+	1++	0	0	0	0	0
			0	4++	4++	1+	4++	0	0	0	0	0
<i>C. protothecoides</i> var. <i>communis</i>	264	thiamin yeast	0	2+	3++	1	3++	0	0	0	0	0
			0	5++	5++	3	5++	0	0	0	0	0
<i>C. protothecoides</i> var. <i>communis</i>	255	thiamin yeast	0	4+	4++	1	5++	0	0	0	0	0
			0	5++	4++	2	3++	0	0	0	0	0
<i>C. protothecoides</i> var. <i>communis</i>	256	thiamin yeast	0	1++	3++	2	2++	0	0	0	0	0
			0	5+	5+	1	5+	0	0	0	0	0
<i>C. protothecoides</i> var. <i>communis</i>	28	thiamin yeast	0	3+	4++	2	4++	0	0	0	0	0
			0	2+	4+	3	3+	0	0	0	0	0
<i>C. protothecoides</i> var. <i>communis</i>	31	thiamin yeast	0	2++	2++	0	2++	0	0	0	0	0
			0	2++	4++	1	5++	0	0	0	0	0
<i>C. protothecoides</i> var. <i>communis</i>	250	thiamin yeast	0	5++	5++	2	5++	0	0	0	0	0
			0	5++	4++	1	5++	0	0	0	0	0
<i>C. protothecoides</i> var. <i>galactophila</i>	411	thiamin yeast	0	4+	3++	-	5++	0	0	0	0	0
			0	6++	6++	-	5++	0	0	0	0	0
<i>C. protothecoides</i> var. <i>communis</i>	636	thiamin yeast	0	4++	2+	2	5++	0	0	0	0	0
			0	4++	4++	3	4++	0	0	0	0	0
<i>C. protothecoides</i> var. <i>communis</i>	249	yeast	0	3++	4++	3	3++	0	0	0	0	0

APPENDIX TABLE 2
The Effect of Sodium Acetate Supplements on the Growth of Species of *Chlorella* on Basal Medium in Light and Darkness.

Species	Isolate Number	Light, basal, +0.1% Acetate	Light, basal, +1.0% Acetate	Dark, basal, +0.1% Acetate	Superior to basal + glucose
<i>Chlorella</i>					
<i>C. sorokiniana</i>	7-11-05	+	+	-	No
<i>C. candida</i>	260	+	-	-	No
<i>C. infusionum</i> var. <i>auxenophila</i>	261	+	+	-	No
<i>C. regularis</i>	262	+	+	+	No
<i>C. regularis</i> var. <i>aprica</i>	263	+	-	+	No
<i>C. simplex</i>	265	+	-	-	No
<i>C. infusionum</i>	396	+	+	-	No
<i>C. regularis</i>	397	+	+	+	No
<i>C. regularis</i> var. <i>umbricata</i>	398	+	+	+	No
<i>C. candida</i>	259	+	-	-	No
<i>C. infusionum</i>	30	+	-	-	No
<i>C. nocturna</i>	490	+	-	+	Yes
<i>C. mutabilis</i>	24	+	-	+	No
<i>C. saccharophila</i>	27	+	-	-	No
<i>C. fusca</i> var. <i>vacuolata</i>	251	+	+	-	No
<i>C. emersonii</i> var. <i>globosa</i>	252	+	+	-	No
<i>C. fusca</i>	343	+	-	-	No
<i>C. photophila</i>	26	+	-	-	No
<i>C. ellipsoidea</i>	247	+	+	-	No
<i>C. acuminata</i>	20	+	+	-	No
<i>C. vulgaris</i> var. <i>luteoviridis</i>	248	+	+	+	No
<i>C. vulgaris</i> var. <i>luteoviridis</i>	21	+	+	+	No

Symbols:

+ In light represents growth greater than that in basal medium by at least 0.2 O.D.

+ In dark represents growth greater than that on inorganic medium by at least 0.2 O.D.

APPENDIX TABLE 2 (Continued)

Species	Isolate Number	Light, basal, +0.1% Acetate	Light, basal, +1.0% Acetate	Dark, basal, +0.1% Acetate	Superior to basal + glucose
<i>C. vulgaris</i> var. <i>luteoviridis</i>	22	+	+-	+	No
<i>C. miniata</i>	32	+	-	-	No
<i>C. vulgaris</i>	257	+	-	+	No
<i>C. vulgaris</i>	258	+	-	+	No
<i>C. variabilis</i>	130	-	-	-	No
<i>C. autotrophica</i>	580	-	-	?	Yes
<i>C. vanniellii</i>	Md.#1	+	-	-	No
<i>C. emersonii</i>	Md.#2	+	-	-	No
<i>Auxenochlorella</i>					
<i>C. protothecoides</i>	25	+	+-	+	Slightly
<i>C. protothecoides</i> var. <i>mannophila</i>	29	+	+-	+	Slightly
<i>C. protothecoides</i> var. <i>communis</i>	264	+	+-	+	Slightly
<i>C. protothecoides</i> var. <i>communis</i>	255	+	+-	+	Slightly
<i>C. protothecoides</i> var. <i>communis</i>	256	+	+-	+	Slightly
<i>C. protothecoides</i> var. <i>communis</i>	28	+	+-	+	Slightly
<i>C. protothecoides</i> var. <i>communis</i>	31	+	+-	+	Slightly
<i>C. protothecoides</i> var. <i>communis</i>	249	+	+-	+	Slightly
<i>C. protothecoides</i> var. <i>communis</i>	250	+	+-	+	Slightly
<i>C. protothecoides</i> var. <i>communis</i>	636	+	+-	+	Slightly
<i>C. protothecoides</i> var. <i>galactophila</i>	411	+	+-	+	Slightly

APPENDIX TABLE 3
 The Effect of 0.01% Yeast Extract on the Ability of Species of *Chlorella* to Grow on Basal Inorganic Medium Supplemented with Certain Organic Compounds in Light and Darkness

Species	Number Isolate	Basal		Basal + glucose		Basal + casein hydrolysate		Basal + glucose + casein hydrolysate		Replaceable by thiamin
		Lt.	Dk.	Lt.	Dk.	Lt.	Dk.	Lt.	Dk.	
Most of subgenus										
<i>Chlorella</i>		s	0	s	s	s	0	s	s	Undetectable
<i>C. nocturna</i>	490	0	0	-	0	-	0	-	0	Partial
<i>C. regularis</i> var. <i>umbricata</i>	398	0	0	0	0	-	0	-	-	No
<i>C. vulgaris</i>	257	+	0	+	+	s	0	s	s	No
<i>C. autotrophica</i>	580	++	0	++	0	0	0	0	0	Partial
<i>C. photophila</i>	26	++	0	++	+	0	0	0	0	No
Subgenus <i>Auxenochlorella</i>		++	0	++	++	++	+	++	++	Entirely

Symbols:

- 0 indicates no stimulation of growth over that on inorganic basal medium only.
- + indicates stimulation of growth over that on inorganic basal medium greater than 0.2 O.D.
- ++ indicates stimulation of growth over that on inorganic basal medium greater than 0.5 O.D.
- s indicates slight stimulation of growth over that on inorganic basal medium less than 0.2 O.D.

APPENDIX TABLE 4
 The Effect of Vitamins on the Growth of Species of the Subgenus *Auxenochlorella* Compared to Growth on Yeast Extract and 0.01% Casein Hydrolysate

Species	Isolate Number	0.01% Yeast Extract	Vitamin Supplement								
			1 $\mu\text{g}/1$				10 $\mu\text{g}/1$				
			Casein hydrolysate + B ₁₂	Casein hydrolysate + B ₁	Casein hydrolysate + Biotin	Casein hydrolysate + B ₁₂	Casein hydrolysate + B ₁	Casein hydrolysate + Biotin	Casein hydrolysate + B ₁₂	Casein hydrolysate + Biotin	
<i>C. protothecoides</i> var. <i>communis</i>	264	5	0	1	5	0	0	1	1	7	1
<i>C. protothecoides</i> var. <i>mannophila</i>	29	3	0	0	4	1	1	0	0	6	0
<i>C. protothecoides</i> var. <i>communis</i>	31	4	0	0	4	1	1	0	0	5	1
<i>C. protothecoides</i> var. <i>communis</i>	255	5	0	0	5	0	0	0	0	4	0
<i>C. protothecoides</i> var. <i>communis</i>	256	6	0	0	5	0	0	0	0	4	0
<i>C. protothecoides</i> var. <i>communis</i>	28	4	0	0	2	0	0	0	0	2	0
<i>C. protothecoides</i> var. <i>communis</i>	250	6	0	0	6	0	0	0	0	6	0
<i>C. protothecoides</i> var. <i>galactophila</i>	411	7	0	0	6	0	0	0	0	5	0
<i>C. protothecoides</i> var. <i>communis</i>	249	4	0	0	5	0	0	0	0	4	0
<i>C. protothecoides</i> var. <i>communis</i>	25	7	0	0	7	0	0	0	0	5	0
<i>C. protothecoides</i> var. <i>communis</i>	636	7	0	0	5	0	0	0	0	5	0

Symbols:

0 represents no growth.

1-7 represents growth greater than that in the absence of the vitamins on inorganic medium in the light in terms of tenths of O.D. unit, i.e., 3 = 0.3 O.D.

APPENDIX TABLE 5
The Effect of Different Nitrogen Sources on the Growth of Species of *Chlorella* on Basal Medium Minus Nitrogen
Supplemented with Various Compounds in Light.

Species	Isolate Number	+NH ₃	+NO ₃	+NH ₃ + glucose + yeast extract	+NO ₃ + glucose + yeast extract	+NH ₄ NO ₃	+ Amino acids	+NH ₄ NO ₃ + glucose + yeast extract	+ Amino acids + glucose + yeast extract
<i>Chlorella</i>									
(Thiamin excluded)									
<i>C. sorokintiana</i>	7-11-05	+	+	+	+	+	++	+	+
<i>C. candida</i>	260	+	+	+	+	+	?++	+	+
<i>C. infusioformis</i> var. <i>auxenophila</i>	261	+	+	+	+	+	+	+	+
<i>C. regularis</i>	262	+	+	+	+	+	++	+	+
<i>C. regularis</i> var. <i>aprica</i>	263	+	+	+	+	+	+	+	+
<i>C. simplex</i>	265	+	?++	+	++	+	+	+	+
<i>C. infusioformis</i>	396	+	+	+	+	+	+	+	+
<i>C. regularis</i>	397	+	+	+	+	+	+	+	+
<i>C. regularis</i> var. <i>umblicata</i>	398	+	+	+	+	+	+	+	+
<i>C. candida</i>	259	+	+	+	+	+	+	+	+
<i>C. infusioformis</i>	30	+	+	+	+	+	++	+	+

Symbols:

- + represents growth equivalent to normal growth on basal medium + NH₄NO₃.
- ++ represents growth greater than normal growth on basal medium by a difference of at least 1.5 × normal.
- represents no growth.
- ? represents erratic growth response.

APPENDIX TABLE 5 (Continued)

Species	Isolate Number	+NH ₃	+NO ₃	+NH ₃ + glucose + yeast extract	+NO ₃ + glucose + yeast extract	+NH ₄ NO ₃	+ Amino acids	+NH ₄ NO ₃ + glucose + yeast extract	+ Amino acids + glucose + yeast extract
<i>C. nocturna</i>	490	+	++	+	++	+	+	+	+
<i>C. mutabilis</i>	24	+	++	+	++	+	++	+	++
<i>C. saccharophila</i>	27	+	+	+	+	+	++	+	+
<i>C. fusca</i> var. <i>vacuolata</i>	251	+	+	+	+	+	++	+	+
<i>C. emersonii</i> var. <i>globosa</i>	252	+	+	+	+	+	+	+	++
<i>C. fusca</i>	343	+	+	+	+	+	+	+	+
<i>C. photophila</i>	26	+	+	+	+	+	++	+	+
<i>C. ellipsoidea</i>	247	+	+	+	+	+	+	+	+
<i>C. acuminata</i>	20	+	+	+	+	+	+	+	+
<i>C. vulgaris</i> var. <i>luteoviridis</i>	248	+	+	+	++	+	++	+	++
<i>C. vulgaris</i> var. <i>luteoviridis</i>	21	+	+	+	++	+	++	+	++
<i>C. vulgaris</i> var. <i>luteoviridis</i>	22	+	+	+	++	+	++	+	+
<i>C. miniata</i>	32	+	++	+	++	+	++	+	++
<i>C. vulgaris</i>	257	+	+	+	++	+	++	+	+
<i>C. vulgaris</i>	258	+	+	+	++	+	++	+	++
<i>C. variabilis</i>	130	+	-	+	-	+	-	+	##
<i>C. autotrophica</i>	580	++	s	+	+	+	-	++	+
<i>C. vanniellii</i>	Md.#1	+	++	+	++	+	+	+	+
<i>C. emersonii</i>	Md.#2	+	++	+	++	+	++	+	++

APPENDIX TABLE 5 (Continued)

Species	Isolate Number	+NH ₃	+NO ₃	+NH ₃ + glucose + yeast extract	+NO ₃ + glucose + yeast extract	+NH ₄ NO ₃	Amino acids	+NH ₄ NO ₃ + glucose + yeast extract	+ Amino acids + glucose + yeast extract
<i>Auxenochlorella</i> (thiamin included)									
<i>C. protothecoides</i>	25	+	-	+	-	+	++	+	++
<i>C. protothecoides</i> var. <i>mannophila</i>	29	+	-	+	-	+	++	+	++
<i>C. protothecoides</i> var. <i>communis</i>	264	+	-	+	-	+	++	+	++
<i>C. protothecoides</i> var. <i>communis</i>	255	+	-	+	-	+	++	+	++
<i>C. protothecoides</i> var. <i>communis</i>	256	+	-	+	-	+	++	+	++
<i>C. protothecoides</i> var. <i>communis</i>	28	+	-	+	-	+	++	+	++
<i>C. protothecoides</i> var. <i>communis</i>	31	+	-	+	-	+	++	+	++
<i>C. protothecoides</i> var. <i>communis</i>	249	+	-	+	-	+	++	+	++
<i>C. protothecoides</i> var. <i>communis</i>	250	+	-	+	-	+	++	+	++
<i>C. protothecoides</i> var. <i>communis</i>	636	+	-	+	-	+	++	+	++
<i>C. protothecoides</i> var. <i>galactophila</i>	411	+	-	+	-	+	++	+	++

LITERATURE CITED

- Allen, M. B. 1954. Studies on a blue-green *Chlorella*. Rapports et Communications, Huitième Congrès International De Botanique, Sec. 17: 41-42.
- Allen, M. B. 1954. Studies with *Cyanidium caldarium*, an anomalously pigmented chlorophyte. Arch. Mikrobiol. 32: 270-277.
- Alvik, G. 1934. Plankton-algen Norwegischer Austernpollen. In Bergens Museums Arbok, Naturuid rekke. Nr. 6: 1-47.
- Artari, A. 1892. Untersuchungen Über Entwicklung und Systematik einiger Proto-coccoideen. Bull. Soc. Imp. Nat. Moscou, N. S. 6: 222-258.
- Belcher, J. H. and G. E. Fogg. 1958. Studies on the growth of Xanthophyceae in pure culture. III. *Tribonema aequale* Pascher. Arch. Mikrobiol. 30: 17-22.
- Belcher, J. H. and J. D. A. Miller. 1960. Studies on the growth of Xanthophyceae in pure culture. IV. Nutritional type amongst the Xanthophyceae. Arch. Mikrobiol. 36: 219-228.
- Beyerinck, M. W. 1890. Culturversuche mit Zoochlorellen, Lichenengonidien und anderen niederen Algen. Bot. Ztg. 45: 726-739, 741-753, 757-767, 781-784.
- Beyerinck, M. W. 1904. *Chlorella variegata*, ein bunter Microbe. Rec. Trav. Bot. Neerl. 1: 14-27.
- Brandt, K. 1881. Ueber Das Zusammenleben von Thieren und Algen. Sitzungs-Berichte Gessel. Naturforschender Freunde Berlin 9: 140-146.
- Brandt, K. 1882. Über Die morphologische u. physiologische Bedeutung des Chlorophylls bei Thieren. Arch. Anat. und Physiol., Abt. Physiol. 6: 125-151.
- Brandt, K. 1883. Über Die morphologische und physiologische Bedeutung des Chlorophylls bei Tieren. 2. Artikel. Mitteil. Zool. Station Neapel. 4: 191-302.
- Bristol-Roach, B. M. 1926. On the relation of certain soil algae to some soluble carbon compounds. Ann. Bot. 40: 149-201.
- Bristol-Roach, B. M. 1927. On the carbon nutrition of some algae isolated from soil. Ann. Bot. 41: 509-517.
- Brunnthaler, J. 1915. Protococcales. In Pascher, A. Die Süßwasserflora Deutschlands, Österreichs und der Schweiz 5: 52-205.
- Butcher, R. W. 1952. Contributions to our knowledge of the smaller marine algae. J. Marine Biol. Assoc. of the United Kingdom 31: 175-190.
- Chick, H. 1903. A study of a unicellular green alga occurring in polluted water, with special reference to its nitrogenous metabolism. Proc. Roy. Soc. London, Ser. B, 71: 458-476.
- Chodat, R. 1909. Etude critique et expérimentale sur le polymorphisme des Algues. Genève Librairie Georg and C^o Libraries de l' Université, Genève, Switzerland. 165 pp.
- Chodat, R. 1913. Monographie d'Algues en Culture Pure. In Materieux pour la Flore Cryptogramique Suisse, Vol. 4, Fascicule 2. 266 pp. K. J. Wyss, Berne, Switzerland.
- Craig, F. N. and S. F. Trelease. 1937. Photosynthesis of *Chlorella* in heavy water. Am. J. Bot. 24: 232-242.
- Dönz, O. C. 1934. *Chlorella zopfingiensis* eine neue Bodenalge. Schweiz. Botan. Gesell. Berichte 43: 127-131.
- Fogg, G. E. 1953. The metabolism of algae. John Wiley & Sons, Inc. New York. 149 pp.

- Fritsch, F. E. 1912(a). Freshwater Algae. In National Antarctic Expedition 1901–1904. Vol. 6. Zoology and Botany, 1–60. British Museum, London.
- Fritsch, F. E. 1912(b). Freshwater algae collected in the South Orkneys by Mr. R. N. Rudmore Brown of the Scottish National Antarctic Expedition 1902–1904. Linn Soc. J. Bot. 40: 293–338.
- Galloway, R. A. and R. W. Krauss. 1959. Mechanism of action of Polymyxin B on *Chlorella* and *Scenedesmus*. Plant Physiol. 34: 380–389.
- Gerneck, R. 1907. Zür Kenntnis der niederen Chlorophyceen. Botan. Centr. 212: 221–290.
- Granick, S. 1948. Protoporphyrin 9 as a precursor of chlorophyll. J. Biol. Chem. 172: 717–727.
- Krauss, R. W. 1958. Physiology of the fresh-water algae. Ann. Rev. Plant Physiol. 9: 207–244.
- Krauss, R. W. 1962. Mass culture of algae for food and other organic compounds. Am. J. Bot. 49: 425–435.
- Krüger, W. 1894. Beiträge zur Kenntnis der Organismen des Saftflusses (sog. Schleimflusses) der Labbbäume. Beiträge z. Morph. u. Phys. Nied. Org. 4: 69–116.
- Lanjouw, J., ed. 1961. International Code of Botanical Nomenclature adopted by the Ninth International Botanical Congress, Montreal, August 1959. Regnum Vegetabile, Vol. 23. International Bureau for Plant Taxonomy and Nomenclature. Utrecht. 372 pp.
- Lewin, J. C. and R. W. Lewin. 1960. Auxotrophy and heterotrophy in marine littoral diatoms. Can. J. Microbiol. 6: 127–134.
- Loefer, J. B. 1936. Isolation and growth characteristics of the "Zoochlorella" of *Paramecium bursaria*. Am. Midland Nat. 70: 184–188.
- Mainx, F. 1928. Einige neue Chlorophyceen (Tetrasporales und Protococcales). Arch. Protistenk. 64: 93–94.
- Meyer, H. 1932. Das Chlorose-und Panaschüre phänomen bei Chlorellen. I. Teil. Beih. Botan. Centralblatt I Abt. 42: 496–544.
- Meyer, H. 1933. Das Chlorose-und Panaschüre problem bei Chlorellen. II. Teil. Beih. Botan. Centralblatt I Abt. 51: 170–203.
- Migula, W. 1904. Kryptogamen Flora von Deutschland, Deutsche-Österreich und der Schweiz im Anschluss an Thome's Flora von Deutschland. Vol. II. 918 p. (See p. 626–628).
- Miller, J. D. A. and G. E. Fogg. 1958. Studies on the growth of Xanthophyceae in pure culture. II. The relations of *Monas subterraneus* to organic substances. Arch. Mikrobiol. 30: 1–16.
- Myers, J. 1957. Suppression of carbon dioxide assimilation by glucose in *Chlorella*. Plant Physiol. 32. Suppl. xvi.
- Myers, J. 1960. The use of photosynthesis in a closed ecological system. In, Benson, O. O. and H. Strughold, eds. Physics and Medicine of the Atmosphere and Space. John Wiley & Sons, Inc. New York. 645 pp.
- Nadson, G. 1906. Zur Morphologie der niederen Algen. Bull. Jard. Imp. Bot. St. Pétersbourg 6: 184–194.
- Näegeli, C. 1849. Gattungen einzelligen Algen. Zurich. 139 pp.
- Oltmanns, F. 1904. Morphologie und Biologie der Algen. Vol. 1. Verlag von Gustav Fischer, Jena, Germany. 733 pp.
- Oltmanns, F. 1905. Morphologie und Biologie der Algen. Vol. 2. Verlag von Gustav Fischer, Jena, Germany. 443 pp.

- Oltmanns, F. 1923. Morphologie und Biologie der Algen. 2d Ed. Vol. 3. Verlag von Gustav Fischer, Jena, Germany. 558 pp.
- Parker, B. C., H. C. Bold and T. R. Deason. 1961. Facultative heterotrophy in some chlorococcean algae. *Science* 133: 761-763.
- Pascher, A. 1915. Süßwasserflora Deutschlands, Österreichs und der Schweiz. Heft 5. Chlorophyceae II. Verlag von Gustav Fischer, Jena, Germany.
- Patterson, G. W. 1963. The synthesis of sterols and the effect of steroids in *Chlorella*. M. S. Thesis, University of Maryland, College Park, Md.
- Pratt, R. 1941. Studies on *Chlorella vulgaris*. IV. Influence of the molecular proportions of KNO_3 , KH_2PO_4 , and $MgSO_4$ in the nutrient solution of the growth of *Chlorella*. *Am. J. Bot.* 28: 492-497.
- Pratt, R., J. F. Oneto, and J. Pratt. 1945. Studies on *Chlorella vulgaris*. X. Influence of the age of the culture on the accumulation of Chlorellin. *Am. J. Bot.* 32: 405-408.
- Pringsheim, E. G. and O. Pringsheim. 1959. Die Ernährung koloniebildender Volvocales. *Biologischen Zentralblatt* 78: 937-971.
- Pringsheim, E. G. and O. Pringsheim. 1959. Einige Chrysophyceen (*Ochromonas minuta* n. sp., *Synchromonas korschikoffie* n. sp., *Monas* spec.) Kleine Mitteilungen über Flagellaten und Algen VI. *Arch. Mikrobiol.* 34: 339-357.
- Provasoli, L. 1958. Nutrition and ecology of protozoa and algae. *Ann. Rev. Microbiol.* 12: 279-308.
- Rabenhorst, L. 1868. Flora Europaea Algarum aquae dulcis et submarinae. Section III. Algas Chlorophyllophyceas, Melanophyceas et Rhodophyceas complectens. p. 58. Lipsiae Edwardum Kummerum.
- Shrift, A., Joann Nevyas, and Sietske Turndorf. 1961. Mass adaptation to selenomethionine in populations of *Chlorella vulgaris*. *Plant Physiol.* 36: 502-509.
- Skuja, H. 1948. Taxonomie des phytoplanktons Einiger Seen in Uppland, Schweden. *Symbol. Bot. Upsaliensis* IX: 3. 399 pp.
- Sorokin, C. 1959. Tabular comparative data for the low- and high-temperature strains of *Chlorella*. *Nature* 184: 613-614.
- Stanier, R. Y. 1953. Adaptation, evolutionary and physiological; or Darwinism among the micro-organisms. *In*, *Adaptation in Microorganisms*. Cambridge University Press, London, England. p. 1-14.
- Starr, R. C. 1960. The culture collection of algae at Indiana University. *Am. J. Bot.* 47: 67-86.
- Thomas, W. H. and R. W. Krauss. 1955. Nitrogen metabolism in *Scenedesmus* as affected by environmental changes. *Plant Physiol.* 30: 113-122.
- Wetherell, D. F. 1958. Obligate phototrophy in *Chlamydomonas eugametos*. *Physiol. Plantarum* 11: 260-274.
- Wetherell, D. F. and R. W. Krauss. 1957. X-ray induced mutations in *Chlamydomonas eugametos*. *Am. J. Bot.* 44: 609-619.
- Wille, N. 1909. Conjugatae and Chlorophyceae. Die natürlichen Pflanzenfamilien nebst ihren Gattungen und wichtigeren Arten insbesondere den Nutzpflanzen unter Mitwirkung zahlreicher hervorragender Fachgelehrten begründet von A. Engler und K. Prantl. Nachtrage zum 1 Teil. Abteilung 2. p. 1-136.
- Wille, N. 1924. Süßwasser-algen von der Deutschen Sudpolar-Expedition auf dem Schiff "Gauss." *In* *Deutsche Sudpolar-Expedition 1901-1903*, Vol. 8: 377-445. Walter de Gruyter & Co., Berlin.
- Winokur, M. 1948. Growth relationships of *Chlorella* species. *Am. J. Bot.* 35: 118-129.

INDEX TO DESCRIPTIONS AND CITATIONS OF GENERA, SUBGENERA, AND SPECIES

Key to the various fonts used in this index:

Nomenclature

Roman accepted specific and generic names

[Roman] unaccepted names and synonyms

Pagination

Italics indicates the page reference for the formal description
 of species, sub-species or genera

Boldface indicates a page with a literature reference

INDEX TO DESCRIPTIONS AND CITATIONS OF GENERA, SUBGENERA, AND SPECIES

[*Aerosphaera*], 3, 13

faginea, 54

Auxenchlorella, 13, 14 39, 53, 59, 60,

61, 62, 63, 64, 65, 66, 68, 77, 78

protothecoides, 14, 39, 40, 51, 52, 61,

62, 65, 70, 72, 82, 84, 86, 89

protothecoides var. *communis*, 40, 41,

51, 59, 82, 84, 86, 89

protothecoides var. *galactophila*, 40,

51, 59, 62, 82, 84, 86, 89

protothecoides var. *mannophila*, 41, 42,

52, 59, 82, 84, 86, 89

protothecoides var. *protothecoides*, 59

[*variegata*], 22, 41, 90

Chlorella, iii, iv, 1, 2, 3, 4, 5, 6, 7, 13, 14,

15, 22, 28, 31, 40, 42, 54, 55, 61,

62, 63, 64, 65, 67, 69, 77, 78, 90,

91, 92

acuminata, 55, 63, 83, 88

antarctica, 55

[*aureoviridis*], 23, 24

autotrophica, 17, 18, 25, 43, 53, 56, 61,

62, 63, 64, 65, 66, 71, 81, 84, 85, 88

caldaria, 55

candida, 38, 39, 50, 59, 80, 83, 87

cladoniae, 54

coelastroides, 54

conductrix, 42

conglomerata, 42, 54

ellipsoidea, 34, 35, 36, 38, 49, 58, 63,

66, 75, 81, 83, 88

emersonii, 25, 26, 36, 45, 60, 61, 62,

64, 81, 84, 88

emersonii var. *emersonii*, 57

emersonii var. *globosa*, 26, 27, 46, 57,

81, 83, 88

faginea, 54

fusca, 35, 36, 49, 54, 81, 83, 88

fusca var. *fusca*, 59

fusca var. *vacuolata*, 36, 37, 50, 59,

80, 83, 88

homosphaera, 55

infusionum, 32, 33, 48, 80, 83, 87

Chlorella—*continued*

infusionum var. *auxenophila*, 33, 48,
58, 80, 83, 87

infusionum var. *infusionum*, 58

Koettlitzii, 55

lacustris, 54

lichina, 54

[*luteoviridis*], 23, 24

marina, 55

miniata, 19, 20, 24, 45, 52, 54, 57, 60,

61, 62, 64, 81, 84, 88

mutabilis, 18, 19, 20, 43, 56, 57, 63,

64, 80, 83, 88

nocturna, 19, 20, 44, 56, 61, 62, 63, 64,

66, 73, 80, 83, 85, 88

ovalis, 54

paramecii, 16, 55

parasitica, 42

photophila, 20, 21, 44, 56, 66, 81, 83,
85, 88

pringsheimii, 37, 38, 50, 59, 81

protothecoides, 14, 39, 40, 51, 52, 61,

62, 65, 70, 72, 82, 84, 86, 89

protothecoides var. *communis*, 40, 41,

51, 59, 82, 84, 86, 89

protothecoides var. *galactophila*, 40,

51, 59, 62, 82, 84, 86, 89

protothecoides var. *mannophila*, 41, 42,

52, 59, 82, 84, 86, 89

protothecoides var. *protothecoides*, 59

pyrenoidosa, iv, 4, 21, 26, 32, 53

pyrenoidosa (strain 7-11-05), 5, 31

pyrenoidosa (van Niel's strain), 32

regularis, 27, 28, 30, 31, 32, 46, 60, 62,

66, 80, 83, 87

regularis var. *aprica*, 29, 30, 47, 58, 83,
87

regularis var. *regularis*, 58

regularis var. *umbricata*, 28, 29, 30, 47,
58, 74, 80, 83, 85, 87

reticulata, 18

rubescens, 54

saccharophila, 27, 46, 57, 61, 62, 63,
80, 83, 88

Chlorella—continued

salina, 55

simplex, 34, 49, 58, 60, 64, 80, 83, 87

sorokiniana, 30, 31, 47, 58, 80, 83, 87

sparckii, 54

stigmatophora, 54

vanniellii, 31, 32, 48, 58, 64, 81, 84, 88

variabilis, 15, 16, 17, 19, 43, 53, 56, 61,
63, 64, 81, 84, 88[variegata], 22, 41, **90**

viscosa, 54

vulgaris, 2, 13, 21, 22, 23, 25, 28, 44,
60, 62, 64, 66, 81, 84, 85, 88, **92**

vulgaris var. aprica, 80

vulgaris var. luteoviridis, 22, 23, 24,
45, 57, 76, 81, 83, 84, 88

[vulgaris var. viridis], 32, 33

vulgaris var. vulgaris, 57

xanthella, 40

[zopfingiensis], 24, **90**

[Chlorodeum], 3, 13

Chlorosphaera

antarcticus, 55

Cyanidium

caldarium, 55, **90**

[Euchlorella], 3, 13, 14

[Palmellococcus], 3, 13

Placosphaera, 3

Pleurococcus

[Beyerinckii], 22

conglomeratus, 42

Koettlitzii, 55

Prototheca, 3, 4

Radiococcus, 3

Tetracoccus, 3

Zoochlorella, 2, **90, 91**

conductrix, 2, 42

parasitica, 2, 42

INDEX TO AUTHORS

- Allen, M. B., 55, 90
Alvik, G., 54, 90
Artari, A., 3, 22, 28, 34, 42, 90
Belcher, J. H., 90
Beyerinck, M. W., 1, 2, 3, 4, 13, 21, 22,
25, 28, 32, 33, 40, 41, 42, 44, 45,
48, 90
Bold, H. C., 61, 92
Brandt, K., 2, 42, 90
Bristol-Roach, B. M., 4, 90
Brunthaler, J., 2, 34, 90
Butcher, R. W., 54, 55, 90
Chick, H., 1, 4, 21, 26, 31, 32, 53, 90
Chodat, R., 1, 3, 4, 13, 22, 23, 24, 32,
33, 54, 90
Craig, F. N., 28, 90
Deason, T. R., 61, 92
Dönz, O. C., 24, 90
Emerson, R., 25, 26, 37
Fogg, G. E., 90, 91
Fritsch, F. E., 55, 91
Galloway, R. A., 40, 91
Gerneck, R., 3, 13, 34, 35, 38, 49, 54,
55, 91
Granick, S., 28, 91
Krauss, R. W., 1, 6, 9, 40, 91, 92
Krüger, W., 1, 4, 14, 39, 40, 41, 46, 51,
52, 53, 91
Lanjouw, J., 91
Lewin, J. C., 91
Lewin, R. W., 91
Loefer, J. B., 16, 55, 91
Mainx, F., 91
Meyer, H., 23, 24, 41, 91
Migula, W., 27, 34, 49, 91
Miller, J. D. A., 90, 91
Myers, J., 1, 4, 91
Nadson, G., 3, 13, 91
Näegeli, C., 91
Nevyas, Joann, 92
Oltmanns, F., 3, 19, 20, 24, 27, 28, 29,
42, 45, 46, 52, 53, 91, 92
Oneto, J. F., 30, 92
Parker, B. C., 61, 92
Pascher, A., 2, 92
Patterson, G. W., 26, 32, 92
Pratt, J., 30, 92
Pratt, R., 29, 30, 92
Pringsheim, E. G., 6, 38, 55, 92
Pringsheim, O., 92
Provasoli, L., 92
Rabenhorst, L., 92
Shrift, A., 92
Skuja, H., 55, 92
Sorokin, C., 4, 30, 31, 92
Stanier, R. Y., 92
Starr, R. C., 6, 7, 78, 92
Thomas, W. H., 6, 92
Trelease, S. F., 28, 30, 90
Turndorf, Sietske, 92
van Niel, C. B., 25, 32
Wetherell, D. F., 9, 92
Wille, N., 3, 13, 14, 54, 55, 92
Winokur, M., 33, 92